



# DRY CARGO

*handling directory*



2 0 1 8

*The industry's only complete fully comprehensive listing for:*

■ Bulk Ports, Terminals

■ Equipment Manufacturers

■ Engineering Consultants

■ Inspection Companies

■ FIBC & Big Bag Manufacturers

■ Inland Transportation Operators



# DESIGNED, ENGINEERED AND BUILT WITH 90 YEARS OF EXPERIENCE AND EVOLUTION

Golfetto Sangati is an Italian company designing, building and installing turnkey equipment for grain handling and milling. This strong industrial reality is born from the merger of three historic Italian brands: Golfetto, Sangati and Berga. The company fulfills the market demand in a competitive way and with state-of-the-art technologies based on research, experience and in-depth technical knowledge.

Golfetto Sangati is a reference point for the design and construction of complete port systems for loading and unloading ships. The company designed and built more than 50 port systems all over the world and plays a primary role in technological advancement from the first pneumatic ship unloader to the more advanced mechanical loaders and unloaders.

The company supplies a large range of handling, processing and storage, loading and unloading systems on tires or rail with a capacity of 50 to 2,000 tons per hour implementing the best technical principles.

**GOLFETTO SANGATI**  
A COMPANY OF PAVAN GROUP

[www.golfettosangati.com](http://www.golfettosangati.com) - [info@golfettosangati.com](mailto:info@golfettosangati.com)



Two new SENNEBOGEN 870 material handlers working in scrap handling at S Norton's Barking Site. The handlers are fitted with 24m reach, mobile undercarriage, larger outrigger pads, 2-metre pylon, energy recovery system, 3m<sup>3</sup> five-tine grab, full Prolec system and hook.

SENNEBOGEN Maschinenfabrik GmbH  
Sennebogenstraße 10  
D-94315 Straubing, Germany  
T.: +49 9421 540-0  
M: info@sennebogen.de  
W: www.sennebogen.com

#### PUBLISHERS

**Jason Chinnock**  
jason@dc-int.com  
**Andrew Hucker-Brown**  
andrew@dc-int.com

#### EDITORIAL

**Louise Dodds-Ely** Editor  
louise@dc-int.com  
**Jay Venter** Deputy Editor  
editorial@dc-int.com  
**Samantha Smith** Directories  
directories@dc-int.com  
**Stephanie Hodgkins** Office Manager  
accounts@dc-int.com

#### SALES

**Matthew Currin** Senior Sales Executive  
sales2@dc-int.com  
**Gregg Franz** Advertisement Sales Executive  
sales@dc-int.com  
**Zack Venter** Advertisement Sales Executive  
sales@dc-int.com

#### CORRESPONDENTS

Brazil **Patrick Knight**  
India **Kunal Bose**  
Asia **David Hayes**  
Europe **Barry Cross**  
Malaysia **Wira Sulaiman**  
Philippines **Fred Pundol**  
South Africa **Iain McIntosh**  
UK **Maria Cappuccio**  
UK **Michael King**  
UK **Richard Scott**  
USA **Colby Haines**  
USA **Walter Mitchell**

#### ADMINISTRATIVE OFFICE

Business Publishing International  
Corporate Park, 11 Sinembe Crescent  
La Lucia Ridge, South Africa, 4051  
Tel: +27 31 583 4360  
Fax: +27 31 566 4502  
Email: info@dc-int.com  
Twitter: twitter.com/drycargomag

#### HEAD OFFICE

Trade Publishing International Limited  
Clover House, 24 Drury Road,  
Colchester, Essex CO2 7UX, UK  
Tel: +44 (0)1206 562552  
Email: info@dc-int.com  
Website: www.dc-int.com  
Twitter: twitter.com/drycargomag  
Insta: www.instagram.com/drycargointernational  
ISSN 1466-3643

Trade Publishing International Ltd does not guarantee the information contained in Dry Cargo International, nor does it accept responsibility for errors or omissions or their consequences. Opinions expressed herein are not necessarily those of Trade Publishing International Ltd  
© Trade Publishing Int'l Ltd 2018

# DCi DRY CARGO

## handling directory

# 2018



## Contents

### BULK HANDLING EQUIPMENT

COMPANY PROFILES	2
TABLE — COMMODITIES HANDLED	99

### BAGGING

FIBC AND BAG MANUFACTURING COMPANIES	115
--------------------------------------	-----

### INLAND TRANSPORT

BARGE HANDLING COMPANIES	118
RAIL HANDLING COMPANIES	120

### PORTS & TERMINALS

PORTS AND TERMINALS WORLDWIDE — BY COUNTRY	123
TABLE — COMMODITIES HANDLED	183

## BULK HANDLING EQUIPMENT COMPANY PROFILES

### 2000 Engineering

Heiligenbloem 8  
Nootdorp  
Zuid-Holland  
The Netherlands  
**Contact:** Mr Edwin Alewijnse  
**Job Title:** President  
**T:** + 31 153 101 144  
**F:** + 31 153 101 145  
**E:** info@2000engineering.com  
**W:** http://www.2000engineering.nl

### 4B BRAIME Components

Hunslet Road  
Leeds  
West Yorkshire  
LS10 1JZ  
UK  
**Contact:** Mrs Simone Block  
**Job Title:** Marketing Manager  
**T:** + 44 113 246 1800  
**F:** + 44 113 243 5021  
**E:** 4b-uk@go4b.com  
**W:** www.go4b.com  
With over 125 years experience, 4B is the world's leading supplier of high quality Components for Bucket Elevators & Conveyors. 4B offers Mechanical Components (Elevator Buckets & Bolts, Belting & Fasteners, Forged Conveyor Chains..) as well as Electronic

Components (Level Sensors, Belt Alignment Sensors, Bearing Temperature Sensors, Speed Sensors..).

### A. Friedl Flender AG

Alfred Flender Strasse 77  
Bocholt  
D- 46395  
Germany  
**Contact:** Mr Matthias Wenning  
**Job Title:** Marketing  
**T:** + 49 2871 922 780 / + 49 2871 920  
**F:** + 49 2871 921 602  
**E:** matthias.wenning@flender.com  
**W:** www.flender.com  
Flender is a leading international manufacturer of mechanical and electrical components for power transmission equipment. Its diversified product range covers individual components and also complete drive systems for nearly all industrial applications. The company's history dates back over 100 years and it is continuously striving to achieve the best solutions for the future.



### A/S Cimbria

Faartofvej 22  
Thisted  
7700  
Denmark  
**Contact:** Mr Lars Norgaard  
**Job Title:** Sales Director  
**T:** + 45 9617 9000  
**F:** + 45 9617 9299  
**E:** holding@cimbria.com  
**W:** www.cimbria.com  
Cimbria is one of the world's leading producers within processing, handling and storage of grain and seed and other bulk products. We offer projecting and process control - as well as the development, manufacture and installation of individual machines.

### AAF Ltd

Bassington Lane  
Cramington  
Northumberland  
NE23 8AF  
UK  
**Contact:** Mr Jeremy Thompson  
**Job Title:** Environmental Products Business Manager  
**T:** + 44 1670 713477  
**F:** + 44 1670 566312  
**E:** apc@aafgb.com  
**W:** www.aafintl.com  
Designs and manufactures dust extraction systems - plus aftermarket sales and service for all makes of dust collectors.

### AAL

9 Temasek Boulevard  
#20-01 Suntec Tower 2  
Singapore  
038989  
Singapore  
**Contact:** Mr Yiannis Pittalis  
**Job Title:** Marketing Manager  
**T:** +65 6248 3600  
**E:** Y.Pittalis@aalshipping.com  
**W:** www.aalshipping.com

### ABB AB

Crane Systems  
Tvarleden 2  
Västerås  
72159  
Sweden  
**Contact:** Ms Maarit Nystrom  
**Job Title:** Marketing and Sales  
**T:** + 46 21 32 14 11  
**F:** + 46 21 34 02 90  
**E:** cranes.sales@se.abb.com  
**W:** www.abb.com/cranes  
ABB Crane Systems helps harbors, shipping lines, power plants and the steel industry to move containers, bulk material and steel products in a reliable, fast and cost effective way. We will do this by delivering electrical equipment, automation and information management systems for cranes and terminals, via crane builders or direct.

### ABB Engineering (Shanghai) Ltd.

6th Floor No.5 Lane 369  
Chuangye Road  
Pudong  
Shanghai  
201319  
China  
**Contact:** Ms Karen-Jinping Zhu  
**Job Title:** Marketing and Communication  
**T:** + 86 21 2328 8786

**F:** + 86 21 2328 8290  
**E:** karen-jinping.zhu@cn.abb.com  
**W:** www.abb.com/cranes  
ABB offers reliable automation solutions and electrical equipment that enable terminals to move, e.g. bulk material fast and cost efficiently. Already hundreds of various types of cranes in bulk and container terminals as well as industrial plants are equipped with our solutions and deliver to the highest productivity requirements every day.

### ABB Switzerland Ltd

Local Business Unit Minerals  
Segelhofstrasse 9P  
Baden - Daettwil  
CH - 5405  
Switzerland  
**Contact:** Mr Micheal Colbert  
**Job Title:** Marketing Communications  
**T:** + 41 58 586 7508  
**F:** + 41 58 586 7333  
**E:** michael.colbert@ch.abb.com  
**W:** www.abb.com/minerals  
ABB delivers integrated process control, optimization and information systems, drives and power distribution equipment as well as service and support for the complete primary production chain in the mining, mineral processing and cement industry. With its global network, ABB provides local support and engineering facilities that are never far from you.

### Abbey Rollers Limited

Togher Industrial Estate No. 2  
Pouladuff Road  
Cork  
Ireland  
**Contact:** Mrs Martha Murphy  
**Job Title:** Sales and Marketing  
**T:** + 353 21 496 2745  
**F:** + 353 21 431 4898  
**E:** sales@abbeyrollers.ie  
**W:** www.abbeyrollers.ie  
We are a leading manufacturer specialising in patented superior quality, precision engineered, heavy duty, steel conveyor rollers and troughing sets giving long life, performance and reliability. Suitable for Port Facilities, Coal Terminals, Jetty's, etc. Fitting Abbey Rollers on conveyors reduces roller replacement requirements, stock inventory and maintenance downtime. Worldwide Sales.

Perfectly covered  
- with our hoods.

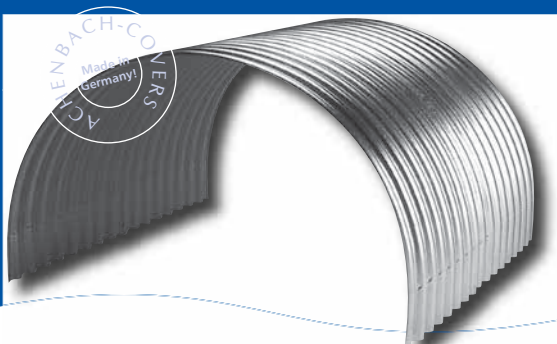

Achenbach metal hoods for conveyor belts

- The modern classic – in worldwide use
- Steel, aluminium, stainless – the appropriate material at any time
- Four corrugation profiles – suitable and cost-effective

Sale of organit-hard-PVC covers made in EU

**ACHENBACH**

Achenbach GmbH Metalltechnik  
Lindstraße 10 · D-57234 Wilnsdorf · Phone +49 (0) 2737/9863-0  
Fax: +49 (0) 2737/9863-10 · www.achenbach-siegen.de



## Abraaj

Gate Village 8  
3rd Floor  
Dubai International Financial Centre  
Dubai  
504905  
UAE

**Contact:** Mr Ajay Malhotra  
**Job Title:** AVP  
T: + 971 5055 7 6388  
F: + 971 4506 4600  
E: [ajay.malhorta@abraaj.com](mailto:ajay.malhorta@abraaj.com)

## AC Robinson & Associates

3rd Floor  
Lakeside Building  
Alexandra Park  
Prescot Road  
St Helens  
WA10 3TT  
UK

**Contact:** Mr Simon Robinson  
**Job Title:** Manager  
T: + 44 1744 621 669  
F: + 44 1744 454 040  
E: [info@acr.org.uk](mailto:info@acr.org.uk)  
W: [www.acr.org.uk/](http://www.acr.org.uk/)

## Achenbach GmbH Metalltechnik



Lindstrasse 10  
Wilnsdorf  
D-57234  
Germany

**Contact:** Mr Uwe Achenbach  
T: + 49 2737 98 63 0  
F: + 49 2737 98 63 10  
E: [u.achenbach@achenbach-siegen.de](mailto:u.achenbach@achenbach-siegen.de)  
W: [www.achenbach-siegen.de](http://www.achenbach-siegen.de)  
Conveyor covers - Achenbach manufactures hoods made of metal (steel, aluminium, stainless) for covering standard or special belts. Hoods made of hard-PVC and fixings round up the Achenbach range.

## Advance Automated Systems Ltd

12 Enterprise City  
Spennymoor  
Durham  
DL16 6JF  
UK

**Contact:** Ms Amy Redhead  
**Job Title:** Sales Admin.  
T: + 44 1388 811 122  
F: + 44 1388 811 133  
E: [AmyRedhead@advanceautomation.co.uk](mailto:AmyRedhead@advanceautomation.co.uk)  
W: [www.advanceautomation.co.uk](http://www.advanceautomation.co.uk)

## AE AntiEmission GmbH

Nordhang 74  
Gevelsberg  
58285  
Germany

**Contact:** Dipl.-Ing. A Eskandani  
**Job Title:** President  
T: + 49 2332 66 49 92 0  
F: + 49 2332 66 49 92 5  
E: [Info@AntiEmission.de](mailto:Info@AntiEmission.de)  
W: [www.AntiEmission.de](http://www.AntiEmission.de)  
Serving coal and biomass power plants, the construction, demolition



and recycling, raw & bulk material and mining industry.  
Our products and services:  
Spraying systems, fog cannons, fog cannon pole systems, dust binders, pile/slope/haul road stabilizers, ash treatment products, dust & ash mixers, air cannons, dust management & consultancy.

## AE Automation (M) Sdn bhd

10-12, Jalan Mas 6  
Taman Cheras Mas  
Cheras  
Selangor D.E.

43200  
Malaysia  
**Contact:** Mr Ken Lim  
**Job Title:** Managing Director  
T: + 60 7 455 6333  
F: + 60 7 455 6666  
E: [ken@aeauto.com.my](mailto:ken@aeauto.com.my)  
W: [www.ae.com.my](http://www.ae.com.my)  
Specialized in Bulk material handling system, turnkey solutions in coal mining, power plants, cement plants, fertilizer plants, port projects.

## Aeromaster International Ltd

Fairport House  
Market Place  
Adlington  
PR7 4EZ  
UK

**Contact:** Mr Ian Tallents  
**Job Title:** Project Manager  
T: + 44 1257 484000  
F: + 44 1257 483312  
E: [info@aeromaster-int.com](mailto:info@aeromaster-int.com)  
W: [www.fairport.co.uk/](http://www.fairport.co.uk/)  
As part of the Fairport Group of Companies including Flomat Bagfilla (FIBC big bag discharging



# AGRICO FIXED TOWER SHIPLOADERS LOAD SHIPS FASTER AND SAVE 50% OR MORE ON FOUNDATIONS

## WHY BUY AN AGRICO SHIPLOADER?

- ◆ PROVEN DESIGN
  - ◆ SAFETY
- ◆ HIGH CAPACITY
- ◆ REDUNDANCY
- ◆ RADIO REMOTE
- ◆ LOW LABOR
- ◆ DUST FREE



## AGRICO SALES

Agrico Sales, Inc.  
14900 Intracoastal Dr.,  
New Orleans,  
Louisiana,  
USA 70129  
+1 504-436-9400  
brieck@agricosales.com  
www.agricosales.com



& filling specialists), Fairport NEU Solutions (pneumatic conveying experts) and Fairport Process Equipment, we can offer a variety of materials handling solutions.

## AFM Industries

828 Ritson Road  
Oshawa  
Ontario  
L1H 5L4  
Canada  
**Contact:** Mr Rob Butterworth  
**Job Title:** President  
**T:** + 1 905 443 0150  
**F:** + 1 905 443 0155  
**E:** rbutterworth@afmindustries.com  
**W:** www.afmindustries.com  
Supplier-fabricator of conveyor belting.  
Textile belting (polyester-nylon-aramid) - Enduraply  
Textile belting with steelcord breakers - Enduraply-Plus  
Steelcord belting - Endurasteel  
Steelcord belting with steelcord breakers - Endurasteel-Plus  
Corrugated sidewall belting (1.5-16 inches) - Endurawall  
Extreme high heat belting — Endurathern  
Complete installation-field splicing-jointing services.

## Ag Growth International (AGI)

198 Commerce Drive  
Winnipeg  
MB  
R3P 0Z6  
Canada  
**Contact:** Ms Melanie Davidson  
**Job Title:** Marketing Manager, Commercial Brands  
**T:** + 1 204 594 2420  
**E:** Melanie.davidson@aggrowth.com  
**W:** www.aggrowth.com  
A leading manufacturer of seed, fertilizer, grain, feed and food handling, blending, storage and conditioning equipment.  
Manufacturing facilities in Canada, the United States, Brazil, South Africa and Italy, with global distribution. Products include: augers; belt conveyors; grain storage bins; grain handling accessories; aeration equipment; drying systems, as well as feed, food and fertilizer handling and storage systems.

## Agora Services

Telford Way  
Kettering  
Northants  
NN16 8YZ  
UK  
**Contact:** Mr Shaun Haycock  
**T:** + 44 1536 481629  
**F:** + 44 1536 410193

**E:** sales@agoraservices.co.uk  
**W:** www.agoraservices.co.uk  
Engineers for powders and granules bulk material handling. Product range - hoppers, feeders, exciters and pneumatic, mechanical and screw conveying systems.

## Agrico Sales, Inc.



14900 Intracoastal Drive  
New Orleans  
Louisiana  
70129  
USA  
**Contact:** Mr Bob Rieck  
**Job Title:** Vice President - Sales  
**T:** + 1 504 436 9400  
**E:** brieck@agricosales.com  
**W:** www.agricosales.com  
Agrico Sales is an equipment manufacturer and construction company specializing in turnkey design/build projects for dry bulk commodities. Agrico builds: ship and barge loaders, conveyor systems, covered and open storage, rail and truck loading and unloading as well as jobs that include several of these components. Agrico is price competitive on a worldwide basis.

## Agromatic AG

Goldingenstrasse 30  
Laupen  
CH-8637  
Switzerland  
**Contact:** Ms Anita Speier  
**T:** + 41 55 256 21 00  
**E:** anita.speier@agromatic.com  
**W:** www.agromatic.com  
Specialises in bulk handling systems components, safety devices for mills, silos and storages and feed mill industries especially silo temperature monitoring equipment, level control, speed & alignment monitoring, automatic sampling, flow control, dampening systems and laboratory devices, metal detectors and separators, magnets.

## AJ Edmond Company

1530 W 16th Street  
Long Beach  
CA 90813  
USA  
**Contact:** Mr Jignesh Panchal  
**Job Title:** Technical Director  
**T:** + 1 562 437 1802  
**F:** +1 562 590 0482  
**E:** JPanchal@ajedmondco.com  
**W:** www.ajedmondco.com

## AJ Sackett & Sons Company

1701 South Highland Ave

Baltimore  
Maryland  
21224  
USA  
**Contact:** Mr Larry Taylor  
**T:** + 1 410 276 4466  
**F:** + 1 410 276 0241  
**E:** larryt@ajsackett.com  
**W:** www.ajsackett.com  
Designers and manufacturers of dry bulk material handling systems, including conveying systems, blending, granulation, bagging and compaction systems.

## AKJ Industries

PO Box 588  
Pewee Valley  
Kentucky  
40056  
USA  
**Contact:** Mr Jack Cranfill  
**Job Title:** Vice President  
**T:** + 1 502 241 6932  
**F:** + 1 502 241 6766  
**E:** jackcranfill@yahoo.com  
**W:** www.akjindustries.com  
Provides dust control, belt de-icing and freeze conditioning chemicals equipment and service to the material handling industries.





# Alex Stewart Agriculture

## Experienced Agri Inspections



### **Alex Stewart Agriculture Ltd**

21 Sefton Business Park, Aintree,  
Liverpool L30 1RD United Kingdom

Call Glenn Forbes

**T:** +44 151 525 1488

**E:** [glenn.forbes@alexstewartagriculture.com](mailto:glenn.forbes@alexstewartagriculture.com)

**www.alexstewartagriculture.com**



## Alex Stewart Agriculture Ltd



21 Sefton Business Park  
Netherton  
Liverpool  
Merseyside  
L30 1RD  
UK

**Contact:** Mr Glenn Forbes  
**Job Title:** Agriculture Manager  
**T:** + 44 151 525 1488  
**F:** + 44 151 530 1563

**E:** Glenn.forbes@alexstewartagriculture.com  
**W:** www.alexstewartagriculture.com  
Offers a complete range of agricultural analytical, inspection and certification services for the facilitation of the international trading of soft commodities including raw & refined sugar, oils & fats, bio diesel, cereals, fertilisers and other food products.

## Alex Stewart International Corporation Ltd



2b Sefton Business Park  
Netherton  
Liverpool  
Merseyside  
L30 1RD  
UK

**Contact:** Mr Graham Stewart  
**Job Title:** Managing Director  
**T:** + 44 151 525 2132  
**E:** graham.stewart@alexstewartinternational.com  
**W:** www.alexstewartinternational.com  
Alex Stewart International provides global inspection, sampling and laboratory analysis for all bulk commodities including metals, minerals and soft/agri commodities.

## Algoma Central Corporation

63 Church Street  
Suite 600  
St Catharines  
ON  
L2R 3C4  
Canada

**Contact:** Mr Gregg Ruhl  
**Job Title:** COO  
**T:** + 1 905 687 7890  
**E:** gregg.ruhl@algonet.com  
**W:** http://www.algonet.com/

## All-Fill International Ltd

5 Gateshead Close  
Sunderland Road  
Sandy  
Beds  
SG19 1RS  
UK

**Contact:** Mr Stewart Todd  
**Job Title:** Export Sales Manager  
**T:** + 44 1767 691100

**F:** + 44 1767 681406  
**E:** info@allfill.co.uk  
**W:** www.allfill.co.uk  
Manufacturer of vertical auger powder filling systems and ancillary equipment.

## Allison Engineering Ltd

Capricorn Centre  
Cranes Farm Road  
Basildon  
Essex  
SS14 3JA  
UK

**Contact:** Mr Jeff Harwood  
**T:** + 44 1268 526161  
**F:** + 44 1268 533144  
**E:** jharwood@allison.co.uk  
**W:** www.allison.co.uk/

## ALS Inspection

Caddick Road  
Knowsley Business Park  
Prescott  
Merseyside  
L34 9HP  
UK

**Contact:** Mr Christopher Walker  
**Job Title:** Commercial Manager  
**T:** + 44 151 548 7777  
**F:** + 44 151 548 0714  
**E:** info@alexstewart.com  
**W:** www.alexstewart.com  
Alex Stewart are suppliers of quality commodity inspection and laboratory analysis offering cargo supervision, quality and quantity inspection, weighing, sampling, assaying, testing, verification and certification services for the facilitation of international trade.

## ALTA, Co

Štefánikova 41  
Brno  
602 00  
Czech Republic  
**Contact:** Mr Jiří Bartuňek  
**Job Title:** Sales Director  
**T:** + 420 541 550 111  
**F:** + 420 541 550 555  
**E:** office@alta.cz  
**W:** www.alta.cz

## Amec Foster Wheeler

111 Dunsuir St, Suite 400  
Vancouver  
British Columbia  
V6B 5W3  
Canada  
**Contact:** Mrs Anna Klimek  
**Job Title:** Manager  
**T:** + 1 604 664 4315  
**E:** anna.klimek@amec.com  
**W:** www.amecfw.com

Amec Foster Wheeler is an industry leader in global mining solutions. For more than 60 years, we have been trusted to deliver some of the most logistically and technically challenging mining projects in the world. We are focused on delivering value to customers with safety and integrity in all we do.

## AMECO SA

43, Rue du 21 Novembre  
Illfurth  
F-68720  
France

**Contact:** Mr Stéphane Killian  
**Job Title:** CEO  
**T:** + 33 389 255963  
**F:** + 33 389 255968  
**E:** info@ameco.eu.com  
**W:** http://www.ameco.eu.com

Manufactures mechanical loaders/unloaders complete with belt stackers, scraper reclaimers, bucket wheel reclaimers, enclosed storage systems and other storage

systems, automation/computer/electrical and conveyors/components.

## Anindya

Apartemen Mediterania Palace  
Residence  
Ruko B/OR/C  
Jalan Landasan Pacu Utara-Selatan  
Kemayoran  
Jakarta  
Special Region Jakarta  
10630  
Indonesia  
**Contact:** Mr Irvan Rahman  
**Job Title:** Coal & Mineral Operation Head  
**T:** + 62 21 300 43757  
**E:** irvan.rahman@anindya.biz  
**W:** www.anindya.biz

## Antar@Pressvess

Stallings House  
Stallings Lane  
Kingswinford  
West Midlands  
DY6 7LG  
UK

**Contact:** Mr Roger Bannister  
**Job Title:** CEO  
**T:** + 44 1384 400 088  
**F:** + 44 1384 296 268  
**E:** roger.bannister@antar-equipment.com  
**W:** www.pressvess.co.uk

## ANUPAM INDUSTRIES LIMITED

138, G.I.D.C. Vitthal Udyognagar  
Via. Anand  
Gujarat  
388121  
India  
**Contact:** Mr Mehul Patel  
**Job Title:** Managing Director  
**T:** + 91 2692 235210  
**F:** + 91 2692 236324  
**E:** sales@anupamgroup.com  
**W:** http://www.anupamgroup.com/

## Anvil Attachments

PO Box 216  
261 Highway 19  
Slaughter  
Louisiana  
70777  
USA

**Contact:** Mr Shane Toncrey  
**Job Title:** Marketing Director  
**T:** + 1 225 654 8223 ext 208  
**F:** + 1 225 654 3125  
**E:** Sales@AnvilAttachments.com  
**W:** www.AnvilAttachments.com  
Manufacturer of grabs, grapples and clamshell buckets for cable, hydraulic and electro-hydraulic operation. Models for ships-gear, gantry, excavators, crawler cranes and hydraulic equilibrium cranes. Brands include Anvil, Hawco, Pro-line, Owen, Yaun, Williams & Drott. New, used, rentals, rebuilds, repairs, parts and service, since 1969.

## Applied Conveyor Technology, Inc. DBA The ACT Group

14644 El Molino Street  
Fontana  
CA  
92335-6205  
USA

**Contact:** Mr Edward Sunseri  
**T:** + 1 909 350 4703  
**F:** + 1 909 350 4982  
**E:** esunseri@groupactinc.com  
**W:** www.groupact.com  
Specialists in the process,

containment and control of dust for all bulk materials. The Group offers full design and engineering, procurement, installation and fabrication and after market service and repair for conveyors, crushers, screens, dust collectors and dust suppression systems.

## Aristoncavi

Via Einaudi 8  
Brendola  
Vincenza  
36040  
Italy

**Contact:** Mr Alessandro Tessier  
**Job Title:** Marketing Manager  
**T:** + 39 0444 749900  
**F:** + 39 0444 749800  
**E:** info@aristoncavi.com  
**W:** www.aristoncavi.com/

## Arlona Engineering

PO Box 41125  
Rossburgh  
Durban  
KZN  
4072  
South Africa

**Contact:** Mr Steve Christy  
**Job Title:** Managing Director  
**T:** + 27 31 205 95 90  
**F:** + 27 31 205 98 35  
**E:** steve@arlonaco.za  
**W:** www.arlonaco.za  
Manufactures a range of bulk handling equipment, including radio remote control grabs and mobile bulk hopper / conveyor systems for bulk carrier unloading.

## Arodo BVBA

Hoge Mauw 740  
Arendonk  
B-2370  
Belgium

**Contact:** Mr Jan-Mathijs van Noort  
**T:** + 32 14 672 332  
**F:** + 32 14 671 760  
**E:** sales@arodo.be  
**W:** http://www.arodo.com

## Artelia

Bureau de Gerland  
38 Place des Pavillons  
Lyon  
69007  
France

**Contact:** Mr Jean-Luc Attia  
**Job Title:** Regional Director  
**T:** + 33 4 37 65 36 20  
**F:** + 33 4 37 65 39 70  
**E:** info@artelia.com  
**W:** www.arteliagroup.com

## AS LNK Industries

15 J. Dalina Street  
Riga  
LV-1013  
Latvia

**Contact:** Mr Kristis Leiskalns  
**Job Title:** Marketing & PR Spokesman  
**T:** + 37 167 334 012  
**E:** kristis.leiskalns@lnk.lv  
**W:** www.lnk.lv

## AS Marine

Jl. Cengkeh No 19 F  
Jakarta Barat  
11110  
Indonesia

**Contact:** Mr Eddy Gunawan  
**Job Title:** Purchasing Manager  
**T:** + 62 21 691 9595  
**F:** + 62 21 691 9696  
**E:** eddy@asmarines.com  
**W:** www.asmarines.com/

## ASGCO "Complete Conveyor Solutions"

301 Gordon Street  
Allentown  
PA  
18102  
USA

**Contact:** Mr Aaron Gibbs  
**Job Title:** President  
**T:** + 1 610 821 0216  
**F:** + 1 610 778 8991  
**E:** info@asgco.com  
**W:** http://www.asgco.com/  
At ASGCO "Complete Conveyor Solutions" we use engineered products and services to provide our customers with productive, safe and reliable solutions for bulk conveyor material handling industries.

Combined with our global network of complete turn-key service distributors, we are part of a coordinated team focused on insuring your success. Other equipment includes: Belt Cleaners, Conveyor Components, Conveyor Idlers, Impact Beds.

## ASGCO Manufacturing

Gading Bukit Indah / F16  
Jl. Bukit Gading Raya  
Kelapa Gading  
Jakarta  
14240  
Indonesia

**Contact:** Mr Ray Nainggolan  
**Job Title:** Asia Ind. Representative  
**T:** + 62 819 1675 3573  
**E:** ray@asgco.asia

**W:** www.asgco.asia or www.asgco.com  
ASGCO specialises in bulk conveyor accessories and services. ASGCO manufacture components to belt conveyor that maximises the performances. Among many, Self-Aligning idlers (without 90° belt edge contact) that is the most effective in the market, Primary belt cleaners with superior tensioning and stainless steel frames, and easy to maintain rubber skirting clamps are our specialty products. Free conveyor inspections available as part of our solutions programme.

## Ashton Bulk Ltd

The Old Tannery  
Kelston  
Bath  
BA1 9AN  
UK

**Contact:** Mr Joe Dudman  
**Job Title:** Director  
**T:** + 44 117 329 4841  
**E:** admin@ashtonbulk.com  
**W:** www.ashtonbulk.com

## ATD Stramproy BV

Industrieweg 27  
Stramproy  
AP  
6039

The Netherlands  
**Contact:** Mr Roel Lebens  
**T:** +31 495 56 61 11  
**F:** + 31 495 56 2942  
**E:** r.lebens@stramproy.nl  
**W:** www.atdstramproy.nl  
Suppliers of silos.



# BEDESCHI



**SINCE 1908...  
TAKING THE BEST FROM THE PAST TO BUILD THE FUTURE**

BEDESCHI product range covers a wide variety of equipment for Heavy Clay Industry, Bulk Materials Handling, Marine Logistics and Mining.

BEDESCHI services range from feasibility studies and basic engineering to complete green field, turn key installations. All design activities are performed in house in BEDESCHI technical centers in Italy and United States, while all manufacturing is carried out in the Company state-of-art workshop in Italy.

BEDESCHI has followed this way of operation for more than 100 years, resulting in complete quality control and the highest product reliability.

[www.bedeschi.com](http://www.bedeschi.com)

MEDCEM CEMENT PLANT - TURKEY  
TWO CEMENT AND CLINKER  
EXPORT TERMINALS  
TOTAL DESIGN CAPACITY **2.800 T/H**





## ATIC Services

91bis, rue du Cherche Midi  
Paris  
75006  
France  
**Contact:** Ms Marie-Pierre Lachaud  
T: + 33 1 536 338 63  
F: + 33 1 536 338 58  
E: info@atics.fr  
W: www.atics.fr

## Atlas Manufacturing Co.

**Inc**  
PO Box 1969  
622 East McPherson Drive  
Monticello  
MS 39654  
USA  
**Contact:** Mr Ashley Watson  
**Job Title:** Sales Manager  
T: + 1 601 587 4511  
F: + 1 601 587 5393  
E: ashley@atlasmanufacturing.net  
W: www.atlasmanufacturing.net  
Atlas Manufacturing Company designs and builds high performance industrial clamshell buckets and grapples that meet and exceed strict industry demands. Atlas is comprised of the most experienced staff in the industry, and committed to producing the finest, most reliable products in the business. Call and put Atlas to work for you today.

## August Penkert GmbH

Xantener Str.12  
Mülheim an der Ruhr  
45479  
Germany  
**Contact:** Mr Bodo Altgeld-  
Wichmann  
**Job Title:** Marketing Manager  
T: + 49 2084 1969 10  
F: + 49 2084 1969 22  
E: info@brehme-ubo.com  
W: www.penkert.com  
For more than 50 years Ulrich Brehme GmbH have been manufacturers of bulk materials equipment and components for all industries.

## AUMUND Foerdertechnik (AUMUND Group)



Saalloffer Strasse 17  
Rheinberg, D-47495  
Germany  
**Contact:** Mr Robert Gruss  
**Job Title:** Managing Director  
T: + 49 2843 720  
F: + 49 2843 60270  
E: info@aumund.de  
W: www.aumund.com  
AUMUND Foerdertechnik GmbH specializes in the transportation of hot and abrasive materials and the storage of bulk solids. The product portfolio includes bucket, plate and chain conveyors, silo technology and discharge systems. The products are used particularly in the cement industry, the iron and steel industry, in mining and minerals, in power plants and for alternative fuels handling. Services include assembly, replacement part procurement as well as modernisation and conversion.

## Aurecon

PT Aurecon Indonesia  
Alamanda Towers 24th Floor, Unit C-D

Jl.T.B. Simatupang Kav. 23-24,  
Cilandak Barat  
Jakarta  
12430  
Indonesia  
**Contact:** Mr Jeff Tutticci  
**Job Title:** Business Development  
Manager  
T: + 62 21 2965 4000  
F: + 62 21 2965 4001  
E: Jeff.Tutticci@aurecongroup.com  
W: www.aurecongroup.com  
Multidiscipline Consulting  
Engineers specialising in the design of infrastructure for efficient and innovative pit to port solutions.

## Aurecon

Level 10  
55 Grenfell Street  
Adelaide  
South Australia  
5000  
Australia  
**Contact:** Mr Stephen Symons  
**Job Title:** Development Manager  
T: + 61 8 8237 9905  
F: + 61 8 8237 9778  
E: SymonsS@ap.aurecongroup.com  
W: www.aurecongroup.com

## Ausenco Engineering Canada Inc.

855 Homer Street  
Vancouver  
British Columbia  
V6B 2W2  
Canada  
**Contact:** Mr Joel Shirriff  
**Job Title:** VP Terminals &  
Transportation  
T: + 1 604 684 9311  
F: + 1 604 688 5913  
E: joel.shirriff@ausenco.com  
W: www.ausenco.com  
Leading engineering company operating worldwide in the bulk terminals, mining, and slurry pipeline industries, providing services in mine materials handling, transportation and export/import facilities. Services span all aspects of project development including planning studies, detailed design, EPCM and EPC design/build. Other services: logistics simulation, marine structures, coastal engineering, project and construction management, asset management.

## AusGroup Limited

Head Office  
Level 2, 251 St Georges Terrace  
Perth  
WA  
6000  
Australia  
**Contact:** Laurie Barlow  
**Job Title:** CEO  
T: + 61 8 6210 4500  
F: + 61 8 6210 4501  
E: info@agc-ausgroup.com  
W: www.agc-ausgroup.com

## Australian Superintendence Company

PO Box 7003  
East Brisbane  
Queensland  
4169  
Australia  
**Contact:** Mr Doug Parry  
**Job Title:** Managing Director  
T: + 61 7 3391 8640  
F: + 61 7 3217 3942  
E: dparry@austsupco.com.au



## Avplast Dis Tic. Ve Paz. Ltd. Sti.

Egitim Mah. Kasap Ismail Sok.  
Avrasya Is Merkezi No:14 Kat:1  
D:24-  
34722 Hasanpasa / Kadikoy  
Istanbul  
81080  
Turkey  
**Contact:** Mr Hakan Avci  
T: + 90 216 338 32 31 - 347 38 54  
F: + 90 216 348 88 95  
E: sales@avplast.com.tr  
W: www.avplast.com.tr

## AW Process

2161 E County Rd 540a  
Suite 224  
Lakeland  
Florida  
33813  
USA  
**Contact:** Mr Andy Woodford  
**Job Title:** President  
T: + 1 941 807 1448  
F: + 1 863 583 0472  
E: andy@awprocess.com  
W: www.awprocess.com  
Bulk handling equipment – Storage domes & silos, bulk ship, rail, truck & barge loading and unloading. Mechanical & pneumatic conveying systems.

## B.V. BECO

Industrieterrein "De Biezen"  
De Limiet 18  
Vianen  
Utrecht  
4131 - NR  
The Netherlands  
**Contact:** Mr Henk van Vuren  
**Job Title:** Managing Director  
T: + 31 347 323 100  
F: + 31 347 377 780  
E: h.vanvuren@beco-vianen.nl  
W: www.beco-vianen.com  
Beco Grabs is a specialist for grab-equipment and is certified in accordance with ISO 9001:2015. We are able to fulfil the still growing demand for custom made grabs and/or specials as well as for grabs in the field of bulk material handling and in the field of dredging.

## Babcock & Wilcox Loibl GmbH

Arberstr. 40  
Straubing  
D-94315  
Germany

**Contact:** Mr Jules Fricke  
**Job Title:** Managing Director  
T: + 49 9421 92560  
F: + 49 9421 925625  
E: jules.fricke@loibl.biz  
W: www.babcock.com/loibl  
For more than 42 years the Plant Engineering and Materials Handling Technology Arthur Loibl GmbH has made conveying and recycling plants for bulk material of all types e.g. ship loading plants; troughed belt, sidewall belt, belt and chain, apron, scraper and troughed chain conveyors; wet slag dischargers, screening and crushing plants.

## Bagfilla SA Pty Ltd

PO Box 34251  
Jeppesstown  
Gauteng  
2043  
South Africa  
**Contact:** Mr Alan Mason  
T: + 27 11 613 8024  
F: + 27 11 613 1080  
E: info@bucklepack.co.za  
W: www.bucklepack.co.za  
Suppliers of Bag Sewing and Heat sealing machines to close open mouth bags.

## Bauer Gear Motor

Eberhard Bauer Straße 36-60  
Esslingen  
73734  
Germany  
**Contact:** Mr Philip Crowe  
T: + 49 711 3518456  
F: + 49 711 3518276  
E: info@bauergears.com  
W: www.bauergears.com/

## Bayards Aluminium Constructions

PO Box 9  
Nieuw-Lekkerland  
ZH  
2957 ZG  
The Netherlands  
**Contact:** Mr Dick de Kluijver  
**Job Title:** Commercial Director  
T: + 31 184 683000  
F: + 31 184 684345  
E: dick.dekluijver@bayards.nl  
W: www.bayards.nl  
Bulk containers.

## Bedeschi Mid-West Conveyor

8245 Nieman Road  
Lenexa  
Kansas  
66214  
USA  
**Contact:** Mr Sudy L Vohra  
**Job Title:** Executive Vice President  
T: + 1 913 261 2406  
F: + 1 913 261 2472  
E: sudyv@mwconveyor.com  
W: www.mwconveyor.com  
Manufacturer of turnkey Bulk Materials Handling Systems for Terminals, Power Plants, Mines, Cement Plants, Iron Oxide and DRI handling. Latest products include Pipe Conveyors, Curved Conveyors Stackers And Reclaimers including Travelling Rotary Plow Feeders under piles and for Silo Reclaim Systems. Other Equipment includes Trippers, Belt Feeders and Telescopic Chutes. Complete materials handling for Gassification projects.

## Bedeschi SpA



Via Praimbole  
38 Limena  
Padova  
35010  
Italy  
**Contact:** Ms Elena Marcato  
**Job Title:** Marketing &  
Communication Manager  
T: + 39 049 884 8088  
F: + 39 049 884 8006  
E: sales@bedeschi.com  
W: www.bedeschi.com  
Material handling solutions such as stackers, reclaimers, ship loaders and ship unloaders plus crushing equipment. Bedeschi also operates in the container logistics sector, producing Ship to Shore Cranes, RMG and RTG.

## BEHN + BATES Maschinenfabrik GmbH & Co. KG

Robert-Bosch-Strasse 6  
Munster  
D-48153  
Germany  
**Contact:** Ms Gabriele Buss  
T: + 49 251 9796 0

F: + 49 251 9796 260

E: sales@behnates.com

W: www.behnates.com

For more than 80 years we have specialized in the manufacture of packing machines for filling all kind of food and animal feed products, into valve bags, open-mouth bags and FFS bags. Part of our activities are also overall concepts incorporating prior and subsequent plant components.

## Beijing HaoSheng Transmission Technology Co., Ltd.

Room 511, No.3 Building  
Unit 2, Xingmao Center, Greenland  
Central Plaza  
Xinghua Street  
Daxing District  
Beijing  
Beijing City  
102627  
China

**Contact:** Ms Selena Bai  
**Job Title:** International Sales  
T: +86 010 6342 3819  
F: +86 010 6349 7906  
E: sales5@hscdtech.com  
W: http://www.hscdtech.com

## Bekaert NV

Product Group Steelcord  
Bekaert Street 2  
Zwevegem  
B-8550  
Belgium

**Contact:** Ms Sara De Craemer  
**Job Title:** Marketing  
Communications  
T: +32 56 23 05 60  
F: + 32 9 3749 292



E: Sara.Decraemer@bekaert.com  
W: www.bekaert.com  
Bekaert is a leader in

manufacturing of wire and wire products for a wide range of industrial and household

applications.

Steel cord is the best way to reinforce a tire, a conveyor belt. Bekaert produces conveyor belt cords and woven steel cord fabrics for conveyor belt reinforcement.

W: www.bendezu.com/

We deal with second hand port equipment such as Mobile Harbour Cranes, shipunloaders, Material Handlers, grabs, etc, and new and fully refurbished Diesel Engines, especially for harbour cranes. We also offer Hoppers (with and without dust suppression) and Conveyor Belts for loading vessels.

## Belt Equipment Supplies Sdn Bhd

11-0-8  
Jalan 3/109F  
Danau Business Centre  
Taman Danau Desa  
Kuala Lumpur  
58100  
Malaysia

**Contact:** Mr K H Low  
**Job Title:** Managing Director  
T: + 60 3 7984 6099  
F: + 60 3 7984 6097  
E: belt@pc.jaring.my  
W: http://beltequipment.com.my  
Solutions for Bulk Handling, vacuum cleaning and logistic transportation.

## Benetech GmbH

Karl Liebkrecht Str 27  
b. Leipzig  
Deuben DE-06682  
Germany

**Contact:** Mr Frank Lippert  
**Job Title:** Managing Director  
T: + 49 34441 445 0  
F: + 49 34441 445 20  
E: benetech@gmx.de

## Benetech USA

2245 Sequoia Drive  
Suite 300  
Aurora  
Illinois  
60506  
USA

**Contact:** Mr Christopher F Blazek  
**Job Title:** Vice President,  
Marketing  
T: + 1 630 844 1300 x214  
F: + 1 630 844 0064  
E: blazekc@benetechusa.com  
W: www.benetechusa.com

Benetech offers a range of engineering, equipment, and field services supporting your bulk-material handling and dust control needs. Benetech's equipment or turnkey solutions are geared to reducing risk and operating costs. Our Plant Professionals division provides operations consulting support.

## Bemo Rail BV

Debbemeerweg 59  
Warmenhuizen  
1749 DK  
The Netherlands  
**Contact:** Mr Theo Druif  
T: + 31 226 425 300  
F: + 31 226 421 916  
E: info@bemorail.nl

## Bendezu Port Equipment GmbH

C/Camino Padre Cura, 15  
Bloq. Oasis II  
City  
Estepona  
Málaga  
29680  
Spain

**Contact:** Mr Andrés Bendezu  
**Job Title:** General Manager  
T: + 34 679 449 189  
E: info@bendezu.com

## Bergu International AB

Nygata 30  
Box 5006

don't play with your cargo

# GRAB IT WITH BLUG

1965 2015

Juan XXIII, 9 Azpeitia (Spain)  
blug@blug.es . www.blug.es

## BLUG®

Credeblug, s.l.  
HANDLING SOLUTIONS





Helsingborg  
S-250 05  
Sweden  
**Contact:** Mr Conny Simonsson  
**T:** + 46 42 12 7970  
**F:** + 46 42 12 8002  
**E:** bergu@telia.com  
**W:** www.bergu.com  
Produces components for pneumatic conveying equipment.

### Best Service Group (B.S.G.) bvba

Bogaardestraat 168M  
Maldegem  
Oost-Vlaanderen  
B-9990  
Belgium  
**Contact:** Mrs Kathleen Breusegem  
**Job Title:** Managing Director  
**T:** + 32 50 711801  
**F:** + 32 50 710402  
**E:** info@sobemai.com  
**W:** www.sobemai.com  
Manufacturer of equilibrated cranes, capable of lifting up to 200 ton. Capacities up to 5000 ton per hour. PLC controlled. For container handling, bulk, scrap and general cargo. Pedestal-, pontoon-, track- or bogie mounted.

### Beumer Group GmbH & Co KG



Oelder Strasse 40  
Beckum  
North-Rhine Westphalia  
D-59269  
Germany  
**Contact:** Dr Andreas Echelmeyer  
**Job Title:** Director Conveying and Loading Systems  
**T:** + 49 2521 24 0  
**F:** + 49 2521 24 280  
**E:** beumer@beumergroup.com  
**W:** www.beumergroup.com  
The BEUMER group is a leading

international manufacturer of intralogistic systems specializing in conveying, loading, palletizing and packaging technology as well as in sortation and distribution systems. Having approx. 4.000 employees and a turnover of around EUR 700 million, BEUMER has, with subsidiaries and representations, a worldwide presence for various industries.

### BGS Holland

Hoogeveeneweg 5  
Nieuwerkerk ad IJssel  
2913 LV  
The Netherlands  
**Contact:** Ms Martina Hermans  
**T:** + 31 180 317838  
**F:** + 31 180 315538  
**E:** info@bgsholland.nl  
**W:** www.bgsholland.nl  
Produces 'Choke Feed Scavenger' fittings for loadspouts to remove dust while loading bulk materials into ships, trucks or rail cars. Capacities range from 50 to 2000m<sup>3</sup> per hour.

### Binder + Co AG

Grazer Strasse 19-25  
Gleisdorf  
A-8200  
Austria  
**Contact:** Ms Almuth Schnehen  
**T:** + 43 31 12 800 0  
**F:** + 43 31 12 800 300  
**E:** office@binder-co.at  
**W:** www.binder-co.com  
Binder+Co is an internationally successful specialist in machinery and complete systems for crushing, screening, drying, sorting, as well as packaging and palletising bulk materials of all kinds. The company, based in Gleisdorf, Styria, is a global market leader in the fields of screening technology and glass recycling.

### Birrus International Pty Ltd

10 Dandenang Street  
Dandenong  
Victoria  
3175  
Australia  
**Contact:** Mr Paul Shultz  
**Job Title:** Managing Director  
**T:** + 613 9769 2646  
**F:** + 613 9769 2535  
**E:** sales@birrus.com.au  
**W:** www.birrus.com.au

### Blue Water Misting

PO Box 7545  
West Lakes  
Adelaide  
South Australia  
5021  
Australia  
**Contact:** Mr James Davenport  
**E:** sales@bluwatermisting.com  
**W:** www.bluwatermisting.com

### BLUG Credeblug S.L.



Juan XXIII - 9  
Azpetitia  
Guipuzcoa  
20730  
Spain  
**Contact:** Mr JR Zubeldia  
**Job Title:** Commercial Manager  
**T:** + 34 943 810 150  
**F:** + 34 943 815 665  
**E:** comercial@blug.es  
**W:** www.blug.es  
BLUG product range fits what the maritime bulk handling sector requires. Our handling solutions can be adapted to any kind of existing harbour crane. BLUG solutions go from automatic grabs,

**SOME THINK  
LONG-DISTANCE  
TRANSPORT IS  
INFRASTRUCTURE-  
INTENSIVE.  
WE THINK  
DIFFERENT.**

Transporting materials from remote locations has traditionally required significant infrastructure investments in road or rail links, vehicles, personnel and fuel. BEUMER offers an economical, efficient and environmental alternative – long-distance overland conveying. This gives you a dedicated, around-the-clock transport link at the fraction of the cost of infrastructure development. The reduced noise and air pollution minimises environmental impact and improves personnel safety. Add to that a high degree of design flexibility and customisation and you can see why overland conveying makes a big difference to operational efficiency and environmental protection.

For more information, visit [www.beumergroup.com](http://www.beumergroup.com)





to 4-rope or electro-hydraulic high volume grabs that fit any crane, material and production requirements.

### **BMT Baxter Eadie Ltd**

Goodrich House  
1 Waldegrave Road  
Teddington  
Surrey TW11 8LZ  
UK

**Contact:** Mr John Hunter  
**Job Title:** Marketing Manager  
**T:** + 44 208 943 5544  
**F:** + 44 208 943 5347  
**E:** jhunter@bmtmail.com  
**W:** www.bmtbaxtereadie.com

### **BMT De Beer**

Guldenwaard 141  
Rotterdam  
3078 AJ

The Netherlands  
**Contact:** Mr Jeroen de Haas  
**Job Title:** Managing Director  
**T:** + 31 10 479 0311  
**F:** + 31 10 479 1466  
**E:** surveyors@bmtdebeer.com  
**W:** www.bmtdebeer.com

BMT De Beer is one of the world's leading independent marine surveying companies, providing a wide portfolio of services in cargo,

naval and technical matters. The company offers a comprehensive array of marine services and brings an unprecedented level of expertise to every aspect of marine surveying.

### **Bogaert Transmission (GEHA)**

Industriepark

Neringstraat 5  
Londerzeel  
B-1840  
Belgium  
**Contact:** Mr Luc Vlieminckx  
**T:** + 32 52 75 0421  
**F:** + 32 52 30 01 98

**E:** info@bogaert-transmission.com  
**W:** www.bogaert-transmission.com  
Supply conveyor-chains and sprockets for the heavy industries eg cement, fertiliser, ore, coal, gypsum etc. Chains with breaking load of 300 tons. Manufacture sprockets to a diameter of 2 metres. Consult for replacement chains for bucket-elevators and en-masse scraperchains etc.

### **Boh Bros. Construction Co., LLC**

730 South Tonti Street  
New Orleans  
LA  
70119  
USA

**Contact:** Mr Fred Fuchs  
**Job Title:** VP, Piling & Marine Construction  
**T:** + 1 504 827 7639  
**E:** ffuchs@bohbro.com  
**W:** www.bohbros.com/

### **Bonfanti srl**

Highway Briantea 4  
Ambivere  
24030  
Italy

**Contact:** Mr Riccardo Losa  
**T:** + 39 035 908 911  
**F:** + 39 035 493 7049  
**E:** coms@bonfanti.it

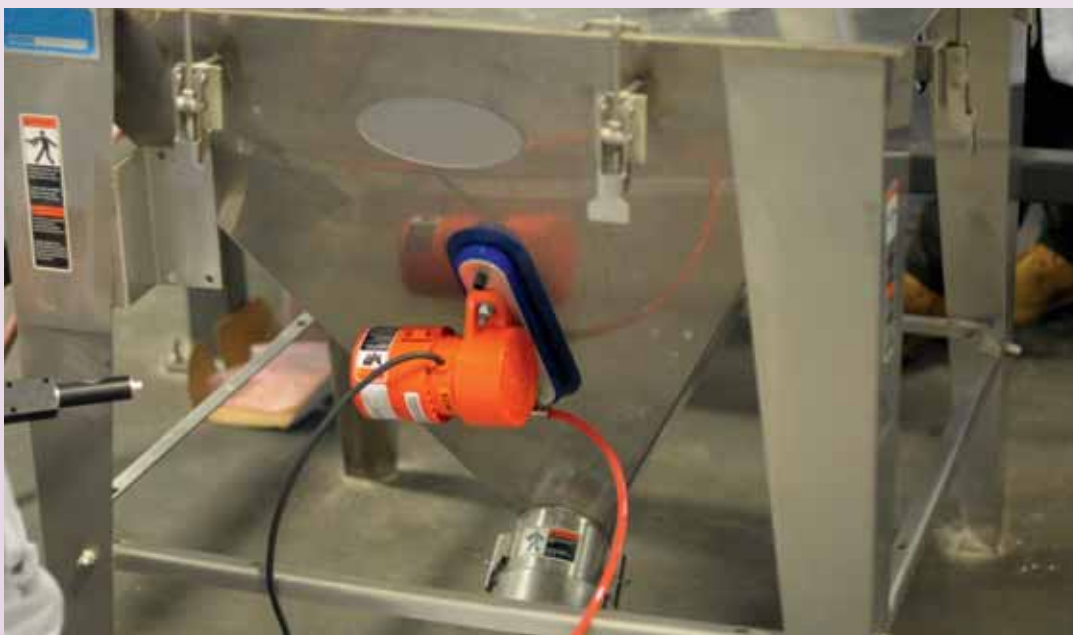



W: [www.bonfanti.it](http://www.bonfanti.it)

## Bosch Rexroth AG

Zum Eisengießerei 1  
Lohr am Main  
97816  
Germany  
**Contact:** Mrs Julia-Jacqueline Klein  
**T:** + 49 9352 18 4401  
**F:** + 49 9352 40 4885  
**E:**  
[Julia.Jacqueline.Klein@boschrexroth.de](mailto:Julia.Jacqueline.Klein@boschrexroth.de)  
**W:** [www.boschrexroth.com](http://www.boschrexroth.com)

## Bosch Rexroth B.V.

Kruisbroeksestraat 1  
Boxtel  
Noord-Brabant  
5281 RV  
The Netherlands  
**Contact:** Mr Edwin Doedee  
**Job Title:** Sales Manager,  
Materials Handling & Mining  
**T:** + 31 411 65 19 51  
**F:** + 31 411 65 14 83  
**E:** [cylinders@boschrexroth.nl](mailto:cylinders@boschrexroth.nl)  
**W:** [www.boschrexroth.nl](http://www.boschrexroth.nl)  
Has a worldwide responsibility for  
turnkey projects and the  
development and production of  
Hydraulic Cylinders.  
Core competence is the  
development of engineered-to-order  
products, mostly one-off solutions  
for specific applications.

## Bosch Rexroth Mellansel AB

PRS-MLL  
Mellansel  
890 42  
Sweden  
**Contact:** Mr Uno Sundelin  
**Job Title:** Business Area Manager  
**T:** + 46 660 87000  
**F:** + 46 660 87160  
**E:** [info@boschrexroth.se](mailto:info@boschrexroth.se)  
**W:** [www.boschrexroth.com](http://www.boschrexroth.com)  
Hägglunds Drives manufactures  
and markets drive system solutions  
for applications requiring high  
torque, low speeds and variable  
speeds. The drive systems are  
used in a wide range of industries,  
such as Mining and materials  
handling

## Bosstek

**BOSSTEK**

1607 W. Chanute Rd.  
Peoria  
IL  
61615  
USA  
**Contact:** Mr Mike Lewis  
**Job Title:** Sales Manager  
**T:** + 1 309 693 8600  
**F:** + 1 309 693 8605  
**E:** [info@bosstek.com](mailto:info@bosstek.com)  
**W:** <http://bosstek.com>  
BossTek delivers superior results  
by specializing in open-area dust  
management. DustBoss® dust  
suppression equipment combines  
an oscillating ducted fan with  
proprietary atomized misting  
technology to create a powerful, yet  
customizable dust control tool.  
Largest model can blanket 280,000  
SF (26,000 SM) with millions of  
droplets optimized for trapping dust  
particles.

## Boyne Area Manufacturing (BAM)

1 Altair Drive  
Boyne City  
MI

49712  
USA  
**Contact:** Mr Michael Ryan  
**Job Title:** Director of Sales &  
Marketing  
**T:** + 1 231 459 4242  
**F:** + 1 231 459 4243  
**E:** [jlaursen@boynearea-mfg.com](mailto:jlaursen@boynearea-mfg.com)  
**W:** [www.boynearea-mfg.com](http://www.boynearea-mfg.com)  
Boyne Area Manufacturing (BAM)  
began in 2008 with over 40 yrs. in  
sales, design and engineering  
experience in bulk material  
handling. We have built loading  
equipment for trucks and trailers,  
railcars, barges and ships, and  
stockpiling. Our spouts,  
positioners, gates, wet&dry dust  
collectors, and air slides are the  
best value in the industry. Call us!

## Brelko Conveyor Products

PO Box 62392  
Marshalltown  
Johannesburg  
Gauteng  
2107

South Africa  
**Contact:** Mr Peter Ellis  
**Job Title:** Sales & Marketing  
Director  
**T:** + 27 11 013 4000  
**F:** + 27 11 013 4150  
**E:** [peter@brelko.com](mailto:peter@brelko.com)  
**W:** [www.brelko.com](http://www.brelko.com)  
BRELKO develops, produces and  
markets a range of products for the  
bulk materials handling industry  
and provides an installation and  
maintenance service, including a  
24-hour call out service.  
BRELKO products are intended to  
assist in the control of spillage,  
carryback and dust, as well as  
promoting trouble free flow of  
material at belt conveyor transfer  
and load points.

## Bretby Gammatech Ltd.

Unit 4 & 5 Station Yard  
Station Road  
Melbourne  
Derbyshire  
DE73 8HJ  
UK

**Contact:** Mr Gary Wain  
**Job Title:** General Manager  
**T:** + 44 1332 694594  
**F:** + 44 1332 865860  
**E:** [info@bretbygammatech.com](mailto:info@bretbygammatech.com)  
**W:** [www.bretbygammatech.com](http://www.bretbygammatech.com)  
Melbourne-based Bretby  
Gammatech is a leading  
manufacturer of ash monitoring  
equipment that uses natural  
gamma radiation to test the quality  
of coal with 99% accuracy and  
without the need for laboratory  
testing. The company's products  
are sold to the international mining  
industry, in countries such as  
Turkey, Kazakhstan and Vietnam.

## Bridgestone Industrial Limited

Berliner Ring 89  
Bensheim  
64625  
Germany  
**Contact:** Mr John Hanson  
**T:** + 49 6251 690 396  
**F:** + 49 6251 690 397

**E:** [hanson.j@bridgestone-industrial.de](mailto:hanson.j@bridgestone-industrial.de)  
**W:** [www.bridgestoneindustrial.com](http://www.bridgestoneindustrial.com)

## Bridon International Ltd

Balby Carr Bank  
Doncaster  
South Yorkshire DN4 5JQ  
UK  
**Contact:** Ms Jenny Ferguson  
**Job Title:** Marketing Assistant  
**T:** + 44 1302 565100  
**F:** + 44 1302 382 263  
**E:** [fergusonj@bridon.com](mailto:fergusonj@bridon.com)  
**W:** [www.bridon.com](http://www.bridon.com)  
A world leader in the manufacture  
of high performance steel wire  
ropes for the industrial, mining,  
energy, marine and fishing markets.  
Bridon's strength and consistently  
superior quality products provide  
our customers with reliable and  
cost effective solutions in addition  
to the peace of mind of working  
with the world leader.



## Dust Doesn't Stand A Chance

To contain dust particles within your site,  
stop them at the point of emission.

DustBoss® has you covered.

- Mobile dust suppression for convenience, or tower-mounted for wider coverage.
- Slash water usage by more than half.
- Turn it on and walk away.

**BOSSTEK**

[bosstek.com](http://bosstek.com)  
309.693.8600



**Innovative solutions for global challenges.**

World's population and therefore the demand for food is increasing. Every year, millions of tons of grain are collected, stored and handled around the globe – and the upward trend is unbroken. Only the most up-to-date plant and equipment can guarantee rapidity and quality while minimizing raw material losses.

In order to meet the increasingly stringent challenges, Bühler Grain Logistics provides with its capabilities the best possible solutions – for conveying, cleaning, drying, storing, dedusting or loading and unloading the most important commodity on earth. Our contribution to feed the world - together with you!

[www.buhlergroup.com/grain-logistics](http://www.buhlergroup.com/grain-logistics)

Strong partner  
for **your grain  
management.**



## Brock Grain Systems

A Division of CTB, Inc  
611 N. Higbee Street  
PO Box 2000  
Milford  
Indiana  
46542-2000  
USA

**Contact:**

**Job Title:** Managing Director  
**T:** + 1 574 658 4191  
**F:** + 1 574 658 4133  
**E:** brock@brockgrain.com  
**W:** www.brockgrain.com

## BRUKS AB

Västergatan  
Arbrå  
SE-82010  
Sweden

**Contact:** Mr Pontus Westrup  
**E:** pwp@bruks.com  
**W:** http://www.bruks.com/

## BRUKS Klöckner GmbH

Grabenstrasse 1  
Hirtscheid  
Nistertal  
D - 57647  
Germany

**Contact:** Mr Markus Schwarz  
**T:** + 49 26 61 28 167  
+49 (0) 26 61 / 280  
**F:** + 49 26 61 28 180  
**E:** msz@bruks.com  
**W:** www.bruks.com

## BRUKS Rockwood Incorporation

5975 Shiloh Road  
Suite 109  
Alpharetta  
GA  
30005  
USA

**Contact:** Mr Ken Upchurch  
**Job Title:** Vice President of Sales & Marketing  
**T:** + 1 770 849 0100 x109  
**E:** kuh@bruks.com  
**W:** www.bruks.com

## BSG Resources

36 Fricker Road  
Illovo Boulevard  
Illovo  
Johannesburg  
Gauteng  
2196  
South Africa

**Contact:** Mr Frank Eagar  
**Job Title:** New Business Development  
**T:** + 27 11 3271 070  
**F:** + 27 11 3271 011  
**E:** frank@bsgresources.com  
**W:** www.bsgresources.com

## Bucket Mart Inc.

PO Box 1240  
Marion  
Illinois  
62959  
USA

**Contact:** Mr Jack Johnson  
**Job Title:** President/CEO  
**T:** + 1 813 390 8626  
**F:** + 1 813 908 9474  
**E:** salesbucketmart@aol.com  
**W:** www.bucketmart.net  
New/Used All sizes/Types/Brands  
Clamshell Buckets/Grabs, Grapple  
Buckets/Grabs, HYD  
Buckets/Grabs, Radio Controlled  
Buckets/Grabs Buckets/Grabs.

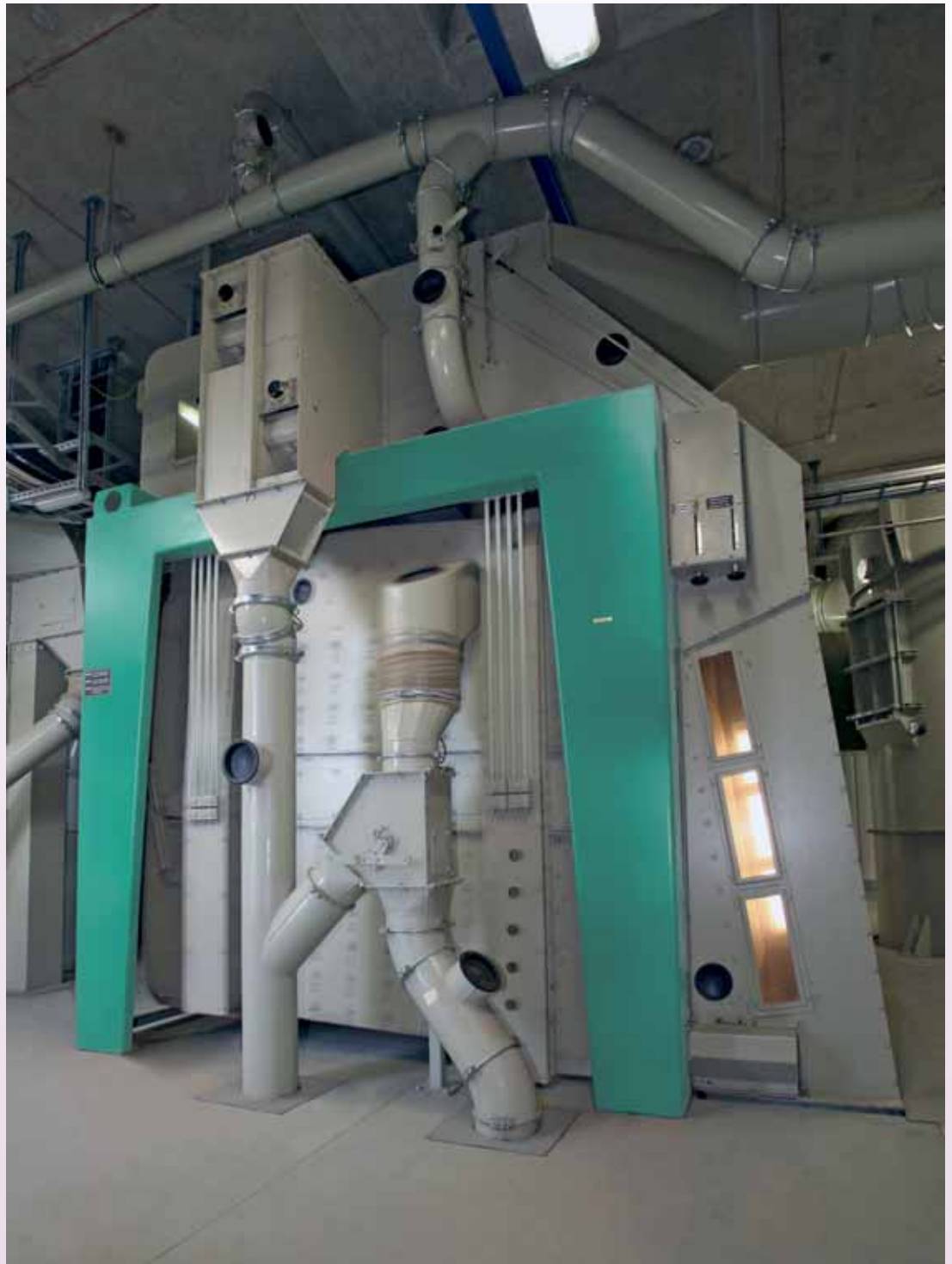

## Buhler AG, Grain Logistics



Gupfenstrasse 5  
Uzwil  
CH-9240  
Switzerland

**Contact:** Mr Vincent van der Wijk  
**Job Title:** Product Manager  
**T:** + 41 71 955 39 49  
**E:** Vincent.vanderwijk@buhlergroup.com  
**W:** www.buhlergroup.com  
Customized solutions for grain handling.

Bühler Grain Logistics is the ideal partner when it comes to reliable solutions in the area of grain handling and storage. The

company's wide range of offerings includes ship loading and unloading solutions, conveying systems and silos as well as storage equipment.

## Buhler GmbH



Eichstaetter Strasse 49  
Beilngries  
92339  
Germany

**Contact:** Mrs Martina Eckerle  
**T:** + 49 8461 701 129  
**E:** Martina.eckerle@buhlergroup.com  
**W:** www.buhlergroup.com/grain-logistics  
Customized solutions for grain handling.

Bühler is the ideal partner when it comes to reliable solutions in the

area of grain handling and storage. The company's wide range of offerings includes ship loading and unloading solutions, conveying systems and silos as well as storage equipment.

## Bulk Cargo Handling BVBA

Nijverheidskaai 28  
Bus 9  
Brussels  
1080  
Belgium

**Contact:** Mr Nicola Samyn  
**Job Title:** CEO  
**T:** + 32 477 44 98 81  
**E:** bch.belgium@gmail.com

## Bulk Lift International

1013 Tamarac Drive  
Carpentersville  
IL  
60110  
USA

**Contact:** Mr Brian Kelly  
**Job Title:** National Sales Manager  
**T:** + 1 847 428 6059 x 215  
**F:** + 1 847 428 7180  
**E:** briank@bulklift.com  
**W:** www.bulklift.com

## BULK.ID

Oude Kasel 16  
Waregem  
B-8791  
Belgium

**Contact:** Mr Bart Vanpoucke  
**T:** + 32 56 71 53 85



# DOCKSOLID BESPOKE BULK PORT EQUIPMENT

FULL RANGE OF HOPPERS AVAILABLE FROM  
STANDARD TO HIGH SPECIFICATION UNITS

**DOCKSOLID** Towed, Rail Mounted, Shore Power  
or Self Driven units.

**DOCKSOLID** Patented Steering and Suspension  
Systems for High Mobility and to  
accommodate uneven quay walls.

**DOCKSOLID** State-of-the-art Dust Suppression  
Systems.

**DOCKSOLID** Built for Reliability and Longevity:  
Structures Designed for Dynamic and  
Static Loads.



F: + 32 56 75 62 13  
 E: bart.vanpoucke@bulkid.be  
 W: www.bulkid.be

## Buttimer Engineering



Carrigen Industrial Estate  
 Cahir

Co. Tipperary  
 Munster  
 E21 CC60  
 Ireland

Contact: Mr Fergal Buttmer  
 Job Title: Director

T: + 353 52 744 1377

F: + 353 52 744 1087

E: info@buttimer.ie

W: http://buttimer.com

Buttimer Engineering is a diversified mechanical engineering company, which specialises in bulk materials handling systems and high-quality steel fabrication. The company operates across a range of industries, providing design, fabrication, procurement, installation, maintenance, project management and engineering services.

## ByM Agencia Martima

Coronel Pereira 72

OF 1002

Las Condes

Santiago

1002

Chile

Contact: Mr Anogar Muschen V

Job Title: Manager

T: + 56 2 365 1197

F: + 56 2 366 1267

## C Spencer Ltd

One Humber Quays  
 Wellington Street West  
 Hull  
 HU1 2BN  
 UK

Contact: Mr Ian Atkinson  
 Job Title: Engineering Director  
 T: + 44 113 815 0015  
 E: engineering@cspencertfd.co.uk  
 W: thespencergroup.co.uk

## C. Christophel GmbH

Taschenmacherstr. 31-33  
 Lübeck

SH 23556

Germany

Contact: Mr Matthias Dammer

Job Title: Sales

T: + 49 43 66 88 48 20

F: + 49 43 66 88 88 75

E: mail@christophel.com

W: www.christophel.com

## Cable Arm Inc

3452 W Jefferson Avenue

Trenton

Michigan

48183 2939

USA

Contact: Mr Ray Bergeron

Job Title: President

T: + 1 734 676 6108

F: + 1 734 676 1345

E: info@cablearm.com

W: www.cablearm.com

Produces environmental and bulk handling grabs. These are available in double rope design for mobile cranes and in four rope versions for portal dockside cranes and gantries.

## Cachapuz Bilanciai Group

Parque Industrial de Sobreposta

Apartado 2012

Braga

Braga

4701-952

Portugal

Portugal

Contact: Mr Nuno Matos

Job Title: International Business Developer

T: + 351 253 603 480

F: + 351 253 603 485

E: info@cachapuz.com



W: www.cachapuz.com

## Calim Grab Industry

Piri Reis Cad

Çınar San.

Sitesi No:46 Maltepe

Istanbul

81540

Turkey

Contact: Mr Murat Calim

T: + 90 533 226 4923

F: + 90 216 399 79 71

E: info@calimkepce.com

W: www.calimkepce.com

Calim Grabs is a manufacturer of mechanical, electro-hydraulic and remote controlled grabs.

Other: Lifting equipments C Hooks

## Camar Mill Systems Ltd

P.O. Box 419, 1600 King St N

St. Jacobs

Ontario N0B 2N0

Canada

Contact: Mr Rick Weber

Job Title: President

T: +1 519 664 3709

F: +1 519 664 3700

E: rick@camar.ca

W: www.camar.ca

Camar is an engineering leader, providing Total Project Engineering, Project Management and Process Automation. Marine grain terminals, feed mills and related process design and construction, from initial plan development through engineering, construction management and final commissioning.

## Cambelt International Corp

2820 W Directors Row

Salt Lake City

Utah

84104

USA

Contact: Mr Dave Hansen

Job Title: Vice President

T: + 1 801 972 5511 ext 205

F: + 1 801 972 5522

E: info@cambelt.com

W: www.cambelt.com

Manufacturer of high incline belt conveyor and mechanical bulk materials handling systems. Also produces 'Cambelt' automated reclaim systems for large volume dome storage systems.



## Capotex

Colombia 1  
Majadahonda  
Madrid  
28220  
Spain

**Contact:** Ms Eva Barrilero  
**T:** + 34 91 634 71 92  
**F:** + 34 91 636 21 15  
**E:** barrilero@capotex.com  
**W:** www.capotex.com  
CAPOTEX is the only company on a world level that exclusively specialises in covering belt conveyors. Our experience enables us to provide the market with a wide series of standard solutions, together with customised designs at very competitive prices.

## Captrain Deutschland GmbH

Georgenstrasse 22  
Berlin 10117  
Germany

**Contact:** Ms Romy Mothes  
**Job Title:** Press & Public Relations Officer  
**T:** + 49 30 39 60 11 0  
**F:** + 49 30 39 60 11 70  
**E:** info@captrain.de  
**W:** www.captrain.de  
Captrain Deutschland is one of the leading rail logistics companies in Germany and Europe. Be it international traction services, industrial rail operations or transport concepts tailored to the individual processes of its customers, Captrain Deutschland offers innovative, customised and efficient logistics solutions.

## Carbonser, S. A. DE C. V.

Guillermo Gonzalez Camarena  
No. 1200 Piso 7  
Centro Ciudad Santa Fe  
DF  
01210  
Mexico

**Contact:** Ing. Thomas Cortes Petersen  
**Job Title:** Director  
**T:** + 52 55 5246 7360  
**F:** + 52 55 5246 7391  
**E:** tcortes@techint.com.mx  
**W:** www.techint.com.mx  
Techint is the leader of the Consortium Carbonser for executing the BOT contract to handle up to 6 million tons of coal annually. Techint is a leading engineering and construction company operating worldwide. The services provided included the design, construction and operation of the coal terminal for 30 years starting from 1999.

## Cardno TEC

275 West Street  
Suite 101  
Annapolis  
MD 214014  
USA

**Contact:** Mr Marcel Veilleux  
**Job Title:** Principal  
**T:** + 1 410 9900299  
**F:** + 1 410 990 0455  
**E:** marcel.veilleux@cardno-gs.com  
**W:** http://www.cardno.com/

## Cargotec Sweden AB, Marine Selfunloaders

PO Box 914  
Enköping

SE-745 25  
Sweden

**Contact:** Mr Johan Ericson  
**T:** + 46 171 232 00  
**F:** + 46 171 232 99  
**E:** susales.enk@cargotec.com  
**W:** www.cargotec.com

## Carlsen Group

Van Polanenweg 2  
Krimpen aan de IJssel  
2921 LT  
The Netherlands

**Contact:** Mr Cor de Kwant  
**T:** + 31 180 440 720  
**E:** cdk@carlsengroup.com  
**W:** www.carlsengroup.com  
A leading expert in marine, offshore and onshore bulk handling systems. 50 years of design and engineering experience in equipping dry bulk ships, barges, supply vessels, harbor loading and unloading equipment, drilling rigs and floating terminals.

## Carmatec AB

Sporregatan 16  
Malmö  
Malmö  
S-213 77  
Sweden

**Contact:** Mrs Carina Thern  
**Job Title:** Managing Director  
**T:** + 46 4014 07 95  
**F:** + 46 4014 07 99  
**E:** carina.thern@carmatec.se  
**W:** www.carmatec.se  
Our mission is to;  
- guide and partner you in the self unloading market for cement handling business  
- develop efficient and practical

systems/ways to handle bulk materials  
- find new solutions for existing equipment  
- offer advice and service  
- develop and refine components and solutions for special services and applications.

## CASE CNH Industrial

Viale delle Nazioni 55  
Modena  
Italy

**Contact:** Ms Francesca Asteggiano  
**Job Title:** Commercial Manager  
**T:** + 39 011 008 6261  
**E:** Francesca.ASTEGGIANO@cnhind.com  
**W:** www.cnhindustrial.com/

## Cassantec AG

Technoparkstrasse 1  
Zürich  
8005  
Switzerland

**Contact:** Mr Moritz von Plate  
**Job Title:** CEO  
**T:** + 41 44 445 22 60  
**F:** + 41 44 445 22 61  
**E:** info@cassantec.com  
**W:** www.cassantec.com  
Within the field of Predictive Maintenance, Cassantec has developed a prognostic solution, with which predictive analytics approaches can be complemented, enhanced and improved. Our Prognostic Report provides insight into the future state of assets with an explicit time horizon of typically weeks or months, in special cases even years.

## Caterpillar Belgium

Ave des Etats Unis  
Charleroi  
B6041  
Belgium

**Contact:** Mr Philippe Michaux  
**Job Title:** Marketing  
**F:** + 32 71 25 29 56  
**E:** michaux\_philippe@cat.com

## Caterpillar Inc

100 NE Adams Street  
Peoria  
IL  
616-6335  
USA

**Contact:** Mrs Sharon Holling  
**Job Title:** PR  
**T:** + 1 309 675 8995  
**F:** + 1 309 675 4757  
**E:** Holling\_Sharon\_L@Cat.com  
**W:** www.cat.com

Caterpillar equipment product line, consisting of more than 300 machines, sets the standard for the construction industry. The company is also the world's largest manufacturer of medium-speed engines and high-speed diesel engines. The parts distribution network features 23 centres in 11 countries and 13 centres in the United States.

## Caterpillar SARL

Route de Frontenex 76  
Geneva  
1207  
Switzerland

**Contact:** Mr Bert Heijligers  
**Job Title:** Marketing & Communication  
**T:** + 31 73 639 9716

CIMBRIA.COM

# GROWING INTO THE FUTURE TAKING CARE ADDING VALUE

Thorough technical engineering experience and in-depth product knowledge enable us to supply solutions for handling and storage of various grain and seed products. Special focus is kept on effective sorting and cleaning, gentle handling and storage, crop-purity, safe and dust-free operation and low running costs.

## SOLUTIONS. TOGETHER.

CIMBRIA UNIGRAIN A/S  
Praestjorden 6 | DK-7700 Thisted  
Phone: +45 96 17 90 00 | E-mail: unigrain@cimbria.com





**E:** Heijligers\_Bert@cat.com  
**W:** www.cat.com  
 With 2015 sales and revenues of \$47.011 billion, Caterpillar is the world's leading manufacturer of construction and mining equipment, diesel and natural gas engines, industrial gas turbines and diesel-electric locomotives. Port equipment includes material handlers, wheel loaders, track-type loaders, track-type tractors, skid steers as well as an extensive range of solutions and support services.

## Cavotec Deutschland GmbH

Ludwig-Erhard Strasse 1a  
 Eschborn  
 D-65760  
 Germany  
**Contact:** Dipl.-Ing. Dirk Moll  
**Job Title:** Managing Director  
**T:** + 49 6196 50950 12  
**F:** + 49 6196 50950 22  
**E:** dirk.moll@cavotec.com  
**W:** www.cavotec.com

## Cavotec Inc

124 Hatfield Road  
 Statesville  
 NC 28625  
 USA  
**Contact:** Mr Erik Wilhelmson  
**Job Title:** President  
**T:** + 1 704 873 3009  
**F:** + 1 704 873 3093  
**E:** erik.wilhelmson@cavotec.com  
**W:** www.cavotec.com

## Cavotec SA

Via S. Balestra 27  
 Lugano  
 CH-6900  
 Switzerland  
**Contact:** Mr Dirk Fussel  
**Job Title:** Sales Director Mining & Tunnelling  
**T:** + 41 91 911 4010  
**F:** + 41 91 922 54 00  
**E:** lorene.grandidier@cavotec.com  
**W:** www.cavotec.com  
 Cavotec is a leading engineering group that designs and manufactures automated connection and electrification systems for ports, airports and industrial applications worldwide. Our innovative technologies ensure

safe, efficient and sustainable operations.

## CDM Systems, Inc

6002 East N Avenue  
 Kalamazoo  
 MI  
 49048  
 USA  
**Contact:** Mr Andrew Parker  
**T:** + 1 763 428 9700  
**F:** + 1 763 428 9701  
**E:** steve@cdmsys.com  
**W:** www.cdmsys.com  
 CDM Systems, Inc. offers a complete line of Mechanical Marine Leg Unloaders with mobile single leg capacities from 150 to 500 TPH (Stationary installations up to 1500 TPH.)

## CH2M Hill

1100 112th Avenue NE  
 Suite 400  
 Bellevue  
 WA 98004  
 USA  
**Contact:** Mr J Michael Zachary  
**Job Title:** VP Dir of Ports & Intermodal  
**T:** + 1 425 453 5000  
**F:** + 1 425 462 5957  
**E:** feedback@ch2m.com  
 Provides marine terminal engineering and planning as well as economic feasibility studies, environmental planning and construction management for the transportation industry.

## Changsha Kaiyan Instruments Co. Ltd

172 Kaiyuan Road  
 Changsha Economic & Technological Development Zone  
 Changsha  
 410100  
 China  
**Contact:** Ms Susan Wang  
**Job Title:** Overseas Director  
**T:** + 86 731 4012074 / + 86-731-84021617  
**F:** + 86 731 4012074  
**E:** susanky@chs5e.com  
**W:** www.ckcic.net

## CHIA Espirales.es

Poligono Industrial El Sotillo S/N  
 La Puebla de Cazalla

Seville  
 41540  
 Spain  
**Contact:** Ms Carmen Sojo  
**T:** + 34 629 340 472 / + 34 695 402 000  
**E:** info@espirales.es  
**W:** http://www.espirales.es/eng/

## Chief Industries UK Ltd.

Beckingham Business Park  
 Tolleshunt Major  
 Maldon  
 Essex  
 CM9 8LZ  
 UK  
**Contact:** Mr Geoff Freed  
**T:** + 44 1621 868944  
**F:** + 44 1621 868955  
**E:** info@chief.co.uk  
**W:** www.chief.co.uk  
 Chief Industries is an international company supplying grain storage systems throughout the world. Sizes of individual silo tanks range up to 30,000tons, with multiple silo complex sizes of several hundreds of thousand tons. Conveyors and ancillary equipment range up to 1600tph or more.

## Chief Industries, Inc.

Chief Agri  
 P.O. Box 848  
 Kearney  
 NE  
 68848  
 USA  
**Contact:** Mr Travis Woodside  
**Job Title:** Marketing Assistant  
**T:** + 1 308 237 3186  
**F:** + 1 308 389 6703  
**E:** agri@chiefind.com  
**W:** www.agri.chiefind.com  
 Chief Agri/Industrial, a division of Chief Industries, Inc., specializes in the design, manufacture and sales of grain storage systems around the world. With over 60 years of experience, Chief offers customers a wide range of products and the expertise to serve their individual needs. Chief offers everything needed for a complete grain storage system, including steel grain silos, grain handling, conditioning equipment (conveyors, elevators, fans, heaters

and floors) along with continuous flow grain dryers and square feed mill storage silos.

## China Sonangol International (S) Pte Ltd

9 Temasek Boulevard #42-01  
 Suntec Tower 2  
 Singapore  
 038989  
 Singapore  
**Contact:** Mr Eugene Tan  
**T:** + 65 6808 1880  
**F:** + 65 6808 1881  
**E:** sg@chinasonangol.com  
**W:** www.chinasonangol.com

## CHL Equipment Ltd (incorp. Verstegen Grabs UK)

24 Solihull Road  
 Shirley  
 Solihull  
 West Midlands  
 B90 3HD  
 UK  
**Contact:** Mr John Hinder  
**Job Title:** General Manager  
**T:** + 44 121 733 8100  
**F:** + 44 121 733 2796  
**E:** sales@chlequipment.com  
**W:** www.chlequipment.com  
 CHL are the U.K. agents for the leading European manufacturers of material handling equipment. Whether your need is for ship unloading, moving concrete products, handling steel coils or scrap metal, we can provide the solution. We supply only the highest quality products to ensure durability, productivity, and economy for the lifetime of the equipment.

## Christianson Systems Inc.

PO Box 138  
 Blomkest  
 Minnesota  
 56216  
 USA  
**Contact:** Mr Mike Schow  
**Job Title:** Sales Manager  
**T:** + 1 320 995 6141 Ext 360  
**F:** + 1 320 995 6145  
**E:** sales@christianson.com

**W:** www.christianson.com  
 Builds pneumatic grain vacs for bulk grains and feeds. Full service supplier from design and manufacturing to installation and training. Christianson shipunloaders are installed in over 90 countries worldwide. Trademarks/Brandnames include SuperTower, SuperPortable, Handlair, Vac-U-Vator, Chem-Vac, Seed Vac, VacBoss, Push Pac, AugerVac, Dunbar Kapple.

## CICSA & MCV s.r.l.

Via dell'Industria, 2  
 Beverate di Brivio (LC)  
 23883  
 Italy  
**Contact:** Mrs Luisa  
**T:** + 39 0399 2732 12  
**F:** + 39 0399 2732 20  
**E:** sales@cicsa.it  
**W:** www.cicsa-mcv.com

## Cimbria Unigrain A/S



Praestjorden 6  
 Thisted  
 DK- 7700  
 Denmark  
**Contact:** Mr Lars Noergaard  
**Job Title:** Managing Director  
**T:** + 45 72 42 24 00 / +45 96179000  
**F:** + 45 72 42 24 99  
**E:** cbe@cimbria.com  
**W:** www.cimbria.com  
 More than 30 years experience within developing and marketing Moduflex loading chutes and Contec screw conveyors for dustfree outloading and conveying of dry bulk material. The product programme covers all branches from agriculture to industry and solutions can be delivered for all applications within road & rail, shiploading & stockpiling.

## CINTASA S.A.

Ctra. N-232 - Km. 252a Utebo  
 Zaragoza 50180  
 Spain  
**Contact:** Mr Jaime Simon  
**Job Title:** Sales Manager  
**T:** + 34 976 770 656  
**E:** cintasa@cintasa.com  
**W:** http://www.cintasa.com  
 Cintasa's main activity is engineering, manufacturing and installing material-handling systems, transport and warehouse element systems. The company offers conveyor systems that are tailored to the customer's operation.

## Cita Logistics LLC

3 Commercial Place Suite 150  
 Norfolk  
 Virginia  
 23510  
 USA  
**Contact:** Mrs Ghislaine Taylor  
**T:** + 1 757 623 6900  
**F:** + 1 757 623 6911  
**E:** cita@citalogistics.com

## Cita Logistics LLC

Suite 708/1 Newland Street  
 Bondi Junction  
 Sydney  
 NSW  
 2022





CIVETTINI ITALO & C SAS

**The quality of our products is a result of our passion, dedication and hard work.**



**Sele legale - Registered Office**

Civettini Italo & c sas  
Via Campagnoli Golgi,7  
25012CalvisanoBs Italy  
P.I. 01583540982

Registro Imprese di Brescia 01583540982 – Iscrizione R.e.a 324999

**Sede Operativa - Working Headquarters**

Via Sigalina a Mattina, 12/14  
25018 - Montichiari - (BS) - Italy

**Mobile:** (+39) 340 1358822 **Foreign office:** (+44) 7978302839  
[www.cfshandling.it](http://www.cfshandling.it)



Australia  
**Contact:** Ms Julie Forster  
**Job Title:** Branch Manager  
**T:** + 61 289 646 250  
**E:** cita-aust@citalogistics.com  
**W:** www.citalogistics.com  
 CITA Logistics LLC, established in 2004 and registered in the State of Delaware, specialises in Bulk Logistics Services provision, including Bulk Ore Sampling & analysis, Shipping Agency, Freight Forwarding, Logistics Management, Statistical Data and Market Intelligence. Its offices are located a short distance from Ports on the East Coast of the USA (Norfolk, Virginia) and the East Coast of Australia (Mackay, Queensland).

## Civettini Italo & c sas (CFS Handling)



Via Golgi, 7  
 Calvisano  
 BS  
 25012  
 Italy  
**Contact:** Mr Italo Civettini  
**Job Title:** Owner  
**T:** + 39 340 135 8822  
**F:** + 39 030 207 2026  
**E:** civettini@cfshandling.it  
**W:** www.cfshandling.it  
 Civettini & c sas with brand CFS handling works in design and manufacturing of equipment for handling across a range of sectors including, coal, cement, steel mills, demolition, ores, urban solid waste, paper etc.  
 The company's product range includes mechanical, hydraulic and electro-hydraulic buckets as well as hydraulic and electro-hydraulic grabs to suit customer's specific needs.201

## Clariant Corporation

101 Christine Drive  
 Belen  
 NM  
 87002  
 USA  
**Contact:** Mr Justin Mueller  
**Job Title:** Head of Business Group  
 CDP Americas  
**T:** + 1 505 975 1676  
**E:** desiccants@clariant.com  
**W:** www.desiccants.clariant.com

## Clarke Chapman Manufacturing Ltd

P O Box 9  
 Saltmeadows Road  
 Gateshead  
 Tyne & Wear  
 Newcastle  
 NE8 1SW  
 UK  
**Contact:** Mr Nicholas Hancock  
**Job Title:** General Manager  
**T:** + 44 191 477 2271  
**F:** + 44 1225 332529  
**E:** info@clarkechapman.co.uk  
**W:** www.clarkechapman.co.uk/

## Claudius Peters Projects GmbH

Schanzenstrasse 40  
 Buxtehude  
 D-21614  
 Germany  
**Contact:** Mr Frank Siebert

**Job Title:** Sales Director  
**T:** + 49 4161 706 515  
**F:** + 49 4161 706 270  
**E:** projects@claudiuspeters.com  
**W:** www.claudiuspeters.com  
 Product lines include grinding systems, cement clinker coolers, storage and mixing silos, pneumatic conveying systems, ash removal systems, self-unloading vessels, packing and palletising systems, pulverised coal injection systems for blast furnaces. Building material product lines include natural and by-product gypsum processing

systems for plants, wallboard production plaster and ceilingboard plants.

## Claudius Peters Technologies S.A.S

34 Avenue de Suisse  
 BP 269  
 Illzach  
 Cedex  
 F-68316  
 France  
**Contact:** Mr Jean Christophe

Holfert  
**Job Title:** Sales Director  
**T:** + 33 389 31 33 19  
**F:** + 33 389 61 95 25  
**E:** technologiessa@claudiuspeters.com  
**W:** www.claudiuspeters.com  
 Product lines of stackers/reclaimers, blending beds, Truck and Wagon Load/unload/tipler systems, Belt Conveyor systems.

## CLC Technology Enterprise Co Ltd

Room A6, 1/F Mai Sik Industrial Bldg  
 1~11 Kwai Ting Road  
 Kwai Chung  
 Hong Kong  
 China  
**Contact:** Mr David Lin  
**Job Title:** Marketing  
**T:** + 86 1865 8165 919  
**E:** davidlin@clc-enterprises.com  
**W:** www.clc-enterprises.com/

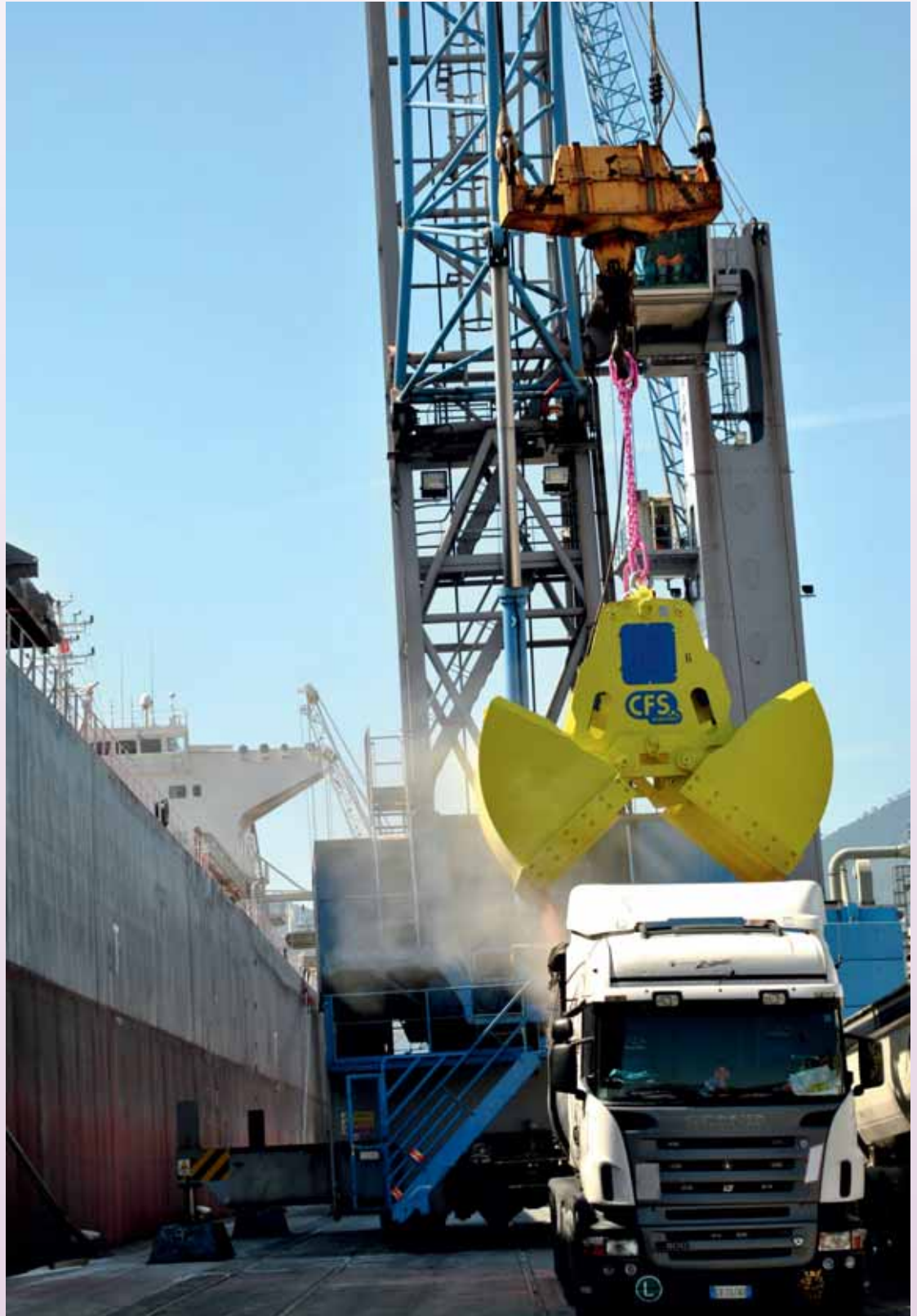

# Cleveland Cascades Ltd

Global leader in bespoke dry bulk loading chutes

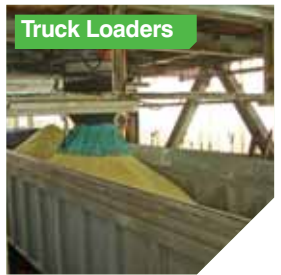
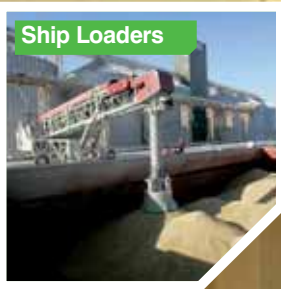

## Cleveland Cascades are Specialists in the design and manufacture of bespoke dry bulk loading chutes.

Our bespoke solutions are designed to meet each customer's specific requirements from a tool kit of proven components, utilising the expertise of a team of specialist in house design engineers.

We lead the loading chute industry & set the standard for dust emissions and environmental pollution control in dry bulk handling.

Our worldwide reputation is built on high quality, well-engineered, robust, high performance chutes, backed up by excellent customer service and global lifetime product support.

### Contact Cleveland Cascades Ltd

Unit 22, Dukesway, Teesside Industrial Estate, Thornaby, Stockton-on-Tees, Cleveland, TS17 9LT, United Kingdom Tel: +44 1642 753260 | Fax: +44 1642 753270

E-mail: [enquiries@clevelandcascades.co.uk](mailto:enquiries@clevelandcascades.co.uk) | Website: [www.clevelandcascades.co.uk](http://www.clevelandcascades.co.uk)





## Cleveland Cascades Ltd



Unit 22 Dukeway  
Teesside Industrial Estate  
Thornaby  
Stockton on Tees  
TS17 9LT  
UK

**Contact:** Mr Ian Barnard  
**Job Title:** Managing Director  
**T:** + 44 1642 753260  
**F:** + 44 1642 753270  
**E:** enquiries@clevelandcascades.co.uk  
**W:** www.clevelandcascades.co.uk  
Has developed a new dustless shiploading chute that can operate without additional dust extraction systems. Suitable for most types of bulk material including highly dusty products such as cement clinker, alumina, phosphate and apatite.

## Clime SA

c/- Castilla 52-54  
Barcelona  
08018  
Spain  
**Contact:** Mr John Climent  
**T:** + 34 93 307 6362  
**F:** + 34 93 308 5649  
**E:** climesa@fibcnet.com  
**W:** www.fibcnet.com

## Clough Limited

58 Mounts Bay Road  
Perth  
Western Australia 6000  
Australia  
**Contact:** Mr Max Bergomi  
**Job Title:** Exec VP -  
Commissioning & Asset Support  
**T:** + 61 8 9281 9281  
**F:** + 61 8 9281 9943  
**E:** clough@clough.com.au  
**W:** www.clough.com.au  
A service provider of Project Management, Engineering and Construction Contracting services in the oil and gas (onshore and offshore), petrochemicals, mining and minerals processing industries, infrastructure (including power and harbour works) and manufacturing sectors.

## CNBM International Engineering Co., Ltd.

19th Floor, Building 4  
Interwest Business Center  
NO.9 Shouti South Road  
Beijing  
100044  
China  
**Contact:** Mr Wang Lin  
**Job Title:** Bulk Handling Division Manager  
**T:** + 86 10 68796130  
**F:** + 86 10 68796029  
**E:** wanglin@cblme.com  
**W:** www.cnbmengineering.com  
CNBM Bulk Handling consists of unloading/loading (barge, railway car, truck), conveying, storing (silo, dome, stacker & reclaimers etc.) and optional systems. Both pneumatic and mechanical working principles are integrated into a customer-oriented solution upon specific situation. It can help you with either your in-plant transportation or your terminal establishment.

## CNK INTERNATIONAL LIMITED

No.29 Building  
North Gongren Xincun  
Jinan City  
China  
**Contact:** Mr Kevin  
**T:** + 86 531 6880 0516  
**F:** + 86 531 6880 0516  
**E:** sales@cnkcorporation.com  
**W:** www.cnkcorporation.com

## Coal & Mineral Technologies (SABS)

1 Dr Lategan Road  
Groenkloof  
Pretoria  
Gauteng  
0001  
South Africa  
**Contact:** Mr Heinrich Williams  
**Job Title:** General Manager  
**T:** + 27 12 428 6328  
**F:** + 27 12 428 7795  
**E:** heinrich.williams@sabs.co.za  
**W:** www.sabs.co.za

## COBRA Europe SA

12 rue Henry Guy  
BP 40081  
Luxeuil les Bains Cedex

70300  
France  
**Contact:** Mr Edgar Mansour  
**Job Title:** President  
**T:** + 33 671 58 72 56  
**F:** + 33 384 40 44 92  
**E:** emphone@cobra-cs.com  
**W:** www.cobra-cs.com

## Coeclerici Logistics S.p.A.

Piazza A. Diaz, 7  
Milano  
20123  
Italy  
**Contact:** Captain Giordano Scotto  
d'Aniello  
**Job Title:** Head of Commercial  
Department  
**T:** + 39 02 6246 9453  
**F:** + 39 02 6246 9444  
**E:** gscotto@coeclerici.com  
**W:** www.coeclerici.com  
One of the best known and most reputed companies in the field of offshore transloading operations. This achievement is based on the dedication and commitment of the company towards its clients as well as being an integral part of their production chain with a view to long term relationships.

## Coles Associates

PO Box 5096  
Dalkeith  
Western Australia  
6009  
Australia  
**Contact:** Mr Richard Coles  
**Job Title:** Manager Business  
Development  
**T:** + 61 8 9389 8484  
**F:** + 61 8 9386 5700  
**E:** rcoles@colesassociates.com.au  
**W:** www.shiploader.com.au

## Comercial Tauro S.A.

Merced 380 Of. 71  
Santiago  
Metropolitana  
8320310  
Chile  
**Contact:** Mr Matias Leyton  
**Job Title:** General Manager  
**T:** + 56 2 23621177  
**F:** + 56 2 23621177  
**E:** mleyton@vibrafloor-latam.com  
**W:** www.vibrafloor-latam.com

## Condepols S.A.

Avda. Iberoamérica, 35  
Alcalá La Real  
Jaén  
23680  
Spain  
**Contact:** Mr Luis Gómez  
**Job Title:** Commercial Director  
**T:** + 34 953 1021 00  
**E:** comercial@condepols.com  
**W:** www.condepols.es  
Condepols, Spanish Manufacturer of big-bags made of polypropylene to store or transport merchandise from 500 to 2000 kg and liners for maritime containers to transport merchandise in bulk.

## Conductix -Wampfler

**Australia**  
14 England St  
Dandenong  
VIC  
3175  
Australia  
**Contact:** Mr Mark Howlett  
**Job Title:** Managing Director  
**T:** + 61 3 9706 8844  
**F:** + 61 3 9794 9298  
**E:** sales-australia@conductix.com  
**W:** www.conductix.com  
Previously named Insul-8 & now





#### Motor Driven Reels

- Monospiral and Level-Wind configurations
- Rugged and dependable magnetic coupler for dusty environments



#### Cable Festoon

- Corrosion-resistant, long-life rollers; precision sealed bearings
- Systems customized for the application
- Preassembled option, for easy installation



#### Cable Chain

- Rugged design for demanding environments
- Long operating life
- Custom-configured

## Rugged Energy & Data Transmission Systems

Conductix-Wampfler has one critical mission: To keep your bulk material handling operations running 24 / 7 / 365. You need proven, worry-free energy solutions - and Conductix-Wampfler has them. Our systems provide reliable electric power and water to stacker/reclaimers, barge and ship loaders/unloaders, bulk conveyors, tripper systems, and gantry cranes. Conductix-Wampfler systems are rugged, low maintenance, and time-tested in tough, dusty environments. All products are backed by the largest sales and service network worldwide!

[www.conductix.com](http://www.conductix.com)

**CONDUCTIX**  
wampfler  
DELACHAUX GROUP



incorporating Wampfler. Designing & manufacturing in Australia for over 40 years. Products include conductor bars, cable festoon systems, cable and hose reels, slip rings, Kabelschlepp energy chain, push button pendants, radio controls, flexible cable, industrial buffers, Kiepe conveyor monitoring equipment and UEE high voltage couplers.

## Conductix-Wampfler



Rheinstrasse 27 + 33  
Weil am Rhein  
79576

Germany

**Contact:**

T: + 49 7621 662 0

F: + 49 7621 662 144

E: info.de@conductix.com

W: www.conductix.com

Conductix-Wampfler is the world's leading supplier of energy supply and data transmission systems for moving machinery. All typical technologies for the transmission of energy and data are combined under one roof. Festoon systems, conductor rails, cable chains, spring cable reels, motorized cable reels, slip ring assemblies and contactless power transmission systems.

## Conductix-Wampfler Americas

10102 F Street

Omaha

Nebraska

NE 68127

USA

**Contact:** Mr Mark Zuroske

**Job Title:** Market Development

Manager, Americas

T: + 1 402 952 9325

F: + 1 402 339 9627

E: mark.zuroske@conductix.com

W: www.conductix.us

The leading global manufacturer of energy/data transfer systems for bulk material handling and mining equipment at mines, bulk terminals, and bulk storage facilities. Products include motorized cable reels, heavy duty festoon systems, conductor bars, spring reels, slip rings, radios and pendants.

## Conitex Sonoco

1302 INDUSTRIAL PIKE

GASTONIA

North Carolina

NC 28052

USA

**Contact:** Ms Michelle Saffit

**Job Title:** Marketing Manager

T: + 1 704 833 1367

F: + 1 704 865 7926

E: msaffit@conitex.com

W: www.conitex.com

## Conservatek Industries, Inc.

498 North Loop 336 East

Conroe

Texas

77301

USA

**Contact:** Ms Nita Bailey

**Job Title:** Marketing

T: + 1 936 539 1747

F: + 1 936 539 5355

E: nbailey@conservatek.com

W: www.conservatek.com

Conservatek engineers, fabricates and installs clear-span structural

aluminum framing systems to which we attach glass, aluminum panels, translucent systems and standard roofing products. All have unique design characteristics that maximize interior and exterior usage of space by eliminating secondary structural support systems. We offer complete installed systems that allow architects unmatched design flexibility while utilizing a low-density aluminum grid framework.

## Continental Construction (Memphis)

5646 Shelby Oaks Drive

Memphis

Tennessee

38134

USA

**Contact:** Mr Brian Morphis

**Job Title:** Marketing

T: + 1 901 382 4070

F: + 1 901 388 2534

E: mail@continentalconst.com

W: www.continentalconst.com

General Contractor specializing in Heavy Industrial construction. Marine construction, driven pile foundations, and slip form concrete construction are just a few of the services that we offer. We have an impressive array of projects throughout our 30 years of experience.

## Continental Conveyor & Equipment Co Inc

PO Box 400

438 Industrial Drive

Winfield

Alabama

35594

USA

**Contact:** Lou Boltik

**Job Title:** Director Marketing & Communications

T: + 1 205 487 6492

F: + 1 205 487 4233

E: info@continentalconveyor.com

W: www.continentalconveyor.com

The Continental High Angle Conveyor (HAC) employs standard conveyor components and belts to utilize a simple but unique 'sandwich belt' approach to elevating and lowering materials at any angle, up to and including 90 degrees (vertical). The HAC® system can be located on a ship or in a loading area.

## CONTINENTAL MATADOR RUBBER, s.r.o.

Terezie Vansovej 1054

Puchov

020 01

Slovakia

**Contact:** Mr Dusan Michalko

**Job Title:** Marketing Manager

T: + 421 42 461 3050

F: + 421 42 461 3365

E: dusan.michalko@matador.sk

W: www.matador.sk

Producer and supplier of textile and steel cord conveyor belts for the mining and construction industries. Innovative products include the shockbelt with carcass EPP, the firebelt - fireproof conveyor belt and the thermbelt with cover rubber 'T+' resistance of higher temperatures.

## ContiTech Transportbandsysteme GmbH

Breslauer Strasse 14

Norheim

D-37154

Germany

**Contact:**

T: + 49 5551 702 0

E: transportbandsysteme@

cbg.contitech.de

W: www.contitech.de/conveyorbelts

As a technology leader, we are the mining industry's development partner and original equipment supplier. Our conveyor belts around the world run reliably and economically, with respect for the environment. As systems supplier, we offer a full range of equipment and comprehensive service, from installation through to start-up.

## Control Systems Technology Pty Ltd

47 Fitzpatrick Street

Revesby

NSW

2212

Australia

**Contact:** Mr Leonard Ian Burrell

T: + 612 8708 0200

F: + 612 8708 0280

E: iburrell@controlsystems.com.au

W: www.controlsystems.com.au/Control Systems Technology Pty Ltd manufacture Trade Certified belt scales legal for trade use in Europe (0.25%), Canada (0.1% and 0.5%), Australia (0.25, 0.5 and 1.0%) and the USA (0.25%). Multi-idler belt scales with many innovations to allow accurate predictable weighing in very high belt tension areas. All applications engineered with an 'in conveyor' performance guarantee.

## Conveyor Dynamics, Inc.

3633 Alderwood Avenue

Bellingham

Washington

98225

USA

**Contact:** Mr Andrew Jennings

**Job Title:** President

T: + 1 360 671 2200

F: + 1 360 671 8450

E: cdi@conveyor-dynamics.com

W: http://conveyor-dynamics.com/ CDI designs the longest, strongest, and most advanced belt conveyor systems in the world. Last year we commissioned the world's longest belt conveyor: a 27km conveyor in South Africa. We specialize in detailed mechanical design, software development, and control system.

## Cornell & Co Inc

PO Box 807

Woodbury

New Jersey 08096

USA

**Contact:** Mr B O Donnell

**Job Title:** Equipment Sales

T: + 1 856 742 1900

F: + 1 856 742 8186

E: bodonnell@cornell-co.com

W: www.cornellcraneandsteel.com

## Cotecna Inspection SA

Calle 103 No.14A-43

Oficina 20

Edificio Gemedco

Santafe

Bogota

Colombia

**Contact:** Mr Alfredo Garcia

**Job Title:** VP Area manager

T: + 57 1 7427655

F: + 57 1 7550100

E: cotecna.colombia@cotecna.com.co

W: www.cotecna.com/

## Cotesi SA

Av. Mosteiro, 486

Grijó

4415-493

Portugal

**Contact:** Mr Kai Hakala

T: + 351 227 476 500

F: + 351 227 646 575

E: geral@cotesi.com

W: www.cotesi.com

## CPS Projects (Pty) Ltd

PO Box 47261

Greyville

Durban

KZN

4023

South Africa

**Contact:** Mr Banzi Majola

**Job Title:** Managing Director

T: + 27 31 466 4396

F: + 27 31 466 4399

E: banzi@cpsprojects.co.za

Distributor supplies and services ship loaders and unloaders, stackers/reclaimers and grabs.

## Cranes Machinery Co., Ltd(CMC)

CMI China Office

No.8-20 Shunyuan Road

Xinchen Industrial Park

Xuejia

Changzhou

Jiangsu

China

**Contact:** Mr Kaison XU

**Job Title:** Manager

T: + 86 519 8516 3887

F: + 86 519 8188 6887

E: info@craneschina.cn

W: www.craneschina.cn

## Crippen Manufacturing Company

400 Woodside Drive

St Louis

MI

48880

USA

**Contact:** Mr Darren Losey

**Job Title:** Manufacturing & Production

T: + 1 989 681 4323

F: + 1 989 681 3818

E: info@crippenmfg.com

## CSL Americas

1130 West Pender Street

Suite 1433

Vancouver

V6E 4A4

Canada

**Contact:** Mr Garth Mitcham

**Job Title:** Director, Marketing -

West Coast Ops

T: + 1 604 940 8020

F: + 1 604 235 1394

E: info@cslint.com

W: www.cslint.com

## CST Covers

498 N Loop 336 E

Conroe

Texas

77301

USA

**Contact:** Mrs Kimberly Mathis

**Job Title:** Global Marketing

Director

T: + 1 936 539 1747

F: + 1 936 539 5355

E: kmathis@cstindustries.com

W: www.cstcovers.com

Producers of corrosion-resistant aluminum dome storage facilities...over 8,000 domes have been completed in spans from 8m to over 135m world wide.

## CST Storage

903 E 104th Street, Suite 900

Kansas City

MO

64131

USA

**Contact:** Mr David Wheat

**Job Title:** Director

T: + 1 913 621 3700

F: + 1 913 621 2145

E: sales@cst-storage.com

W: www.cstindustries.com  
Leading manufacturer of bolted and factory welded silos for dry bulk storage. Each silo, large or small, is individually engineered for its application. Custom engineering enables the selection of drive-through skirts, speciality hoppers, spread legs, passive flow control devices, tanks on load cells, peripheral conveyor supports, internal blending and interior maintenance platforms.

## CTI Group Inc

Amman Regional Office

Shmaisani, Layla Al-Akhyalieh

Street

Adli Commercial Center, 5th Floor

P.O.BOX (7676)

Amman

11118

Jordan

**Contact:** Mr Nidal Mhiyar

**Job Title:** Senior Vice President

Commercial

T: + 962 6 5685 115

F: + 962 6 5676 939

E: nmhiyar@cti-grp.com

W: www.cti-grp.com

Established in 1990, our success has been achieved by hard work, professionalism, integrity, and long-term global partnerships. Current involvement includes:  
- Cement and Clinker Trading  
- Product Handling  
- Land and Sea Transportation  
- Terminal Construction and Operation (Shore or Floating)  
- Ship Owning and Ship Operating  
- Ship Management  
- Chartering

## CTP Team Srl

Via Provinciale, 25

Lallio

Bergamo

24040

Italy

**Contact:** Mr Roberto Binago

# DUST FREE LOADING

Leading the way  
with innovative  
dust free loading  
solutions for  
rail, ship, and  
barge loading of  
bulk materials at  
terminals and port  
facilities throughout  
the world.

**LOAD  
WITH THE  
LEADER**



DUST CONTROL AND LOADING SYSTEMS, INC.

**WWW.DCLINC.COM**

08660 ANCE RD • CHARLEVOIX, MI 49720  
PH: 231-547-5600







## Demag Cranes & Components GmbH



Benefit recipient: Gottwald Port Technology  
 Forststrasse 16  
 Düsseldorf  
 D-40597  
 Germany  
**Contact:** Mr Reiner Derhardt  
**Job Title:** Project Manager  
**T:** + 49 2335 92 7442  
**F:** + 49 2335 92 3812  
**E:** reiner.derhardt@demagcranes.com  
**W:** www.demagcranes-ag.com  
 Demag Cranes & Components GmbH - a subsidiary of Demag Cranes AG - is a supplier of industrial cranes and crane components for material flow, logistics and industrial drive applications. It also offers spare parts, maintenance and refurbishment services.  
 Represented globally by approx 5,000 employees in 22 foreign subsidiaries and agencies in 46 countries. With more than 650,000 Demag brand cranes and hoists for industrial applications in operation, the company has the largest installed base worldwide.

## DeMarco Industrial Vacuum Corporation

PO Box 1138  
 Crystal Lake  
 IL  
 60039-1138  
 USA  
**Contact:** Mr Thomas DeMarco  
**Job Title:** President  
**T:** + 1 815 344 2222  
**F:** + 1 815 344 2223  
**E:** Sales@DeMarcoVacuums.com  
**W:** www.DeMarcoVacuums.com  
 Manufacturers of MAX VAC industrial vacuuming and pneumatic conveying systems for the worldwide bulk handling industry. 5-300 hp.

## DemcoTECH Engineering

Modderhouse  
 Moddercrest Office Park  
 1 High Street  
 Modderfontein  
 Johannesburg  
 Gauteng  
 1645  
 South Africa  
**Contact:** Mr Paul van de Vyver  
**Job Title:** General Manager  
**T:** + 27 11 608 4355  
**F:** + 27 11 608 4251  
**E:** info@DemcoTECH.com  
**W:** www.DemcoTECH.com  
 Bulk materials handling and niche process plant specialist, DemcoTECH offers services from concept to completion to the power generation, cement, mining, metallurgical, manufacturing and port handling industries. Services include conceptual design, feasibility studies, design, engineering, procurement, expediting, construction and commissioning. Aftersales covers spares, maintenance, refurbishments and operational readiness packages.

bulk bags (FIBC), drums, and big boxes. Associated equipment such as bulk bag (FIBC) Unloaders, Drum Dumpers, Pallet dispensers, conveyors and turntable conveyors are integrated together in systems complete with PLC Controllers or as independent stand alone components.

## CWA Engineers Inc.

#380 - 2925 Virtual Way  
 Vancouver  
 BC  
 V5M 4X5  
 Canada  
**Contact:** Ms Nadine Clark  
**Job Title:** Marketing & Proposal Coordinator  
**T:** + 1 604 637 2275  
**F:** + 1 604 637 2276  
**E:** nadine.clark@cwaengineers.com  
**W:** www.cwaengineers.com  
 CWA Engineers provides innovative and practical engineering, procurement and construction management services to industry leading clients around the world. We provide a comprehensive suite of services for every phase of a project life cycle, from concept development through to commissioning and operations support. Core expertise: bulk materials handling.

## Cygnus Instruments Limited

Cygnus House  
 30 Prince of Wales Road  
 Dorchester  
 Dorset  
 DT1 1PW  
 UK  
**Contact:** Mr Graham Haines  
**Job Title:** Sales Director  
**T:** + 44 1305 265533  
**F:** + 44 1305 269960  
**E:** sales@cygnus-instruments.com  
**W:** www.cygnus-instruments.com/  
 Cygnus Instruments Ltd manufactures an ultrasonic hatch

cover leak detector, Cygnus Hatch Sure, for testing weather tightness of cargo hatch covers. The equipment provides a quick and effective method of evaluating hatch seals and aiding the prevention of sea water ingress.

## Dalian Huarui Heavy Industry International CO.,LTD

No 169 Bayi Road  
 Xigang District  
 Dalian  
 Liaoning  
 116013  
 China  
**Contact:** Mr Wang Chang  
**Job Title:** Project Manager  
**T:** + 86 411 86852821  
**F:** + 86 411 86852398  
**E:** wangchang@dhdicw.com  
**W:** www.dhdicw.com/dhdicw/english/index\_en.asp  
 DHHI is the holding subsidiary company of DHI-DCW Group Co., Ltd., as the national large and key leading enterprise in heavy industry, as well as key manufacturing enterprise of new energy equipment. Up to now DHHI has over 10,000 employees and a total asset of more than 18 billion RMB.

## Damen Shipyards Gorinchem

PO Box 1  
 Gorinchem  
 4200 AA  
 The Netherlands  
**Contact:**  
**T:** + 31 183 63 99 11  
**F:** + 31 183 63 21 89  
**E:** info@damen.com  
**W:** www.damen.nl  
 Damen is an international shipyard group but, at heart, we are still a family company. Whatever we do - whether it's in our building activities or our services - we always aim to match our customers' needs and

exceed their expectations.

## Dantherm Filtration Ltd

Limewood Approach  
 Seacroft  
 Leeds  
 LS14 1NG  
 UK  
**Contact:** Ms Karolina Szymanska  
**T:** + 44 113 2739 461  
**F:** + 44 113 265 0735  
**E:** kabo@danthermfiltration.com  
**W:** www.danthermfiltration.co.uk  
 Dantherm Filtration designs, manufactures installs and services dust and fume extraction equipment worldwide, with production centres throughout Europe, in USA, Thailand and China. Installations include extraction for dockside hoppers, ship unloaders, conveying storage and outloading facilities. Filters, cyclones, silos, fans, discharge devices. ISO9001:2008, ATEX EN13980:2002.

## DAWSON

7DE, Huaren Building  
 No. 2 Shandong Rd  
 Qingdao  
 China  
**Contact:** Ms Janet  
**T:** + 86 532 8666 0581  
**E:** info@dawson-group.com  
**W:** http://www.dawson-group.com

## DCL, Incorporated



08660 Ance Road  
 Charlevoix  
 MI  
 49720  
 USA  
**Contact:** Mr Kyle Smith  
**T:** + 1 231 547 5600 Ext 3124  
**F:** + 1 231 547 3343  
**E:** sales@dclinc.com  
**W:** www.dclinc.com  
 DCL provides full dust control loading systems as well as partial

components to the bulk material handling industry. Seasoned veterans in Technical Sales, Engineering and Manufacturing give DCL the capabilities of designing custom equipment to meet and understand all field applications. Product lines include Loading Spouts, Dust Collectors, Gates, Valves, and Air Conveyors.

## DCW Group Co

350 Zhong Nan Road  
 Zhongshan District  
 Dalian  
 116022  
 China  
**Contact:** Mr Lu Kaili  
**T:** + 86 411 289 3900  
**F:** + 86 411 289 1756  
**E:** info@dalian-gov.net  
 Manufactures specialist 'Deadfall Discharge' ship loading systems fitted with dust control equipment, plugged spout relief doors and no moving parts.

## De Regt Conveyor Systems

Ijzendijkseweg 5  
 Biervliet  
 Zeeland  
 4521 GX  
 The Netherlands  
**Contact:** Mr Peter De Regt  
**Job Title:** Director  
**T:** + 31 115 481238  
**F:** + 31 115 481234  
**E:** peter@deregt.com  
**W:** www.deregt.com  
 De Regt is a company specialized in developing, building and installing conveyor systems and structures needed to achieve a partial or total project.

## Den Bakker Dustcrusting Technology b.v. (dbd global b.v.)



Christiaan Huygensweg 2  
Hellevoetsluis  
Zuid Holland  
3225 LD  
The Netherlands  
**Contact:** Mr J.A.A. den Bakker  
**Job Title:** CEO  
**T:** + 31 181 399 632  
**E:** j.d.bakker@denbakker.nl  
**W:** www.dbdglobal.com  
Experts in dust control and prevention. As a contractor for some 30 years, the company has developed a number of solutions, including a range of specially designed water spraying vehicles, each having particular capacities and performances to suit the needs of a specific site or condition. The constant desire to improve led to the development of a very effective method to control dust: the Dustcruster® technology.

## Deutsche Großwärlager GmbH

Marieneher Strasse 17  
Rostock MV18069  
Germany  
**Contact:** Mr Andreas Wiedenhoft  
**Job Title:** Head of Sales  
**T:** + 49 381 4407 10 31  
**F:** + 49 381 4407 10 931  
**E:** info@dgwl.de  
**W:** www.dgwl.de

## Dinnissen BV

Horsterweg 66  
Sevenum  
NL-5975 NB  
The Netherlands  
**Contact:** Mr P Konings  
**T:** + 31 77 467 35 55  
**F:** + 31 77 467 37 85  
**E:** powtech@dinnissen.nl  
**W:** www.dinnissen.nl  
Specialising in bulk transfer equipment. Product range includes batch weigh systems for powders, big bag emptying stations, big bag filling lines, powder mixers.

## DMN-WESTINGHOUSE

Gieterij 3  
PO Box 6  
Noordwijkerhout  
Zuid-Holland  
NL-2210 AA  
The Netherlands  
**Contact:** Mrs Tonneke Krempel  
**Job Title:** Manager Marketing Services and PR  
**T:** + 31 252 361 800  
**F:** + 31 252 375 934  
**E:** dmn@dmn-nwh.nl  
**W:** www.dmnwestinghouse.com  
Design and manufacture of rotary valves, diverters and other components for the bulk solids handling industry. Besides an extensive range of standard versions, DMN-Westinghouse supply components that are pressure shock resistant to 10 bar, flame proof or ATEX compliant to Directive 94/9/EC.

## Dome Corp of North America

5450 East Street  
Saginaw  
Michigan  
48601  
USA  
**Contact:** Mr Ross Lake  
**Job Title:** President  
**T:** + 1 989 777 2050  
**F:** + 1 517 777 3477  
**E:** sales@dome-corp-na.com  
**W:** www.dome-corp-na.com

## Dome Technology, LLC

4946 North 29th East  
Idaho Falls  
ID  
83401  
USA  
**Contact:** Mr Jason Miller  
**Job Title:** Vice President of Marketing  
**T:** + 1 208 529 0833  
**F:** + 1 208 529 0854  
**E:** jason.miller@dometechnology.com  
**W:** www.dometechnology.com  
We design solutions and provide turnkey construction for bulk storage products, for both industrial and commercial applications. We design and construct reclaim tunnels, deep foundation and soil solutions, material handling systems and coordination with the owner's engineers and suppliers. Products commonly stored include wood pellets, fertilizer, cement, clinker, gypsum, fly ash, coal, sugar, grains and mining ores. Inventors of the insulated thin shell concrete dome.

## DOMTEC International LLC

4355 N Haroldsen Drive  
Idaho Falls  
Idaho  
83401  
USA  
**Contact:** Mr Mike Hunter  
**Job Title:** General Manager  
**T:** + 1 208 522 5520  
**F:** + 1 208 522 5344  
**E:** domtec@domtec.com  
**W:** www.domtec.com  
Design and constructs concrete domes to store a multitude of products. Projects are delivered on time and within budget. Broad experience with a variety of reclaim systems, both mechanical and pneumatic, depending on clients' needs.

## Don Valley Engineering Co Ltd

Sandall Stones Road  
Doncaster  
DN3 1QR  
UK  
**Contact:** Mr Roger Allen  
**Job Title:** Managing Director  
**T:** + 44 1302 881188  
**F:** + 44 1302 881000  
**E:** sales@donvalleyeng.com  
**W:** www.donvalleyeng.com  
Over 60 years of experience in all aspects of engineering, particularly the processing and handling of bulk materials, and the building of specialist screening, centrifuging and malting plant equipment. We are UK and global leaders in our fields, and a preferred supplier to all major producers and users of

minerals, iron and steel, coal, sugar, potash and more.

## Donaldson Filtration (GB) Ltd

Humberstone Lane  
Thurmaston  
Leicester  
LE4 8HP  
UK  
**Contact:** Mr Geoff Hodgson  
**Job Title:** Territory Manager  
**T:** + 44 116 269 6161  
**F:** + 44 116 269 3028  
**E:** IAF-uk@donaldson.com  
**W:** www.DonaldsonToritDCE.com  
Donaldson is a leading worldwide provider of filtration systems that improve people's lives, enhance our Customers' equipment performance, and protect our environment. We are a technology-driven company committed to satisfying our Customers' needs for filtration solutions through innovative research and development, application expertise, and global presence.

## Donaldson Filtration Deutschland GmbH

Industriestraße 11  
Dülmen  
48249  
Germany  
**Contact:** Mrs Susanne Fulko  
**Job Title:** Marketing Manager  
**T:** + 49 2594 781 0  
**F:** + 49 2594 781 21  
**E:** IAF-de@donaldson.com  
**W:** www.DonaldsonToritDCE.com  
Donaldson is a leading worldwide provider of filtration systems that

# DUST!

## The headache of each terminal operator!

### We have the solution:

# Dustcruster®!

For more details, contact:



den bakker dustcrusting technology b.v.  
Rijksstraatweg 167a  
3222 KD Hellevoetsluis  
The Netherlands  
**Phone:** +31 (0)181-399632  
**Fax:** +31 (0)181-399634  
**E-mail:** info@denbakker.nl  
**Contact:** J.A.A. den Bakker (CEO)  
**E-mail:** j.d.bakker@denbakker.nl  
**Mobile:** +316 51566863  
**Web:** www.dbdglobal.com

Partner:



Tunnellaan 117  
B-9060 Zelzate, Belgium  
**Phone:** +32 9 372 63 77  
**Fax:** +32 9 372 41 88  
**Contact:** Marc Verschaeve  
**E-mail:** marc@bpcinternational.be  
**Mobile:** +32 475 69 68 73  
**Web:** www.bpc-international.com





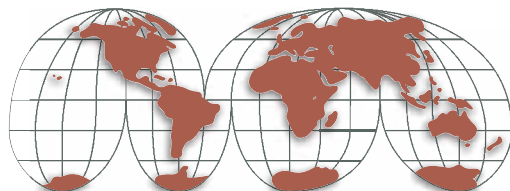

# DOS SANTOS INTERNATIONAL

+1 770 423 9895 | +1 833 DOS INTL

DosSantosIntl.com

SANDWICH BELT HIGH ANGLE CONVEYORS  
OVERLAND & HIGH CAPACITY CONVEYORS  
IN-HOUSE CONVEYOR ANALYSIS  
ENGINEERING CONSULTING

**THE GREATER  
THE LOAD  
THE HIGHER  
THE LIFT  
THE BETTER  
WE LOOK**

## **DSI SANDWICH BELT HIGH ANGLE CONVEYOR**

The DSI Sandwich Belt High Angle Conveyor is **PROVEN** in over 100 installations worldwide. It's **RELIABLE** for rugged mining conditions, yet gentle enough for friable materials. It's **ECONOMICAL**, fitting into tight spaces and small footprints. Elevating millions of tons of material at various installations all around the world, users have agreed it's the most reliable, low cost and low maintenance conveyor system available. **LET US PROVE IT TO YOU.**



improve people's lives, enhance our Customers' equipment performance, and protect our environment. We are committed to satisfying our Customers' needs for filtration solutions through innovative research and development, application expertise, and global presence.

## Doosan Benelux SA

Drève Richelle 167

Waterloo B-1410

Belgium

**Contact:** Ms Nancy De Sy

**Job Title:** Corporate and Public Communication Manager

**T:** + 32 2 371 6811

**F:** + 32 2 371 6900

**E:** nancy.desy@doosan.com

**W:** www.bobcat.eu;

www.doosanequipment.eu

Skid-steer loaders, compact tracked loaders; wheel loaders; excavators; rigid-frame and rotary telehandlers; attachments.

## Doppelmayr Transport Technology GmbH

Konrad-Doppelmayr-Str. 1

Wolfurt 6922

Austria

**Contact:**

**T:** + 43 5574 604 1800

**E:** dtt@doppelmayr.com

**W:** www.doppelmayr-mts.com

Doppelmayr Transport Technology solves all transport issues in the field of bulk materials and unit loads with a range of sophisticated material transport systems - from well-proven material ropeways to innovative long-distance conveyor systems for high capacities.



## Dos Santos International, LLC



531 Roselane Street

Suite 810

Marietta

GA

30060

USA

**Contact:** Mrs Amy D. Duncan

**Job Title:** Marketing Manager

**T:** + 1 770 423 9895

**F:** Text: + 1 916 US SNAKE

**E:** info@dossantosintl.com

**W:** www.dossantosintl.com

Materials handling and engineering specialists specialising in high-angle conveyors.

We offer the DSI Snake Sandwich conveyor, the most reliable and economical solution for your high-angle and vertical, high tonnage requirements.

Additionally we offer high-tech solutions. Our in-house proprietary software facilitates complete analysis of the most complicated conveying systems.

## Dosco Overseas Engineering Ltd

Ollerton Road

Tuxford

Newark

Nottinghamshire

NG22 0PQ

UK

**Contact:** Mr Phillip Adrych

**Job Title:** Export Sales

**T:** + 44 1777 870 621

**F:** + 44 1777 871 580

**E:** padrych@dosco.co.uk

**W:** www.dosco.co.uk

Manufacturers of an extensive range of pipe conveyors that transport materials in a totally

enclosed environment eliminating any spillage and contamination of the surrounding area. Also manufactured are high torque, slow speed, twin roll crushers, incorporating picks or manganese teeth.

## Dosetec Exact Oy

Vaakatie 37

Nastola

15560

Finland

**Contact:** Mr Pertti Hännikainen

**T:** + 358 3 871540

**F:** + 358 3 8715410

**E:** pertti.hannikainen@dosetec.fi

**W:** www.dosetec.fi

Dosing systems, sack filling and big bag FIBS filling system for food, chemical and building material industry.

## Doubrava Ges GmbH

Industriestrasse 17-20

Attnang-Puchheim

A-4600 Austria

**Contact:** Mr Stefan Wenninger

**Job Title:** Director sales/Sales Dry

Mortar Plants

**T:** + 43 7242 9022 759

**F:** + 43 7674 601499

**E:** office@doubrava.at

**W:** www.doubrava.at

Specialises in batching, weighing and mixing plants, classifying and dressing plants, plants for ready mixed plaster and concrete; mechanical conveyors and ship-to-shore conveying systems.

## Doyle Manufacturing Co

PO Box 3024

Quincy

Illinois

62305

USA

**Contact:** Mr Monty Doyle

**T:** + 1 217 222 1592

**F:** + 1 217 223 3655

**E:** doyle@doylemfg.com

## DSH SYSTEMS – WE CARE ABOUT YOUR AIR!

Solve the world-wide industrial material handling problem – dust fallout while transferring dry, granular goods.

At the loading point, the DSH System concentrates the discharge of dry goods as a solid column through free air into any target repository including trucks, rail wagons, storage containers, bags, ships, barges or stockpiles.

The DSH Dust Suppression System uses no utilities and has no internal moving parts.

Winner (joint) of the Inaugural Innovative Technology Award at BulkEx 2006.

Winner of the Dust Control Technology "Application or Practice" at BulkEx 2007.

The DSH System gives you:

- Cleaner, safer working environments
- Dust explosion risk mitigation
- Reduced maintenance, cleaning and dust handling
- Faster, continuous, cleaner loading of trucks and rail wagons
- Enables operation in closer proximity to urban areas
- Reduced product shrinkage.
- Reduced environmental agency concerns

Clients include companies handling fertilizers, grains, stock-foods, salt, sugar, sand, etc in Australasia, USA, Canada, South Africa, South America, and Europe (East and West).



ENQUIRIES

**DSH SYSTEMS LTD**

**E:** info@dshsystems.com

**T:** +64 9 828 8012

**W:** www.dshsystems.com



W: www.4doyle.com

## Draka Automotive GmbH

Dickestrasse 23  
Wuppertal  
42369  
Germany  
**Contact:** Mr Heribert Hoepfner  
**T:** + 49 20 22 96 0  
**F:** + 49 20 22 96 20 00  
**E:** automotive@draka.com  
**W:** www.draka-automotive.com

## DRC Engineering

Srednegavansky 9-31  
Saint-Petersburg  
199226  
Russia  
**Contact:** Mrs Mescherikova  
Nadezda  
**Job Title:** Director  
**T:** + 7 812 740 7426  
**F:** + 7 812 740 7429  
**E:** vyoukhnoe1@yahoo.com

## Dry Bulk Solutions

Moezel Weg 110  
Harbour 5596  
Europoort - Rotterdam  
Zuid-Holland  
3198 LS  
The Netherlands  
**Contact:** Mr Tom Vermeulen  
**T:** + 31 181 250 050  
**F:** + 31 181 261 466  
**E:** t.vermeulen@elivesto.com  
**W:** www.drybulksolutions.com  
Dry Bulk Solutions offer products such as steelwires with special grab operation developed end connections. Furthermore we supply the High Performance Unloader, a machine to ease the trimming of rafters and stairs. Main

benefit for our customers is cost reductions and safer work conditions!

## Dry-Bag A/S

Dalagarde 1  
Aarhus C  
DK 8000  
Denmark  
**Contact:** Mr Soren  
**Job Title:** Marketing  
**T:** + 45 86 19 0500  
**F:** + 45 86 19 0577  
**E:** production@dry-bag.dk  
**W:** www.desiccant.com

## DS SM a/s

Sonderjyllands Maskinfabrik  
Vaerksevej 5  
Roedekro  
6230  
Denmark  
**Contact:** Mr Martin N Nielsen  
**Job Title:** Project Manager  
**T:** + 45 74 39 33 33  
**F:** + 45 74 39 33 39  
**E:** mani@ds-sm.dk  
**W:** www.ds-sm.dk  
Manufactures conveyor plants for coal processing, including hoppers.

## DSG Consultants

Offices of the park - Bat.C  
Allée de Barcelone  
Perpignan  
Toulouges  
66350  
France  
**Contact:** Ms Sylvie Doutres  
**T:** +33 6 12 06 92 51  
**F:** + 33 4 68 21 77 86  
**E:** s.doutres@dsgconsultants.com  
**W:** www.dsgconsultants.com/

## DSH Systems Ltd.



PO Box 48052  
Blockhouse Bay  
Auckland  
Auckland  
0644  
New Zealand  
**Contact:** Mr Ian Walton  
**Job Title:** CEO  
**T:** + 64 275 999 592  
**F:** + 64 9828 8012  
**E:** ian@dshsystems.com  
**W:** www.dshsystems.com  
DSH Systems produce unique loading spouts for dry, granular, free-running goods. Dust is contained within a tight solid column through free air into any target repository. The DSH System requires no utilities, has no internal moving parts and provides Health & Safety, Environmental and commercial benefits.

## Dulevo International S.p.A.

Via Giovannino Guareschi 1  
Fontanellato  
Parma 43012  
Italy  
**Contact:** Mr Stefano Battistini  
**T:** + 39 0521 827733  
**E:** info@dulevo.com  
**W:** www.dulevo.com

## Dunlop Conveyor Belting

Oliemolenstraat 2  
PO Box 14  
Drachten

9200 AA  
The Netherlands  
**Contact:** Mr Andries Smilda  
**Job Title:** Sales & Marketing Director  
**T:** + 31 512 585 446  
**F:** + 31 512 585 433  
**E:** marketing.drachten@dunlopbc.com  
**W:** www.dunlopconveyorbelting.com  
Dunlop have both the largest range and biggest stock of textile and steelcord cargo handling belts. The range includes belts with outstanding qualities of heat, oil, cold, abrasion, tear and impact resistance as well as fire retardant belting. Unrivalled technical support, 24 hour helpline + 31 620 498831.

## DURO FELGUERA, S.A.

Parque Científico y Tecnológico de Gijón  
c/ Ada Byron, 90  
Gijón  
Asturias 33203  
Spain  
**Contact:** Mr Angel Pelegrý  
**Job Title:** Sales Director - DF Mining and Handling  
**T:** + 34 985 199 201  
**F:** + 34 985 199 059  
**E:** dfmh@durofelguera.com  
**W:** www.durofelguera.com  
A one hundred fifty year-old company specialised in turn-key projects worldwide for the bulk handling sector. Its great experience enables the company to develop state of the art designs and achieve high performance as well as run all the projects based on environmentally friendly solutions and competitive costs.

## Dust Solutions Inc

130 Bay Pines Road  
Beaufort  
South Carolina  
29906  
USA  
**Contact:** Mr Richard Posner  
**Job Title:** President  
**T:** + 1 843 846 3700  
**F:** + 1 843 846 3701  
**E:** sales@nodust.com  
**W:** www.nodust.com  
DSI manufactures Dry Fog Dust Suppression Systems for ship loaders/unloaders, conveyor transfer points, truck & rail dump/fill stations, feeders & crushers. Modular System, No Chemicals, No Product Wetting, No Freezing. Ideal for Coal, Coke, Copper & Iron Ore, Woodchips, Cement, Clinker. DustTamer™ Wind Fence Systems to protect storage piles/load points.

## E-Crane World Wide / E-Crane International USA



1332 Freese Works Place  
Galion  
Ohio 44833  
USA  
**Contact:** Mr Mark W Osborne  
**Job Title:** President  
**T:** + 1 419 468 0090  
**F:** + 1 419 468 0074  
**E:** mark.osborne@e-crane.com



## 327 | Tilting Top Lift Spreader



## One of our hard-working container spreaders

Dedicated Top Lift Spreader with tilting function for bulk material handling. Meet the rest of the team at [elme.com](http://elme.com)

W: [www.e-crane.com](http://www.e-crane.com)  
Hydraulic, balanced, bulk material handling cranes from 5.5 to 43 tons, 19 meters to 45 meters reach.  
ECI imports, markets and supports the E-Crane in the Americas. ECI offers complete material handling solutions including the E-Crane.

### E-Crane Worldwide



Koekoeklaan 53  
Adegem  
Oost Vlaanderen  
B-9991  
Belgium  
**Contact:** Mr Lieven Bauwens  
**Job Title:** Managing Director  
**T:** + 32 9378 0444  
**F:** + 32 9378 0645  
**E:** [lieven.bauwens@e-crane.com](mailto:lieven.bauwens@e-crane.com)  
**W:** [www.e-crane.com](http://www.e-crane.com)  
E-Crane® Worldwide provides design services as well as complete machine production, erection, support, and training with on-going service for the heavy equipment industry. E-Crane products excel in heavy bulk handling applications at ports around the world. E-Crane® is also the world leader for large scrap handling machines with an outreach from 24 to 50 meters.

### ECS Eurocargo Services AS

Tongavej 19  
Århus C, DK-8000  
Denmark  
**Contact:** Mr Peterson  
**T:** + 45 86 20 82 20  
**E:** [ecs@eurocargoservices.dk](mailto:ecs@eurocargoservices.dk)  
**W:** [www.eurocargoservices.dk](http://www.eurocargoservices.dk)

### EDGE INNOVATE. (NI) LTD

30 Farlough Road  
Newmills  
Dungannon  
County Tyrone BT71 4DT  
Northern Ireland  
**Contact:** Mr Lee Williamson  
**Job Title:** Sales Manager  
**T:** + 44 2887 740525  
**F:** + 44 2887 747244  
**E:** [info@edgeinnovate.com](mailto:info@edgeinnovate.com)  
**W:** <https://edgeinnovate.com/>  
Edge Innovate are a blue sky thinking, imaginative and creative equipment manufacturing company. With our ethos of "Innovation at Work" EDGE persist in pushing the boundaries of design and manufacturing to produce hard working, quality machinery to fit any materials handling requirement from recycling, material handling to quarrying.

### Egis Ports

Place des Freres Montgolfier  
Guyancourt 78286  
France  
**Contact:** Mr Pierre Aristaghes  
**T:** + 33 1 30 12 47 84  
**F:** + 33 1 30 12 10 95  
**E:** [Pierre.aristaghes@egis.fr](mailto:Pierre.aristaghes@egis.fr)  
**W:** [www.egis-international.fr](http://www.egis-international.fr)

### EIFFEL Etablissement SOMDEL

80 bis rue Jean Jaurès  
Quievrechain F-59920  
France  
**Contact:** Mr Gérard Pellez  
**Job Title:** (see ed notes)  
**T:** + 33 32 714 1516  
**F:** + 33 32 714 1515  
**E:** [contact.somdel.eiffel@eiffage.com](mailto:contact.somdel.eiffel@eiffage.com)  
**W:** [www.eiffel.fr](http://www.eiffel.fr)  
Specialised in the provision of tailor made lifting and handling equipment. The range of products extends from EOT for steel

plants, nuclear power plants and gantry cranes to ship loaders, ship unloaders, stackers and reclaimers, conveying systems and turnkey installations.

### Elecon Engineering Co Ltd

Post Box # 6, Anand Sojitra Road  
Vallabh Vidyanagar  
Gujarat 388 120  
India  
**Contact:** Mr Paresh Vyas  
**Job Title:** Corporate Communications  
**T:** + 91 2692 237016  
**F:** + 91 2692 236457  
**E:** [info@gear@elecon.com](mailto:info@gear@elecon.com)  
**W:** [www.elecon.com](http://www.elecon.com)

Elecon since established in 1951, apart from Power Transmission Products, provides engineered solutions, manufactures and supplies Bulk Material Handling Plants, Stockyard Equipment, Wagon tippers, Ship loaders, specialized conveyors and Pipe Conveyor for the core sector industries which include power, steel, cement, fertilizer, port mechanisation and open cast mines in India and abroad.  
Additional equipment: bagging machines, magnetic separators, metal detectors.

### Elecon Singapore PTE Ltd

10, Anson Road #24-03  
International Plaza  
Singapore 079903  
Singapore  
**Contact:** Mr Vipul Shah  
**Job Title:** Manager Sales and Services  
**T:** + 65 6227 4694  
**F:** + 65 6227 8942  
**E:** [vipul@singapore.elecon.com](mailto:vipul@singapore.elecon.com)  
**W:** [www.elecon.com](http://www.elecon.com)

### Electro-Motive Diesel (EMD) Inc

9301 West 55th Street  
La Grange, IL 60525  
USA  
**Contact:** Mr Scott Garmin  
**T:** + 1 708 387 3938  
**F:** + 1 708 387 6626  
**E:** [frank.w.ward@EMDiesels.com](mailto:frank.w.ward@EMDiesels.com)

### Elgin Engineering and Construction

2001 Butterfield Road  
Downers Grove  
Chicago  
Illinois 60515  
USA  
**Contact:** Mr Bob Williams  
**Job Title:** Marketing Director  
**T:** + 1 630 434 7200  
**F:** + 1 630 434 7272  
**E:** [soros@elginindustries.com](mailto:soros@elginindustries.com)  
**W:** [www.elginindustries.com](http://www.elginindustries.com)  
Designs, rehabilitates and upgrades port and harbour facilities, bulk and general cargo handling systems and equipment.

### ELME Spreader AB



Stålgatan 6  
Ålmhult  
SE-34334  
**Contact:** Mr Niklas Lefèvre  
**Job Title:** Sales & Marketing Manager  
**T:** + 46 476 55 800  
**E:** [niklas.lefevre@elme.com](mailto:niklas.lefevre@elme.com)  
**W:** [www.elme.com](http://www.elme.com)  
As the world's leading independent spreader manufacturer, ELME Spreader supports companies worldwide with container handling solutions. Over a period of four decades, our customers have attached over 16,000 ELME spreaders to their lift trucks, reach



**E-HANDLER®**  
by E-CRANE



"The E-Crane system has **cut our unloading time in half**, cut our maintenance time dramatically, and just **generally simplified our lives** and **reduced our costs** substantially".

*Tom Noble, Department Supervisor, Powersouth Energy*

See Why it ALWAYS  
has been  
@ E-CRANE.COM!



- 1 SHORT DELIVERY TIME**  
Lead time as fast as 3-4 months ex-works
- 2 132 Kw ELECTRICAL MOTOR**  
Save money with low energy costs
- 3 VERSATILITY**  
Free Standing, Crawlers, Floating, Rail

**"WHITE** is the New **Green"**





CUSTOM-DESIGNED  
**BULK MATERIAL  
HANDLING SYSTEMS**

*Perfectly fitted solutions, engineered to meet your needs.*

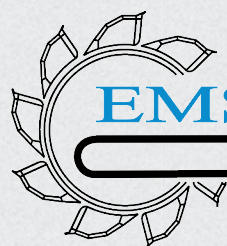

**EMS-TECH INC.®**

mobile equipment and bulk  
material handling systems



*Specializing in the design and supply of*  
• Self-Unloading Systems • Shiploaders • Transshippers • Stackers • Reclaimers And Bulk Conveyor Systems

[WWW.EMS-TECH.NET](http://WWW.EMS-TECH.NET)



stackers, straddle carriers and cranes.

## Emaq-Verolme Estaleiros

Rua Quatis 426  
426 liha do Governador  
Rio de Janeiro  
RJ 21920  
Brazil

**Contact:** Mr I Fonseca  
**Job Title:** Sales Dept  
**T:** + 55 21 392 8029  
**F:** + 55 21 396 4126

## EMDE INDUSTRIE-TECHNIK

PO Box 1339 Koppelheck  
Nassau-Lahn 56377  
Germany

**Contact:** Mr Hansjürg Emde  
**Job Title:** Managing Director  
**T:** + 49 2604 97030  
**F:** + 49 2604 970333  
**E:** info@emde.de  
**W:** www.emde.de

Produces a wide range of material handling systems, including control systems, process automation equipment and FIBC emptying and filling equipment.

## EMS-Tech Inc



699 Dundas Street West  
Belleville  
Ontario  
K8N 4Z2  
Canada

**Contact:** Ms Gail Carl  
**Job Title:** Executive Assistant,  
Sales & Marketing  
**T:** + 1 613 966 6611  
**F:** + 1 613 966 6710  
**E:** sales@ems-tech.net

**W:** www.ems-tech.net  
A multi-task, multi-discipline company specialising in design and supply of dry bulk material handling equipment, both mobile and stationary; including custom designed conveyors; belt elevators; receiving hoppers; storage/loadout systems; environmental controls; shiploaders; stackers and reclaimers; transhippers, self-unloading ships.

## EMS-Tech Inc.



Vlaardingstraat 3  
Ijmuiden  
1976 AS

The Netherlands  
**Contact:** Mr Luke Huitema  
**Job Title:** Manager, International  
Sales

**T:** + 31 251 291 340  
**F:** + 31 251 291 344  
**E:** europe@ems-tech.net  
**W:** www.ems-tech.net

A multi-task, multi-discipline company specializing in design and supply of dry bulk material handling equipment, both mobile and stationary; including conveyors, belt elevators, receiving hoppers, storage/loadout systems, environmental controls, shiploaders, stackers and reclaimers, self-unloading ships.

## EMTICI Engineering Co Ltd

68 Sarat Bose Road

Calcutta  
West Bengal  
700025

India  
**Contact:** Mr D Sen  
**T:** + 91 33 24761861  
**F:** + 91 33 24761831  
**E:** dsen@calemtici.elecon.com  
**W:** www.elecon.com

## Enco Engineering Inc

4410 13th Street  
Wyandotte  
MI  
48192

**Contact:** Ms Bobbi Lang  
**T:** + 1 734 407 2400 x 202  
**F:** + 1 734 676 3436  
**E:** enco@encoeng.com  
**W:** www.encoeng.com  
Specialises in the custom design of material handling systems to fit the unique characteristics of bulk material handling application. Experienced staff and engineering are dedicated in helping to meet the demands of an increasingly competitive world market.

## Endress + Hauser Inc

2350 Endress Place  
Greenwood  
IN  
46143

USA  
**Contact:** Mr Victor Wolowec  
**T:** + 1 317 535 1410  
**F:** + 1 317 353 1481  
**E:** info@us.endress.com  
**W:** www.us.endress.com  
Offers process control devices and measurement systems for industrial applications including level, flow, pressure, tank gauging, temperature and liquid analysis.

## Engicon nv

Broelstraat 20  
Harelbeke  
B-8530  
Belgium

**Contact:** Mr Pieter Van Acker  
**Job Title:** Sales & Marketing  
Director  
**T:** + 32 56 73 21 21  
**F:** + 32 56 73 40 40  
**E:** sales@geldof.be

**W:** www.geldof.be  
Offers complete solutions in bulk handling systems. Product range includes silos with extraction systems, discharge hoppers, pressure vessels and storage tanks, conveyor belts, screw conveyors, chain conveyors, bucket elevators.

## Engineering System Solutions

4943 North 29th East, Suite A  
Idaho Falls  
ID 83401  
USA

**Contact:** Mr Jason South  
**T:** + 1 208 552 9874  
**F:** + 1 208 552 9302  
**E:** jason@es2eng.com

## Enso-Gutzeit Oy

Logistic Services  
PO Box 62-63  
Kotka  
48101  
Finland

**Contact:** Mr. Alexandre Nicolini  
**Job Title:** Senior VP Sales and  
Marketing  
**T:** + 358 2046 112  
**F:** + 358 2046 254 87  
**E:** vesa.sarkkinen@storaenso.com

**W:** www.storaenso.com/

## Entecon UK Ltd

8 Lawrence Way  
Camberley  
Surrey  
GU15 3DL  
UK

**Contact:** Mr Kees Wilschut  
**Job Title:** Managing Director  
**T:** + 44 1276 414 540  
**F:** + 44 1276 414 541  
**E:** entecon@entecon.co.uk  
**W:** www.entecon.co.uk

## Enviro Abrasion Resistant Engineers Pvt. Ltd

"ENVIRO HOUSE", Sector-27  
Plot No. F/12  
Near Sambhaji Chowk  
Pradhikaran  
Pune  
411044

India  
**Contact:** Mr Milind Dixit  
**T:** + 91 20 27641757  
**F:** + 91 20 27650316  
**E:** info@enviroabrasion.com  
**W:** www.enviro-abrasion.com

## EPN Solutions

Karl Grankvist 1C  
Piteå  
SE-941 52  
Sweden

**Contact:** Mr Mattias Öman  
**Job Title:** Managing Director  
**T:** + 46 70 371 15 30  
**E:** mattias.oman@epnsolutions.se  
**W:** http://epnsolutions.se/

## EQ Trade

Rijsdijk Equipment Trade BV  
Droogdweg  
Waalhaven Oostzijde 119  
Rotterdam  
BM  
3087  
The Netherlands

**Contact:** Mr Kees Keetels  
**T:** + 31 62182 36 79  
**F:** + 31 10 487 3477  
**E:** keetels@eq-trade.com

## EQUIPO LLC

Salahudeen Road  
Dubai  
64624  
UAE

**Contact:** Mr Mohamad Yasar  
Aboobackar  
**Job Title:** Operations & Sales  
Manager  
**T:** + 971 4 268 2216  
**F:** + 971 426 822 17  
**E:** sales@equipo.ae  
**W:** http://www.equipollc.com/

## Eriez Europe

Bedwas House Industrial Estate  
Bedwas  
Caerphilly  
CF83 8YG  
UK

**Contact:** Ms Gareth Meese  
**Job Title:** Marketing Executive  
**T:** + 44 29 20 868 501  
**F:** + 44 29 20 851 314  
**E:** Gareth.Meese@eriezeurope.co.uk  
**W:** www.eriez.com  
Magnetic separators (dry and wet process) for separation and recovery of ferrous and non-ferrous metals, metal detectors (underbelt and aperture types as well as vertical feed/pipeline systems), automatic samplers for dry bulk materials and slurries, vibratory feeders for light bulk and heavy

duty applications.

## Esch Group bv

Veerweg 14  
Hoom  
5145 NS  
The Netherlands

**Contact:** Mr Rob ver Doren  
**Job Title:** Managing Director  
**T:** + 31 229 282 940  
**F:** + 31 229 233 177  
**E:** info@eschgroup.nl  
**W:** www.stas-nl.com

Stas is a manufacturer (production) of transport rollers, drive and tension drums and import bearings and bearing blocks.

## ESI Eurosil BV

Newtonstraat 26-28  
Purmerend  
1446 VR  
The Netherlands

**Contact:** Mr Richard Spaargaren  
**Job Title:** Commercial Director  
**T:** + 31 299 630 730  
**F:** + 31 299 630 737  
**E:** esi@eurosil.com  
**W:** www.eurosil.com

The Eurosil is a well proven enclosed storage system, available for storing large quantities of bulk solids up to 100,000 cubic meter per unit. Both free-flowing and non-free flowing products can be stored like: coal, FGD-gypsum, limestone, fertilizer, minerals and agri-bulk like potato starch.

## Essar Industries

15/B, Manjushree, 1st Floor, 2nd Floor  
Sri MVC Hanumanthaiah Road  
Nrupathunga Extension  
R.T. Nagar  
Bengaluru  
Karnataka  
560032  
India

**Contact:** Mr A.M Sherif  
**Job Title:** CEO  
**T:** + 91 844 7531774  
**E:** essarinds@gmail.com  
**W:** www.essarmaterialhandling.com/

## Euromec Srl

Via Visano 78/80  
Isorella  
25010  
Italy

**Contact:** Mr Ricardo Segala  
**Job Title:** Sales and Marketing  
**T:** + 39 030 9958 151  
**F:** + 39 030 995 2223  
**E:** sales@euromecsr.it  
**W:** www.euromecsr.com

EUROMECC, born from the merger of companies Eurohydromec and Isomec, has years of experience in the material handling field and the production of products such as lifting equipment, electrohydraulic and mechanical grabs and buckets.

## Euro-tech Corporation

195 23rd. Street  
Pittsburgh  
PA  
15215  
USA

**Contact:** Mr Richard W. Theobald  
**T:** + 1 412 782 0600  
**F:** + 1 412 782 6200  
**E:** sales@eurotechcorporation.com  
**W:** www.eurotechcorporation.com

## Euro-Tramco BV

Spacelab 47 D  
Amersfoort  
3824MR  
The Netherlands

**Contact:** Mr Hans Plekkenpol  
**T:** + 31 33 4567033  
**F:** + 31 33 4568149  
**E:** hans@tramco-europe.com  
**W:** www.tramcoinc.com  
Manufactures chain, screw and bucket conveyors and 'Aerobelt' air-supported belt conveyor systems.

## EXP.Com

40, Rue Ste-Cecile  
Salaberry-de-Valleyfield  
Quebec  
J6T 1L7  
Canada

**Contact:** Mr François Giguère  
**Job Title:** Project Manager  
**T:** + 1 450 371 5722  
**F:** + 1 450 371 6955  
**E:** f.giguere@lbcid.org  
**W:** www.teknika-hba.com  
Multi-disciplinary engineering consultants with emphasis on potable and waste water treatment and material handling.

## F E Schulte Strathaus GmbH & Co KG

Runtstrasse 42  
Weri  
D-59457  
Germany

**Contact:** Mr Andre Hanke  
**T:** + 49 2922 9775 0  
**F:** + 49 2922 9775 75  
**E:** ha@schulte-strathaus.de  
**W:** www.schulte-strathaus.de

## F L Smidth A/S

Vigerslev Alle 77  
Valby DK-2500  
Denmark

**Contact:** Mrs Camilla Travis  
**T:** + 45 3618 1000  
**F:** + 45 3645 4427  
**E:** ctr@flsmidth.com  
**W:** www.flsmidth.com

FLSmidth offers a portfolio of products and solutions to handle any type of bulk materials. Our full range of materials handling products includes complete crusher installations and silos, stackers/reclaimers and ship unloaders.

We supply process design and equipment for all materials handling applications for the cement industry and related industries.

## Fairport Engineering

Market Place  
Adlington  
Lancashire PR7 2QP  
UK

**Contact:** Mrs Linda White  
**Job Title:** Communications  
Manager  
**T:** + 44 1257 484000  
**F:** + 44 1257 483312  
**E:** info@fairport.co.uk  
**W:** www.fairport.co.uk

Produces a wide range of vibratory screw and belt conveyors for the food, coal and other industries.

## FAM Canada Inc

1750, 444 - 5th Ave  
Calgary  
Alberta  
T2P 2T8  
Canada

**Contact:** Mr Heiko Schiemann  
**T:** + 1 403 764 0777  
**F:** + 1 403 775 4043  
**E:** info@famcanada.com  
**W:** www.fam.de/

Solutions and equipment for bulk material handling and mineral processing.



One Source

# Is your terminal operating at peak performance?

Peak efficiency results from routine optimization audits, best maintenance practices, highly skilled operators and process equipment upgrades.

FLSmidth's terminal specialists are experienced, trained, and prepared to perform a complete **System Optimization Audit** to evaluate any pneumatic conveying system at your terminal. A personalized system audit will include a complete mechanical, electrical and process evaluation of your equipment's current condition.

Furthermore, we will provide you:

- Observations and recommendations for best maintenance practices and unloading logistics.
- Suggestions for possible upgrades to ensure your unloader is operating at the most efficient level possible

Call +1 610 554 7548 for more information, or to schedule your system audit.  
Or visit us on the web: [www.flsmith.com](http://www.flsmith.com)

**FLSMIDTH**



## FAM Magdeburger Förderanlagen und Baumaschinen GmbH

Sudenburger Wuhne 47  
Magdeburg D-39112  
Germany  
**Contact:** Mr Michael Kutzka  
**Job Title:** Director, Sales & Marketing  
**T:** + 49 391 6380 10 1 03  
**F:** + 49 391 6380 10 1 99  
**E:** sales@fam.de  
**W:** www.fam.de

FAM Förderanlagen Magdeburg is an independent company with the head office in Germany, with a long tradition as a manufacturer of materials handling systems and mineral processing.

## Famak SA

Machinery and Equipment Company  
Fabryczna Street 5  
Kluczbork  
PL 46-200  
Poland  
**Contact:** Mr Wojciech Staszak  
**Job Title:** President and CEO  
**T:** + 48 77 40 70 100  
**F:** + 48 77 418 15 45  
**E:** famak@famak.com.pl  
**W:** www.famak.pl  
Manufacturer of grabs & hooks cranes, stackers & reclaimers, portal scraper loaders and belt conveyors systems.

## Fantuzzi Reggiane S.p.a

Via Cisa Ligure 51/A  
Lentigione di Brescello (RE)  
42040  
Italy  
**Contact:** Mrs Rosanna Gennari  
**Job Title:** Marketing  
**T:** + 39 0522 5881  
**F:** + 39 0522 588243  
**E:** rgennari@fantuzzi.com  
**W:** www.fantuzzi.com  
Manufactures a wide range of port loading and unloading equipment, including mobile harbour cranes with maximum lifting capacities of up to 100 tonnes.

## FELD Maschinen-und Industriebau GmbH

Winkelfeld 3  
Oer-Erkenschwick  
D-45739  
Germany  
**Contact:** Mr André Stueckradt  
**Job Title:** Accounts & Purchasing  
**T:** + 49 2368 98890  
**F:** + 49 2368 9889 27  
**E:** andre.stueckradt@maschinenbau-feld.de  
**W:** www.maschinenbau-feld.de

## FEMADIGIPACK S.r.l

Via San Giovanni Bosco, 60  
Bergamo  
24126  
Italy  
**Contact:** Mr Tiengo Giorgio  
**Job Title:** General Manager  
**T:** + 39 036 391 0453  
**F:** + 39 036 390 2466  
**E:** commerciale@femadigipack.it  
**W:** www.femagroup.net  
Packing machines for cement and other materials in powder.

## Fenner Dunlop Conveyor Belting Europe

Marfleet  
Hull  
Yorkshire  
HU9 5RA  
UK  
**Contact:** Mr Jim Jones  
**T:** + 44 1482 785450  
**F:** + 44 1482 785438  
**E:** jim.jones@fennerdunlop.com  
**W:** www.fennerdunlop.com

## Fenner plc

Hesslewood Country Office Park  
Hessle  
East Yorks  
HU13 0PW  
UK  
**Contact:** Ms. Michelle Madden  
**Job Title:** Studio Manager  
**T:** + 44 1482 626 500 / 523  
**F:** + 44 1482 626522  
**E:** eprismuk@fenner.com  
**W:** www.fennerdunlop.com/

## FFE Ltd

9 Hunting Gate  
Hitchin  
Hertfordshire  
SG4 0TJ  
UK  
**Contact:** Mr Mark Wood  
**Job Title:** Business Development Manager  
**T:** + 44 1462 444 740  
**F:** + 44 1462 444 789  
**E:** sales@ffeuk.com  
**W:** http://www.ffeuk.com/

## Fige Crane Services BV

PO Box 235  
Zaandam 1500 EE  
The Netherlands  
**Contact:** Mrs Babette Sloven  
**T:** + 31 75 6810 410  
**F:** + 31 75 6315 996  
**E:** b.slovan@kenz-figee.com  
**W:** www.kenz-figee.com  
Merger of Kenz offshore cranes and Fige harbour cranes.  
Founded in 1836, Fige designs and manufactures a complete range of bulk handling cranes including the unique and well proven Lemniscate floating grab cranes with capacities from 16-50t, gantry grab unloaders, single- and double boom cranes, kangaroo cranes.

## Flexco

2525 Wisconsin Avenue  
Downers Grove  
IL  
60515-4200  
USA  
**Contact:** Ms Kelly Clancy  
**Job Title:** Public Relations Specialist  
**T:** + 1 630 971 0150  
**F:** + 1 630 971 1180  
**E:** kclancy@flexco.com  
**W:** www.flexco.com  
Flexco provides the world's belt conveyors with products, services, and solutions for splicing, belt cleaning, belt tracking, spillage, and slippage. It is based in the U.S. with subsidiaries in Australia, Chile, China, England, Germany, India, Mexico, Singapore, and South

Africa. Flexco distributes products under the Flexco®, Mineline®, and Tasman Warajay™ Technology names.

## Flexco Europe GmbH

Leidringer Strasse 40-42  
Rosenfeld  
D-72348  
Germany  
**Contact:** Mr Joerg Schairer  
**Job Title:** Managing Director  
**T:** + 49 7428 94060  
**F:** + 49 7428 9406260  
**E:** europe@flexco.com  
**W:** www.flexco.com  
Mechanical belt fastening systems, installation tools, maintenance tools, ceramic lagging, belt cleaners, belt trainers, impact beds and skirting systems.

## Flexicon Corporation

2400 Emrick Blvd  
Bethlehem  
PA  
18020-8006  
USA  
**Contact:**  
**T:** + 1 610 814 2400  
**F:** + 1 610 814 6000  
**E:** sales@flexicon.com  
**W:** http://www.flexicon.co.uk/

## Flexicon Europe Ltd

182 John Wilson Business Park  
Harvey Drive  
Whitstable  
Kent  
CT5 3RB  
UK  
**Contact:**  
**T:** + 441227 374710  
**E:** sales@flexicon.co.uk  
**W:** www.flexicon.co.uk

## Flexoveyor Conveyor

3795 Paris St., Unit D  
Denver  
Colorado  
80239  
USA  
**Contact:** Mr Bill Priday  
**T:** + 1 303 375 0200  
**F:** + 1 303 373 5149  
**E:** billpriday@flexoveyor.com

**W:** www.flexoveyor.com

## Flomat Bagfilla International Limited

Fairport House  
28 Charles Street  
Higher Hillgate  
Stockport  
Cheshire  
SK1 3JR  
UK  
**Contact:** Mr Jeremy Booth  
**Job Title:** Sales Director  
**T:** + 44 161 477 4775  
**F:** + 44 161 474 0257  
**E:** jbooth@fpeggroup.co.uk  
**W:** www.fpeglobal.com  
As part of the FPE Global Group of Companies including Aeromaster (Aero-mechanical conveying specialists), NEU Solutions (Pneumatic conveying experts), Process Equipment and Site Operations, we can offer a variety of materials handling solutions.

## Flowrox Oy

Marssitie 1  
PO Box 138  
Lappeenranta  
FIN-53101  
Finland  
**Contact:** Ms Helena Byckling  
**Job Title:** Marketing Manager  
**T:** + 358 201 113 311  
**F:** + 358 201 113 300  
**E:** info@flowrox.com  
**W:** www.flowrox.com  
Producer of flow control solutions including pinch and knife gate valves and peristaltic and PC-pumps. We focus on abrasive, corrosive and other demanding shut-off, control and pumping applications serving different process industries worldwide, including mining, chemical, pulp and paper.

## FLSmidth GmbH

Alfred Leiner Strasse 3  
Lanzendorf  
A-2326  
Austria  
**Contact:** Mr Patrick Schwarz  
**T:** + 49 6834 470 175  
**F:** + 43 2235 47568  
**E:** patrick.schwarz@flsmidth.com  
**W:** www.flsmidth.com  
Leading Pipe Conveyor Technology - More than 200 Pipe Conveyor installations worldwide.

## FLSmidth Inc.

  
2040 Avenue C  
Bethlehem  
PA  
18017-2188  
USA  
**Contact:** Mr David Bergenstock  
**Job Title:** Sales Manager  
**T:** + 1 610 264 6988  
**F:** + 1 610 264 6307  
**E:** david.bergenstock@flsmidth.com  
**W:** www.flsmidth.com  
FLSmidth specializes in terminal equipment for dry bulk products, primarily cement. In addition to ship and barge unloading/loading equipment we also specialize in pneumatic reclaim and transfer systems for storage silos and domes.



## FLSmith Minerals Pvt. Ltd

FLSmith House  
34 Egatoor  
Kelambakkam  
Old Mahabalipuram Road  
Chennai  
Tamil Nadu  
603 103  
India  
**Contact:** Mr Sivalingam  
Santhakumar  
**Job Title:** Library  
**T:** + 91 44 47484795  
**F:** + 91 44 27470301  
**E:** [indiainfo@flsmith.com](mailto:indiainfo@flsmith.com)  
**W:** [www.flsmith.com](http://www.flsmith.com)

## FLSmith Wadgassen GmbH

Karl-Koch-Strasse 1  
Wadgassen  
Saarland  
66787  
Germany  
**Contact:** Mr Matthias Schmidt  
**Job Title:** Sales Director EMENA  
**T:** + 49 6834 470 0  
**F:** + 49 6834 470 339  
**E:** [wadgassen@flsmith.com](mailto:wadgassen@flsmith.com)  
**W:** [www.flsmith.com](http://www.flsmith.com)  
FLSmith designs, manufactures, and services a broad range of materials handling equipment and systems for various industries, from minerals and cement to pulp and paper. Products include stacker/reclaimer systems, bulk material and bag loading and unloading systems for barges and ships, conveying solutions, including KOCH Pipe Conveyor®, and complete materials handling facilities.

## FMC Corporation

PO Box 1370  
1 Link Belt Drive  
Tupelo  
MS 38802  
USA  
**Contact:** Mr Randy Webb  
**T:** + 1 507 243 3185  
**F:** + 1 601 869 7402  
**W:** [www.fmc.com](http://www.fmc.com)

## Fortum Power and Heat OY

PO Box 1  
Fortum  
00048  
Finland  
**Contact:** Ms Jonn Paakkonen  
**Job Title:** Marketing Manager  
**T:** + 358 10 4511  
**F:** + 358 10 45 24447  
**E:** [communications@fortum.com](mailto:communications@fortum.com)

## FPS Mustang

Filtermech Plant Sales Ltd  
Unit 6-2  
Seckar Wood Industrial Park  
Barnsley Road, Newmillerdam  
Wakefield  
WF2 6QW  
UK  
**Contact:** Mr Mick Maxfield  
**T:** + 44 1924 252252  
**F:** + 44 1924 252565  
**E:** [mick@filtermech.com](mailto:mick@filtermech.com)  
**W:** [www.filtermech.com](http://www.filtermech.com)  
Importers and distributors for Mustang Skid Steer Loaders and attachments for the UK and Ireland. Mustang Skid Steer Loaders are manufactured to industrial specifications and are ideal for use in arduous applications such as ship trimming and stevedore work.



# The complete range of bulk solid mechanical handling technologies

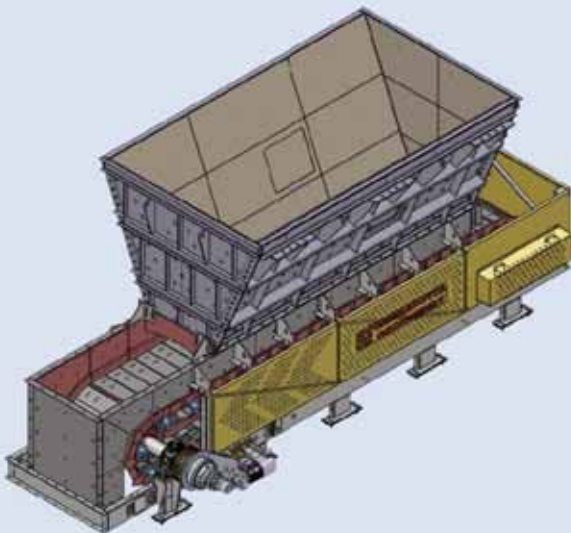

### EP/EPP – APRON FEEDERS

Heavy duty apron feeders designed to convey and extract blocks, crusher feeding

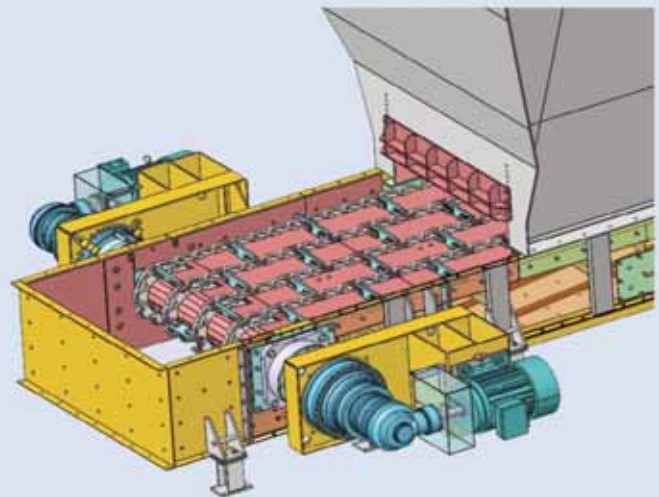

### EM – ARMOURD CHAIN CONVEYORS

Armoured drag chain conveyors designed to extract bulk materials from hoppers





## Franz Wölfer Elektromaschinenfabrik Osnabrück GmbH

Industriestraße 14  
Osnabrück  
49082  
Germany  
**Contact:** Mr Ulrich T. Beholz  
**Job Title:** Vice President Sales  
**T:** + 49 541 9902233  
**F:** + 49 541 9902222  
**E:** u.t.beholz@woelfer-motoren.com  
**W:** www.woelfer-motoren.com  
Our company Franz Wölfer Elektromaschinenfabrik GmbH is a medium sized family owned company. We develop and manufacture for more than 70 years customized low-voltage-three-phase-squirrel-cage-motors for inverter operation up to 2300kW. In the HQ in Osnabrueck over 130 employees ensure highest quality standards and fulfill each technically reasonable customer requirement.

## Freudenberg Technical Supply (Sin) Pte Ltd

1 Sunview Road  
#06-31 Eco-Tech Sunview  
Singapore  
627615  
Singapore  
**Contact:** Mr Raymond Ng  
**Job Title:** Managing Director  
**T:** + 65 67104919  
**F:** + 65 67104917  
**E:** r@freudenberg-cranes.sg  
**W:** www.freudenberg-cranes.de  
Offering OEM or replacement parts from Europe, provide crane service and maintenance, hydraulic components and gearboxes

overhauling.

## Frigate Technologies Private Limited

Gr. Floor, No. 9,  
Block 5, Eros Garden  
Charmwood Village  
Surajkund Road  
Faridabad  
Haryana  
121 001  
India  
**Contact:** Mr Ajay Hooda  
**Job Title:** Director (Marketing)  
**T:** + 91 129 4116470  
**F:** + 91 11 66173981  
**E:** office@frigate.in  
**W:** www.frigate.in  
Frigate Technologies is a diversified global conglomerate providing integrated Design, Engineering, Procurement, Construction & Project Management Services in Aviation, Cement, Energy, Marine, Mineral Processing, Steel and other associated downstream sectors.

## Gama Endustri Tesisleri Imalat Ve Montaj AS

Narcissus Street No: 9, 06 520  
Söğütözü  
Ankara  
06540  
Turkey  
**Contact:** Mr Mehmet Artun  
**Job Title:** General Manager  
**T:** + 90 312 248 42 00  
**F:** + 90 312 4094360  
**E:** industry@gama.com.tr  
**W:** www.gama.com.tr

## Gambarotta Gschwendt



Viale Verona 200  
Trento  
38123  
Italy  
**Contact:** Mr. Fabrizio Gambarotta  
**Job Title:** CEO  
**T:** + 39 0461 920403  
**F:** + 39 0461 933391  
**E:** gambarotta@gambarotta.it  
**W:** www.gambarotta.it  
Designer and Manufacturer of Bucket Elevators, Apron Feeders, Truck Discharge Feeders, Stockpilers Reclaim Feeders, Steel Pan Conveyors, Chain Conveyors, Screw Conveyors, Bulk Unloader Chutes applicable for Cement, Coal, Mineral, Petrochemical and Power Plants Industries.

## Gantrex Inc.

6000 Town Center Blvd., Suite 240  
Canonsburg  
PA  
PA 15317  
USA  
**Contact:** Mr Tom Berringer  
**Job Title:** Business Development Manager  
**T:** + 1 412 655 1400  
**F:** + 1 412 655 3814  
**E:** sales@gantrex.com  
**W:** www.gantrex.com/  
Gantrex provides solutions for rail mounted material handling systems including crane rail, rail clips and hydraulic bumpers. Call Toll Free at 1-800-242-6873 or visit [www.Gantrex.com](http://www.Gantrex.com).

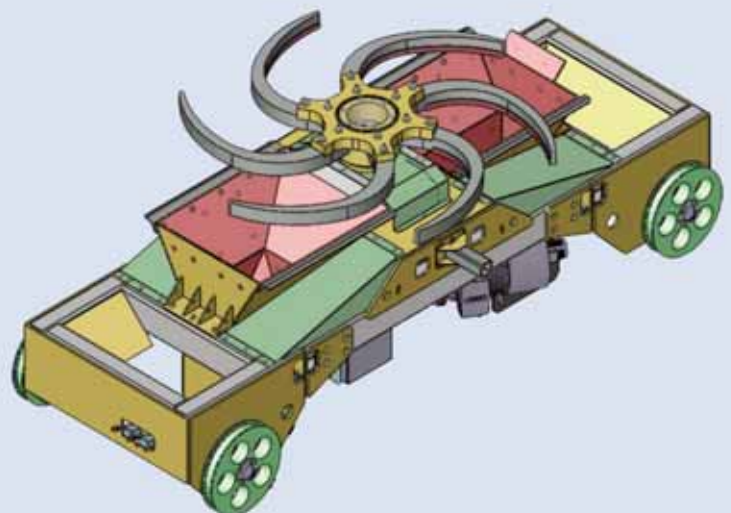
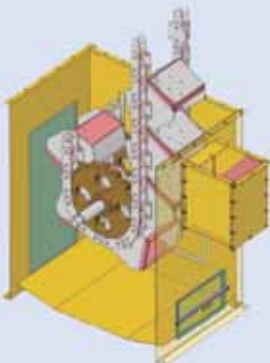
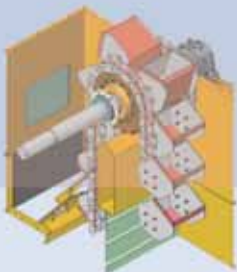

SINCE 1919  **GAMBAROTTA**  
S.R.L. G.M.B.H.  
**GSCHWENDT** 

38123 TRENTO, ITALY - Viale Verona, 200  
Tel. +39 0461 920403 - Fax +39 0461 933391  
[www.gambarotta.it](http://www.gambarotta.it) - [gambarotta@gambarotta.it](mailto:gambarotta@gambarotta.it)

ESPLV - BUCKET ELEVATOR with double lateral chains (for large capacity)

EF Rotary discharge extractor

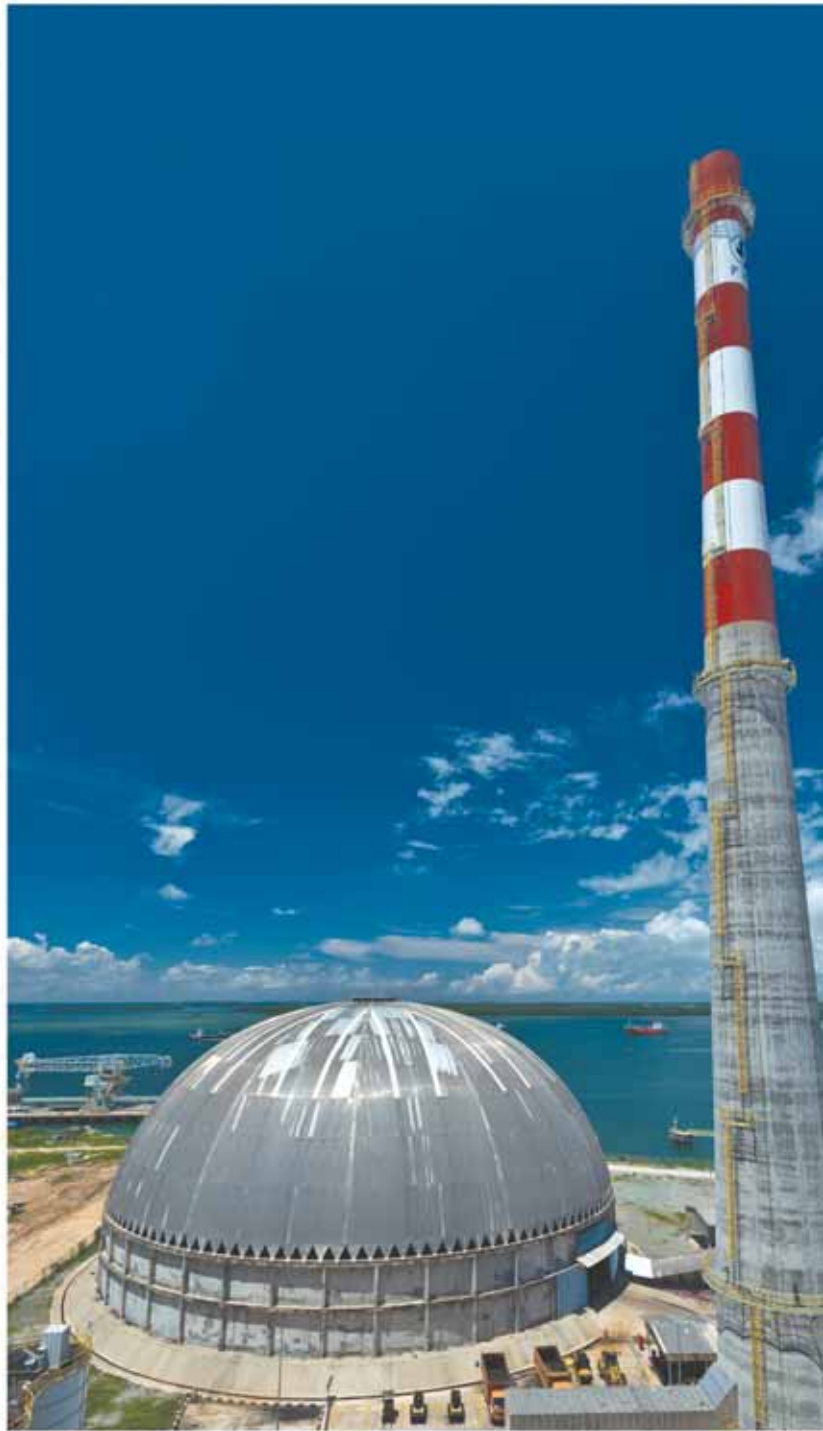

## DEFEAT DUST WITH A DOME.

Tread softly around Mother Nature. If your stockpile produces dust, tame it with a freestyle dome or barrel vault. Whether quayside or on a mountain, protect the surrounding environment while preserving your own stockpile from erosion and loss of fines. We'll build right over your live operations and eliminate downtime. Corrosive saltwater? No problem. Typhoon-force winds? No worries. Torturous snow loads? Never fear, we've got you covered. Build a Geometrica dome for your raw materials and the dust is history.

 **Geometrica**<sup>®</sup>

[www.geometrica.com/bulk-storage](http://www.geometrica.com/bulk-storage)



## Ganz Danubius Trading Co Ltd

PO Box 1138  
Budapest  
H1325  
Hungary  
**Contact:** Mr Karol Bayus  
**Job Title:** Director  
**T:** + 36 1 350 5570  
**F:** + 36 1 329 8041  
**E:** gdtco@hu.inter.net  
**W:** www.ganztrading.hu  
Manufactures  
shiploaders/unloaders, mechanical  
level luffing slewing harbour portal  
cranes 16-50 tonnes capacity,  
floating cranes 16-150 tonnes  
capacity, barges, river-seagoing  
vessels, steel construction for  
special shiploaders and unloaders,  
stackers/reclaimers, cranes.

## Garwood Consulting Ltd

Garwood Lodge  
Wentworth  
Ely  
Cambridgeshire  
CB6 3QG  
UK  
**Contact:** Mr Barry Woodbine

**T:** + 44 780 102 4583  
**F:** + 44 1353 777315  
**E:** barry@garwoodconsulting.com

## Gearbulk Maritima Ltda

Rua Luaro Muller ,116  
Grupo 3302  
Botafogo  
Rio De Janeiro  
22290-160  
Brazil  
**Contact:** Mr Daniel DeChiaro  
**Job Title:** General Manager  
**T:** +55-21-2586-3400  
**F:** +55-21-2543-4508  
**E:** rio@gearbulk.com  
**W:** http://www.gearbulk.com

## General Bridge Engineering Ltd

PO Box 110  
Peterborough  
PE2 7ZZ  
UK  
**Contact:** Mr Jack Wild  
**T:** + 44 1733 231207  
**F:** + 44 1733 231207  
**E:** paulsteed@btconnect.com  
An engineering design consultancy  
for the materials handling, recycling

and quarry industries. The chief  
activities are the design of bulk port  
handling and storage plus individual  
items designed for the quarry and  
recycling installations.

## General Kinematics Corp.

5050 Rickert Rd.  
Crystal Lake  
IL  
60014  
USA  
**Contact:** Mr Gordon Frank  
**Job Title:** VP Sales & Marketing  
**T:** + 1 815 455 3222  
**F:** + 1 815 455 2285  
**E:** info@generalkinematics.com  
**W:** www.generalkinematics.com  
General Kinematics specializes in  
vibrating and rotary equipment and  
solutions for bulk processing of  
material in the foundry, recycling,  
scrap, mining, minerals, food,  
chemical, and wood industries.  
Each piece of GK equipment is  
custom engineered to your  
specifications to meet your process  
objectives.

## Geo - Chem Laboratories Pvt. Ltd

Geo - Chem House  
294 Shahid Bhagat Singh Road,  
Fort  
Mumbai  
400 001  
India  
**Contact:** Mr Subhashis  
Chakraborty  
**Job Title:** Head of Marketing  
**T:** + 91 22 663 83838  
**F:** + 91 22 663 83800  
**E:** s.chakraborty@geochem.net.in  
**W:** www.geochem.net.in  
Geo-Chem Laboratories is an  
international independent  
inspection and testing company.  
We provide services in inspection,  
testing and product certification,  
insurance surveys, engineering  
inspection, collateral management  
services, weight/packing/quality  
control and samplers.  
We specialise in the following  
commodities; agricultural produce,  
processed foods, vegetable oils  
and derivatives, animal feedstuffs,  
chemicals, metals & minerals, coal  
& coke, petroleum &  
petrochemicals, pharmaceuticals

and bulk drugs.

## Geometrica Inc

  
12300 Dundee Court  
Suite 200  
Cypress  
Texas  
77429  
USA  
**Contact:** Mr Cecilio Zalba  
**Job Title:** Sales Manager  
**T:** + 1 832 220 1200  
**F:** + 1 832 220 1201  
**E:** sales@geometrica.com  
**W:** www.geometrica.com  
Specializes in design, manufacture  
and installation of long span bulk  
storage enclosures. Structures can  
be designed in circular, elliptical,  
longitudinal and free style  
configurations that can span up to  
300m, with no intermediate  
supports. Galvanized steel and/or  
aluminum structures that are easy  
to install, lightweight, strong and  
maintenance free, with low  
fabrication and installation costs.

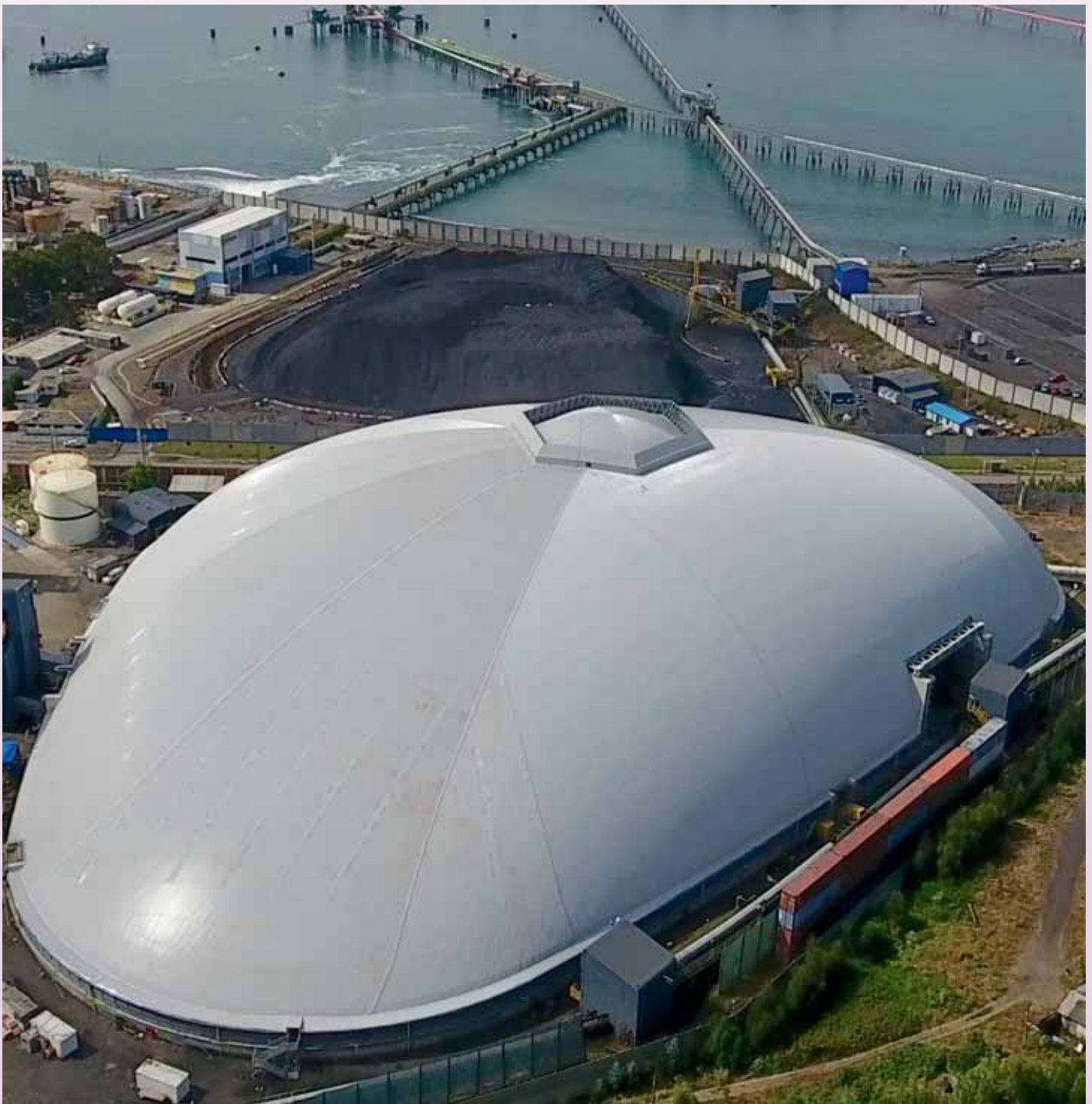



# DESIGNED, ENGINEERED AND BUILT WITH 90 YEARS OF EXPERIENCE AND EVOLUTION

Golfetto Sangati is an Italian company designing, building and installing turnkey equipment for grain handling and milling. This strong industrial reality is born from the merger of three historic Italian brands: Golfetto, Sangati and Berga. The company fulfills the market demand in a competitive way and with state-of-the-art technologies based on research, experience and in-depth technical knowledge.

Golfetto Sangati is a reference point for the design and construction of complete port systems for loading and unloading ships. The company designed and built more than 50 port systems all over the world and plays a primary role in technological advancement from the first pneumatic ship unloader to the more advanced mechanical loaders and unloaders.

The company supplies a large range of handling, processing and storage, loading and unloading systems on tires or rail with a capacity of 50 to 2,000 tons per hour implementing the best technical principles.

**GOLFETTO SANGATI**  
A COMPANY OF PAVAN GROUP

[www.golfettosangati.com](http://www.golfettosangati.com) - [info@golfettosangati.com](mailto:info@golfettosangati.com)





## Geroldinger GmbH & Co KG

Au-Strasse 9  
Sigharting  
A-4771  
Austria

**Contact:** Mr Walter Geroldinger

**Job Title:** CEO

**T:** + 43 7766 24370

**F:** + 43 7766 243724

**E:** office@geroldinger.com

**W:** www.geroldinger.com

Specialises in design and installation of bulk handling systems and processes, including hoppers and storage silos.

## Gertech Handling Systems cc

PO Box 4014  
Durbanville  
Cape Town  
Western Cape  
7551  
South Africa

**Contact:** Mr Gerrit De Hoog

**T:** + 27 21 914 5333

**F:** + 27 21 914 5666

**E:** gerrit@gertech.co.za

**W:** www.gertech.co.za

Design and manufacturing of handling and storage systems for bulk handling of dry materials. Steel Silos, mechanical conveyors and pneumatic conveying.

## Getriebbau NORD GmbH & Co. KG

Getriebbau-Nord-Str. 1  
Bargteheide  
22941

Germany

**Contact:** Mr Joerg Niermann

**Job Title:** Marketing Director  
**T:** + 49 4532 2890  
**F:** + 49 4532 289 2253  
**E:** joerg.niemann@nord.com  
**W:** www.derantrieb.com/

## GF MHS Srl

Via Guido Rossa, 11  
Paderno Dugnano (MI)  
Milan  
20037  
Italy

**Contact:** Mr Francesco Tummlio

**Job Title:** Managing Director

**T:** + 39 0 2 91 08 20 02

**F:** + 39 0 2 91 84 31 47

**E:** info@gfmhs.it

**W:** www.gfmhs.it

.....we are your starting point of your project.

## GGT Goldengrain Trading SA

Via Capelli 28  
Lugano  
6900

Switzerland

**Contact:** Ms Cornelia Riep

**Job Title:** Manager

**T:** + 41 91 971 40 20

**F:** + 41 91 971 40 21

**E:** cgriep@ggt.ch

## Gibbons Engineering Group Ltd

Woodroffe Road  
Tollesbury  
Maldon  
Essex  
CM9 8RY  
UK

**Contact:** Mr Matthew Gibbons

**Job Title:** Sales Engineer

**T:** + 44 1621 868 138  
**F:** + 44 1621 868 188  
**E:** matthew.gibbons@gibbonsgroup.co.uk  
**W:** http://www.gibbonsgroup.co.uk/

## Golden West Industries

332 West Railroad Ave  
Price  
UT  
84501  
USA

**Contact:** Mr Ellis Pierce

**Job Title:** Advertising

**T:** + 1 435 637 3211

**F:** + 1 435 637 6628

**E:** pwynny@gbis.com

**W:** www.goldenwest-industries.com

Golden West Industries provides dust suppression and freeze control products to the mining and material handling industries.

## Golfetto Sangati s.r.l.



Via Fratelli Bandiera, 3  
Quinto di Treviso (TV)  
31055  
Italy

**Contact:** Mr Pietro Barbujani

**Job Title:** Handling Product Manager

**T:** + 39 0422 476 700

**E:** barbujani.p@golfettosangati.com

**W:** www.golfettosangati.com

Designs, constructs and installs complete grain terminals for ship loading and unloading. The range of grain terminals covers any possible technology: fixed or mobile, on rails or tyres, for loading and unloading or the combined type in the same structure. Two types of

unloaders are produced - pneumatic and mechanical. Special designed unloaders for no-free flowing commodities.

## Goodman Conveyor Company

U.S. Route 178 South  
PO Box 866  
Belton  
South Carolina 29627  
USA

**Contact:** Mr Carter Matthews

**Job Title:** VP Sales & Marketing

**T:** + 1 864 338 7793 x 102

**F:** + 1 864 338 8732

**E:** info@goodmanconveyor.com

**W:** www.goodmanconveyor.com

Recognised as a leading designer and manufacturer of high quality bulk conveyor equipment, components and structures, including screw conveyors, multi-flow round bottom drag conveyors and flat bottom en-masse drag conveyors.

## Goodtech AS

Bjoernslettveien 2  
Porsgrunn  
N-3917  
Norway

**Contact:** Mr Knut Halvorsen

**Job Title:** Senior Sales Manager

**T:** + 47 35 93 05 50

**F:** + 47 35 93 05 60

**E:** knut.halvorsen@goodtech.no

**W:** www.portabulk.com or

www.goodtech.no

The company provides specialised technology for filling, handling, storing, tracing and distributing packaged bulk products for customers throughout the world. We supply purpose-designed and

cost-effective systems, materials, equipment and software.

## Gordinne & Co NV/SA

Belgian Ports Operation  
Leegstraat 1  
Zelzate  
B-9060  
Belgium

**Contact:** Mr Patrick Bosschaert

**Job Title:** Operation Manager

**T:** + 32 3 328 05 49

**F:** + 32 3 328 16 54

**E:** patrick.bosschaert@

stewartgroupglobal.com

**W:** www.gordinne.be

Based in Belgium, the Netherlands and Venezuela. Established in 1947 and specialises in the controlling, sampling and analysing of solid bulk commodities (coal, coak and petroleum coke, ores and minerals), the draft survey of ships and the topographic surveys of stockpiled materials. An ISO 9002 certified company.

## Gottwald Port Technology USA

Demag Cranes and Components Corp  
3502 Riga Blvd., Suite C  
Tampa  
Florida  
FL 33619  
USA

**Contact:** Mr Bob Histon

**Job Title:** General Manager, North America

**T:** + 1 813 490 0990 ext 19

**F:** + 1 813 490 0994

**E:** bob.histon@gottwald-us.com

**W:** www.gottwald-us.com

## GraviLoad Limited

Easter Shian  
Glen Quaich  
Amulree  
Perthshire  
PH8 0DB  
UK

**Contact:** Mr Malcolm Gresty  
**Job Title:** International Sales Director  
**T:** + 44 7817 573 144  
**E:** malcolm@graviload.com  
**W:** www.graviload.com

## GREIF-VELOX

Kronsfordter Landstraße 177  
Lübeck  
D-23560  
Germany  
**Contact:** Mr D. M. Wassenberg  
**T:** + 49 451 5303 0  
**F:** + 49 451 5303 233  
**E:** dm.wassenberg@greif-velox.de  
**W:** www.greif-velox.de  
Manufactures special FIBC filling and discharge equipment that allows FIBCs to be transported in interchange racks and unloaded in controlled doses into a production process.

## Greystones Cargo Systems (Pty) Ltd

PO Box 41314  
Rossburgh  
Durban  
4072  
South Africa  
**Contact:** Ms Linda Smit  
**T:** + 27 31 274 2600  
**E:** lindas@greystonescargo.co.za  
**W:** www.greystones.co.za

## Gubre Fabrikalari TAS

Kasap Sokak No 22  
Esentepe  
Istanbul  
34394  
Turkey  
**Contact:** Mr M Kürsat Akin  
**Job Title:** Trade Manager  
**T:** + 90 212 3765050  
**F:** + 90 212 2741201  
**E:** kakin@gubretas.com.tr  
**W:** www.gubretas.com.tr  
Producer of NP,NPK and importer fertilizer .

## Gulsan A.p.

Organize Sanayi Bolgesi 2 Cad.  
No: 18  
Gaziantep  
27180  
Turkey  
**Contact:** Ms Gülden Saka  
**Job Title:** Marketing Manager  
**T:** + 90 342 337 1180  
**F:** + 90 342 337 2528  
**E:** info@gulsan-group.com  
**W:** www.gulsan-group.com

## Guttridge Limited

Wardentree Park  
Pinchbeck  
Spalding  
Lincolnshire  
PE11 3UU  
UK  
**Contact:** Mr Doug Anderson  
**Job Title:** Sales and Marketing Manager  
**T:** + 44 1775 765300  
**F:** + 44 1775 765304  
**E:** sales@guttridge.co.uk  
**W:** www.guttridge.co.uk  
Manufactures a range of bulk

conveying and elevating equipment, as well as storage facilities.

## Guven Grab and Machine Ltd. Co

Nazim Hikmet Cad 536. sk. No: 9  
Aske Köyü  
Cayirova  
Kocaeli  
41420  
Turkey  
**Contact:** Mr Engin Demir  
**Job Title:** Sales & Export Manager  
**T:** + 90 262 743 8858  
**F:** + 90 262 743 1141  
**E:** info@guvengrab.com  
**W:** www.guvengrab.com  
Established in 1984, Guven Grab & Machine (Guven Kepce Makine) has its own manufacturing facilities. Its product range includes radio remote control grabs, electro hydraulic clamshell/orange peel grabs, mechanical clamshell orange peel touch down grabs and mechanical double wired grabs. It has supplied its units to countries around the world.

## H J Wiefierink BV

PO Box 335  
Oldenzaal  
7570 AH  
The Netherlands  
**Contact:**  
**Job Title:** Advertising  
**T:** + 31 5415 71616  
**F:** + 31 5415 12499  
**E:** info@wiefierink.nl  
**W:** www.wiefierink.nl

## H Noorman BV

Breedstraat 2  
Vreeland  
3633 AX  
The Netherlands  
**Contact:** Mr H Noorman  
**T:** + 31 294 236161  
**F:** + 31 294 232181  
**E:** info@hnoorman.com

## Halcrow

Burderop Park  
Swindon  
Wiltshire  
SN4 0QD  
UK  
**Contact:** Mr Daniel Cross  
**Job Title:** Ports Design Engineer  
**T:** + 44 1793 812 479  
**F:** + 44 1793 812 089  
**E:** crossd@halcrow.com  
**W:** www.halcrow.com

## Hangzhou Huaxin Mechanical & Electrical Engineering Co., Ltd.

No. 2 Xiyuan Road  
Xihu Science and Technology  
Economic  
Garden  
Sandun  
Hangzhou  
310030  
China  
**Contact:** Ms Sandy  
**T:** + 86 571 8131 5353  
**F:** + 86 571 8542 5353  
**E:** sales@ship-unloader.com  
**W:** http://www.ship-unloader.com

## Hans Turck GmbH & Co.

**KG**  
Witzlebenstraße 7  
Mülheim an der Ruhr  
D-45472  
Germany  
**Contact:** Mr Klaus Albers  
**Job Title:** PR Manager  
**T:** + 49 208 495249  
**F:** + 49 160 93950359  
**E:** klaus.albers@turck.com  
**W:** www.turck.com

## Hansen Industrial Transmissions (HIT) nv

Leonardo da Vincilaan 1  
Edegem  
Antwerp  
2650  
Belgium  
**Contact:** Ms Lena De Wachter  
**Job Title:** Marketing Communications Manager  
**T:** + 32 345 01200 / + 32 345 01306  
**F:** + 32 345 01220  
**E:** info@hansenindustrialgearboxes.com  
**W:** www.hansenindustrialgearboxes.com  
HIT is part of Sumitomo Drive Technologies & offers single -, multi stage-, planetary-, application specific etc. gear units and geared motors. Operating successfully in thousands of diverse industrial installations worldwide, the gearboxes are available in many configurations and drive packages. Gearbox refurbishment (all brands)24/7, 365 days a year. Full design, spares and on-site service facilities available. Hotline: +32 3

# HAPMAN

Ideas that move.

## MORE THAN EQUIPMENT

THE KNOWLEDGE TO SOLVE YOUR TOUGHEST MATERIAL HANDLING CHALLENGES

We've designed innovative ways to move more than 2,600 distinct materials in 10,000 installations worldwide.



READY TO GET SERIOUS?



450 1234

## Hanson Silo Company

11587 County Rd  
8 SE  
Lake Lillian  
MN  
56253  
USA

**Contact:** Mr Mike Hanson  
**Job Title:** Director of Business Development

**T:** + 1 800 843 7456

**E:** hscinfo@hansonsilo.com

**W:** www.hansonsilo.com

Manufacturers of modular precast concrete containment walls 5-16' high. Engineered for storage loads up to 100 lbs/ft<sup>3</sup>.

## Hapman



5944 East N Avenue  
Kalamazoo  
MI  
49048  
USA

**Contact:** Mr Keith Rouse  
**Job Title:** Marketing Director  
**T:** + 1 269 343 1675  
**F:** + 1 269 349 2477

**E:** k.rouse@hapman.com

**W:** www.hapman.com

Produces bulk material handling conveyors, bulk bag handling equipment and systems for the handling of materials for the chemical, food, minerals and related industries.

## Hasel Machinery Inc

Cumhuriyet Mh. Nr 15 E5 Karayolu  
Uzeri

Yakacik Kartal

Istanbul

81100

Turkey

**Contact:** Mr Osman Nuri Mete

**Job Title:** Manager

**T:** + 90 216 452 9787

**F:** + 90 216 452 9790

**E:** osman.mete@hasel.com

**W:** www.hasel.com

## Haskoning India Pvt Ltd

13th Floor, Maithili's Signet

Plot - 39/4, Sector 30A

Vashi

Navi Mumbai

400 705

India

**Contact:** Mr Hareld van den Brink

**Job Title:** Director of Business -

India

**T:** + 91 22 4161 5004

**E:** hareld.van.den.brink@rhdvhv.com

**W:** www.royalhaskoningdhv.com

## HASLER GROUP SAS

Z.I. De l'Abbaye

46 rue Louis Bréguet

Pont-Evêque

38780

France

**Contact:** Mr Michel Jamey

**Job Title:** CAO

**T:** + 33 474 161151

**F:** + 33 474 161155

**E:** sales.fr@hasler-gp.com

**W:** www.hasler-gp.com

## Haugen System AB

Fersens väg 12

Malmö

211 42

Sweden

**Contact:** Mr Malik Minhaj

**Job Title:** Marketing Manager

**T:** +46 40 30 64 00

**F:** +46 40 30 63 30

**E:** malik.minhaj@haugensystem.com

**W:** www.haugensystem.com

**SPILLAGE MANAGEMENT:**

Spillage in your plant means:

- Loss of valuable raw material and finished products.
  - Internal and external environmental problems.
  - Increased maintenance cost.
  - Lower production efficiency.
- Heavy duty vacuum loaders and stationary vacuum systems can recover spillage, clean your plant and create a better environment.

## Haver & Boecker OHG, Wire Weaving Division

Ennigerloher Strasse 64

Oelde

59302

Germany

**Contact:** Mr N Alberternst

**T:** + 49 2522 300

**F:** + 49 2522 30404

**E:** dw@haverboecker.com

**W:** www.weavingideas.com

Haver & Boecker produce woven wire cloth and process it into engineered woven wire products.

They are used as customised solutions in a large range of applications. Rolls, pieces, strips, discs, filters and fabricated parts, screen sections, test sieves, test sieve shakers, and photo-optical particle analyser.

## Haver & Boecker OHG, Machinery Division

PO Box 3320/ Carl-Haver-Platz 3

Oelde

59282/ 59302

Germany

**Contact:** Mr Christian Reinke

**Job Title:** Manager Sales Support

**T:** + 49 2522 30 120

**F:** + 49 2522 30 627

**E:** c.reinke@haverboecker.com

**W:** www.haverboecker.com

**Haver & Boecker product**

range: Packing plants for bulk products in valve bags and open-mouth bags for semi-automatic or fully automatic operation.

Capacities 100-5,500 bags/hour, weight range 5-2,000 kg, Form-Fill-Seal bagging systems, big bag weighers and container weighers, complete silo and bag loading plants as well as screening plants for dry and wet products.

## Haver Niagara GmbH

Robert-Bosch-Straße 6

Munster

48153

Germany

**Contact:** Mr Peter Grotjohann

**T:** + 49 251 116

**F:** + 49 251 156

**E:** p.grotjohann@haverniagara.com

**W:** www.haverniagara.com

Haver NIAGARA is renowned for innovative mineral processing technology and provides solutions and service for the mining, building materials and industrial mineral industries worldwide.

The core disciplines are screening, washing, pelletizing and plant engineering.

From single equipment to processing plants - engineering, design and manufacturing - made in Germany.

## Hebei Xinrong Rubber Products Co., Ltd

Beijing International Marketing Dept

21st Floor,

Wanda Plaza

Shijingshan District,

Beijing

100043

China

**Contact:** Ms Roxy Yang

**Job Title:** Sales Manager

**T:** + 86 10 886 96 189

**F:** + 86 10 88 696 185

**W:** www.bjxinrongrubber.com

## Heinrich Schacke gmbh & co kg

Hölscherstr. 6a,

Duisburg

D-47167

Germany

**Contact:** Mrs Schwacke

**Job Title:** + 49 90 0140 5123 ??

**T:** + 49 203 995 290

**F:** + 49 203 586 058

**E:** info@schacke.de

**W:** www.schwacke.de

## HEKO Ketten GmbH

Eisenbahnstrasse 2

Wickede (Ruhr)

D-58739

Germany

**Contact:**

**T:** + 49 23 779 1800

**F:** + 49 23 77 1028

**E:** info@heko.com

**W:** http://www.heko.com

## Henry International Diplomatic Marine

27502 Vilna Avenue

Santa Clarita

CA

91351

USA

**Contact:** Mr Jim Hill

**Job Title:** International Sales

Manager

**T:** + 1 713 676 2400

**F:** + 1 713 673 5805

**E:** jhill@henry.com

**W:** www.henry.com

Products include:





*Cement silo from IBAU HAMBURG, installed at Cementa AB's facility at Norra Hamnen terminal in Malmö, Sweden.*

RAM-NEK - Premium heavy duty hatch cover tape.  
 GULF-SEAL - Heavy duty hatch cover tape  
 MARITAPE-60 - Hatch cover tape  
 MARITAPE-40 - Hatch cover tape  
 KOAMING-AIDE - Coaming joint sealant  
 RAM-WRAP - Pipe repair system

## Heyl & Patterson

Equipment Division of The HALL Group  
 514 Mecklem Lane  
 Ellwood City  
 PA  
 16117  
 USA

**Contact:** Ms Chelsea Finlay  
**Job Title:** Marketing Manager  
**T:** + 1 724 758 1558  
**F:** + 1 412 4811100  
**E:** heylpatterson@hallindustries.com  
**W:** www.heylpatterson.com/  
 railcar\_unloaders.aspx

## Hitachi Construction Machinery (Europe) NV

Siciliëweg 5  
 Amsterdam  
 1045 AT  
 The Netherlands

**Contact:** Ms Ghislaine Jonker  
**Job Title:** Manager, Corporate Communication  
**T:** + 31 20 44 76 700  
**F:** + 31 20 33 44 045  
**E:** marketing@hcme.com  
**W:** www.hcme.com

Hitachi Construction Machinery (Europe) NV's (HCME) main products are hydraulic excavators, crawler cranes, wheel loaders, rigid dump trucks, and light compaction equipment. With such an extensive product line-up, HCME has earned itself an excellent reputation for performance, reliability and safety

around the world.

## HKD Blue

15 Mercer Road  
 Natick  
 MA  
 01760  
 USA

**Contact:** Mr Gordon Santry  
**Job Title:** Business Development Manager  
**T:** + 1617 913 7679  
**E:** gsantry@hkdblue.com  
**W:** http://www.hkdblue.com/

## Horizon Conveyor Equipment

Unit 1, Haysech Road  
 Halesowen  
 West Midlands  
 B63 3PD  
 UK

**Contact:** Mr Alan Bowler  
**Job Title:** Managing Director  
**T:** + 44 121 550 2218  
**F:** + 44 121 550 2243  
**E:** info@horizonconveyors.co.uk  
**W:** www.horizonconveyors.co.uk  
 Horizon Conveyor Equipment design and manufacture a comprehensive range of conveyor bulk handling equipment which includes:  
 Medium & Heavy-Duty Steel Idlers, Steel & HDPE  
 Conveyor Rollers, Primary, Secondary Belt Scrapers & V-Ploughs, Impact Sections & Skirts, Conveyor Covers, Pulleys.

## HOSCH-Fördertechnik Recklinghausen GmbH

Am Stadion 36  
 Recklinghausen  
 D-45659  
 Germany

**Contact:** Mr Giancarlo Leombruno  
**Job Title:** Export Manager

**T:** + 49 2361 5898 0  
**F:** + 49 2361 5898 40  
**E:** sales@hosch.de  
**W:** www.hosch.de

Hosch has been manufacturing and distributing Sprung Blade Scrapers and accessories for high-precision belt cleaning for 35 years now. The innovative design principle of the C-series, which is patented worldwide, utilises modular components and guarantees total belt cleaning efficiency for all types of installation.

## HPC Hamburg Port Consulting GmbH

Container Terminal Altenwerder  
 Am Ballinkai 1  
 Hamburg  
 21129  
 Germany

**Contact:** Dr Felix Kasiske  
**Job Title:** Managing Director, Partner  
**T:** + 49 40 74008 130  
**F:** + 49 40 74008 133  
**E:** f.kasiske@hpc-hamburg.de  
**W:** www.hpc-hamburg.de

Over the past 40 years HPC has gained a reputation as a globally leading ports and intermodal consulting firm in more than 1,400 projects spanning six continents. The range of services covers for i.a. development concepts, operational improvement, equipment engineering, IT strategy and development, supply chain management, sustainability management, training.

## Huadian Heavy Industries Co., Ltd.

No. 6 Auto Museum  
 East Road  
 Fengtai  
 Beijing

10070  
 China

**Contact:** Ms Chen Qiao  
**Job Title:** Market Manager of Materials Handling International  
**T:** + 86 10 6391 9524  
**F:** + 86 10 63919548  
**E:** chenq@chec.com.cn  
**W:** www.hhi.com.cn;  
 www.chec.com.cn

Material Handling Business Unit is the leading bulk materials handling company in China and is continuously expanding the application of bulk materials handling technologies (equipment and systems) for the world market. MHD is ready to supply the optimized solutions to your bulk materials handling requirement. Other Equipment: ship-unloader, wagon tippler, spreader, circular storage yard equipment

## Hycontrol Limited

Larchwood House  
 Orchard Street  
 Redditch  
 B98 7DP  
 UK

**Contact:** Mr Nigel Allen  
**Job Title:** Marketing  
**T:** + 44 1527 406800  
**F:** + 44 1527 406810  
**E:** nallen@hycontrol.com  
**W:** www.hycontrol.com

## Hyundai Heavy Industries Co

1000 Bangeojinsunhwan-doro  
 Dong-Gu  
 Ulsan  
 682-792  
 South Korea

**Contact:** Mr J.M. Roh  
**Job Title:** General Manager  
**T:** + 82 52 202 2429  
**F:** + 82 52 202 3315  
**E:** sbyun@hhi.co.kr

**W:** www.hhi.co.kr/

Produces a range of cranes and bulk-handling equipment, including gantry bulk unloaders and rail-mounted grab cranes.

## IBAU HAMBURG



Roedingsmarkt 35  
 Hamburg  
 20459  
 Germany

**Contact:** Mr Mario Rämmele  
**Job Title:** Sales Director  
**T:** + 49 40 361 309 24  
**F:** + 49 40 369 019 62  
**E:** mraemmele@ibauhamburg.de  
**W:** www.ibauhamburg.de

IBAU HAMBURG operates in the field of silo technology and pneumatic conveying systems for the cement, thermal power plant industry and the minerals industry throughout the world. IBAU supplies marine handling systems, ranging from shore-based terminals to self-unloading cement ships and barges, ship unloaders and loaders and floating terminals, ranging from individual components to entire EPC contracts.



# The perfect flow for your cement business.



## Space saving design with Cement Carriers by IBAU HAMBURG.

Saving space and costs: Our Cement Carriers are made to make your business more effective. The advanced Midship Tunnel System and the IBAU Pump guarantee you high loading and unloading rates and an efficient, fast and fully automatized process.

We not only offer you individual systems, but also **engineering services**. Please contact us for further information: [info@ibauhamburg.de](mailto:info@ibauhamburg.de)

IBAU HAMBURG is your ideal provider when it comes to cement – whether it is terminals, ship unloaders, EPC-contracting, silo conversions, as well as cement, raw meal or multicompartiment silos. **Find out more at [ibauhamburg.com](http://ibauhamburg.com)**

PROCESSING STORAGE MIXING PACKING FILLING PALLETIZING LOADING



**IBAU  
HAMBURG**  
A HAVER & BOECKER Company

## IBC International Handling AB

Hamnv. 1  
Falkenberg  
S-311 32  
Sweden  
**Contact:** Ms Maria Penca  
**Job Title:** Marketing Manager  
**T:** + 46 346 56910  
**F:** + 46 346 56918  
**E:** sales@ibc-international.se  
**W:** www.ibc-international.se

Supplies complete customised material handling systems. Dust-free, filling/discharging of big bags/small bags and transport of powder/granules. We also supply lifting equipment, both traditional, customized and with vacuum. We lift everything from big bags to helicopters.

## IEM FörderTechnik GmbH

IndustrieStraße 1  
Kasti (Kemnath)

D-95506  
Germany  
**Contact:** Mr Ralf Zander  
**Job Title:** Managing Director  
**T:** +49 96 42 800  
**F:** +49 96 42 3477  
**E:** info@iem-foerdertechnik.com  
**W:** http://iem-foerdertechnik.com/

## Igus GmbH



Postfach 90 61 23  
Köln  
D-51127  
Germany  
**Contact:** Mr Theo Diehl  
**Job Title:** Head of Intl. Cranes & Materialhandling  
**T:** + 49 2203 9649 0  
**F:** + 49 2203 9649 222

**E:** cranes@igus.de  
**W:** www.igus-cranes.com  
Products include E-ChainSystems - in operation on Bulkhandling Cranes, Ship to Shore Cranes, RTGs, RMGs, Goliath Cranes, Spreaders, Reach Stacker etc. More than 5.000 port equipment applications are running world-wide with igus® E-ChainSystems.

## IHI Transport Machinery Covan, Ltd. (IUK)

8-1 Seiroka Tower  
Akashi Cho  
Chuo-Ku  
Tokyo  
104-0044 MZ  
Japan  
**Contact:** Mr Tadashi Ito  
**Job Title:** Overseas Sales Dept  
**T:** + 81 3 5550 5375  
**F:** + 81 3 5550 5366  
**E:** Tadashi.Ito@iuk.co.jp  
**W:** www.iuk.co.jp  
IUK is a leading supplier of material

handling equipment and designs, supplies, and gives specialized services of machinery for loading, unloading, transport and storage of a wide range of materials such as containers, coal, iron ore, coke, bauxite, etc.

## IMASA

Palacio Valdes 1  
Oviedo (Asturias)  
33002  
Spain  
**Contact:** Mr Amancio Garcia  
**T:** + 34 985 22 71 78  
**F:** + 34 985 22 25 98  
**E:** amancio.garcia@imasa.com  
**W:** www.imasa.com

## IMGS

Mazaya Tower AA1,  
Jumeirah Lakes Towers  
Suite 2906  
Dubai  
UAE

**Contact:** Mr Shahbaz Alikhan  
**Job Title:** Director  
**T:** + 97 144 458 335  
**F:** + 97 144 458 337  
**E:** shahbaz@img.s.a  
**W:** www.imgs.a  
IMGS provides innovative and economical cargo handling solutions globally. Operating for over 30 years in the most diverse geographic and operational conditions, our teams are experienced and offer customized solutions for all cargo handling issues. With mobile bulk bagging, ship loading/unloading, Ship berthing and expediting we provide our customers with cost-effective handling of various commodities.

## IMO Germany

Imostr. 1  
Gremsdorf  
Bavaria  
91350  
Germany  
**Contact:** Mrs Christina Straubmeier  
**Job Title:** Executive Assistant  
Sales  
**T:** + 49 9193 6395 1481  
**F:** + 49 9193 6395 3456  
**E:** christina.straubmeier@imo.de  
**W:** http://www.goimo.eu/

## Imperial Technologies, Inc.

4155 Martindale Rd., NE  
Canton  
OH  
44705  
USA  
**Contact:** Mr Ron Tschantz  
**Job Title:** VP Gen Sales & Marketing  
**T:** + 1 330 491 3200  
**F:** + 1 330 491 3204  
**E:** rontschantz@imperial-technologies.com  
**W:** www.imperial-technologies.com  
Has a unique 'Multi-Fold' system that allows belt cover flaps to fold over and enclose the product. This system eliminates spillage and blow-off and can operate at steep angles.

## Impsa - Industrias Metalurgicas Pescarmana

Carril Rodriguez Pena 2451  
San Francisco del Monte  
Godoy Cruz  
Mendoza  
5501  
Argentina  
**Contact:** Mr Sergio Carobene  
**Job Title:** Operations Director  
**T:** + 54 261 413 1394  
**F:** + 54 261 413 1335  
**E:** Sergio.Carobene@impsa.com  
**W:** www.impsa.com  
Produces Panamax and post-Panamax ship-to-shore bulk cranes and unloaders.

## Incolab Services BV

PO Box 1561  
Oud-Beijerland  
BB  
3260  
The Netherlands  
**Contact:** Mr Leo Van Tour  
**Job Title:** Managing Director  
**T:** + 31 1866 10355  
**F:** + 31 1866 10552  
**E:** leo@incolab.com  
**W:** www.incolab.com  
Quality and quantity control in major coal ports worldwide.

# light & quick for heavy-weights

## P4 rol e-chain® in aluminium trough

All media in a single e-chain®. Drive and data cables, hoses, accessories. Corrosion-free and resistant to salt water in the igus® aluminium trough. Saves 30% weight compared to steel troughs. Travel of up to 800 m and speed of up to 600 m/min with 57% less drive power. Moving energy made easy.

**igus.eu/cranes**  
Request a free sample Tel. +49 2203 9649-800 info@igus.eu plastics for longer life®



## Indexator Rotator Systems AB

Allan Jonssons väg 2  
Vindeln  
SE-922 31  
Sweden  
**Contact:** Mr Valentin Gufier  
T: + 46 933 148 22  
E: rotator@indexator.se  
W: www.indexator.com  
The wide range of Indexator rotators are suitable for the most demanding materials handling tasks. Our rotators are used worldwide in many industries from forestry to scrap metal, general cargo to materials recycling. The compact, robust and low profile design, combined with the high quality materials used in construction, ensure a long working life.

## Industrial Netting (Pty) Ltd

PO Box 39624  
Bramley  
Gauteng  
2018  
South Africa  
**Contact:** Mr Ian Campbell  
**Job Title:** Managing Director  
T: + 27 11 6084686  
F: + 27 11 6084690  
E: info@industrialnetting.co.za  
W: www.industrialnetting.co.za

## Industrias Murtra

Jordi Camp 94  
Apartado 278  
Granollers  
Barcelona  
08403  
Spain  
**Contact:** Mr Xhabby Franco  
**Job Title:** Sales Manager  
T: + 34 93 846 7200  
F: + 34 93 846 5956  
E: murtra@murtra.com  
W: www.murtra.com

## Inman SA

Av Hermilo Mena N 10  
San Juan Ixhuatepec  
Edo de Mexico  
54180  
Mexico  
**Contact:** Mr Oscar Calderon  
T: + 52 55 5718 3036/4536  
F: + 52 55 5718 3432  
E: inman@inman.com.mx  
W: www.inman.com.mx  
Manufacturer of solid material handling equipment.

## Inspectorate (Suisse) SA - Bureau Veritas

Commodities Division  
Route de Cossonay 28b  
Prilly  
CH-1008  
Switzerland  
**Contact:** Mr Ivan Ivanov  
T: + 41 21 623 62 30  
F: + 41 21 623 67 00  
E: Agri@inspectorate.ch  
W: www.inspectorate.com

## Inspectorate America Corporation

12000 Aerospace Avenue  
Suite 200  
Houston  
Texas  
77034  
USA  
**Contact:** Mr Marlon Guillory  
**Job Title:** Assistant Manager -

Metals & Minerals  
T: + 1 504 418 1362  
E: MM\_Marketing@inspectorate.com  
W: www.inspectorate.com

## Inspectorate International Ltd

2 Perry Road  
Witham  
Essex  
CM8 3TU  
UK  
**Contact:** Mr John Soepnel  
**Job Title:** Business Development Manager  
Metals & Minerals Eur  
T: + 31 10.5937234  
F: + 44 1376 520819  
E: john.soepnel@inspectorate.com  
W: www.inspectorate.com  
Inspectorate, part of Bureau Veritas Commodities Division, is one of the world's leading independent inspection companies. We provide key inspection and sampling services globally for a wide range of metals, minerals, solid fuels & biomass materials. Analysis & testing is undertaken through our network of specialized laboratories, accredited to ISO17025.

## Instral B.V.

Platinastraat 33  
Lelystad  
Flevoland  
8211AR  
The Netherlands  
**Contact:** Mr Nils Janbroers  
**Job Title:** General Manager  
T: + 31 3 2041 5591  
E: contact@instral.com  
W: http://www.instral.com/  
Instral BV is a specialized and leading company in the world of dust protection and dust control. Our innovative C-Force® dust control additives are applicable for bulk storage, bulk handling and transshipment (coal, sand, iron ore pellets, fertilizer, wood chips, wood pellets etc.).

## Interjute BV

PO Box 154  
Hulst  
4560 AD  
The Netherlands  
**Contact:** Mr Robin van Hal  
**Job Title:** Business Development Exec  
T: + 31 114 387213  
F: + 31 114 311512  
E: rvhal@interjute.nl  
W: www.interjute.com  
50 kg. bags and FIBC's for all purposes. Fast deliveries all over the world.

## Intermodal Solutions Pty Ltd

The Zhen Building  
210/33 Lexington Drive  
Bella Vista  
NSW  
2153  
Australia  
**Contact:** Mr Garry Pinder  
**Job Title:** Managing Director  
T: + 61 400 035 548  
F: + 61 288 835 195  
E: gpinder@intermodalsolutions.com  
W: www.pittoship.com/

## International Bulk Handling Technology BV

PO Box 47  
Mierlo  
5730 AA  
The Netherlands

**Contact:** Mr Johan M.A.M. Brands  
**Job Title:** Technical Manager  
T: + 31 492 664 885  
F: + 31 492 664 695  
E: info@ibtbulk.nl  
W: www.ibtbulk.nl  
IBT is specialized in designing and turn-key supply of bulk handling systems like troughed belt conveyors, pipe conveyors and beltwall conveyors. With capacities of product conveyed up to 6000 tph major systems in harbors etc. have been supplied by IBT.

## Interstate Equipment Corporation

929 Park Avenue  
Pittsburgh  
Pennsylvania  
15234  
USA  
**Contact:** Mr Joe Vogel  
**Job Title:** Sales Manager  
T: + 1 412 563 5556  
F: + 1 412 563 6741  
E: joevogel@go-iec.com

## Intersystems

9575 N 109th Ave  
Omaha  
NE  
68142  
USA  
**Contact:** Mr Ray Vrtiska  
**Job Title:** VP Sales, Bulk Material Handling  
T: + 1 402 330 1500  
F: + 1 402 330 3350  
E: bulkmatl@intersystems.net  
W: www.intersystems.net  
Intersystems has expertise in the engineer and manufacture of bulk weighers, bucket elevators, enclosed belt and en-masse conveyors, gravity screeners, automatic samplers and truck probes, micro ingredient systems, bolted bins and distributors.

## Intertek Group plc

33 Cavendish Square  
London  
W1G 0PS  
UK  
**Contact:** Ms Noreen Boyhan  
T: + 44 20 7396 3400  
F: + 44 20 7396 3480  
E: n.boyhan@intertek.com  
W: www.intertek.com

## Intertek Testing Services

Majalco Building  
PO Box 1904  
2310 Fasong Jamo Ext Makiti  
Metro  
Manila  
Philippines  
**Contact:** Mr Eugenio Pranada Jr  
T: + 63 2 815 0293  
F: + 63 2 893 4635  
E: web.cm@intertek.com

## Invicta Vibrators

Harlaxton Road  
Grantham  
Lincolnshire  
NG31 7SF  
UK  
**Contact:** Mr Mike Caldwell  
**Job Title:** Sales Manager  
T: + 44 1476 566301  
F: + 44 1476 590145  
E: mike.caldwell@invictavibrators.co.uk

## iSAM AG Gesellschaft fuer angewandte Kybernetik

Alexanderstrasse 46  
Mülheim an der Ruhr  
45472  
Germany  
**Contact:** Dr Juergen Hellmich  
**Job Title:** Chief Executive Officer  
T: + 49 208 49 585 61  
F: + 49 208 49 585 62  
E: info@isam-ag.de  
W: www.isam-ag.de  
iSAM AG delivers the full range of products and services for advanced automation of bulk material handling and port operations. We handle turn-key solutions for new automation projects as well as the upgrading of existing equipment including project management, electrical engineering and commissioning.

## Isomonte SA

Rua Cristiano Franca Teixeira  
Guimaraes, 265  
Bairro Cinco  
Contagem  
Minas Gerais  
CEP 32010-130  
Brazil  
**Contact:** Mr Jose Rubem Almeida  
T: + 55 31 2128 2600 / 2641  
F: + 55 31 2128 2690  
E: info@isomont.com  
W: www.isomonte.com.br  
Specialises in the design and construction of turnkey systems for materials handling, including shiploaders/unloaders, mechanical grabs, stackers/reclaimers, shield, belt conveyors and steel structures for handling equipment.

## Istop Spamat Srl

Corso Antonio de Tullio 3  
Bari  
70123  
Italy  
**Contact:** Mr Vito Totorizzo  
**Job Title:** General Manager  
T: + 39 080 397 4444  
F: + 39 080 397 4474  
E: totorizzo@spamat.it  
W: www.spamat-group.com

## Italgru S.r.l.

4 Via Briantea  
Ambivere  
(BG)  
24030  
Italy  
**Contact:** Mr Fabrizio Bonfanti  
**Job Title:** C.E.O.  
T: + 39 0 35 49 32 411  
F: + 39 35 49 32 409  
E: coms@bonfanti.com  
W: www.italgru.com

## J & B Grabs b.v.

Rijksstraatweg 32  
Utrecht  
Utrecht  
3545 NA  
The Netherlands  
**Contact:** Mr Edgar Joustra  
**Job Title:** Director  
T: + 31 3066 63765  
F: + 31 3066 63765  
E: info@j-b-gripsers.nl  
W: www.jb-grabs.com  
Designs, engineers and manufactures mechanical and hydraulic grabs for all kinds of bulk material.

## J C Steele & Sons Inc

710 South Mulberry Street  
Statesville  
NC  
28687  
USA  
**Contact:** Mr Rick Steele  
**Job Title:** Marketing Manager  
T: + 1 704 872 3681  
F: + 1 704 878 0789  
E: ricksteele@jcsteele.com  
W: www.jcsteele.com  
Established in 1889, J. C. Steele is the largest producer of heavy clay machinery in the United States. Export sales to many parts of the world make up a large part of total business.

## J. Poulsen Shipping USA

4203 Montrose Boulevard  
Suite 490  
Houston  
TX  
77006  
USA  
**Contact:** Mr George Vassilas  
**Job Title:** Chartering Manager  
T: + 1 713 942 8825  
F: + 1 713 942 8850  
E: mail@jpsphip.dk  
W: www.jpsphip.dk  
J. Poulsen Shipping's core activities are ship management, chartering and operation, with a focus on ocean transport for breakbulk, heavy-lift, project and IMO cargoes.

## James A. Redding Company

733 S. Center Avenue  
Somerset  
PA  
15501  
USA  
**Contact:** Mr Brian Putman  
T: + 1 814 444 7200  
F: + 1 814 445 1320  
E: salesinfo@jamesaredding.com  
W: http://www.jamesaredding.com/

## Jansen & Heuning

Bulk Handling Systems  
Duinkerkenstraat 11  
Groningen  
9723 BN  
The Netherlands  
**Contact:** Mr Bart Klimp  
**Job Title:** Marketing & Sales  
T: + 31 50 312 64 48  
F: + 31 50 313 80 18  
E: bk@jh.nl  
W: www.jh.nl

## Jansens & Dieperink BV

PO Box 436  
Zaandam  
1500 EK  
The Netherlands  
**Contact:**  
**Job Title:** Sales Department  
T: + 31 75 616 8555  
F: + 31 75 6168569  
E: info@jansensanddieperink.com  
W: www.jansensanddieperink.com  
Engineering, fabrication and assembly of stainless and aluminium silos and gravity blenders. Dry bulk container with aluminium liner.

## JCB

Lakeside Works  
Rocester  
Uttoxeter  
Staffordshire  
ST14 5JP  
UK  
**Contact:** Mr Lee Appleby  
**Job Title:** Marketing Manager

E: lee.appleby@jcb.com  
W: https://www.jcb.com/en-gb

## JEM International

6873 Martindale  
Shawnee  
Kansas  
66218  
USA  
**Contact:** Mr Brett Mattson  
**Job Title:** VP - Marketing  
T: + 1 913 441 4788  
F: + 1 913 441 1711  
E: info@JemScales.com  
W: www.JemBaggingScales.com  
JEM International sells and manufactures a complete line of gross and net weigh, open mouth bag filling machinery, bag closing, positioning and transfer equipment. We design and provide complete automatic systems with robotic palletizing equipment, automatic bag hangers and portable bagging systems.

## Jenike & Johanson Inc.

400 Business Park Drive  
Tyngsboro  
MA  
01879  
USA  
**Contact:** Mr Brian Pittenger  
**Job Title:** Director Business Development  
T: + 1 978 649 3300  
F: + 1 978 649 3399  
E: bhpittenger@jenike.com  
W: www.jenike.com  
Our engineering services focus on material flow properties and your operating conditions to assist you in selecting the right process equipment, or troubleshooting existing equipment. For 50 years, we have tested over 8,000 materials and successfully serviced over 3,500 companies.

## JFE Engineering Corporation

Marunouchi Trust Tower North  
1-8-1 Marunouchi  
Chiyoda-ku  
Tokyo  
100-0005  
Japan  
**Contact:** Mr Takashi Ishii  
**Job Title:** Executive VP  
T: + 81 3 6212 0800  
F: + 81 3 6216 0802  
E: ishii-takashi@jfe-eng.co.jp  
W: www.jfe-eng.co.jp/en/

## Jiangsu Zhendong Port Machinery Manufacturing Co., Ltd.

Changshu City  
Jiangsu Province  
215500  
China  
**Contact:** Ms Doris Chen  
**Job Title:** Marketing  
T: + 86 0512 529 36333  
86-512-52936333  
F: + 86 1512 529 35033  
E: jszdgj@163.com  
W: www.cnzdj.net/

## Jim Way Enterprise Co., Ltd

No. 17 Chang Tai Street  
Hsiao Kang Dist.  
Kaohsiung  
81266  
Taiwan  
**Contact:** Mr Guillermo Su  
**Job Title:** International Sales Manager

T: + 888 7 8718126  
F: + 886 7 8718128  
E: jw@roller.com.tw  
W: www.roller.com.tw  
Using less money to supply the best performance of your conveyor systems is what Jim Way served. Over 30 years experience (established in 1982) we analysis of problems and suggest for conveyor components (idlers, belt cleaners, pulleys/laggings, skirt rubbers, impact beds, and ceramic liners) on site or in our workshops.

## Johannes Hübner Fabrik elektrischer Maschinen GmbH

Siemensstrasse 7  
Giessen  
D-35394  
Germany  
**Contact:** Mr Matthias Simon  
**Job Title:** Sales Manager  
T: + 49 641 79 69 0  
F: + 49 641 736 45  
E: matthias.simon@huebner-giessen.com  
W: www.huebner-giessen.com  
Hübner Giessen is considered a market leader in measurement, encoder and drive technology with activities in the following industrial sectors: Steelworks and rolling mills, mining, cranes, railways, marine, oil and gas, traction technology, hydroelectric power plants and energy systems.

## John R Boone Ltd Industrial Mixers

18 Silk Street  
Congleton  
Cheshire  
CW12 4DH  
UK  
**Contact:**  
**Job Title:** Sales Administrator  
T: + 44 1260 272894  
F: + 44 1260 281128  
E: sales@jrboone.com  
W: www.jrboone.com  
JR Boone Ltd manufacturer Industrial Mixing machines for the Bulk Solids and Chemical industry Worldwide. Our objective is efficiency, precision and even mixing with our Helical, Delta, Paddle or Drum Mixers. Further Test in our Lab mixer available.

## Joy Global Inc

100 East Wisconsin Avenue  
Milwaukee  
WI  
53202  
USA  
**Contact:** Mr Edward L Doheny  
**Job Title:** CEO  
T: + 1 414 319 8500  
E: info@joyglobal.com  
W: www.joyglobal.com/

## JSC RIKON

Tvaika Street 68b  
Riga  
LV-1034  
Latvia  
**Contact:** Mr Jānis Smelters  
**Job Title:** Chief Operating Officer  
T: + 371 67393156 / + 371 29103410  
F: + 371 67393828  
E: rikon@rikon.lv or sales@rikon.lv  
W: www.rikon.lv  
RIKON JSC is a producer of port lifting equipment. Main products are level luffing portal cranes, gantry cranes and mechanical rope grabs as well as spare parts for lifting

equipment, JSC RIKON also provides services for installation, erection and commissioning of cranes and various other port equipment.

## JSC Tehnoros

Gzhatskaya st, 21, liter A  
Saint-Petersburg  
195220  
Russia  
**Contact:** Mr Oleg Kasinov  
**Job Title:** Marketing Director  
T: + 7 812 718 82 82 (232)  
E: Kasinov@tehnoros.ru  
W: www.tehnoros.ru

## Jumbo Shipping

PO Box 23016  
Rotterdam  
3001 KA  
The Netherlands  
**Contact:** Ms Dorrie Dijsselbloem  
**Job Title:** Senior Communications Advisor  
T: + 31 10 7900300  
F: + 31 10 4334624  
E: ddijsselbloem@jumbogroup.nl  
W: www.jumbogroup.nl  
Jumbo is a leading heavy lift shipping company that develops pioneering solutions for ocean transportation. We operate a fleet of 12 specialised heavy lift vessels with a lifting capacity varying from 500t to 1,800t. To cater for ever increasing industry demand two new vessels, with a lifting capacity of 3,000t and built to a Finnish-Swedish ice class 1A, will complement the fleet in 2013.

## Kalenborn Kalprotect GmbH & Co. KG

Asbacher Str 50  
Vettelschoss  
D-53560  
Germany  
**Contact:** Mr Michael Rokitta  
**Job Title:** Managing Director  
T: + 49 26 45 18 196  
F: + 49 26 45 18 180  
E: michael.rokitta@kalenborn.de  
W: www.kalenborn.com  
One of the world's leading manufacturers and suppliers for wear resistant linings. Kalenborn provides tailor-made solutions starting from advice to design and manufacturing through to construction and on-site assembly using a wide range of mineral, ceramic, metallic, plastic or rubber materials. The scope of supply covers pneumatic, hydraulic and mechanical conveying including storage in silos and bunkers.

## KCT Grab Industry

Agva cad. yeni sanayi sitesi  
No:3-5  
Sile  
Istanbul  
34980  
Turkey  
**Contact:** Cpt Atilla Kocatas  
**Job Title:** General Manager  
T: + 90 216 739 59 68  
F: + 90 216 739 59 83  
E: info@kctgrab.com or sales@kctgrab.com  
W: www.kctgrab.com  
We are grab manufacturers, since 1992.  
- Radio Remote Control Ship Grabs  
- Electro Hydraulic Grabs  
\* Clamshell type  
\* Orange peel type  
- Electro Hydraulic Water Proof Grabs  
- Mechanical 2 & 4 rope Grabs

- Hydraulic excavators Grabs  
- Dredging Grabs  
- Timber Grabs  
- 2 & 4 rope Roundnose Grabs  
- Marine Port fender Construction  
- Port Hopper

## Kinergy Corporation

7310 Grade Lane  
Louisville  
Kentucky  
40219  
USA  
**Contact:** Mr Bill Ware  
**Job Title:** Project Manager  
T: + 1 502 366 5685  
F: + 1 502 366 3701  
E: bware@kinergy.com  
W: www.kinergy.com  
Kinergy Corporation is a vibratory equipment manufacturer, which includes vibrating screens, feeders, conveyors, bin activators, dryers and coolers, railcar densifiers and dischargers, storage pile dischargers.

## King Bag & Manufacturing Co

1500 Spring Lawn Avenue  
Cincinnati  
OH  
45223  
USA  
**Contact:** Mr Mike Jennings  
**Job Title:** Sales Manager  
T: + 1 513 541 5440 ext 306  
F: + 1 513 541 6555  
E: mike@kingbag.com  
W: www.kingbag.com

## Kingfisher Industrial Ltd

Cradley Business Park  
Overend Road  
Cradley Heath  
West Midlands  
B64 7DW  
UK  
**Contact:** Ms Anita Chumber  
**Job Title:** Sales & Marketing Executive  
T: + 44 1384 410777  
F: + 44 1384 410877  
E: achumber@kingfisher-industrial.co.uk  
W: www.kingfisher-industrial.co.uk  
Kingfisher specialise in manufacturing wear resistant process plant and equipment used to convey, store and handle bulk solid material. We offer solution-driven, tailored concepts to counter the detrimental effects of handling and processing abrasive minerals by employing our extensive expertise in the design, manufacture, wear protection and installation services.

## KINSHOFER GmbH

Hauptstrasse 76  
Waakirchen  
Bavaria  
D-83666  
Germany  
**Contact:** Mr Bernhard Fiechter  
**Job Title:** Export Sales  
T: + 49 8021 8899 2210  
F: + 49 8021 8899 37  
E: b.fiechter@kinshofer.com  
W: www.kinshofer.com  
KINSHOFER GmbH is a medium sized company specializing in the development, production and sales of hydraulically operated crane and excavator attachments. Founded in 1971 and based south of Munich's dynamic financial region, today KINSHOFER GmbH is the center of an international group of 15 companies with about 500



employees worldwide.

## Kiruna Wagon AB

Truckverkstaden  
Kiruna  
981 86  
Sweden  
**Contact:** Mr Daniel Kangas  
T: + 46 70 226 26 56  
E: daniel.kangas@heedmark.com  
W: http://kirunawagon.com/

## Kleemann GmbH

Hildenbrandstr.18  
Goppingen-Faurndau  
D-73035  
Germany  
**Contact:** Mr Mark Hezinger  
**Job Title:** Marketing  
T: + 49 7161 206 0  
F: + 49 7161 206 100  
E: info@kleemann.info  
W: www.kleemann.info

## Knight Energy Services Limited

Eccleston Grange  
Prescott Road  
St Helens  
Merseyside





WA10 3BQ  
UK  
**Contact:** Mr Mark Willis  
T: + 44 1744 733757  
F: + 44 1744 27062  
E: mark.willis@ahkggroup.com  
W: www.ahkggroup.com/

**KOCKS ARDELT KRANBAU GmbH**

Branch Bremen  
Weserstrasse 64  
Bremen  
28757  
Germany  
**Contact:** Mr Bernd Flaskamp  
**Job Title:** Managing Director  
T: +49 421 6601 319  
F: +49 421 6601 367  
E: bernd.flaskamp@kocksardelt.de  
W: www.kocksardelt.de  
Development, engineering and supply including erection and commissioning of handling equipment as well as related consulting and other services.

**Kocks ARDELT KRANBAU GmbH**

Heegermühler Straße 64  
Eberswalde  
16225  
Germany  
**Contact:** Mr Bernd Flaskamp  
**Job Title:** Managing Director  
T: + 49 421 6601 319  
F: + 49 421 6601 367  
E: bernd.flaskamp@kocksardelt.de  
W: www.kocksardelt.de  
Crane manufacturer (designing, fabrication, assembling, commissioning, training, after sales service in one hand for harbour cranes, shipyard cranes, balancer cranes - refurbishment, inspection, repair service for own and third party cranes).  
Former member of TAKRAF group, now member of KRANUNION GmbH. (together with KOCKS KRANE GmbH and KIROW ARDELT GmbH, Leipzig/Germany)

**Komatsu Mining Corp.**

West Quay Road  
Sunderland Enterprise Park  
Sunderland  
Tyne & Wear

SR5 2TD  
UK  
**Contact:** Mr Paul Bancroft  
**Job Title:** Global Product Director - Conveyors  
T: + 44 191 516 5353  
F: + 44 191 516 5399  
E: rebecca.crossley@mining.komatsu  
W: https://mining.komatsu/  
Complete conveyor systems for bulk mineral handling at ports, mines, quarries, process plants. Belt conveyor component manufacturer of idlers, rollers, pulleys, drums and structures. Full range of compact conveyor drives from 20kw to 1000kw.

**Konecranes (France)**

47 bis Boulevard de Gravelle  
B.P. 727  
Le Havre  
Cedex  
76060  
France  
**Contact:** Mr Gerard Lesueur  
T: + 33 2 35 25 95 14  
F: + 33 2 35 25 95 82  
E: gerard.lesueur@konecranes.com  
W: www.konecranes.com

**Konecranes B.V. - The Netherlands**

Eikenburglaan 7d  
Rosmalen  
5248 BJ  
The Netherlands  
**Contact:** Mr A M Verstedden  
**Job Title:** Manager Special Cranes  
T: + 31 735 217 279  
F: + 31 735 217 438  
E: info.nl@konecranes.com

**Konecranes Finland Corporation**

PO Box 662  
(Koneenkatu 8)  
Hyvinkää  
FIN-05801  
Finland  
**Contact:** Mr Jari Itäkodes  
**Job Title:** Product Manager, Shipyard and Bulk Handling Cranes  
T: + 358 40 768 8258  
F: + 358 20 427 2599  
E: jari.itakodes@konecranes.com  
W: www.konecranes.com  
Konecranes is a world-leading group of Lifting Businesses™, serving a broad range of customers, including manufacturing

and process industries, shipyards, ports and terminals. Regardless of your lifting needs, Konecranes is committed to providing you with lifting equipment and services that increase the value and effectiveness of your business. See more information on www.konecranes.com

**Konecranes Hafentechnik GmbH**

Mühlenfeld 20  
Langenhagen  
D-30853  
Germany  
**Contact:** Mr Dirk Groth  
**Job Title:** Manager Marketing & Sales Support  
T: + 49 511 7704 418  
F: + 49 511 7704 477  
E: info-hafentechnik@konecranes.com  
W: www.konecranes.de  
Services all types of cranes and port handling equipment regardless of manufacturer.

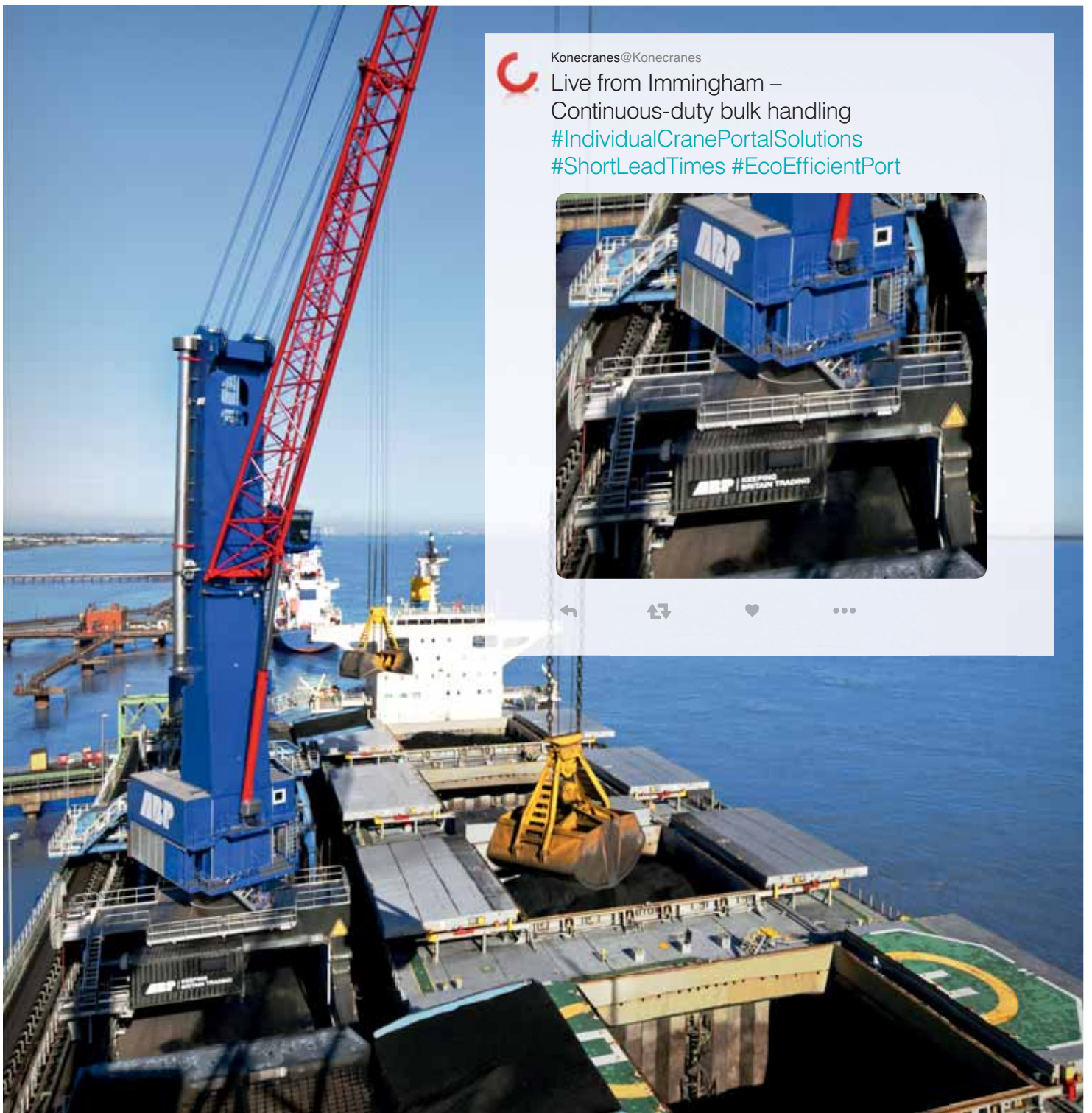

## SEARCHING FOR GREATER BULK HANDLING PRODUCTIVITY?

Reach out and grab it with a Konecranes Gottwald Portal Harbor Crane. Take these two Model 8 four-rope grab cranes at ABP in Immingham, UK that handle coal, biomass and petcoke to supply power and industrial plants. They have customized, robust rail-mounted portals topped by proven mobile harbor crane technology and they're equipped to operate on-grid to maximize eco-efficiency.

Find out more about portal harbor cranes at [konecranes.com](https://www.konecranes.com)

**KONECRANES**<sup>®</sup>  
Lifting Businesses™



## Konecranes Port Solutions

### KONECRANES

Demag Cranes & Components GmbH  
Forststrasse 16  
Düsseldorf  
D-40597  
Germany  
Contact: Mr Giuseppe Di Lisa  
Job Title: Sales & Marketing Director  
T: + 49 211 7102 3771  
F: + 49 211 7102 3651  
E: ps.info@konecranes.com  
W: www.konecranes.com

**FOR GREATER BULK HANDLING PRODUCTIVITY**

Reach out and grab it with eco-efficient Konecranes Gottwald Mobile Harbor Crane technology. Depending on site and operating conditions, our four-rope grab cranes, also available as rail-mounted portal and floating cranes, achieve handling capacities of up to 1,800 tph in continuous-duty bulk handling. Our broad range of products with their smart crane features is supported by dedicated planning and consultancy services and backed by a global service network.

## Kornylak Corporation

400 Heaton Street  
Hamilton  
OH  
45011  
USA  
Contact: Mr Bruce Bens  
Job Title: Sales Manager  
T: + 1 513 863 1277 ext 35  
F: + 1 513 863 7644  
E: bruce@kornylak.com  
W: www.kornylak.com

Produces a variety of freight loading and unloading systems, including roller and conveyor loaders for dry bulk cargoes.

## KPI-JCI and Astec Mobile Screens

700 West 21st Street  
Yankton  
South Dakota  
57078  
USA  
Contact: Mr Ron Earl  
Job Title: Vice President Sales & Marketing  
T: + 1 605 665 9311  
F: + 1 605 665 8858  
E: mail@kpijci.com  
W: www.kpijci.com

KPI-JCI and Astec Mobile Screens, Astec companies (NASDAQ: ASTE), is a world-wide leader in manufacturing equipment for the aggregate, construction, paving and recycling industries. As an innovative, high integrity manufacturer, KPI-JCI and Astec Mobile Screens develops quality, state-of-the-art products and has the ability to engineer custom products because of a highly qualified engineering staff. For more information, call (605) 665-9311 or visit the website at www.kpijci.com.

## Kramer & Duyvis BV

Mauritsstraat 4  
Zaandam  
1506 TZ  
The Netherlands  
Contact: Mr Rene Blom  
Job Title: Director  
T: + 31 75 612 33 49

F: + 31 75 612 30 06  
E: info@kramer-duyvis.nl  
W: www.kramer-duyvis.nl

Over 30 years leading in engineering and manufacturing reliable and economical weighing- and dosing systems for high quality dry bulk materials. For user friendly filling your big-bag, FIBC, tote bin, box or drum. Kramer and Duyvis beltconveyors shall change the direction of your general cargo.

## KRANUNION GmbH

Spinnereistraße 13  
Leipzig  
04179  
Germany  
Contact: Ms Ulrike Manke-Krausemann  
Job Title: Marketing Department  
T: + 49 341 4953 221  
F: + 49 341.4953 108  
E: ulrike.manke-krausemann@kranunion.de  
W: www.kranunion.de

Kranunion is an association of three crane manufacturers specialised in lifting and transporting heavy loads. Krow is the world market leader for railway cranes and slag pot carriers. Ardelt is the world market leader for double jib level luffing cranes. Kocks is the world market leader for Goliath cranes and innovator for STS container cranes.

## Krech Ojard & Assoc

227 W 1st St  
Suite 200  
Duluth  
Minnesota  
55082  
USA  
Contact: Mr Kevin Ehrenreich  
Job Title: Director Infrastructure Services  
T: + 1 218 727 3282  
F: + 1 218 727 1216  
E: kevin.ehrenreich@krechojard.com  
W: www.krechojard.com

## Kröger Greifertechnik GmbH & Co. KG

Steinheide 1-9  
Sonsbeck D-47665  
Germany  
Contact: Dr Philipp Diekmann  
Job Title: Managing Director  
T: + 49 2838 3750  
F: + 49 2838 3729  
E: info@kroeger-greifertechnik.de  
W: www.kroeger-greifertechnik.de

Manufacturer of grabs. Main products include two rope grabs, four rope grabs, electro-hydraulic grabs and electro hydraulic grabs from 0.5m3 to 26m3.

## Kuiken N.V.

1 Dukaat  
Emmeloord  
8305 BC  
1 Ducat  
8305 BC  
The Netherlands  
Contact: Mr Eric Bossinade  
Job Title: Sales Manager  
T: + 31 0 527 63 65 00  
F: + 31 0 527 61 67 95  
E: paul.helmink@kuiken.nl  
W: www.kuiken.nl

## Lachenmeier Monsun A/S

Grundtvigs Allé 176  
Sønderborg 6400  
Denmark

Contact: Mr Christan Petersen  
Job Title: Sales Director  
T: + 45 74 42 24 64  
F: + 45 74 43 04 04  
E: mail@lachenmeier-monsun.com  
W: www.lachenmeier-monsun.com

Designs and supplies complete plants for the handling of grain and feedstuffs. The product programme includes chain conveyors, belt conveyors and bucket elevators for capacities up to 800tph; compressed-air cleaned filters and drying plants for capacities up to 200tph.

## Laidig Systems Inc

14535 Dragoon Trail  
Mishawaka  
Indiana  
IN 46544  
USA  
Contact: Mr Mike Schuster  
Job Title: VP of Sales  
T: + 1 574 256 0204 x 236  
F: + 1 574 256 5575  
E: sales@laidig.com  
W: www.laidig.com

Laidig Systems, Inc. provides custom-engineered bulk storage silos and automated unloading reclaim systems which offer proven performance and reliability. Known throughout the industry for their rugged, high-quality systems, Laidig excels in innovative, effective designs customized to store and reclaim materials with special handling requirements. Materials include meals, wood chips, sawdust, recycled materials, coal, and other industrial materials.

## Laing O'Rourke

825 Ann Street  
Brisbane  
Queensland 4105  
Australia  
Contact: Mr Josh Murray  
T: + 61 7 3223 2303  
F: + 61 7 3223 2300  
E: rlayton@laingorourke.com.au  
W: www.laingorourke.com.au

## Langston Companies Inc

401 East Clay Street  
PO Drawer 350  
Crowley  
LA  
70527-0350  
USA  
Contact: Ms Carla Lormond  
Job Title: Bulk Bag Division Site Manager  
T: + 1 337 783 2010  
F: + 1 337 788 1000  
E: clormond@langstonbag.com  
W: www.langstonbag.com

## Lanier & Associates

4101 Magazine Street  
New Orleans  
Louisiana  
70115  
USA  
Contact: Mr John Rutherford  
T: + 1 504 895 0368  
F: + 1 504 895 0566  
E: jrutherford@lanier-engineers.com  
W: www.lanier-engineers.com

Consulting and design engineers; construction managers for marine terminals worldwide.

## Larsen & Toubro Limited

Monunt Poonamallee Road  
Manapakkam  
PB No.979  
Chennai  
600089



India  
Contact: Mr Kumar Vikram  
Job Title: ECC Division  
T: + 91 44 2252 6250  
F: + 91 44 22526993  
E: kvikram@intecc.com

## Larsen & Toubro Limited

Bldg. 'C'  
Powai Campus  
Gate No. 1  
Saki Vihar Road  
Mumbai  
400072  
India  
Contact: Mr Tapan Sen  
T: + 91 22 67050505 x 3385  
F: + 91 22 67051462  
E: Tapan.Sen@larsentoubro.com

## Lassing Dibben Consulting Engineers Ltd

PO Box 472  
Trenton  
Ontario  
K8V 5R6  
Canada  
Contact: Mr David Jesse  
Job Title: Projects Manager  
T: + 1 613 398 0007  
F: + 1 613 394 4173  
E: info@lassingdibben.com  
W: www.lassingdibben.com

Lassing Dibben specializes in the field of bulk material handling and extensive experience in this field has given Lassing Dibben the capacity to handle all aspects of system design. The highly qualified engineers and technologists work together to design advanced equipment installations meeting specific customer requirements.

## Lawrence Industries, Inc.

10403 Arbor Trail  
Fort Wayne  
Indiana  
46804  
USA  
Contact: Mr Kerry McAtee  
Job Title: Sales Engineer  
T: + 1 260 432 9693  
F: + 1 260 432 6302  
E: kmcatee@lawrenceindustriesnow.com  
W: www.tivar88.com

Lawrence Industries, Inc. is a supplier of industrial lining materials

that improve bulk material flow in silos, bins, and bunkers. TIVAR 88 is a primary material that is used to eliminate bridging, arching and ratholing. Lawrence Industries designs and fabricates.

## LBU Marine & Cranes

8th floor, Raffles City  
No.268 Xizang Zhong Lu  
Shanghai  
Huangpu District  
200001  
China  
Contact: Ms Cherie Sile Hu  
Job Title: Marketing Communications  
T: + 86 21 2328 8289  
F: + 86 21 2328 8290  
E: cherie-sile.hu@cn.abb.com

## Legacy Building Solutions, Inc.

19500 County Road 142  
South Haven  
Minnesota  
55382-9240  
USA  
Contact: Ms Sarah Cords  
Job Title: Director of Marketing  
T: + 1 320 258 0500  
F: + 1 320 259 0087  
E: marketing@legacybuildingsolutions.com  
W: www.legacybuildingsolutions.com

Legacy Building Solutions designs, manufactures, engineers and installs large-scale custom fabric structures for a wide range of industries. A pioneer in the use of a rigid steel frame for fabric structures, the company has achieved ISO 9001:2008 and CSA-A660 certifications.

## Libran Engineering and Services

C-33, First Floor  
Malviya Nagar  
New Delhi  
110 017  
India  
Contact: Mr Anil Seth  
Job Title: Director  
T: + 91 11 266 71658  
E: libranengineering@gmail.com  
W: www.libranengineering.com

## Librawerk Maschinenfabrik GmbH **LIEBHERR**

Vossenkamp 1  
Braunschweig  
Lower Saxony  
D-38104

Germany  
**Contact:** Mr Klein  
**T:** + 49 531 370980  
**F:** + 49 531 3709888  
**E:** info@librawerk.de  
**W:** www.librawerk.de

Fully automatic and semi automatic bagging units for open mouth and valve bags for almost all kinds of bulk goods. Big bag filling machines with a weighing range of up to 2,000kg, with capacities from 5 to 60 bags/hour. Fully automatic and semi automatic bagging units for open mouth and valve bags for almost all kinds of bulk goods. Big bag filling machines with a weighing range of up to 2,000kg, with capacities from 5 to 60 bags/hour.

## Liebherr-Danmark ApS **LIEBHERR**

Marsalle 38A  
Horsens  
8700  
Denmark

**Contact:**  
**T:** + 45 75 79 0321  
**F:** + 45 75 79 0445  
**E:** info@lwe.dk  
**W:** www.liebherr.com

## Liebherr- Hydraulikbagger GmbH **LIEBHERR**

Liebherrstrasse 12  
Kirchdorf  
88457  
Germany

**Contact:** Ms Stefanie Willburger  
**Job Title:** Marketing  
**T:** + 49 735480 7953  
**E:** info@lhb.liebherr.com  
**W:** www.liebherr.com

Liebherr-Hydraulikbagger GmbH is a global leader in the manufacture of state-of-the-art hydraulic excavators. Furthermore, the company develops and manufactures material handling machines and articulated trucks. The hydraulic excavators are successfully used throughout the world in civil engineering as well as in many special tasks such as horticulture and landscape gardening, for example. The areas of application for the material handling machines range from scrap, wood, and port handling right up to waste management and recycling.

## Liebherr-MCctec Rostock GmbH

**LIEBHERR**

(Liebherr Mobile Harbour Cranes)  
Liebherrstr. 1  
Rostock  
18147  
Germany  
**Contact:** Mr Leopold Berthold  
**Job Title:** Sales Director

**T:** + 43 50809 41725  
**F:** + 43 50809 41447  
**E:** mobile.harbour.cranes@liebherr.com  
**W:** www.liebherr.com  
**F:** facebook.com/LiebherrMaritime  
Liebherr Maritime Cranes offers a comprehensive portfolio of innovative maritime equipment to successfully complete your cargo handling tasks. The range includes state-of-the-art port equipment, ship cranes and offshore cranes. In order to optimise your handling rates, Liebherr also provides professional simulator-based training solutions and a global service network for quick response times.

## Liebherr-Singapore Pte Ltd

**LIEBHERR**

No. 8 Pandan Avenue  
Singapore  
609384  
Singapore

**Contact:** Mr Yong Soon Huat  
**Job Title:** General Manager  
**T:** + 65 6265 2305 ext 218  
**F:** + 65 6261 6485  
**E:** soonhuat.yong@liebherr.com  
**W:** www.liebherr.com

## Liebherr-Werk Bischofshofen GmbH

**LIEBHERR**

Dr.-Hans-Liebherr-Straße 4  
Bischofshofen  
AT - 5500  
Austria



**Contact:** Mr Martin Koller  
**Job Title:** Teamleiter Marketing  
**T:** + 43 50809 11475  
**F:** + 4 350809 17475  
**E:** martin.koller.lbh@liebherr.com  
**W:** www.liebherr.com

## Lion Bulk Handling b.v.

Global Headquarters  
Noord 101  
Krimpen aan de Lek  
Amsterdam  
2931 SJ

The Netherlands  
**Contact:** Mr Marcel van  
Rangelooij

**Job Title:** CEO  
**T:** + 31 180 440 720  
**F:** + 31 180 516 064  
**E:** news@lionbulkhandling.com  
**W:** www.lionbulkhandling.com

## Listenow GmbH & Co.

**LISTENOW**  
TECHNISCHE ASSISTENZ FÜR SCHIFFSCHAFFEN

Dieselstrasse 21  
Rutesheim  
71277

Germany  
**Contact:** Mr Carsten Lohr  
**T:** + 49 7152 50900  
**F:** + 49 7152 509050  
**E:** c.lohr@listenow.com

**W:** www.listenow.com

Products manufactured include:

- Loading Systems
- Loading Hoses (PU-flex, an own brand)
- Filters, Positioning Aids (LIS-pos), Folding Steps (LIS-klapp)
- Winches

# Mack

## Manufacturing Grapples & Buckets

**“Quality First”**  
**Since 1942**

[www.mackmfg.com](http://www.mackmfg.com)



7205 Bellingrath Road, P.O. Box 1559, Theodore, Alabama 36590, USA  
Fax: +1-251-653-1365

Email: [sales@mackmfg.com](mailto:sales@mackmfg.com)

Telephone: +1-251-653-9999  
Website: [www.MackMfg.com](http://www.MackMfg.com)



## LOC

IBEX House  
42-47 Minories  
London  
EC3N 1DY  
UK

**Contact:** Dr Aime Harrison  
**Job Title:** Associate  
**T:** + 44 2072643250  
**F:** + 44 2072643250  
**E:** aime.harrison@loc-group.com  
**W:** www.loc-group.com

## LT LIGHTING CO.,LTD

No.49 Zhongtai Western Road  
Liufang Village  
Hetang  
Pengjiang District  
Jiangmen City  
Guangdong  
China

**Contact:** Ms June Hou  
**T:** + 86 8675 0395 0729  
**E:** junhou03@lighting-lt.com  
**W:** www.lt-lighting.com/

## Lycopodium

163 Leichhardt St  
Spring Hill  
QLD  
4171  
Australia

**Contact:** Mr Mark Osborne  
**Job Title:** Engineer  
**T:** + 61 7 3244 7777  
**F:** + 61 7 3244 7788  
**E:** mminerals@lycopodium.com.au  
**W:** www.lycopodium.com.au

## Macawber Engineering, Inc

1829 Clydesdale Street  
Maryville  
TN  
37801-3796  
USA

**Contact:** Mr Dean Wicks  
**Job Title:** VP Business Development  
**T:** + 1 800 433 2213  
**F:** + 1 865 984 5286  
**E:** webinquiry@macawber.com  
**W:** www.macawber.com  
Manufacturers of custom-made dense-phase pneumatic conveying solutions worldwide. Expertise and experience for 40 years in designing systems that save energy, improve reliability and downtime.

## MacGREGOR Group AB

PO Box 4114  
Gothenburg  
40040  
Sweden

**Contact:** Mr Hans Ohlsson  
**Job Title:** Sales Manager  
**T:** + 46 318 50900  
**F:** + 46 318 50901  
**E:** hans.ohlsson@macgregor-group.com  
**W:** www.macgregor-group.com

## MacGregor SWE AB

Sjögatan 4G  
Örnköldsvik  
SE-891 85  
Sweden

**Contact:** Mr Mikael Hägglund  
**T:** + 46 660 294000  
**F:** + 46 660 12455  
**E:** Mikael.Hagglund@macgregor.com  
**W:** www.macgregor-group.com

## Mack Manufacturing Inc



PO Box 1559  
7205 Bellingrath Road  
Theodore  
Alabama  
36582  
USA

**Contact:** Mr Matthew A. Davidson  
**Job Title:** Vice President - Marketing  
**T:** + 1 251 653 9999  
**F:** + 1 251 653 1365  
**E:** sales@MackMfg.com  
**W:** www.mackmfg.com  
Manufacturing all sizes and styles of grapples and clamshell buckets. Specializing in customized electro-hydraulic, diesel powered, and remote controlled crane attachments.

## Mactenn Systems Ltd.

One Bull Lane  
Acton  
Sudbury  
Suffolk  
CO10 0BD  
UK

**Contact:** Mr Lee Suckling  
**Job Title:** Director, Sales & Application Engineering  
**T:** + 44 1787 882 422  
**F:** + 44 1787 882 433  
**E:** sales@mactenn.com  
**W:** www.mactenn.com  
Mactenn Systems designs and manufactures dense phase pneumatic conveying systems. As a company we have over 35 years of experience with the conveying of a wide range of bulk materials within our specialist areas of: The Power, Minerals, Chemicals, Food, Biomass, Metals and Plastics industries.

## Mahr GmbH Anlagentechnik für Schuttgüter

Rheingaustrasse 100  
Wiesbaden  
D-65203  
Germany

**Contact:** Herr Dipl.-Ing. Dieter Bee  
**Job Title:** Marketing Manager  
**T:** + 49 611 967 64 0  
**F:** + 49 611 967 64 19  
**E:** Mahr.Anlagentechnik@t-online.de  
**W:** www.mahr-gmbh.de

## Manitowoc Engineering

500 South 15 Street  
Manitowoc  
WI  
54220  
USA

**Contact:** Mr Chris Bratthauer  
**Job Title:** Media  
**T:** + 1 920 683 6510  
**F:** + 1 920 683 6277  
**E:** tcioni@manitowoc.com  
**W:** www.manitowoccranes.com  
Manufacturer of lattice-boom cranes and attachments with lifting capacities from 73 to 1300 tonnes and excavator capacities from 9 to 22.6 tonnes.

## Mantsinen Group Ltd Oy

Valikankaantie 3  
Ylmylly  
FIN-80400  
Finland



**Contact:** Ms Mia Mantsinen  
**Job Title:** Vice President  
**T:** + 358 20 755 1230  
**F:** + 358 13 252 5555  
**E:** mia.mantsinen@mantsinen.com  
**W:** www.mantsinen.com  
Mantsinen is a forerunner of material handling and logistics in ports, terminals and industry. Mantsinen material handling machines tailor configured to best suit each application. Mantsinen HybriLift® energy saving system and wide range of attachments makes the cranes economical, efficient and universal tools for stevedoring companies and harbour operators.

## Mantsinen Group Ltd Oy

Valikankaantie 3  
Ylmylly  
FIN-80400  
Finland

**Contact:** Mr Tapio Pirinen  
**Job Title:** Vice President, Material Handling  
**T:** + 358 20 755 1230  
**F:** + 358 13 252 5555

**E:** tapio.pirinen@mantsinen.com  
**W:** www.mantsinen.com  
Mantsinen is a forerunner of material handling and logistics in ports, terminals and industry. Mantsinen material handling machines tailor configured to best suit each application. Mantsinen HybriLift® energy saving system and wide range of attachments makes the cranes economical, efficient and universal tools for stevedoring companies and harbour operators.

## Maquinas Condor SA

Av Dos Estados 1383  
Porto Alegre  
RS 90200-001  
Brazil

**Contact:** Mr André Meyer da Silva  
**Job Title:** Director  
**T:** + 55 51 2104 3388  
**F:** + 55 51 2104 3345  
**E:** andre@maquinascondor.com.br  
**W:** www.maquinascondor.com.br  
Founded 1959. Engineers and manufactures complete systems for solid bulk materials handling ports and terminals. Equipment range includes pneumatic grain unloading, continuous shiploading, bulk stacking, reclaiming, belt conveyor, bucket elevator and mechanical conveyor. Operating from barges up to capesize ships, to 3000 tph. Shipunloaders and shiploaders operating successfully in ports around the world.

## Marine Inspection and Logistics

408 Richmond Avenue  
Point Pleasant Beach  
New Jersey 08742  
USA

**Contact:** Ms Marylon Cresitelli  
**Job Title:** inspection Advertiser  
**T:** + 1 732 899 0500  
**F:** + 1 732 899 0518  
**E:** mpl@midship.com  
**W:** www.midship.com

## Marine Inspection LLC

621 North Carrollton Avenue  
New Orleans  
LA 70119  
USA

**Contact:** Mr Robert Drew  
**Job Title:** Managing Partner  
**T:** + 1 504 866 0014  
**F:** + 1 504 866 0016  
**E:** rdrew@marineinspection.com  
**W:** www.marineinspection.com/

## Maritime Strategies International

48 Marney Road  
London SW11 5EP  
UK

**Contact:** Ms Tarryn Teller  
**T:** + 44 207 940 0070  
**F:** + 44 207 223 9991  
**E:** tarryn@msilt.com  
**W:** www.msilt.com

## Marsden Weighing Machine Group Ltd

Anvil House  
Tuns Lane  
Henley-on-Thames

**LISTENOW**  
VERLADESYSTEME FÜR SCHÜTTGÜTER



Replacement loading hoses  
+49 7152 50900



Image: LISTENOW Loading System 4030 with fill-level indicator

### We make sure that nothing gets lost!

For over 40 years, our loading systems for bulk materials have been synonymous around the world with long-lasting and reliable technology.

- Bulk loading systems for open and closed loading
- Loading with no segregation e.g. with **FLOW-stop** technology
- Dust-free loading
- High quality loading hoses e.g. made in wear-resistant **PU-flex**
- Positioning System **LIS-pos**
- First-class service: Start-up and installation  
Revision and repair services  
System maintenance, modernisation and upgrading
- more informationen at [www.listenow.com](http://www.listenow.com)

Oxfordshire  
RG9 1SA  
UK

**Contact:** Ms Sally Tooher  
**Job Title:** Marketing Manager  
**T:** + 44 845 130 7330  
**F:** + 44 845 130 7440  
**E:** sallytooher@  
marsdengroup.demon.co.uk  
**W:** www.marsden-weighing.co.uk

## Martin Engineering



One Martin Place  
Neponset  
Illinois  
IL 61345  
USA

**Contact:** Mr Rick Felde  
**Job Title:** Marketing  
**T:** + 1 309 852 2384  
**F:** + 1 800 814 1553  
**E:** rickf@martin-eng.com  
**W:** www.martin-eng.com  
Martin Engineering makes bulk material handling cleaner, safer and more productive, improving belt conveyors by suppressing dust and spillage, removing carryback and controlling belt tracking. Specialists in belt cleaners, air cannons, engineered vibration, transfer point technologies, dust management, belt alignment, silo cleaning.

## Martin Engineering GmbH

In der Rehbach 14  
Walluf  
Hessen  
D-65396  
Germany  
**Contact:** Mr Michael Hengl  
**Job Title:** General Manager  
**T:** + 49 6123 978 20

**F:** + 49 6123 755 33  
**E:** info@martin-eng.de  
**W:** www.martin-eng.de  
Equipment for Bulk Material Handling. We make your bulk material handling cleaner, safer and more productive.

## Martin Engineering South Africa

PO Box 12696  
Leraatsfontein  
1038  
South Africa  
**Contact:** Mr Hannes Kotze  
**Job Title:** Managing Director  
**T:** + 27 13 656 5135  
**F:** + 27 13 656 5129  
**E:** hannesk@martin-eng.co.za  
**W:** www.martin-eng.co.za  
Installation & Maintenance of belt cleaners, sealing systems, impact support, belt tracking, air-cannons, screen vibrators, silo cleaning, service contracts, Martin Engineering Service Group - MESH S Class air supported conveyors,

Inertial Flow chutes.

## Maschinen und Mühlenbau Erhard Muhr GmbH



Grafenstraße 27  
Brannenburg  
D-83098, Germany  
**Contact:** Mr Roland Muhr  
**Job Title:** Managing Director  
**T:** + 49 8034 90720  
**F:** + 49 8034 9072 526

**E:** info@muhr.com  
**W:** www.muhr.com  
MUHR offers a wide range of high quality Bulk Loading Systems (for open and closed, dust-free loading), Loading Spout Positioners, Pneumatical Docking Devices and even Railcar Dumping Systems for economical unloading of trains with open railcars.

## Matcon

Matcon House  
London Road  
Morton in Marsh  
Gloucestershire  
GL56 0BJ  
UK

**Contact:** Mr Simon Gibson  
**T:** + 44 1608 651666  
**F:** + 44 1608 651635  
**E:** s.gibson@matcon.co.uk  
**W:** www.matcon-cone.com  
Specialises in powder handling and processing systems for the chemical industry. Manufactures metal powder silos and IBCs.

## MATEC massagoed techniek BV

PO Box 707  
Amersfoort  
3800 AS  
The Netherlands  
**Contact:** Mr Marc Fischer  
**T:** + 31 33 475 2653  
**E:** info@matec.nl  
**W:** www.matec.nl

An independent distributor. Offers a wide range of bulk handling equipment and components. Bulk-bag handling, tubular chain conveyors, vibrating feeders, sieves, rotary valves, also for high temperature.

## Material Handling Asia

2/70 Tossapol Land 4 Floor  
14 Bangna-Trad road  
Bangkok  
Bangna  
10260  
Thailand  
**Contact:** Miss Witchanee Namthip  
**T:** + 66 027443180  
**F:** + 66 027443177  
**E:** witchanee@ata-services.com  
**W:** www.j-tecasia.com/

## Matrix PDM Engineering

5100 E Skelly Drive  
Suite 100  
Tulsa  
OK  
74135  
USA  
**Contact:** Ms Katie Smith  
**Job Title:** Business Development  
**T:** + 1 918 838 8822  
**F:** + 1918 838 8810  
**E:** katherinesmith@matrixpdm.com  
**W:** www.matrixpdm.com  
Matrix PDM Engineering provides comprehensive, multi-discipline engineering solutions with industry-leading expertise in aboveground storage, low temperature and cryogenic tanks and terminals, specialty vessels, silos and other bulk storage, natural gas processing, sulfur recovery, processing and handling, process plant design, power generation environmental controls and material handling, industrial power distribution design and engineering, electrical, instrumentation and controls / controls and automation, marine structures and material handling systems and terminals.

## MegaRoller

17 Murphy Street  
O'Connor  
Canberra  
WA 6163  
Australia  
**Contact:** Mr Jannie Kotze  
**Job Title:** Director  
**T:** + 61 8 9314 5000  
**F:** + 61 8 9314 5500  
**E:** sales@megaroller.com.au

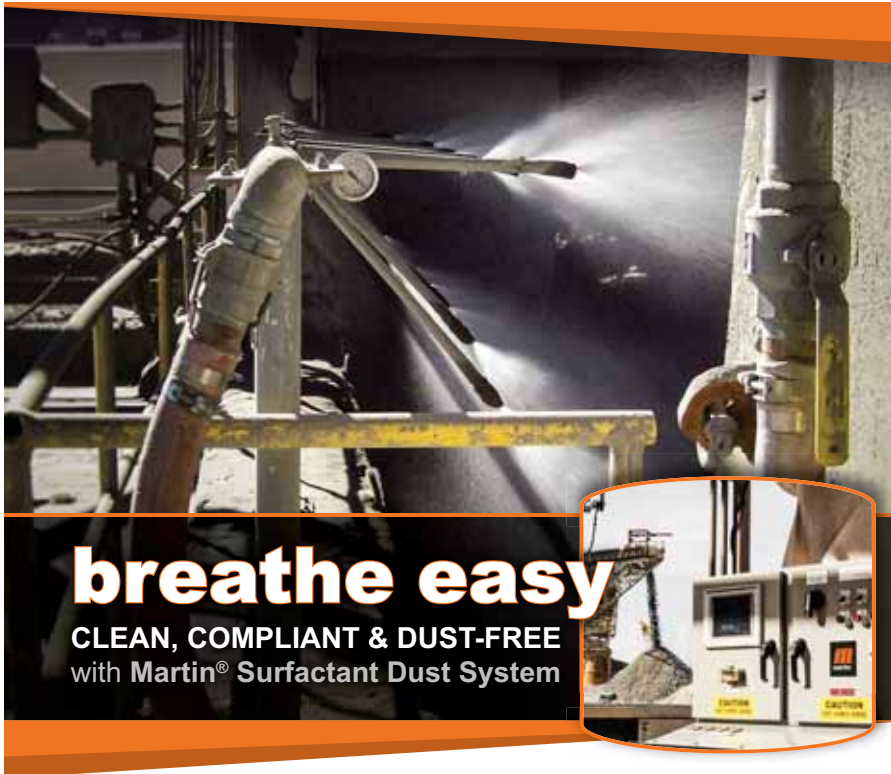

# breathe easy

**CLEAN, COMPLIANT & DUST-FREE**  
with Martin® Surfactant Dust System

## Martin® Surfactant Dust System

- ▶ Custom-designed to meet individual customer requirements
- ▶ Fully-automated system maintains consistent treatment application
- ▶ Automatic flow adjustment eliminates surfactant waste and cost
- ▶ Industry-leading quality components for dependable operation
- ▶ Effective surfactant solutions available to suit application



call **309.852.2384** or **800.544.2947**  
visit [martin-eng.com](http://martin-eng.com)  
email [dustmgmt@martin-eng.com](mailto:dustmgmt@martin-eng.com)

**Problem Solved™**  
**GUARANTEED!**



© Registered trademark of Martin Engineering Company in the US and other select locations. © 2017 Martin Engineering Company. Additional information can be obtained at [www.martin-eng.com/trademarks](http://www.martin-eng.com/trademarks) and [www.martin-eng.com/patents](http://www.martin-eng.com/patents).



W: [www.megaroller.com.au](http://www.megaroller.com.au)

## Mentor Dynamics

170 Penrod Court  
Glen Burnie  
Maryland  
21061  
USA  
**Contact:** Mr Don Watts  
**Job Title:** President  
**T:** + 1 410 760 6349  
**F:** + 1 410 760 8284  
**E:** [don.watts@mentordynamics.com](mailto:don.watts@mentordynamics.com)  
**W:** [www.mentordynamics.com](http://www.mentordynamics.com)  
Company designs, fabricates and installs high performance polymer liners for ships, barges and docking facilities.

## Merius Oy

BOX 17 / Satamatie 330  
Kokkola  
67101  
Finland  
**Contact:** Mr Hannu Sarja  
**Job Title:** Managing Director  
**T:** + 358 6822 4882  
**F:** + 358 6822 4883  
**E:** [hannu.sarja@merius.fi](mailto:hannu.sarja@merius.fi)  
**W:** [www.merius.fi](http://www.merius.fi)  
Merius Oy is a mechanical design & engineering company from Kokkola, Finland. We provide conceptual & detailed design, cost calculation and project management services. Our field of expertise consists from logistics planning for industry and ports to steel structure, plant and product design. Our clients are from various fields of industry.

## Merrick Industries

10 Arthur Drive  
Lynn Haven  
FL  
32444  
USA  
**Contact:** Mr Erik Nolte  
**Job Title:** Sales Manager  
**T:** + 1 850 265 3611  
**F:** + 1 850 265 9768  
**E:** [info@merrick-inc.com](mailto:info@merrick-inc.com)  
**W:** [www.merrick-inc.com](http://www.merrick-inc.com)  
Merrick Industries is the leader in continuous weighing and feeding solutions since 1908. Merrick designs, manufactures, and supports all of our products at our Lynn Haven, Florida, plant for the Cement, Mining, Lime, Gypsum, Steel, and Aggregates industries. Products include belt conveyor scales, weighbelt feeders, impact flowmeters and apron feeders.

## Metso Minerals Industries, Inc.

Bulk Materials Handling  
2715 Pleasant Valley Road  
York  
PA  
17402  
USA  
**Contact:** Mr Tom Lippencott  
**Job Title:** VP, Mineral Process Solutions Sales, USA  
**T:** + 1 412 999 8552  
**F:** + 1 717 849 7148  
**E:** [Tom.Lippencott@metso.com](mailto:Tom.Lippencott@metso.com)  
**W:** [www.metso.com](http://www.metso.com)  
Manufacturer of large-scale equipment and systems for the handling of minerals and bulk materials in the mining, power, shipping and heavy industrial markets. Along with its products,

the company provides field service and replacement parts. Metso Mining & Construction.

## MH Automation International Ltd

13 Swift Business Centre  
East Moors  
Keen Road  
Cardiff  
CF24 5JR  
UK  
**Contact:** Mr Robin Evans  
**Job Title:** Managing Director  
**T:** + 44 2920 253300  
**F:** + 44 2920 253303  
**E:** [mail@mhai.co.uk](mailto:mail@mhai.co.uk)  
**W:** [www.mhai.co.uk](http://www.mhai.co.uk)

## Midwest Industrial Supply Inc

1101 3rd St. SE  
Canton  
Ohio  
OH 44707  
USA  
**Contact:** Ms Liz Campbell  
**Job Title:** Marketing  
**T:** + 1 330 456 3121  
**F:** + 1 330 456 3247  
**E:** [liz.campbell@midwestind.com](mailto:liz.campbell@midwestind.com)  
**W:** [www.midwestind.com](http://www.midwestind.com)  
A complete line of dust control, erosion control, soil stabilization, lubrication, anti-icing and de-icing products that are developed by their staff of chemists, manufactured in its plants across the US and backed by a complete range of services, equipment, expertise and technical support.

## Midwest International Standard Products, Inc.

105 Stover Road/ PO Box 438  
Charlevoix  
MI  
49720-0438  
USA  
**Contact:** Mr Walter Pair  
**Job Title:** President and CEO  
**T:** + 1 231 547 4000  
**F:** + 1 231 547 9453  
**E:** [sales@midwestinternational.com](mailto:sales@midwestinternational.com)  
**W:** [www.midwestmagic.com](http://www.midwestmagic.com)  
Founded in 1967. Focuses on dust free loading and stockpiling of dry bulk products. The pre-engineered product line has throughput capacities to 1400 STPH and useful vertical travels to 45 feet. The engineered systems product line has capacities to 6000 STPH and vertical travels to 100 feet. The dust free shiploading systems are used by governments and industries in over 50 countries.

## Millard Maritime

7730 Deer River Road  
Theodore  
AL  
36582  
USA  
**Contact:** Mr Bobby Wein  
**Job Title:** Vice President, Business Development  
**T:** + 1 251 443 6743  
**E:** [bwein@millardmaritime.com](mailto:bwein@millardmaritime.com)  
**W:** <http://millardmaritime.com/>

## Minebea Intec GmbH

Meiendorfer Strasse 205 A  
Hamburg  
D-22145  
Germany

**Contact:** Ms Inken Martens-Teuscher  
**Job Title:** Marketing  
**T:** + 49 40 67960917  
**E:** [Inken.Martens-Teuscher@minebea-intec.com](mailto:Inken.Martens-Teuscher@minebea-intec.com)  
**W:** [www.minebea-intec.com](http://www.minebea-intec.com)  
Weighing and batching technologies for grain handling.

## Mitchell Consulting Group, Inc

Green Spring Station  
PO Box 1116  
Brooklandville  
MD  
21022-1116  
USA  
**Contact:** Mr Walter Mitchell  
**T:** + 1 410 828 9371  
**F:** + 1 410 828 9372  
**E:** [mitgroup@verizon.net](mailto:mitgroup@verizon.net)  
**W:** [www.mitchellonline.org](http://www.mitchellonline.org)  
Mitchell Consulting conducts rigorous research, analysis and advisory into strategic and economic issues relating to marine transportation of all seaborne commodities. Since 1995, our clientele has benefited from keen insight into the markets surrounding local, regional and global seaborne transport of liquids and dry bulk commodities.

## Mitsubishi Heavy Industries

Steel Structure Systems  
International Ops Dept.  
5-1 Marunouchi  
2-Chome  
Chiyoda-ku  
Tokyo  
100-8315

## BULK LOADING TECHNOLOGIES



# Flexicient.

More flexible. More efficient.

**BULK LOADING SYSTEMS**  
MVS | MBG | MBO  
CSR Cascade System

The flexible and world-wide largest product range. Closed, open, combined. Of course dust-free. With individual adaption modules. More efficiency due to a reduction of operating cost by up to 50 %.

**RAILCAR DUMPERS**  
L-Tec | L-high Tec

Dumps up to ten railcars at the same time without a height limit. Space-saving due to the unique Muhr compact design. More flexible and more efficient.

[www.muhr.com](http://www.muhr.com)



For more Information  
please call now:  
**+49 (0)8034 9072-0**

Muhr GmbH  
Grafenstraße 27  
83098 Brannenburg/Germany

[info@muhr.com](mailto:info@muhr.com)



Japan

**Contact:** Mr Naohika Nanba  
**Job Title:** Managing Director  
**T:** + 81 3 3212 3111  
**F:** + 81 3 3212 9823  
**E:** naohika-nanba@hq.mh.co.jp  
**W:** www.mhi.co.jp  
 Produces mechanical and pneumatic ship loaders and unloaders, ship-mounted equipment, conveyors and components, stackers and reclaimers, weighing systems and automation equipment.

## Mitsubishi Nagasaki Machinery

1-2-1 Fukahorimarchi  
 Nagasaki  
 Japan  
**Contact:** Mr Kazuhiro Aritsuka  
**Job Title:** Export Department  
**T:** + 81 958 71 6106  
**F:** + 81 958 71 3576  
**E:** aritsuka@mnm.co.jp  
**W:** www.mnm.co.jp

## Mitsui Engineering & Shipbuilding Co

6-4 Tsukiji  
 5-Chome  
 Chou-ku  
 Tokyo 104  
 Japan  
**Contact:** Mr Nakajo  
**Job Title:** General Manager  
**T:** + 81 3 3544 3398  
**F:** + 81 3 3544 3031  
**E:** shipsale@mes.co.jp  
**W:** www.mes.co.jp



## ROPE GRABS MOTOR GRABS HYDRAULIC GRABS

in all executions for each handling  
 The perfect grabs with unbeatable handling  
 The most economic solution in grab construction

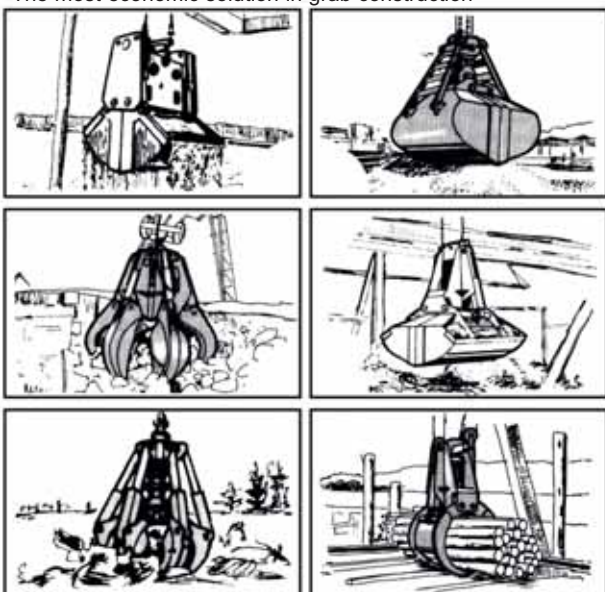

Talweg 15-17 · 74921 Helmstadt/Germany  
 Tel. +49-72 63-91 29-0 · Fax +49-72 63-91 29 12  
 email: info@mrs-greifer.de · www.mrs-greifer.de

## Mitsui Miike Machinery Co., Ltd.

Nihonbashi-Muromachi 2-1-1  
 Chuo-ku  
 Tokyo  
 103-0022  
 Japan  
**Contact:** Mr Hachiro Naito  
**Job Title:** General Manager,  
 Material Handling Machinery  
**T:** + 81 3 3270 2001  
**F:** + 81 3 3245 0203  
**E:** soumu@mitsuimiike.co.jp  
**W:** www.mitsuimiike.co.jp

## Mitsui Zosen Europe Limited

St Alphage House  
 2 Fore Street  
 London  
 EC2Y 5DA  
 UK  
**Contact:** Mr M Higashino  
**T:** + 44 20 7588 9277  
**F:** + 44-20 7256 7272  
**E:** info@dg.mitsui.com  
**W:** www.mes.co.jp/english/

## Mobile Conveying Systems

631 Uhlmann Rd  
 Burpengary  
 QLD  
 4505  
 Australia  
**Contact:**  
**T:** + 61 1300 665 409  
**E:** enquiries@mobileconveyors.com.au  
**W:** www.mobileconveyors.com.au/

## Moffatt & Nichol

5th Floor  
 34 Lime Street  
 London  
 EC3M 7AT  
 UK  
**Contact:** Mrs Rebecca Roberts  
**Job Title:** Office Manager  
**T:** + 44 203 2061062  
**F:** + 44 203 2061061  
**E:** roberts@moffatnichol.com

W: www.moffatnichol.com

## Mogensen Sizers

Haraxton Road  
 Grantham  
 Lincolnshire  
 NG31 7FF  
 UK  
**Contact:** Mr James Hornsey  
**Job Title:** Sales Manager  
**T:** + 44 1476 566301  
**F:** + 44 1476 590145  
**E:** james.hornsey@mogensen.co.uk  
**W:** www.mogensen.co.uk

## Mole•Master Services Corporation™

27815 State Route 7  
 Marietta  
 Ohio  
 45750  
 USA  
**Contact:** Mr David Laing  
**Job Title:** General Manager  
**T:** + 1 740 374 6726  
**F:** + 1 740 374 5908  
**E:** contactus@molemaster.com  
**W:** www.molemaster.com  
 Silo, Bin, Bunker, Transport and Process Vessel clearing, cleanout, cleaning and unlogging services or equipment. Mole•Master™ has over three decades of experience solving material build up problems in over 33 countries. Safely return any storage vessel to original capacity fast!

## Möllers Maschinenfabrik GmbH

Sudhoferweg 93-97  
 Beckum  
 D 59269  
 Germany  
**Contact:** Mrs Gabriela Tortato  
**Job Title:** Marketing  
**T:** + 49 2521 88 152  
**F:** + 49 2521 88 100  
**E:** info@moellers.de  
**W:** www.moellers.com  
 Möllers is a worldwide leading manufacturer of machines and



plants for the automatic filling of bulk materials, palletizing and loading of bags and other lots as well as for the packaging of pallets and other dispatch units in shrink and stretch films.

## Monolithic Dome Institute

177 Dome Park Place  
Italy  
Texas  
76651  
USA

**Contact:** Mr David B South  
**Job Title:** President  
**T:** + 1 972 483 7423  
**E:** sales@monolithic.com  
**W:** www.monolithic.org/

## Monotube Pile Corp.

PO Box 7339  
Canton  
OH  
44705-0339  
USA

**Contact:** Mr Sam Kosa  
**Job Title:** Marketing Manager  
**T:** + 1 330 454 6111  
**F:** + 1 330 454 1572  
**E:** monotube@raex.com

## Motherwell Automation

10 Sangiorgio Court  
Osborne Park  
West Perth  
WA

6017

Australia

**Contact:** Mr Chris Watson  
**Job Title:** Marketing Manager  
**T:** + 61 8 9212 4444  
**F:** + 61 8 9212 4479  
**E:** townsend@motherwell.net.au  
**W:** www.motherwell.net.au  
Specialises in industrial control and automation equipment, including PLCs, MMIs and computers.  
Recent contracts have included automation of grain terminals.

## Motion Metrics

101-2389 Health Sciences Mall  
Vancouver  
British Columbia  
V6T 1Z3  
Canada

**Contact:** Ms Jodie Davies  
**Job Title:** Marketing Manager  
**T:** + 1 604 822 5842  
**F:** + 1 604 677 5191  
**E:** jodie@motionmetrics.com  
**W:** www.motionmetrics.com

## Motridal SpA

Via Pietro Bubba 17  
Piacenza  
Piacenza  
29122  
Italy

**Contact:** Mr Giampietro Calvi  
**Job Title:** Sales Director  
**T:** + 39 0523 59 66 11  
**F:** + 39 0523 59 01 28  
**E:** motridal@motridal.com

**W:** www.motridal.com  
Specialist, with over 60 years experience, in heavy duty, high capacity machines, intended for operating under severe condition in cement factory, harbour terminal, steel works, power plant, aluminium smelter. Product line includes screw, chain, belt and pipe conveyors, bucket elevators, stackers. Worldwide operation.

## MRS Greifer GmbH



Talweg 15-17  
Helmstadt-Bargen  
D-74921  
Germany

**Contact:** Mrs Karin Greulich  
**Job Title:** Export Manager  
**T:** + 49 7263 912 915  
**F:** + 49 7263 912 912  
**E:** export@mrs-greifer.de  
**W:** www.mrs-greifer.de  
Approaching more than 40 years experience in producing all types of grabs. The company's product range extends from mechanical grabs, also radio-controlled, to

hydraulic and electro-hydraulic grabs. MRS has an excellent after-sales and repair service, provide spare parts from stock and supply parts for a long period after delivery.

## Mühlen Sohn GmbH & Co. KG

P.O. Box 1165  
Blaustein  
D-89130  
Germany

**Contact:** Mrs Karin Albrecht  
**Job Title:** Sales Director Fluitex  
**T:** + 49 7304 801 33  
**F:** + 49 7304 801 23  
**E:** karin.albrecht@muehlen-sohn.de  
**W:** www.muehlen-sohn.de  
Mühlen Sohn GmbH & Co. KG is one of the leading suppliers of fluidising fabrics and looks back to a success story since 1880 which means more than 130 years of weaving experience.  
Fluitex® air slide fabrics for pneumatic loading and unloading systems, airslides for pneumatic conveying, storage and homogenising silos, discharging cones, fly ash handling systems.

## Muller Beltex BV

Ambachtsweg 28A  
Pijnacker  
2641 KS

The Netherlands  
**Contact:** Mr Lars Muller

**T:** + 31 15369 5444  
**F:** + 31 15369 7864  
**E:** info@mullerbeltex.com  
**W:** www.mullerbeltex.com  
Produces conveyors and conveyor components, including elevator belting.

## Multidocker

Piessenspolderstraat 77  
Sluiskil  
GK  
4541

The Netherlands  
**Contact:** Mr Walter Hartmann  
**Job Title:** Director Sales and Marketing  
**T:** + 31 610359881  
**E:** walter.hartmann@multidocker.com  
**W:** http://multidocker.com/

## Musco Lighting

100 1st Avenue West  
P.O. Box 808  
Oskaloosa  
Iowa  
52577  
USA

**Contact:** Mr Jason Van Wyk  
**Job Title:** Public Relations  
**T:** + 1 641 673 0411  
**F:** + 1 515 664 1931  
**E:** jason.vanwyk@musco.com  
**W:** www.musco.com





## MUT - Maschinen-Umwelttechnik Transportanlagen

Schiessstattgasse 49  
Stockerau  
2000  
Austria  
**Contact:** Mr Alfred Schuh  
T: + 43 22 66 6030  
F: + 43 22 66 603202  
E: office@m-u-t.at  
W: www.m-u-t.at  
Plans, designs and manufactures complete bulk handling plants, including conveyor bridges, troughed chain conveyors and screw conveyors. Manufactures belt- and chain bucket elevators, belt conveyors, trough chain conveyors, bin emptying equipment, rotary feeders, drag chain conveyors, coal feeders and wetslag extractors.

## MWI Silo Systems Inc.

5001 Rd. 104 N. Easthope Perth East  
Wellesley  
Ontario  
N0B 2T0  
Canada  
**Contact:** Mr Joel Gingerich  
**Job Title:** Sales and Project Management  
T: + 1 519 656 2341  
F: + 1 519 656 3252  
E: joel@mwisilo.com  
W: http://mwisilo.com

## Nanhua Electronics Co., Ltd

Building 9, No 1755

Wenbei Rd  
Jiading District  
Shanghai  
201802  
China  
**Contact:** Mr Dong Hong  
**Job Title:** Deputy General Manager  
T: + 86 21 391 26868  
F: + 86 21 391 26868  
E: nh@nanhua.com  
W: http://en.nanhua.com/

## Nantong UP Machinery Engineering Co., Ltd

No.6 Shuanggong Road  
Qutang Town  
Hai'an County  
Nantong City  
Jiangsu Province  
China  
**Contact:**  
E: jsntup@163.com  
W: www.upmachinery.com.cn

## National Bulk Equipment Inc

12838 Stainless Drive  
Holland  
Michigan  
49424  
USA  
**Contact:** Mr Dave Denhof  
**Job Title:** Marketing Manager  
T: + 1 616 399 2220  
F: + 1 616 399 7360  
E: sales@nbe-inc.com  
W: www.nbe-inc.com

## National Ports Corporation Limited

2 Birksgate Road  
Rous Head, North Fremantle

Perth  
Western Australia  
60016159  
Australia  
**Contact:** Ms Klara Haselhurst  
**Job Title:** Administration Manager  
T: +61 8 9435 8088  
E: khaselhurst@nationalports.com  
W: www.nationalports.com

## Natural Grabs

Toros Caddesi Fethi bey sokak no 11  
Natural Business Center  
Maltepe  
Istanbul  
Turkey  
**Contact:** Mr Hayrettin Yakut  
T: + 90 216 380 60 03  
F: + 90 216 380 65 59  
E: sales@naturalgrab.com  
W: www.naturalgrab.com/

## NAVCO (National Air Vibrator Co)

PO Box 40563  
Houston  
TX  
77240-0563  
USA  
**Contact:** Mr Ann Hutchinson  
T: + 1 832 467 3636  
F: + 1 832 467 3800  
E: ben@navco.us  
W: www.navco.us

## Nectar Group Ltd



No 1 Ashton Gate  
Ashton Road



Harold Hill  
Romford  
Essex  
RM3 8UF  
UK

**Contact:** Mr Chris Leonard  
**Job Title:** Commercial Manager  
T: + 44 1708 386 555  
F: + 44 1708 386 665  
E: nectar.uk@nectargroup.net  
W: www.nectargroup.net  
Nectar Group is involved in handling and bagging of bulk commodities such as wheat, rice, sugar and fertilizers in ports and at inland locations. The Group's main activity includes positioning of its own mobile bagging equipment for handling one-off discharge and bagging contracts, Period Leases or Sales of bagging equipment. Nectar also provides lightening, expediting as well as bulk terminal management and consultancy services.

## Negrini Srl



via E. Torricelli n.4  
Castelfranco Emilia  
Modena  
41013  
Italy

**Contact:** Mr Massimo Negrini  
**Job Title:** Managing Director  
T: + 39 059 923110  
F: + 39 059 920378  
E: info@negrini.org  
W: www.negrini.org  
Negrini company, established in 1967, specializes in engineering and manufacturing a comprehensive range of grabs and buckets for rope machines and crawler mounted cranes. Professionalism and versatility towards different customer demands: this is the business philosophy of Negrini srl.

**NEGRINI**  
since 1967 S.R.L.

*the piece you are missing!*



# From ship to shore, from shore to ship...



## ...for sure.

**Nectar can say “for sure” with confidence.**

We've been supplying market leading bulk handling solutions for over 40 years and encountered and overcome many difficult situations, scenarios and challenges,

Since inventing the first mobile bagging system in the 1970s we have become world leaders in all aspects of bulk handling. Nectar have worked hard to develop important strategic relationships and specialist knowledge of port infrastructures ensuring that the solution we provide delivers your product on time, intact and cost effectively anywhere around the world.

Whether it's the simple task of transporting your product from A to B overland or consulting on the design, build and management of a new port we will have all the answers...**for sure.**



TERMINALS AND LOGISTICS

**T:** +44 1708 386 555 **W:** [www.nectargroup.co.uk](http://www.nectargroup.co.uk)

## Nemag BV



Deltastraat 15  
PO Box 110  
Zierikzee  
4300 AC  
The Netherlands

**Contact:** Mr Riny Stoutjesdijk  
**Job Title:** Sales Manager  
**T:** + 31 111 418 900  
**F:** + 31 111 416 154  
**E:** sales@nemag.com  
**W:** www.nemag.com

NEMAG specializes in high performance four rope grabs for medium and large scale bulk handling. "lowest handling costs per tonne material transferred" are the key words in NEMAG's philosophy. Also: NEMAG Quick Release Links and Rope Pear Sockets for fast and safe connection of a grab to a crane.

## NEO CORP BRASIL

Avenida Bento Munhoz da Rocha Neto, N°:1777  
Jardim Samambaia  
Paranaquá-PR  
83212-000  
Brazil

**Contact:** Mr Christopher Paolo  
**T:** + 55 41 3122 5771  
**E:** christopher@neocorpbr.com.br  
**W:** http://www.ncbr.com.br/

## NERAK GmbH Fördertechnik

Brigitta 5  
Hambühren

D-29313  
Germany

**Contact:** Mr Edgar Bleeker  
**Job Title:** Marketing  
**T:** + 49 50 84 944 0  
**F:** + 49 50 84 944 222  
**E:** bleeker@nerak.de  
**W:** www.nerak.com

Nerak manufactures some of the world's most technically advanced vertical conveying equipment for unit loads and loose bulk materials.

## Neuro Industrietechnik GmbH

### NEUERO

Neurostrasse 1  
Melle  
D-49324  
Germany

**Contact:** Eng. Andreas Haeuser  
**Job Title:** Sales & Project Manager  
**T:** + 49 5422 9503 26  
**F:** + 49 5422 9503 50  
**E:** a.haeuser@neuro.de  
**W:** www.neuro.com

NEUERO designs and manufactures pneumatic and mechanical ship/barge unloaders and ship/barge loaders, mobile pneumatic conveyors. Capacity range of 30t/h to 2.000t/h. Products: mainly grain, meals, biomass, alumina pet coke, fly ash and others.

## Nilfisk SpA

Via Porrettana 1991  
Zocca  
Modena  
41059  
Italy

**Contact:** Dr Leonardo Bianco  
**Job Title:** Director of Marketing  
**T:** + 39 059 973 00 00  
**F:** + 39 059 973 00 99  
**E:** industrial-vacuum@nilfisk.com  
**W:** www.nilfisk.com

Leader in the production of industrial vacuum solutions to collect any kind of material in metal, pharma food and any other manufacturing activity. Nilfisk is also engineering and manufacturing pneumatic conveyors and centralized vacuum systems.

## NILOS GmbH & Co KG

Reisholzstrasse 15  
PO Box 970  
Hilden  
40709  
Germany

**Contact:** Mr Jens Hamacher  
**Job Title:** Export Manager  
**T:** + 49 2103 9510  
**F:** + 49 2103 951 209  
**E:** jens.hamacher@nilos.de  
**W:** www.nilos.com

## NK Tehnologija SIA

120Z Dzelzavas Street  
Riga  
LV-1021  
Latvia

**Contact:** Mr Andrey Oleynik  
**Job Title:** Marketing & Publications  
**T:** + 371 67271092  
**F:** + 371 67271038  
**E:** nkteh@nkteh.lv  
**W:** www.nkteh.lv

NK TEHNOLOGIJA is a design, engineering and assembly company, specializing in dry bulk

material handling projects and lifting equipment since 2001. Operating within Latvia, Lithuania, Estonia, Russia, Finland and Norway.

## NKM Noell Special

### Cranes GmbH

Kruisweg 643  
Hoofddorp  
2132 NC  
The Netherlands

**Contact:**  
**Job Title:** Marketing Manager  
**T:** + 31 20 655 0030  
**F:** + 31 20 655 0040  
**E:** sales@nkmnoell.com  
**W:** www.nkmnoell.com/

## NM Heilig BV

Newtonstraat 17  
Heerhugowaard  
1704 SB  
The Netherlands

**Contact:** Mr G. S. Dwarsweerd  
**Job Title:** Head of Sales  
Department  
**T:** + 31 72 571 6688  
**F:** + 31 72 571 6020  
**E:** info@heilgbv.com  
**W:** www.heilgbv.com

For more than 30 years N.M. Heilig B.V. have specialised in designing, developing, producing and installing bulk-handling and recycling installations worldwide. Our key values are quality, durability and service.

## NMH s.r.o.

Priemyselná 4608/10  
Sereď

926 01  
Slovakia

**Contact:** Ms Veronika Kremľ  
**Job Title:** Marketing Manager  
**T:** + 42 131 230 4441  
**E:** v.kremľ@nmh-sro.com  
**W:** www.nmh-sro.com

## Noell Crane Systems (China) Ltd

China Merchants  
Zhangzhou Development Zone  
Fujian  
363105  
China

**Contact:**  
**T:** + 86 596 6851 888  
**F:** + 86 596 6851 889  
**E:** xia.info@terexnoell.com  
**W:** www.noellchina.com

## Nordströms Konstruktionsbyrå

Storgatan 58  
Umeå  
SE-903 30  
Sweden

**Contact:** Mr Peter Vedin  
**Job Title:** Marketing  
**T:** + 46 90 1136 4500  
**F:** + 46 90 1330 69  
**E:** arletun@nordstroems.se  
**W:** www.nordstroems.se

Dry bulk vehicle loading spouts.

## Nordstrong Equipment Ltd

5895 Ambler Drive  
Mississauga  
Ontario  
L4W 5B7

# NEW FASTER LIGHTER STRONGER

The new nemaX® grab for iron ore, >10% higher productivity than all comparable clamshell grabs, way stronger and the lowest maintenance cost ever.

Want to know more?

[nemag.com/nemax](http://nemag.com/nemax)

**nemag**







# NEUERO

Industrietechnik



The loader is working exceptionally well. No dust and the operators love it. *Murray Vanderpont - G3*



## Ausführung

Leistung: 1.500 t/h  
Fördergüter: Getreide  
Abmessungen: 27 m Ausleger  
Bauweise: Stationär  
Schiffgrößen: Laker  
Bemerkungen: KIKO Staubarm Beladepkopf

## Design

Capacity: 1.500 t/h  
Products: Grain  
Dimensions: 27 m Boom  
Type: Stationary  
Ship size: Laker  
Remarks: KIKO with DSH





[www.orts-grabs.de](http://www.orts-grabs.de)

Orts GmbH Maschinenfabrik • Schwartauer Str. 99  
23611 Sereetz • Germany

Tel: +49 451 398 850 • Fax: +49 451 392 374  
Email: [sigvard.orts-jun@orts-gmbh.de](mailto:sigvard.orts-jun@orts-gmbh.de)



**ORTS** GmbH





Canada

**Contact:** Mr Bill Van Duyn  
**Job Title:** Sales Manager  
**T:** + 1 289 562 6402  
**F:** + 1 289 562 6445  
**E:** wmvanduyn@nordstronqequipment.com  
**W:** www.nordstronqequipment.com  
 Designs and manufactures bulk material handling equipment and systems, including belt conveyors, screw conveyors, drag conveyors, bucket elevators and pipe conveyors.

## North American Crushing & Screening, LLC

322 Lafayette Street  
 New Orleans  
 Louisiana  
 LA 70130  
 USA

**Contact:** Mr Gilbert Wright  
**T:** + 1 504 866 0014  
**F:** + 1 504 866 0016  
**E:** gwright@nacslc.com  
**W:** www.nacslc.com  
 Based in New Orleans, North American Crushing & Screening, LLC (NACS) conducts specialized services for various parties involved with the trading, transportation and handling of commodities. NACS provides portable processing alternatives for bulk cargo. NACS also recycles C&D materials (Asphalt & Concrete) for the construction industry.

## Northern Conveyors

8 Einstein Drive  
 Golden Grove  
 SA  
 5125  
 Australia

**Contact:** Mr Colin Northey  
**Job Title:** Engineering Manager  
**T:** + 61 8 8289 1600  
**F:** + 61 8 8251 4944  
**E:** enquiries@northernconveyors.com.au  
**W:** www.northernconveyors.com.au  
 Northern Conveyors is a South Australian materials handling company, specialising in design, manufacture and distribution of conveyor products & equipment, including belt & roller conveyors, and all conveyor spares, including rollers, conveyor belts, drives and belt scrapers. Other conveyor services include conveyor design assistance, on-site trouble-shooting and custom conveyor manufacturing.

## N-service Aps.

Mommarkvej 81  
 Sønderborg  
 DK-6400  
 Denmark

**Contact:** Mr Niels Jørgen Truelsen  
**T:** + 45 53 28 32 90  
**E:** njt@n-service.dk

## NSL Engineering Pte Ltd

117 Dalhousie St  
 Haberfield  
 Sydney  
 NSW 2045  
 Australia

**Contact:** Mr Cameron Hay  
**Job Title:** Sales & Marketing Manager  
**T:** + 61 297 972054  
**F:** + 65 626 11300  
**E:** cameron@ramspreaders.com  
**W:** www.ramspreaders.com/



## O B Wiik AS

Industriveien 13  
 Skedsmokorset  
 2020  
 Norway

**Contact:** Mr Ole Gregersen  
**Job Title:** Export & Marketing Director

**T:** + 47 64 83 55 00  
**F:** + 47 64 83 55 01

**E:** ole.gregersen@obwiik.no  
**W:** www.obwiik.com

O. B. Wiik is a supplier of relocatable warehouses / Mobile Storage tents. Durable PVC coated fabric covers on clear span steel or aluminium frames 5 – 100 meter. WiikHalls are installed in more than 100 countries.

## o.z. HENNLICH ENGINEERING

HENNLICH s.r.o.  
 Ceskolipská 9  
 Litoměřice  
 412 01  
 Czech Republic

**Contact:** Mr Jan Petruzalek  
**Job Title:** Sales Director

**T:** + 420 416 711 357  
**F:** + 420 416 711 999

**E:** engineering@hennlich.cz  
**W:** www.hennlich-engineering.com  
 HENNLICH ENGINEERING is an expert in dust suppression. We design and manufacture telescopic spouts for loading of dry bulk solids, dust collectors for air filtration, fog cannons for the effective dust control.

## Oceanport Shiploaders Ltd

11 Cygnet Crescent  
 Dalkeith  
 6009  
 Australia

**Contact:** Mr Stewart Graham  
**Job Title:** Managing Director

**T:** + 61 8 9389 6490  
**E:** sg@grahamgroup.net.au

## Offshore Bulk Terminal Pte Ltd

50, Collyer Quay  
 OUE Bayfront, #06-04  
 Singapore

049321

Singapore

**Contact:** Ms Lohita Ellysiyana

**E:** lohita.ellysiyana@obt-group.com

**W:** http://www.obt-group.com

## Oldendorff Carriers GmbH & Co. KG

Willy-Brandt-Allee 6  
 Lubeck  
 23554  
 Germany

**Contact:** Mr William Wallace  
**Job Title:** Managing Director

**T:** + 49 451 1500 239

**E:** bizdev@oldendorff.com

**W:** www.oldendorff.com

Oldendorff is a private company which is an owner and operator of bulk carriers, usually operating a fleet of over 500 vessels. In addition the company performs transshipment of bulk cargo at 7 offshore locations to provide more cost effective freight for our customers.

## OMIC Perth

3/22 Rosco Turn  
 Rockingham  
 Western Australia  
 6168  
 Australia

**Contact:** Mr Takuyu Ajiro

**T:** + 61 8 9592 2281

**E:** uyukuta@hotmail.com

## Onestone Consulting Group GmbH

Alte Trift 19

Buxtehude

D-216 14

Germany

**Contact:** Dr Ing. Joachim Harder

**Job Title:** Management Consultant

**T:** + 49 4161 5568 17

**F:** + 49 4161 5568 27

**E:** consult@onestone.de

**W:** www.onestone.de

Product, market and strategy consulting.

## OP system ab

V Storgatan 26

OSBY

SKÅNE

S-28331

Sweden

**Contact:** Mr Anders Edbro

**Job Title:** Key Account Manager

**T:** +46 70600093

**F:** + 46706117930

**E:** anders.edbro@opsystem.se

**W:** www.opsystem.se

## Orthos Projects Ltd.

Fernie Road  
 Market Harborough  
 Leicestershire  
 LE16 7PH  
 UK

**Contact:** Mr Nick Hall

**Job Title:** Director

**T:** + 44 1858 462806

**F:** + 44 1858 464403

**E:** Nick.Hall@orthosprojects.com

**W:** www.orthosprojects.com

Since 1977 Orthos Projects have designed, manufactured and installed bulk solids raw materials handling plant to the highest specification.

Best qualified to serve the Port, Bulk Handling, Quarry, Foundry, Recycling and related industries, Special purpose machine design, conveyor systems to ISO 9001 (2008).

## ORTS GmbH Maschinenfabrik



Schwartauer Strasse 99

Sereetz

D-23611

Germany

**Contact:** Herr Sigvard Orts

**T:** + 49 451 3988515

**F:** + 49 451 392374

**E:** soj@orts-gmbh.de

**W:** www.orts-grabs.de

All kinds of mechanical rope grabs, electro-hydraulic grabs, radio controlled diesel-hydraulic grabs. Crane equipment for electro-hydraulic grabs. All clamshell

designs and sizes. TAILOR made!  
 Constructed and manufactured in Germany! 40 years of experience.

## Oxbow Energy Solutions BV

Wilhelminakade 93  
 Rotterdam  
 3072 AP

The Netherlands

**Contact:** Mr Ewoud Colenbrander

**Job Title:** Vice President

International Operations

**T:** + 31 104419200

**F:** + 31 104360692

**E:** Ewoud.Colenbrander@

oxbow.com

**W:** www.oxbow.com

One of the world's largest recyclers of refinery and natural gas byproducts. Oxbow upgrades, handles, transports and sells petroleum coke and sulphur into markets where they can be used to produce aluminum, steel, electric power, fertilizer, cement and other critical products for the world economy.

## P.T. Mitra S.K. Analisa testama

Pulogadung Trade Centre, Block 8H No 7

Jl. Raya Bekasi Km 21

Kawasan Industri

Jakarta 13930

Indonesia

**Contact:** Ms Mien Hermina

**Job Title:** Marketing Manager

**T:** + 62 21 4680 1210

**F:** + 62 21 4680 0716

**E:** mina@mitrask.com

**W:** http://www.mitrask.com/

## PAGE MACRAE ENGINEERING

61 Aerodrome Road

Mount Maunganui 3116

Bay of Plenty

New Zealand

**Contact:** Mr Bruce Ennis

**Job Title:** Manager Port Equipment

**T:** + 64 7 575 5079 Ext 810

**F:** + 64 7 574 8594

**E:** enquiries@page-macrae.co.nz

**W:** www.page-macrae.co.nz

Bulk cargo operators now require equipment that is safe, reliable and compliant even under extreme conditions.

Page Macrae Engineering has earned a reputation for delivering high-quality port equipment that is reliable, robust, low maintenance and highly productive, regardless of conditions and loads. We offer a combination of loading and unloading solutions that protect the environment while maximising bulk discharge productivity.

Since 1955 we've been designing and manufacturing port equipment. As Australasia's leading manufacturer, our bulk materials handling expertise covers the process from concept and design to build, commissioning and training. We have invested heavily in research and development to ensure the highest, most consistent standards of design and manufacture. Contact us to discuss your requirements.

## Pakiet

82-103 Stegna  
Rybina 43  
Gdansk  
Poland  
**Contact:** Mr Piotr Rzeszutek  
**Job Title:** Director  
**T:** + 48 55 247 17 70 ext.32  
**E:** patrycja@pakiet.com  
**W:** <https://pakiet.com>

## Parker Plant Ltd

Viaduct Works  
Canon Street  
Leicester  
Leicestershire  
LE4 6GH  
UK  
**Contact:** Mr Richard Fothergill  
**Job Title:** Marketing Manager  
**T:** + 44 116 266 5999  
**F:** + 44 116 261 0812  
**E:** [sales@parkerplant.com](mailto:sales@parkerplant.com)  
**W:** [www.parkerplant.com](http://www.parkerplant.com)

## Parsons Brinckerhoff

1401 K Street NW  
Suite 701  
Washington  
DC 20005  
USA  
**Contact:** Ms Joan B Yim  
**Job Title:** Vice President  
**T:** + 1 202 783 0241  
**F:** + 1 202 783 0229  
**W:** [www.wsp-pb.com/](http://www.wsp-pb.com/)

## Paul Hedfeld GmbH

Hundeicker Strasse 20  
Gevelsberg  
58285  
Germany  
**Contact:** Mr Burkhard Hedfeld  
**T:** + 49 2332 6371  
**F:** + 49 2332 61167  
**E:** [hedfeld@hedfeld.com](mailto:hedfeld@hedfeld.com)  
**W:** [www.hedfeld.com](http://www.hedfeld.com)  
Manufacturer of elevator buckets  
and screw flights.

## PEBCO®

PO Box 7506  
225 North 4th Street (42001)  
Paducah  
KY  
42002-7506  
USA  
**Contact:** Mr David Finke  
**Job Title:** VP, Sales and Marketing  
**T:** + 1 270 442 1996  
**F:** + 1 270 442 5214  
**E:** [sales@pebco.com](mailto:sales@pebco.com)  
**W:** [www.pebco.com](http://www.pebco.com)  
PEBCO® is acknowledged  
throughout the world in the field of  
moving, controlling and loading dry  
bulk materials. PEBCO®'s resources  
and responsibilities include  
customized gates, valves, mass  
flow feeders, dustless loading  
spouts, telescopic chutes, and  
truck, ship and railcar loadouts.  
(Owner of North American Patent  
for Cleveland Cascade® Chute.)

## Peinemann Cranes

Nieuwe Langeweg 40  
Hoogvliet  
DB 3194  
The Netherlands  
**Contact:**  
**T:** + 31 10 295 50 00  
**F:** + 31 10 295 50 49  
**E:** [kranen@peinmann.nl](mailto:kranen@peinmann.nl)  
**W:** [www.peinmann.nl](http://www.peinmann.nl)

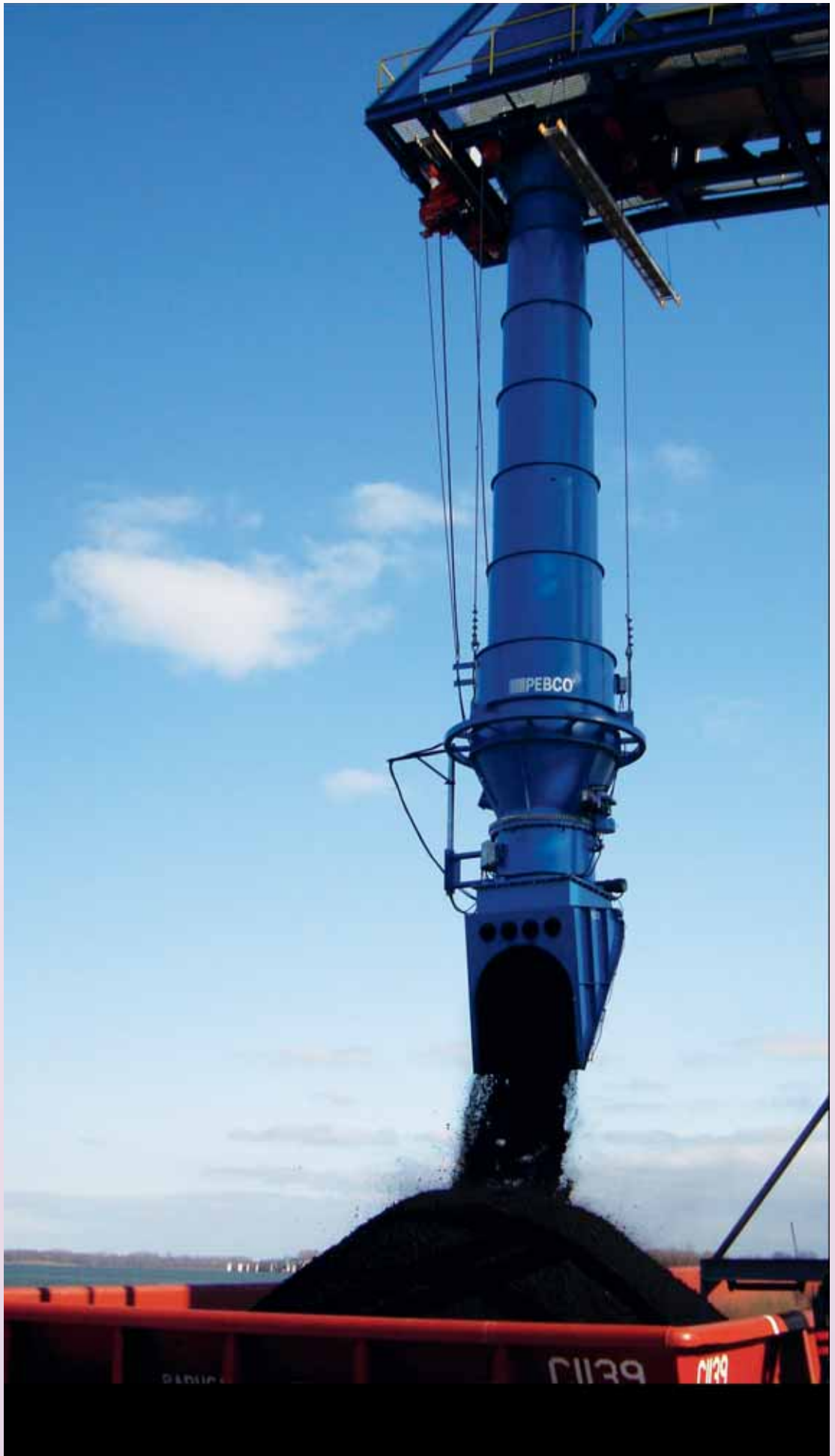



## PEINER SMAG Lifting Technologies GmbH

Windmühlenbergstrasse 20-22  
Salzgitter  
D-38259  
Germany

**Contact:** Mr Arnulf Köhnemann  
**Job Title:** Area Sales Manager  
**T:** + 49 5341 302 613  
**F:** + 49 5341 302 424 or 606  
**E:** arnulf.koehnemann@peiner-smag.com

**W:** www.peiner-smag.com  
PEINER SMAG Lifting Technologies GmbH leads the world in manufacturing grabs and other lifting accessories for cargo handling. On the basis of the proven PEINER product design, the special-purpose machinery manufacturer develops, manufactures and services lifting accessories for various industries, e.g. ports, ships, steel mills, waste-to-energy plants and recycling/scrap handling businesses.  
Peiner-smag.de

## Peterson Agricare & Bulk Logistics BV

Boompjes 270  
Rotterdam  
3011 XZ

The Netherlands  
**Contact:** Mr Arno Maehlmann

**T:** + 31 10 282 3333  
**F:** + 31 10 282 3282

**E:** info@peterson.nl

**W:** www.peterson.nl

Specialists in supply chain services for all kinds of bulk materials and

offers: inspection, gauging barges, draft surveys, bunker surveys, on/off hire surveys, stockpile control, sampling, preparation, analyses, testing and verification, bias testing of mechanical samplers and management of JIT supplies

## PetroKab LLC

P.O. Box 7  
village Lepsari, Vsevolozhsk district  
Leningrad Region  
188671

Russia

**Contact:** Mr Konstantin Apykhtin

**Job Title:** FEA manager

**T:** + 7 812 449 71 19

**F:** + 7 812 449 71 19

**E:** ak@petrokab.com

**W:** www.petrokab.com

PetroKab LLC is a manufacturer of different control cabins (such as crane cabins, shiploader/unloader cabins, stacker/reclaimer cabins, excavator cabins and etc.).

Besides, we produce E-containers/E-houses & operator control stations (chairs). PetroKab LLC can produce standard and different non-standard equipment by your designs or upon your requirements.

## Pfister Waagen Bilanciai GmbH

Linker Kreuthweg 9

Affing-Mühlhausen

D-86444

Germany

**Contact:** Ms Susanne Geller-Dürr

**Job Title:** Marketing and Sales

Manager

**T:** + 49 82 07 9 58 99 28

**F:** + 49 82 07 9 58 99 29

**E:** marketing@pfisterwaagen.de

**W:** www.pfisterwaagen.de

Suppliers of innovative, high quality, fully electronic weighing systems, incorporated in data networks, capturing and processing weighing data in cost-efficient control systems.

Truck weighbridges, railway scales, platform scales, weighing indicators, weighing data software, load cells and load cell units.

## PHB Weserhütte, S.A.

Parque Científico y Tecnológico de

Gijón

C/Ada Byron, 220

Gijón

Asturias

33203

Spain

**Contact:** Dr Jose Ramón Prado

**Job Title:** Technical Commercial

Director

**T:** + 34 984 495 640

**F:** + 34 985 134 222

**E:** joseramon.prado@pwh.es

**W:** http://en.grupotsk.com/

Engineering Company an EPC Contractor with more than 70 years of experience in material handling installations.

Working in 35 countries, with a permanent staff of 400 engineers in our home office, over 1000 in the company. Sales over 1 billion euro.

## Phelps Industries

PO Box 1093

Little Rock

Arkansas

72203

USA

**Contact:** Mr John Phelps

**Job Title:** Sales

**T:** + 1 501 375 1141

**F:** + 1 501 375 6568

**E:** jpsales@phelpsindustries.com

**W:** http://www.phelpsindustries.com

## PHOENIX Conveyor Belt Systems GmbH

Hannoversche Strasse 100

Hamburg 21079

Germany

**Contact:** Mr Danny Slonka

**T:** + 49 40 7667 03

**F:** + 49 40 7667 2413

**E:** info@phoenix-cbs.com

**W:** www.phoenix-conveyorbelts.com

PHOENIX serves the worldwide bulk handling industry with textile and steel cord conveyor belts.

Technological masterpieces in combination with 110 years of experience in conveyor belt production make PHOENIX conveyor belts the first choice for highest reliability and performance.

## Phoenix Terminal Solutions

8711 West Port Avenue

Milwaukee

WI

53224

USA

**Contact:** Ms Melissa Stephany

**Job Title:** Marketing Manager

**T:** + 1 414 973 3320

**E:** mstephany@

phoenixproducts.com

**W:** www.phoenixterminalsolutions.

com

Phoenix Terminal Solutions is the industry's first and only global sales agency exclusively serving global container, intermodal and bulk terminals. We deliver safety, operational and environmental benefits to terminals worldwide.

## PINTSCH BUBENZER GmbH



Friedrichshüttenstraße 1

Kirchen-Wehbach

RLP

57548

Germany

**Contact:** Mr Oliver Wagner

**Job Title:** Export Sales Manager

**T:** + 49 2741 9488 432

**F:** + 49 2741 9488 44

**E:** oliver.wagner@

pintschbubenzler.de

**W:** www.pintschbubenzler.de

PINTSCH BUBENZER is focused on the design, production and service of high quality braking systems for both static and dynamic applications which involve the precise control of small to very large amounts of kinetic energy. The challenge is to control that energy in the most efficient, cost-effective way.



## PURE BRAKING PERFORMANCE

MADE IN GERMANY

BUEL® thrusters have been developed on the basis of decades of experience in drive technology and its components. Highest quality standards in all operating divisions of PINTSCH BUBENZER are the foundation for the functional safety of BUEL® thrusters. With regard to applications and operational capability, there are nearly no limits. The primary purpose is the use as the brake release thruster on industrial drum and disc brakes.



## Pirs SAS

ZI St Hermentaire  
309, Avenue de l'Europe  
Draguignan  
Var  
83300  
France  
**Contact:** Mr Fikri El Mourabet  
**Job Title:** International Sales Manager  
T: + 33 4 98 10 6767  
F: + 33 4 98 10 6768  
E: info@domepirs.com  
W: www.domepirs.com  
Storage solutions for dry bulk commodities.

## PIV Drives GmbH — a Brevini Power Transmission Co.

Justus-von-Liebig-Straße 3  
Bad Homburg  
D-61352  
Germany  
**Contact:** Mr Christoph Höhr  
**Job Title:** Director Sales Germany  
T: + 49 6172 102 450  
F: + 49 6172 102 8807  
E: Christoph.Hoehr@brevini.com  
W: www.piv-drives.com or www.brevini.com  
PIV Drives, a company of Brevini Power Transmission, has over 80 years experience in providing quality power transmission solutions for every industry sector. PIV Drives developed modular concepts for its comprehensive product range, providing the flexibility to deliver high-quality optimised solutions, both standard and bespoke, quickly and at competitive cost.

## Plastruct-Polyzone

4305 Springcreek Road  
Vineland  
Ontario  
L0R 2C0  
Canada  
**Contact:** Mr Nick Koppelaar  
**Job Title:** CEO  
T: + 1 905 563 4000  
F: + 1 905 563 0228  
E: nick@polyzone.com  
W: www.polyzone.com  
Designer, manufacturer and professional installer of lining systems for the toughest bulk material flow issues for hoppers, bins, conveying, classifiers chutes, fluidizing beds. Specialists in providing flow, abrasion, impact and corrosion solutions for bulk solids.

## PLM Cranes B.V.

Sluisweg 21-25  
Heijningen  
4794 SW  
The Netherlands  
**Contact:** Mr Pieter Pulleman  
**Job Title:** Managing Director  
T: + 31 167 528510  
F: + 31 167 524444  
E: info@plmcranes.com  
W: www.plmcranes.com  
We build hydraulic and electric cranes from 50 to 2000 tm with a transhipment capacity up to approx. 2000 ton/hour. We are specialized in shipboard cranes, mobile cranes and harbour cranes for dredging, transshipping, hoisting and pile-driving.

## PMC Projects (India) Pvt. Ltd.

'Infrastructure House'  
Shrimali Society  
Beside Shikhar Complex

Navrangpura  
Ahmedabad  
Gujarat.  
380 009  
India  
**Contact:** Mr Chirayu Pandya  
**Job Title:** Sr. Manager-Projects  
T: + 91 79 2555 5868  
F: + 91 79 2555 5603  
E: chirayu.pandya@pmcprojects.com

## Pneumat Systems Inc

110 Mohr Dr  
Mankato  
MN  
56001  
USA  
**Contact:** Mr Sam Cebula  
**Job Title:** Sales and Marketing Manager  
T: + 1 507 345 4553  
F: + 1 507 345 3639  
E: info@pneumat.com  
W: http://pneumat.com/

## Polymer Industries - Ultrapoly Division

2404 Center Street  
Tacoma  
WA  
98409-7638  
USA  
**Contact:** Mr Bryan Olin  
T: + 1 253 272 1217  
F: + 1 253 272 1457  
E: bryan.olin@polymerindustries.com  
W: www.polymerindustries.com  
Tough, self-lubricating Ultra Poly Ultra High Molecular Weight polyethylene provides durable protection for metal surfaces and eliminates noise associated with metal-on-metal contact. And its slick, nonstick properties assure unimpeded flow of materials, even under wet, sticky or freezing conditions.

## Port Contractors

529 Terminal Ave  
New Castle  
DE  
19720  
USA  
**Contact:** Mr Tony Develli  
**Job Title:** VP Commercial  
T: + 1 704 756 6793  
E: tdevelli@portcontractors.com  
W: www.portcontractors.com

## Portasilo Ltd

New Lane  
Huntington  
York  
YO3 9PR  
UK  
**Contact:** Mr Fin Farrelly  
T: + 44 1904 624 872  
F: + 44 1904 611 760  
E: bulk@portasilo.co.uk  
W: www.portasilo.co.uk  
The Bulk Handling Division manufactures a range of silo discharge products, including 'Rotoflo', 'VibroFlo', 'Osciflo' and 'Augerflo' discharge valves as 'SiloFlo' aeration devices

## Portpack UK Limited

Unit A2/G11 Enterprise Business Park  
Wigwam Lane  
Hucknall  
Nottinghamshire  
NG15 7SZ  
UK  
**Contact:** Ms Sharon Henson  
**Job Title:** General Manager  
T: + 44 1159 680130  
F: + 44 1159 641926

E: portpack@portpack.biz  
W: www.portpack.biz  
For over a decade Portpack UK Limited have provided solutions for direct discharge operations in Ports throughout the world. Portpack specialise in the design and manufacture of containerised mobile bagging systems.

## Portside Solutions Pty Ltd

22 Nichols Street  
Surry Hills  
Sydney  
2010  
Australia  
**Contact:** Mr Ray Lee  
**Job Title:** Managing Director  
T: + 61 407 663 132  
E: rayl@portsidesolutions.com.au  
W: http://portsidesolutions.com.au/

## Port-Trade AS

Karelmagervej 9  
Fredericia  
DK 7000  
Denmark  
**Contact:** Mr Peter J Muller  
**Job Title:** Managing Director  
T: + 45 7628 0102  
F: + 45 7628 0103  
E: peter.muller@port-trade.com  
W: www.port-trade.com  
Port-Trade is a Danish company with more than thirty years of experience with cargo handling systems, including mobile harbor cranes, container spreaders, bulk handling grabs, and loading equipment. Port-Trade provides analyses of customer requirements and proposes and delivers complete equipment solutions.

## Powerscreen

200 Coalisland Road  
Dungannon  
County Tyrone  
BT71 4DR  
Northern Ireland  
**Contact:** Mrs Dearbaile  
Mulholland  
**Job Title:** Marketing  
T: + 44 288 77 18500  
F: + 44 288 77 47231  
E: sales@powerscreen.com  
W: www.powerscreen.com

## Powertex Inc

1 Lincoln Boulevard  
Rouses Point  
New York  
New York  
12979  
USA  
**Contact:** Mr Stephen Podd  
**Job Title:** President and CEO  
T: + 1 518 297 4000  
F: + 1 518 297 2634  
E: stephenpodd@powertex.com  
W: www.powertex.com  
Manufacturer:  
Seabulk liners for 20' and 40' ocean containers, using woven, virgin grade PE film, and foil for moisture sensitive products, aeration and fluidizing liners for stubborn flowing products. Manufacturing facilities in U.S., China and India.

## Precia-Molen Nederland BV

Frans Akker 1  
Breda  
4824 AL  
The Netherlands  
**Contact:** Mr Frédéric Felten  
**Job Title:** Export Manager

T: + 31 76 524 2510  
F: + 31 76 522 8039  
E: export@preciamolen.nl  
W: www.preciamolen.nl  
Has provided weighing solutions to industry for more than 147 years. World wide reputation for quality and reliability. After-sales service and preventative maintenance programmes ensure customers have complete confidence in the accuracy and reliability of installations.

## Precia-Molen UK Ltd

Walkers Road  
North Moons Moat  
Redditch  
Worcs  
B98 9HE  
UK  
**Contact:** Mr John Swinburne  
**Job Title:** Managing Director  
T: + 44 1527 590 300  
E: john.swinburne@preciamolen.co.uk

## Premier Tech Chronos

1, avenue Premier  
Premier Tech Campus  
Rivière-du-Loup  
Québec  
G5R 6C1  
Canada  
**Contact:** Ms Marie-Pier Vallée  
**Job Title:** Communications Coordinator  
T: + 1 418 868 8324  
F: + 1 418 862 6642  
E: valm2@premiertech.com  
W: http://www.ptchronos.com/  
PREMIER TECH CHRONOS is recognized worldwide as a leader in flexible industrial packaging equipment. Premier Tech Chronos offers complete bag packaging solutions for a wide range of materials. Our unrivaled solutions in packaging equipment can greatly increase your efficiency and your production rate while reducing your costs.

## Premier Tech Chronos b.v.

Meerheide 40  
Eersel  
Noord Brabant  
5521 DZ  
The Netherlands  
**Contact:** Mr Robert Vet  
**Job Title:** Marketing Representative  
T: + 31 497514988  
E: vetr@premiertech.com  
W: www.ptchronos.com  
Chronos BTH supply bulk weighers and controllers for intake / outloading free-flowing bulk materials. Complimenting these is a range of material handling, bagging and palletising systems, and the Containerpak™ mobile bagging unit. Chronos BTH incorporates Richard Simon, BTH, Verville and Premier Tech Systems for European spares, refurbishments, service, installation / commissioning.

## Premier Tech Chronos GmbH

Löhestrasse 18  
Hennef  
53773  
Germany  
**Contact:** Mr Robert Oster  
**Job Title:** Geschäftsführer  
T: + 49 2242 9335 0  
F: + 49 2242 9335 186  
E: info-eu@ptchronos.com  
W: www.ptchronos.com

Chronos BTH supply bulk weighers and controllers for intake / outloading free-flowing bulk materials. Complimenting these is a range of material handling, bagging and palletising systems, and the Containerpak mobile bagging unit. Chronos BTH incorporates Richard Simon, BTH, Verville and Premier Tech Systems for European spares, refurbishments, service, installation / commissioning.

## Premier Tech Chronos Ltd

Unit 1, Centurion Business Centre  
Blenheim Industrial Estate  
Nottingham  
Notts  
NG6 8WN  
UK  
**Contact:** Mr Mike Simmonds  
**Job Title:** Sales Director  
T: + 44 115 935 1351  
F: + 44 115 960 6941  
E: info-eu@ptchronos.com  
W: www.ptchronos.com  
Chronos BTH supply bulk weighers and controllers for intake / outloading free-flowing bulk materials. Complimenting these is a range of material handling, bagging and palletising systems, and the Containerpak mobile bagging unit. Chronos BTH incorporates Richard Simon, BTH, Verville and Premier Tech Systems for European spares, refurbishments, service, installation / commissioning.

## Primasonics International Limited

North Lakes Business Park  
Flusco  
Penrith  
Cumbria  
CA11 0JG  
UK  
**Contact:** Mr Donald Cameron  
**Job Title:** Managing Director  
T: + 44 17684 80372  
F: + 44 17684 80374  
E: sound@primasonics.com  
W: www.primasonics.com;  
www.quattrosonics.com  
Acoustic cleaners and silo cleaning systems.

## Procon Engineering Limited

Vestry Estate  
Oxford Road  
Sevenoaks  
Kent  
TN14 5EL  
UK  
**Contact:** Mr Brian Sangster  
**Job Title:** Sales Manager - Beltweighers  
T: + 44 1732 781 300  
F: + 44 1732 781 311  
E: joe.naylor@proconeng.com  
W: www.proconeng.com

## Protan International

PO Box 420  
Brakerøya  
Drammen  
NO-3002  
Norway  
**Contact:** Mr Erik Øyno  
**Job Title:** Direktor Protan International Roofing  
T: + 47 90 51 30 72  
E: erik.oyno@protan.no  
W: www.protan.no



## PSTek LLC

Thorwesten Vent GmbH  
2409 Traci Drive  
Pittsburgh  
PA  
15237  
USA  
**Contact:** Mr Scott Larkin  
**T:** + 1 412 366 6303  
**F:** + 1 412 366 6303  
**E:** Scott.Larkin@aol.com  
**W:** www.thorwesten.com  
PSTek is the exclusive US and Canadian sales representative and aftermarket service provider for Thorwesten Vent of Beckum, Germany.

## PT Armada Rock Karunia Transshipment

Menara Standard Chartered 9th Floor  
Jl. Prof. Dr. Satrio No. 164  
Jakarta  
12930  
Indonesia  
**Contact:** Ms Paula Anselmi  
**Job Title:** Marketing Executive  
**T:** + 62 812 9177 7342  
**F:** + 62 21 2553 2554  
**E:** enquiry@ark-transshipment.com  
**W:** www.ark-transshipment.com

## PT Bajra Mandalasakti

Graha Mobilis, 2nd Floor  
Jl. Buncit Raya No. 139  
Jakarta  
Selatan 12075  
Indonesia  
**Contact:**  
**T:** + 62 21 799 1323  
**F:** + 62 21 799 1308  
**E:** enquiries@ptbms.net  
**W:** www.ptbms.net

## PT Bukaka Teknik Utama

Jl. Raya Bekasi Narogong Km 19.5 Cileungsi Bogor  
Jakarta  
16820  
Indonesia  
**Contact:** Mr Achmad Kalla  
**Job Title:** Director  
**T:** + 62 21 823 1146  
**F:** + 62 21 823 2323  
**E:** bdv@bukaka.com  
**W:** www.bukaka.com

## PT Carsurin

Wisma 77 Tower 2  
Jl. Letjen S. Parman Kav. 77  
Slipi  
Jakarta  
DKI Jakarta  
11410  
Indonesia  
**Contact:** Mr Hal Loevy  
**Job Title:** Director Corporate Strategy & Business Development  
**T:** + 62 21 2967 5868  
**F:** + 62 21 2967 5818  
**E:** headoffice@carsurin.com  
**W:** www.carsurin.com  
PT CARSURIN provides independent third party Inspection, Testing and Verification services to mitigate risk for our domestic and international clients. For over 48 years, we have been delivering Quality Solutions with Integrity to a broad range of industries, including: Coal, Minerals and Metals, Maritime and Offshore, Industrial Equipment, and Food and Agricultural Commodities. We are the only independent Indonesian company accepted as a member of the International Federation of Inspection Agencies and the sole Lloyd's Agent in Indonesia.

## PT CCIC Jakarta

Menara Citicon  
Jl. Letjen S. Parman Kav. 72  
Lantai 10, Suite E-F  
Slipi  
Jakarta  
11410  
Indonesia  
**Contact:** Mr Eddy Kristianto  
**Job Title:** Assistant Marketing Manager  
**T:** + 62 21 2930 8911/22  
**F:** + 62 21 28930 8933  
**E:** eddykristianto@ccicsg.com  
**W:** www.ccicsg.com

## PT Geoservices

Jl. Setiabudi 79-81  
Bandung  
West Java  
40291  
Indonesia  
**Contact:** Mr Peter Pramana  
**Job Title:** + 62 22 203 1316  
**T:** + 62 22 203 5433  
**E:** jktbranch@geoservices.co.id  
**W:** www.geoservices.co.id

## PT Jakarta Prima Cranes

Wisma JPC  
Jl. Mampang Prapatan Raya No. 20  
Jakarta  
12760  
Indonesia  
**Contact:** Mr Tony Haryono  
**Job Title:** Branch Manager  
**T:** + 62 21 799 2772  
**F:** + 62 21 799 2442  
**E:** edy-sianturi@jpc.co.id  
**W:** www.jpc.co.id

## PT MacGregor Indonesia

hanurata Graha 5th Floor  
Jl. Kebon Sirih No. 67-69  
Jakarta  
10340  
Indonesia  
**Contact:** Mr Hengky Saputra  
**Job Title:** Area Marketing Manager, Marine & Offshore  
**T:** + 62 21 319 27746  
**F:** + 62 21 319 27746  
**E:** hengky.saputra@macgregor.com  
**W:** www.macgregor.com

## PT Mitra Bahtera Segarasejati

Menara Karya 12th Floor  
JI H R Rasuna Said Block X-5  
Kav 1-2 Kuningan  
Jakarta  
12950  
Indonesia  
**Contact:** Mr Ferdinand Mapaye  
**Job Title:** Deputy Marketing Director  
**T:** + 62 21 5794 4755  
**F:** + 62 21 5794 4767  
**E:** ferdinand.mapaye@mbss.co.id  
**W:** www.mbss.co.id

## PT Pamapersada Nusantara

Jln. Rawagelam I No. 9  
Kawasan Industri Pulogadung  
Jakarta  
13930  
Indonesia  
**Contact:** Mr. Sudiarso Prasetyo  
**Job Title:** President Director  
**T:** + 62 21 460 2015 Ext 211  
**F:** + 62 21 460 1916  
**E:** busdev@pamapersada.com  
**W:** www.pamapersada.com

## PT SpanSet Indonesia

Jl. Marunda Center Blok F No.20  
Segara Makmur  
Tarumajaya

Bekasi  
Jawa Barat  
14350  
Indonesia  
**Contact:** Mr Mario Harben  
**Job Title:** Business Development Manager  
**T:** + 62 21 28510077  
**F:** + 62 21 28510088  
**E:** sales@spanset.co.id  
**W:** www.spanset.co.id

## PT Thiess Contractors Indonesia

Ratu Prabu 2  
Ratu Prabu 2  
Jl. TB. Simatupang Kav. 18  
Jakarta  
12560  
Indonesia  
**Contact:** Mr. Matahara  
**Job Title:** Business Development Manager  
**T:** + 62 21 2754 9999  
**F:** + 62 21 2754 9800  
**E:** thiess@thiess.co.id  
**W:** www.thiess.co.id

## PT Trans Power Marine Tbk

Artha Graha Building  
20th Floor Suite#20-01  
SCBD, Jl. Jendral Sudirman Kav 52-53  
Jakarta  
Jakarta  
12190  
Indonesia  
**Contact:** Mr Ronny Kurniawan  
**Job Title:** Vice President Commissioner  
**T:** + 62 215 155 551  
**F:** + 62 215 153 385  
**E:** info@tp-tm.com  
**W:** www.transpowermarine.com

## PT. Anugrah Lautan Luas

Jl Raya pahlawan Seribu  
Golden Boulevard 2 Blok O No. 5-6  
BSD City  
Serpong  
15321  
Indonesia  
**Contact:** Mr Teddy Saoutra  
**Job Title:** Operation Executive  
**T:** + 62 21 5316 4382  
**E:** teddy@anugrahlautanluas.com  
**W:** www.anugrahlautanluas.com/

## PT. Bando Indonesia

Wisma Hayam Wuruk, 6th floor,  
Suite 600  
Jln. Hayam Wuruk No. 8  
Jakarta  
10120  
Indonesia  
**Contact:** Mr Wahyono Wardiman  
**Job Title:** Conveyor Belt Division  
**T:** + 62 21 3517590  
**F:** + 62 21 3517591  
**E:** conveyor.div@bandoindonesia.com  
**W:** www.bandoindonesia.com  
PT. Bando, established in 1987, is one of the leading automotive and industrial power transmission belt manufacturers in Indonesia. It has one main plant located in Tangerang and its marketing office located in Central Jakarta.

## PT. Meratus Advance Maritim

Wisma Raharja 6th floor, zone C  
Jl. TB Simatupang Kav.01, Cilandak  
Jakarta  
12560  
Indonesia  
**Contact:** Ms Katherine The  
**Job Title:** Commercial Manager

**T:** + 62 21 781 4568  
**F:** + 62 21 781 4572  
**E:** info@mdm.co.id  
**W:** http://www.mdm.co.id/

## PT. Thermalindo Sarana Laboratoria

Jl. Daan Mogot II No. 100J  
Jakarta  
11510  
Indonesia  
**Contact:** Mr Eduard Sasmita  
**Job Title:** Branch Manager  
**T:** + 62 21 566 3057  
**F:** + 62 21 566 2795  
**E:** edo@thermalindo.com  
**W:** http://www.thermalindo.com/

## PT. Winning Logistik Indonesia

The Belleza Permata Hijau  
Gapura Prima Office Tower 22nd Floor  
Jl. Letjen Soepono No.34  
Arteri Permata Hijau  
Jakarta  
12210  
Indonesia  
**Contact:** Mr Aninda Putri  
**Job Title:** Senior Commercial Executive  
**T:** + 62 21 2991 6084  
**F:** + 62 21 3048 5511  
**E:** anindaauli Putri@winninglogistic.com  
**W:** www.winninggroup.com.sg/

## Qingdao Huaxia Rubber Industry Co. Ltd.

No.146, Chengma Road  
Tongji District  
Jimo  
Qingdao  
Shandong  
266228  
China  
**Contact:** Mrs Molly Shi  
**Job Title:** Sales Manager  
**T:** + 86 137 8985 9616  
**F:** + 86 532 8251 9238  
**E:** conveyorbelt@huaxiarubber.cn, molly.shi@huaxiarubber.cn  
**W:** www.huaxiarubber.cn  
HUAXIA RUBBER is listed in the top three Chinese conveyor belt manufacture, exported to more than 60 countries and areas. World widely used in tunneling, mining, steel works, metallurgy, terminal, power station, etc, with first class quality and competitive price, famous project is CARAJAS S11D/VALE-Brazil, Trekkopje pioneers/ Namibia.

## Quadrant Engineering Plastics Products

2120 Fairmont Avenue  
Reading  
PA  
19612  
USA  
**Contact:** Mr Ron Mesing  
**Job Title:** Project Development Manager  
**T:** + 1 412 384 5592  
**F:** + 1 412 384 8910  
**E:** ron.mesing@qplas.com  
**W:** www.systemtivar.com  
For more than 30 years Quadrant's SystemTIVAR Engineering Group has been providing flow, abrasion, impact and corrosion solutions in the field of bulk material handling using TIVAR 88 to line a wide array of process equipment including ship holds, bins, bunkers, silos, chutes, railcars, off-road trucks, on-road trucks, etc.

## Quadrant EPP

2710 American Way  
Fort Wayne  
IN  
46809  
USA  
**Contact:** Mr Bradley Seibt  
**Job Title:** Project Development Manager  
**T:** + 1 260 479 4335  
**F:** + 1 260 478 1074  
**E:** bradley.seibt@qplas.com  
**W:** www.quadrantplastics.com  
Polymer lining systems to solve bulk material handling flow problems. TIVAR 88 polymer liners are the perfect solution to reduce or eliminate arching, ratholing, and erratic material flow challenges in bins, bunkers, hoppers, or railcars.

## Quadrant PHS

Woodhouse Road  
Tadmorden  
Lancs  
OL14 5TP  
UK  
**Contact:** Mr Dave Liveoy  
**Job Title:** Logistics Department  
**T:** + 44 1706 811 000  
**F:** + 44 1706 817 571  
**E:** dave.liveoy@qplas.com  
**W:** www.polyhsolidur.com

## Quality Handling Systems Pty Ltd

6 Metters Place  
Wetherill Park  
Sydney  
NSW  
2164  
Australia  
**Contact:** Mr Peter Taylor  
**Job Title:** Project Manager  
**T:** + 61 2 9756 1921  
**F:** + 61 2 9756 4212  
**E:** ptaylor@qhs.com.au  
**W:** www.qhs.com.au  
Quality Handling Systems Pty Ltd (QHS) is an Australian company specialising in the design and manufacture of sampling systems for bulk materials. QHS have experience with sampling a wide range of materials using the various international standards.

## Qube Ports & Bulk

Level 22  
44 Market Street  
Sydney  
NSW  
2000  
Australia  
**Contact:** Mr Paul White  
**Job Title:** Media  
**T:** + 61 2 9005 1100  
**F:** + 61 2 9005 1101  
**E:** paul.white@qube.com.au  
**W:** www.qube.com.au/ports-and-bulk

## R & S S.r.l.

Via del Cmapo Sportiuo 40  
Mezzana  
48123  
Italy  
**Contact:** Mr Michael Grass  
**Job Title:** Marketing Communications Manager  
**T:** + 39 0535 61 81 11  
**F:** + 39 0544 41 10 99  
**E:** Michael.Grass@wamgroup.com  
**W:** www.roncuzzi.com  
A great piece of Italian history and tradition combined with the most accurate and innovative engineering in bulk handling and movimentation.

# RBL REI BULK UNDER CONTROL MULTI-BULK HOPPER

GENERAL CHARACTERISTIC		
Util capacity	35m <sup>3</sup>	100m <sup>3</sup>
Feeding height without dedusting filters or with spraying	10m	11.5m
Feeding height with dedusting filters	12m	13m
Opening diameter without dedusting filters or with spraying	7m	9.5m
Opening diameter with dedusting filters	5.5m	8m

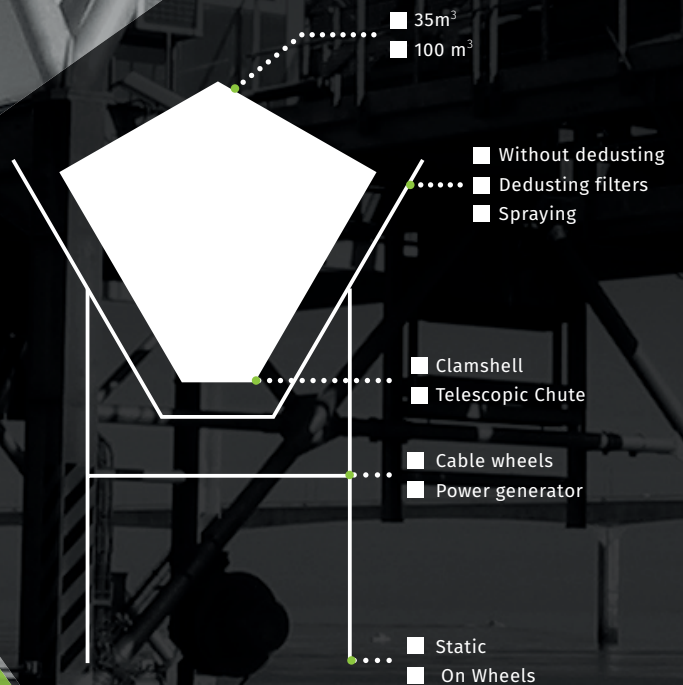

DEDUSTING FILTERS



SPRAYING



TELESCOPIC CHUTE



CLAMSHELL



POWER GENERATOR



ON WHEELS

Questionnaire to be return at : [contact@rblrei-france.com](mailto:contact@rblrei-france.com)  
Please specify products to be handled  
For other dimensions, contact us.



## RBL-REI | ANGERS

15 rue du Moulin des Landes  
CS 50159 Saint Sylvain d'Anjou  
49481 Verrières en Anjou Cedex  
T : +33 (0)2 41 21 19 40  
F : +33 (0)2 41 21 19 59  
[contact@rblrei-france.com](mailto:contact@rblrei-france.com)

## RBL-REI | PARIS

11, boulevard Brune  
75682 PARIS Cedex 14  
T : +33 (0)1 53 90 22 40  
F : +33 (0)1 53 90 22 24



Follow us on > [LinkedIn](#) > [YouTube](#)





**RAM SMAG Lifting Technologies**

6 Selby Place  
Stanley  
Skelmersdale  
Lancashire  
WN8 8EF  
UK  
**Contact:** Mr Patrick Draper  
**Job Title:** PR & Communication  
**T:** + 44 1695 556355  
**F:** + 44 1695 556356  
**E:** p.draper@ramspreaders.com  
**W:** www.ramspreaders.com/  
RAM Spreaders, one of the leading manufacturers and suppliers of container handling equipment for over 40 years have developed their environmental friendly RAM Revolver® for dust free containerized bulk handling solutions in association with specialist container suppliers.

**RAP Conveyors Ltd**

Conveyor House  
Turner Crescent  
Loomer Road Industrial Estate  
Chesterton  
Newcastle  
Staffordshire  
ST7 7LU  
UK  
**Contact:** Mr David Southern  
**Job Title:** Managing Director  
**T:** + 44 1782 566440  
**F:** + 44 1782 566835  
**E:** info@rapconveyors.co.uk  
**W:** www.rapconveyors.co.uk  
Supplies a wide range of conveyor belting, including the complete range of 'Starflex', 'Belahete',

'Starhete', 'Deltahete' and 'FRCDM' oil-resistant and chevron belting from Fenner Dunlop Belting.

**Rapat Asia**

Clark, Philippines  
Angeles  
Pamapaga  
061  
Philippines  
**Contact:** Mr Craig Stall  
**Job Title:** General Manager  
**T:** + 1 2182514261  
**F:** + 1 2184833344  
**E:** cstall@rapat.com  
**W:** www.rapat.com

**Rapat Corporation**

919 O'Donnell Street  
Hawley  
MN  
56549-4310  
USA  
**Contact:** Mr Ron Werner  
**Job Title:** General Manager  
**T:** + 1 218 483 3344  
**F:** + 1 218 483 3535  
**E:** info@rapat.com  
**W:** http://www.rapat.com/

**Rapidpack Corporation**

Suite 207  
Mazaya Tower AA1  
Jameirah Lakes Towers  
Dubai  
UAE  
**Contact:** Mr Peter Ascot  
**Job Title:** Sales Manager  
**T:** + 9714 445 8336  
**F:** + 9714 445 8337  
**E:** peter@rapidpack.ca  
**W:** www.rapidpack.ca

Rapidpack designs, engineers and manufactures mobile bulk bagging machines, grabs, ship loaders and ancillary equipment for cargo handling in port and/or inland departments. Our clients include leading trading houses and shipping companies around the world.

**RBL-REI France**



11 Boulevard Brune  
Paris  
Cedex 14  
75682  
France  
**Contact:** Mr Sébastien Bouhours  
**Job Title:** Technical Sales Representative  
**T:** + 33 2 41 21 3670  
**F:** + 33 2 41 21 19 59  
**E:** s.bouhours@rbirei-france.com  
**W:** www.rbirei-france.com  
A merger between two French companies specialised in bulk handling equipment. RBL - a leader in handling equipment. REI - known worldwide for its expertise in long-distance and curved conveyors. REI is also specialised in conveyors fitted with belt storage for tunnel excavation.

**RC Inspection B.V**

Gustoweg 66  
Rotterdam  
NL 3029  
The Netherlands  
**Contact:** Mr Kees Maarschalkerweerd  
**T:** + 31 10 4250240  
**E:** kees.maarschalkerweerd@rc-inspection.com  
**W:** www.rc-inspection.com/  
An independent, privately owned inspection company operating in the field of dry bulk commodities, metals and marine survey related services. Main operational centers in Rotterdam, Johannesburg and Hong Kong, with office and field staff operating in more than 40 countries. We provide an independent, fast and reliable service with a direct people to people approach.

**RDS Technology (Topcon Technology Ltd)**

Cirencester Road  
Minchinhampton  
Stroud  
Gloucestershire GL6 9BH  
UK  
**Contact:** Mr Mark Evans  
**Job Title:** Business Development Manager  
**T:** + 44 1453 733300  
**F:** + 44 1453 733311  
**E:** C.Mattiolo@rdstec.com  
**W:** www.rdstec.com  
RDS Technology specialises in designing and manufacturing a wide range of on-board weighing systems to suit any application.

Products include the new LOADEX 100 excavator bucket scale, the LOADMASTER α 100 for wheeled loaders and the WEIGHLOG α10 for compact loaders/ telehandlers.

**Redaelli Teca S.p.a.**

Via Volta,16  
Cologno Monzese  
Milano 20093  
Italy  
**Contact:** Mr Emanuele Cortesi  
**Job Title:** Sales Representative  
**T:** + 39 02 253 07219  
**F:** + 39 02 253 07212  
**E:** emanuele.cortesi@redaelli.com  
**W:** http://www.redaelli.com/

**REEL Alesa Ltd**



Max Hogger-Strasse 6  
Zurich  
CH - 8048  
Switzerland  
**Contact:** Mr Hanspeter Stahl  
**Job Title:** General Manager  
**T:** + 41 44 435 33 33  
**F:** + 41 44 435 33 66  
**E:** hanspeter.stahl@reel-alesa.com  
**W:** http://www.reel-alesa.com/  
Specialized in supplying complete material handling systems including pneumatic unloaders and dense phase conveyors for alumina, cement, chemicals, powders, grain, petroleum coke, rock phosphate and granular materials.



The  
market's  
choice



## From port to pot

At **REEL ALESA** we deliver fully integrated materials handling solutions that will optimise your processes and performance.

[www.reel-alesa.com](http://www.reel-alesa.com)

### Switzerland

T +41 44 435 33 33  
Infoswiss@reel-alesa.com

### France

T +33 4 42 99 36 49  
Infofrance@reel-alesa.com

### Canada

T +1 514 937 91 05  
Infocanada@reel-alesa.com

### Australia

T +61 3 97 69 26 46  
sales@birrus.com.au





## REEL Alesa Ltd



150 Rockland Rd  
Town of Mount Royal  
Quebec  
H3P 2V9  
Canada  
**Contact:** Mr Jean-Pierre  
Desmoulins  
**Job Title:** General Manager  
**T:** + 1 514 937 9105 ext. 2231  
**F:** + 1 514 937 0473  
**E:** jean-pierre.desmoulins@reel-alesa.com  
**W:** www.rta-alesa.com

At RTA Alesa, we go beyond simply conveying materials. We provide fully integrated material handling solutions that optimize your processes and performance. We specialize in a broad range of technologies for handling bulk materials. From feasibility studies to turnkey projects; our team of experienced specialists completely covers all aspects of any sized project.

## REMA TIP TOP AG

Gruber Straße 65  
Poing  
Bavaria  
D-85586  
Germany  
**Contact:**

**T:** + 49 8121 707 10100  
**F:** + 49 8121 707 10349  
**E:** info@rema-tiptop.com  
**W:** www.rema-tiptop.com

REMA TIP TOP Industrie claims to be the world leader in high -quality conveyor maintenance, wear protection and corrosion protection. With a worldwide service network of more than 190 partners and 15 subsidiaries very close relationships can be maintained

with customers.

## Renby Ltd

Tarvin Mill  
Barrow Lane  
Tarvin  
Chester  
CH3 8JF  
UK

**Contact:** Mr Robin Travis  
**T:** + 44 1829 741009  
**F:** + 44 1829 740 574  
**E:** info@renby.co.uk  
**W:** www.renby.co.uk

Specialist in dust contained and dust tight conveying in particular a range of dust tight conveyors. Also the home of MicronFog(TM) fogging systems for dust suppression, odour control and humidification. UK and Ireland agents for Schrage Rohrketten-system GmbH, (tube chain conveyors); Spiro BV (Static moving floors).

## Representaciones Alfredo Brand y Cia. Ltda.

Casilla 16871  
Santiago  
Región Metropolitana  
7510147  
Chile

**Contact:** Mr Alfredo Brand  
**T:** + 56 222 38968  
**F:** + 56 234 40817  
**E:** abrandp.gm@gmail.com  
**W:** www.abrandp.com

## Rexnord Industries Inc

4800 W. Mitchell St  
Milwaukee  
WI 53214  
USA

**Contact:** Mr Ken Piper  
**T:** + 1 414 643 2365  
**F:** + 1 414 643 3725  
**E:** ken.piper@rexnord.com  
**W:** www.rexnord.com

## RHC Deutschland GmbH

Am Taennele 6  
Senden-Aufheim  
Bayern  
D-89250  
Germany

**Contact:** Mr Rolf Hofmann  
**Job Title:** CEO  
**T:** + 49 174 2050 164  
**F:** + 49 7307 253 39  
**E:** rhofmann@rhcheavymachinery.com  
**W:** http://rhcheavymachinery.com/

RHC is a company registered in Germany and Hong Kong. It also has offices in Shanghai/China and Incheon/Korea. Main customers are metallurgy, shipbuilding and ports. Core business is focused on material handling systems such as cranes, mobile carriers, ship loading and unloading systems, etc.

## RHC Heavy Machinery Ltd

China Office Shanghai  
Lane 1288, Room 2004  
Man Ma You Road  
Pudong  
Shanghai  
China

**Contact:** Mr Rolf Hofmann  
**Job Title:** Managing Director  
**T:** + 85 2 8199 7916  
**F:** + 85 2 822 62666  
**E:** info@rhcheavymachinery.com  
**W:** http://rhcheavymachinery.com/

## Richwood Industries, Inc.

PO Box 1298  
Huntington  
West Virginia  
25714-1298  
USA

**Contact:** Ms Kelley Barr  
**Job Title:** Marketing Manager  
**T:** + 1 304 525 5436  
**F:** + 1 304 525 8018  
**E:** info@richwood.com  
**W:** www.richwood.com

## Risun Technologies

357 West 6160 South  
Murray  
Utah  
84107  
USA

**Contact:** Mr Bill Whitney  
**Job Title:** Vice President, Business Development  
**T:** + 1 801 305 4241  
**F:** + 1 801 281 8787  
**E:** info@risuntech.com  
**W:** www.risuntech.com

Risun Technologies is a multi-discipline engineering firm specializing in material handling, terminal design and broad scope projects requiring innovative concepts to solve difficult problems. Specialty areas include silo design, monolithic dome storage with automated reclaim systems and control packages with system integration for projects using several different equipment vendors.

## Ritchie Bros

9500 Glenlyon Parkway  
Burnaby  
BC  
V5J 0C6  
Canada

**Contact:** Mr Adam Yee  
**T:** + 1 778 331 5318  
**F:** + 1 778 331 5501  
**E:** ayeer@rbauction.com  
**W:** www.rbauction.com

## RJS Siloclean International Ltd

Crowcroft Road Industrial Estate  
Nedging with Naughton  
Ipswich  
Suffolk  
IP7 7HR  
UK

**Contact:** Mr Jason Johnson  
**Job Title:** Marketing  
**T:** + 44 1449 740 051  
**F:** + 44 5600 767 753

**E:** info@rjssiloclean.co.uk  
**W:** www.rjssiloclean.co.uk

## RKR Gebläse und Verdichter GmbH

Braasstr. 1  
Rinteln  
31737  
Germany

**Contact:** Mr Lothar Stoll  
**T:** + 49 57 51 40 04 0  
**F:** + 49 57 51 40 04 30  
**E:** info@rkr.de  
**W:** www.rkr.de

RKR Gebläse und Verdichter GmbH is your expert partner for anything associated with blowers and compressors for oil-free air supply. A highly qualified team of engineers and technicians plans, designs, installs and tests customized compressed solutions.

## Roberts & Schaefer Company

222 South Riverside Plaza  
Chicago  
Illinois  
60606-3986  
USA

**Contact:** Mr Ike Miller  
**Job Title:** Business Development Mgr  
**T:** + 1 312 236 7292  
**F:** + 1 312 726 2872  
**E:** rs@elginindustries.com  
**W:** www.r-s.com

We are a full service engineering & construction company specializing in designing & erecting bulk material handling systems.

## Robson Handling Technology Ltd

Coleford Road  
Darnall  
Sheffield S9 5PA  
UK

**Contact:** Mr Tris Young







**MAIN FEATURES**

- Totally enclosed Drive
- Aesthetic design
- Space saving and light weight

**BENEFITS**

- Safer than exposed drives
- Smooth and out of sight
- No need for costly extras

# We move your work

**Rulmeca Motorized Pulleys:**

- the most efficient and effective drives available
- high protection rate of IP67
- low maintenance
- successful for more than 50 years

Contact your local RULMECA Company to discuss about this or other requirements for Idlers and components for bulk handling applications.



**COMPANIES AROUND THE WORLD**

**Headquarters**

RULMECA HOLDING S.P.A.  
Via A. Toscanini, 1  
I-24011 Almè (Bergamo)  
Phone: +39 035 4300 111  
Fax: +39 035 4300391  
e-mail: rulmecca@rulmecca.com

**RULMECA - EUROPE**

**Denmark**  
RULMECA A/S  
e-mail: dk@rulmecca.com

**Finland**  
RULMECA OY  
e-mail: fi@rulmecca.com

**France**  
RULMECA FRANCE S.A.S.  
e-mail: info.france@rulmecca.com

**Germany**  
RULMECA GERMANY GMBH  
Aschersleben  
e-mail: de@rulmecca.com

**Leipzig**  
e-mail: de@rulmecca.com

**Great Britain**  
RULMECA UK Ltd  
e-mail: uk@rulmecca.com

**Italy**  
RULLI RULMECA S.P.A.  
e-mail: export-it@rulmecca.com

**Spain/Portugal**  
RULMECA IBÉRICA. S.L.U.  
e-mail: espana@rulmecca.com

**Sweden**  
RULMECA A/S  
e-mail: se@rulmecca.com

**Turkey**  
RULMECA Taşıma Aksamları Tic. Ltd. Şti.  
e-mail: turkey@rulmecca.com

**RULMECA NORTH & SOUTH AMERICA**  
**Canada**  
RULMECA CANADA LIMITED  
e-mail: sales-ca@rulmecca.com

**USA**  
RULMECA CORPORATION  
e-mail: sales-us@rulmecca.com

**VENEZUELA**  
INDUSTRIAS RULMECA S.A.  
e-mail: rulmecca@rulmecca.com.ve

**RULMECA - AUSTRALIA**  
RULMECA MELCO AUSTRALIA (PTY) LTD  
e-mail: sales-au@rulmecca.com

[www.rulmecca.com](http://www.rulmecca.com)

**RULMECA - ASIA**  
**China**  
RULMECA (TIANJIN) CO. LTD  
e-mail: sales-cn@rulmecca.com

**Indonesia**  
PT. RULMECA INDONESIA  
e-mail: sales-id@rulmecca.com

**Thailand**  
RULMECA (THAILAND) CO., LTD.  
e-mail: sales-th@rulmecca.com

**RULMECA - AFRICA**  
MELCO Conveyor Equipment  
e-mail: conveyors-za@rulmecca.com





©Rulmecca.

**Job Title:** Marketing Manager  
**T:** + 44 114 244 4221  
**F:** + 44 114 243 3066  
**E:** youngt@robson.co.uk  
**W:** www.robson.co.uk  
 Robson design and manufacture in Sheffield a vast range of products to suit many industries including Belt Conveyors, Screw Conveyors, Airglide Conveyors. All can be purchased individually or as part of a full system. Robson produce standard products and bespoke designs to suit the clients needs worldwide.

### RockTree Logistics Pte. Ltd.

3 Church Street  
 #24-01/02  
 Samsung Hub  
 Singapore  
 049483  
 Singapore  
**Contact:** Mr Daniele Pratalongo  
**T:** + 65 6622 65 10  
**F:** + 65 6622 65 11  
**E:** info@rocktree.sg  
**W:** www.rocktree.sg

RockTree Logistics Pte. Ltd.  
 Designs customised logistics that manage the complete transshipment aspect of your supply chain for all dry bulk commodities. Our goal is to get your dry bulk moving on schedule, saving you time and money in the process.

### Ronin GMS

No 1 Nobel Avenue  
 Modderfontein  
 Johannesburg  
 Gauteng  
 1645  
 South Africa  
**Contact:** Mr Ferdinand Meyer  
**Job Title:** Sales and Marketing Executive, Ronin Group  
**T:** + 27 11 608 3666  
**F:** + 27 11 608 4679  
**E:** ferdi@roningms.com  
**W:** www.roningms.com  
 Ronin GMS supplies grain management system solutions, analytical grading equipment and grain handling services to the Southern African Grain Handling and Storage Industry. This

includes:  
 - real time, independent inventory measurement and management systems  
 - transactional software packages  
 - identity tracking solutions  
 - in bin temperature control, management and aeration  
 - Near Infra Red Transmittance devices for measuring protein  
 - Image Analysers for measuring specks and ash content  
 - service & support for analytical instrumentation  
 - Silo Auditing service.

### Royal Bodewes

Werkkade 22  
 Hoogezand  
 9601 LG  
 The Netherlands  
**Contact:** Mr Martijn Beunk  
**Job Title:** Business Developer  
**T:** + 31 5 9839 3131  
**F:** + 31 5 9831 6980  
**E:** m.beunk@royalbodewes.com  
**W:** www.royalbodewes.com  
 Royal Bodewes builds vessels for over 200 years. It is specialized in building multifunctional vessels in a

range 1,500 to 15,000 tonnes. Royal Bodewes is developing technically advanced vessels, such as hybrid ships, self-discharging cement carriers and LNG bunker vessels. Bodewes just delivered the self-discharging cement carriers 'Furuvik' and 'Cymbidium'.

### Royal Haskoning DHV

George Hintzenweg 85  
 Rotterdam  
 3068 AX  
 The Netherlands  
**Contact:** Ms Berte Simons  
**Job Title:** Director Advisory Group  
**T:** + 31 10 2865 398  
**F:** + 31 10 443 3688  
**E:** info@rotterdam.royalhaskoning.com  
**W:** www.royalhaskoningdhv.com/  
 Royal Haskoning harbours the knowledge and practical experience that is indispensable in the development of modern ports and (un)loading, transport and storage systems. Our services cover all stages of project development and we are dedicated to finding solutions aimed at improving and optimising our clients' business activities in the field of dry bulk handling, processing and storage.

### RUD Kettenfabrik Rieger & Dietz GmbH & Co. KG

Friedensinsel  
 Aalen Unterkochen  
 D-73432  
 Germany  
**Contact:** Mr Kai Eder  
**Job Title:** Marketing - Conveyors  
**T:** + 49 7361 504 0  
**F:** + 49 7361 504 1460  
**E:** kai.eder@rud.com  
**W:** www.RUD.de  
 With 140 years of experience and, taking round steel chains as a basis, we develop future-oriented solution concepts with chain systems and components in diverse forms and for a wide range of applications.

### RULMECA HOLDING S.P.A.



Via A Toscanini 1  
 Almé  
 Bergamo  
 24011  
 Italy  
**Contact:** Mr Carsten Spanggaard  
**Job Title:** Group Sales Director  
**T:** + 39 035 430 0111  
**F:** + 39 035 545 700  
**E:** rulmecca@rulmecca.it  
**W:** www.rulmecca.com  
 Steel rollers, heavy-duty rollers, medium- and light-duty rollers, anticorrosion rollers for salty and chemically aggressive environments; troughing and self-aligning sets manufactured according to all major international standards; garland systems with 2, 3, 4, 5 rollers employed in conveyors loading areas; idler pulleys and drums, with or without bearings for all belt widths.



### Rubb Buildings Ltd

Dukesway  
 Team Valley Trading Estate  
 Gateshead  
 Tyne & Wear  
 NE11 0QE  
 UK  
**Contact:** Mr Ian Hindmoor  
**Job Title:** Sales Manager  
**T:** + 44 191 482 2211  
**F:** + 44 191 482 2516  
**E:** info@rubb.co.uk  
**W:** www.rubb.co.uk  
 Builds warehouses, stores and workshops for the storage and handling of bulk cargo.



*SAMSON Eco Hoppers  
in operation at Jurong  
Port in Singapore.*

## SABS - Mining & Minerals

PO Box 413  
Richards Bay  
KwaZulu Natal  
3900

South Africa

**Contact:** Ms Audrey Ndlovu  
**Job Title:** Operations Manager  
**T:** + 27 35 901 1600  
**F:** + 27 35 797 7212  
**E:** ndlovua@sabs.co.za

Provides a holistic range of sampling, analytical and product certification services to the solid-fuel and mineral industries. In addition to its core values of Accredited Quality (ISO 17025), integrity, accuracy and speed, also offered is a very competitive pricing structure resulting in product samples for analysis being received from around the world.

## SAI Gulf

100 Alpha Drive  
Suite 104  
Destrehan  
LA 70047  
USA

**Contact:** Mr Tim Hale  
**Job Title:** Managing Director  
**T:** + 1 504 725 0726  
**F:** + 1 504 725 0753  
**E:** saigulf@saigulf.com

## Saiag Industria SpA

Strade Brandizzo 130  
Volpiano  
I-10088  
Italy

**Contact:** Mr Moro Marco  
**Job Title:** Sales Manager  
**T:** + 39 0 11 9822111  
**F:** + 39 0 11 9822301  
**E:** mmoro@comital.com  
**W:** www.saiag.it

## Saipem SA

1/7 Av. San Fernando  
Energies - 2A07  
Saint-Quentin-Yvelines  
Cedex  
78884  
France

**Contact:** Mr Cyril Canchon  
**Job Title:** Commercial Manager  
**T:** + 33 161 37 60 19  
**F:** + 33 161 37 88 07  
**E:** cyril.canchon@saipem-sa.com  
**W:** www.saipem-sa.com

## Sammi

Via Tuderte, 388  
Narni Scalo  
Terni  
05036  
Italy

**Contact:** Mr Daniele Bellezza  
**Job Title:** Engineer  
**T:** + 39 0744 733832  
**F:** + 39 335 5313331  
**E:** daniele.bellezza@sammi.it  
**W:** www.sammi.it

Making plant and machinery for the bulk handling industry for over 35 years, from designing to material selection, from assembly and implementation to maintenance and after-sales technical assistance. Sammi directly controls the entire business cycle and is strongly oriented towards product development and design. Our team of designers ensures continual technical innovation - a distinguishing feature of the Company.

## Sampling Associates International

22 Enterprise Parkway  
Suite 220  
Hampton  
Virginia  
23666  
USA

**Contact:** Mr Paul Reagan  
**Job Title:** President  
**T:** + 1 757 928 0484 ext 100  
**F:** + 1 757 928 0482  
**E:**

preagan@samplingassociates.com  
**W:** www.samplingassociates.com  
Sampling Associates International (SAI) specializes in the mechanical sampling of coal and petroleum coke. SAI is a major service provider to the US coal export trade with operations in all US East and Gulf Coast ports.

SAI extends its service range in the Americas through its ownership in Incolab Services.

## SAMSON Materials Handling Ltd (AUMUND Group)

**SAMSON**  
AUMUND GROUP

Gemini House  
Cambridgeshire Business Park  
1 Bartholomew's Walk  
Ely, Cambridgeshire  
CB7 4EA, UK  
**Contact:** Mr Dale Lockley  
**Job Title:** Managing Director  
**T:** + 44 1353 665001  
**F:** + 44 1353 666734  
**E:** sales@samson-mh.com  
**W:** www.samson-mh.com

SAMSON Materials Handling Ltd., a company within the AUMUND Group, is an engineering company and leading supplier of an extensive range of Mobile Stackers (Stormajor®), Shiploaders, Eco Hoppers, and Material Feeders for bulk materials reception. The SAMSON concept offers a mobile and economical alternative to conventional installations and represents a unique approach to the bulk cargo handling in ports and terminals requiring a high degree of mobility and flexibility.

## Sandvik Mining

Sandviken  
SE-81181  
Sweden

**Contact:** Mr Göran Carlbom  
**Job Title:** Sales Support Manager  
**T:** + 46 26 262000  
**F:** + 46 26 260230  
**E:** info.smc@sandvik.com  
**W:** mining.sandvik.com

Sandvik Mining and Construction is one of the leading suppliers of drilling, crushing and turn-key bulk material handling equipment using continuous material handling technologies (bucket wheel, scraper, conveyor,...) to stack, load/reclaim and haul bulk material. Integrated solutions and products

are designed to specific customer requirements and engineering, project management and operation services are offered worldwide.

## Sandvik Mining and Construction

Materials Handling GmbH & CO KG  
Vorderberger Strasse 12  
Leoben  
A-8700  
Austria

**Contact:** Mr Claus-Jürgen Butter  
**Job Title:** Product Line Manager - Mining Systems  
**T:** + 43 3842 2077 331  
**F:** + 43 3842 2077 201  
**E:** claus.butter@sandvik.com  
**W:** www.alpine-mining.com

A leading global supplier in continuous mining and bulk materials handling in stockyards and ports, offering a wide range of equipment for mechanical excavation and conveying. Other equipment includes: Bucket wheel excavators, Beltwagons, Spreaders, Fully- and semi-mobile crushing plants, Stationary crushing plants, Transport crawlers.

## Sandvik Mining and Construction (China) Co., Ltd.

No.986, Baota Rd  
Jiading District  
Shanghai  
201821  
China

**Contact:** Mr Zhang Jianyuan  
**Job Title:** Vice President, Surface Mining  
**T:** + 86 21 6916 6050  
**F:** + 86 21 6916 6025  
**E:** jianyuan.zhang@sandvik.com  
**W:** www.sandvik.com

## SANWA COMMERCIAL CO., LTD.

13-20 Irieoka - cho, Shimizu - ku,  
Shizuoka - city  
Shizuoka  
424-0839  
Japan

**Contact:** Mr Masao Butsuji  
**Job Title:** President  
**T:** + 81 543536 121  
**F:** + 81 54352 6390  
**E:** scsanwa@blue.ocn.ne.jp  
**W:** http://www.sco-sanwa.jp

## Saxlund International Ltd

11 Freemantle Business Centre  
Millbrook Road East  
Southampton  
Hampshire  
UK

**Contact:** Mr Matt Drew  
**T:** + 44 2380 636330  
**F:** + 44 2380 636343  
**E:** mattdrew@saxlund.co.uk  
**W:** www.saxlund.co.uk

## SCAFCO Corporation

PO Box 11215  
6200 East Main  
Spokane  
Washington  
99211-1215  
USA

**Contact:** Mr Bruce Katahira  
**T:** + 1 509 3439000  
**F:** + 1 509 535 9130  
**E:** mail@scafcoc.com  
**W:** www.scafcoc.com

## Scantech International

PO Box 1485  
Springwood  
Queensland  
4127  
Australia

**Contact:** Mr Henry Kurth  
**T:** + 61 7 3710 8406  
**F:** + 61 7 3710 8499  
**E:** sales@scantech.com.au

**W:** www.scantech.com.au  
World leader in process control solutions for conveyed bulk materials. On-belt analysers with proven technologies. Reliable, accurate and dependable ash, moisture and elemental measurement minute by minute. Control quality through blending or monitor specification compliance. Over 1,000 installations. Other Equipment: Analysers.



# THE POWER TO DELIVER



WE CONVEY QUALITY

sales@samson-mh.com  
www.samson-mh.com

## Fully mobile shiploading system

- Increase productivity with loading rates up to 3500 tph
- Designed to handle a wide variety of materials from free-flowing light particles to heavy ores and concentrates
- No need for a dedicated berth

**SAMSON**  
AUMUNDGROUP

## SCHADE Lagertechnik (AUMUND Group)

**SCHADE**  
AUMUND GROUP

Bruchstraße 1  
Gelsenkirchen, D-45883  
Germany

**Contact:** Dr Christoph Seifert  
**Job Title:** Managing Director  
**T:** + 49 209 50 31 60  
**F:** + 49 209 50 31 62 88

**E:** sales@schade-lagertechnik.com

**W:** www.schade-lagertechnik.com

SCHADE Lagertechnik GmbH, a

company within the AUMUND

Group, is a global market leader in

designing and supplying stockyard

technology such as longitudinal and

circular stockyards, blending beds,

tripper cars, bridge- and portal-type

stackers and reclaimers as well as

wagon unloading systems. The

products are used in the cement,

mining, fertilizer and chemical

industries, in power plants, the iron

and steel industry, and at port and

terminal facilities.

## Schenck Process

7901 NW 107th Terrace

Kansas City

MO

64153

USA

**Contact:** Mr Todd Messmer

**Job Title:** Sales Applications

Engineering Manager

**T:** + 1 262 473 2441

**F:** + 1 262 473 4384

**E:** mktg@schcnkprocess.com

**W:** www.schenckprocess.com

Schenck Process is a worldwide manufacturer of pneumatic conveying, filtration, weighing and feeding technologies. The commitment to research and development has led to the creation of some of the industry's most advanced products along with delivering unified process solutions for customers in every corner of the world.

## Schenck Process Africa (Pty) Limited

1 Crusher Road

Crown Ext. 3

Johannesburg

Gauteng

2092

South Africa

**Contact:** Mr Willem Kempen

**T:** + 27 11 837 9656

**F:** + 27 11 837 7458

**E:** wkempen@schcnkprocess.co.za

**W:** www.schenckprocess.co.za

Supplies a wide variety of bulk

materials weighing equipment,

including static controllers and

loadcells as well as belt weighers

and flow meters.

## Schenck Process UK Limited

Alpha Court

Capitol Park

Thorne

Doncaster

South Yorkshire

DN8 5TZ

UK

**Contact:** Mr Richard Sims

**Job Title:** Technical Sales Director

**T:** + 44 1302 321 313

**F:** + 44 1302 554 400

**E:** enquiries@schcnkprocess.co.uk

**W:** www.schenckprocess.co.uk

## Schneider Electric

M4 Plant - 22 chemin du vieux

chêne

Meylan

38240

France

**Contact:** Ms Sophie Souquet

**Job Title:** PR Manager

**T:** + 33 4 76 82 24 61

**E:** sophie.souquet@schneider-

electric.com

**W:** www.schneider-electric.com

## Schouten Commodities BV

Burgstraat 12 4283 GG Giessen

Giessen

4284 GG

The Netherlands

**Contact:** Mr Marius van Doorn

**Job Title:** Commercial Manager

**T:** +31 183-446451

**E:** info@schoutenproducts.com

**W:** www.schoutenproducts.com

## Schrage Rohrkettensystem GmbH Conveying Systems

Im Gewerbepark 26-30

Friedeburg

26446

Germany

**Contact:** Mr Ralf Ronken

**Job Title:** Technical Manager

**T:** + 49 4465 9469 0

**F:** + 49 4465 9469 33

**E:** info@schrage.de

**W:** http://www.schrage.de/

For more than 30 years, we have

been developing tube chain

conveyors for a wide range of

industries, worldwide. We design,

test, build, and deliver complete

systems in a modular design for

nearly all bulk solids. And also our

mobile conveyors for loading

trucks, wagons or containers have

many admirers.

## Scorpio Engineering Pvt. Ltd

Scorpio House

132 Wheeler Road

Cox Town

Bangalore

560 005

India

**Contact:** Mr Jacob P.

**Job Title:** VP - Marketing &

Application

**T:** + 91 99801 625 39/+ 91 77026

3779

**F:** + 91 80 2548119

**E:** jacob@scorpioengg.com,

jacobsebrmh@gmail.com

**W:** www.scorpioengg.com

Scorpio is a turnkey engineering

and manufacturing company in bulk

materials handling concentration on

ports and port handling systems for

dry bulk cargo. A 50000 sqft

manufacturing facility on a 5 acre

plot augments our core engineering

and design capabilities.

Experienced service and start up

engineers can get projects running in quick time. A strong design team underscores our technology orientation. At Scorpio, we sell technology.

## Sea Spec International

5 Manor Green

Nth Frodingham

Driffield

East Yorkshire

YO25 8JH

UK

**Contact:** Mr Mike L Coles

**Job Title:** Company Proprietor

**T:** + 44 1262 488 500

**F:** + 44 1262 481200

**E:** mikecoles@seaspec.eclipse.co.uk

## Sea Transport Corporation

PO Box 1043

Southport

QLD

4215

Australia

**Contact:** Mr Ross Ballantyne

**T:** + 61 7 5529 5777

**F:** + 61 7 5529 5177

**E:** ross@seatransport.com

**W:** www.seatransport.com

## Seabulk Inc

Suite 150

10271 Shellbridge Way

Richmond

British Columbia

V6X 2W8

Canada

**Contact:** Mr Sidney Sridhar

**Job Title:** President



*SCHADE bridge-type reclaimer at the Holcim plant in Campulung, Romania. ©SCHADE.*





## Environmentally Safe Stockyard Solutions



**Proven Technology, Quality,  
Strength and Reliability for**

- Stacking
- Storing
- Blending
- Reclaiming

**of a wide range of bulk materials  
in all kinds of industries worldwide**

**SCHADE**  
AUMUNDGROUP

T: + 1 604 273 1378 Ext 103  
F: + 1 604 273 1358  
E: sbs@seabulk.com  
W: www.seabulk.com  
Design and build contractors for bulk materials handling ports involving shiploading/unloading and storage systems. Seabulk provides integrated shipping solutions from 'mine to mill' for dry bulk and liquid bulk cargo. Developed World's largest gravity reclaim ore transshipper. Also involved in design/construction of civil and marine structures.

## S-E-G Instrument AB

Box 111 43  
Bromma  
S-161 11  
Sweden  
**Contact:** Ms Eva Söderholm  
**Job Title:** Assistant  
T: + 46 8 764 74 00  
F: + 46 8 764 75 00  
E: inform@s-e-g.com  
W: www.s-e-g.com  
Producer of belt scales, massflow meters and other industrial weighing equipment.

## Selpco Resources Inc.

14150 NE 20th Street  
F1, PMB342  
Bellevue  
WA  
98007  
USA  
**Contact:** Mr S E (Steve) Laccinole  
**Job Title:** Principal Engineer/COO  
T: + 1 206 255 0885  
F: + 1 206 260 1474  
E: selpco@selpco.com  
W: www.selpco.com  
A bulk solids handling engineering and program management consultant serving the cement, pulp and paper, energy, mining, chemical and port industries. Primary service is program management of complex material handling projects, from planning through commissioning.

## Sempertrans France Beltting Technology SAS

Sempertrans Marketing  
10 rue des charretiers  
Argenteuil Cedex  
95104  
France  
**Contact:** Ms. Catherine Flichy  
T: + 33 1 30 25 72 00  
F: + 33 2 39 80 46 16  
E: contact@sempertrans-france.com  
W: www.sempertrans.com  
SEMPERTRANS has been developing, manufacturing and installing conveyor belts for more than 50 years. Its knowhow, its experience and the quality of its products make SEMPERTRANS one of the world's leading companies in its field.

## SENNEBOGEN Maschinenfabrik GmbH

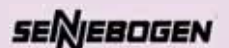

Hebbelstrasse 30  
Straubing  
D-94315  
Germany  
**Contact:** Mr Bernhard Kraus  
T: + 49 9421 540143  
F: + 49 9421 43882  
E: marketing@sennbogen.de  
W: www.sennbogen.com  
Sennebogen offers a wide range of

all kinds of materials handling machines, HD rope excavators/cranes, crawler cranes, telescopic cranes and base carriers.

## Sensor Technology Ltd

Apollo Park  
Ironstone Lane  
Wroxton  
Banbury  
Oxon  
OX15 6AY  
UK  
**Contact:** Mr Mark Ingham  
**Job Title:** Sales Manager  
T: + 44 1869 238400  
F: + 44 1869 238401  
E: info@sensors.co.uk  
W: www.sensors.co.uk  
Suppliers of TORQSENSE & LOADSENSE sensors and transducers, TorqSense, the world's first low cost non-contact rotary torque transducers and LoadSense wireless load transducers.

## SERAM

817 boulevard Marius Berliet  
Perpignan  
66000  
France  
**Contact:** Mr Joaquin Semis  
**Job Title:** CEO  
T: + 33 642 287 213  
F: + 33 468 615 700  
E: semis.j@seram.net  
W: www.seramgroup.com  
Manufacturer of hydraulic, electrical, balanced cranes for bulk handling since 1973. Outreach up to 40 meters and lifting capacity up to 35 tons. SERAM offers design, manufacture, erection, training and after-sales service for our whole range of cranes worldwide.

## Servo Berkel Prior

Jan Evertsenlaan 4  
Katwijk  
2224 SV  
The Netherlands  
**Contact:** Mr Erwin van Diest  
**Job Title:** Marketing Director  
T: + 31 71 4030101  
F: + 31 71 4032317  
E: info@servoberkelprior.eu  
W: www.servoberkelprior.eu  
Offers bunker weighers and duplex weighers for in/outtake and bulkloading; automatic net weighers; special weighing equipment; conversion sets for all conventional weighers.

## SESCOTRANS For Developed Logistics (SAE)

1, Elshahied Sayed Zakarya St.  
(Behind Sheraton Airport)  
Cairo  
11361  
Egypt  
**Contact:** Mr Kareem Abd El Latif  
**Job Title:** Assistant General Manager  
T: +2 057 229 00 95  
F: +2 057 229 08 49  
E: kareem.abdelatif@sescotrans.net  
W: www.sescotrans.com

## SEW-EURODRIVE GmbH & Co KG

P O Box 3023  
Bruchsal  
D-76652  
Germany  
**Contact:** Mr Herbert Ebert

**Job Title:** Marketing Manager  
T: + 49 7251 75 2555  
F: + 49 7251 75 1970  
E: herbert.ebert@sew-eurodrive.de  
W: www.sew-eurodrive.com

## SGH Equipment Limited

Unit 32  
King Street Trading Estate  
Middlewich  
Cheshire  
CW10 9LF  
UK  
**Contact:** Mr Stuart Henderson  
**Job Title:** Director  
T: + 44 1606 536 955  
F: + 44 1606 536 956  
E: sales@sghequipment.co.uk  
W: www.sghequipment.co.uk  
Equipment for conveying and handling Powders and Granular materials.  
EQUIPMENT: Storage Silos & Vessels, Silo Safety Systems, Discharge & Flow Aids, Valves & Actuators, Conveyors & Feeders, Dust Filters & Collectors, Mixers & Blenders, FIBC / Big Bag - PORTABULK® Representatives - UK  
SERVICES: Fabrication, Mechanical, Electrical  
\*Design, Manufacture, Installation & Commissioning  
\*Control & Instrumentation  
\*Dust & Odour Suppression

## SGS

Suite 210B  
1919 S. Highland Ave  
Lombard  
Illinois  
60148  
USA  
**Contact:** Ms MaryLynn Dobush  
T: + 1 630 953 9300  
F: + 1 630 953 9306  
E: info@sgs.com  
W: www.sgs.com

## SGS (Nederland) BV

Malledijk 18  
Spijkenisse  
AE  
3200  
The Netherlands  
**Contact:** Mr Rolf Wiltling  
T: + 31 181 69 3260  
F: + 31 181 69 3581  
E: rolf.wiltling@sgs.com  
W: www.sgs.nl

## SGS Australia Pty Ltd

Unit 16  
33 Maddox Street  
Alexandria  
NSW  
2015  
Australia  
**Contact:** Mr Stephen Hemsworth  
**Job Title:** National Business Manager  
T: + 61 2 8594 0400  
F: + 61 2 8594 0419  
E: stephen.hemsworth@sgs.com  
W: www.au.sgs.com  
SGS is the world's leading inspection, verification, testing and certification company. SGS also designs and supplies mechanical sampling systems for a wide range of bulk materials. SGS has more than 30 years experience in this field with equipment in operation throughout the world.

## SGS Minerals Services

185 Concession Street  
PO Box 4300  
Lakefield  
ON

KOL 2HO  
Canada  
**Contact:** Ms Peggy Bell  
**Job Title:** Global Minerals Marketing Coordinator  
T: + 1 705 652 2000  
F: + 1 705 652 6365  
E: minerals@sgs.com  
W: www.sgs.com/coal  
SGS works hand-in-hand with your operations to provide cost-effective solutions to minimize operational and financial risk. Our global technical leadership and industrial expertise provides an unrivalled global benchmark of experience and value to help you control your coal operations..

## SGS Minerals Services

1 Place Des Alps  
PO Box 2152  
Geneva  
CH 1211  
Switzerland  
**Contact:** Mr Richard Lihou  
T: + 41 22 739 9111  
F: + 41 22 739 9815  
E: richard.lihou@sgs.com  
W: www.sgs.com  
The SGS Group is the global leader and innovator in verification, inspection, testing and certification services. Founded in 1878, SGS is recognised as the global benchmark for the highest standards of expertise and integrity. With over 30,000 employees, the Company operates a network of offices and laboratories in over 140 countries around the world.

## Shandong Lingong Machinery

Lingong Industrial park  
Linyi Economic Development Zone  
Linyi  
Shandong  
276023  
China  
**Contact:** Ms Shaohua Guo  
T: + 86 539 8785578  
F: + 86 531 66590 959  
E: shaohua.guo@sdlg.com.cn  
W: http://www.sdlg.cn/

## Shanghai Global Machinery. Co., Ltd (SGMC)

No.1449 Baishi Road  
Qingpu District  
Shanghai  
201711  
China  
**Contact:** Mr Luo Tao  
T: + 86 21 398 21129  
F: + 86 21 398 21130  
E: luo@sgmc.com.cn  
W: www.sgmgrab.com  
Shanghai Global Machinery Co., Ltd (SGMC) is a famous manufacturer specializing in producing grab series products. SGMC grabs are widely applied to shipping, port, power station, steel plant, refuse incineration plant, railway, cement, chemical engineering, paper marking, dredging, salvaging, etc.

## Shanghai Guan Hai Engineering Co.,Ltd

Lane3736-5, Hunan Highway  
Pudong  
Shanghai  
201318  
China  
**Contact:** Ms Maggie Xu  
**Job Title:** Sales Department  
T: + 86 21 2098 0848 807

F: + 86 21 2098 0849  
E: maggie@ghengineer.com  
W: www.ghengineer.com

## Shanghai Janus Grab Co., Ltd.

Room 518-519  
VMO 37#  
2049 Pujin Road  
Shanghai  
Shanghai  
201114  
China  
**Contact:** Mr Pracy Jia  
**Job Title:** Marketing Manager  
T: + 86 21 6885 5558  
F: + 86 21 6885 5559  
E: janus@janusgrab.com  
W: http://www.janusgrab.com/  
Shanghai Janus Grab Co., Ltd specializes in various types of grabs designing and manufacturing, with rich experience of grabs manufacturing for nearly 30 years.

## Shanghai Peiner Smag Machinery Co.,Ltd

6098 Huqingping Road, Zhujiyajiao  
Qingpu  
Shanghai  
201713  
China  
**Contact:** Mr Ellan Chan  
**Job Title:** General Manager  
T: + 86 21 5924 7798  
F: + 86 21 5924 0057  
E: ellan.chan@shpeiner.com  
W: www.shpeiner.com

## Shanghai Qifan Co., Ltd.

25F, Baoding Mansion  
Xujiahui Road  
Shanghai  
200025  
China  
**Contact:** Mr Eric Liu  
T: + 86 21 51029257  
F: + 86 21 51062358  
E: ericshpy@163.com  
W: http://www.qifanco.com/

## Shanghai Yo-Pi Port Machinery Co. LTD

Room 603, No 3 Lane 298  
East Wenshui Road  
Shanghai  
PR  
China  
**Contact:** Miss Avril  
T: + 86 21 552 28716  
F: + 86 21 5522 8739  
E: grab@shyp-pm.com  
W: www.shyp-pm.com/

## Shanghai Zhenhua Port Machinery Co (ZPMC) Ltd

3470 Pudong Nan Lu  
Shanghai  
PR  
200125  
China  
**Contact:** Mr Chen Kai  
**Job Title:** General Manager  
T: + 86 21 5839 6666  
F: + 86 21 5839 9555  
E: mail@zpmc.com  
W: www.zpmc.com  
Shanghai Zhenhua Port Machinery Co Ltd (ZPMC) is a world-famous manufacturer of cranes and large steel structures. Its main products include quayside container cranes, rubber-tyred gantry cranes (RTGs), bulk-material ship loaders and unloaders, bucket wheel stackers and reclaimers, portal cranes, floating cranes, engineering vessels and large steel bridge structures.



## Shanthi International

21, Center Point  
Indira Gandhi Road  
Jamnagar  
Gujarat  
361008  
India

**Contact:** Mr Sanjay Masuria  
**Job Title:** Director - Marketing - International  
**T:** + 91 288 255 6671 / + 91 288 2555 867  
**F:** + 91 288 255 4254  
**E:** sanjay@servoday.in  
**W:** www.servodaygrabs.com  
Manufacturer & Exporter of Radio Remote Control Grabs, capacity from 6CBM to 22 CBM, with the Unique features of Grabs operation counting, with Weight calculation, online Grab monitoring systems etc.

## Shaw Almex Canada

PO Box 430  
Parry Sound  
Ontario  
P2A 2X4  
Canada

**Contact:** Ms Pamela Mc George  
**Job Title:** Sales Manager  
**T:** + 1 705 746 5884 / +1 9053317177  
**F:** + 1 705 746 9484  
**E:** Pamela\_mcgeorge@almex.com  
**W:** www.almex.com

## SIBRE - Siegerland Bremsen GmbH

Auf der Stücker 1-5  
Haiger  
Hessen



D-35708

Germany

**Contact:** Mr Michael Scheidt

**Job Title:** Sales Manager

**T:** + 49 2773 9400 0

**W:** www.sibre.de

Since 1958 SIBRE-Siegerland Bremsen GmbH is a manufacturer of industrial brakes systems (drum-, disc-, caliper- and storm brakes) and drive components (e.g. drum couplings) and offers an optimum combination of innovative high quality products, easy usage and minimized life-cycle costs by employing latest manufacturing and quality assurance technologies.

## SIDERAR / TERNIUM

Centro de Informacion  
Ave. Cordoba 320, Piso 4  
Ciudad Autonoma de Buenos Aires  
Buenos Aires  
C1054AAP  
Argentina

**Contact:** Mr Ariel Fabré

**Job Title:** Engineer

**T:** + 54 11 4018 6538

**F:** + 54 11 4018 1005

**E:** BAIIFA@techint.net

**W:** www.siderar.com

## Siebtechnik GmbH

Platanenallee 46  
Mülheim an der Ruhr  
D-45478

Germany

**Contact:** Mr G Liefke

**T:** + 49 208 580 100

**F:** + 49 208 580 1300

**E:** sales@siebtechnik.com

**W:** www.siebtechnik.com

## Siemens AG International

Frauenauracherstrasse 80  
Erlangen  
91050

Germany

**Contact:** Mr Hans Hertogh

**Job Title:** Marketing Manager

**T:** + 49 9 131 984 299

**E:** cranes.i@siemens.com

**W:** www.siemens.com/cranes

Safety, reliability and performance of Siemens' cranes drive & control systems is widely recognized. During the last 10 years over 4000 harbour cranes are equipped with Siemens. Simocrane crane-control & -automation technology combined with Siemens' extensive cranes know-how ensure maximum safety, reliability, efficiency and productivity of your crane.

## Siemens Nederland NV

PO Box 16068

The Hague

2500 BB

The Netherlands

**Contact:** Mr Hans Hertogh

**T:** + 31 70 33 33 333

**F:** + 31 70 33 33 534

**E:** hans.hertogh@siemens.com

**W:** www.siemens.com

Siemens Netherlands NV delivers both products, systems, facilities

and services. The varied product range covers virtually all areas of electrical engineering and electronics.

## SIG Società Italiana Gomma Spa



Via Colombo 144

Corla Minore

Varese

21055

Italy

**Contact:** Mr Luca De Stefano

**Job Title:** Commercial Director

**T:** + 39 0331 365135

**F:** + 39 0331 365215

**E:** sig@sig.it

**W:** www.sig.it

The Italian leading producer of rubber conveyor, elevator and tubular belts with textile and steel cord carcass. Primary markets are mines, power stations, iron and steel industries, cement factories and all bulk material handling plants as harbour terminal, grain silos, waste processings.

# WE MANUFACTURE IN ITALY TO SUPPLY ALL AROUND THE WORLD



# CONVEYOR & ELEVATOR BELTS STEEL CORD & TEXTILE

ISO 9001



21055 Corla Minore (Italy)  
Phone +39 0331 36.51.35  
Fax +39 0331 36.52.15

Via A. Colombo, 144  
www.sig.it  
E-mail: sig@sig.it



# Increase your profits with intelligent solutions

Your challenge may be to invest in a bulk handling solution that ensures profitable and sustainable growth for your business. Our expertise is to provide just that solution. Virtually any dry bulk material can be handled through safe and smooth Siwertell systems, and thanks to totally-enclosed conveyors, the operation is free from dust and spillage.



Ship unloaders



Road-mobile ship unloaders



Ship loaders



Conveying systems



Bulk terminal solutions



Parts & Service

NEW [siwertell.com](https://www.siwertell.com)



Siwertell is part of Cargotec

## *Siwertell*





**Silvan Dis Ve IC Ticaret**

**AS**

Akasyali Sok  
Konak Apt.  
5/8-9 Suadiye  
Istanbul  
Turkey

**Contact:** Mr Tarik Gursal  
**T:** + 90 216 380 36 18  
**F:** + 90 216 416 91 59  
**E:** info@silvanticaret.com  
**W:** www.silvanticaret.com

**Sime Industrie**

20, allée des érables  
B P 40004  
Roissy  
CDG Cedex  
F-95911  
France

**Contact:**  
**Job Title:** Marketing Manager  
**T:** + 33 1 49 90 32 20  
**F:** + 33 1 49 89 06 38  
**E:** sales@stromagfrance.com

**Simplicity Projects Pvt Ltd**

17 Community Centre  
Maya Puri, Phase 1  
New Delhi  
110064  
India

**Contact:** Mr R K Makhija  
**Job Title:** President  
**T:** + 91 11 2811 5093  
**F:** + 91 11 2811 6744  
**E:** sppl@simplicityprojects.com  
**W:** www.simplicityprojects.com

**Siwertell AB**



PO Box 566  
Gunnarstorp  
Bjuv  
SE-267 25  
Sweden

**Contact:** Ms Emily Braekhus  
Cueva  
**Job Title:** Marketing & Communications Manager  
**T:** + 46 42 858 00  
**F:** + 46 42 858 99  
**E:** sales@siwertell.com  
**W:** www.siwertell.com

Siwertell dry bulk handling solutions are designed with a totally enclosed conveying line, reducing dust emission to a minimum and eliminating spillage completely, and is thereby one of the most environmentally friendly dry bulk handling solution found on the market today.

**Sly Incorporated**

8300 Dow Circle  
Suite 600  
Strongsville  
OH  
44136  
USA

**Contact:** Mr Bill Kurz  
**Job Title:** Vice President/Regional Sales Manager  
**T:** + 1 440 274 0150  
**F:** + 1 440 891 3210  
**E:** sales@slyinc.com  
**W:** www.slyinc.com

**SMB International GmbH**

Friedrich List Str 3-7  
Quickborn  
25451  
Germany

**Contact:** Mr Andreas Heckel  
**Job Title:** Managing Director  
**T:** + 49 41 06 12388 0  
**F:** + 49 41 06 12388 19

**E:** heckel@smb-group.de  
**W:** www.smb-shiploading.com

- SMB specializes in
1. Shiploaders for various bulk and bag materials such as fertilizers, sulphur, grains and cement.
  2. Reclaimers
  3. Conveying systems
  4. Bucket Elevators
  5. Warehousing systems for pallets
  6. Automatic palletizers.

**Smiley Monroe Ltd**

23 Ferguson Drive  
Knockmore Hill Industrial Park  
Lisburn, Co. Antrim  
Northern Ireland  
BT28 2EX  
UK

**Contact:** Mr Tim Monroe  
**Job Title:** Marketing Manager  
**T:** + 44 28 9267 3777  
**F:** + 44 28 9266 3666

**E:** sales@smileymonroe.com  
**W:** www.smileymonroe.com  
A leading United Kingdom manufacturer of moulded rubber and PU products, spillage control systems, belt alignment equipment and belt scrapers. The portfolio includes modular products such as impact bars, skid bars and skirt boards for ease of installation and replacement, together with encapsulation systems for conveyors and for screens and feeders.

**SMM-UM Sociedade de Montagens Metalomecnicas SA**

Quinta da Fonte  
Edifício D.João I  
Paço de Arcos 2770-203  
Portugal

**Contact:** Ms Ines Goncalves  
**T:** + 351 21 4697600 / 607  
**F:** + 351 21 4697612  
**E:** ines.goncalves@smm.com.pt  
**W:** www.smm.com.pt

Maintenance and Revamping of Lifting and Handling Equipments

**Societe de Tolerie Industrielle Francaise**

Artisanal Zone de la Lande  
Street Savennieres  
St Georges Sur Loire, ZI 49170  
France

**Contact:** Mr Manuel Burgos  
**T:** + 33 2 41 72 16 82  
**F:** + 33 2 41 39 32 12  
**E:** m.burgos@stifnet.com

**Solimar Pneumatics**

8001 Ranchers Road NE  
Minneapolis  
Minnesota, MN 55432-3103  
USA

**Contact:** Mr Jeff Lucke  
**Job Title:** Director of Sales  
**T:** + 1 763 574 1820  
**F:** + 1 763 574 1822

**E:** jeff@solimarpne.com  
**W:** www.solimarpneumatics.com  
Solimar Pneumatics is a leading designer and supplier of aeration systems and engineered components for the dry bulk material handling industry. Solimar is backed by over 40 years of experience specializing in

aeration devices and discharge aids that assist the pneumatic flow of dry products like cement and flour.

**Solitec Engineering Ltd**

Unit 8  
Gilchrist Thomas Industrial Estate  
Blaenavon  
Gwent NP4 9RL  
UK

**Contact:** Mr David Woodland  
**Job Title:** General Manager  
**T:** + 44 1495 790623  
**F:** + 44 1495 790666  
**E:** sales@solitec.co.uk  
**W:** www.solitec.co.uk

**Sotecma inc**

245, boul. Yvon - L'Heureux Nord  
Beloeil  
Quebec  
J3G 5R8  
Canada

**Contact:** Ms Isabelle Coutu  
**Job Title:** Administrative Assistant  
**T:** + 1 450 464 4426  
**F:** + 1 450 464 4534  
**E:** info@sotecma.com

**W:** www.sotecma.com  
Sotecma offers engineering services in solid bulk handling, storage, design and projects realization. Sotecma Construction also provides turnkey projects and follow up to construction works. We will assist you for the signature of the documents, feasibility studies, choice of the companies to be consulted and the signature of the agreements.

**Specimas**

Via Galvani Nr 1  
Nova Milanese  
Milan 20054



# Stemm®

GRABS FOR HANDLING  
ALL MATERIALS....  
A GRAB FOR EVERY  
OCCASION



## ELECTRO-HYDRAULIC CLAMSHELL & ORANGE PEEL GRABS RADIO CONTROLLED SINGLE ROPE GRABS

Delivery time:  
3-4 weeks  
Prices for all grab  
**On-line**  
Ask for your  
password !!!!

# Stemm®



STEMM EQUIPOS INDUSTRIALES, S.L.  
Poligono APATTA ERREKA, nave 1 • 20.400 IBARRA - SPAIN  
Tel. +34 943 335 033 • Fax +34 943 333 506 • E-mail: info@stemm.com  
**www.stemm.com**



Italy  
**Contact:** Mr Ottonel Popesco  
**T:** + 39 036 24 55 101  
**F:** + 39 036 24 12 33  
**E:** ottonel.popesco@cavotec.com

## Spiroflow Ltd

Lincoln Way  
 Clitheroe  
 Lancashire BB7 1QG, UK  
**Contact:** Mr Ben Ayrton  
**Job Title:** Marketing Manager  
**T:** + 44 1200 422525  
**F:** + 44 1200 429165  
**E:** sales@spiroflow.com  
**W:** www.spiroflow.com  
 Spiroflow is a leading designer and manufacturer of Bulk Bag (FIBC) Fillers and Dischargers. Their comprehensive range covers the simple filling and emptying of dust-free materials right through to the 'total containment' of hazardous chemicals.

## STAG AG

Industriestrasse 11  
 Maienfeld 7304  
 Switzerland  
**Contact:** Mr Walter Furgler  
**Job Title:** Sales/Marketing  
**T:** + 41 81 303 5800/45  
**F:** + 41 81 303 5899  
**E:** office@stag.net  
**W:** www.stag.net  
 STAG bulk material technology for mechanical and pneumatic conveying technology as well as ensilage technology. We are also the ideal partner as a general company for complex assignments for nearly all bulk materials in plant

construction.

## Standard Industrie



139 - 141 Rue du Luxembourg  
 Roubaix  
 59054  
 France  
**Contact:** Ms Laura Broderick  
**Job Title:** Marketing & Communication  
**T:** +33 320 283 232  
**F:** +33 320 685 109  
**E:** Laura.BRODERICK@Standard-industrie.com  
**W:** www.standard-industrie.com  
 Specialist in the design and manufacture of equipment to facilitate the handling of powdery bulk products safely and with respect for the environment.  
 4 fields of expertise :  
 - Blockage & build-up removal  
 - Industrial vacuum cleaning  
 - Conveyor belt optimisation  
 - Silo & hopper cleaning services

## Starlinger & Co. Gesellschaft m.b.H.



## Starlinger

Sonnenruhrgasse 4  
 Vienna

A-1060  
 Austria  
**Contact:** Mr Christian Leeb  
**Job Title:** Sales Director  
**T:** + 43 1 599 55 0  
**F:** + 43 1 599 55 180  
**E:** sales@starlinger.com  
**W:** www.starlinger.com  
 Starlinger ranks among the world's leading suppliers of machinery and process technology for woven plastic sack production. The Austria-based company provides extrusion lines as well as heavy-duty circular looms for FIBC production out of PP as well as PET and - most recently - rPET flakes.

## STATEC BINDER GmbH

Industriestrasse 32  
 Gleisdorf  
 8200  
 Austria  
**Contact:** Ms Tina Peinhart  
**T:** + 43 3112 38580 538  
**E:** t.peinhart@statec-binder.com  
**W:** www.statec-binder.com  
 STATEC BINDER is an internationally known specialist for customized bagging and palletizing systems. The Austrian company already has successfully installed more than 1200 machines worldwide. With 40 years of experience STATEC BINDER is global market leader in high-performance open-mouth bagging and known for absolute reliability, innovation and precision.

## Stemm Equipos Industriales, S.L.



Poligono Ibarluze  
 PAB. B-9  
 Hernani  
 20120  
 Spain  
**Contact:** Mr Martin Amesti  
**Job Title:** General Manager  
**T:** + 34 609 403 120  
**F:** + 34 943 333 506  
**E:** info@stemm.com  
**W:** www.stemm.com  
 With extensive experience in the bulk handling sector, STEMM manufactures a wide range of grabs for harbour and industrial cranes, especially electrohydraulic clamshell and orange peel grabs and radio remote-controlled grabs with state-of-the-art construction and service concepts. STEMM is your partner for consulting, manufacturing and servicing around the grab world. For further information, kindly check our website www.stemm.com.

## Stemm Equipos Industriales, S.L.

Calle José Hierro, 2  
 Villabilla - Madrid  
 28810  
 Spain  
**Contact:** Mr Wolfgang Thies  
**Job Title:** Export Manager  
**T:** + 34 943 335 033

**E:** info@stemm.com  
**W:** www.stemm.com

## Stevenel OY

Juhlatalonkatu 6 C 45  
 Tampere  
 FIN - 33100  
 Finland  
**Contact:** Mr Heikki Hyysalo  
**Job Title:** Managing Director  
**T:** + 358 40 5037 616  
**F:** + 358 3 261 9773  
**E:** stevenel@stevenel.com  
**W:** www.stevenel.com  
 Stevenel Ltd offers automated and semi-automated cargo handling attachments for fully hydraulic cranes at ports and terminals. We offer lift frames for pulp, sawn timber, steel products, paper reels, big bags, pallet cargo etc.

## Stewart Inspection and Analysis (Pty) Ltd

PO Box 267  
 Brakpan  
 1541  
 South Africa  
**Contact:** Mrs Carol Le Cordeur  
**T:** + 27 11 740 0621  
**F:** + 27 11 740 0626  
**E:** carol.lecordeur@alsgroup.com  
**W:** www.stewartgroupglobal.com

## STM srl

Zona Industriale snc  
 Tito Scalco  
 Potenza  
 85050  
 Italy  
**Contact:** Mr Anselmo Zirpoli

# SAVE MONEY & CONTROL DUST EMISSIONS BY SEALING !

## LIFTUBE®

**Optimize the sealing and safety of all conveyor belts between the loading and unloading points**

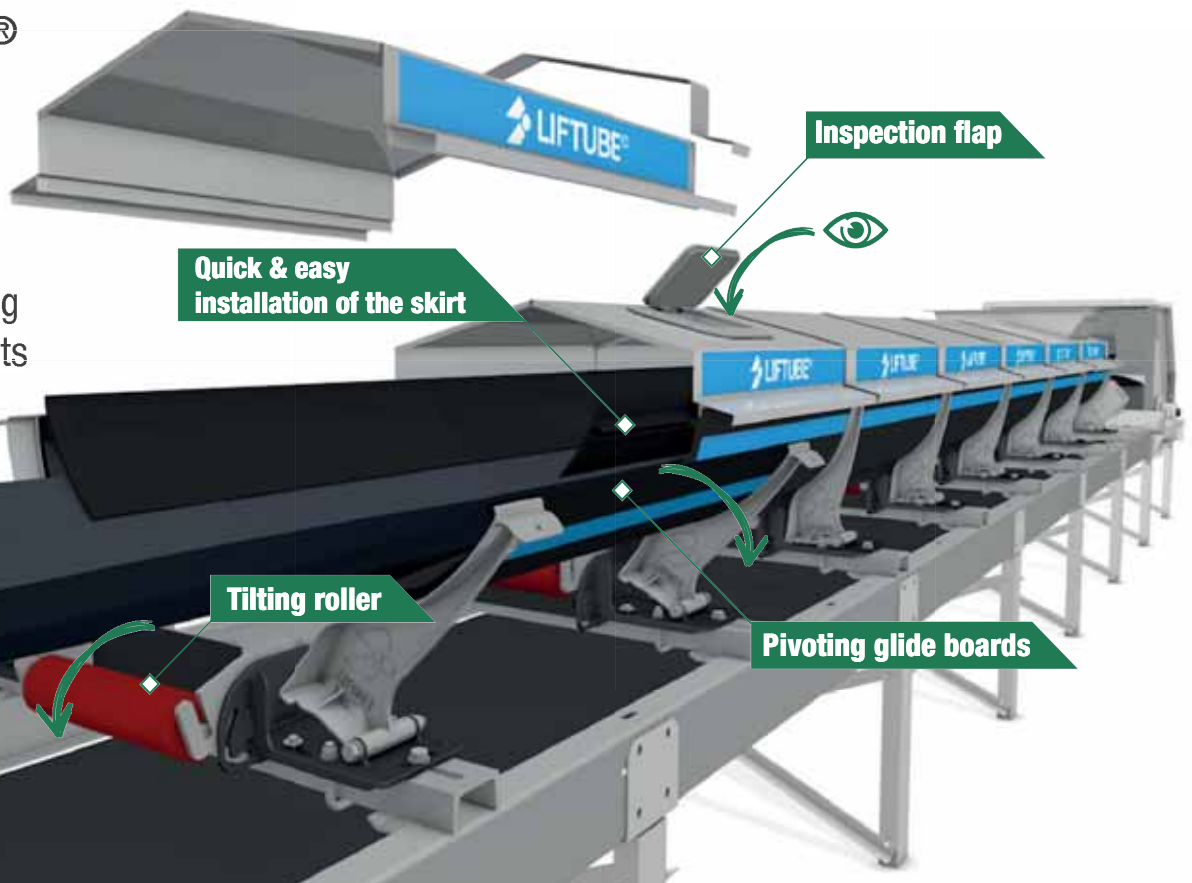

**Already present  
in more than 60  
countries, and  
growing**



[www.taimwesor.com](http://www.taimwesor.com)



Nuestro mundo es el mundo



**Job Title:** Sales Manager  
**T:** + 39 0971 485073  
**F:** + 39 0971 485086  
**E:** anselmo.zirpoli@stmpotenza.com  
**W:** www.stmpotenza.com  
 STM specializes in the engineering and supply of BELT CONVEYORS SYSTEMS for bulk materials handling facilities. STM is able to offer its Customers a full range of project services: engineering, fabrication, commissioning and STM usually performs complete installations in a wide range of industry fields such for example mining, thermal power plants, concrete placing.

## Stock Equipment Company

16490 Chillicothe Road  
 Chagrin Falls  
 Ohio  
 44023  
 USA  
**Contact:** Mr Simon Shipp  
**Job Title:** Business Development  
**T:** + 1 800 289 7326 ext: 217  
**F:** + 1 440 543 5944  
**E:** simon.shipp@stockequipment.com  
**W:** www.stockequipment.com  
 For over 80 years, Stock Equipment Company has installed material handling equipment in various applications around the globe. Stock is known for accurately weighing and feeding fuels/goods, reliably screening and conveying materials (both pneumatic and mechanical), as well as automating systems.

## Stockpile Surveying and Protection BVBA

Bankwegelhof 93C  
 Beveren-Waas  
 9120  
 Belgium  
**Contact:** Mr Joeri Verbraeken  
**T:** + 31 180 556561  
**F:** + 31 180 556289  
**E:** joeri.verbraeken@ssp-belgium.com

## Stokman BV

Brasem 18  
 Raamsdonksveer  
 AB  
 4941 SE  
 The Netherlands  
**Contact:** Mr Mark Hoekstra  
**Job Title:** Account Manager  
**T:** + 31 162 516040  
**F:** + 31 162 517590  
**E:** mhoekstra@stokmanbv.com  
**W:** www.stokmanbv.com  
 Produces, installs and repairs heavy duty bulk handling systems including ship-mounted equipment for self-unloaders.

## Stora Enso

PO Box 309  
 Helsinki  
 FI-00101  
 Finland  
**Contact:** Mr Lauri Peltola  
**Job Title:** Head of Group Communications  
**T:** + 358 2046 21380  
**F:** + 358 2046 21267  
**E:** lauri.peltola@storaenso.com  
**W:** www.storaenso.com

## Strudes Inc

1440 Sainte Catherine St  
 Suite 905  
 Montreal  
 Quebec



Canada  
**Contact:** Mr Henry Nowodworski  
**Job Title:** President  
**T:** + 1 514 731 6951 x 123  
**F:** + 1 514 737 4146  
**E:** h.nowodworski@strudes.ca  
**W:** www.strudes.ca  
 Strudes Inc. is an Engineering Consulting Company, specializing in design for heavy industry in general and Cement Industry in particular. For markets and more information: www.strudes.ca.

## STUDIO TECNICO MALNATI SAS

Via G. Treccani/Alfieri 22  
 Milano  
 I-20141  
 Italy  
**Contact:** Dr Andrea Malnati  
**Job Title:** Product Manager  
**T:** + 39 02 895 017 30  
**E:** andrea.malnati@stmalnati.com  
**W:** www.stmalnati.com  
 The company sells equipment and develops basic engineering for:  
 - Permanent installation : cement, fertilizer, coal, potash, etc. handling and storage process.  
 - Loading and unloading system at ports.  
 - Temporary installations for civil infrastructures like dams and tunnels.  
 - Aggregates handling systems.  
 - Mucking out by conveyor belts during the tunnel excavation phase.

## Sub Con Ltd

20 Shamrock Road  
 Erin  
 Ontario  
 NOB IT0  
 Canada  
**Contact:** Mr Don Johnstone  
**T:** + 1 519 833 0054  
**F:** + 1 519 833 9344  
**E:** don@bulk-store.ca

## Sucofindo

Laboratory Strategic Business Unit  
 Graha Sucofindo 6th Floor  
 Jalan Raya Pasar Minggu Kav.34  
 Jakarta 12780  
 Indonesia  
**Contact:** Mr Diding Sudira  
**Job Title:** Senior Manager  
**T:** + 62 21 798 3666  
**F:** + 62 21 798 6878  
**E:** diding@sucofindo.co.id  
**W:** www.sucofindo.co.id

## Sumitomo Heavy Industries Material Handling Systems Co., Ltd.

5th Floor Sumitomo Fudosan Hibiya Building  
 8-6, Nishishimbashi 2-Chome  
 Minato-Ku  
 Tokyo  
 105-0003  
 Japan  
**Contact:** Mr Akihide Ito  
**Job Title:** General Manager, International Sales  
**T:** + 81 3 6891 2164 / + 81 3 6737 2643  
**F:** + 81 3 6866 5181  
**E:** Akh\_Itou@shi.co.jp  
**W:** www.shi.co.jp/shi-mh/  
 Product range covers not only bulk handling but also cranes of all types. A leader in the field of continuous ship unloading with a long track record and experience with various materials, especially iron ore.

## Suomen Viljava Oy

Kielotie 5 B  
 Vantaa  
 01300  
 Finland  
**Contact:** Mr Hannu Kortesmaa  
**Job Title:** Project Manager  
**T:** + 358 10 3464 204  
**F:** + 358 01 3464 200  
**E:** hannu.kortesmaa@suomenviljava.fi  
**W:** www.suomenviljava.fi  
 Suomen Viljava Ltd is Finland's biggest grain handling and storage company. We have stores at 21 locations in south and middle Finland. The total storage capacity is 1,4 million tonnes. Our services comply with ISO 9001 and GTP standards.

## Supercargo, Lda

Rua Alfredo Cunha, 107  
 Monte de Caparica  
 2825-056 Caparica  
 Portugal  
**Contact:** Mr Artur Rocha  
**Job Title:** Director  
**T:** + 351 212 946 220  
**F:** + 351 212 946 228  
**E:** mail@supercargo.pt  
**W:** www.supercargo.pt  
 Superintendents for loading / unloading  
 Packing and stowage inspection,

report of findings  
 Damages surveys, loss prevention and evaluation  
 Draft survey and complete survey on vessels  
 (Gafta and Fosfa members and ISO 9001:2008 Approved)

## Superior Industries, Inc.

315 East State Highway 28  
 PO Box 684  
 Morris  
 Minnesota  
 56267  
 USA  
**Contact:** Mr Corey Poppe  
**Job Title:** Marketing Manager  
**T:** + 1 320 589 2406  
**F:** + 1 320 585 5644  
**E:** info@superior-ind.com  
**W:** www.superior-ind.com  
 Superior Industries has a reputation of engineering and manufacturing groundbreaking bulk material handling conveyors and cutting-edge components -including stacking, transfer and feed conveyors; portable ship loading and unloading conveyors; conveyor idlers, pulleys, belt scrapers, sealing systems, impact beds and guarding.

## Svendborg Brakes USA, LLC

4155 E. Jewell Ave., Suite 1018  
 Denver  
 CO  
 80222  
 USA  
**Contact:** Mr David Brooksbank  
**Job Title:** Marketing Director (Head Office)  
**T:** + 1 303 285 1271  
**E:** david.brooksbank@atramotion.com

## Swire CTM Bulk Logistics

C Transport Maritime SAM  
 Gildo Pastor Centre  
 7 Rue du Gabian  
 Monaco  
 MC 98000  
 Monaco  
**Contact:** Captain Giorgio Vallega  
**Job Title:** Operation/Commercial Manager  
**T:** + 377 9798 5981  
**F:** + 377 9798 2306  
**E:** gvallega@ctmcm.com  
**W:** www.swirectmbl.com  
 Sums up the experience, know-how and networks of its parent companies in the dry bulk and

logistics field, providing a full range of integrated services from the supplier to the end users, including specialised barge services, transshipment, river, coastal and ocean transportation by means of conventional bulkcarriers or self-unloading vessels and barge.

## Sympatec

System-Partikel-Technik  
 Am Pulverhaus 1  
 Clausthal-Zellerfeld  
 D-38678  
 Germany  
**Contact:** Dr Stephan Röthele  
**Job Title:** Managing Director  
**T:** + 49 5323 717 0  
**F:** + 49 5323 717 229  
**E:** sales@sympatec.com  
**W:** www.sympatec.com/

## Synergy Engineering Ltd

135 Glacier Street  
 Coquitlam  
 BC  
 V3K 5Z1  
 Canada  
**Contact:** Mr Richard Neuman  
**Job Title:** President  
**T:** + 1 604 472 2800  
**F:** + 1 604 464 9399  
**E:** office@synergy-eng.com  
**W:** http://www.synergy-eng.com

## TAIM WESER, S.A.



Carretera de Castellón, km 6,3  
 Poligono Industrial La Cartuja  
 Zaragoza  
 50013  
 Spain  
**Contact:** Mr Javier Salvador  
**Job Title:** Marketing  
**T:** + 34 976 500 006  
**F:** + 34 976 500 028  
**E:** jsalvador@taimweser.com  
**W:** www.taimweser.com  
 TAIM WESER is a world leading company with presence in more than 60 countries and over 100 years of experience in the supply of high technological tailor made projects, within the fields of bulk materials handling, lifting equipment, waste treatment plants and renewable energy.

# MAKING LIGHT WORK OF HEAVY DUTY.

**The future of material handling is now.  
Brand new design meets brand new features.**

[www.terex-fuchs.com](http://www.terex-fuchs.com)



**FUCHS**<sup>®</sup>  
A TEREX BRAND

**WORKS FOR YOU.**<sup>™</sup>

© 2017 Terex Corporation.  
Fuchs and Works For You are trademarks owned by Terex Corporation or its subsidiaries.



## TAKRAF GmbH

Torgauer Str. 336  
Leipzig  
D-04347  
Germany  
**Contact:** Mr Thomas Eckel  
**Job Title:** Director Sales  
**T:** + 49 341 2423 605  
**F:** + 49 341 2423 610  
**E:** takraf.sales@tenova.com  
**W:** www.takraf.com

With more than a century of experience and tradition in the field of bulk materials handling, the company is proud of its worldwide standing.

Services offered: planning, design, fabrication, erection and after sales service of machines, systems and complete plants.

## TAKRAF India Pvt. Ltd.

94/3, TTK Road  
Alwarpet  
Chennai  
600 018  
India

**Contact:** Ms Jayanthi Kandhasami  
**Job Title:** Marketing Executive - Mining & Minerals  
**T:** + 91 44 33430519 / 33430100  
**F:** + 91 44 24996451  
**E:** jayanthi@tenova.com  
**W:** www.takraf.co.in

TAKRAF India Pvt. Ltd., a wholly owned subsidiary within Tenova Mining & Minerals Division, a world leader in the mining and bulk handling equipment. TAKRAF as a competent, experienced, capable and reliable partner for our customers offers system solutions within the core areas open-cast mining and bulk material handling technology.

## Tank Connection

3609 North 16th Street  
Parsons  
Kansas  
KS 67357  
USA

**Contact:**  
**Job Title:** Sales Department  
**T:** + 1 620 423 3010  
**F:** + 1 620 423 3999  
**E:** sales@tankconnection.com  
**W:** www.tankconnection.com/

## Taurus Emergé

Rubber Industrial VII  
Kerpesi ut 17  
Budapest  
1965  
Hungary  
**Contact:** Mr Viktor Vajda  
**T:** + 36 62 566 700  
**F:** + 36 1113 2912  
**E:** marketing@taumrg.hu  
**W:** www.taumrg.hu

## TBA Doncaster

4 Railway Court  
Ten Pound Walk  
Doncaster  
South Yorkshire  
DN4 5FB  
UK

**Contact:** Mr David Trueman  
**Job Title:** Sales Director  
**T:** + 44 1302 330 837  
**F:** + 44 1302 724 731  
**E:** david.trueman@dbis.biz  
**W:** www.tba.group  
DBIS provide bulk and break bulk terminals with optimal management software solutions.

## TBMA Europe BV

Delfweg 18  
Noordwijkerhout  
NL-2211 VM  
The Netherlands  
**Contact:** Mr E A J Houben  
**Job Title:** Managing Director  
**T:** + 31 252 37 50 68  
**F:** + 31 252 37 54 36  
**E:** info@tbma.com  
**W:** www.tbma.com/engels/  
TBMA manufacture and supply a wide range of FIBC Filling- and FIBC Discharging machines. We are specialists in filling-off fine, aerated powders ensuring volume

reduction and a stable FIBC. Our range of automatic bag emptying machines can handle up to 1,500 bags/hour.

## TBS Shipping Services

612 Grassy Sprain  
Yonkers  
New York  
10710  
USA  
**Contact:** Mr Gregg McNelis  
**T:** + 1 914 961 1000  
**F:** + 1 914 961 2286  
**E:** TBSRates@nyc.tbsship.com  
**W:** www.tbsship.com/

## Tebodin Consultants & Engineers

P.O. Box 16029  
The Hague  
2500 BA  
The Netherlands  
**Contact:** Mr R J Smits van Oyen  
**Job Title:** Manager Logistics, Asset Management & Maintenance  
**T:** + 31 70 348 0249  
**F:** + 31 70 348 0591  
**E:** info@tebodin.com  
**W:** www.tebodin.com

An independent multi-disciplinary engineering and consulting firm, employing some 4,900 employees, located at 50 offices in 24 countries in Europe, the Middle East and Asia. Possessing an extensive international knowledge and experience in providing engineering consultancy services in the field of ports and terminals. Services range from preliminary studies for port development to the detailed design and construction supervision of terminals.

## Tebodin Netherlands B.V.

Jan Tinbergenstraat 101  
Hengelo  
7559 SP  
The Netherlands

**Contact:** Mr Bert Frowijn  
**Job Title:** Projects Director  
**T:** + 31 88 996 75 84  
**F:** + 31 570 63 6350  
**E:** b.frowijn@tebodincce.nl  
**W:** www.tebodincce.nl

## techNaero aps

Blaabaervej 3  
Haslev  
DK-4690  
Denmark  
**Contact:** Mr Anders Larsen  
**Job Title:** CEO  
**T:** + 45 56314925  
**F:** + 45 56314555  
**E:** sales@techNaero.dk  
**W:** www.techNaero.dk

We are selling, planning, producing and commissioning filtration systems for the world market. We have supplied filtration systems to customers in Scandinavia, Russia, Ukraine and Georgia. Huge filter systems shipped in ordinary containers to very competitive prices, worldwide. Standard control system able to communicate directly with the control room.

## Tecniconsult SpA

Viale dell'industria 40  
Busto Arisizio  
21052  
Italy  
**Contact:** Mr M Beghian  
**T:** + 39 331350777  
**F:** + 39 3313 53044  
**E:** sales@tecniconsult.com  
**W:** www.tecniconsult.com

## Telestack Limited

Bankmore Way East  
Omagh  
County Tyrone  
BT79 0NZ  
Northern Ireland  
**Contact:** Mrs Samantha Thompson  
**Job Title:** Marketing Co-Ordinator  
**T:** + 44 28 82 25 11 00  
**F:** + 44 28 82 25 22 11  
**E:** salesenquiries@telestack.com  
**W:** www.telestack.com  
Specialist manufacturers of Mobile bulk material handling systems for the Ports/Inland terminals, Mines, Quarries, Steel Mills, Cement Plants and Powerstation industries globally. The mobile range of equipment offers unrivalled flexibility for the operator, reducing costs in Cap Ex Investment compared to fixed installations, fuel and labour. We have supplied and support some of the world largest blue chip companies.

## Tema BV

PO Box 3220  
Rijswijk  
GE  
2280  
The Netherlands  
**Contact:** Mr M P van Delden  
**T:** + 31 70 390 6555  
**F:** + 31 70 399 3390  
**E:** mp.vandelden@tema.nl  
**W:** www.tema.nl

## TEMA Systems Inc.

7806 Redsky Drive  
Cincinnati  
Ohio  
45249  
USA  
**Contact:** Mr Mike Mullins  
**T:** + 1 513 489 7811  
**F:** + 1 513 489 4817  
**E:** sales@tema.net  
**W:** www.tema.net

## TENOVA S.p.A - Tenova

**Takraf Italy**  
Via Albareto, 31  
Genova  
16153  
Italy  
**Contact:** Mr Pietro Bibolini  
**Job Title:** Commercial Director  
**T:** + 39 010 605 4634  
**F:** + 39 010 605 4710  
**E:** pietro.bibolini@it.tenovagroup.com  
**W:** www.tenovagroup.com  
Key supplier of equipment and systems for open pit mining, bulk and specialized materials handling, milling and crushing, and air pollution control to the global mining and mineral processing industries, and general industry. A comprehensive after sales service is provided.

## Tenova TAKRAF Africa

58 Emerald Parkway Road  
Greenstone Hill Ext. 21  
Johannesburg  
2047  
South Africa  
**Contact:** Mr Peter Cheshire or Ms Kay Subramoney  
**T:** + 27 11 201 2300  
**F:** + 27 11 455 4547  
**E:** TMM@za.tenovagroup.com  
**W:** www.tenovagroup.com  
GLOBAL LEADERS IN BULK MATERIALS HANDLING  
Tenova is a worldwide supplier of advanced technologies, products and engineering services for the iron & steel and mining industries, providing innovative, integrated solutions for complete process areas.

## Terex Cranes c/o Terex Demag GmbH

Dinglerstr. 24  
Zweibrücken  
66482  
Germany  
**Contact:**  
**Job Title:** Global Marketing  
**T:** + 49 6332 83 0  
**F:** + 49 6332 83 1602  
**E:** Info.portequipment@terex.com  
**W:** www.terexcranes.com  
Terex Cranes is the only construction equipment manufacturer to provide you with a full line of cranes and port equipment. Our offering ranges from Reachstackers to Straddle Carriers or Ship to Shore cranes and from compact City Cranes to the biggest crawler crane ever built.

## Terex Deutschland GmbH

  
Industriestr. 3  
Bad Schönborn  
76669  
Germany  
**Contact:** Mrs Maike Schemberg  
**Job Title:** Global Marketing Manager  
**T:** +49 7253 84 431  
**E:** maike.schemberg@terex.com  
**W:** www.terex-fuchs.de  
Established in 1888, Terex Fuchs is a specialist technology provider and global player for loading machines and handling units.



# 17th Coaltrans India™

12 - 14 February 2018 | Grand Hyatt Goa, Goa, India

## Be part of India's largest coal event

### New features:

- The Coal Industry Cricket Tournament
- "Meet the buyers" roundtables session
- "Meet the miners" roundtables session
- Polling session - you create the discussion
- Generation dialogue - exclusive interviews

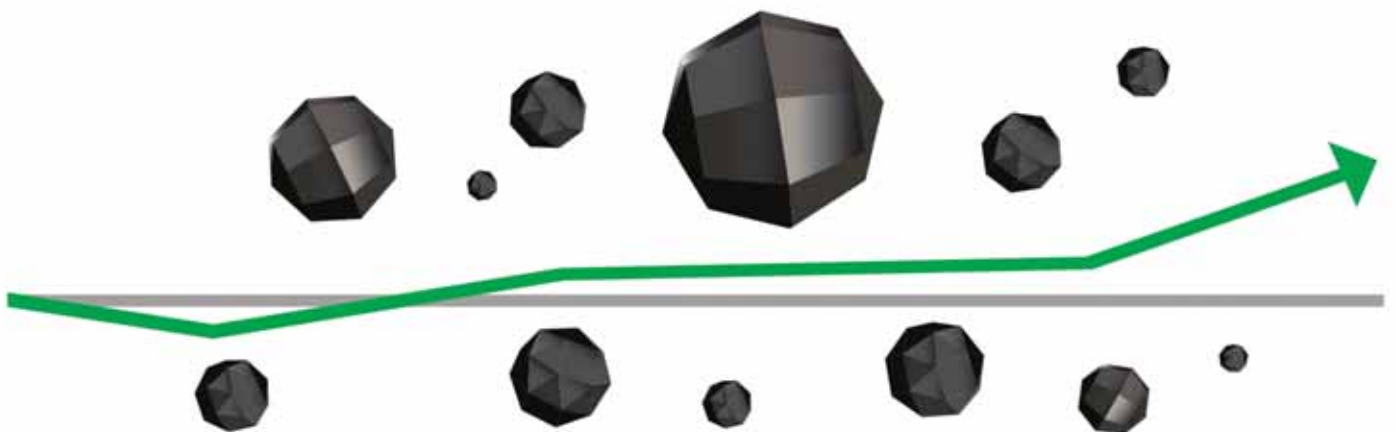



## Terrain Technologies SL

Adosinda 11, 1C  
Gijón 33202  
Spain  
**Contact:** Ms Laura Garrido  
**Job Title:** Innovation Manager  
**T:** + 34 984 05 06 07  
**F:** + 34 984 05 06 06  
**E:** lgarrido@terraintechnologies.com  
**W:** www.terraintechnologies.com  
Terrain Technologies focuses its activity in developing projects and applications in the 3D and GIS fields.  
With an experience of more than 10 years in the mapping field, we are experts in providing customized solutions that fulfill our customers' needs.

## Teta Mühendislik A.Ş.

Çankırı Yolu 7.km Aselsan Karşısı  
Akyurt  
Ankara 06950  
Turkey  
**Contact:** Mr Talat Isik  
**Job Title:** General Manager  
**T:** + 90 312 8475361  
**F:** + 90 312 8475399  
**E:** teta@tetamuh.com.tr  
**W:** www.tetamuh.com.tr  
Engineering, manufacturing and supply of grain storage systems, bagging machines and bulk weighers.

## Teufelberger Seil Ges.m.b.H



Böhmervaldstraße 20  
Wels  
4600

Austria  
**Contact:**  
**T:** + 43 7242 615 0  
**F:** + 43 7242 605 01  
**E:** wireurope@teufelberger.com  
**W:** www.teufelberger.com  
TEUFELBERGER is a globally successful enterprise specializing in the development and production of ropes. Its wide-ranging product portfolio includes steel wire ropes, e.g., for ropeways and cranes, synthetic fiber ropes, e.g., for marine and industrial applications, as well as plastic strapping. In 2014, TEUFELBERGER generated approx. € 182 million in total revenue, about 90% of which came from exports.

## Thames Side Sensors Ltd

Unit 10 io Trade Centre  
Deacon Way  
Reading  
Berkshire  
RG30 6AZ  
UK  
**Contact:** Mrs Maureen Forrester  
**Job Title:** Marketing Manager  
**T:** + 44 1189 411387  
**F:** + 44 1189 458225  
**E:** mforrester@thames-side.co.uk  
**W:** www.thames-side.com  
Thames Side Sensors are the UK Market Leaders in load cells and mounting assemblies for Process Weighing, with an unrivalled reputation for service, flexibility and quality. With over 30 years experience we believe that no-one can match our extensive range and innovative products.

## The BRUKS Group

PO Box 46  
Vastergatan  
Arbrå  
Gävleborg County  
SE-82010  
Sweden  
**Contact:** Mr Lars Lindvall  
**Job Title:** Sales Manager  
**T:** + 46 278 642547  
**F:** + 46 278 642520  
**E:** ll@bruks.com  
**W:** www.bruks.com

## The China Navigation Co. Pte. Ltd

300 Beach road #27-01  
The Concourse  
Singapore 199555  
Singapore  
**Contact:** Mr Richard Sell  
**Job Title:** Commercial Manager  
**T:** + 65 6603 9429  
**E:** Richard.Sell@chinanav.com  
**W:** www.chinanav.com

## The Grab Specialist b.v.

Draaibrugweg 1  
Almere 1332AA  
The Netherlands  
**Contact:** Mr Emiel Bleyenbergh  
**Job Title:** Director  
**T:** + 31 365 32 88 22  
**F:** + 31 365 49 99 22  
**E:** info@tgs-grabs.nl  
**W:** www.tgs-grabs.nl  
TGS manufactures all types of grabs for sale and rental; we have a stock of approx.60 pc.in all sizes. Also repairs can be done for other grabs. TGS is also certified as ISO 9001.

## The Raring Corporation

12007 NE 95th St  
Vancouver  
WA  
98682  
USA  
**Contact:** Mr David L Raring  
**Job Title:** President  
**T:** + 1 360 892 1659  
**F:** + 1 360 892 1624  
**E:** draring@raringcorp.com  
**W:** www.raringcorp.com

## Thermo Fisher Scientific

501 - 90th Avenue NW  
Minneapolis  
MN  
55433  
USA  
**Contact:** Ms Paula Frisk  
**Job Title:** Product Manager/Marketing  
**T:** + 1 800 445 3503  
**F:** + 1 763 783 2525  
**E:** Sales.bulk.us@thermofisher.com  
**W:** www.thermofisher.com/  
bulkweighing  
A leading manufacturer of weighing and monitoring products for the bulk material handling and processing industries, the Thermo Scientific product portfolio includes belt scales, conveyor protection switches, continuous and point level measurement, sampling equipment and tramp metal detectors. Contact us today to improve your process, productivity and profitability.

## THIELE GmbH & Co KG

Werkstrasse 3  
Iserlohn  
D- 58640

Germany  
**Contact:** Mr Norbert Hinkelmann  
**Job Title:** Director Sales -Bulk Material Handling/Project Eng  
**T:** + 49 2371 947 0  
**F:** + 49 2371 947 295  
**E:** bulkmaterial@thiele.de  
**W:** www.thiele.de  
THIELE - More than 80 years of experience in in-house engineering and manufacturing of conveyor chain systems such as round steel chains, bushed conveyor chains, forged conveyor chains and cardan chains, including all attachments. Customised solutions, consulting, inspection, supervision and assembling services from one single source - Made in Germany.

## ThyssenKrupp Canada

1177-11th Avenue SW  
Suite 500  
Calgary  
Alberta  
T2R 1K9  
Canada  
**Contact:** Mr Steve Harrington  
**Job Title:** Vice President Marketing  
**T:** + 1 403 209 4431  
**F:** + 1 403 245 5625  
**E:** infocanada@thyssenkrupp.com  
**W:** www.krupp.ca  
Krupp Canada, located in Calgary, Alberta, has been involved for many years in the design and supply of turnkey, environmentally sensitive mining and material handling projects. The product line of equipment includes: conveying systems, crushing systems, stackers, ship loaders and unloaders, storage and reclamation design and supply.



**ABSOLUTE RELIABILITY  
FOR HARBOR AND SHIPPING  
APPLICATIONS**



Together in Motion

## QS816 V

PLASTIFILL®

SUPERFILL®

GALVANIZED WIRES



## ENGINEERING INNOVATIONS

TEUFELBERGER develops innovative, forward-looking ropes – such as QS816 V. Excellent bending fatigue strength and maximum lifetime make it the perfect choice for shipping and harbor applications.



Industrial Solutions for the mining industry

## Wagon unloading stations.

With more than 100 years of experience our customers benefit from a unique know-how in the field of bulk materials handling. We offer complete wagon unloading stations from single discharge tipplers to quadruple car dumpers with fully automated side arm chargers. Get in touch with us: [info-mh@thyssenkrupp.com](mailto:info-mh@thyssenkrupp.com) [www.thyssenkrupp-industrial-solutions.com](http://www.thyssenkrupp-industrial-solutions.com)

engineering.tomorrow.together.



thyssenkrupp



## thyssenkrupp Industrial Solutions AG



thyssenkrupp

Mining Technologies -OU Materials Handling Germany Ernst-Heckel-Strasse 1 St Ingbert-Rohrbach Saarland D-66386 Germany  
**Contact:**  
 T: + 49 6894 599 0  
 F: + 49 6894 599 468  
 E: Info-mh@thyssenkrupp.com  
 W: www.thyssenkrupp-industrial-solutions.com

More than 100 years of experience in the design, engineering, supply, erection, supervision of erection and commissioning of material handling equipment and systems for the fertilizer and cement industry, for ports as well as complete coal handling plants for power stations.

## ThyssenKrupp Industrial Solutions South Africa - Resource Technologies

71 Nanyuki Road Sunninghill Johannesburg Gauteng 2191 South Africa  
**Contact:** Mr Ralf Hesemann  
**Job Title:** Managing Director  
 T: + 27 11 236 1000  
 F: + 27 11 236 1235  
 E: info.tkr@thyssenkrupp.com  
 W: www.thyssenkrupp-materialshandling.co.za and/or www.thyssenkrupp-industrial-solutions.co.za

Leading OEM of bulk materials handling, minerals processing, cement and lime equipment in Southern Africa. The product range: Stockyard equipment, Port handling equipment, Train/transport systems, Conveyors, Waste disposal solutions, Mining equipment, full range of minerals processing equipment, including crushers, mills, screens, etc. Cement and Lime plants. Laboratory automation for sample processing. ThyssenKrupp Industrial Solutions SA - Resource Technologies has a service and spares department that fully supports all of its machines in the field.

## ThyssenKrupp Robins, Inc.

7730 E. Bellevue Ave Suite #404 Greenwood Village Colorado 80111-5820 USA  
**Contact:** Mr Bill Halley  
**Job Title:** Mechanical Engineer  
 T: + 1 303 770 0808  
 F: + 1 303 770 4522  
 E: bill.halley@thyssenkrupp.com  
 W: www.krupprobins.com  
 ThyssenKrupp Robins, located in Denver, Colorado, has been involved for many years in the design and supply of turnkey, environmentally sensitive mining and material handling projects. The

product line of equipment includes: conveying systems, crushing systems, stackers, ship loaders and unloaders, storage and reclamation design and supply.

## Timars Svets & Smide AB

Industrivagen 12 Falkenberg S-311 33 Sweden  
**Contact:** Mr Peter Stenbeck  
 T: + 46 346 82100  
 F: + 46 346 82800  
 E: info@timars.se  
 W: www.timars.se  
 Specialising in container and bulk cargo handling equipment. Products include bulk material measuring scales, loading bellows, discharge cones and 'Empty Boy' bulk material emptiers.

## TME BV

Hoekerweg 2 Postbus 164 Zwolle 8000 AD The Netherlands  
**Contact:** Mrs Ilke Tollenaar  
**Job Title:** Sales  
 T: + 31 38 425 00 35  
 F: + 31 38 423 42 72  
 E: i.tollenaar@tme.nl  
 W: http://www.tme.nl/

## TMEIC

1325 Electric Road Roanoke Virginia 24018 USA  
**Contact:** Mr Don Samsa  
**Job Title:** Marketing  
 T: + 1 540 283 2000  
 F: + 1 540 283 2001  
 E: don.samsa@tmeic-ge.com  
 W: www.tmeic.com  
 TMEIC is the leading company supplying variable frequency drives, motors and controls for container cranes, in particular for the automation of rail mounted gantry cranes. Equipment manufacture is in Japan.

## TMSA Tecnologia em Movimento S/A

Avenida Bernardino Silveira Pastoriza, 710 Bairro Sarandi Porto Alegre RS 91160-310 Brazil  
**Contact:** Mr Mathias Elter  
**Job Title:** CEO  
 T: + 55 51 2131 3318  
 F: + 55 51 2131 3330  
 E: mathias.elter@tmsa.ind.br  
 W: www.tmsa.ind.br  
 TMSA is the leader in South America supplying grain/meal loading terminals, with references in coal, fertilizer, wood, sugar, iron, ore, coal, alumina, kaolin and other heavy duty commodities up to 4,000tph: conveying equipments for minerals up to 20,000tph 3,100Km, coal up to 2,400tph pipe conveyor 6,800Km.

## Tobu Jukogyo Co., Ltd.

4-12-20, Kitazakae Urayasu City Chiba Pre 279-0002 Japan  
**Contact:** Mr M Yoshida  
**Job Title:** Director  
 T: + 81 473 525311

F: + 81 473 525316  
 E: info@tobugrab.com  
 W: www.tobugrab.com

## Top Lift Int

21 Teal Ave Stormy Creek Ontario L8E 2P1 Canada  
**Contact:** Mr Joel Paikin  
**Job Title:** Sales Director  
 T: + 1 905 662 4137 ext 14  
 F: + 1 905 662 8058  
 E: jpaikin@toplift.com

## Tramco Europe Limited

Mendham Business Park Hull Road Saltend Hull HU12 8DZ UK  
**Contact:** Mr Dave Fanthorpe  
**Job Title:** General Manager  
 T: + 44 1482 782 666/ + 44 7813 800251  
 F: + 44 1482 793 920  
 E: David@tramcoeuropa.co.uk  
 W: www.tramcoeuropa.com  
 Tramco Europe Ltd Design and manufacture chain and belt conveyors that deliver! Our products are all ATEX approved, robust, reliable and designed to handle severe processing applications. Our variety of designs allows flexibility to specify the size of conveyor for your capacity, at the best value.

## Tramco, Inc

1020 East 19th Street Wichita KS 67214 USA  
**Contact:** Mr Ben Cott  
**Job Title:** Sales Product Manager  
 T: + 1 316 264 4604  
 F: + 1 316 264 7965  
 E: sales@tramcoinc.com  
 W: www.tramcoinc.com  
 TRAMCO has been involved in the design, application, engineering and manufacture of the worlds most complete line of chain conveyors, enclosed belt conveyors, specially designed conveyors and conveyor conversions since 1967. The combination of design, engineering, proper component selection, manufacturing, and after-sales service makes TRAMCO the source for consulting and supply in bulk material handling situations.

## Trans Elektro

Spuieweg 8a Waalwijk N-Br 5145NE The Netherlands  
**Contact:** Mr Ronald van Egeraat  
**Job Title:** Business Development  
 T: + 31 416 34 00 16  
 F: + 31 416 56 07 90  
 E: egeraat@transelektro.nl  
 W: www.transelektro.com

## Transas Marine

Datavagen 37 Askim Gothenburg 42632 Sweden  
**Contact:** Ms Lidia Selivanova  
 T: + 46 31 769 56 00  
 F: + 46 31 69 41 84  
 E: info@transas.com  
 W: www.transas.com

Transas is a world-leading developer and supplier of a wide range of software and integrated solutions for the transportation industry. The company's range of high-technology products includes onboard navigation systems, a broad range of maritime simulators, vessel traffic solutions.

## Trans-Global Solutions, Inc.

5255 N Twin City Hwy Nederland TX 77627 USA  
**Contact:** Mr William Scott  
**Job Title:** Vice President  
 T: + 1 409 727 4801  
 F: + 1 409 729 1132  
 E: wfscott@tsgroup.com  
 W: www.tsgroup.com

## Translift Port Equipment Services Inc

Building 3 SRF Area Subic Bay Zambales Freeport Zone 2222 Philippines  
**Contact:** Mr John Wellington  
**Job Title:** Managing Director  
 T: + 63 47 252 6332/4/5  
 F: + 63 47 252 6336  
 E: translift@transliftsubic.com

## Transship LTD

Marazlievskaya Str, 8 Odessa 65014 Ukraine  
**Contact:** Mr Eugene Mashtakov  
 T: + 380 482 33 33 32  
 F: + 38 482 34 74 07  
 E: e.mashtakov@transship.ua  
 W: www.transship.com.ua

## Transystems Corporation

101 West Main Street, Suite 900 Norfolk Virginia VA 23510 USA  
**Contact:** Mr Brian Larson  
**Job Title:** Chairman  
 T: + 1 757 627 1112  
 F: + 1 757 672 1113  
 E: brgarcia@transystems.com  
 W: www.transystems.com  
 TranSystems Corporation specializes in condition assessments, maintenance and design of maritime facilities including container terminals, intermodal rail facilities, passenger and cruise terminals, break-bulk and neo bulk terminals and mixed-used developments. TranSystems is recognized in the United States and internationally for their innovative and cost-effective solutions for the maritime industry.

## TRF Limited (TATA)

11 Station Road Burma Mines Jamshedpur

Jharkhand 831 007 India  
**Contact:** Mr Rajen Sahay  
**Job Title:** Head of Corporate Communications  
 T: + 91 657 3046 407  
 E: rajen.sahay@trf.co.in  
 W: www.trf.co.in / www.tata.com/company/profile/TRF  
 An engineering company with expertise in the field of bulk material handling and processing. Its products include ship loaders handling iron ore and other bulk products.

## Triodetic

10 Didak Drive Amprior Ontario K7S 0C3 Canada  
**Contact:** Mr Tim Staniszewski  
**Job Title:** Sales & Marketing Manager  
 T: + 1 613 623 3434 ext 2234  
 F: + 1 613 622 4003  
 E: info@triodetic.com  
 W: www.triodetic.com  
 Designs, manufactures and constructs stockpile enclosures, Geodesic Domes and Barrel Vaults. A network of connected Steel, Aluminum or Stainless Steel tubes as a space frame or single layer shell in any required geometric configuration. The product is pre-engineered and comes to site with protective coatings appropriate to the service life requirements.

## Triple Point Technology

PO Box 495 Newcastle NSW 2300 Australia  
**Contact:** Mr Steve Maxwell  
**Job Title:** GVICE President, Mining, APAC Sales  
 T: + 61 2 4908 2222  
 F: + 61 2 4968 2043  
 E: info@tpt.com  
 W: www.tpt.com  
 Triple Point Technology® is the leading global provider of cloud and on-premise Commodity Management software. Triple Point's QMASTOR solutions manage the tonnage, quality and value of coal and mineral supply chains from "pit" to the point of export, import, or consumption.

## TS Systems BV

PO Box 206 De Giessen 19 Dronten 8253 PR The Netherlands  
**Contact:** Mr Peter Slotje  
 T: + 31 321 33 90 91  
 F: + 31 321 33 99 88  
 E: info@tsystems.nl  
 W: www.tssystem.nl  
 European distributor of steel and stainless steel FLOVEYOR Aero-mechanical conveying systems capable of moving up to 50 tonnes per hour.





**VAN AALST**

## Tailor made ship unloaders in any size

Van Aalst Bulk Handling is a flexible organization directed to assist its customers with tailor made solutions for their loading, unloading and pneumatic conveying projects. Van Aalst Bulk Handling provides design and technical engineering, manufacturing and supply of equipment and installation supervision. The customer can rely on one experienced and reliable source.

**Always Interested. Van Aalst Bulk Handling.**



**Road mobile ship  
unloaders up to  
250 tons per hour**



**Bulk handling  
equipment for  
dusty abrasive  
materials like  
cement, fly ash,  
alumina**

**Pneumatic ship  
unloaders with  
high capacity  
up to 800 tons  
per hour**



**Ship loading systems  
from 200 up to  
1.000 tons per hour**



**Also Interested?**

T +31(0)172 213 341

E [info@vanaalstbulkhandling.com](mailto:info@vanaalstbulkhandling.com)

[VANAALSTBULKHANDLING.COM](http://VANAALSTBULKHANDLING.COM)





## ts-systemfilter gmbh

Gänsäcker 9  
Ahorn-Berolzheim  
74744  
Germany  
**Contact:** Mr H Straub  
**T:** + 49 6296 880  
**F:** + 49 6296 8855  
**E:** info@ts-systemfilter.de  
**W:** www.ts-systemfilter.de  
Produces filter units with dust separation equipment.

## Tsubaki Kabelschlepp GmbH

Daimlerstr. 2  
Wenden-Gerlingen  
D-57482  
Germany  
**Contact:** Mr Frank Springer  
**T:** + 49 2762 4003 0  
**F:** + 49 2762 4003 220  
**E:** info@kabelschlepp.de  
**W:** www.kabelschlepp.de  
Plastic and Steel Cable Carrier Systems, LIFE-LINE Cables.

## Tsubakimoto Bulk Systems Corporation

Ryokuchieki Building 7F,  
2-4-1, Terauchi,  
Toyonaka  
Toyonaka  
Osaka  
561-0872  
Japan  
**Contact:** Mr Y Horii  
**Job Title:** Overseas Business Dept.  
**T:** + 81 6 6862 2329  
**F:** + 81 6 6862 8516  
**E:** sales@tsubaki-bulk.com  
**W:** http://tsubakimoto.com/tbs/  
Produces bulk handling systems equipment, bucket, flow and pan conveyors.

## Tsuji Heavy Industries (Jiangsu) Co Ltd

Du Jing Gang, Da Xin Zhen, Zhang Jia Gang  
Along Yang tze river, Economy & Development Zone  
Zhang Jia Gang  
215636  
China  
**Contact:** Mr Yang Yen Yoong  
**Job Title:** Dy. General Manager (Marketing & Sales)  
**T:** + 86 512 58713111  
**F:** + 81 0512 5873170  
**E:** yang@tsuji-hi.com.cn  
**W:** www.tsuji-hi.com.cn

## TTS (Transportation Technology Systems) LLC

60F Darzciema Street  
Riga  
LV-1073  
Latvia  
**Contact:** Mr Alex Menschikov  
**Job Title:** Sales Europe  
**T:** + 371 6713 8267  
**F:** + 371 6713 8365  
**E:** alex.menschikov@tts.lv  
**W:** www.tts.lv  
"TTS", along with its affiliates from LNK Group, has great experience in solving complex tasks in production, construction and erection of industrial objects like port terminals and vast types of material handling equipment and large scale metal structures. We'll be glad to use our knowledge to accomplish your task!

## TTS HuaHai Ships Equipment

18th Floor  
3255 Zhou Jia Zui Road  
Shanghai  
200093  
China

**Contact:** Mr Lian Zhou Yang  
**Job Title:** Business Development Manager  
**T:** + 86 21 6539 8257  
**F:** + 86 21 6539 7400  
**E:** info@ts-huahai.com

## TTS Marine AS

Barstolveien 26  
Kristiansand  
4606  
Norway  
**Contact:** Mr. Peter Klasson  
**Job Title:** Communications & Marketing Coordinator  
**T:** + 47 55 94 74 08  
**F:** + 47 55 94 74 01  
**E:** info@tts-marine.no  
**W:** www.ttsgroup.com

## TTS Marine INC

14730 Vickery Drive  
Houston  
Texas  
77032  
USA  
**Contact:** Mr Torsten Paas  
**Job Title:** General Manager  
**T:** + 1 281 227 5999  
**F:** + 1 281 227 5998  
**E:** info@tts-se.us  
**W:** www.ttsgroup.com

## TTX Corporation

101 N Wacker Drive  
Chicago  
Illinois  
60606  
USA  
**Contact:** Mr Peter Wolf  
**Job Title:** Director - Market Development  
**T:** + 1 312 984 3722  
**F:** + 1 312 984 2682  
**E:** marketing@ttx.com  
**W:** www.ttx.com

## Tufbag

PO Box 155  
Mandini  
KwaZulu Natal  
4490  
South Africa  
**Contact:** Mr Russell Titmas  
**Job Title:** National Sales Manager  
**T:** + 27 32 459 5050  
**F:** + 27 32 459 2581  
**E:** russell.titmas@tufbag.com  
**W:** http://tufbag.com  
Produce woven polypropylene FIBC's and small WPP open mouth and valved sacks, including the Adstar® product with block bottom and valves. Our Polypropylene sacks and bags are currently used for the packaging of commodities such as cement, sugar, rice, wheat, maize flour, salt, fertilisers, animal feeds and cotton seeds.

## Turck B.V.

Ruiterlaan 7  
Zwolle  
8019 BN  
The Netherlands  
**Contact:** Mr Frank de Jong  
**T:** + 31 38 4227750  
**F:** + 31 38 4227451  
**E:** frank.dejong@turck.com  
**W:** www.turck.nl  
Turck is a leading manufacturer in industrial automation. With an enormously versatile range of more than 13,000 sensor, fieldbus, interface and connectivity products, Turck offers highly efficient product solutions for factory and process automation.

## U.S. Tsubaki Power Transmission, LLC

301 E. Marquardt Dr.  
Wheeling  
IL  
60090

USA  
**Contact:** Ms Tiffany Milliken  
**Job Title:** Marketing Communications Analyst  
**T:** +1 847 353 0351  
**E:** tiffanymilliken@ustsubaki.com  
**W:** www.ustsubaki.com

## United DC

8947 Market Street  
Houston  
TX 77029  
USA  
**Contact:** Mr Ben Levine  
**Job Title:** President  
**T:** + 1 713 671 8200  
**F:** + 1 713 671 8224

## V D D B (Pty) Ltd

PO Box 16985  
Lyttelton  
Gauteng  
0140  
South Africa  
**Contact:** Mr Leonard van der Dussen  
**T:** + 27 12 664 2300  
**F:** + 27 12 644 2902  
**E:** admin@vddb.co.za  
**W:** www.vddb.co.za  
Engineering and design of optimised air-supported belt conveyors.

## Van Aalst Bulk Handling BV



Engelandlaan 56  
Hazerswoude Dorp  
2391 PN  
The Netherlands  
**Contact:** Ms Timara van Lingen  
**Job Title:** Marketing Manager  
**T:** + 31 172 213 341  
**F:** + 31 172 232 804  
**E:** tvlingen@vanaalstbulkhandling.com  
**W:** www.vanaalstbulkhandling.com  
**BULK CEMENT HANDLING:** Specialized in design and supply of equipment for pneumatic bulk handling of dusty abrasive products like cement and fly ash. The main products of Van Aalst Bulk Handling are ship unloaders, ship loaders, convey units and silo's. All equipment is made to measure and developed in close cooperation with the end users.

## Van Aalst Marine & Offshore B.V.

Baanhoekweg 16  
Dordrecht  
3313 LA  
The Netherlands  
**Contact:** Ing. Wijnand van Aalst  
**Job Title:** Managing Director  
**T:** + 31 78 622 1304  
**F:** + 31 78 622 9490  
**E:** wijnand@vanaalstmarine.com  
**W:** www.vanaalstbulkhandling.com  
Specialist in pneumatic bulk handling equipment for loading, unloading, conveying and storing of powders and dusty or abrasive materials such as cement, fly ash, alumina, etc. A service oriented and flexible organisation with offices all over the world.



## Van Beek bv

Christiaan Huygensweg 20  
Drunen 5151 DN  
The Netherlands

**Contact:** Ms Cynthia Meijer  
**T:** + 31 416 375 225  
**F:** + 31 416 378 350  
**E:** info@van-beek.nl

**W:** www.van-beek.nl

The bulk truck loader, Dino®, is used to load a wide range of bulk goods with divergent specific properties - either packaged in loose bags or big bags. Its capacity of 40 - 90 cubic metres per hour makes it possible to load a silo

in an hour.

## Veenstra Machinefabriek B.V.

De Holwert 10  
KC Coevorden  
7741KC

The Netherlands

**Contact:** Mr Jan Koerts

**T:** + 31 524 599 333

**F:** + 31 524 599 330

**E:** info@veenstragroup.nl

**W:** www.veenstragroup.nl

Custom made bulkhandling specialist.

Product range includes; airslides,

valves, discharge systems and fluidising systems.

## VEN SA

19 Chemin du Blanc Caillou  
Braine-L'Alleud  
B-1420

Belgium

**Contact:** Mr Roderick Norman

**T:** + 32 2 384 20 27

**F:** + 32 2 385 15 88

**E:** ven@skynet.be

## Ventomatic SPA

Via G. Marconi, 20  
Valbrembo

24030

Italy

**Contact:** Mrs Nicolette Cattaneo

**Job Title:** Marketing Manager

**T:** + 39 035 468 311

**F:** + 39 035 528 027 / + 39 35 4608 38

**E:** vento@ventomatic.it

**W:** www.ventomatic.it

## Ventyx

193 Turbot Street

Brisbane

Queensland

4000

Australia

**Contact:** Mr Greg Clark

**Job Title:** CEO

**T:** + 61 7 3303 3333

**F:** + 61 7 3303 3232

**E:** info@mincom.com

**W:** www.ventyx.com

## Verachtert Nederland

### B.V.

De Bloemendaal 8  
EC's Hertogenbosch  
Noord Brabant  
5221

The Netherlands

**Contact:** Mr Rudy van Leeuwen

**Job Title:** Director

**T:** + 31 73 640 41 11

**F:** + 31 36 529 85 94

**E:** Info@dcc-grabs.nl

**W:** www.verachtert.nl

DCC-Grabs designs, develops and manufactures grabs for the dry bulk cargo-, dredging- and recycling industry. DCC's main objective is to ensure that their grabs underscore added value for the client.

Innovative design and product development are guaranteed at DCC-Grabs.

## Verstegen Grijpers BV



PO Box 1014

Nieuwegein

3430 BA

The Netherlands

**Contact:** Mr Eric Visser

**Job Title:** Managing Director

**T:** + 31 3060 62222

**F:** + 31 3060 60657

**E:** info@verstegen.net

**W:** www.verstegen.net

Specialists in developing, designing and manufacturing all kinds of grabs. A leading grab manufacturer with extensive experience whose grabs are in operation all over the world. More than 10,000 grabs have been manufactured for all kinds of materials and applications and delivered to 80 countries worldwide.





# WORLDWIDE NUMBER ONE IN ROPE-OPERATED GRABS

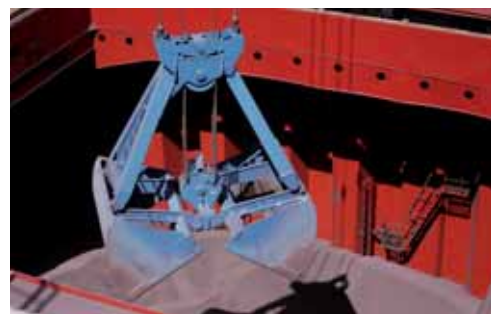

## Are you looking for a new grab?

Please contact us. At Verstegen we are fully specialised in rope-operated mechanical grabs. Our goal is to provide the optimal grab for your specific operation. A new Verstegen grab leads to higher production rates and lower maintenance costs through extreme reliability and long lifetimes. Tell us how you want to improve your operation and together we will find the best solution.

Visit us at [www.verstegen.net](http://www.verstegen.net)



**VERSTEGEN**

**TOGETHER WE GRAB MORE**

**Verstegen Grippers B.V.  
The Netherlands**

[WWW.VERSTEGEN.NET](http://WWW.VERSTEGEN.NET)



# Pneumatic or Mechanical Ship Loaders & Unloaders Port Equipment - Turnkey Projects

**PNEUMATIC SHIP UNLOADERS :**  
From 100 to 800 tons/hour  
All sizes of vessels • All types of grains



*PORTABLE GRAIN PUMPS up  
to 270 t/h*

*PNEUMATIC BARGE  
UNLOADER up to 600 t/h*

*LOADER  
up to 2000 t/h*

*SIMPORTER  
up to 1500 t/h*



*Reliability, Efficiency, Quality,  
Efficiency, Quality, Reliability,  
Quality, Reliability, Efficiency...*





## Vibco Inc

75 Stillson Road  
Wyoming  
RI  
02898  
USA  
**Contact:** Ms Lisa F Huftalen  
**Job Title:** Marketing & Design Services  
**T:** + 1 401 539 2392  
**F:** + 1 401 539 2584  
**E:** lhuftalen@vibco.com  
**W:** www.vibco.com

## Vibrafloor

Za 27 Rue de la Tuilerie  
Dracy-le-Fort  
71640  
France  
**Contact:** Mr Jean-Claude Poncet  
**Job Title:** President  
**T:** + 33 3 85 44 06 78  
**F:** + 33 3 85 44 06 79  
**E:** jc.poncet@vibrafloor.com  
**W:** www.vibrafloor.com  
VIBRAFLOOR, the modular vibrating floor, is used in various bulk industries, inside silos, ships and railway cars as a versatile reclaiming using powered gravity.

## VIGAN



Rue de L'Industrie 16  
Nivelles  
B-1400  
Belgium  
**Contact:** Mr Nicolas Dechamps  
**Job Title:** Managing Director  
**T:** + 32 67 89 50 41  
**F:** + 32 67 89 50 60  
**E:** info@vigan.com  
**W:** www.vigan.com  
VIGAN ENGINEERING designs and manufactures bulk materials handling systems for agribulk cargo (mainly cereals), some chemicals, woodpellets...  
VIGAN expertise covers complete turnkey solutions - from project engineering to commissioning- for port terminals, including ship unloading & loading, storage facilities and bagging operations. Complete information and references on <http://www.vigan.com>

## Vitelli srl

Via del Campono 72/74  
Porto Santo Stefano  
Italy

**Contact:** Mr Giorgio Vitelli  
**Job Title:** Sales Manager  
**T:** + 39 0564 814436  
**F:** + 39 0564 816676  
**E:** giorgio.vitelli@vitellisrl.it  
**W:** www.vitellisrl.it

## Vollert Anlagenbau GmbH

Stadtseestr. 12  
Weinsberg  
74189  
Germany  
**Contact:** Mr Juergen Schiemer  
**Job Title:** Vice President  
**T:** + 49 7134 52 232  
**F:** + 49 7134 52 222  
**E:** juergen.schiemer@vollert.de  
**W:** www.vollert.com  
For over 80 years Vollert is worldwide acting as competent engineers and supplier of shunting equipment. For each shunting problem Vollert provides robust, low-maintenance and individual system solutions capable of being automated and above all at very reasonable prices. Vollert provides the perfect solution for moving wagons.

## Vortex Global

Building 1J  
Enterprise House  
Valley North Street

Darlington  
DL1 1GY  
UK  
**Contact:** Ms Lisa Johnson  
**Job Title:** Media & Communications Manager  
**T:** + 44 1325 728 577  
**E:** ljohnson@vortexglobal.com  
**W:** www.vortexglobal.com

Vortex manufactures quality slide gates, diverters, and loading spouts for dry bulk solids in gravity flow or pneumatic conveying systems. All products are designed for dependability, durability and easy maintenance helping customers save time and money. Vortex is the brand choice among many industries including grain and cement.

## Vossloh Kiepe GmbH

Kiepe-Platz 1  
Düsseldorf  
D-40599  
Germany  
**Contact:** Mr Rainer Luehring  
**Job Title:** Head of Sales Industrial Components  
**T:** + 49 211 7497 265  
**F:** + 49 211 7497 1265  
**E:** r.luehring@kiepe-elektrik.com  
**W:** www.kiepe-elektrik.com  
VOSSLOH KIEPE is a leading supplier of pull wire switches, belt drift switches and speed monitoring

devices for the control of belt conveyors. The trade mark KIEPE is worldwide a synonym for proven products of highest quality.

## VSR Industrietechnik GmbH

Am Alten Schacht 6  
Duisburg D-47198  
Germany  
**Contact:** Mr Wolfgang Schlabach  
**Job Title:** Export Manager  
**T:** + 49 20 66 99 66 40  
**F:** + 49 20 66 99 66 62  
**E:** info@vsr-industrietechnik.de  
**W:** www.vsr-industrietechnik.de  
VSR Blaster products have been proving themselves in the bulk handling business for more than 35 years and are recognised for their extensive expertise, high effectiveness and dependability. The conveyor belt solutions found in the Dustex, Vibrex, Carex and Linex systems improve the conveying quality and are environmentally friendly.



## WeatherSolve Structures



2A-27355 Gloucester Way  
Langley  
British Columbia V4W 3Z8  
Canada

**Contact:** Mr Mike Robinson  
**T:** + 1 604 607 7781  
**F:** + 1 604 909 1914

**E:** go@WeatherSolve.com

**W:** www.weathersolve.com

With machinery working and the wind blowing, dust is everywhere. So control the wind and control the dust. A typical WeatherSolve wind fence is 80% efficient, and it works 24 hours a day, that's a huge amount of control. With minimal to no maintenance at all, that's an easy solution! WeatherSolve Structures specialized in the design and manufacturing of industrial dust & wind control structures.

## Webster Griffin Ltd

Brooklands Park  
Farmingham Road  
Crowborough  
East Sussex TN6 2JD  
UK

**Contact:** Ms Jo Smith  
**T:** + 44 1892 664250  
**F:** + 44 1892 664340

**E:** info@webstergiffin.com

**W:** www.webstergiffin.com

Webster Griffin are a leading supplier of modular bagging machinery. We manufacture modular and mobile bagging systems ideal for high speed 'on-the-spot' dock side filling of fertilizer, grain, sand, sugar, rice into small bags and sacks.

## Wellasiana Technology Co, Ltd

4F, No.196, Sec 2 Ta Tung Road  
Hsi-Chih Dist.  
New Taipei City  
Keelung City  
22184

Taiwan

**Contact:** Mrs Janet Shentu

**Job Title:** Managing Director

**T:** + 886 2 2649 3196

**F:** + 886 2 2649 3182

**E:** trading@evermontgroup.com

## Windmüller & Hölscher KG

Münsterstr. 50

Lengerich

D-49525

Germany

**Contact:** Mrs Elisabeth Braumann

**Job Title:** Public Relations

**T:** + 49 5481 14 2929

**F:** + 49 5481 14 3355

**E:** elisabeth.braumann@

wuh-group.de

**W:** www.wuh-group.com/

Windmüller & Hölscher - one of the leading machine manufacturers in the world for the flexible packaging industry and the global leader in bag making and bagging equipment.

## Winning Alliance (s) Pte Ltd

6 Shenton Way  
OUE Downtown 2,  
#17-09

Singapore 068809  
Singapore

**Contact:** Mr Wang Chuangyang

**Job Title:** General Manager

**T:** + 65 97765877

**F:** + 65 63230027

**E:** wangchuangyang@

winninglogistic.com

**W:** www.winninggroup.com.sg

## Wirtech AG

Zelgstrasse 86

Uetendorf CH-3661

Switzerland

**Contact:** Mr K Buehler

**Job Title:** Marketing

**T:** + 41 33 346 5050

**F:** + 41 33 346 5059

**E:** info@wirtech.ch

**W:** www.wirtech.ch

## WIRTGEN Group

Reinhard-Wirtgen-Str. 2

Windhagen 53578

Germany

**Contact:** Mr Martin Heitz

**Job Title:** Head of Marketing

**T:** + 49 2645 131 7321

**F:** + 49 2645 131 499

**E:** pr@wirtgen-group.com

**W:** www.wirtgen-group.de

## Wolf Point Engineers & Contractors

One North LaSalle Street

Suite 4000

Chicago

IL

60602

USA

**Contact:** Mr Robert Williams

**Job Title:** Vice President of Sales

and Marketing

**T:** + 1 312 508 5550

**E:** bob.williams@wpengrs.com

**W:** www.wolfpointengineers.com/

*This 28m-high fence from WeatherSolve is being used to protect coal piles from the wind, and to prevent the escape of fugitive dust. Note the thicker mesh at the bottom of the fence.*





## Dry cargoes need windfences!



32m high fence for mountainside port storage



Fence integrated with doors and conveyors



Fence with roof for easily blown dust

A windfence is a porous screen upwind and/or downwind of the stockpile that filters the wind and controls your valuable dust

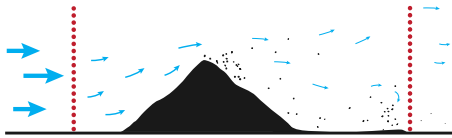

Fence incorporated with retaining wall



Hopper fence in conjunction with fog system



1.5km fence in marine environment



Discover more, email:  
[cargo@weathersolve.com](mailto:cargo@weathersolve.com)

**WeatherSolve**  
**Structures**



*We care about what we promise*

2A - 27355 Gloucester Way  
Langley, BC, Canada, V4W 3Z8  
T: +1 604.607.7781  
TF: 800.749.2201  
F: +1 604.909.1914  
E: [cargo@weathersolve.com](mailto:cargo@weathersolve.com)  
[www.weathersolve.com](http://www.weathersolve.com)



## Worley Parsons Canada (Westmar)

400-233 West First Street  
North Vancouver  
BC  
V7M 1B3  
Canada

**Contact:** Mr Stanley Cowdell

**Job Title:** President

**T:** + 1 604 985 6488

**F:** + 1 604 985 2581

**E:** info@westmar.com

**W:** www.westmar.com

Multi-disciplinary consulting firm with design expertise in the maritime, civil, structural, mechanical and environmental fields associated with bulk materials handling, utilising state-of-the-art computer simulation for the planning and optimisation of bulk terminals and transportation systems.

## WorleyParsons

8133 Warden Avenue  
Markham  
ON L6G1B3  
Canada

**Contact:** Mr Jeremy Okolsan

**Job Title:** Director, Business

Development

**T:** + 1 905 940 4774

**F:** + 1 905 940 4778

**E:** jeremy.okolsan@worleyparsons.com

**W:** www.worleyparsons.com

Additional services include: Ports & Marine Terminal Planning, Transportation Studies and Supply Chain Logistics, Marine Structure Design (inshore and offshore), Coastal Processes, Cold Weather (Arctic) Engineering including Ice

Management, Site Development and Civil Infrastructure, Terminal Waste Water Treatment & Management, Environmental Assessment and Management, Contaminated Sites and Waste Management, Condition Inspections and Asset Management

## Wuvio Chemicals International

wuvio



Honderdland 150

Maasdijk

Zuid-Holland

2267 LT

The Netherlands

**Contact:** Mr Marck Hagen

**Job Title:** Director

**T:** + 31 1745 200 01

**F:** + 31 1745 200 03

**E:** info@wuvio.com

**W:** www.wuvio.com

Wuvio Chemicals was founded in 2003 in the Netherlands and engages in dust and odor control and sanitization in industrial environment. Wuvio Chemicals develops dust solutions by utilizing biodegradable chemicals and proprietary technologies in innovative ways.

## Yernaux-Passage

Zone Industrielle Beraugard PB  
552

Brive Cedex

19107

France

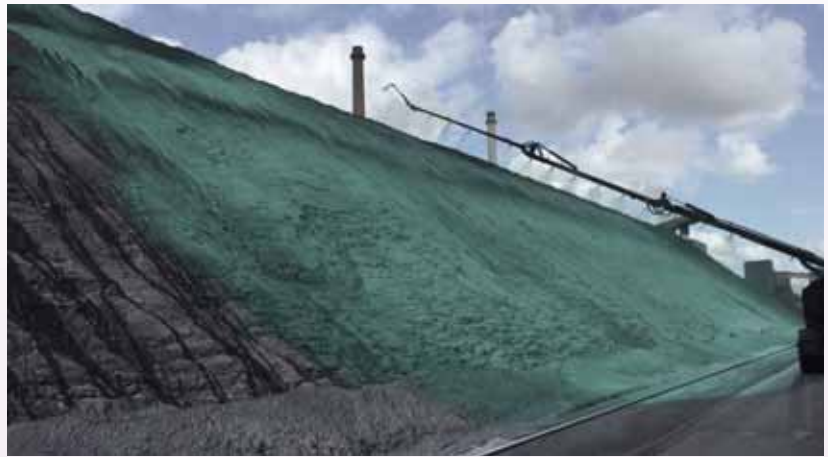

**Contact:** Mr Willy Banc

**Job Title:** Marketing Department

**T:** + 33 475 66 4600

**F:** + 33 555 860 563

**E:** willy.banc@preciamolens.fr

## Yokohama Rubber Co

MB Overseas Sales Dept

6-1-11 Shimbashi Minato-Ku

Tokyo

105-8656

Japan

**Contact:** Mr Funakoshi

**Job Title:** Marketing

**T:** + 81 3 5400 4816

**F:** + 81 3 5400 4830

**E:** yinfo@mta.yrc.co.jp

## Young Industries Inc

PO Box 30

16 Painter Street

Muncy

PA

17756

USA

**Contact:** Mr William Mahoney

**T:** + 1 570 546 3165

**F:** + 1 570 546 1888

**E:** mktinfo@younginds.com

**W:** www.younginds.com

Manufacturer of dilute and dense phase pneumatic conveying and bulk materials processing systems and equipment.

## ZAO SMM

1/64 Grivsova Street

Saint-Petersburg

197000

Russia

**Contact:** Mr Sergey Pokrovsky

**Job Title:** Commercial Director

**T:** + 792 19373311

**E:** sergey@zaosmm.ru

**W:** www.zaosmm.ru

## Zhengzhou Ellsen Machinery Equipments Co.,Ltd

Building2.Roman Holiday,No 159,  
Garden Road, JinshuiDist.  
Zhengzhou  
China

**T:** + 86 371 55036316

**E:** enquiry@cnellsen.com

**W:** www.cnellsen.com

# Wuvio deals with dust.

Deal with dust and clean up your operations. Our easy to use solutions help you create a healthy workplace, keep your neighbours happy and save you money.

Wuvio foam, crust and humidifying agents combat and reduce dust during transport, processing and storage of dry bulk goods.

Want to know more? Call +31 174 520 001

sales@wuvio.com | www.wuvio.com





# BULK HANDLING EQUIPMENT COMPANIES – ALPHABETICAL LISTING

- KEY:**
- SL = Shiploaders
  - CR = Cranes
  - GL/U = Grab Loaders/Unloaders
  - MCSU = Mechanical CSUs
  - PSU = Pneumatic ship unloaders
  - BL/U = Barge loaders/unloaders
  - GR = Grabs
  - MCN = Mechanical conveyors
  - PCN = Pneumatic conveyors
  - CnCp = Conveyor components
  - ST/R = Stackers & reclaimers
  - MBE = Mobile bulk handling equipment
  - HP = Hoppers
  - CRu/S = Crushing & Screening
  - WGH = Weighing
  - SM/I = Sampling & inspection
  - DC = Dust control/suppression
  - DV/C = Drives & controls
  - STG = Storage systems
  - RH = Rail handling
  - TH = Truck handling
  - SU = Self unloading shipping equipment
  - ENG = Engineering consultants
  - BAG = Bag handling
  - OTH = Other equipment



	SL	CR	GL/U	MCSU	PSU	BL/U	GR	MCN	PCN	CnCp	ST/R	MBE	HP	CRu/S	WGH	SM/I	DC	DV/C	STG	RH	TH	SU	ENG	BAG	OTH
2000 Engineering																									
4B BRAIME Components																									
A. Friedr Flender AG																									
A/S Cimbría																									
AAF Ltd																									
AAL																									
ABB AB																									
ABB Engineering (Shanghai) Ltd.																									
ABB Switzerland Ltd																									
Abbey Rollers Limited																									
Abraaj																									
AC Robinson & Associates																									
Achenbach GmbH Metalltechnik																									
Advance Automated Systems Ltd																									
AE AntiEmission GmbH																									
AE Automation (M) Sdn bhd																									
Aeromaster International Ltd																									
AFM Industries																									
Ag Growth International (AGI)																									
Agora Services																									
Agrico Sales, Inc.																									
Agromatic AG																									
AJ Edmond Company																									
AJ Sackett & Sons Company																									
AKJ Industries																									
Alex Stewart Agriculture Ltd																									
Alex Stewart International Corporation Ltd																									
Algoma Central Corporation																									
All-Fill International Ltd																									
Allison Engineering Ltd																									
ALS Inspection																									
ALTA, Co																									
Amec Foster Wheeler																									
AMECO SA																									
Anindya																									

	SL	CR	GL/U	MCSU	PSU	BL/U	GR	MCN	PCN	CnCp	ST/R	MBE	HP	CRu/S	WGH	SM/I	DC	DV/C	STG	RH	TH	SU	ENG	BAG	OTH
Antar@Pressvess																									
ANUPAM INDUSTRIES LIMITED																									
Anvil Attachments																									
Applied Conveyor Technology, Inc. DBA The ACT Group																									
Aristoncavi																									
Ariona Engineering																									
Arodo BVBA																									
Artelia																									
AS LNK Industries																									
AS Marine																									
ASGCO "Complete Conveyor Solutions"																									
ASGCO Manufacturing																									
Ashton Bulk Ltd																									
ATD Stramproy BV																									
ATIC Services																									
Atlas Manufacturing Co. Inc																									
August Penkert GmbH																									
AUMUND Foerdertechnik (AUMUND Group)																									
Aurecon																									
Ausenco Engineering Canada Inc.																									
AusGroup Limited																									
Australian Superintendence Company																									
Avplast Dis Tic. Ve Paz. Ltd. Sti.																									
AW Process																									
B.V. BECO																									
Babcock & Wilcox Loibl GmbH																									
Bagfilla SA Pty Ltd																									
Bauer Gear Motor																									
Bayards Aluminium Constructions																									
Bedeschi Mid-West Conveyor																									
Bedeschi SpA																									
BEHN + BATES Maschinenfabrik GmbH & Co. KG																									
Beijing HaoSheng Transmission Technology Co., Ltd.																									
Bekaert NV																									
Belt Equipment Supplies Sdn Bhd																									
Bemo Rail BV																									
Bendezu Port Equipment GmbH																									
Benetech GmbH																									
Benetech USA																									
Bergu International AB																									
Best Service Group (B.S.G.) bvba																									
Beumer Group GmbH & Co KG																									
BGS Holland																									
Binder + Co AG																									
Birrus International Pty Ltd																									
Blue Water Misting																									
BLUG Credeblug S.L.																									
BMT Baxter Eadie Ltd																									
BMT De Beer																									
Bogaert Transmission (GEHA)																									
Boh Bros. Construction Co., LLC																									
Bonfanti srl																									
Bosch Rexroth AG																									
Bosch Rexroth B.V.																									
Bosch Rexroth Mellansel AB																									
BossTek																									
Boyne Area Manufacturing (BAM)																									
Brelko Conveyor Products																									
Bretby Gammatech Ltd.																									
Bridgestone Industrial Limited																									
Bridon International Ltd																									
Brock Grain Systems																									
BRUKS AB																									
BRUKS Klöckner GmbH																									
BRUKS Rockwood Incorporation																									
BSG Resources																									
Bucket Mart Inc.																									
Buhler AG, Grain Logistics																									
Buhler GmbH																									
Bulk Cargo Handling BVBA																									
Bulk Lift International																									
BULK.ID																									
Buttimer Engineering																									
ByM Agencia Martima																									
C Spencer Ltd																									
C. Christophel GmbH																									
Cable Arm Inc																									
Cachapuz Bilanciai Group																									
Calim Grab Industry																									



	SL	CR	GL/U	MCSU	PSU	BL/U	GR	MCN	PCN	Cn Cp	ST/R	MBE	HP	CRu/S	WGH	SM/I	DC	DV/C	STG	RH	TH	SU	ENG	BAG	OTH
Camar Mill Systems Ltd																									
Cambelt International Corp																									
Capotex																									
Captrain Deutschland GmbH																									
Carbonser, S. A. DE C. V.																									
Cardno TEC																									
Cargotec Sweden AB, Marine Selfunloaders																									
Carlsen Group																									
Carmatec AB																									
CASE CNH Industrial																									
Cassantec AG																									
Caterpillar Belgium																									
Caterpillar Inc																									
Caterpillar SARL																									
Cavotec Deutschland GmbH																									
Cavotec Inc																									
Cavotec SA																									
CDM Systems, Inc																									
CH2M Hill																									
Changsha Kaiyan Instruments Co. Ltd																									
CHIA Espirales.es																									
Chief Industries UK Ltd.																									
Chief Industries, Inc.																									
China Sonangol International (S) Pte Ltd																									
CHL Equipment Ltd (incorp. Versteegen Grabs UK)																									
Christianson Systems Inc.																									
CICSA & MCV s.r.l.																									
Cimbria Unigrain A/S																									
CINTASA S.A.																									
Cita Logistics LLC																									
Cita Logistics LLC																									
Civettini Italo & c sas (CFS Handling)																									
Clariant Corporation																									
Clarke Chapman Manufacturing Ltd																									
Claudius Peters Projects GmbH																									
Claudius Peters Technologies S.A.S																									
CLC Technology Enterprise Co Ltd																									
Cleveland Cascades Ltd																									
Clime SA																									
Clough Limited																									
CNBM International Engineering Co., Ltd.																									
CNK INTERNATIONAL LIMITED																									
Coal & Mineral Technologies (SABS)																									
COBRA Europe SA																									
Coeclerici Logistics S.p.A.																									
Coles Associates																									
Comercial Tauro S.A.																									
Condepols S.A.																									
Conductix -Wampfler Australia																									
Conductix-Wampfler																									
Conductix-Wampfler Americas																									
Conitex Sonoco																									
Conservatek Industries, Inc.																									
Continental Construction (Memphis)																									
Continental Conveyor & Equipment Co Inc																									
CONTINENTAL MATADOR RUBBER, s.r.o.																									
ContiTech Transportbandsysteme GmbH																									
Control Systems Technology Pty Ltd																									
Conveyor Dynamics, Inc.																									
Cornell & Co Inc																									
Cotecna Inspection SA																									
Cotesi SA																									
CPS Projects (Pty) Ltd																									
Cranes Machinery Co., Ltd(CMC)																									
Crippen Manufacturing Company																									
CSL Americas																									
CST Covers																									
CST Storage																									
CTI Group Inc																									
CTP Team Srl																									
Custom Equipment Design, Inc.																									
CWA Engineers Inc.																									
Cygnus Instruments Limited																									
Dalian Huarui Heavy Industry International CO., LTD																									
Damen Shipyards Gorinchem																									
Dantherm Filtration Ltd																									
DAWSON																									
DCL, Incorporated																									
DCW Group Co																									
De Regt Conveyor Systems																									
Demag Cranes & Components GmbH																									

	SL	CR	GL/U	MCSU	PSU	BL/U	GR	MEN	PCN	CnCp	ST/R	MBE	HP	CRu/S	WGH	SM/I	DC	DV/C	STG	RH	TH	SU	ENG	BAG	OTH	
DeMarco Industrial Vacuum Corporation																										
DemcoTECH Engineering																										
Den Bakker Dustcrusting Technology b.v. (dbd global b.v.)																										
Deutsche Großwälzlager GmbH																										
Dinnissen BV																										
DMN-WESTINGHOUSE																										
Dome Corp of North America																										
Dome Technology, LLC																										
DOMTEC International LLC																										
Don Valley Engineering Co Ltd																										
Donaldson Filtration (GB) Ltd																										
Donaldson Filtration Deutschland GmbH																										
Doosan Benelux SA																										
Doppelmayr Transport Technology GmbH																										
Dos Santos International, LLC																										
Dosco Overseas Engineering Ltd																										
Dosetec Exact Oy																										
Doubrava Ges GmbH																										
Doyle Manufacturing Co																										
Draka Automotive GmbH																										
DRC Engineering																										
Dry Bulk Solutions																										
Dry-Bag A/S																										
DS SM a/s																										
DSG Consultants																										
DSH Systems Ltd.																										
Dulevo International S.p.A.																										
Dunlop Conveyor Belting																										
DURO FELGUERA, S.A.																										
Dust Solutions Inc																										
E-Crane World Wide / E-Crane International USA																										
E-Crane Worldwide																										
ECS Eurocargo Services AS																										
EDGE INNOVATE. (NI) LTD																										
Egis Ports																										
EIFFEL Etablissement SOMDEL																										
Elecon Engineering Company Ltd																										
Elecon Singapore PTE Ltd.																										
Electro-Motive Diesel (EMD) Inc																										
Elgin Engineering and Construction																										
ELME Spreader AB																										
Emaq-Verolme Estaleiros SA																										
EMDE INDUSTRIE-TECHNIK																										
EMS-Tech Inc																										
EMS-Tech Inc.																										
EMTICI Engineering Co Ltd																										
Enco Engineering Inc																										
Endress + Hauser Inc																										
Engicon nv																										
Engineering System Solutions																										
Enso-Gutzeit Oy																										
Entecon UK Ltd																										
Enviro Abrasion Resistant Engineers Pvt. Ltd																										
EPN Solutions																										
EQ Trade																										
EQUIPO LLC																										
Eriez Europe																										
Esch Group bv																										
ESI Eurosilto BV																										
Essar Industries																										
Euromec Srl																										
Euro-tech Corporation																										
Euro-Tramco BV																										
EXP.Com																										
F E Schulte Strathaus GmbH & Co KG																										
F L Smidth A/S																										
Fairport Engineering																										
FAM Canada Inc																										
FAM Magdeburger Förderanlagen & Baumaschinen GmbH																										
Famak SA																										
Fantuzzi Reggiane S.p.a																										
FELD Maschinen-und Industriebau GmbH																										
FEMADIGIPACK S.r.l																										
Fenner Dunlop Conveyor Belting Europe																										
Fenner plc																										
FFE Ltd																										
Figee Crane Services BV																										
Flexco																										



	SL	CR	GL/U	MCSU	PSU	BL/U	GR	MCN	PCN	Cn Cp	ST/R	MBE	HP	CRu/S	WGH	SM/I	DC	DIV/C	STG	RH	TH	SU	ENG	BAG	OTH
Flexco Europe GmbH																									
Flexicon Corporation																									
Flexicon Europe Ltd																									
Flexoveyor Conveyor																									
Flomat Bagfilla International Limited																									
Flowrox Oy																									
FLSmith GmbH																									
FLSmith Inc.																									
FLSmith Minerals Pvt. Ltd																									
FLSmith Wadgassen GmbH																									
FMC Corporation																									
Fortum Power and Heat OY																									
FPS Mustang																									
Franz Wölfer Elektromaschinenfabrik Osnabrück GmbH																									
Freudenberg Technical Supply (Sin) Pte Ltd																									
Frigate Technologies Private Limited																									
Gama Endustri Tesisleri Imalat Ve Montaj AS																									
Gambarotta Gschwend																									
Gantrex Inc.																									
Ganz Danubius Trading Co Ltd																									
Garwood Consulting Ltd																									
Gearbulk Maritima Ltda																									
General Bridge Engineering Ltd																									
General Kinematics Corp.																									
Geo - Chem Laboratories Pvt. Ltd																									
Geometrica Inc																									
Geroldinger GmbH & Co KG																									
Gertech Handling Systems cc																									
Getriebbau NORD GmbH & Co. KG																									
GF MHS Srl																									
GGT Goldengrain Trading SA																									
Gibbons Engineering Group Ltd																									
Golden West Industries																									
Golfetto Sangati s.r.l.																									
Goodman Conveyor Company																									
Goodtech AS																									
Gordinne & Co NV/SA																									
Gottwald Port Technology USA																									
GraviLoad Limited																									
GREIF-VELOX																									
Greystones Cargo Systems (Pty) Ltd																									
Gubre Fabrikalari TAS																									
Gulsan A.p.																									
Guttridge Limited																									
Guyen Grab and Machine Ltd. Co																									
H J Wiefierink BV																									
H Noorman BV																									
Halcrow																									
Hangzhou Huaxin Mechanical & Electrical Eng'g Co., Ltd.																									
Hans Turck GmbH & Co. KG																									
Hansen Industrial Transmissions (HIT) nv																									
Hanson Silo Company																									
Hapman																									
Hasel Machinery Inc																									
Haskoning India Pvt Ltd																									
HASLER GROUP SAS																									
HAUGEN System AB																									
Haver & Boecker OHG, Wire Weaving Division																									
HAVER & BOECKER OHG, Machinery Division																									
HAVER NIAGARA GmbH																									
Hebei Xinrong Rubber Products Co., Ltd																									
Heinrich Schacke gmbh & co kg																									
HEKO Ketten GmbH																									
Henry International Diplomatic Marine																									
Heyl & Patterson																									
Hitachi Construction Machinery (Europe) NV																									
HKD Blue																									
Horizon Conveyor Equipment																									
HOSCH-Fördertechnik Recklinghausen GmbH																									
HPC Hamburg Port Consulting GmbH																									
Huadian Heavy Industries Co., Ltd.																									
Hycontrol Limited																									
Hyundai Heavy Industries Co																									
IBAU HAMBURG																									
IBC International Handling AB																									
IEM FörderTechnik GmbH																									
Igus GmbH																									
IHI Transport Machinery Covan ., Ltd. (IUK)																									
IMASA																									

	SL	CR	GL/U	MCSU	PSU	BL/U	GR	MEN	PCN	CnCp	ST/R	MBE	HP	CRu/S	WGH	SM/I	DC	DV/C	STG	RH	TH	SU	ENG	BAG	OTH	
IMGS																										
IMO Germany																										
Imperial Technologies, Inc.																										
Impsa - Industrias Metalurgicas Pescarmana																										
Incolab Services BV																										
Indexator Rotator Systems AB																										
Industrial Netting (Pty) Ltd																										
Industrias Murtra																										
Inman SA																										
Inspectorate (Suisse) SA - Bureau Veritas Commodities Div																										
Inspectorate America Corporation																										
Inspectorate International Ltd																										
Instral B.V.																										
Interjute BV																										
Intermodal Solutions Pty Ltd																										
International Bulk Handling Technology BV																										
Interstate Equipment Corporation																										
Intersystems																										
Intertek Group plc																										
Intertek Testing Services																										
Invicta Vibrators																										
iSAM AG Gesellschaft fuer angewandte Kybernetik																										
Isomonte SA																										
Istop Spamat Sri																										
Italgru S.r.l																										
J & B Grabs b.v.																										
J C Steele & Sons Inc																										
J. Poulsen Shipping USA																										
James A. Redding Company																										
Jansen & Heuning																										
Jansens & Dieperink BV																										
JCB																										
JEM International																										
Jenike & Johanson Inc.																										
JFE Engineering Corporation																										
Jiangsu Zhendong Port Machinery Manufacturing Co., Ltd.																										
Jim Way Enterprise Co., Ltd																										
Johannes Hübner Fabrik elektrischer Maschinen GmbH																										
John R Boone Ltd Industrial Mixers																										
Joy Global Inc																										
JSC RIKON																										
JSC Tehnoros																										
Jumbo Shipping																										
Kalenborn Kalprotect GmbH & Co. KG																										
KCT Grab Industry																										
Kinergy Corporation																										
King Bag & Manufacturing Co																										
Kingfisher Industrial Ltd																										
KINSHOFER GmbH																										
Kiruna Wagon AB																										
Kleemann GmbH																										
Knight Energy Services Limited																										
Kocks ARDELTA KRANBAU GmbH																										
KOCKS ARDELTA KRANBAU GmbH																										
Komatsu Mining Corp.																										
Konecranes (France)																										
Konecranes B.V. - The Netherlands																										
Konecranes Finland Corporation																										
Konecranes Hafentechnik GmbH																										
Konecranes Port Solutions																										
Kornylak Corporation																										
KPI-JCI and Astec Mobile Screens																										
Kramer & Duyvis BV																										
KRANUNION GmbH																										
Krech Ojard & Assoc																										
Kröger Greifertechnik GmbH & Co. KG																										
Kuiken N.V.																										
Lachenmeier Monsun A/S																										
Laidig Systems Inc																										
Laing O'Rourke																										
Langston Companies Inc																										
Lanier & Associates																										
Larsen & Toubro Limited																										
Larsen & Toubro Limited																										
Lassing Dikken Consulting Engineers Ltd																										
Lawrence Industries, Inc.																										
LBU Marine & Cranes																										
Legacy Building Solutions, Inc.																										
Libran Engineering and Services																										
Librawerk Maschinenfabrik GmbH																										



	SL	CR	GL/U	MCSU	PSU	BL/U	GR	MCN	PCN	Cn Cp	ST/R	MBE	HP	CRu/S	WGH	SM/I	DC	DV/C	STG	RH	TH	SU	ENG	BAG	OTH	
Liebherr-Danmark ApS																										
Liebherr-Hydraulikbagger GmbH																										
Liebherr-MCCTec Rostock GmbH																										
Liebherr-Singapore Pte Ltd																										
Liebherr-Werk Bischofshofen GmbH																										
Lion Bulk Handling b.v.																										
Listenow GmbH & Co.																										
LOC																										
LT LIGHTING CO.,LTD																										
Lycopodium																										
Macawber Engineering, Inc																										
MacGREGOR Group AB																										
MacGregor SWE AB																										
Mack Manufacturing Inc																										
Mactenn Systems Ltd.																										
Mahr GmbH Anlagentechnik für Schuttgüter																										
Manitowoc Engineering																										
Mantsinen Group Ltd Oy																										
Mantsinen Group Ltd Oy																										
Maquinas Condor SA																										
Marine Inspection and Logistics																										
Marine Inspection LLC																										
Maritime Strategies International																										
Marsden Weighing Machine Group Ltd																										
Martin Engineering																										
Martin Engineering c/o GSFA Consulting																										
Martin Engineering GmbH																										
Martin Engineering South Africa																										
Maschinen und Mühlenbau Erhard Muhr GmbH																										
Matcon																										
MATEC massagoed techniek BV																										
Material Handling Asia																										
Matrix PDM Engineering																										
MegaRoller																										
Mentor Dynamics																										
Merius Oy																										
Merrick Industries																										
Metso Minerals Industries, Inc.																										
MH Automation International Ltd																										
Midwest Industrial Supply Inc																										
Midwest International Standard Products, Inc.																										
Millard Maritime																										
Minebea Intec GmbH																										
Mitchell Consulting Group, Inc																										
Mitsubishi Heavy Industries																										
Mitsubishi Nagasaki Machinery																										
Mitsui Engineering & Shipbuilding Co																										
Mitsui Miike Machinery Co., Ltd.																										
Mitsui Zosen Europe Limited																										
Mobile Conveying Systems																										
Moffatt & Nichol																										
Mogensen Sizers																										
Mole•Master Services Corporation™																										
Möllers Maschinenfabrik GmbH																										
Monolithic Dome Institute																										
Monotube Pile Corp.																										
Motherwell Automation																										
Motion Metrics																										
Motridal SpA																										
MRS Greifer GmbH																										
Mühlen Sohn GmbH & Co. KG																										
Muller Beltex BV																										
Multidocker																										
Musco Lighting																										
MUT - Maschinen-Umweltechnik Transportanlagen																										
MWI Silo Systems Inc.																										
Nanhua Electronics Co.,Ltd																										
Nantong UP Machinery Engineering Co., Ltd																										
National Bulk Equipment Inc																										
National Ports Corporation Limited																										
Natural Grabs																										
NAVCO (National Air Vibrator Co)																										
Nectar Group Ltd																										
Negrini Srl																										
Nemag BV																										
NEO CORP BRASIL																										
NERAK GmbH Fördertechnik																										
Neuero Industrietechnik GmbH																										

# BULK HANDLING EQUIPMENT

	SL	CR	GL/U	MCSU	PSU	BL/U	GR	MEN	PCN	CrCp	ST/R	MBE	HP	CRu/S	WGH	SM/I	DC	DV/C	STG	RH	TH	SU	ENG	BAG	OTH
Nilfisk SpA																									
NILLOS GmbH & Co KG																									
NK Tehnologija SIA																									
NKM Noell Special Cranes GmbH																									
NM Heilig BV																									
NMH s.r.o																									
Noell Crane Systems (China) Ltd																									
Nordströms Konstruktionsbyrå																									
Nordstrong Equipment Ltd																									
North American Crushing & Screening, LLC																									
Northern Conveyors																									
N-service ApS.																									
NSL Engineering Pte Ltd																									
O B Wiik AS																									
o.z. HENNLICH ENGINEERING																									
Oceanport Shiploaders Ltd																									
Offshore Bulk Terminal Pte Ltd																									
Oldendorff Carriers GmbH & Co. KG																									
OMIC Perth																									
Onestone Consulting Group GmbH																									
OP system ab																									
Orthos Projects Ltd.																									
ORTS GmbH Maschinenfabrik																									
Oxbow Energy Solutions BV																									
P.T. Mitra S.K. Analisa testama																									
PAGE MACRAE ENGINEERING																									
Pakiet																									
Parker Plant Ltd																									
Parsons Brinckerhoff																									
Paul Hedfeld GmbH																									
PEBCO®																									
Peinemann Cranes																									
PEINER SMAG Lifting Technologies GmbH																									
Peterson Agricare & Bulk Logistics BV																									
PetroKab LLC																									
Pfister Waagen Bilanciai GmbH																									
PHB Weserhütte, S.A.																									
Phelps Industries																									
PHOENIX Conveyor Belt Systems GmbH																									
Phoenix Terminal Solutions																									
PINTSCH BUBENZER GmbH																									
Pirs SAS																									
PIV Drives GmbH - a Brevini Power Transmission Co.																									
Plastruct-Polyzone																									
PLM Cranes B.V.																									
PMC Projects (India) Pvt. Ltd.																									
Pneumat Systems Inc																									
Polymer Industries - Ultrapolpy Division																									
Port Contractors																									
Portasilo Ltd																									
Portpack UK Limited																									
Portside Solutions Pty Ltd																									
Port-Trade AS																									
Powerscreen																									
Powerdex Inc																									
Precia-Molen Nederland BV																									
Precia-Molen UK Ltd																									
Premier Tech Chronos																									
Premier Tech Chronos b.v.																									
Premier Tech Chronos GmbH																									
Premier Tech Chronos Ltd																									
Primasonics International Limited																									
Procon Engineering Limited																									
Protan International																									
PSTek LLC																									
PT Armada Rock Karunia Transshipment																									
PT Bajra Mandalasakti																									
PT Bukaka Teknik Utama																									
PT Carsurin																									
PT CCIC Jakarta																									
PT Geoservices																									
PT Jakarta Prima Cranes																									
PT MacGregor Indonesia																									
PT Mitra Bahtera Segarasejati																									
PT Pamapersada Nusantara																									
PT SpanSet Indonesia																									
PT Thiess Contractors Indonesia																									
PT Trans Power Marine Tbk																									
PT. Anugrah Lautan Luas																									



	SL	CR	GL/U	MCSU	PSU	BL/U	GR	MCN	PCN	Cn Cp	ST/R	MBE	HP	CRu/S	WGH	SM/I	DC	DIV/C	STG	RH	TH	SU	ENG	BAG	OTH	
PT. Bando Indonesia																										
PT. Meratus Advance Maritim																										
PT. Thermalindo Sarana Labortoria																										
PT. Winning Logistik Indonesia																										
Qingdao Huaxia Rubber Industry Co. Ltd.																										
Quadrant Engineering Plastics Products																										
Quadrant EPP																										
Quadrant PHS																										
Quality Handling Systems Pty Ltd																										
Qube Ports & Bulk																										
R & S S.r.L.																										
RAM SMAG Lifting Technologies																										
RAP Conveyors Ltd																										
Rapat Asia																										
Rapat Corporation																										
Rapidpack Corporation																										
RBL-REI France																										
RC Inspection B.V																										
RDS Technology (Topcon Technology Ltd)																										
Redaelli Tecna S.p.A.																										
REEL Alesa Ltd																										
REEL Alesa Ltd																										
REMA TIP TOP AG																										
Renby Ltd																										
Representaciones Alfredo Brand y Cia. Ltda.																										
Rexnord Industries Inc																										
RHC Deutschland GmbH																										
RHC Heavy Machinery Ltd																										
Richwood Industries, Inc.																										
Risun Technologies																										
Ritchie Bros																										
RJS Siloclean International Ltd																										
RKR Gebläse und Verdichter GmbH																										
Roberts & Schaefer Company																										
Robson Handling Technology Ltd																										
RockTree Logistics Pte. Ltd.																										
Ronin GMS																										
Royal Bodewes																										
Royal Haskoning DHV																										
Rubb Buildings Ltd																										
RUD Kettenfabrik Rieger & Dietz GmbH & Co. KG																										
RULMECA HOLDING S.P.A.																										
SABS - Mining & Minerals																										
SAI Gulf																										
Saiag Industria SpA																										
Saipem SA																										
Sammi																										
Sampling Associates International																										
SAMSON Materials Handling Ltd (AUMUND Group)																										
Sandvik Mining																										
Sandvik Mining and Construction																										
Sandvik Mining and Construction (China) Co., Ltd.																										
SANWA COMMERCIAL CO., LTD.																										
Saxlund International Ltd																										
SCAFCO Corporation																										
Scantech International																										
SCHADE Lagertechnik (AUMUND Group)																										
Schenck Process																										
Schenck Process Africa (Pty) Limited																										
Schenck Process UK Limited																										
Schneider Electric																										
Schouten Commodities BV																										
Schrage Rohrkettensystem GmbH Conveying Systems																										
Scorpio Engineering Pvt. Ltd																										
Sea Spec International																										
Sea Transport Corporation																										
Seabulk Inc																										
S-E-G Instrument AB																										
Selpeco Resources Inc.																										
Sempertrans France Belting Technology SAS																										
SENNEBOGEN Maschinenfabrik GmbH																										
Sensor Technology Ltd																										
SERAM																										
Servo Berkel Prior																										
SESCOTRANS For Developed Logistics (SAE)																										
SEW-EURODRIVE GmbH & Co KG																										
SGH Equipment Limited																										
SGS																										
SGS (Nederland) BV																										

	SL	CR	GL/U	MCSU	PSU	BL/U	GR	MEN	PCN	CnCp	ST/R	MBE	HP	CRu/S	WGH	SM/I	DC	DV/C	STG	RH	TH	SU	ENG	BAG	OTH
SGS Australia Pty Ltd																									
SGS Minerals Services																									
SGS Minerals Services																									
Shandong Lingong Machinery																									
Shanghai Global Machinery Co., Ltd (SGMC)																									
Shanghai Guan Hai Engineering Co.,Ltd																									
Shanghai Janus Grab Co., Ltd.																									
Shanghai Peiner Smag Machinery Co.,Ltd																									
Shanghai Qifan Co., Ltd.																									
Shanghai Yo-Pi Port Machinery Co. LTD																									
Shanghai Zhenhua Port Machinery Co (ZPMC) Ltd																									
Shanthi International																									
Shaw Almix Canada																									
SIBRE - Siegerland Bremsen GmbH																									
SIDERAR / TERNIUM																									
Siebtechnik GmbH																									
Siemens AG International																									
Siemens Nederland NV																									
SIG Società Italiana Gomma Spa																									
Silvan Dis Ve IC Ticaret AS																									
Sime Industrie																									
Simplicity Projects Pvt Ltd																									
Siwertell AB																									
Sly Incorporated																									
SMB International GmbH																									
Smiley Monroe Ltd																									
SMM-UM Sociedade de Montagens Metalomecanicas SA																									
Societe de Tolerie Industrielle Francaise																									
Solimar Pneumatics																									
Solitec Engineering Ltd																									
Sotecma inc																									
Specimas																									
Spiroflow Ltd																									
STAG AG																									
Standard Industrie																									
Starlinger & Co. Gesellschaft m.b.H.																									
STATEC BINDER GmbH																									
Stemm Equipos Industriales, S.L.																									
Stemm Equipos Industriales, S.L.																									
Stevenel OY																									
Stewart Inspection and Analysis (Pty) Ltd																									
STM srl																									
Stock Equipment Company																									
Stockpile Surveying and Protection BVBA																									
Stokman BV																									
Stora Enso																									
Strudes Inc																									
STUDIO TECNICO MALNATI SAS																									
Sub Con Ltd																									
Sucofindo																									
Sumitomo Heavy Industries Material Handling Systems																									
Suomen Viljava Oy																									
Supercargo, Lda																									
Superior Industries, Inc.																									
Svendborg Brakes USA, LLC																									
Swire CTM Bulk Logistics																									
Sympatec																									
Synergy Engineering Ltd																									
TAIM WESER, S.A.																									
TAKRAF GmbH																									
TAKRAF India Pvt. Ltd.																									
Tank Connection																									
Taurus Emergé																									
TBA Doncaster																									
TBMA Europe BV																									
TBS Shipping Services																									
Tebodin Consultants & Engineers																									
Tebodin Netherlands B.V.																									
techNaero aps																									
Tecnicconsult SpA																									
Telesack Limited																									
Tema BV																									
TEMA Systems Inc.																									
TENOVA S.p.A - Tenova Takraf Italy																									
Tenova TAKRAF Africa																									
Terex Cranes c/o Terex Demag GmbH																									
Terex Deutschland GmbH																									
Terrain Technologies SL																									



	SL	CR	GL/U	MCSU	PSU	BL/U	GR	MCN	PCN	CnCp	ST/R	MBE	HP	CRu/S	WGH	SM/I	DC	DV/C	STG	RH	TH	SU	ENG	BAG	OTH
Teta Mühendislik A. .																									
Teufelberger Seil Ges.m.b.H																									
Thames Side Sensors Ltd																									
The BRUKS Group																									
The China Navigation Co. Pte. Ltd																									
The Grab Specialist b.v.																									
The Raring Corporation																									
Thermo Fisher Scientific																									
THIELE GmbH & Co KG																									
ThyssenKrupp Canada																									
thyssenkrupp Industrial Solutions AG																									
ThyssenKrupp Industrial Solutions South Africa - Resource Technologies																									
ThyssenKrupp Robins, Inc.																									
Timars Svets & Smide AB																									
TME BV																									
TMEIC																									
TMSA Tecnologia em Movimentação S/A																									
Tobu Jukogyo Co., Ltd.																									
Top Lift Int																									
Tramco Europe Limited																									
Tramco, Inc																									
Trans Elektro																									
Transas Marine																									
Trans-Global Solutions, Inc.																									
Translift Port Equipment Services Inc																									
Transship LTD																									
Transystems Corporation																									
TRF Limited (TATA)																									
Triodetic																									
Triple Point Technology																									
TS Systems BV																									
ts-systemfilter gmbh																									
Tsubaki Kabelschlepp GmbH																									
Tsubakimoto Bulk Systems Corporation																									
Tsuji Heavy Industries (Jiangsu) Co Ltd																									
TTS (Transportation Technology Systems) LLC																									
TTS HuaHai Ships Equipment																									
TTS Marine AS																									
TTS Marine INC																									
TTX Corporation																									
Tufbag																									
Turck B.V.																									
U.S. Tsubaki Power Transmission, LLC																									
United DC																									
V D D B (Pty) Ltd																									
Van Aalst Bulk Handling BV																									
Van Aalst Marine & Offshore B.V.																									
Van Beek bv																									
Veenstra Machinefabriek B.V.																									
VEN SA																									
Ventomatic SPA																									
Ventyx																									
Verachtert Nederland B.V.																									
Verstegen Grijpers BV																									
Vibro Inc																									
Vibrafloor																									
Vigan																									
Vitelli srl																									
Vollert Anlagenbau GmbH																									
Vortex Global																									
Vossloh Kiepe GmbH																									
VSR Industrietechnik GmbH																									
WeatherSolve Structures																									
Webster Griffin Ltd																									
Wellasiana Technology Co, Ltd																									
Windmüller & Hölscher KG																									
Winning Alliance (s) Pte Ltd																									
Wirtech AG																									
WIRTGEN Group																									
Wolf Point Engineers & Contractors																									
Worley Parsons Canada (Westmar)																									
WorleyParsons																									
Wuvio Chemicals International																									
Yernaux-Passage																									
Yokohama Rubber Co																									
Young Industries Inc																									
ZAO SMM																									
Zhengzhou Ellsen Machinery Equipments Co.,Ltd																									



**100%** Starlinger  
**rPET**  
*Flakes*

## FROM BOTTLE TO BIG BAG

rPET FIBCs – the sustainable solution for bulk material logistics!

Made from 100 % recycled PET bottle flakes or pellets, rPET FIBCs feature high creep resistance, long-term form stability, less bulging, excellent abrasion resistance. Perfect for hot-fill and food-grade applications, rPET FIBCs can be used as high-performance big bags and are a cost-cutting alternative to FIBCs such as octabins or drums. Fully recyclable and reusable.

Visit us at:  
Plastimagen, Mexico City, November 7 - 10, Booth 414 and 830



  
**Starlinger**

Starlinger Head Office:  
Sonnenuhrgasse 4, 1060 Vienna, Austria  
T: + 43 1 59955, F: -25, office@starlinger.com  
www.starlinger.com  
A member of Starlinger Group

textile packaging | consumer bags | recycling technology | viscotec



## FIBC & BAG MANUFACTURING



©Beumer.

### AUSTRALIA

#### Bulk Handling Australia Pty Ltd

45 Centre Way  
Croydon South  
Victoria 3136  
Australia

**Contact:** Mr Ian Shaw  
**Job Title:** Managing Director  
**T:** + 61 3 9839 7635  
**F:** + 61 3 9761 4558  
**E:** ishaw@bha.com.au  
**W:** www.bha.com.au

### AUSTRIA

#### Mondi Industrial Bags GmbH

Marxergasse 4A  
Vienna  
A-1030  
Austria

**Contact:** Mrs Doris Kainz  
**Job Title:** Marketing Manager  
Europe & International  
**T:** + 43 1 79523 4057  
**F:** + 43 1 79013 960  
**E:** doris.kainz@mondigroup.com  
**W:** www.mondigroup.com/  
Mondi Industrial Bags offers the full range of industrial paper bags. With 36 operations in 28 countries we can serve our clients in the cement & building materials, chemicals, food & feed & seed industries wherever they need us

#### Starlinger & Co. Gesellschaft m.b.H.



#### Starlinger

Sonnenuhrgrasse 4  
Vienna  
A-1060  
Austria  
**Contact:** Mr Christian Leeb

**Job Title:** Sales Director  
**T:** + 43 1 599 55 0  
**F:** + 43 1 599 55 180  
**E:** sales@starlinger.com  
**W:** www.starlinger.com  
Starlinger ranks among the world's leading suppliers of machinery and process technology for woven plastic sack production. The Austria-based company provides extrusion lines as well as heavy-duty circular looms for FIBC production out of PP as well as PET and - most recently - rPET flakes.

### BELGIUM

#### Arodo BVBA

Hoge Mauw 740  
Arendonk  
B-2370  
Belgium

**Contact:** Mr Jan-Mathijs van Noort  
**T:** + 32 14 672 332  
**F:** + 32 14 671 760  
**E:** sales@arodo.be  
**W:** http://www.arodo.com

#### Bekintex NV

Industriepark Kwatrecht -  
Neerhonderd 16  
Wetteren  
9230  
Belgium

**Contact:** Ms Ilse Veldeman  
**Job Title:** Marketing Assisant  
**T:** + 32 9 365 7111  
**F:** + 32 9 365 7117  
**E:** ilse.veldeman@bekaert.com  
**W:** www.bekaert.com

#### Combopack NV

Bedrijvencentrum Waasland  
IndustriePark West 75  
St Niklaas B9100  
Belgium

**Contact:** Mr Can Sarac  
**Job Title:** Managing Director  
**T:** + 32 3 780 1732  
**F:** + 32 3 766 5825  
**E:** info@combopack.be  
**W:** www.combopack.be

### BRAZIL

#### NEO CORP BRASIL

Avenida Bento Munhoz da Rocha Neto, N°:1777  
Jardim Samambaia  
Paranaguá-PR  
83212-000  
Brazil

**Contact:** Mr Christopher Paolo  
**T:** + 55 41 3122 5771  
**E:** christopher@neocorpbr.com.br  
**W:** http://www.ncbr.com.br/

### BULGARIA

#### Assenova Krepost

2 Ivan Vazov Str  
Blagoevgrad  
4230  
Bulgaria

**Contact:** Mrs Amaudo  
**T:** + 359 331 223 95  
**F:** + 359 331 263 75  
**E:** admin@ceebd.com

### CANADA

#### Syn-Tex Bag

211 Hutchings Street  
Winnipeg  
Manitoba  
R2X 2R4  
Canada

**Contact:** Mr Ed Cavenagh  
**Job Title:** Operations Manager  
**T:** + 1 204 632 5667  
**F:** + 1 204 633 4125  
**E:** ecavenagh@syntexbag.com  
**W:** www.syntexbag.com

### CHINA

#### Changzhou Quick Way FIBC Ltd

Flat C, 12/F.  
18 Cao Xi Bei Road  
Shanghai  
200030  
China

**Contact:** Mr Kim Bi  
**Job Title:** Sales Manager  
**T:** + 86 21 5489 2602  
**E:** qwsale@quickway.com.cn  
**W:** www.czquickway.com

### CZECH

### REPUBLIC

#### LANEX Packaging s.r.o.

Hlucinska 93  
Bolatice  
747 23  
Czech Republic

**Contact:** Mr Martin Postuka  
**Job Title:** Sales Manager  
**T:** + 420 563 751 325  
**F:** + 420 724 654 151  
**E:** martin.postulka@lanex.cz  
**W:** www.lanex.cz

### DENMARK

#### Dry-Bag A/S

Dalagarde 1  
Aarhus C  
DK 8000  
Denmark

**Contact:** Mr Soren  
**Job Title:** Marketing  
**T:** + 45 86 19 0500  
**F:** + 45 86 19 0577

**E:** production@dry-bag.dk  
**W:** www.desiccant.com

### GERMANY

#### EFIBCA

Kaiser-Friedrich-Promenade 43  
Bad Homburg 61348  
Germany

**Contact:** Ms Kerstin Meggert  
**Job Title:** EFIBCA Secretariat  
**T:** + 49 61 7292 6665  
**F:** + 49 61 7292 6670  
**E:** k.meggert@kunststoffverpackungen.de  
**W:** www.efibca.com

#### EMDE INDUSTRIE-TECHNIK

PO Box 1339 Koppelheck  
Nassau-Lahn  
56377  
Germany

**Contact:** Mr Hansjürg Emde  
**Job Title:** Managing Director  
**T:** + 49 2604 97030  
**F:** + 49 2604 970333  
**E:** info@emde.de  
**W:** www.emde.de

#### GREIF-VELOX

Kronsforder Landstraße 177  
Lübeck  
D-23560  
Germany

**Contact:** Mr Poppe  
**T:** + 49 451 530 30  
**F:** + 49 451 530 233  
**E:** logdos@logdos.de  
**W:** www.greif-velox.de

#### PEMA Verpackung GmbH

Carl Zeiss Strasse 10  
Syke  
28857  
Germany

**Contact:** Mr Christof Raake  
**T:** + 49 42 42 53 93 0  
**F:** + 49 42 425 02 09  
**E:** raake@pema-verpackung.de  
**W:** www.pema-verpackung.de  
PEMA Verpackung GmbH has been, for nearly 25 years, one of the leading suppliers of FIBC's in Germany. The main markets are the foodstuff, chemical, pharmaceutical and building industries. PEMA has its own production facility for FIBC in Germany which brings advantages for ourselves and our customers.

#### Schleswiger

#### Tauwerkfabrik Oellerking GmbH & Co KG

Margarethenwallstr. 7  
Schleswig  
D-24837  
Germany

**Contact:** Mr Johannes Jensen  
**Job Title:** Sales Manager  
**T:** + 49 4621 3809 40  
**F:** + 49 4621 3809 99  
**E:** jjensen@oellerking.com  
**W:** www.oellerking.com  
Liner bags, thermo liner and Sweatkings for standard container.

### INDIA

#### Taurian Exim Pvt. Ltd

199 / 201 Gold Coin Bldg  
2nd Floor Sheikh Memon Street  
Zhaveri Bazaar  
Mumbai  
Maharashtra  
400 002

India

**Contact:** Mr Sachin Bajja  
**Job Title:** Managing Director  
**T:** + 91 22 234 53430  
**F:** + 91 22 234 53589  
**E:** taurian@vsnl.com

### IRELAND

#### Synthetic Packaging

Clara  
County Offaly  
Ireland

**Contact:** Mr Kevin Crothers  
**Job Title:** Managing Director  
**T:** + 353 579 331 282  
**F:** + 353 579 331 224  
**E:** Kevin.Crothers@syntheticpackaging.com  
**W:** www.syntheticpackaging.com

### ITALY

#### ECEPLAST srl

Strada Provinciale 115  
Troia  
Foggia  
71029  
Italy

**Contact:** Mr Nicola Altobelli  
**Job Title:** Commercial Director  
**T:** + 39 0881 978080  
**F:** + 39 0881 979100  
**E:** info@eceptplast.it  
**W:** www.eceptplast.com  
The only European Manufacturer of PE film and Woven Fabric Linerbags for dry bulk cargo shipment in containers.

#### FEMADIGIPACK s.r.l.

Via Romano, 9  
Cortenuova  
Bergamo  
24050  
Italy

**Contact:** Mr Marco Belotti  
**Job Title:** Project Engineer  
**T:** + 39 0363 911 396  
**F:** + 39 0363 902 466  
**E:** info@femadigipack.it  
**W:** www.femagroup.net

#### Premier Tech Chronos s.r.l.

Via G. Di Vittorio, 78  
Lemignano Di Collecchio  
PG  
43044  
Italy

**Contact:** Mr Fabrizio Ferrari  
**Job Title:** General Manager  
**T:** + 39 521 29 60 11  
**F:** + 39 521 29 60 51  
**E:** info-eu@ptchronos.com  
**W:** www.ptchronos.com

#### Sa Te In

Castell'Arquato (PC) 29014  
Strada Castellana  
KM 7  
Italy

**Contact:** Mr Giuseppe Massouda  
**Job Title:** Sales Director  
**T:** + 39 0525 804133  
**F:** + 39 0523 804338  
**E:** giuseppe.massouda@italtex.com  
**W:** www.satein.com

#### Saccheria F.Lli Franceschetti Spa

Via Stazione Vecchia 80  
Provaglio d'Iseo  
Brescia  
25050  
Italy

**Contact:** Mr Maurizio Bonardi

**Job Title:** Commercial Dept  
**T:** + 39 030 982 3841  
**F:** + 39 030 983 9039  
**E:** comag@saccheriafranceschetti.it  
**W:** www.saccheriafranceschetti.it

## JAPAN

### Taiyo Kogyo Corporation

2-33-16 Ikejiri  
 Setagaya-ku  
 Tokyo  
 154-0001  
 Japan  
**Contact:** Mr Daiki Shirai  
**Job Title:** Assistant Manager  
**T:** + 81 3 3714 3311  
**F:** + 81 3 3791 5558  
**E:** sd003275@mb.taiyokogyo.co.jp  
**W:** www.taiyokogyo.com/taicon  
 Taiyo Kogyo offers a wide variety of FIBCs ranging from single/multi-trip PP woven FIBCs to repairable heavy-duty FIBCs made of PVC and other tarpaulins.

## LUXEMBOURG

### SOLEM S.A.

13, Fausermillen  
 Mertert  
 6689  
 Luxembourg  
**Contact:** Mr Bernd Beeking  
**Job Title:** General Manager  
**T:** + 352 75 07 91 25  
**F:** + 352 74 96 46  
**E:** bernd.beeking@solem.lu  
**W:** www.solem.lu

## NEW

## ZEALAND

### Donaghys

16 Sheffield Crescent  
 Harewood  
 Christchurch  
 New Zealand  
**Contact:** Mr H N F Ross  
**T:** + 64 3 983 4100  
**F:** + 64 3 983 4191  
**E:** enquiries@donaghys.co.nz  
**W:** www.donaghys.com/

## NORWAY

### Goodtech AS

Bjoernstveien 2  
 Porsgrunn  
 N-3917  
 Norway  
**Contact:** Mr Tim Johnstone  
**Job Title:** Regional Director  
**T:** + 47 35 93 05 50  
**F:** + 47 35 93 05 60  
**E:** tim.johnstone@goodtech.no  
**W:** www.portabulk.com or www.goodtech.no  
 Based on PORTABULK® technology and in close cooperation with its international marketing and manufacturing network, Goodtech delivers superior, cost-effective materials handling technology, products, systems and services in selected markets.

## POLAND

### Pakiet

82-103 Stegna  
 Rybina 43  
 Gdansk

Poland  
**Contact:** Ms Patricia Wojcik  
**Job Title:** Assistant  
**T:** + 48 55 247 17 70 ext. 21  
**F:** + 48 55 612 93 13  
**E:** patrycja@pakiet.com  
**W:** https://pakiet.com

## PORTUGAL

### Cotesi SA

Av. Mosteiro, 486  
 Grijó  
 4415-493  
 Portugal  
**Contact:** Mr Kai Hakala  
**T:** + 351 227 476 500  
**F:** + 351 227 646 575  
**E:** geral@cotesi.com  
**W:** www.cotesi.com

## RUSSIA

### Nekrasovsky

Dmitrov District  
 Moscow Region  
 141760  
 Russia  
**T:** + 7095 578 6452  
**F:** + 7095 578 4698

### Plastcon

Neftyanaya doroga, 1 A  
 St Petersburg  
 193060  
 Russia  
**Contact:** Ms Anna Starikova  
**T:** + 7 812 766 5905  
**F:** + 7 812 766 0370  
**E:** starikova@plastcon.ru

## SINGAPORE

### Interbulk Enterprise

12 Mariam Walk  
 Singapore  
 507172  
 Singapore  
**Contact:** Mr Michael Lian Soon  
 Leong  
**T:** + 65 654 66335 / 4688  
**F:** + 65 654 50985  
**E:** info@singnet.com.sg

### Ssangleong Bulkhandling Pte Ltd

72 Tuas South Street 5  
 Singapore  
 637807  
 Singapore  
**Contact:** Mr Soon Beng Lien  
**Job Title:** Managing Director  
**T:** + 65 6265 7377  
**F:** + 65 6264 7377  
**E:** veron.lien@ssangleong.com  
**W:** www.ssangleong.com  
 Since 1981, Ssangleong has evolved from a small Bulk Bag trading firm to a full-fledged company, manufacturing and exporting a wide range of industrial packaging products. Bulk Bags, PP Woven Bags, Flexibags, IBC Tanks, rework and repacking are some of our core products and services.

## SOUTH

## AFRICA

### Industrial Netting (Pty) Ltd

PO Box 39624  
 Bramley

Gauteng  
 2018  
 South Africa  
**Contact:** Mr Ian Campbell  
**Job Title:** Managing Director  
**T:** + 27 11 6084686  
**F:** + 27 11 6084690  
**E:** info@industrialnetting.co.za  
**W:** www.industrialnetting.co.za

### Tufbag

PO Box 155  
 Mandini  
 KwaZulu Natal  
 4490  
 South Africa  
**Contact:** Mr Russell Titmas  
**Job Title:** National Sales Manager  
**T:** + 27 32 459 5050  
**F:** + 27 32 459 2581  
**E:** russell.titmas@tufbag.com  
**W:** http://tufbag.com

## SPAIN

### Beniplast/Benitex

Avda Vicente Boluda Polop  
 S/N 46830  
 Beniganim  
 Valencia  
 46830  
 Spain  
**Contact:** Mr Vicente Cuquerella  
**Job Title:** Managing Director  
**T:** + 34 96 391 6906  
**F:** + 34 96 392 1638  
**E:** valencia.btx@benitex.com  
**W:** www.benitex.com

### Clime SA

c/- Castilla 52-54  
 Barcelona  
 08018  
 Spain  
**Contact:** Mr John Climent  
**T:** + 34 93 307 6362  
**F:** + 34 93 308 5649  
**E:** climesa@fibcnet.com  
**W:** www.fibcnet.com

### Condepols S.A.

Avda. Iberoamérica, 35  
 Alcalá La Real  
 Jaén  
 23680  
 Spain  
**Contact:** Mrs Gloria Lindemann  
**Job Title:** Commercial Director  
**T:** + 34 91 337 7048 / +34 953 59 81 00  
**E:** gloria.lindemann@condepols.es  
**W:** www.condepols.es

### Industrias Murtra

Jordi Camp 94  
 Apartado 278  
 Granollers  
 Barcelona  
 08403  
 Spain  
**Contact:** Mr Xhabby Franco  
**Job Title:** Sales Manager  
**T:** + 34 93 846 7200  
**F:** + 34 93 846 5956  
**E:** murtra@murtra.com  
**W:** www.murtra.com

### Propitex SA

Poligono Industrial s/n  
 Aoiz  
 Navarra  
 31430  
 Spain  
**Contact:** Mrs Monica Fuentez  
**Job Title:** Commercial Manager  
**T:** + 34 948 334 115  
**F:** + 34 948 334 116  
**E:** commercial@propitex.com  
**W:** www.propitex.com

### Rodenas & Rivera S.A.

PO Box 252  
 Albacete  
 Albacete  
 02080  
 Spain  
**Contact:** Ms Maria Galan  
**Job Title:** Marketing  
**T:** + 34 967510270  
**F:** + 34 967511098  
**E:** Rodenasrivera@rodensasrivera.com  
**W:** www.rodensasrivera.com

## SWEDEN

### Bergu International AB

Nygata 30  
 Box 5006  
 Helsingborg  
 S-250 05  
 Sweden  
**Contact:** Mr Conny Simonsson  
**T:** + 46 42 12 7970  
**F:** + 46 42 12 8002  
**E:** bergu@telia.com  
**W:** www.bergu.com

## THE

## NETHERLANDS

### Greif Flexibles Benelux B.V.

Jupiterweg 1  
 Harbournumber M-389  
 Moerdijk  
 4761 RW  
 The Netherlands  
**Contact:** Mr Peter Neteleer  
**Job Title:** Senior Account Manager  
**T:** + 31 168 35 99 99  
**F:** + 31 168 35 99 88  
**E:** Flexibles.benelux@greif.com  
**W:** www.greif-flexibles.com  
 Greif's Flexible Products & Services business provides FIBCs, shipping sacks, container liners and other flexible industrial packaging for chemicals, pharmaceuticals, foodstuffs and many other sectors. We also offer a full portfolio of geotextiles.

### Interbulk Packaging BV

PO Box 2168  
 Vught  
 5260 CD  
 The Netherlands  
**T:** + 31 6 484 21285  
**F:** + 31 111 45 1010  
**E:** info@interbulkpackaging.com  
**W:** www.interbulkpackaging.com

### Interjute BV

PO Box 154  
 Hulst  
 4560 AD  
 The Netherlands  
**Contact:** Mr Ron Segboer  
**Job Title:** Chief Commercial Officer  
**T:** + 31 114 311000  
**F:** + 31 114 311512  
**E:** rsegboer@interjute.nl  
**W:** www.interjute.com  
 INTERJUTE is one of Europe's major suppliers of polypropylene sacks and big bags for the packaging of fertilizer, chemicals, animal feed, malt, flour, sugar and many other products.

### Jansen & Heuning

Bulk Handling Systems  
 Duinkerkenstraat 11  
 Groningen  
 9723 BN  
 The Netherlands

**Contact:** Mr Bart Klomp  
**Job Title:** Marketing & Sales  
**T:** + 31 50 312 64 48  
**F:** + 31 50 313 80 18  
**E:** bk@jhn.nl  
**W:** www.jhn.nl

### LC Packaging International

Hoogeveeneweg 150  
 Nieuwerkerk a/d IJssel  
 2913 LV  
 The Netherlands  
**Contact:** Mr Nick Jansen  
**Job Title:** Director Europe  
**T:** + 31 180 39 38 17  
**F:** + 31 618 52 99 81  
**E:** Info@lcpackaging.com  
**W:** www.lcpackaging.com  
 LC Packaging is a family business that has been active in the packaging industry for four generations. It all started in the jute bag business in 1923, since then LC Packaging has expanded its services considerably, evolving from a packaging and packaging machinery importer to a manufacturer and distributor with its own production facilities in Europe, Asia and Africa. LC Packaging is now one of the largest packaging experts in the field of Flexible Intermediate Bulk Containers (FIBCs).

### Premier Tech Chronos b.v.

Meerheide 40  
 Eersel  
 Noord Brabant  
 5521 DZ  
 The Netherlands  
**Contact:** Mr Robert Vet  
**Job Title:** Marketing Representative  
**T:** + 31 497514988  
**E:** vetr@premiertech.com  
**W:** www.ptchronos.com

### Zakkencentrale B.V.

Cairostraat 50  
 Rotterdam 3047 BC  
 The Netherlands  
**Contact:** Mr Harm Peters  
**Job Title:** Managing Director  
**T:** + 31 10 462 3511  
**F:** + 31 10 462 6939  
**E:** exim@zakkencentrale.nl  
**W:** www.zakkencentrale.nl  
 Zakkencentrale and daughter company EXIM are producing and selling 25-50 kg bags, FIBC's and Containerliners.

## TURKEY

### Avplast Dis Tic. Ve Paz. Ltd. Sti.

Egitim Mah. Kasap Ismail Sok.  
 Avrasya Is Merkezi No:14 Kat:1  
 D:24-  
 34722 Hasanpasa / Kadikoy  
 Istanbul  
 81080  
 Turkey  
**Contact:** Mr Hakan Avci  
**T:** + 90 216 338 32 31 - 347 38 54  
**F:** + 90 216 348 88 95  
**E:** sales@avplast.com.tr  
**W:** www.avplast.com.tr

### Cesur Packaging Corporation

Cumhuriyet Mahallesi,  
 Yüzüil Caddesi, No:64,  
 Istanbul  
 Kartal



34876

Turkey

**Contact:** Mr Cihan Cesur  
**Job Title:** General Manager  
**T:** + 90 216 377 28 55  
**F:** + 90 216 377 11 90  
**E:** info@cesur.com  
**W:** www.cesur.com

Cesur Packaging Corporation is an international packaging company established in 1930 specializing in the manufacturing of FIBC Polypropylene Big Bags in Istanbul-Turkey with fully integrated facilities.

Cesur is proud to serve blue chip companies all around the world within the chemical, food, pharmaceutical, cement and fertilizer industries by producing all types of fibc pp big bags including special designs and models.

## Greif Flexibles Turkey

Fabrika Sokak No.2/8  
 Samandira  
 Istanbul  
 34885  
 Turkey

**Contact:** Mr Can Sezer  
**Job Title:** Business Development Director, EMEA  
**T:** + 90 216 564 0600  
**F:** + 90 216 311 5013  
**E:** mail@unsa-tr.com  
**W:** www.unsa-tr.com

## Gulsan A.p.

Organize Sanayi Bolgesi 2 Cad.  
 No: 18  
 Gaziantep  
 27180  
 Turkey

**Contact:** Ms Gulden Saka  
**Job Title:** Marketing Manager  
**T:** + 90 342 337 1180  
**F:** + 90 342 337 2528  
**E:** info@gulsan-group.com  
**W:** www.gulsan-group.com

## Isbir Sentetik Dokuma

### San .A.S.

Izmir Yolu  
 Cayirhisar Mevkii  
 Balikesir  
 10034  
 Turkey

**Contact:** Mr Tanin Guven  
**Job Title:** Marketing Manager/Sales Director  
**T:** + 90 266 283 0000  
**F:** + 90 266 283 0001  
**E:** taninguyen@isbirsentetik.com  
**W:** www.isbirsentetik.com

## Tetsa A.S.

Koseilyas Yoyu Yolu 2. km  
 Degirmenalti Mevkii  
 Tekirdag  
 59000  
 Turkey

**Contact:** Mr Ekrem Edip  
**T:** + 90 282 293 2222  
**F:** + 90 282 293 2228  
**E:** bilgi@tetsa.com.tr  
**W:** www.tetsa.com.tr

## UK

## Bulkgab Containers Ltd

Old Glamis Factory  
 Old Glamis Road  
 Dundee  
 DD3 8JB  
 UK

**Contact:** Mr Hamish Milne  
**Job Title:** Director  
**T:** + 44 1382 823824  
**F:** + 44 1382 823825  
**E:** sales@bulkgab.co.uk



**W:** www.bulkbag.co.uk

We are heavy industrial sewing specialists with 30 years experience in the manufacture and development of Flexible Intermediate Bulk Containers (FIBCs). We service all industrial sectors, catering for large and small contracts and one off requirements. With standard and bespoke bags available to buy online. Contact us with your requirements.

## Flexicon Europe Ltd

182 John Wilson Business Park  
 Harvey Drive  
 Whitstable  
 Kent  
 CT5 3RB  
 UK

**T:** + 441227 374710  
**E:** sales@flexicon.co.uk  
**W:** www.flexicon.co.uk

## Industrial Bulk Containers

Newton Business Park  
 Talbot Road  
 Hyde  
 Cheshire  
 SK14 4UQ  
 UK

**Contact:** Ms Judith Kelly  
**T:** + 44 161 367 8695  
**F:** + 44 161 367 8685  
**E:** industrialbulkcontainers@btconnect.com

## Miller Weblift Ltd

Marling Mills  
 Nelson Street  
 Leek  
 Staffordshire  
 ST13 6BB  
 UK

**Contact:** Mr Andrew Clement  
**Job Title:** General Manager  
**T:** + 44 1538 384108  
**F:** + 44 1538 387350  
**E:** sales@millerweblift.com  
**W:** www.millerweblift.com

## Mulox Ltd

Unit 2, High Carr Business Park  
 Off Millennium Way  
 Newcastle  
 Stoke-on-Trent  
 Staffordshire  
 ST5 7XE  
 UK

**Contact:** Mr Andrew Reardon  
**Job Title:** Operations Director  
**T:** + 44 1782 565 659  
**F:** + 44 1782 562 252  
**E:** andrew.reardon@mulox.co.uk  
**W:** www.mulox.com  
 Manufacturer of FIBCs mainly for

the pharmaceutical, chemical and food industries. Specialists in high containment systems.

## Protective Packaging Ltd

Dane Road Industrial Estate  
 Dane Road  
 Sale  
 Cheshire  
 M33 7BH  
 UK

**Contact:** Mr Simon P Jolly  
**Job Title:** Sales Director  
**T:** +44 161 976 2006  
**F:** +44 161 976 3330  
**E:** info@protpack.com  
**W:** www.protpack.com  
 Manufacturers of aluminium barrier foil laminate bags and liners.

## Structure-Flex Ltd

Peacock Way  
 Melton Constable  
 Norfolk  
 NR24 2A3  
 UK

**Contact:** Mr Paul Reeve  
**T:** + 44 1263 863124  
**F:** + 44 1263 863110  
**E:** sales@structure-flex.co.uk  
**W:** www.structure-flex.co.uk

## USA

## BAG Corp®

1155 Kas Drive  
 Suite 170  
 Richardson  
 Texas  
 75081  
 USA

**Contact:** Mr Matthew Simons  
**Job Title:** Marketing Director  
**T:** + 1 214 340 7060 ext 832  
**F:** + 1 214 340 7060  
**E:** matt@bagcorp.com  
**W:** www.bagcorp.com  
 BAG Corp® manufactures Super Sack® containers, woven polypropylene flexible intermediate bulk containers (FIBCs) for shipping, handling and storing of dry, flowable products. The B.A.G. Corp. family also includes: FIBC Recycling, Inc., reconditioning FIBCs in a closed-loop system.

## Bulk Lift International

1013 Tamarac Drive  
 Carpentersville  
 IL  
 60110  
 USA

**Contact:** Mr Brian Kelly  
**Job Title:** National Sales Manager  
**T:** + 1 847 428 6059 x 215

**F:** + 1 847 428 7180

**E:** briank@bulklift.com  
**W:** www.bulklift.com

## BULK-FLOW

16623 W Hardy Road  
 Houston  
 TX  
 77060  
 USA

**Contact:** Mr Pablo Llopez  
**Job Title:** Director  
**T:** + 1 713 589 4580  
**F:** + 1 281 715 4032  
**E:** pllopez@bulk-flow.com  
**W:** www.bulk-flow.com/

BULK-FLOW is a global bulk packaging manufacturing company specialized in containerized bulk packaging solutions, and break-bulk packaging.

## Conitex Sonoco

1302 Industrial Pike  
 Gastonia  
 North Carolina  
 NC 28052  
 USA

**Contact:** Ms Michelle Safrit  
**Job Title:** Marketing Manager  
**T:** +1 704 833 1367  
**F:** +1 704 865 7926  
**E:** msafrit@conitex.com  
**W:** www.conitex.com

Full scale FIBC manufacture in the US, India, Mexico and China. U Paneled, Circular, Baffled, UN, Type D and Type C available. Specializing in Food and Pharma Grade Bags.

## CorrPak Bulk Packaging Systems, LLC

506 North 31st Street  
 Suite 4  
 Monroe  
 LA  
 71201  
 USA

**Contact:** Mr Andy Mintz  
**Job Title:** President  
**T:** + 1 318 699 0108  
**F:** + 1 318 699 0501  
**E:** amintz@corrpkbpps.com  
**W:** www.corrpkbpps.com

## FlexCon & Systems

50 Market Street  
 #1A, Suite 331  
 South Portland  
 Maine 04106  
 Lafayette  
 LA  
 LA 70506  
 USA

**Contact:** Mr Steve Herd  
**Job Title:** Manager

**T:** + 1 207 767 5387

**E:** info@flexcon.com

**W:** www.flexcon.com

## Flexicon Corporation

2400 Emrick Blvd  
 Bethlehem  
 PA  
 18020-8006  
 USA

**T:** + 1 610 814 2400  
**F:** + 1 610 814 0600  
**E:** sales@flexicon.com  
**W:** http://www.flexicon.co.uk/

## Intertape Polymer

3647 Cortez Road West  
 Bradenton  
 FL  
 34210  
 USA

**Contact:** Mrs Cindy Wong  
**Job Title:** Sales & Marketing  
**T:** + 1 941 727 5788 x 7594  
**F:** + 1 941 727 5293  
**E:** info@itape.com  
**W:** www.intertapepolymer.com

## King Bag & Manufacturing Co

1500 Spring Lawn Avenue  
 Cincinnati  
 OH  
 45223  
 USA

**Contact:** Mr Mike Jennings  
**Job Title:** Sales Manager  
**T:** + 1 513 541 5440 ext 306  
**F:** + 1 513 541 6555  
**E:** mike@kingbag.com  
**W:** www.kingbag.com

## Langston Companies Inc

2500 South K Street  
 Tulare  
 CA 93274  
 USA

**Contact:** Mr Carlton Truhett  
**Job Title:** Managing Director  
**T:** + 1 559 688 3839  
**F:** + 1 559 688 1876

## Langston Companies Inc.

PO Box 60  
 Memphis  
 Tennessee  
 38101-0060  
 USA

**Contact:** Mr Bob Langston  
**Job Title:** President  
**T:** + 1 901 774 4440  
**F:** + 1 901 942 5402  
**E:** blangston@langstonbag.com  
**W:** www.langstonbag.com

## Powertex Inc

1 Lincoln Boulevard  
 Rouses Point  
 New York  
 New York  
 12979  
 USA

**Contact:** Mr Stephen Podd  
**Job Title:** President and CEO  
**T:** + 1 518 297 4000  
**F:** + 1 518 297 2634  
**E:** stephenpodd@powertex.com  
**W:** www.powertex.com

## Semi-Bulk Systems Inc

159 Cassens court  
 Fenton  
 MO 63026  
 USA

**Contact:** Mr Bentley  
**T:** + 1 636 343 4500 x 112  
**F:** + 1 636 343 2822  
**E:** rbentley@semi-bulk.com  
**W:** www.semi-bulk.com

## INLAND TRANSPORT: BARGE COMPANIES



### AUSTRALIA

#### ADM

Level 10 Suite 1002  
1 Newland Street  
Bondi Junction  
New South Wales  
2022  
Australia  
**Contact:** Mr Nigel Hart  
**Job Title:** Global Director - Ports  
**T:** + 61 417227412  
**E:** Nigel.Hart@adm.com  
**W:** www.adm.com

### BELGIUM

#### Bulk Cargo Handling BVBA

Nijverheidskaai 28  
Bus 9  
Brussels  
1080  
Belgium  
**Contact:** Mr Nicola Samyn  
**Job Title:** CEO  
**T:** + 32 477 44 98 81  
**E:** bch.belgium@gmail.com

### CANADA

#### Dismar

2615, Notre-Dame Centre  
C.P. 35  
Trois-Rivières  
Quebec  
G9A 5E3  
Canada  
**Contact:** Ms Elena Ivanova  
**Job Title:** Development / Customer Service  
**T:** + 1 819 374 6203  
**F:** + 1 819 372 9276  
**E:** E.Ivanova@dimarcana.com  
**W:** www.dismar.qc.ca

#### Groupe Desgagnés Inc.

21, Rue du Marché-Champain  
Quebec  
Quebec  
G1K 8Z8  
Canada  
**Contact:** Mr Louis-Marie Beaulieu  
**T:** + 1 418 692 1000

**F:** + 1 418 692 6044  
**E:** info@desgagnés.com  
**W:** www.desgagnés.com

#### Groupe Somavrac

3450 Boul. Gene H. Kruger  
C.P. 294  
Trois-Rivières  
Quebec  
G9A5G1  
Canada  
**Contact:** Mr Sylvain Desbiens  
**Job Title:** Vice President  
**T:** + 1 819 379 3311  
**F:** + 1 819 379 5584  
**E:** info@grpml.com  
**W:** www.groupe-somavrac.com

#### McKeil Marine Limited

208 Hillyard Street  
Hamilton  
Ontario  
L8L 6B6  
Canada  
**Contact:** Mr Patrick Bourke  
**Job Title:** Commercial VP  
**T:** + 1 905 528 4141 ext 241  
**F:** + 1 905 528 6144  
**E:** pbourke@mckeil.com  
**W:** www.mckeil.com

#### Seabulk Inc

Suite 150  
10271 Shellbridge Way  
Richmond  
British Columbia  
V6X 2W8  
Canada  
**Contact:** Mr Sidney Sridhar  
**Job Title:** President  
**T:** + 1 604 273 1378 Ext 103  
**F:** + 1 604 273 1358  
**E:** sbs@seabulk.com  
**W:** www.seabulk.com

### EGYPT

#### Egyptian International Shipping

**Co**  
PO Box 110  
Orman  
Giza  
Egypt  
**Contact:** Mr Mohamad Hashish  
**Job Title:** Vice President

**T:** + 20 2 37481565  
**F:** + 20 2 37481116  
**E:** mhashish@eisgroup.com.eg

### FINLAND

#### ESL Shipping

Lintulahdenkuja 10  
Helsinki  
FIN-00580  
Finland  
**Contact:** Mr Mikki Koskinen  
**T:** + 358 9 5211  
**E:** mikki.koskinen@eslshipping.com  
**W:** www.eslshipping.fi

### FRANCE

#### CFT

Le Havre  
Haute Normandie  
7012 X  
France  
**Contact:** Mr Ferenc Szilagyi  
**Job Title:** Market Leader  
**T:** + 33 2 35 53 50 29  
**F:** + 33 2 35 24 88 45  
**E:** ferenc.szilagyi@cft.fr

### GERMANY

#### HTAG Häfen und Transport AG

Neumarkt 7-11  
Duisburg  
47119  
Germany  
**Contact:** Mr Joachim Holstein  
**T:** + 49 203 47989 128  
**F:** + 49 203 47989 191  
**E:** joachim.holstein@htag-  
duisburg.de  
**W:** www.htag-duisburg.de

#### Oldendorff Carriers GmbH & Co.

**KG**  
Willy-Brandt-Allee 6  
Lubeck  
23554  
Germany  
**Contact:** Mr Henning Oldendorff  
**Job Title:** MD  
**T:** + 49 451 15000  
**F:** + 49 451 73522  
**E:** henning@oldendorff.com  
**W:** www.oldendorff.com

### INDIA

#### J.M. Baxi & Co

Sapt Building  
2nd Floor  
18 J.N. Heredia Marg  
Ballard Estate  
Mumbai  
400 001  
India  
**Contact:** Mr John C. Alexander  
**Job Title:** Senior VP Business Development  
**T:** + 91 22 2270 3779 / 82  
**F:** + 91 22 2210 3629  
**E:** jca@jmbaxi.com  
**W:** www.jmbaxi.com

#### United Shippers Limited

Prospect Chambers, 3rd Floor  
D N Road  
Fort  
Mumbai  
Maharashtra  
400 001  
India  
**Contact:** Captain Sanjay Goel  
**Job Title:** Managing Director  
**T:** + 91 22 67568 400  
**F:** + 91 22 67568 496/97

**E:** inquiry@unitedshippers.com  
**W:** www.unitedshippers.com  
United Shippers Limited (USL) is in  
Barging, Stevedoring, Logistics  
business for Dry Bulk Cargo in  
West Coast of India handling about  
13 million metric tpa of cargo and  
60 barges. Handles rake loading  
with mostly coal cargo - about  
2.5million tpa.

### INDONESIA

#### Pt Pelayaran Kartika Samudra

**Adijaya**  
10th Floor, Suite 10- C  
Jl. H.R. Rasuna Said Blok X-1  
Kav 1-2  
Kuningan  
Jakarta  
12950  
Indonesia  
**Contact:** Mr Robby Nugraha  
**Job Title:** Marketing  
**T:** + 62 21 527 6015  
**F:** + 62 21 527 6016  
**E:** roby.nugraha@ptksa.org  
**W:** http://www.ptksa.org/

#### PT Perusahaan Pelayaran

**Rusianto Bersaudara**  
Jalan H.R. Rasuna Said Blok X-5  
Kav 13  
Menara Cyber 2  
Floor 21-C  
Jakarta  
12950  
Indonesia  
**Contact:** Ms Heppy Herawaty  
**Job Title:** Marketing Director  
**T:** + 62 21 300 26606  
**F:** + 62 21 300 26616  
**E:** heppy.ong@  
rusiantobersaudara.com  
**W:** www.rusiantobersaudara.com

#### PT Trans Power Marine Tbk

Artha Graha Building  
20th Floor Suite#20-01  
SCBD, Jl. Jengral Sudirman Kav  
52-53  
Jakarta  
12190  
Indonesia  
**Contact:** Mr Ronny Kurniawan  
**Job Title:** Vice President  
Commissioner  
**T:** + 62 215 155 551  
**F:** + 62 215 153 385  
**E:** info@pt-tpm.com  
**W:** www.transpowermarine.com

#### PT. Anugrah Lautan Luas

Jl Raya pahlawan Seribu  
Golden Boulevard 2 Blok O No. 5-6  
BSD City  
Serpong  
15321  
Indonesia  
**Contact:** Ms Mayang Paramitha  
**Job Title:** Chartering Manager  
**T:** + 62 21 5316 4382  
**E:**  
mayang@anugrahlautanluas.com  
**W:** www.anugrahlautanluas.com/

#### PT. Meratus Advance Maritim

Wisma Raharja 6th floor, zone C  
Jl. TB Simatupang Kav.01, Cilandak  
Jakarta  
12560  
Indonesia  
**Contact:** Ms Katherine The  
**Job Title:** Commercial Manager  
**T:** + 62 21 781 4568  
**F:** + 62 21 781 4572  
**E:** info@mdm.co.id  
**W:** http://www.mdm.co.id/

#### PT. Pelita Samudera Shipping

Menara Citicon 19th Floor  
Jl. Letjen. S. Parman Kav.72  
Jakarta  
11410  
Indonesia  
**Contact:** Ms Apriliani Wulandari  
**Job Title:** Commercial Executive  
**T:** + 62 21 2930 8801  
**F:** + 62 21 2930 8802  
**E:** sprilianiwulandari@ptpss.co.id  
**W:** http://www.ptpss.co.id/

### ITALY

#### Vitelli srl

Via del Campone 72/74  
Porto Santo Stefano  
Italy  
**Contact:** Mr Giorgio Vitelli  
**Job Title:** Sales Manager  
**T:** + 39 0564 814436  
**F:** + 39 0564 816676  
**E:** giorgio.vitelli@vitellisrl.it  
**W:** www.vitellisrl.it

### THE

### NETHERLANDS

#### DAP Barging BV

Wilhelmskade 15 a  
Rotterdam  
3016 DK  
The Netherlands  
**Contact:** Mr Dirk A van der Plas  
**T:** + 31 10 282 7788  
**F:** + 31 10 282 7655  
**E:** dirk@dap-barging.nl  
**W:** www.dap-barging.nl/

#### Eurobulk Transport

Amstelwijckweg 15  
Dordrecht  
3316 BB  
The Netherlands  
**Contact:** Mr Zeeg Brasser  
**Job Title:** Advertising  
**T:** + 31 786552400  
**E:** info@eurobulk.nl  
**W:** www.eurobulk.nl

#### Euro-Rijn International BV

Plaza 6  
Moerdijk  
4782 SK  
The Netherlands  
**Contact:** Mr van Tooren  
**T:** + 31168393220  
**F:** + 31168393260  
**E:** d.kuijpers@eurorijn.com

#### Interrijn BV

Kantoorgebouw Westgate  
Scheepmakerij 130  
Zwijndrecht  
3331 MA  
The Netherlands  
**Contact:** Ms Ellen Straver  
**Job Title:** Ass Manager  
**T:** + 31 078 625 9399  
**F:** + 31 078 619 0775  
**E:** interrijn@interrijn.com  
**W:** www.interrijn.nl/

#### LBH Marketing Services BV

Rijsdijk 13  
Rhoon  
3161 HK  
The Netherlands  
**Contact:** Ms Naemi Monte  
**Job Title:** Marketing Manager  
**T:** + 31 10 506 5030  
**F:** + 31 10 506 5035  
**E:** naemi.monte@lbhmarketing.com  
**W:** www.lbh-group.com



## UK

**Ashmead Maritime**

The Old Barns  
The Ham  
Coaley  
GL11 5AS  
UK

**Contact:** Mr Peter Ashmead  
**Job Title:** Principal  
**T:** + 44 1453 860045  
**E:** ashmead@aship.co.uk  
**W:** www.aship.co.uk

**J P Knight Group Ltd**

Admiral's Offices  
The Historic Dockyard  
Chatham  
Kent  
ME4 4TZ  
UK

**Contact:** Mr Richard Knight  
**Job Title:** Managing Director  
**T:** + 44 1634 826633  
**F:** + 44 1634 829093  
**E:** navigators@jpknight.com  
**W:** www.jpknight.com  
JP Knight are shallow-draft barging specialists transporting millions of tonnes of bauxite on the rivers of Suriname, South America. The company was founded in 1892 in London and is Britain's oldest tug and barge owner.

## UKRAINE

**Transship LTD**

Marazlievskaya Str, 8  
Odessa  
65014  
Ukraine

**Contact:** Mr Eugene Mashtakov  
**T:** + 380 482 33 33 32  
**F:** + 38 482 34 74 07  
**E:** e.mashtakov@transship.ua  
**W:** www.transship.com.ua

## USA

**AEP River Operations**

16150 Main Circle Drive  
Suite 400  
Chesterfield  
MO 63017  
USA

**Contact:** Ms Jennifer Mason  
**T:** + 1 636 530 2488  
**E:** JLMason@AEPRiverOps.com  
**W:** www.aepriveprops.com

**American Commercial Barge Line**

PO Box 610  
Jeffersonville  
IN 47131-0610  
USA

**Contact:** Mr Rich McCarty  
**Job Title:** Marketing Director  
**T:** + 1 812 228 1703  
**E:** richard.mccarty@bargeacbl.com

**ARTCO**

4666 Faries Parkway  
Decatur  
IL  
62526  
USA

**Contact:** Mr Kevin Van Meter  
**Job Title:** Director  
**T:** + 1 217 424 5556  
**F:** + 1 217 451 4122  
**E:** kevin.vanmeter@adm.com  
**W:** www.admworld.com

**Canal Barge Company, Inc**

835 Union Street

New Orleans  
LA 70112-1469  
USA

**Contact:** Mr Larry Barbish  
**Job Title:** VP Marketing  
**T:** + 1 504 584 1535  
**F:** + 1 504 584 1505  
**E:** lbarbish@canalbarge.com  
**W:** www.canalbarge.com

**Cooper Consolidated, LLC**

365 Canal Street  
Suite 1450  
New Orleans  
LA  
70130  
USA

**Contact:** Mr Scott Beonel  
**Job Title:** Director Energy Sales & Business Development  
**T:** + 1 504 569 2168  
**E:** scott.beonel@cooperconsolidated.com  
**W:** www.cooperconsolidated.com

**Forest Lines Inc**

PO Box 53425  
New Orleans  
LA 70153-3425  
USA

**Contact:** Mr Joseph E Zehner  
**Job Title:** General Traffic Manager  
**T:** + 1 504 529 1300  
**F:** + 1 504 593 6401  
**W:** www.forest-lines.com

**Ingram Barge Co**

4400 Harding Road  
Nashville  
TN  
37205-229  
USA

**Contact:** Mr Daniel T. Martin  
**Job Title:** Senior Vice President & Chief Commercial Officer  
**T:** + 1 615 298 8373  
**F:** + 1 615 695 3373  
**E:** dan.martin@ingrambarge.com  
**W:** www.ingrambarge.com

Ingram Barge Company is the leading carrier on America's inland waterways, with a fleet of more than 150 towboats and approximately 5,000 barges that transport coal, aggregates, grain, fertilizer, ores, alloys, steel products and chemicals. For more information, visit [www.ingrambarge.com](http://www.ingrambarge.com).

**Lakes Logistics LLC**

15361 Highland Place  
Minnetonka  
Minnesota  
55345  
USA

**Contact:** Mr Don Divine  
**Job Title:** President  
**T:** + 1 952 938 5039  
**E:** don@lakeslogistics.com  
**W:** www.LakesLogistics.com

**MBLX Inc**

One Canal Place  
Suite 2100  
New Orleans  
LA 70130  
USA

**Contact:** Mr David P Schulingkamp  
**Job Title:** President  
**T:** + 1 504 581 2033  
**F:** + 1 504 581 2035  
**E:** david.schulingkamp@mblx.com  
**W:** <http://mblxresources.com/>

**McDonough Marine Service**

1750 Clearview Parkway  
Metairie  
LA 70001-2470  
USA

**Contact:** Mr Pat Sant



**Job Title:** Sales Representative  
**T:** + 1 504 780 8100  
**F:** + 1 504 780 8200  
**E:** pstant@marmac.net

**National Waterways Conference, Inc.**

1100 North Glebe Road  
Suite 1010  
Arlington  
VA  
22201  
USA

**Contact:** Ms Carole Wright  
**Job Title:** Director of Internal Operations  
**T:** + 1 703 224 8007  
**F:** + 1 866 371 1390  
**E:** carole@waterways.org  
**W:** www.waterways.org  
Promotes a better understanding of the public value of the American waterways system and to document the importance of far-sighted navigation and water resources policies to a sound economy, industrial and agricultural productivity, regional development, environmental quality, energy

conservation, international trade, defense preparedness and the overall national interest.

**Pere Marquette Shipping Company**

701 Maritime Drive  
PO Box 708  
Ludington  
MI  
49431  
USA

**Contact:** Mr Chuck Leonard  
**Job Title:** Marketing Manager  
**T:** + 1 231 845 7846  
**F:** + 1 231 843 4558  
**E:** cleonard@pmship.com  
**W:** www.pmship.com

**Rand Logistics Inc**

333 Washington Street, Suite 201  
Jersey City  
NJ  
07302  
USA

**Contact:** Ms Annemarie Dobler  
**Job Title:** Corporate Communications Director  
**T:** + 1 212 863 9429

**Saint Lawrence Seaway Development Corporation**

U.S Department of Transportation  
1200 New Jersey Avenue SE  
Washington  
DC  
20590  
USA

**Contact:** Ms Rebecca Yackley  
**Job Title:** International Trade Specialist  
**T:** + 1 202 366 0091  
**F:** + 1 202 366 7147

**E:** rebecca.yackley@dot.gov  
**W:** www.greatlakes-seaway.com  
The SLSDC is a wholly owned government corporation created by statute May 13, 1954, to construct, operate and maintain the part of the St. Lawrence Seaway between the Port of Montreal and Lake Erie. Trade Development functions aim to enhance Great Lakes/Seaway utilization without respect to territorial or geographic limits.

**INLAND TRANSPORT:  
RAIL COMPANIES**



F: + 27 35 906 7359  
E: joez@spoomet.co.za

**Transnet SOC**

Head Office  
150 Commissioner Street  
Carlton Centre  
Johannesburg  
Gauteng Province  
2001  
South Africa  
**Contact:** Mr Siyabonga Group  
Chief Executive  
**Job Title:** Group Chief Executive  
**T:** + 27 11 308 2266  
**F:** + 27 11 308 2315  
**E:** siyabonga.gama@transnet.net  
**W:** www.transnet.net

**THE**

**NETHERLANDS**

**Captrain Nederlands B.V**

Albert Plesmanweg 103 b-c  
Rotterdam  
NL - 3088 GC  
The Netherlands  
**Contact:** Mr Allan Marketing  
**Job Title:** Marketing  
**T:** + 31 10707 0500  
**E:** sales@captrain.nl  
**W:** www.captrain.be

**UK**

**DB Schenker**

Lakeside Business Park Carolina  
Way  
Doncaster  
South Yorkshire  
DN4 5PN  
UK  
**Contact:** Mr Graham  
**T:** +44 8701405000  
**E:** graham.meiklejohn@  
dbschenker.com

**Forwardis UK Ltd**

2nd Floor, Unit 17  
83 Crampton Street  
London  
SE71 3BQ  
UK  
**Contact:** Mrs Sharon Managing  
Director  
**Job Title:** Managing Director  
**T:** + 44 207 939 1900  
**E:** sharon.mcspadden@  
forwardis.com  
**W:** www.forwardis.com

**Freightliner Heavy Haul**

Aire Valley Depot  
Stranglands Lane  
Ferrybridge  
West Yorks  
WF11 8RA  
UK  
**Contact:** Mr David Director Coal &  
Deputy MD  
**Job Title:** Director Coal & Deputy  
MD  
**T:** + 44 1977 466805  
**F:** + 44 1977 466804  
**E:** israeld@freightliner.co.uk  
**W:** www.freightliner.co.uk

**Freightliner Heavy Haul**

3rd Floor  
The Podium  
1 Eversholt Street  
London  
NW1 2FL  
UK  
**Contact:** Ms Lynn Communications  
Manager  
**Job Title:** Communications

**AUSTRALIA**

**Asciano Limited**

Level 6  
15 Blue Street  
North Sydney  
NSW 2060  
Australia  
**Contact:** Mr Anthony Director, Bulk  
& Automotive Services  
**Job Title:** Director, Bulk &  
Automotive Services  
**T:** + 61 2 8484 8012  
**F:** + 61 2 8484 8154  
**E:** info@asciano.com.au  
**W:** www.asciano.com.au

**Trans Coal Pty Ltd**

Level 11, 225 Wickham Terrace  
Brisbane  
QLD 4000  
Australia  
**Contact:** Ms Faith Managing  
Director  
**Job Title:** Managing Director  
**T:** +61 7 3831 8431  
**F:** +61 7 3831 8432  
**E:** fdempsey@transcoal.com.au  
**W:** www.transcoal.com.au

**CANADA**

**Canadian National Railway**

Public Affairs & Advtg Dept.  
2nd Floor 935  
LA Gauchetiere West  
Montreal  
Canada  
**Contact:** Ms Chantale Director -  
Sustainability  
**Job Title:** Director - Sustainability  
**T:** + 1 514 399 8753  
**F:** + 1 514 399 5344  
**E:** chantale.despres@cn.ca

**CN Railway**

250050 Lantz Way  
2nd Floor  
Rocky View County  
AB  
T1Z 0A8  
Canada  
**Contact:** Gurpreet (G K)  
**T:** + 1 403 798 2138  
**F:** + 1 403 798 2105  
**E:** Gurpreet.khaira@cn.ca  
**W:** www.cn.ca

**FRANCE**

**MTS SAS**

7 rue de Dunkerque  
Strasbourg  
67016  
France  
**Contact:** Mr Eric CEO  
**Job Title:** CEO  
**E:** eric.mathon@mts-strasbourg.fr

**GERMANY**

**Captrain Deutschland GmbH**

Georgenstrasse 22  
Berlin  
10117  
Germany  
**Contact:** Ms Romy Press & Public  
Relations Officer  
**Job Title:** Press & Public Relations  
Officer  
**T:** + 49 30 39 60 11 0  
**F:** + 49 30 39 60 11 70  
**E:** info@captrain.de  
**W:** www.captrain.de  
Captrain Deutschland is one of the  
leading rail logistics companies in  
Germany and Europe. Be it  
international traction services,  
industrial rail operations or  
transport concepts tailored to the

individual processes of its  
customers. Captrain Deutschland  
offers innovative, customised and  
efficient logistics solutions.

**Deutsche Bahn Gruppe**

DB Cargo AG  
Königsstrasse 67-69  
Duisburg  
D-47051  
Germany  
**Contact:** Mr Hendrec  
**T:** + 49 6131 159  
**F:** + 49 6131 1565975  
**E:** info@dbschenker.eu  
**W:** www.dbschenker.de/

**INFORM GmbH**

Pascalstr. 23  
Aachen  
52076  
Germany  
**Contact:** Mr Udo Vice President  
Logistics Systems Division  
**Job Title:** Vice President Logistics  
Systems Division  
**T:** + 49 2408 9456 44  
**F:** + 49 2408 9456 45  
**E:** info@inform-software.com

**Pfister Waagen Bilanciai GmbH**

Linker Kreuthweg 9  
Affing-Mühlhausen  
D-86444  
Germany  
**Contact:** Ms Susanne Marketing  
and Sales Manager  
**Job Title:** Marketing and Sales  
Manager  
**T:** + 49 82 07 9 58 99 28  
**F:** + 49 82 07 9 58 99 29  
**E:** marketing@pfisterwaagen.de  
**W:** www.pfisterwaagen.de

**INDIA**

**Subarnarekha Port Private Ltd**

New No.84, Old No.50  
"Dakshin", 1st Ave, Indranagar  
Adyar  
Chennai  
600020  
India  
**Contact:** Mr Ramani Joint  
Managing Director  
**Job Title:** Joint Managing Director  
**T:** + 914424431900  
**F:** + 914442607368 - Ext 18  
**E:** subarnarekha.port@gmail.com  
**W:** www.creativeports.com

**MEXICO**

**Servicios Especiales Portuarios**

**S.A. de C.V.**

Bustamante 173-1  
Fracc Los Pinos  
Veracruz  
C.P. 91870  
Mexico  
**Contact:** Mr Andrew  
**T:** + 52 229 934 3718  
**F:** + 52 229 178 2329  
**E:** direccion@sepsaver.com  
**W:** www.sepsaver.com

**SOUTH  
AFRICA**

**Transnet**

PO Box 2058  
Empangeni  
KZN  
3880  
South Africa  
**Contact:** Mr Joe  
**T:** + 27 35 9067515





Manager  
 T: + 44 207 2003902  
 F: + 44 207 2003975  
 E: [crump@freightliner.co.uk](mailto:crump@freightliner.co.uk)  
 W: [www.freightliner.co.uk](http://www.freightliner.co.uk)  
 Heavy Haul is a leading player in the coal, aggregates and cement sectors. Also operating trains in the waste, petroleum and minerals markets, the company has carried out Infrastructure work for Network Rail since its inception in 1999.

#### GB Railfreight (FirstGBRF)

15-25 Artillery Lane  
 London  
 E1 7HA  
 UK  
**Contact:** Mr Mike Senior  
 Commercial Manager  
**Job Title:** Senior Commercial Manager  
 T: + 44 20 7983 5214  
 F: + 44 20 7983 5170  
 E: [mike.higgins@gbraillfreight.com](mailto:mike.higgins@gbraillfreight.com)  
 W: [www.gbraillfreight.com](http://www.gbraillfreight.com)

#### VTG Rail UK Ltd.

Sir Stanley Clarke House  
 7 Ridgeway  
 Quinton Business Park  
 Birmingham  
 B32 1AF  
 UK  
**Contact:** Mr Ian  
 T: + 44 121 421 9180  
 F: + 44 121 421 9184  
 E: [ian.shaw@vtg.com](mailto:ian.shaw@vtg.com)  
 W: [www.vtg.com](http://www.vtg.com)

## USA

#### Burlington Northern Railroad

3701 East Itasca Street  
 Superior  
 Wisconsin  
 54880  
 USA  
**Contact:** Ms Roxanne Director,  
 Media Relations  
**Job Title:** Director, Media Relations  
 T: + 1 817-867-6671

F: + 1 817-352-7925  
 E: [Roxanne.Butler@bnsf.com](mailto:Roxanne.Butler@bnsf.com)

#### CN Railway

17641 S. Ashland Avenue  
 Homewood  
 Illinois  
 60430  
 USA  
**Contact:** Mr Ken Account Manager  
**Job Title:** Account Manager  
 T: + 1 812 858 1860  
 F: + 1 812 858 1869  
 E: [ken.johnson@cn.ca](mailto:ken.johnson@cn.ca)  
 W: [www.cn.ca](http://www.cn.ca)

#### CSX

500 Water St  
 HQBldg, 6th Floor  
 Speed Code J842  
 Jacksonville  
 FL  
 32202  
 USA  
**Contact:** Mr Russ Director Coal  
 Facilities  
**Job Title:** Director Coal Facilities  
 T: + 1 904 366 5493  
 F: + 1 904 359 3341  
 E: [Russ\\_Epting@csx.com](mailto:Russ_Epting@csx.com)  
 W: [www.csx.com](http://www.csx.com)

#### CSX - Curtis Bay Coal Piers

Chesapeake Bay Area  
 1910 Benhill Avenue  
 Baltimore  
 Maryland  
 21226  
 USA  
**Contact:** Mr Lorenzo  
 T: + 1 410-355-6395  
 F: + 1 410-355-2088  
 E: [Marsha\\_SewellThompson@CSX.com](mailto:Marsha_SewellThompson@CSX.com)

#### Duraport Marine & Rail

##### Terminal, LLC

PO Box 1009  
 85 East 2nd Street  
 Bayonne  
 New Jersey  
 07002

USA  
**Contact:** Mr Vincent President  
**Job Title:** President  
 T: + 1 201 437 0703  
 F: + 1 201 437 0158  
 E: [Vincent@AlessiOrg.com](mailto:Vincent@AlessiOrg.com)  
 W: [www.Duraport.Net](http://www.Duraport.Net)  
 Multi Modal Port Terminal in The New York City Metropolitan Area ( Rail , Truck and Marine Terminal)  
 60 Car Rail Capacity with Rail Scale, 4 Truck Scales, 900' Bulkhead Deep Water

#### Ecofab Maintenance USA Inc.

1645 Lonsdale Avenue  
 North Vancouver  
 B.C.  
 V7M 2J5  
 USA  
**Contact:** Mr Doug  
 T: + 1 604 903 2000  
 F: + 1 604 903 2025  
 E: [dbock@ecofab.com](mailto:dbock@ecofab.com)  
 W: <http://www.ecofab.com/>

#### Electro-Motive Diesel (EMD) Inc

9301 West 55th Street  
 La Grange  
 IL  
 60525  
 USA  
**Contact:** Mr Scott  
 T: + 1 708 387 3938  
 F: + 1 708 387 6626  
 E: [frank.w.ward@EMDiesels.com](mailto:frank.w.ward@EMDiesels.com)

#### Kansas City Southern

427 West 12th Street  
 Kansas City  
 MI  
 64105  
 USA  
**Contact:** Mr Rich Sales &  
 Marketing  
**Job Title:** Sales & Marketing  
 T: + 1 816-983-1303  
 F: + 1 800-243-8624  
 E: [wweig@kcsouthern.com](mailto:wweig@kcsouthern.com)  
 W: [www.kcsi.com](http://www.kcsi.com)

#### Kinder Morgan Terminals

3500 N. Causeway Blvd  
 Suite 210  
 Metairie  
 LA  
 70002  
 USA  
**Contact:** Mr John Senior  
 Accountant  
**Job Title:** Senior Accountant  
 T: + 1 504 620 4639  
 F: + 1 504 620 4698  
 E: [john\\_vaughn@kindermorgan.com](mailto:john_vaughn@kindermorgan.com)

#### Krech Ojard & Assoc

227 W 1st St  
 Suite 200  
 Duluth  
 Minnesota  
 55082  
 USA  
**Contact:** Mr Kevin Director  
 Infrastructure Services  
**Job Title:** Director Infrastructure  
 Services  
 T: + 1 218 727 3282  
 F: + 1 218 727 1216  
 E: [kevin.ehrenreich@krechojard.com](mailto:kevin.ehrenreich@krechojard.com)  
 W: [www.krechojard.com](http://www.krechojard.com)

#### Norfolk Southern Coal Business Group

110 Franklin Road  
 S.E., Roanoke  
 VA  
 24042-0026  
 USA  
**Contact:** Mr Daniel D Senior Vice  
 President Energy and Properties  
**Job Title:** Senior Vice President  
 Energy and Properties  
 T: + 1 757 629 2813  
 E: [Danny.Smith@nscorp.com](mailto:Danny.Smith@nscorp.com)

#### Savage

Old River Operations  
 16800 Greenspoint Park Drive  
 Suite 120N  
 Houston  
 Texas

77060  
 USA  
**Contact:** Mr Joshua  
 T: + 1 281 673 1098  
 F: + 1 281 673 1086  
 E: [Joshknichel@savageservices.com](mailto:Joshknichel@savageservices.com)  
 W: [www.savageservices.com/](http://www.savageservices.com/)

#### TBS Shipping Services

612 Grassy Sprain  
 Yonkers  
 New York  
 10710  
 USA  
**Contact:** Mr Gregg  
 T: + 1 914 961 1000  
 F: + 1 914 961 2286  
 E: [TBSRates@nyc.tbsship.com](mailto:TBSRates@nyc.tbsship.com)  
 W: [www.tbsship.com/](http://www.tbsship.com/)

#### Union Pacific Railroad Co

1416 Dodle Street  
 Dodge room 400  
 Omaha  
 NE  
 68179  
 USA  
**Contact:** Mr Mark  
 T: + 1 402 5445459  
 F: + 1 402501 0011  
 E: [mwdavis@up.com](mailto:mwdavis@up.com)

#### Utah Railway Corporation

4692 North 300 West  
 Suite 220  
 Provo  
 Utah  
 UT 84604  
 USA  
**Contact:** Mr James M President  
 and General Manager  
**Job Title:** President and General  
 Manager  
 T: + 1 801 221 7460  
 F: + 1 801 221 7462  
 E: [jdavis@gwrr.com](mailto:jdavis@gwrr.com)  
 W: [www.gwrr.com](http://www.gwrr.com)





PORTS & TERMINALS



ALBANIA

DURRES

Port Authority of Durres

Lagja No.1 Rruga Tregtare  
Durres  
Albania  
Contact: Mr Partizan Osmani,  
Marketing  
F: + 355 52 23115  
E: apd@san.com.al  
W: www.apdurres.com/al

ALGERIA

ALGIERS

Entreprise Portuaire d'Alger

2 Rue d'Angkor  
PO Box 259  
Algiers  
Algeria  
Contact: Port Director  
T: +213 21 42 36 14 / 16 / 18 / 23 / 42  
F: + 213 21 42 36 06  
E: epa@portalger.com.dz  
W: www.portalger.com.dz

ANNABA

Entreprise Portuaire de Annaba

Môle Cigogne  
Quai Nord  
PO Box 1232  
Annaba  
23000  
Algeria  
Contact: Mr D Sahli, President  
Director General  
T: + 213 38 86 31 31/43  
F: + 213 38 86 54 15  
E: epan@annaba-port.com  
W: www.annaba-port.com  
Location: North East of Algeria  
Equipment & Capacity: Grain silo:  
Two (02) loading/offloading grain  
unloader with a total capacity of  
100&400tph,  
Vigan grain unloader capacity  
250tph

Phosphates: 03 unloader of 1000tph  
-1200tph  
Coke-Iron: 04 unloader of 800-  
1000tph  
05 Electy quay crane 25t  
02 Electy quay crane 40t  
UAN-Phosphoric Acid - Urée en  
vrac : unloader 320tph  
Bulk Berths: Berth12 :Grain Depth:  
9.80m, Length: 155ml  
Berth11: Raw sugar-vegetable oil  
Depth: 9.50m, Length:145ml  
Berth13 Coal - Iron ore Depth:  
13m, Length: 320ml  
Berth14-15 Steel products Depth:  
9.75m, Length:630ml  
Berth 16-17 et 19 : Phosphates  
Depth: 9.45m to 11m,  
Length:130-220ml  
Berth 18 UAN-Fuel-Tar-Ammonia  
Depth:11m, Length:125ml  
Total Uncovered Storage:  
163,000sqm  
Total Covered Storage: 50,000sqm

BEJAIA

Entreprise Portuaire de Bejaia

13 Avenue de la Amrani Brothers  
Bejaia  
06000  
Algeria  
Contact: Mr Achour Djelloul, Port  
Chairman General Manager  
T: + 213 34 21 18 07  
F: + 213 34 20 14 88  
E: portbj@portdebejaia.dz  
W: www.portdebejaia.dz  
Location: The North East of Algeria  
at 260 KM. East of Algiers and  
460km West of Annaba  
Equipment & Capacity: - grain  
vacu-vators (3x 250 tons per hour)  
- 2 cranes (1x 63 tons and 1x 80  
tons) equipped with 10 t grabs for  
grain handling,  
- 2 cranes (2x 10t)  
- 3 new cranes (3x 64t) equipped  
with 12 m3 grabs for grain handling  
Bulk Berths: 4 berths specialized  
for cargo bulk handling. Max length  
210m. Max draft 10.5m

BENI SAF

Entreprise Portuaire de Beni Saf

Route du Port  
Beni Saf  
Algeria  
T: + 213 43 225 468  
E: ypa@ynet.lye

GHAZAOUET

Port Authority of Ghazaouet

PO Box 217  
Ghazaouet  
13400  
Algeria  
Contact: Mr K Mehabi, Manager  
T: + 213 43 323353  
F: + 213 43 323255  
E: contact@portdeghazaouet.com  
W: www.portdeghazaouet.com

MOSTAGANEM

Entreprise Portuaire de Mostaganem

PO Box 131  
Mostaganem  
27000  
Algeria  
Contact: Mr Mohamed Bouabida,  
Port Director  
T: + 213 45 21 14 11  
F: + 213 45 33-01-15  
E: epm@port-mostaganem.dz  
W: www.port-mostaganem.dz/

SKIKDA

Entreprise Portuaire de Skikda

Avenue Rezki Rahal  
PO Box 65  
Skikda  
21000  
Algeria  
Contact: Port Director  
T: + 213 38 75 68 50 / 75 22 54  
F: + 213 38 75 20 15  
E: epskikda@skikda-port.com  
W: www.skikda-port.com

ANGOLA

LOBITO

Porto do Lobito E.P.

Largo Restoration 4  
Customs Building  
Lobito  
Benguela  
16  
Angola  
Contact: Mr José Carlos Gomes,  
Manager Director  
T: +244 272 224 686  
F: +244 272 224 971  
W: www.portdolobito.com  
Total Uncovered Storage: 100,000  
sqm  
Total Covered Storage: 25.853sqm  
Silos with 20,000t capacity

LUANDA

Cabinda Gulf Oil Company Limited

PO Box 2950  
Luanda  
Uige  
Angola  
Contact: Dr Agostinho Neto,  
Managing Director  
T: + 244 222 692 600  
F: + 244 222 394 348  
E: questoes@chevron.com  
W: www.chevroninangola.com

LUANDA

Porto de Luanda

Administracao do Porto de Luanda  
Largo 4 de Fevereiro  
Luanda  
1229  
Angola  
T: + 244 2 335 975  
F: + 244 2 840 535

E: portoluanda@snet.co.ao  
W: www.otal.com/angola

ARGENTINA

BAHIA BLANCA

Bahia Blanca Port  
Avenida Dr Mario M Guido  
8103 Ingeniero White  
Bahia Blanca  
Argentina  
Contact: Mr V Morán, General  
Manager  
T: + 54 291 457 3213  
F: + 54 291 457 3214  
E: secretaria@  
puertobahablanca.com.ar  
W: www.puertobahablanca.com

BAHIA BLANCA

Glencore/Toepfer Grain Elevator

Ingeniero White Port Area  
Bahia Blanca  
Argentina  
Contact: Mr Dario de Luca,  
T: + 54 291 72332  
F: + 54 291 72360  
E: dario.de.luca@glencore.com

BAHIA BLANCA

Oleaginoso Moreno Hermanos SA

Berths 2 and 3  
Puerto Galvan Port area  
Bahia Blanca  
8103  
Argentina  
T: + 54 291 457 3333  
E: jrutz@omhsa.com.ar

BAHIA BLANCA

Puerto De Bahia Blanca

Consorcio De Gestion Del Puerto  
De Quequen  
Puertos De Ing White Y Galvan  
Av Dr Mario Guido Ing White  
Bahia Blanca  
Argentina  
Contact: Mr Luis Alejandro Arecco,  
President  
T: + 54 291 457 3213  
F: + 54 291 457 3214  
W: www.puertobahablanca.com

BAHIA BLANCA

Terminal Bahia Blanca, Piers 5/6, 7/8 and 9

Ingeniero White Port Area  
Bahia Blanca  
Buenos Aires  
8103  
Argentina  
Contact: Mr Horacio Moretti,  
Manager  
T: + 54 91 457 3035  
F: + 54 91 457 1728  
E: horacio.moretti@bunge.com  
Location: Is located in Ingeniero  
White Port, Bahia Blanca City,  
Buenos Aires Province,Argentine  
Republic.  
Total Uncovered Storage: TBB  
covers a total area of 136,890 sqm.  
Total Covered Storage: The total  
storage capacity is about 197,000  
tons(wheat base) distributed among  
500 silos.  
The maximum discharging diary  
capacity is about 500 trucks and  
200 wagons.

BARRANQUERAS

Puerto de Barranqueras

Intervencion Provincial Puerto  
Barranqueras  
Av Rio Parana s/n  
Barranqueras  
Chaco  
3503  
Argentina  
Contact: Mr Daniel Ruben Gaborov,

T: + 54 3722 480216  
E: puertobqras@arnet.com.ar  
W: www.consejoportuario.com.ar

BARRANQUERAS

Puerto de Barranqueras

Av. Rio Parana s/n  
Barranqueras  
3503  
Argentina  
Contact: Mr Brandt,  
T: + 54 3722 480216  
F: + 54 3722 480216  
E: puertobqras@infovia.com.ar  
W: www.advance.com.ar

BUENOS AIRES

ACA Berth - San Lorenzo Port

Asociacion de Cooperatives  
Argentinas Coop.(ACA)  
940 Madero Avenue  
6th Floor  
Buenos Aires  
C1106ACW  
Argentina  
Contact: Mr Nestor E. Salaberry,  
Export Manager  
T: + 54 11 4310 1300 ext.  
1168/1170  
F: + 54 11 4313 1349  
E: Salaberry@acacoop.com.ar  
W: www.acacoop.com.ar  
Location: KM 446.2 of Parana  
River - Santa Fe Province -  
Argentina  
Bulk Berths: 273mt load; draught  
40feet alongside berth at datum but  
according to Parana River limitation.  
Total Covered Storage: 240,000mt  
dry grains. 11,000mt vegetable oils  
+ 70,000mt dry fertilizers +  
30,000mt liquid fertilizers.  
Import: dry and liquid fertilizers.  
Export: grains and oilseeds  
ACA is a cooperative that also  
provides throughput to other  
Argentine exporters.

BUENOS AIRES

ACA Berth Nbr 3 - Quequen Port

Asociacion de Cooperatives  
Argentinas Coop.(ACA)  
940 Madero Avenue  
6th Floor  
Buenos Aires  
C1106ACW  
Argentina  
Contact: Mr Nestor E. Salaberry,  
Export Manager  
T: + 54 11 4313 1300 ext.1168/1170  
F: + 54 11 4313 1349  
E: Salaberry@acacoop.com.ar  
W: www.acacoop.com.ar  
Location: Left hand margin at the  
mouth of the Quequen River,  
Buenos Aires, Argentina  
Bulk Berths: 230mt load; draught  
39 feet alongside at datum but  
according to Necochea Port  
restrictions  
Total Covered Storage: 180,000mt  
dry grains. 10,5000mt vegetable  
oils. 20,00mt dry fertilizers.  
Import: Dry fertilizers  
Export: Grains and vegetable oils  
ACA is a cooperative that also  
provides throughput to other  
Argentine exporters.

BUENOS AIRES

Del Bene SA

Piedras  
77-90 Piso  
Buenos Aires  
1070  
Argentina  
Contact: Snr Ferruccio Del Bene,  
T: + 54 11 4342 5211  
F: + 54 11 4343 5352  
E: latinamerica@  
savinodelbene.com

BUENOS AIRES

Quebracho Elevator

Avenida Leandro N Alem 928  
Buenos Aires  
1001  
Argentina  
Contact: Mr Luis Anunciata,  
T: + 54 11 4476 29049  
F: + 54 11 4476 29057

BUENOS AIRES

SA Berth

AV Paseo Colon 505  
Fourth Floor (CP1063)  
Buenos Aires  
Argentina  
Contact: Mr Sergio Suarez,  
T: + 54 11 4342 1727  
F: + 54 11 4346 8001  
E: institucionales@  
puertobuenosaires.gov.ar

BUENOS AIRES

Terminal 4

Av. Edison y Prefectura Naval  
Puerto Nuevo  
Capital Federal  
Buenos Aires  
C1104BCA  
Argentina  
Contact: Mr Juan Corujo, Terminal  
Manager  
T: + 54 11 45 900 900 Ext. 8120  
F: + 54 11 45 900 991  
E: bueaapmtmg@apmterminals.com  
W: www.apmterminals.com

BUENOS AIRES

Terminal Buenos Aires SA

Av. Edison y Calle Prefectura Naval  
Argentina  
Dársena D Sud 2da.  
Puerto Nuevo  
Buenos Aires  
1104  
Argentina  
Contact: Lic. Nicolas C Caporale,  
Gerente de Planta  
T: + 54 11 4311 3598  
F: + 54 11 4312 8031  
E: ncaporale@terbasa.com.ar

BUENOS AIRES

Terminal EMCYM

Dársena C Norte 3ra. Sección  
Puerto Nuevo  
Buenos Aires  
1104  
Argentina  
T: + 54 11 4313 0332  
F: + 54 11 4313 0347  
E: maritima@basal.com  
W: www.basal.com

BUENOS AIRES

Terminals Rio de la Plata

Avda R.S. Castillo y Comodoro Py  
Buenos Aires  
C1104BEN  
Argentina  
T: + 54 11 4319 9500  
F: + 54 11 4315 2700  
E: info@trp.com.ar  
W: www.trp.com.ar

BUENOS AIRES

TPA Terminals Portuarias Argentinas

Avenida Ramon Castillo 8  
Av. de los Inmigrantes y Av. Edison  
Acceso Maipu - Zona Puerto  
Buenos Aires  
1104  
Argentina  
Contact: Mr M Barea,  
T: + 54 11 4342 1727  
F: + 54 11 4342 6836  
W: www.puertobuenosaires.gov.ar

DIAMANTE

Port of Diamante

Puerto Nuevo  
3105

Diamante  
Entre Rios Province  
Argentina  
**Contact:** Mr Gheradi,  
T: + 54 343 498 1424  
F: + 54 343 498 1424  
E: eapdotde@infoshopdte.com.ar

## ENSENADA

**La Plata Port Administration**  
St. G. Gaggino y Ortiz de Rosas  
Ensenada  
Buenos Aires Province  
Argentina  
**Contact:** Port Director  
T: + 54 221 460 0233  
F: + 54 21 601014  
E: cgppl@ba.net

## PUERTO GENERAL SAN MARTIN

**Terminal 6 S.A.**  
Hipólito Yrigoyen y Costa del Paraná  
Puerto General San Martín  
Puerto General San Martín  
Provincia de Santa Fe  
CP 2202  
Argentina  
**Contact:** Mr Pablo Ferrés Sayago,  
General Manager  
T: + 54 3476 438066  
F: + 54 3476 438046  
E: avaldez@terminal6.com.ar  
W: www.terminal6.com.ar

## QUEQUEN

**Consorcio de Gestion del Puerto de Quequen**

Avda. Juan de Garay 850  
Quequen  
Buenos Aires  
7631  
Argentina  
**Contact:** Mr Jose Luiz , President  
T: + 54 2262 450006  
F: + 54 2262 450006  
E: secrelania@puertoquequen.com  
W: www.puertoquequen.com  
**Location:** South East of the Province of Buenos Aires on the Atlantic Coast.

## QUEQUEN

**Puerto Quequen**  
Avenue Juan de Garay 850  
Quequen  
Buenos Aires  
B7631XAF  
Argentina  
**Contact:** Mr Jose Alfredo Bisciotti,  
President  
T: + 54 2262 450 006  
F: + 54 2262 450 006  
E: info@puertoquequen.com  
W: www.puertoquequen.com

## ROSARIO

**Neptun SA - Operadores Maritimos**  
Terminal 1 s/no  
(Puerto Rosario)  
Rosario  
Santa Fe  
2000  
Argentina  
**Contact:** Mr Alejandro Jose Peirone, Administrative Manager  
T: + 54 57 1221 9406  
F: + 54 341 4808304  
E: info@neptunlog.com  
W: www.neptunlog.com

## ROSARIO

**Puerto Rosario**  
Cordoba 1464 4 Piso de C  
Rosario  
PICA de Santa Fe  
2000  
Argentina  
**Contact:** Mr Marcelo J Suarez, Vice President  
T: + 54 341 4487105

F: + 54 341 4485010

## ROSARIO

**Puerto Rosario**  
Ente Administrator Puerto Rosario  
Av Belgrano 341  
Rosario  
PICA de Santa Fe  
Argentina  
**Contact:** Mr Carlos Bermudez,  
T: + 54 341 448 7105  
F: + 54 341 448 5010  
E: webcgpq@puertoquequen.com  
W: www.enapro.com.ar

## SAN LORENZO

**Port of San Lorenzo**  
ACA Berth  
Avenida San Martín 2898  
San Lorenzo  
2200  
Argentina  
**Contact:** Mr Ing Raul Frugoli,  
T: + 54 476 22225  
F: + 54 476 22225  
E: info@terminal6.com.ar

## SAN LORENZO

**Vicentin Elevator**  
Km 441  
San Lorenzo  
Argentina  
**Contact:** Mr Jorge Forbitti,  
T: + 54 3 476 424 899  
F: + 54 3 476 425 977  
E: consulitas@vicentin.com.ar  
W: www.vicentin.com.ar

## SAN PEDRO

**Puerto de San Pedro**  
Administracion Portuaria  
Bonaerense  
Ruta 191 Km. 0  
San Pedro  
San Pedro  
2930  
Argentina  
**Contact:** Mr Miguel Hogo Gremio,  
T: + 54 3329 425378  
F: + 54 3329 425279  
W: www.consejoportuario.com.ar

## SAN PEDRO

**Terminal Puerto San Pedro S.A.**  
Av. San Martín 2500  
San Pedro  
Argentina  
**Contact:** Mr A Franco, Port Director  
T: + 54 3329 420999  
F: + 54 3329 425279  
E: info@tpp.com.ar  
W: www.tpp.com.ar

## SANTA FE

**Administracion Puerto Santa Fe**  
Cabecera Darsena 1  
3000  
Santa Fe  
Argentina  
**Contact:** Mr Montero, Port Director  
T: + 54 342 455 8400  
F: + 54 342 455 8392  
E: info@puertosfe.com.ar  
W: www.puertosfe.com.ar

## VILLA CONSTITUCION

**Villa Constitucion Port Authority**  
Villa Constitucion  
Santa Fe  
Argentina  
**Contact:** Mr Martin Mansino,  
T: + 54 3400 475012  
F: + 54 400 74404  
E: eapvc@cablenet.com.ar

## ZARATE

**Zarate Port SA**  
Avda. Pagola 2007  
Zarate

B2800DDO  
Argentina  
**Contact:** Mr Juan Gargantini,  
General Manager  
T: +54 3487 423010  
F: +54 3487 423212  
E: juanargantini@zport.com.ar  
W: www.zport.com.ar

## ARUBA

### ORANJESTAD

**Port of Oranjestad**  
Aruba Ports Authority N.V.  
Port Administration Building  
L.G. Smith Blvd. # 23  
Oranjestad  
Aruba  
**Contact:** Mr Alfonso J Boekhoudt,  
Managing Director  
T: + 297 582 6633  
F: + 297 583 2896  
E: Alfonso.Boekhoudt@arubaports.com  
W: www.arubaports.com

### SAN NICOLAS

**San Nicolas Bay Port**  
Coastal Aruba Refining Co NV  
PO Box 2150  
San Nicolas  
Aruba  
**Contact:** Mr Jack Marshall,  
Manager  
T: + 297 589 4500  
F: + 297 589 8000  
E: psn@intercom.com.ar  
W: www.consejoportuario.com.ar

## AUSTRALIA

### ADELAIDE

**Flinders Ports Pty Ltd**  
296 St Vincent Street  
Port Adelaide  
Adelaide  
South Australia  
5015  
Australia  
**Contact:** Mr Wayne Parham,  
Marketing Manager  
T: + 61 8 8447 0611  
F: + 61 8 8447 0606  
E: flindersports@flindersports.com.au  
W: www.flindersports.com

### ADELAIDE

**Flinders Ports Pty. Ltd**  
296 St. Vincent Street  
PO Box 19  
Adelaide  
S.A. 5015  
Australia  
**Contact:** Mr Carl Kavina, General Manager - Marine Operations  
T: + 61 8 8447 0611  
F: + 61 8 8447 0606  
E: flindersports@flindersports.com.au  
W: www.flindersports.com.au  
**Location:** Gulf of St Vincent, South Australia  
**Equipment & Capacity:** Crane 1 (spreader 46t, hook 60t), Crane 2 (36t spreader, hook 46t) Crane 4 (spreader 40t, hook N/A) Crane 5 (spreader 65t, Hook 75t), Viterra Grain Loader - 2,000tph  
**Bulk Berths:** Inner Harbour, berth 27 two travelling loading booms with spouts, 1450tph max for wheat, berth 29 mobile snake sandwich conveyor max 1000 tph, H berth fixed loader with luffing & slewing boom, Osborne & Outer Harbor, berth 8

### ADELAIDE

**Port Giles Grain Terminal**  
Grain House  
124-130 South Terrace

Adelaide  
5001  
Australia  
T: + 61 8 8211 7199  
F: + 61 8 8231 1249  
E: viterra.aus@viterra.com  
W: www.abb.com.au

## ADELAIDE

**Port Pirie Grain Terminal**  
Berth 2  
Grain House  
123-130 South Terrace  
Adelaide  
SA  
5001  
Australia  
T: + 61 8 8632 1455  
F: + 61 8 8632 5918  
E: flindersports@flindersports.com.au

## ADELAIDE

**SACBH Ardrossan Grain Terminal**  
Grain House  
123-130 South Terrace  
Adelaide  
SA  
5001  
Australia  
T: + 61 8 8211 8087  
F: + 61 8 8211 8087  
E: viterra.aus@viterra.com  
W: www.abb.com.au

## ADELAIDE

**Thevenard Grain Terminal**  
Grain House  
123-130 South Terrace  
Adelaide  
SA  
5001  
Australia  
T: + 61 8 8211 8087  
F: + 61 8 8211 8087  
E: flindersports@flindersports.com.au

## ADELAIDE

**Wallaroo Grain Terminal**  
Berth 2  
Grain House  
123-130 South Terrace  
Adelaide  
SA 5001  
Australia  
T: + 61 8 8211 8087  
F: + 61 8 8211 8087  
E: flindersports@flindersports.com.au  
W: www.flindersports.com.au

## ALBANY

**Port of Albany**  
85 Brunswick Road  
PO Box 175  
Albany  
WA 6330  
Australia  
**Contact:** Captain Steve Young,  
Harbour Master  
T: + 61 8 9892 9000  
F: + 61 8 9841 7566  
E: apa@albanyport.com.au  
W: www.albanyport.com.au

## BONDI JUNCTION

**ADM**  
Level 10 Suite 1002  
1 Newland Street  
Bondi Junction  
New South Wales  
2022  
Australia  
**Contact:** Mr Nigel Hart, Global Director - Ports  
T: + 61 417227412  
E: Nigel.Hart@adm.com  
W: www.adm.com

## BRISBANE

**Cape Flattery**  
Ports Corporation of Queensland

PO Box 409  
Brisbane  
QLD 4001  
Australia  
**Contact:** Mr Tycho Buringh,  
Commercial Manager  
T: + 61 7 3244 7088  
F: + 61 7 3224 7234  
E: tburingh@nqbp.com.au  
W: www.pcq.com.au  
**Location:** Over 200 kms North of Cairns, on the east coast of the Cape York Peninsula, Australia  
**Equipment & Capacity:** On shore Silica Sand handling and stock pile facilities and a single trestle jetty and conveyor running from the mine to an off-shore berth and ship loader  
There is also a general purpose wharf where two line boats are moored (they assist in ship berthing). No tugs are required at the port.

## BRISBANE

**Mitchell Ports**  
112 Bluestone Circuit  
Seventeen Mile Rocks  
Brisbane  
Queensland  
4073  
Australia  
**Contact:** Mr Robert Thatcher,  
T: + 61 7 3722 7277  
F: + 61 7 3722 7256  
E: r.thatcher@mitchellgroup.net  
W: www.mitchellgroup.net/

## BRISBANE

**North Queensland Bulk Ports Corporation Limited**  
GPO Box 409  
Brisbane  
Queensland  
4001  
Australia  
**Contact:** Mr Steve Lewis, CEO  
T: + 61 7 3011 7900  
F: + 61 7 3011 7997  
E: info@nqbp.com.au  
W: www.nqbp.com.au  
**Location:** Port Authority for Weipa, Abbot Point, Mackay, Hay Point & Maryborough; northwest coast and east coast of Queensland.  
**Equipment & Capacity:** Total throughput 2011-2012 approx. 124 million tonnes.  
**Bulk Berths:** See port handbooks. The sea port facilities managed by NQBP are vital to the export and import performance of Queensland and Australia. NQBP ports handle bulk shipments of coal, bauxite, sand, sugar, grain, petroleum and general cargo.

## BRISBANE

**Port Weipa**  
Ports Corporation of Queensland  
PO Box 409  
Brisbane  
QLD 4001  
Australia  
**Contact:** Mr Brad Fish, CEO  
T: + 61 7 3224 1088  
F: + 61 7 3224 7234  
E: info@pcq.com.au  
W: www.pcq.com.au  
**Location:** Located on the North-West coast of the Cape York Peninsula - Australia  
**Equipment & Capacity:** Total Bauxite export 2004/05: 15,519,910 tonnes  
**Bulk Berths:** Contact the Regional Harbour Master for current data. Phone (07) 4052 7412  
Other port facilities include general purpose and fuel wharves and tugs operated by Weipa Tug Service. Pilotage service provided by Maritime Safety Queensland.

## BRISBANE

**Queensland Bulk Handling Coal Export Terminal**  
3 Bulk Terminals Drive  
Port of Brisbane  
Brisbane  
Queensland  
4178  
Australia  
**Contact:** Terminal Manager  
T: + 61 7 3895 6500  
F: + 61 7 3895 1170  
E: qbhl@qbh.com.au  
W: www.qbh.com.au  
**Location:** Port of Brisbane, Queensland, Australia

## BUNBURY

**Southern Ports Authority - Port of Bunbury**  
PO Box 4  
54 Casuarina Drive  
Bunbury  
Western Australia  
WA 6231  
Australia  
**Contact:** Mr Darren Lambourn,  
General Manager Port  
T: + 61 8 9729 6500  
F: + 61 8 9721 8253  
E: enquiries.bunbury@southernports.com.au  
W: www.southernports.com.au  
**Location:** 170kms from Perth and some 15kms from the Kemerton Industrial Park.

**Equipment & Capacity:** Three bulk shiploaders (2 privately owned & operated). In addition the Port has two mobile hoppers for the discharge of bulk cargo and two mobile harbour cranes. Loading capacities of the shiploaders range from 1,000tph to approximately 2,000tph.  
**Bulk Berths:** Seven berths - serviced by deep water of up to 12.2m and uses a dynamic underkeel clearance to allow maximum freight to be carried by vessels.  
**Total Uncovered Storage:** Over 500 hectares of land suitable for Port related industry, much of which has direct access to berths and/or shiploading facilities.  
**Total Covered Storage:** Provides a number of storage facilities ranging in size from 10,000sqm to 4,000sqm.  
The Authority has in place state of the art infrastructure, deep water and excellent transport corridors for the efficient and competitive exchange of goods between sea and land.

## BURNIE

**Tasmanian Ports**  
PO Box 216  
Burnie  
Tasmania  
7320  
Australia  
**Contact:** Captain Trevor Bozoky,  
Harbour Master & Deputy CEO  
T: + 61 3 6434 7300  
F: + 61 3 6434 7373  
E: secretary@tasports.com.au  
W: www.burnieport.com

## CAIRNS

**Ports North**  
PO Box 594  
Cairns  
QLD 4870  
Australia  
**Contact:** Mr Chris Boland, Chief Executive Officer  
T: + 61 7 4052 3842  
F: + 61 7 4052 3853  
E: chris.boland@portsnorth.com.au  
W: www.portsnorth.com.au  
**Location:** Far North East Coast of Australia in the State of



Queensland.  
**Bulk Berths:** Bulk discharges via hopper to truck on general cargo wharf.  
**Total Uncovered Storage:** N/A

**CARRINGTON**  
**GrainCorp Operations Ltd**  
 Denison Street  
 (PO Box 64)  
 Carrington  
 NSW  
 2294  
 Australia  
**Contact:** Mr Mark Jelbart,  
 T: + 61 2 4224 6400  
 F: + 61 2 4224 6466  
 E: mjelbart@graincorp.com.au  
 W: www.graincorp.com.au

**CARRINGTON**  
**Newcastle Agri Terminal**  
 Lvl 1 92 Hill Street  
 Carrington  
 New South Wales  
 2294  
 Australia  
**Contact:** Mr Jock Carter, Executive Director  
 T: + 61 4 2728 3999  
 E: jcarter@naterminal.com.au

**CARRINGTON**  
**Port Waratah Coal Services Limited (PWCS)**  
 PO Box 57  
 Carrington  
 New South Wales  
 2294  
 Australia  
**Contact:** Mr Hennie du Plooy, Chief Executive Officer  
 T: + 61 2 4907 2000  
 F: + 61 2 4907 3000  
 E: contact\_us@pwcs.com.au  
 W: www.pwcs.com.au  
**Location:** Newcastle, NSW, Australia  
**Equipment & Capacity:** Two coal export facilities with a combined throughput capacity of 145 million tpa.  
**Bulk Berths:** 5 berths, each approximately 300m in length.  
**Total Uncovered Storage:** N/A  
**Total Covered Storage:** N/A  
 Port Waratah Coal Services Limited (PWCS), located in the Port of Newcastle, NSW, Australia, operates the world's largest and most efficient coal handling facility.

**DAMPIER**  
**Dampier Port Authority**  
 PO Box 285  
 Dampier  
 WA 6713  
 Australia  
**Contact:** Mr C Norman, General Manager  
 T: + 61 91 596555  
 F: + 61 91 596557  
 E: info@dpa.wa.gov.au  
 W: www.dpa.wa.gov.au

**DARWIN**  
**Darwin Port Corporation**  
 GPO Box 390  
 Darwin  
 NT  
 0801  
 Australia  
**Contact:** Mr Robert Ritchie, Chief Executive Officer  
 T: + 61 8 8922 0644  
 F: + 61 8 8922 0666  
 E: darwinport.dpa@nt.gov.au  
 W: www.darwinport.nt.gov.au

**DARWIN**  
**P&O Automotive and General Stevedoring**  
 PMB 23

Berrimah  
 Darwin  
 Northern Territory  
 0828  
 Australia  
**Contact:** Mr Michael Van Brederode, Regional Manager  
 T: + 61 8 8922 2300  
 F: + 61 8 8941 0604  
 E: craig.doude@poags.com.au  
 W: www.poags.com.au  
**Location:** Top of Australia, Northern Territory  
**Equipment & Capacity:** Heavy machinery and Portainer and mobile cranes  
**Bulk Berths:** Dry Bulk - discharge grabs and hoppers and bulk ship loader for loading  
 Liquid bulk - discharging and loading equipment available  
**Total Uncovered Storage:** As requested  
**Total Covered Storage:** As requested

**EAST DAVENPORT**  
**P & O Automotive & General Stevedoring**  
 Berth No 1, Spirit of Tasmania Terminal  
 The Esplanade  
 East Davenport  
 Tasmania  
 7310  
 Australia  
**Contact:** Operations Manager  
 T: + 61 3 6427 0138  
 F: + 61 3 6427 8466

**EAST PERTH**  
**James Point Pty Ltd (JPPL)**  
 Level 2, 6 Bennett Street  
 East Perth  
 Western Australia  
 6004  
 Australia  
**Contact:** Dr Chris Whitaker, Chairman  
 T: + 61 408 428 079  
 F: + 61 8 9202 1607  
 E: chris.whitaker@jamespoint.com.au  
 W: www.jamespoint.com.au

**ESPERANCE**  
**Esperance Ports - Sean & Land**  
 Corner of Bower Avenue & The Esplanade  
 PO Box 35  
 Esperance  
 WA  
 6450  
 Australia  
**Contact:** General Manager of Commercial  
 T: + 61 8 9072 3333  
 F: + 61 8 9071 1312  
 E: esppta@esperanceport.com.au  
 W: www.esperanceport.com.au  
**Location:** Located on the Southern Ocean Coastline of Western Australia, approximately 720kms South East of the State Capital Perth.

**Equipment & Capacity:** (Storage Capacity)  
 Iron Ore: 900,000 Tonnes  
 Nickel: 500,000 Tonnes  
 Containers: 15,000 - 20,000  
 Fertiliser: 100,000 Tonnes  
 Sulphur: 20,000 Tonnes  
 Grain: 250,000 Tonnes  
**Bulk Berths:** Cape Size Berth capable of loading 3,000tph  
**Total Uncovered Storage:** Approx. 89,000sqm  
**Total Covered Storage:** Approx. 128,000sqm

**FREMANTLE**  
**Fremantle Ports**  
 PO Box 95  
 Fremantle

WA  
 6959  
 Australia  
**Contact:** Mr Chris Leatt-Hayton, CEO  
 T: + 61 8 9430 3555  
 F: + 61 8 9336 1391  
 E: mail@fremantleports.com.au  
 W: www.fremantleports.com.au

**GEELONG**  
**Geelong Port**  
 PO Box 344  
 Geelong  
 Victoria  
 3220  
 Australia  
**Contact:** Mr Ken Stanley, Operations Manager  
 T: + 61 3 52470200  
 F: + 61 3 52721560  
 E: k.stanley@patrick.com.au  
 W: www.geelongport.com.au  
**Location:** Southern Australia on Port Phillip Bay.  
**Equipment & Capacity:** Two level luffing cranes at Lascelles Wharf - Grabs up to 3,000 tonnes per shift and hooks 27.5 tonnes at 28m radius.  
 Dry Bulk Loader at Corio Quay - 1,000 tph capacity  
**Bulk Berths:** Corio Quay North No 1 & No 2 berths  
 Length 375m, Draught 10.4m  
 Lascelles Wharf No 1 Berth  
 Length 185m, Draught 11.7 m  
 Lascelles Wharf Nos 2 & 3 Berths  
 Length 436m, Draught 11.7m  
**Total Uncovered Storage:** 20,000sqm  
**Total Covered Storage:** 15,500sqm

**GERALDTON**  
**Geraldton Port Authority**  
 289 Marine Terrace  
 PO Box 1856  
 Geraldton  
 WA  
 6531  
 Australia  
**Contact:** Capt Martin North, Harbour Master  
 T: + 61 8 9964 0547  
 F: + 61 8 9964 0555  
 E: martin.north@gpa.wa.gov.au  
 W: www.gpa.wa.gov.au  
**Location:** North West Coast of Australia. Approximately 200nm North of Fremantle.

**GLADSTONE**  
**Barney Point Coal Terminal**  
 Central Queensland Ports Authority  
 PO Box 259  
 Gladstone  
 Queensland  
 QLD 4680  
 Australia  
**Contact:** Mr Peter O'Sullivan,  
 T: + 61 74 976 1471  
 F: + 61 74 972 3045  
 E: osullivanp@cqpa.com.au  
 W: www.gpa.org.au

**GLADSTONE**  
**Central Queensland Ports Authority**  
 PO Box 259  
 Gladstone  
 Queensland  
 4680  
 Australia  
**Contact:** Mr Craig Doyle, CEO  
 T: + 61 749 761 333  
 F: + 61 749 723 045  
 E: doylec@cqpa.com.au  
 W: www.cqpa.com.au

**GLADSTONE**  
**Gladstone Ports Corporation**  
 PO Box 259  
 Gladstone  
 Queensland

4680  
 Australia  
 T: + 61 7 4976 1333  
 F: + 61 7 4972 2419  
 E: geninfo@gpocl.com.au  
 W: www.gpocl.com.au  
**Location:** The Port of Gladstone is located 525 kilometres north of Brisbane in Queensland. The Port is just south of the Tropic of Capricorn. The Port of Rockhampton is located 62 kilometres east of Rockhampton, on the southern tip of the Fitzroy River Delta in Queensland. The Port of Bundaberg is situated 19 kilometres downstream from the City of Bundaberg in Queensland, approximately 5 kilometres from the mouth of the Burnett River.  
**Equipment & Capacity:** The Port of Gladstone has eight (8) wharf centres comprising 20 wharves. It encompasses 4,448 hectares (ha) of land, including more than 700ha of reclaimed land. The Port of Rockhampton has three (3) wharf facilities and covers 5,812 hectares of land. The Port of Bundaberg is serviced by two (2) main wharves and covers 507 hectares of land. For more information about GPC's facilities and services, visit www.gpocl.com.au

**GLADSTONE**  
**Grainco Queensland Gladstone Terminal Berth 2**  
 Gladstone Port Authority  
 19 Yarroun Street  
 PO Box 259  
 Gladstone  
 Queensland  
 4680  
 Australia  
**Contact:** Mr Craig Boyle, Chief Executive Officer  
 T: + 61 7 4976 1333  
 F: + 61 7 4972 3045  
 E: info@gpa.org.au  
 W: www.gpa.org.au

**HASTINGS**  
**Port of Hastings Authority**  
 PO Box 129  
 Hastings  
 VIC 3915  
 Australia  
**Contact:** Mr Shane Vedamuttu, Harbour Master  
 T: + 61 3 5979 5500  
 F: + 61 3 5979 5555  
 E: enquiries@portofhastings.com

**KOORAGANG ISLAND**  
**Newcastle Coal Infrastructure Group**  
 Locked Bag 6003  
 Hunter Region Mail Centre  
 Kooragang Island  
 NSW  
 2310  
 Australia  
**Contact:** Mr Aaron Johansen, CEO  
 T: + 61 2 4920 3900  
 E: enquiries@ncig.com.au  
 W: www.ncig.com.au

**MACKAY**  
**BMA Hay Point Services**  
 MS 283  
 Mackay  
 Queensland  
 4740  
 Australia  
**Contact:** Mr Peter Hanrahan, General Manager  
 T: + 61 7 4943 5201  
 F: + 61 7 4956 3421  
 E: peter.f.hanrahan@bhpbilliton.com  
 W: www.bhpbilliton.com  
**Location:** East Coast of Queensland, Australia  
**Equipment & Capacity:** 44Mtpa Port Authority: Ports Corporation

Queensland Limited.  
**MACKAY**  
**Dalrymple Bay Coal Terminal (DBCT)**  
 Martin Armstrong Drive  
 Hay Point  
 Mackay  
 QLD  
 4740  
 Australia  
**Contact:** Ms Sharon Johnston, Senior Specialist Public Relations  
 T: + 61 7 4943 5645  
 F: + 61 7 4943 8466  
 E: sharon.johnston@dbct.com.au  
 W: www.dbct.com.au  
**Location:** Hay Point Mackay Queensland Australia  
**Equipment & Capacity:** Total Coal export 2004/05: 50,248,059.  
 2x stackers: 5,500 - 6,000tph  
 1x reclaimers: 3,300 - 4,200tph  
 5x stacker reclaimers: 3,300 - 5,800tph  
 3x shiploaders: 7,200 - 7,950 tph  
**Bulk Berths:** Berth 1: 662m (combined with B2), 17.9mLAT (depth)  
 Berth 2: 662m (combined with B1), 18.4mLAT (depth)  
 Berth 3: 250m, 18.8LAT (depth)  
**Total Uncovered Storage:** up to 1.4Mt  
**Total Covered Storage:** n/a  
 n/a

**MELBOURNE**  
**Port of Melbourne Corporation**  
 GPO Box 261  
 Melbourne  
 VIC  
 3001  
 Australia  
**Contact:** Mr Stephen Bradford, Chief Executive Officer  
 T: + 61 39 683 1386  
 F: + 61 39 683 1385  
 E: info@portofmelbourne.com.au  
 W: www.portofmelbourne.com.au

**NEWCASTLE**  
**Newcastle Port Corporation**  
 PO Box 633  
 Newcastle  
 New South Wales  
 2300  
 Australia  
**Contact:** Mr Bill Norrie, Trade Development Manager  
 T: + 61 2 4985 8222  
 F: + 61 2 4926 4596  
 E: Bill.n@newportcorp.com.au  
 W: www.newportcorp.com.au  
**Location:** East Coast of Australia  
 70 nautical miles north of Sydney.  
**Equipment & Capacity:** Variety of ship handling facilities including pneumatic grabs, ships grabs, berth gantry grabs, pipelines, belt loaders and ships cranes.  
**Bulk Berths:** 19 operational berths. 11 berths dedicated to general cargo, bulk, break bulk and project cargoes. 8 berths dedicated to coal.  
**Total Uncovered Storage:** Large range of opportunities available  
**Total Covered Storage:** Range of facilities available  
 One of our core objectives is to facilitate trade growth and to ensure the best use of port facilities and infrastructure. Contact Business Development for more information on our capabilities.

**NORTH SYDNEY**  
**Patrick Stevedores Operations Pty Limited**  
 Level 6  
 15 Blue Street  
 North Sydney  
 NSW  
 2060

Australia  
**Contact:** Mr John Horan, General Manager Contracts & Marketing  
 T: + 61 2 8484 8110  
 F: + 61 2 8484 8176  
 E: j.horan@patrick.com.au  
 W: www.patrick.com.au  
**Location:** Pan Australia  
 Scope of business; container terminal operators, automotive and general stevedores, automotive PDI and distribution services, logistics providers and rail operator.

**PERTH**  
**CBH Albany Grain Terminal**  
 GPO Box L886  
 Perth  
 WA  
 6842  
 Australia  
**Contact:** Mr Will Piercey, Terminal Manager  
 T: + 61 8 9845 5555  
 F: + 61 8 9841 8499  
 E: info@cbh.com.au  
 W: www.cbh.com.au

**PERTH**  
**CBH Esperance Grain Terminal**  
 GPO Box L886  
 Perth  
 WA  
 6842  
 Australia  
**Contact:** Mr Michael Colgan, Terminal Manager  
 T: + 61 8 9071 2302  
 F: + 61 8 9071 4040  
 E: info@cbh.com.au  
 W: www.cbh.com.au

**PERTH**  
**CBH Geraldton Grain Terminal**  
 GPO Box L886  
 Perth  
 WA  
 6842  
 Australia  
**Contact:** Mr Eric Cooper, Terminal Manager  
 T: + 61 8 9921 9499  
 F: + 61 8 9921 7463  
 E: info@cbh.com.au  
 W: www.cbh.com.au

**PERTH**  
**CBH Kwinana Grain Terminal**  
 GPO Box L886  
 Perth  
 WA  
 6842  
 Australia  
**Contact:** Mr Justin Bayles, Terminal Manager  
 T: + 61 8 9591 5100  
 F: + 61 8 9527 7938  
 E: info@cbh.com.au  
 W: www.cbh.com.au

**PINEKENBA**  
**Grainco Queensland Pinekenba Terminal**  
 31 Soutter Street  
 Pinekenba  
 Queensland  
 4008  
 Australia  
 T: + 61 7 638 2440  
 F: + 61 7 638 2440  
 E: enquiries@graincorp.com.au

**PORT ADELAIDE**  
**Flinders Ports - Port Pirie**  
 PO Box 19  
 Port Adelaide  
 SA 5015  
 Australia  
**Contact:** Mr Shane Nielsen, Operations Manager

T: + 61 8 8632 1455  
 F: + 61 8 8447 0606  
 E: flindersports@flindersports.com.au  
 W: www.flindersports.com.au  
**Location:** Spencer Gulf, South Australia  
 Latitude 33 degrees - 10 minutes south  
 Longitude 138 degrees - 02 minutes east  
**Equipment & Capacity:** One ship unloader - 29 tonnes, five slewing booms with spouts, gantry loader  
**Bulk Berths:** Berth 6, Zinc concentrates

## PORT HEDLAND

**Port Hedland Port Authority**  
 PO Box 2  
 Port Hedland  
 WA 6721  
 Australia  
**Contact:** Ms Paige Carroll, Executive Secretary  
 T: + 61 8 9173 0011  
 F: + 61 8 9173 0060  
 E: paige.carroll@phpa.com.au  
 W: www.phpa.com.au

## PORT KEMBLA

**Port Kembla Port Corporation**  
 PO Box 89  
 Port Kembla  
 New South Wales  
 2505  
 Australia  
**Contact:** Mr Ray Smith, Manager Business Development  
 T: + 61 2 4275 0113  
 F: + 61 2 4274 0643  
 E: enquiries@portkembla.com.au  
 W: www.portkembla.com.au  
**Location:** Port Kembla is located 80km south of Sydney on the East Coast of Australia.

**Equipment & Capacity:** Berth 202: One 17 tonne luffing crane; one 500tph shiploader.  
 Berth 109: Two 30 tonne luffing cranes  
 No. 2 Discharge Berth: Two 15 tonne travelling transporter grab cranes-gross loading rate 500tph and one 35 tonne travelling transporter grab crane-gross rate 1,000tph.  
 Berth 102: Two gantry shiploaders-nominal loading rate 6,600tph  
 Berth 101: One gantry shiploader-nominal loading rate 1m200tph hour.  
**Bulk Berths:** Outer Harbour: Berths 202,204 - 300m, 10.40m  
 Berths 203,205 - 300m 9.40m  
 Inner Harbour:  
 Berth 113 - 192m, 11.0m  
 Berth 109 - 220m, 12.20m  
 Berth 112 - 278m, 12.80m  
 Berth 111 - 310m, 15.75m  
 Berths 105,106 - 510m, 16.00m  
 Berth 107 - 290m, 12.3m  
 Berth 104 - 290m, 12.3m  
 Berth 104 (air draught 17m) - 233m, 15.10m  
 Berth 102 (air draught 22.4m)- 300m, 16.25m  
 Berth 101 (air draught 17.4m) - 215m, 11.60m  
**Total Uncovered Storage:** 80 hectares  
**Total Covered Storage:** 20,000sqm  
 The Port is a major trade centre for coal, steel and grain. The Port is now the facility for all imported vehicles for NSW.

## PORT LINCOLN

**Flinders Ports P/L**  
 PO Box 354  
 Port Lincoln  
 SA 5606  
 Australia  
**Contact:** Captain Robert Cobban

MNI, Port Pilot  
 T: + 61 886 823633 / 868 23723  
 F: + 61 886 826725  
 E: captrobb@ozemail.com.au  
 W: www.flindersports.com.au  
**Location:** South Australia - Spencer Gulf  
**Bulk Berths:** Two with Depth 15 metres

## PORT OF BRISBANE

**Port of Brisbane Pty Ltd**  
 Locked Bag 1818  
 Port of Brisbane  
 Queensland  
 4178  
 Australia  
**Contact:** Trade Services Team  
 T: + 61 7 3258 4888  
 F: + 61 7 3258 4703  
 E: info@portbris.com.au  
 W: www.portbris.com.au  
**Location:** Australia, East Coast, Queensland, Brisbane  
**Equipment & Capacity:** Fisherman Islands Grain: grain loading - up to 2,200tph, woodchips loading - 1,000tph, sugar loading - 800tph, cottonseed loading - 600tph.  
 Fisherman Islands Coal: coal loading - up to 3,000tph, received by rail - 2,500tph & cement clinker - receive hopper or self-unloading ships up to 2,000tph.  
 Clinker Wharf: cement clinker - receive hopper with travelling grab crane bucket, discharge up to 400tph.  
 Incitec Pivots North: bulk cargoes - loaded into three 50t hoppers using ship or mobile cranes.  
 Pinkenba Bulk Terminal: Mobile gantry loader, load up to 1,200tph. Two import hoppers each 300tph. Direct to truck, silo, shed.  
 Incitec Pivots South: bulk dry cargoes - fixed gantry ship loader, load 200tph.  
 Sugar Terminal: sugar - mobile gantry loader, load 1,500tph.  
**Bulk Berths:** Fisherman Islands Grain: length 285m, draught 13m  
 Fisherman Islands Coal: length 317m, draught 13.5m  
 General Purpose: length 213m, draught 11.5m  
 Cement Australia: length 220m, draught 9.7m  
 Incitec Pivots North: length 210m, draught 10m  
 Pinkenba Bulk Terminal: length 360m, draught 10.4m  
**Total Uncovered Storage:** Fisherman Islands Coal - stockpile storage 900,000t  
 Fisherman Islands Grain Pads - 100,000t  
 Pinkenba Bulk Terminal - open area 25,000t  
**Total Covered Storage:** Fisherman Islands Grain: silo storage 60,000t, sugar/cottonseed shed 40,000t  
 Clinker Wharf: storage sheds 30,000t, 82,000t, 5,000t.  
 Incitec Pivots North: storage 50,000t.  
 Pinkenba Bulk Terminal: 80,000t, silo 62,000t, open area 25,000t  
 Fisherman Islands Grain: wharf use - grain, woodchips, sugar, cottonseed exports.  
 Fisherman Islands Coal/Clinker wharf: wharf use - steaming coal exports. Used to discharge - bulk clinker, gypsum, slag imports.

**PORTLAND**  
**Port of Portland Pty Ltd**  
 PO Box 292  
 23-25 Kunara Crescent  
 Portland  
 VIC 3305  
 Australia  
**Contact:** Mr Malcolm Geier, Business Development Manager  
 T: + 61 355 250900  
 F: + 61 355 217488

**THEVENARD**  
**Thevenard Port**  
 Ports Corp South Australia  
 Thevenard Road  
 Thevenard  
 SA  
 5690  
 Australia  
**Contact:** Mr Peter Codrington, Operations Manager  
 T: + 61 8 8625 2617  
 F: + 61 8 8625 3100  
 E: flindersports@flindersports.com.au  
**Location:** Far north-west coast of the Eyre Peninsula  
 Latitude 32 degrees - 09 minutes south  
 Longitude 133 degrees - 39 minutes east  
**Equipment & Capacity:** Thevenard jetty, serving both sides. Travelling gantry loader with retractable boom and spout attached. Gross loading rates - wheat 550/750tph, barley 550 tph, oats 500 tph, gypsum 1050 tph.  
**Bulk Berths:** Privately owned Viferra, Thevenard jetty, serving both sides. Travelling gantry loader with retractable boom and spout attached.  
 Thevenard is 793km west of Adelaide and 3km from the centre of Ceduna.

**TOOWOOMBA**  
**Grainco Queensland**  
**Fisherman Island Terminal**  
 PO Box 136  
 Toowoomba  
 Queensland  
 4350  
 Australia  
**Contact:** Mr Leon MaGuire, General Manager  
 T: + 61 7 4632 9122  
 F: + 61 7 389 51034  
 E: enquiries@graincorp.com.au

## TOWNSVILLE

**Port of Townsville Limited**  
 PO Box 1031  
 Townsville  
 Queensland  
 4810  
 Australia  
**Contact:** Mr Barry Holden, CEO  
 T: + 61 7 4781 1512  
 F: + 61 7 4781 1525  
 E: info@townsville-port.com.au  
 W: www.townsville-port.com.au  
**Location:** (19 deg. 5'30"S. 146 deg. 52"E)  
 Port of Townsville is a breakwater harbour situated on the Queensland coast in Cleveland Bay.  
**Equipment & Capacity:** Individual stevedoring companies have an extensive range of mobile cargo handling equipment including forklifts, tractors, trailers (container),

loaders and earth-moving equipment.  
**Bulk Berths:** Berth 1 is a dedicated bulk liquids wharf used exclusively by tankers for bulk oil, gas and sulphuric acid discharge and by all types of vessels for bunkering.  
 Berth 2 is used for unloading nickel ore, two gantry cranes can be equipped to unload ore from the vessel into hoppers to feed a conveyor system, which carries the ore into the load out site. The berth is leased to Xstrata who have licensed its use to Queensland Nickel.  
 Berth 3 is leased to Xstrata, and is operated and controlled by Northern Stevedoring Services Pty Ltd. Typical cargoes handled over this wharf include: lead ingots, refined copper, nickel and zinc. Also used for containerised cargo, fertiliser imports and live cattle exports.  
 Berth 4 has a priority berthing arrangement with Cement Australia handling bulk cement imported from Gladstone. The berth also handles molasses, mineral products, and general cargo. The molasses pipeline to this berth is capable of loading up to 400tph.  
 Berth 7 is leased to Xstrata and supports a bulk shiploader for mineral concentrates and ores at the rate of 1,000tph, and fertiliser at 1,200tph. Mineral concentrates mined in northwest Queensland are exported over this wharf.  
 Berth 8 is a general purpose berth handling molasses, fertiliser, refined mineral products, sulphur and general cargo.  
 Berth 9 has a priority berthing arrangement with Queensland Sugar, and is Australia's largest point of export of sugar. A bulk shiploader delivers sugar to carriers at the rate of 2,000tph. The berth is equipped with bulk molasses and bunker pipelines.  
 Berth 10 is a general purpose berth and is to be extended to accommodate cruise and military vessels.  
 Berth 11 is known as the Outer Berth Mineral Concentrates Loading Facility. Lead and zinc concentrates are placed onto a conveyor system by front-end loader and transported to the 1,350tph shiploader. The facility is owned by BHP Billiton Cannington.  
**Total Uncovered Storage:** Open storage space for Crude Load, Refined Copper, Zinc and other cargoes.  
**Total Covered Storage:** Raw Sugar: Two storage sheds of 285,000t total capacity, located adjacent to Berth 9.  
 A third storage shed of 420,000t storage capacity opened for business in late 2003.  
 Molasses: Four bulk storage tanks of 60,000t total capacity located adjacent to Berth 4.  
 Caustic Soda: One 5,000t storage tank, located adjacent to No. 4 wharf.  
 Concentrates: 170,000t covered storage area, located adjacent to No. 7 wharf (MIM).  
 40,000t covered storage area located in the Northern Balloon Loop (BHP).  
 Cement: One 30,000t bulk cement storage silo, located in the Eastern Port Development Area.  
 Chemicals: Two sulphuric acid storage tanks of 17,000t total capacity (1x5,000t, 1x12,000t capacity), located in the Eastern Port Development Area.  
 Fertilizer: One 90,000t covered storage shed, located in the Eastern Port Development Area.

**WALSH BAY**  
**Sydney Ports Corporation**  
 Level 4, 20 Windmill Street  
 Walsh Bay  
 NSW 2000  
 Australia  
**Contact:** Mr Philip Holiday, Business Development  
 T: + 61 2 9296 4999  
 F: + 61 2 9296 4742  
 E: enquiries@sydports.com.au  
 W: www.sydneysports.com.au

**WEST PERTH**  
**Co-Operative Bulk Handling Ltd**  
 Gayfer House  
 30 Delhi Street  
 West Perth  
 WA  
 6005  
 Australia  
**Contact:** Ms Nikki Wilson-Smith, Digital Marketing & Media Advisor  
 T: + 61 8 9327 9600  
 F: + 61 8 9322 3942  
 E: info@cqbh.com.au  
 W: www.cbh.com.au

**WOLLONGONG**  
**Port Kembla Coal Terminal Limited**  
 Port Kembla Road  
 Wollongong  
 New South Wales  
 NSW 2520  
 Australia  
**Contact:** Mr Peter Green, General Manager  
 T: + 61 2 4228 0288  
 F: + 61 2 4228 7605  
 E: peter.green@pkct.com.au  
 W: www.pkct.com.au  
**Location:** Located in the southern major port of New South Wales in Australia.  
 (72 k south of Sydney)  
**Equipment & Capacity:** COAL FACILITY Rail dump station, road dump station, receive conveyors capacity 4400tph, 3 Stackers, stockyard, 2 Reclaimers, shiploading conveyors capacity 6600tph, 2 Shiploaders  
 BULK PRODUCTS FACILITY road dump station, screening plant ,conveyor system 1000tph, 1shiploader, unload conveyor for self discharging ships  
**Bulk Berths:** Coal Berth length 250m, 16.25m alongside  
 Bulk Products berth 215m, 11.6m depth alongside  
 Approach channel 15.25m plus tide  
**Total Uncovered Storage:** Coal stockyard 850,000sqm  
 Bulk Products stockyard 250,000sqm  
**Total Covered Storage:** None  
 Port Kembla Coal Terminal serves the Southern and Western coalfields of New South Wales Australia and has an annual capacity modelled at some 18 million tonnes.

**WOLLONGONG**  
**Port Kembla Grain Terminal**  
 GrainCorp Operations Limited  
 PO Box 1029  
 Wollongong  
 NSW  
 2500  
 Australia  
**Contact:** Mr Mark Jelbart, Manager

Sulphur: One 10,000t covered storage shed, located in the Eastern Port Development Area.  
 Port of Townsville is a gateway to global trade and investment and the nexus of Australia's booming North Queensland region.  
 Port of Townsville Limited is a statutory Government owned corporation.

**WYNDHAM**  
**CGL Wyndham Port**  
 PO Box 186  
 1 Wharf Road  
 Wyndham  
 Western Australia  
 WA 6740  
 Australia  
**Contact:** Mr Steve Forrest, Wharf Manager  
 T: + 61 891 611 203  
 F: + 61 891 611 244  
 E: gill@cgltd.com.au  
 W: www.cgltd.com.au  
**Location:** Far North, Kimberley Region, Western Australia  
 Contact us for more information.

**WYNNUM CENTRAL**  
**Patrick Stevedores**  
 PO Box 734  
 Wynnum Central  
 QLD 4178  
 Australia  
**Contact:** Mr Matt Hollamby, Queensland Manager  
 T: + 61 7 3893 8555  
 F: + 61 7 3895 1534  
 E: m.hollamby@patrick.com.au  
 W: www.patrick.com.au

**BAHAMAS**

**FREEPORT**  
**Grand Bahama Port Authority**  
 PO Box 42666  
 Freeport  
 33114  
 Bahamas  
**Contact:** Mr Felix N Stubbs, Chairman  
 T: + 1242 352-6611  
 F: + 1242 352-6184  
 E: fstubbs@gbpa.com  
 W: www.gbpa.com

**BAHRAIN**

**MANAMA**  
**Mina Salman Port Authority**  
 Customs and Ports Authority  
 PO Box 15  
 Manama  
 Bahrain  
**Contact:** Mr J S Kendrick,  
 T: + 973 1772 5555  
 F: + 973 1772 5534  
 W: www.bahrainport.gov.com

**BANGLADESH**

**CHITTAGONG**  
**Chittagong Port Authority**  
 PO Box 2013  
 Bandar Bhaban  
 Chittagong  
 4100  
 Bangladesh  
**Contact:** Mr Zulfrigar Ali, Commodore  
 T: + 880 31 7419 8090  
 F: + 880 31 710593  
 E: cmancpa@globalctg.net  
 W: www.cpabd.com

**BARBADOS**

**BRIDGETOWN**  
**Barbados Port Authority**  
 University Row  
 Princess Alice Highway  
 Bridgetown  
 Barbados



**Contact:** Mr Richard Alleyne,  
Harbour Master  
T: + 1 246 430 4700  
F: + 1 246 429 5348  
E: administrator@barbadosport.com  
W: www.barbadosport.com

**BELGIUM**

**ANTWERP**

**Alfaport Antwerpen**  
Brouwersvliet 33  
Post Bus 8  
Antwerp  
B-2000  
Belgium  
**Contact:** Mr Rudi de Meyer,  
Managing Director  
T: + 32 3 206 7381  
F: + 32 3 231 6728  
E: info@alfaportantwerpen.be  
W: www.alfaportantwerpen.be

**ANTWERP**

**Antwerp Bulk Terminal (ABT)**  
Haven 750, Delwaidedok  
Nieuwe Westweg 14  
Antwerp  
B-2040  
Belgium  
**Contact:** Mr Michel Moons,  
Manager ABT  
T: + 32 9 255 02 51  
F: + 32 9 259 08 94  
E: michel.moons@sea-invest.be  
W: www.sea-invest.com  
**Location:** Port of Antwerp  
**Equipment & Capacity:** 2 x 50t gantry  
1x 25t gantry  
3 x 40t mobile  
1 x 50t mobile  
2 x 40t mobile  
**Bulk Berths:** Antwerp:  
Delwaidedok, Leopolddok,  
Amerikadok, 6de Havendok  
**Total Uncovered Storage:** 110 ha  
**Total Covered Storage:** 130,000sqm

**ANTWERP**

**Antwerp Port Authority**  
Havenhuis  
Zaha Hadidplein 1  
Antwerp  
B-2030  
Belgium  
**Contact:** Mr Xavier van Rolleghe,  
Business Development Manager  
T: + 32 3 205 2051  
F: + 32 3 205 2269  
E: xavier.vanrolleghe@haven.antwerpen.be  
W: www.portofantwerp.com  
**Location:** Antwerp is located in Northwest Europe. It is the second largest city in Belgium.  
**Equipment & Capacity:** 146 Electric shore cranes (from 2-5t lift to 51-100t), 37 ship loading installations, 3 floating cranes and derricks, 9 gantries for bulk goods (5t, 35t, 50t), 14 grain elevators, 78 mobile cranes.  
**Bulk Berths:** The major bulk terminals have a total quay length of 3.8 km, of which 1,800 m cape size and 2.2 km panamax. In case of simultaneous arrivals it is possible to divert capesize or panamax vessels to different terminals in order to avoid delays.  
**Total Covered Storage:** 4.800.000 sqm  
We have specialised terminals for all kind of goods.

**ANTWERP**

**Boortmalt Group**  
Zantvoort 2  
Haven 350  
Antwerp

B-2030  
Belgium  
**Contact:** Mr Yvan Schaeppman,  
CEO  
T: + 32 3 545 0411  
F: + 32 3 542 0582  
E: info@boortmalt.com  
W: www.boortmalt.com

**ANTWERP**

**Euroports Belgium NV**  
Atlantic House - 3rd floor  
Noorderlaan 147  
Antwerp  
2030  
Belgium  
**Contact:** Mr Wim Leuyckx,  
Commercial Director  
T: + 32 3 204 9300  
T: + 32 3 204 9301  
F: + 32 3 204 93 01  
E: info@euroports.com  
W: www.manuportgroup.com

**ANTWERP**

**Havenbedrijf Antwerpen NV van publiek recht**  
Havenhuis  
Zaha Hadidplein 1  
Antwerp  
B-2030  
Belgium  
**Contact:** Mr Amout Hurkmans,  
Head of Department -  
Documentation Centre  
T: + 32 3 205 20 11  
E: info@portofantwerp.com  
W: www.portofantwerp.com  
**Location:** Hamburg - Le Havre range  
**Equipment & Capacity:** Includes 15 shiploaders, 5 loading bridges for bulk cargo and 90 mobile cranes.  
**Bulk Berths:** Useful berthing length: 169m  
**Total Covered Storage:** 610 ha  
Easy access by inland waterways, road, rail and pipeline

**ANTWERP**

**Manuport Logistics NV**  
Vosseschijnstraat 59, Haven 182  
Antwerp  
2030  
Belgium  
**Contact:** Ms. Luce Proost, Office  
Secretary/Marketing  
T: + 32 3 204 9500  
E: info@manuport-logistics.be  
W: http://manuport.be/site/

**ANTWERP**

**SCR - Sibelco**  
Quellinstraat 49  
Antwerp  
BE - 2018  
Belgium  
**Contact:** Ms. Laurence Boens,  
T: + 32 3 2236658  
E: info@sibelco.com  
W: www.sibelco.be

**BRASSCHAAT**

**United Bulk Terminals**  
Onderheide 43  
Brasschaat  
Belgium  
**Contact:** Mr Ludo De Nijs, Senior  
Strategic Advisor  
T: + 32 3651 0130  
F: + 32 652 1109  
E: ludo.de.nijs@unitedbulkterminals.com

**BRUGGE**

**Firma Germain D'Hoore - Ostende**  
Vaardijkstraat 76  
Brugge  
8200  
Belgium  
**Contact:** Mr H D'Hoore, Managing  
Director  
T: + 32 50 384 506

F: + 32 50 384 851

**GHENT**

**Arcelor Steel Belgium NV**  
Arcelor Gent  
John Kennedylaan 51  
Gent  
9042  
Belgium  
**Contact:** Mr Koen De Coster,  
Maintenance manager railway and  
locomotives  
T: + 32 9347 2670  
F: + 32 9347 4916  
E: gen-iec-communicatie@arcelormittal.com  
W: www.sidmar.be

**GHENT**

**Ensagent NV**  
Skaldenstraat 1  
Gent  
9042  
Belgium  
**Contact:** Mr Tom Zirrick, Planning  
Manager  
T: + 32 9 255 02 11  
F: + 32 9 259 08 93  
E: info@sea-invest.be  
W: www.sea-invest.com/

**GHENT**

**Euro-Silo NV**  
Zeehaven-Oost  
Alphonse Sifferdok  
J F Kennedylaan 19  
Gent  
B9000  
Belgium  
**Contact:** Mr Daniel Matthys,  
Managing Director  
T: + 32 9 345 96 11  
F: + 32 9 251 6074  
E: daniel.matthys@euro-silo.be  
W: www.euro-silo.com

**GHENT**

**Ghent Coal Terminal NV - GCT**  
Skaldenstraat 1  
Gent  
9042  
Belgium  
**Contact:** Mr Bart Laureys,  
T: + 32 9 255 02 11  
F: + 32 9 259 08 94  
E: Bart.Laureys@sea-invest.be  
W: www.sea-invest.com  
**Location:** Alongside the sea canal in the Port of Ghent at berth 2320.  
**Equipment & Capacity:** 2'25 metric tons cranes + 1 ship's belt loader.  
**Bulk Berths:** Draught 12.5m (FW)  
**Total Uncovered Storage:** About 70,000 m<sup>2</sup>  
**Total Covered Storage:** About 40,000 m<sup>2</sup>  
GCT is the biggest solid fuel terminal in Belgium with open air and covered storage facilities, equipped with several screening, crushing, blending and drying installations.

**GHENT**

**Ghent Port Company amp**  
John Kennedylaan 32  
Gent  
B-9042  
Belgium  
**Contact:** Mr Johan Bresseleers,  
Communications Manager  
T: + 32 9 251 0550  
F: + 32 9 251 5406  
E: johan.bresseleers@portofghent.be  
W: www.portofghent.be  
**Location:** West Europe  
**Equipment & Capacity:** No own port cranes - cranes belong to private port companies  
Ghent is a modern and versatile medium-sized port situated in the centre of the Hamburg/Le Havre

range, having an average water-borne cargo traffic of some 48 million tons, 27.3 of which are transported overseas and 20.7 million tons by inland waterway.

**GHENT**

**Ghent Transport & Storage**  
Farmanstraat 41  
Middendok-Noordkaai 0610-0620  
Gent  
9000  
Belgium  
**Contact:** Mr Yves Bienfet, General  
Manager/Director  
T: + 32 9 250 5658  
F: + 32 9 251 10 52  
E: y.bienfet@gtsggent.be  
W: www.gtsggent.be  
**Location:** Middendok terminals  
0600-0620  
Kluizendok terminals 7110 -7140  
**Equipment & Capacity:** 2 cranes :  
Liebherr, Sennebogen full panamax  
**Bulk Berths:** Water Depth: 13m  
Quay length: 8m  
Middendok terminal quay 0600-0620: 300m  
Kluizendok terminals quay 7110-7140: 500m quays  
**Total Uncovered Storage:** 20,000sqm  
**Total Covered Storage:** 67,000sqm

**GHENT**

**Mekol**  
Henri Farmanstraat 47  
Gent  
East Flanders  
9000  
Belgium  
**Contact:** Mr Edvin Gogol, Director  
T: + 32 9 251 08 12  
F: + 32 9 251 76 41  
E: edvin.gogol@rheinbraun-benelux.be

**GHENT**

**Reyniers Havenbedrijf NV**  
Stapelplein 38  
Gent  
9000  
Belgium  
**Contact:** Ms Jo van der Herten,  
Marketing & Communications  
T: + 32 32 04 95 00  
F: + 32 32 04 93 01  
E: j.vanderherten@euroports.com  
W: www.manuportgroup.com

**GHENT**

**Stukwerkers Havenbedrijf NV**  
Port Arthurlaan 40  
Gent  
B - 9000  
Belgium  
**Contact:** Mr Johan De Raeve,  
Managing Director  
T: + 32 9 251 25 45  
F: + 32 9 251 61 81  
E: johan.deraeve@stukwerkers.com  
W: www.stukwerkers.com  
**Location:** Port of Ghent/Belgium  
**Equipment & Capacity:** 7 mobile  
harbour cranes up to 144 tonnes  
capacity  
Mobile conveyor belts up to 1.000  
tonnes / hour  
Mobile weighing equipment  
**Bulk Berths:** Sifferdock 830 - 840  
Sifferdock 1,000  
Grootdok 290 - 360  
Total quay length 3.5 km  
**Total Uncovered Storage:** 505,000sqm  
**Total Covered Storage:** 95,000sqm

**KALLO**

**Belgian Scrap Terminal NV**  
Land van Waaslaan 4  
Haven 1201  
Kallo  
9120  
Belgium

**Contact:** Ms Sofie Van Peteghem,  
T: +32 3575 0575  
F: +32 3575 1370  
E: info@belgienscrap.com  
W: www.belgienscrapterminal.com/  
**Location:** Port of Antwerp  
Handles Ferro and Non-Ferro Scrap

**KALLO**

**Metal Terminals International (MTI)**  
Hazopweg 6  
Kaai 1219  
Kallo  
B-9130  
Belgium  
**Contact:** Mr Fritz Lippens, General  
Manager  
T: + 32 3570 9670  
F: + 32 3570 9671  
E: planning@mtiterminals.com  
W: www.mtiterminals.com  
**Location:** Port of Antwerp - Left  
Bank  
**Equipment & Capacity:** 4 x mobile  
crane 100 mt SWL  
**Bulk Berths:** 2km berth. Draught  
12.5m  
**Total Uncovered Storage:** 250,000sqm  
**Total Covered Storage:** 56,000sqm  
LME-accredited. Forwarding &  
distribution services.

**LIEGE**

**Liege Port Authority**  
Quai de Maestricht 14  
Liege  
4000  
Belgium  
**Contact:** Mr Emile-Louis Bertrand,  
Managing Director  
T: + 32 42 32 97 97  
F: + 32 4 223 11 09  
E: portdeliege@skynet.be  
W: www.portdeliege.be  
**Location:** Accessible via river  
Scheidt and Albert Canal (only at  
14h navigation from Port of  
Antwerp)  
**Equipment & Capacity:** 102  
cranes, max. 50t  
**Bulk Berths:** 26km  
**Total Uncovered Storage:** 366  
hectares  
**Total Covered Storage:** 150,000sqm

**LIEGE**

**Terval S.A.**  
Ile Monsin, Route 10  
Liege  
B-4020  
Belgium  
**Contact:** Mr Dirk Schmidt-  
Holzmann, Administrator  
T: + 32 4256 9340  
F: + 32 4264 0835  
E: dsh@terval.com  
W: www.terval.com

**OOSTENDE**

**Ter Polder**  
Zwaaidok 2  
Oostende  
B-8400  
Belgium  
**Contact:** Mr Steven Verhelst,  
Shipping Manager  
T: + 32 59 331 133  
F: + 32 59 331 433  
E: steven.verhelst@verhelst.be  
W: www.verhelstlogistics.be  
**Location:** Ostend, Belgium  
**Equipment & Capacity:** Cranes up  
to 250t  
**Bulk Berths:** Length 120m/ Draught  
6.8m  
**Total Uncovered Storage:** 30,500sqm  
**Total Covered Storage:** 38,000sqm

**PUURS**

**SMEG Belgium NV**  
Schoonmansveld 12  
Puurs  
2870  
Belgium  
**Contact:** Mr Guy Rooms, Marketing  
T: +32 03 860 96 96  
F: + 32 03 866 0666  
E: ann.de.smedt@smeg.be  
W: www.smeg.com

**ROESELARE**

**Van Eeckhout Vervoermaatschappij**  
Trakelweg 60  
Roeselare  
8800  
Belgium  
**Contact:** Mr Francis Eeckhout, Port  
Director  
T: + 32 51 207313  
F: + 32 51 241310  
E: francis@vmmcem.be

**SERAING**

**CTB Logistics SA**  
Rue du Pont du Val  
Seraing  
B-4100  
Belgium  
**Contact:** Mrs Muriel Baugnee,  
Marketing  
T: + 32 4240 7802 / +32 424 7814  
F: + 32 4337 1008  
E: muriel.baugnee@euroports.com  
W: www.ctblogistics.com  
**Location:** Belgium - Liepe,  
Charleroi  
**Equipment & Capacity:** 9 cranes  
**Total Uncovered Storage:** 200,000sqm  
**Total Covered Storage:** 95,000sqm

**ZEEBRUGGE**

**Devreese & Simon NV**  
Lanceloot Blondellaan 1  
Zeebrugge  
8380  
Belgium  
**Contact:** General Manager  
T: + 32 50 54 40 04  
F: + 32 50 54 43 21

**ZEEBRUGGE**

**Zeebrugge Behandelings Maatschappij**  
Skaldenstraat 1  
Zeebrugge  
Gent  
9042  
Belgium  
**Contact:** Mr Philippe Van de  
Vyvere, Manager  
T: + 32 50 544 095  
F: + 32 50 546 601

**BENIN**

**COTONOU**

**Port Autonome de Cotonou**  
PO Box 927  
Cotonou  
Benin  
**Contact:** Ms Issa Badarou, General  
Manager  
T: + 229 21 312890 / 21 31 52 80  
F: + 229 312891  
E: pac@leland.bj  
W: www.portdecotonou.com

**BERMUDA**

**HAMILTON**

**Department Marine & Port Services**  
PO Box HM 180  
Hamilton  
HM AX  
Bermuda  
**Contact:** Mr David Simmons,

Harbour Master  
T: + 1 441 295 6575  
F: + 1 441 295 5523  
E: dcsimmons@gov.br

## BRAZIL

### ANCHIETA

**Port Authority of Ponta Uba**  
Rodovia do Sol s/n  
Anchieta  
ES 29230-000  
Brazil  
**Contact:** Mr E Drummond, Manager  
T: + 55 27 3361 9000  
F: + 55 27 3361 9474  
E: portodeubu@samarco.com.br  
W: www.portodeubu.com.br

### ANGRA DOS REIS

**Port of Angra dos Reis**  
Avenida dos Reis Magos, s/n  
Angra dos Reis  
Rio de Janeiro  
RJ 23900-000  
Brazil  
**Contact:** Mr Fernando Mauricio de Lima Cavalcanti, Manager  
T: + 55 24 2365 0273  
F: + 55 24 2365 0273  
W: www.portosrio.gov.br

### ARACRUZ

**Portocel-Terminal Especializado de Barra do Riacho**  
Caminho da Barra do Riacho S/N  
Aracruz  
Barra do Riacho  
29197-900  
Brazil  
**Contact:** Mrs Patricia Dutra Lascosque, Director  
T: + 55 27 3270 4444  
F: + 55 27 3270 4433  
E: msc@portocel.com.br  
W: www.portocel.com.br  
**Location:** Barra do Riacho, North Coast of Espírito Santo state.  
**Bulk Berths:** Max draught 11.90m (With tide 1.60m high)  
Max length: 213.99m  
Max beam: 35m  
Max 50,000 dwt  
**Total Covered Storage:** - Armazém 1 = 13.500 m<sup>2</sup> - 51.485 T  
- Armazém 2 = 12.096 m<sup>2</sup> - 45.153 T  
- Armazém 3 = 14.352 m<sup>2</sup> - 55.072 T  
- Armazém 6 = 16.848 m<sup>2</sup> - 71.842 T  
Portocel is the only port in Brazil which is specialized in the handling of forest products (woodpulp and logs). It belongs to two of the biggest woodpulp producers in Brazil, Aracruz (51%) and Cenibra (49%).

### BAIA DE ARATU

**Port of Aratu**  
ADB Nordeste Terminal  
Companhia das Docas do Estado da Bahia (CODEBA)  
Via Matoim, s/n  
Baia de Aratu  
CEP 43.800-000  
Brazil  
**Contact:** Dr Osvaldo C Magalhaes,  
T: + 55 71 602 5711  
F: + 55 71 602 5705  
E: portoaratu@codeba.com.br  
W: www.codeba.com.br

### BELEM

**Port Authority of Para**  
Avenida Presidente Vargas  
41-2 Andar  
Belem  
CEP  
66010-000  
Brazil  
**Contact:** Mr Carlos Acatuassu Nunes, Director-President  
T: + 55 91 3182 9000

F: + 55 91 241 1741  
E: nunes@cdp.com.br  
W: www.cdp.com.br

### BELEM

**Port of Belem**  
Companhia Docas do Para - Autoridade Portuaria  
Endereco Av. Marechal Hermes s/n  
Cais do Porto  
Belem  
Para  
CEP 66010-000  
Brazil  
T: + 55 91 3216 2129  
F: + 55 91 3216 2130  
W: www.cdp.com.br

### FORTALEZA

**Port of Fortaleza**  
Praça Amigos da Marinha  
Esplanada do Mucuripe  
Fortaleza  
CE  
60 000  
Brazil  
**Contact:** Mr Livio Silva de France, Director  
T: + 55 85 263 2267  
F: + 55 85 266 5241  
E: docasdoceara@docasdoceara.com.br  
W: www.docasdoceara.com.br

### ILHEUS

**Port of Ilheus**  
Companhia das Docas do Estado da Bahia (CODEBA)  
Rua Rotary, s/n  
Cidade Nova  
Ilheus  
Bahia  
CEP 45.650-000  
Brazil  
**Contact:** Mr Ronaldo Lavinha, Port Manager  
T: + 55 73 231-1200  
F: + 55 73 231-3318  
E: portoilheus@codeba.com.br  
W: www.codeba.com.br

### IMBITUBA

**Imbituba Port Authority**  
Av Getulio Vargas  
No 100  
Imbituba  
Santa Catarina  
88780-000  
Brazil  
**Contact:** Mr G B da Costa Pereira, Port Manager  
T: + 55 48 3255 0080  
F: + 55 48 3255 0701  
E: docas@cdiport.com.br  
W: www.cdiport.com.br

### ITAGUAÍ

**CSN - Terminal de Carvão e Minério TECAR**  
Estrada da Ilha da Madeira  
s/no, Porto de Itaguaí  
Ilha de Madeira  
Itaguaí  
Rio de Janeiro  
23826-600  
Brazil  
**Contact:** Mr Guilherme Moretzsohn Andrade, Tecar Operations Manager  
T: + 55 21 2688 9338  
F: + 55 21 2688 9209  
E: guilherme.moretzsohn@csn.com.br  
W: www.csn.com.br/tecar

### JARAGUA

**Port of Maccio**  
Rua Sa de Albuquerque  
Jaragua  
Maccio  
Alagoa 57000  
Brazil  
**Contact:** Mr Dominico Silva, Administrator  
T: + 55 82 231 1999/1790

F: + 55 82 231 2975  
E: dominico@portodemaceio.com.br  
W: www.portodemaceio.com.br

### MANAUS

**Port of Manaus**  
Rua Marques de Santa Cruz,  
Centro  
Manaus  
Amazonas  
AM 69005 050  
Brazil  
**Contact:** Mr Nelson Pedro de Aguiar Falcao, Port Administrator  
T: + 55 92 2123 4350  
F: + 55 92 2123 4360  
E: alecom@portodemanaus.com.br  
W: www.portodemanaus.com.br

### MUNICÍPIO DE ORIXIMINÁ

**Trombetas Port**  
Mineração Rio de Norte - Porto Trombetas  
Município de Oriximiná  
Pará State  
68275-000  
Brazil  
**Contact:** Mr Ricardo Samento, Port Manager  
T: + 55 93 549 7029  
F: + 55 93 549 1482  
E: ricardos@mm.com.br  
W: www.mm.com.br  
**Location:** Lat. 01°27'36"S / Long. 56°22'47"W  
Situating on the right bank of Trombetas River, state of Para, north region of Brazil.  
**Equipment & Capacity:** One Shiploader  
Capacity - 6,000tph  
**Bulk Berths:** One Pier - 101m length  
Draught - 38 feet maximum  
**Total Uncovered Storage:** 36,000sqm  
**Total Covered Storage:** 8,000sqm  
Due to restrictions for navigation on Trombetas River bends, the vessels are limited for Panamax Size up to 260m LOA.

### NATAL

**Natal Port Authority**  
Avenida Hildebrando de Goes  
Ribeira  
Natal  
Rio Grande do Norte  
CEP 59000  
Brazil  
**Contact:** Mr Ivan Reis de Lima, Administrator  
T: + 55 84 211 5311  
F: + 55 84 221 6072  
E: codmkt@zaz.com.br  
W: www.codem.com.br

### NATAL

**Natal Port Authority**  
Avenida Hildebrando de Goes  
Ribeira  
Natal  
Rio Grande do Norte  
CEP 59000  
Brazil  
**Contact:** Mr Ivan Reis de Lima, Administrator  
T: + 55 84 211 5311  
F: + 55 84 221 6072  
E: codmkt@zaz.com.br  
W: www.codem.com.br

### NITEROI

**Port of Niteroi**  
Avenida Feliciano Sodre 215  
Niteroi  
RJ  
24030  
Brazil  
**Contact:** Mr Antonio Manne, Manager  
T: + 55 21 718 3182  
E: gemit@portosrio.gov.br  
W: www.portosrio.gov.br/niteroi/Nitpor.htm

### PARA STATE

**Port Authority of Vila do Conde**  
Companhia Docas do Port Vila do Conde  
Para State  
Brazil  
**Contact:** Mr Carlos Edir, Port Supervisor  
T: + 55 91 3754 1027  
F: + 55 91 3754 1026

E: edir@cdp.com.br

### PARANAGUA

**Paranagua Port Authority**  
Rua Antonio Pereira, 161  
Paranagua  
PR  
83221-030  
Brazil  
T: + 55 14 1420 1100  
F: + 55 14 1422 5324  
E: portos@pr.gov.br  
W: www.portosdoparana.pr.gov.br

### PARANAGUA

**PFT-Paraná Forestry Terminals**  
Rua Professor Cleto, 1372  
Leblon  
Paranagua  
Parana  
83203-070  
Brazil  
**Contact:** Mr Fernando Drevnovicz,  
T: + 55 41 3420 1900  
F: + 55 41 3420 1903  
E: pftcom@pft-terminals.com.br  
W: www.gearbulk.com

### PARANAGUA

**Port Silo/Socopar Berths 1/2; Gransol Berth 3**  
Administracao dos Ports de Paranagua e Antonnia (Port Authority)  
Centro Administrativo Taguare  
Paranagua  
Brazil  
**Contact:** Mr Osiris Stenghel Guimaraes, Port Superintendent  
T: + 55 41 420 1100  
F: + 55 41 422 5324  
E: portos@pr.gov.br  
W: www.portodeparanagua.pr.gov.br

### PELOTAS

**Port of Pelotas**  
Rua Conde de Porto Alegre 1  
Pelotas  
RS 96010-290  
Brazil  
**Contact:** Mr Jose Fernando Marques Ripoll, Harbour Manager  
T: + 55 53 278 7263  
F: + 55 53 278 7333  
E: portopel@sph.rs.gov.br  
W: www.portopelotas.rs.gov.br/

### PORTO ALEGRE

**Port of Porto Alegre**  
Administracao do Porto de Porto Alegre  
Av Maua 1050 Centro  
Porto Alegre  
RS 90010-110  
Brazil  
**Contact:** Mr Paulo Elzeu Ody, Port Administrator  
T: + 55 51 3211 5022  
F: + 55 51 3211 5033

### RECIFE

**Port of Recife**  
Praça Comunidade Luso Brasileira no 70  
Bairro do Recife  
Recife  
PE  
50030-280  
Brazil  
**Contact:** Mr Luiz Roberto Trindade Lobato, Port Director  
T: + 55 81 3419 1900  
F: + 55 81 3224 2848  
E: portodorecife@portodorecife.pe.gov.br  
W: www.portodorecife.pe.gov.br

### RIO DE JANEIRO

**Cia Docas Do Rio de Janeiro**  
Porto do Rio de Janeiro  
Av Rodrigues Alves No 20-40  
Rio de Janeiro

CEP  
20 080 000  
Brazil  
**Contact:** Mr Adacio CP Carvalho, Port Manager  
T: + 55 21 2219-8617 /00  
F: + 55 21 2219-8618  
E: asscom@portosrio.gov.br

### RIO DE JANEIRO

**Companhia Portuaria Baía de Sepetiba**  
Rua Rodrigo Silver 26  
São 201 Duplex Parte  
Rio de Janeiro  
CEP 2001  
Brazil  
**Contact:** Mr Gustavo L'Huillier,  
T: + 55 21 2688 1424  
F: + 55 21 2688 1287

### RIO DE JANEIRO

**Petroleo Brasileiro SA-Petrobras**  
Avenida Republica do Chile  
65 Centro  
Rio de Janeiro  
RJ  
20035  
Brazil  
**Contact:** Mr Luis Fernando Maya, Marketing Department  
T: + 55 21 3224 1510  
F: + 55 21 2262 3678  
W: www.petrobras.com.br

### RIO DE JANEIRO

**Port of Forno**  
Rua Santa Cruz No 100  
Arriai do Cabo  
Rio de Janeiro  
28930-000  
Brazil  
**Contact:** Mr Marcos Nau, Manager  
T: + 55 21 246 221185  
F: + 55 21 246 221185  
E: portodoforno@mar.com.br

### RIO DE JANEIRO

**Rio de Janeiro Port Authority**  
Rua Acre 21  
Rio de Janeiro  
20081  
Brazil  
**Contact:** Mr A R Menezes, President  
T: + 55 21 2219 9542  
E: suprio@portosrio.gov.br  
W: www.portosrio.gov.br

### RIO GRANDE

**Bianchini Terminal**  
Grain Terminal  
Avenida Almirante Maximian da Fonseca  
Sector 6 Industrial District  
Rio Grande  
RS  
96204-040  
Brazil  
**Contact:** Mr Carlos (CB) Bacchieri, Terminal Manager  
T: + 55 53 2126 6000  
F: + 55 53 2126 6011  
E: cb@bianchini-rg.com.br  
W: www.bianchinisa.com.br

### RIO GRANDE

**Port of Rio Grande**  
Avenida Honrio Bicalho s/n  
Edifício Deprec  
Rio Grande  
RS 96200  
Brazil  
**Contact:** Mr Newton Kuintas,  
T: + 55 53 3231 1366  
E: nquintas@portoriogrande.com.br  
W: www.portoriogrande.com.br

### SALVADOR

**Port Authority of Salvador**  
Companhia das Docas do Estado da Bahia

Av. da Franca, 155 I, Comercio Salvador  
Bahia  
CEP 40.010-000  
Brazil  
**Contact:** Port Director  
T: + 55 71 320 1299  
F: + 55 71 320 1268  
E: portosalvador@codeba.com.br  
W: www.codebra.com.br

### SANTOS

**Companhia Docas do Estado de São Paulo - CODESP**  
Avenida Conselheiro Rodrigues Alves, s/nº - Macuco  
Santos  
São Paulo  
CEP 11015-900  
Brazil  
**Contact:** Mr José Di Bella Filho, Director-President  
T: + 55 13 3222 5485  
F: + 55 13 3222 3068  
E: di\_bella@uol.com.br  
W: www.portodesantos.com.br  
**Location:** Southeast coast of Brazil in the State of São Paulo  
**Equipment & Capacity:** The Santos Port static capacity is 110 million tonnes. For dry bulk operation state of art equipment is available to handle products in export and import hands. The total static capacity for dry bulk operation in the Organized Port is 43,9 million tonnes.  
**Bulk Berths:** 58 berths including 14 specialized berths for dry bulk.  
**Total Uncovered Storage:** 500,000sqm  
**Total Covered Storage:** 1,000,000sqm  
The port operated in 2006 a total of US\$ (FOB) 60,6 billion in cargo value.

### SANTOS

**Port of Santos**  
Companhia Docas do Estado de Sao Paulo  
Avenida Rodrigues Alves s/n  
Santos  
Sao Paulo 11015-900  
Brazil  
**Contact:** Mr Sergio Aquino, Port Operator  
T: + 55 133 202 6565  
F: + 55 133 233 3080  
E: seaport@santos.sp.gov.br  
W: www.portodesantos.com

### SAO FRANCISCO DO SUL

**Sao Francisco do Sul Port Authority**  
Ave Eugenheiro  
Leite  
Ribeiro  
Sao Francisco do Sul  
782  
Brazil  
**Contact:** Mr Ulisses Tavares Lopes, Commercial Manager  
T: + 55 47 34 71 12 00  
F: + 55 47 34 71 12 11  
E: porto@apsfs.sc.gov.br  
W: www.apsfs.sc.gov.br

### SÃO LUIS

**Port of Ponta da Madeira**  
Avenida dos Portugueses s/n  
Praia do Boqueirao  
Sao Luis  
Maranhao  
65085 580  
Brazil  
**Contact:** Mr Alvaro de Oliveira Jnr, Port Superintendent  
T: + 55 98 218 4263  
F: + 55 98 218 4019

### SÃO PAULO

**Coimbra - Grain**  
Avenida Brigadeiro Faria Lima,



1355  
14° Andar  
Pinheiros CEP  
Sao Paulo  
01451 903  
Brazil  
**Contact:** Ms. Marcia Amorim,  
Marketing  
T: + 55 11 3039 6700  
F: + 55 11 3814 3235  
W: www.louisdreyfus.com

**VITORIA**

**Capuba Quay Grain Terminal/Port of Vitoria**  
Ave Getulio Vargas 556  
Centro  
Vitoria  
ES 29020  
Brazil  
**Contact:** Mr Dirceu Cardoso, Port Director  
T: + 55 272 221 311  
F: + 55 272 227 360  
E: falaporto@codesa.gov.br  
W: www.portodevitoria.com.br

**VITORIA**

**Port Authority of Espirito Santo**  
Avenida Getulio Vargas No 556  
Vitoria  
Espirito Santo  
29000  
Brazil  
**Contact:** Mr Jose Luiz Canjelo de Franca, Marketing  
T: + 55 27 2132 7342  
F: + 55 27 3132 7343  
E: comark@codesa.gov.br  
W: www.portodevitoria.com.br

**VITORIA**

**Tubarao Port Authority**  
c/o Companhia Vale do Rio Doce  
Porto de Tubarao  
Vitoria  
Espirito Santo  
Brazil  
**Contact:** Port Manager  
T: + 55 273 35 5624  
F: + 55 273 35 5293  
E: info@cprd.com.br  
W: www.cprd.com.br

**BULGARIA**

**BOURGAS**

**Bulk Terminal 2A**  
Port of Bourgas JSC  
1 Al. Battenberg Str.  
Bourgass  
8000  
Bulgaria  
**Contact:** Mr Dimitar Terziev,  
Manager  
T: + 359 56 822 400  
F: + 359 56 822 156  
E: headoffice@port-burgas.com  
W: www.port-burgas.com

**BOURGAS**

**Port of Bourgas JSC**  
1, Prince Alexander Battenberg Street  
Bourgass  
8000  
Bulgaria  
**Contact:** Mr Stoycho Dimov, Chief FR, Marketing, QA Dpt  
T: + 359 56 822 345  
F: + 359 56 822 156  
E: st\_dimov@port-burgas.com  
W: www.port-burgas.com  
**Location:** South East of Bulgaria on Black Sea Coast  
**Equipment & Capacity:** Bulk Cargoes terminal / capacity - 6 million tons.  
Siwertell Screw Unloader - 1  
Cheretti Tanfani Grab Gantry unloader - 1  
Forklift Trucks - 3

Front Loaders - 10  
Telescopic Hold Cleaners - 2  
Conveyor Belts - 9  
Bulk Reclaimers - 3  
Bulk Stackers - 2  
Bulk Wagon Loading Station - 1  
Truck Scales - 2  
Terminal 2A  
Grab Gantry Unloaders, 1,200 th each - 2  
Conveyor Belts - 14  
Grab Gantry Unloaders - 1,200 th each - 2  
Small Size Front Loaders (hold work) - 4  
Wagon Weighing Bridge - 1  
Wagon Loading Station - 2 lines per 600 thour - 1  
Stacker/Reclaimer - 1  
Stackers - 2  
Reclaimer - 1  
Capacity 6 million tons  
**Bulk Berths:** Mooring Berths 4  
Total Wharf Length 817 m  
Allowable Draught 15.50 m  
Open Storage 108,000 sqm  
Total area 268,000 sqm  
**Total Uncovered Storage:** 268,000sqm  
**Total Covered Storage:** 160,000sqm

**CAMBODIA**

**SIHANOUKVILLE**

**Sihanoukville Autonomous Port (PAS)**  
Vithei Phe  
Sihanoukville  
Preah Sihanouk Province  
Cambodia  
**Contact:** Mr Lou Kim Chhun,  
Director General  
T: + 855 34 933 416 / 34 933 511  
F: + 855 34 933 693 / 34 933 739  
E: admin@pas.gov.kh  
W: www.pas.gov.kh

**CAMEROON**

**DOUALA**

**Cameroon National Ports Authority**  
PO Box 4002  
Maritime Affairs Centre  
Douala  
Cameroon  
**Contact:** Mr Tchouta Moussa,  
General Manager  
T: + 237 342 0133  
F: + 237 426797  
E: onpc@camnet.cm

**DOUALA**

**Delmas Cameroon (CMA-CGM Group)**  
Cameroon National Ports Authority  
5 Boulevard Leclerc  
Douala BP 4020  
Cameroon  
**Contact:** Mr Markous Mono  
Mboum, General Port Manager  
T: +237 33 42 49 65  
F: + 237 3343 1300 / 2 8836  
E: dlo.cfandeu@african-agency.com  
W: www.cma-cgm.com

**CANADA**

**BAIE-COMEAU**

**Tessier Ltd**  
4 Lavallee Avenue  
Baie-Comeau  
Quebec Province  
G4Z 1L4  
Canada  
**Contact:** Mr Pierre Desgagnés,  
Managing Director  
T: + 1 418 296 2423  
F: + 1 418 296 3771  
E: info@tessier.desgagnes.com  
W: www.tessierlee.com  
**Location:** Province of Quebec (East Canada), near St-Lawrence river

**Equipment & Capacity:** Crane rental 8 to 350 T  
Field of expertise : Crane rental, Handling, Transportation, Mines, Heavy industrie, major construction projects.  
Certified system : ISO 9001-2015  
Teamwork with our head office.  
See other division : Boreal Cranes Inc. in Labrador, NL

**BECANCOUR**

**Becancour waterfront Industrial Park**  
1000 Boulevard Arthur-Sicard  
Industrial Park & Port  
Becancour  
Quebec  
G9H 2Z8  
Canada  
**Contact:** Mr François Marchand-Savoie, Harbour Master  
T: + 1 819 294 6656  
F: + 1 819 294 9020  
E: f.marchandsavoie@spipb.com  
W: www.spipb.com  
**Location:** South shore of the St. Lawrence River, halfway between Montreal and Quebec.  
**Equipment & Capacity:** Railway/ Scales/ Ro-Ro Ramp.  
**Bulk Berths:** Depth = 35ft.  
Berth 1 = 244m, Berth 2 = 150m,  
Berth 3 = 219m, Berth 4 = 214m,  
Berth 5 = 292m.  
**Total Uncovered Storage:** 100,000sqm  
Year-round access.  
Near Highways 30, 55, 40, 20.  
Connected to the North American road network.

**BELLEDUNE**

**Eastern Canada Stevedoring**  
Unit 2  
261 Shannon Drive  
Belledune  
New Brunswick  
E8G 2W1  
Canada  
T: + 1 506 522 1800  
F: + 1 506 522 1803  
E: info@qsl.com  
W: www.qsl.com/en/eastern.html  
**Location:** Port of Belledune: south shore of Baie des Chaleurs, Eastern Canada  
**Bulk Berths:** Port of Belledune: length 455m, draught 10.1m (East wharf); 11.3m (West wharf)  
Port of Sydney - Wharf 3: length 213m, draught 12.5m  
Port of Sydney - Wharf 4: length 218m, draught 12.5m  
**Total Uncovered Storage:** Port of Belledune: 270,000sqm  
Port of Sydney: 445,154sqm  
**Total Covered Storage:** Port of Belledune: 15,800sqm  
Accessible year-round

**BELLEDUNE**

**Port of Belledune**  
112 Shannon Drive  
Belledune  
New Brunswick  
E8G 2W2  
Canada  
**Contact:** Ms Jenna MacDonald,  
Director of Marketing  
T: + 1 506 522 1204  
F: + 1 506 522 0803  
E: macdonald@portofbelledune.ca  
W: www.portofbelledune.ca  
**Location:** NE Coast of New Brunswick on Chaleur Bay  
**Equipment & Capacity:** Mobile/Fixed Covered Conveyors & Hoppers +/- 1,200 to 1,800tph.; Rail Mounted Ship Load/Unloaders +/- 1,200 to 1,800tph.; Mobile Cranes +/- 50t to +/-165t; Front End Loaders & Forklifts (cap. varied).  
**Bulk Berths:** Term. # 1 = 155m X 15m X 10.4 m; Term. # 2 = 307m X

28m X 14.4m; Term. # 3 = 456m X 15m X 9.9m (West) to 11.2m (East); Term. # 4 Combination Ro-Ro/Barge; Ro-Ro Wharf = 184m X 31m X 9.0m; Ro-Ro Ramp = 19.2 m X 27.18 m; Barge Wharf = 122m X 31m X 7.0m;  
**Total Uncovered Storage:** +/- 6,000,000sqm  
**Total Covered Storage:** +/- 15,000sqm

**BURLINGTON**

**Lloyd's Register**  
3050 Harvester Road  
Suite 208  
Burlington  
Ontario  
L7N 3J1  
Canada  
**Contact:** Mr Lori Malone, Marketing  
T: + 1 281 675 3100  
E: barry.shepherd@lr.org

**CHURCHILL**

**Hudson Bay Port Terminal**  
PO Box 217  
Churchill  
Churchill  
Manitoba  
ROB OEO  
Canada  
**Contact:** Captain Irvin Sawatzky,  
Director, Marine Ops  
T: + 1 204 675 8823 ext. 206  
F: + 1 204 675 2550  
E: i.sawatzky@omnitrix.com

**CONTRECOEUR**

**Logistic**  
1920 Marie Victorin  
Contrecoeur  
Quebec  
JOL 1C0  
Canada  
**Contact:** Mr Philippe Desgagnés,  
Director of Operations  
T: + 1 450 587 2073  
F: + 1 450 587 8570  
E: pdesgagn@logistec.com  
W: www.logistec.com  
**Location:** St Lawrence River, East of Montreal  
**Equipment & Capacity:** Two gantry crane 34 MT  
**Bulk Berths:** Two berth  
**Total Uncovered Storage:** 45,000sqm  
**Total Covered Storage:** 3,500sqm

**CONTRECOEUR**

**Terminal Maritime Contrecoeur Inc**  
1920 Marie Victorin  
Contrecoeur  
Quebec  
JOL 1C0  
Canada  
**Contact:** Mr Norman Desjardins,  
General Manager  
T: + 1 450 587 2073  
F: + 1 450 587 8570  
E: ndesjard@logistec.com  
W: www.logistec.com  
**Location:** St. Lawrence River, Quebec, Canada  
**Equipment & Capacity:** 2 gantry cranes  
**Bulk Berths:** 228.9m

**CORNER BROOK**

**Corner Brook Port Corporation**  
R.A. Pollett Building  
61 Riverside Drive  
Corner Brook  
Newfoundland  
A2H 6T2  
Canada  
**Contact:** Ms Jacqueline Chow, Port Manager & CEO  
T: + 1 709 634 6600  
F: + 1 709 634 6620  
E: info@cornerbrookport.com

W: www.cornerbrookport.com/

**DARTMOUTH**

**Port Authority of Georgetown**  
Transport Canada  
PO Box 1013  
Dartmouth  
Nova Scotia  
B2Y 4K2  
Canada  
**Contact:** Mr W Chiasson, Harbour Manager  
T: + 1 902 426 2588  
F: + 1 902 426 6334  
E: DSchronce@SCSPA.com

**DELTA**

**Westshore Terminals**  
1 Roberts Bank  
Delta  
British Columbia  
V4M 4G5  
Canada  
**Contact:** Mr Glenn Dudar, Vice President and General Manager  
T: + 1 604 946 3494  
F: + 1 604 946 1388  
E: gdudar@westshore.com  
W: www.westshore.com  
**Location:** 30 km south of Vancouver, BC, Canada  
**Equipment & Capacity:** 4 Stacker/Reclaimers, 2 rotary railcar dumpers, 2 berths - rated capacity 29 million tpa  
**Total Uncovered Storage:** 2.0 million mt  
**Total Covered Storage:** None  
Currently North America's busiest coal export terminal. In the process of replacing the single rotary dumper with a double rotary and adding 3 new train indexers.  
Capacity 33 million tonnes upon completion in late 2012.

**GODERICH**

**Southpier Terminals Limited**  
230 Harbour Street  
Goderich  
Ontario  
N7A 3Y5  
Canada  
**Contact:** Mr Calvin Kerr, Manager  
T: + 1 519 524 7367  
F: + 1 519 524 7995  
E: ckerr@southpier.ca

**GUELPH**

**Parrish & Heimbecker**  
Suite 110  
150 Research Lane  
Guelph  
Ontario  
N1G 4T2  
Canada  
**Contact:** Mr Matt Gardner, Director Of Operations Eastern Canada  
T: + 1 519 780 4954  
E: mgardner@pandh.ca  
W: www.parrishandheimbecker.com  
**Location:** Great Lakes  
**Equipment & Capacity:** 1,000mtp handling  
**Bulk Berths:** 4 full berths at seaway depth  
**Total Uncovered Storage:** 2ha  
**Total Covered Storage:** 50,000mt grain capacity

**HALIFAX**

**Halifax Grain Elevator Ltd**  
951 South Bland Street  
Halifax  
Nova Scotia  
B3H 4S6  
Canada  
**Contact:** Mr Robert L White,  
Operations Manager  
T: + 1 902 421 1714 x 15  
F: + 1 902 420 0343  
E: rwhite@halifaxgrain.com

**HALIFAX**

**Halifax Port Corporation**  
PO Box 336  
Halifax  
Nova Scotia  
B3L 1K4  
Canada  
**Contact:** Mr George Malec, Vice President - Business Development & Operations  
T: + 1 902 426 2620  
E: ccarter@portofhalifax.ca  
W: www.portofhalifax.ca

**HAMILTON**

**Great Lakes Stevedoring Company Ltd**  
PO Box 57120  
Hamilton  
Ontario  
L8P 4W9  
Canada  
T: + 1 905 529 2355  
F: + 1 905 529 2356  
E: info@qsl.com  
W: www.qsl.com/en/gls.html  
**Location:** Port of Hamilton: western tip of Lake Ontario, Canada.  
Port of Port Colborne: Junction of the south western end of the Welland Canal and Lake Erie.  
**Bulk Berths:** Port of Hamilton: Wharf 26 - length 927m, draught 8.2m  
Port of Port Colborne: Wharf 16 - length 566m, draught 8.2m  
Port of Port Colborne: Wharf 17 - length 244m, draught 8.2m  
Port of Port Colborne: Wharf 18-2 - length 455m, draught 8.2m  
**Total Uncovered Storage:** Port of Port Colborne: 80,937sqm  
Accessible from late March to the end of December, during the opening of the St Lawrence Seaway System.

**HAMILTON**

**Hamilton Port Authority**  
605 James Street North  
Hamilton  
Ontario  
L8L 1K1  
Canada  
**Contact:** Mr Ian Hamilton, VP, Business Development  
T: + 1 905 525 4330  
F: + 1 905 528 6554  
E: ihamilton@hamiltonport.ca  
W: www.hamiltonport.ca  
**Location:** Western End of Lake Ontario  
43 17' North 79 50' West  
Hamilton is the largest Canadian Great Lakes Port serving the Southern Ontario region and surrounding area.

**HAMILTON**

**Richardson International Ltd**  
155 Eastport Blvd  
Hamilton  
Ontario  
L8H 7S3  
Canada  
**Contact:** Mr Riley Verhelst, Director of Operations  
T: + 1 905 314 7650  
F: + 1 905 545 8913  
E: Riley.Verhelst@richardson.ca  
W: www.richardson.ca  
**Location:** Pier 25 N Hamilton, Ontario, Canada

**JOHNSTOWN**

**Port of Johnstown**  
3035 County Road 2  
Johnstown  
Ontario  
KOE 1T1  
Canada  
**Contact:** Mr Robert Dalley, General Manager

T: + 1 613 925 4228  
 F: + 1 613 925 5022  
 E: rdalley@portojohnstown.com  
 W: www.portjohnstown.com  
**Location:** Ottawa, Canada - St. Lawrence River  
**Bulk Berths:** 8 berths  
**Total Uncovered Storage:** 65,000sqm  
 Grain elevator 170,000t capacity

## LA BAIE

**Rio Tinto Alcan**  
 262 1st Street  
 La Baie  
 Quebec  
 G7B 3R1  
 Canada  
**Contact:** Mr Steeve Boivin, Port Agent  
 T: + 1 418 544 9674  
 F: + 1 418 544 9622  
 E: PA.agency@riotinto.com  
**Equipment & Capacity:** 2 shore crane / 800 mtph  
**DUNCAN 2:** Minimum draught: 12.0m as per chart daytum  
 Tidal range: 4-6m  
**DUNCAN 1:** 10.89m

## MILFORD

**National Gypsum Co Ltd**  
 PO Box 57  
 Milford  
 Nova Scotia  
 BON 1Y0  
 Canada  
**Contact:** Terminal Operator  
 T: + 1 902 883 2224  
 F: + 1 902 758 3955  
 E: info@ngcl.com  
 W: www.nationalgypsum.com

## MONTREAL

**Federal Marine Terminals**  
 Suite 3500  
 1000 de la Gauchetiere Street West  
 Montreal  
 Quebec  
 H3B 4W5  
 Canada  
**Contact:** Mr Mike Kirkpatrick, Vice President Sales & Marketing  
 T: + 1 905 528 8741  
 F: + 1 905 528 9332  
 E: mkirkpatrick@fedmar.com  
 W: www.fmtcgo.com

## MONTREAL

**Les Silos Port-Cartier**  
 360 rue St-Jacques  
 Montreal  
 Quebec  
 H2Y 1P5  
 Canada  
**Contact:** Mr Richard Bridgeman,  
 T: + 1 514 844 9391  
 F: + 1 514 844 0588

## MONTREAL

**Logistec Corporation**  
 360 St Jacques  
 Suite 15000  
 Montreal  
 Quebec  
 H2Y 1P5  
 Canada  
**Contact:** Mr George di Sante, Vice-President, Market Development  
 T: + 1 514 844 9381  
 F: + 1 514 842 1262  
 E: gdisante@logistec.com  
 W: www.logistec.com  
 Logistec Stevedoring Inc. is one of the largest cargo handling companies in Eastern Canada and has a network of strategically located facilities across Eastern Canada, the Great Lakes, and the United States East Coast. For more detailed information on each of the individual sites, please visit our web site at www.logistec.com.

## MONTREAL

**Montreal Port Authority (Grain Terminal)**  
 Port of Montreal Building  
 2100 Pierre-Dupuy Ave, Wing 1  
 Montreal  
 Quebec  
 H3C 3R5  
 Canada  
**Contact:** Mr Réal Bélanger,  
 Director, Growth and Development,  
 Grain & Bulk  
 T: + 1 514 283 1313  
 F: + 1 514 283 1858  
 E: belanger@port-montreal.com  
 W: www.port-montreal.com  
**Location:** Section #54 at The Montreal Port Authority  
**Equipment & Capacity:** Unloading: 3,000 tph / Loading: 5,500 tph  
**Bulk Berths:** Length: 395m / Depth: 11.3m / Beam: 36m  
**Total Covered Storage:** 262,000mt  
 Operation: Year-round.  
 We have 2 Rotary Screen Cleaner for a capacity of 24,000bph.

## MONTREAL

**Port of Montreal**  
 Port of Montreal Building  
 2100 Pierre-Dupuy Avenue, Wing 1  
 Montreal  
 Quebec  
 H3C 3R5  
 Canada  
**Contact:** Mrs Rosetta Incono,  
 Director, Growth & Development,  
 Grain & Bulk  
 T: + 1 514 283 1434  
 F: + 1 514 283 0829  
 E: iaconor@port-montreal.com  
 W: www.port-montreal.com  
**Location:** Canadian East Coast  
**Equipment & Capacity:** See website www.port-montreal.com  
**Bulk Berths:** See website www.port-montreal.com  
**Total Uncovered Storage:** See website www.port-montreal.com  
**Total Covered Storage:** See website www.port-montreal.com  
 A leading breakbulk, grain and dry bulk hub, the Port of Montreal is of vital importance to industries dependent on commodities. Representing over 60% of the cargo handled in 2016, bulk sectors demonstrate our know-how and expertise as a trading partner on an international scale.

## NORTH VANCOUVER

**Kinder Morgan Canada Terminals Limited Partnership**  
 1995 West First Street  
 North Vancouver  
 BC  
 V7P 1A8  
 Canada  
**Contact:** Mr Tim Ayling, Director of Marketing and Sales  
 T: + 1 604 904 7206  
 F: + 1 604 982 7113  
 E: Tim\_Ayling@kindermorgan.com  
 W: www.kindermorgan.com  
**Location:** West coast of British Columbia, Canada on the Pacific Ocean  
**Bulk Berths:** 5 Panamax berths with draught of about 11m or more.  
**Total Uncovered Storage:** 190,000 MT for sulphur  
**Total Covered Storage:** 35,000sqm for pulp  
 30,000 MT for agri bulk  
 500,000 MT for mineral concentrates  
 1 million gallons for liquids  
 Very modern, multi-product terminal. 5 berths, 111-acre site.

## NORTH VANCOUVER

**Neptune Bulk Terminals (Canada) Ltd**  
 PO Box 86367  
 North Vancouver  
 BC  
 VL 4K6  
 Canada  
**Contact:** Mr Steve Hopton,  
 Manager, Operations  
 T: + 1 604 985 7461  
 F: + 1 604 684 2397  
 E: shopton@national.ca  
 W: www.neptuneterminals.com  
**Location:** In Vancouver's inner harbour  
**Equipment & Capacity:** Dry Bulk: 4 continuous loop tracks  
 Two, three-car dumpers for covered-bottom hopper cars  
 Semi-automated rail car opening system  
 Up to 170 cars per train  
 World's largest portal reclaimers for fertilizers (rated up to 3,000tph continuous operation, twin rakes)  
 Coal: Continuous loop-track system  
 Fully enclosed rotary dumper  
 Up to 152 rail cars per train  
 Two Rail mounted Stackers/Reclaimers  
 Up to 5,000 tph  
 600,000 tonnes open storage  
**Bulk Berths:** Berth 1 (Coal): Dock face: 230m (753 ft.), plus bollards & dolphins  
 Draught alongside: 15.2m (50 ft.) at zero tide  
 Vessel capacity: 180,000 dwt (Capesize)  
 Will load up to 194,000 dwt (on request)  
 Historical maximum cargo load: 173,000 tonnes  
 Berth 2 (potash) - 2 Q  
 Berth 3 (potash and inbound phosrock) - 1 linear, 3 hoppers  
**Total Covered Storage:** 210,000 tonnes for potash.

## NORTH VANCOUVER

**Oshawa Harbour Commission**  
 1050 Farewell Street  
 Oshawa  
 Ontario  
 L1H 6N6  
 Canada

**Oshawa Harbour Commission**  
 1050 Farewell Street  
 Oshawa  
 Ontario  
 L1H 6N6  
 Canada  
**Contact:** Ms Donna Taylor,  
 T: + 1 905 576 0400  
 F: + 1 905 576 5701  
 E: portoshawa@bellnet.ca  
 W: www.oshawaportauthority.com

## NORTH VANCOUVER

**Richardson International Ltd**  
 375 Low Level Road  
 North Vancouver  
 BC  
 V7L 1A7  
 Canada  
**Contact:** Mr Phillip Hulina, Director of Operations  
 T: + 1 604 987 8855  
 F: + 1 604 987 9532  
 E: phil.hulina@pgrtl.ca  
 W: www.richardson.ca

## NOVA SCOTIA

**Port of Hantsport**  
 Transport Canada  
 PO Box 208  
 Nova Scotia  
 BOP 1P0  
 Canada  
**Contact:** Ms Jeff Lawrence, Chief Administrative Officer  
 T: + 1 902 684 3210  
 F: + 1 902 426 3904  
 E: Jeff@hantsportnovascotia.com  
 W: www.hantsportnovascotia.com

## OSHAWA

**Oshawa Stevedoring Inc.**  
 1050 Farewell Street  
 Oshawa  
 Ontario  
 L1H 6N6  
 Canada  
**Contact:** Mr Allen Tupper,  
 Operations and Maintenance Director  
 T: + 1 418 766 2513  
 F: + 1 418 766 4136  
 E: allen.tupper@dc.com  
**Location:** North shore of St Lawrence - Gulf of St Lawrence  
**Equipment & Capacity:** 6 loading spts. 2,800tph average  
**Bulk Berths:** 1470' of bearth for load/unload

## OSHAWA

**Oshawa Stevedoring Inc.**  
 1050 Farewell Street  
 Oshawa  
 Ontario  
 L1H 6N6  
 Canada

T: + 1 905 728 9299  
 F: + 1 905 728 7898  
 E: info@qsl.com  
 W: www.qsl.com/en/ports/oshawa.html  
**Location:** Shores of Lake Ontario, Canada  
**Bulk Berths:** East wharf: length 274.3m, draught 8.2m  
 West wharf: length 210.7m, draught 7.2m  
**Total Uncovered Storage:** 32,515sqm  
**Total Covered Storage:** Domes: 6,655sqm, Warehouses: 6,728sqm  
 Open to navigation from late March to the end of December

## OTTAWA

**Portha Inc**  
 25 Noel Street  
 Ottawa  
 ON  
 K1M 2A4  
 Canada  
**Contact:** Mr Raymond Gaudreault,  
 T: + 1 613 833 0981  
 F: + 1 613 833 0982  
 E: rgaudreault@portha.ca

## OTTAWA

**Transport Canada**  
 Surface Infrastructure Programs (AHSB)  
 330 Sparks Road  
 Place de Ville - Tower C 18th Floor  
 Ottawa  
 Ontario  
 K1A 0N5  
 Canada  
**Contact:** Operations Officer  
 T: + 1 613 990 2309  
 F: + 1 613 998 8620  
 E: webfeedback@tc.gc.ca

## OWEN SOUND

**Great Lakes Elevator**  
 1499 First Avenue West  
 Owen Sound  
 Ontario  
 N4K 5P1  
 Canada  
**Contact:** Mr Gary Shipley,  
 Operations Manager  
 T: + 1 519 376 2754 x 3  
 F: + 1 519 376 8292  
 E: info@greatlakeslevator.com  
 W: http://greatlakeslevator.com/

## PARRSBORO

**Port Authority of Parrsboro**  
 PO Box 680  
 Parrsboro  
 Nova Scotia  
 BOM 1S0  
 Canada  
**Contact:** Mr C G Wood, Harbour Master  
 T: + 1 902 254 2513  
 F: + 1 902 254 3260  
 E: town@town.parrsboro.ns.ca  
 W: www.town.parrsboro.ns.ca

## PORT CARTIER

**Les Silos Port Cartier div. Louis Dreyfus Company Canada ULC.**  
 CP 400  
 188 Portage des Mousnes  
 Port Cartier  
 Quebec  
 G8B 2G9  
 Canada  
**Contact:** Mr Allen Tupper,  
 Operations and Maintenance Director  
 T: + 1 418 766 2513  
 F: + 1 418 766 4136  
 E: allen.tupper@dc.com  
**Location:** North shore of St Lawrence - Gulf of St Lawrence  
**Equipment & Capacity:** 6 loading spts. 2,800tph average  
**Bulk Berths:** 1470' of bearth for load/unload

**Total Uncovered Storage:** 0  
**Total Covered Storage:** 280,000t

## PORT COLBORNE

**Port Colborne Grain Terminal**  
 PO Box 129  
 Port Colborne  
 Ontario  
 L3K 5V8  
 Canada  
**Contact:** Mr Joe Lannan, Manager  
 T: + 1 905 834 3644  
 F: + 1 905 834 7816  
 E: jlanann@goderichelevators.com  
**Location:** West side at the mouth of welland canal  
**Equipment & Capacity:** 2 loading spouts (1200tph), self unloading hopper (600tph)  
**Bulk Berths:** 700 ft dock wall  
**Total Covered Storage:** 76,000 mt of storage space

## PORT MOODY

**Pacific Coast Terminals Co Ltd**  
 2300 Columbia St  
 Port Moody  
 British Columbia  
 V3H 5J9  
 Canada  
**Contact:** Mr Beau Storey, Manager, Operations  
 T: + 1 604 931 9228  
 F: + 1 604 936 6850  
 E: pctinfo@pct.ca  
 W: www.pct.ca  
**Location:** Vancouver, B.C., Canada  
**Equipment & Capacity:** Bulk Ship Loader up to 5,000MtpH  
**Bulk Berths:** Vessel size 12,000-80,000 tonnes  
 Vessel Length 142m-241m  
 Depth alongside 11.6m  
 Beam 18m-33.5m  
**Total Uncovered Storage:** 35,000sqm  
**Total Covered Storage:** 20,640sqm  
 Currently handling sulphur with potash starting mid 2017.

## PRINCE RUPERT

**Prince Rupert Port Authority**  
 200-215 Cow Bay Road  
 Prince Rupert  
 British Columbia  
 V8J 1A2  
 Canada  
**Contact:** Mr Michael Gurney,  
 T: + 1 250 627 2509  
 F: + 1 250 627 8980  
 E: mgurney@rupertport.com  
 W: www.rupertport.com

## PRINCE RUPERT

**Prince Rupert, Ridley Island Grain Elevator**  
 PO Box 877  
 Prince Rupert  
 British Columbia  
 V8J 3Y1  
 Canada  
**Contact:** Mr Jeff Burghardt,  
 T: + 1 250 627 8777  
 F: + 1 250 627 8541  
 E: edouglas@prgrain.bc.ca

## PRINCE RUPERT

**Ridley Terminals Inc**  
 2110 Ridley Island  
 PO Bag 8000  
 Prince Rupert  
 BC  
 V8J 4H3  
 Canada  
**Contact:** Mr Dennis Blake, Senior Manager  
 T: + 1 250 624 9511  
 F: + 1 250 624 2389  
 E: dblade@rti.ca  
 W: www.rti.ca  
**Location:** North West coast of British Columbia, 500 miles north of

Vancouver.  
**Equipment & Capacity:** 18 million tonne dry bulk capacity  
**Bulk Berths:** 250,000dwt capable, 22 metre draught  
**Total Uncovered Storage:** 2 million tonnes  
**Total Covered Storage:** 12,000 MT Silo  
 New LPG Export Facility under construction, slated for completion Q1 2019.

## QUEBEC

**Bunge of Canada Elevator**  
 300 Dalhousie Street  
 PO Box 2537  
 Station Terminus  
 Quebec  
 Quebec  
 G1K 7R3  
 Canada  
**Contact:** Mr Steve Cantin,  
 T: + 1 418 692 0217  
 F: + 1 418 692 0182  
 E: steve.cantin@orbteq.com

## QUEBEC

**QSL**  
 961, Champlain Boulevard  
 Quebec  
 QC  
 G1K 4J9  
 Canada  
**Contact:** Mr Raphael Charland,  
 Senior Marketing Representative  
 T: + 1 418 522 4701  
 F: + 1 418 522 9770  
 E: info@qsl.com  
 W: www.qsl.com  
**Location:** Stevedoring network extending all across Eastern Canada and through the North American heartland (Chicago).  
**Total Uncovered Storage:** 1.75 million sqm  
**Total Covered Storage:** 1 million sqm  
 QSL is not only the parent company of the entire corporate group, it also operates two terminals located in the Port of Québec.

## QUEBEC

**Quebec Port Authority**  
 150 Dalhousie Street  
 P.O. Box 80  
 Station Haute-Ville  
 Quebec  
 Quebec  
 G1R 4M8  
 Canada  
**Contact:** Ms Josianne Milette,  
 Marketing Assistant  
 T: + 1 418 648 3640 x1108  
 F: + 1 418 648 4160  
 E: marketing@portquebec.ca  
 W: www.portquebec.ca  
**Location:** 1300 km from the Atlantic Ocean on the St.Lawrence River

## QUEBEC

**Sillery Distribution Center Inc.**  
 1111 Champlain Boulevard  
 Quebec  
 Quebec  
 G1K 0A2  
 Canada  
**Contact:** Mr Stephen Leonard,  
 General Manager  
 T: + 1 418 687 7504  
 F: + 1 418 687 0169  
 E: stephen.leonard@cargill.com  
 W: www.cargill.ca

## QUEBEC

**St Lawrence Stevedoring**  
 Div of Quebec Stevedoring Company Ltd  
 961 Boulevard Champlain  
 Quebec  
 Quebec  
 G1K 4J9



Canada  
**Contact:** Mr Geoff Lemont, Vice-President  
**T:** + 1 418 522 4701  
**F:** + 1 418 522 9770  
**E:** glemont@qsl.com  
**W:** www.qsl.com  
**Location:** On St Lawrence River  
 Latitude 46° 50' 00" N  
 Longitude 71° 12' 00" W  
**Equipment & Capacity:** Pneumatic unloader  
 5 portall cranes, Ship loader - up to 150,000 tpd  
**Bulk Berths:** Berths 250 to 325m each  
 Depth - 12.5 to 15.5m  
**Total Uncovered Storage:** 300,000sqm  
**Total Covered Storage:** 17,000sqm

**REGINA**

**Viterra Inc**  
 2625 Victoria Avenue  
 Regina  
 Saskatchewan  
 S4T 7T9  
 Canada  
**Contact:** Mr Bob Miller, Senior Vice-President, Grain, North America  
**T:** + 1 866 569 4411  
**F:** + 1 306 569 4715  
**E:** investor@swp.com  
**W:** www.viterra.ca  
**Location:** (1) Canadian West Coast/North Vancouver, British Columbia; and (2) Canadian Great Lakes, St. Lawrence Seaway, Thunder Bay, Ontario and (3) Montreal (leased)  
**Bulk Berths:** Two ship berths at each location  
**Total Uncovered Storage:** Storage Capacity: (1) 237,240mt capacity (2) 362,650mt capacity (3) 262,000mt capacity  
 -Both Vancouver, BC and Thunder Bay, ON bulk grain terminals are serviced by Canadian National Railway.  
 -Montreal facility is leased

**SAINT JOHN**

**Saint John Port Authority**  
 111 Water Street  
 Saint John  
 New Brunswick  
 E2L 0B1  
 Canada  
**Contact:** Ms Paula Copeland, Manager of Corporate Communications & Governance  
**T:** + 1 506 636 4674  
**E:** pcopeland@sjport.com  
**W:** www.sjport.com  
**Location:** On the Bay of Fundy east coast of Canada.  
 110 km from the border with USA, 771km from Montreal and 1,318 km from Toronto by rail.  
**Equipment & Capacity:** Two 45-tonne Portainer Cranes at Rodney Container Terminal.  
 Barrack Point Polish Terminal has quadrant loader with a loading capacity of 2,700tpd  
**Bulk Berths:** Two 45-tonne Gantry Cranes at Rodney Container Terminal.  
 Navy Island Terminal is equipped for Starboard quarter ramps and stern ramps. Specialized equipment to handle Forest Products.  
 Rodney Terminal:  
 Slip berth Length 291 m, depth 12.2 m  
 Marginal berth Length 369 m, depth 12.2 m  
 American Iron and Metal Terminal  
 Berth Length 202 m, depth 12.2 m  
 Navy Island Terminal:  
 1A & 1B Length 378m, depth 10.4m  
 2B Length 190m, depth 10.4m  
 3A & 3B Length 313m, depth 10.4m  
 Long Wharf Terminal:

Berth length 285 m, depth 10.7m  
 Lower Cove Terminal:  
 Berth length 225 m, depth 10.7 m

Barrack Polish Terminal  
 Berth length 290 m, depth 13 m  
**Total Uncovered Storage:** 164 acres  
**Total Covered Storage:** 82,000sqm  
 Saint John is an ice-free, deep-water port with modern specialized facilities. On dock rail available with competing lines, and direct highway access from each terminal.

**SAINT-JOSEPH-DE-SOREL**

**Sorel-Tracy Maritime Terminal (STMT)**  
 59, rue Etienne  
 Saint-Joseph-de-Sorel  
 Quebec  
 J3R 5H8  
 Canada  
**T:** + 1 418 522 4701  
**F:** + 1 418 522 9770  
**E:** info@qsl.com  
**W:** www.qsl.com/en/ports/sorel\_tracy.html  
**Location:** 70 km east of Montréal, at the mouth of the Richelieu River, in Saint-Joseph-de-Sorel.  
**Equipment & Capacity:** Reach stackers, mobile cranes.  
**Bulk Berths:** Water depth up to 11m  
 Two Canadian National (CN) rail spurs and access to major North American highways.

**SALABERRY-DE-VALLEYFIELD**

**Valport Maritime Services Inc.**  
 950 Boul. Gerard- Cadieux,  
 Salaberry-de-Valleyfield  
 Quebec  
 J6T 6L4  
 Canada  
**Contact:** Mr J. Frank Dunn, President  
**T:** + 1 450 377 6686  
**F:** + 1 450 377 2521  
**E:** frank@valport.ca  
**W:** www.valport.ca/  
**Location:** 70 km west of Montreal, in the St Lawrence Seaway.  
**Equipment & Capacity:** Crane, Conveyors.  
 Shiploading up to 1,000tpd  
**Bulk Berths:** Berth 1107, 1,105 metres of docks  
**Total Uncovered Storage:** 115,000 sf  
**Total Covered Storage:** 145,000 sf  
 The only independent municipal port in Canada.  
 Can accommodate up to 4 Seaway suitable cargo vessels at any one time. Ro/Ro ramp.

**SASKATOON**

**Canpotex Limited**  
 PO Box 1600  
 Saskatoon  
 SK  
 S7K 3R7  
 Canada  
**Contact:** Mr Scott Rudderham, Senior Vice President, Operations  
**T:** + 1 306 931-2200  
**F:** + 1 306 653-5505  
**E:** corporate@canpotex.com

**SEPT-ILES**

**Iron Ore Company of Canada**  
 PO Box 910  
 Sept-Iles  
 Quebec  
 G4R 4L2  
 Canada  
**Contact:** Mr Jilles B., Coordinator  
**T:** + 1 418 968 7540  
**F:** + 1 418 968 7113

**E:** Harold.Hogan@ironore.ca  
**W:** www.ironore.ca

**SEPT-ILES**

**Porlier Express Inc**  
 315 Ave Otis  
 Sept-Iles  
 Quebec  
 G4R 1K9  
 Canada  
**Contact:** Mr Michael Lachance, Vice President  
**T:** + 1 418 962 3073  
**F:** + 1 418 962 3067  
**E:** mlachance@porlier.com  
**W:** www.porlier.com  
**Location:** Sept Iles Quebec , north shore of the St Lawrence  
**Equipment & Capacity:** Dry bulk, liquid and break bulk

**SEPT-ILES**

**Sept-Iles Port Authority**  
 1 Quai Mgr- Blanche  
 Sept-Iles  
 Quebec  
 G4R 5P3  
 Canada  
**Contact:** Ms Patsy Keays, Director of Corporate Affairs  
**T:** + 1 418 961 1235  
**F:** + 1 418 962 4445  
**E:** pkeays@portsi.com  
**W:** www.portsi.com  
**Location:** Sept-Iles is located on the north shore of the St-Lawrence River 287 NM east of Quebec City, Canada.  
**Equipment & Capacity:** - mobile dry bulk conveyors (600 - 1000 Mtpth, depending on cargo)  
 - stacker  
 - 4 ship loaders (5 000 Mtpth capacity)  
 - 2 hangars  
 - Railcar ferry dock with mobile ramp  
**Bulk Berths:** Berth No 2 dock, Length 488m, Depth 18m (owned by Iron Ore Company of Canada/Rio Tinto)  
 Berth No 4 & 5 dock, Length 487m, Depth 11m (owned by Iron Ore Company of Canada/Rio Tinto)  
 Berth No 7 dock, Length 183m, Depth 8.5m  
 Berth No 8 dock, Length 98m, Depth 12m  
 Berth No 14 & 15 dock, Length 244m, Depth 8m  
 Berth No 30 & 31 dock, Length 631.5m, Depth 16m (No 30), 12m (No 31)  
 Berth 40 dock, Length 260m, Depth 14m  
 Berth 41 dock, Length 200m, Depth 8.5m or 11m (with fenders)  
**Total Uncovered Storage:** 208,241sqm  
**Total Covered Storage:** 15,200sqm  
 Other commodities handled: Coke breeze, fuel, bunker, limestone, bentonite, alumina, aluminium

**SEPT-ILES**

**Wabush Mines**  
 1505 Point Noire  
 Sept-Iles  
 Quebec Province  
 G4R 4L4  
 Canada  
**Contact:** Mr Daniel Lebert, General Manager  
**T:** + 1 418 962 5131  
**F:** + 1 418 962 0209

**SEPT-ILES**

**Richardson International (Quebec)**  
 10 Rue de la Reine  
 Sorel-Tracy  
 Quebec  
 J3P 4R2  
 Canada  
**Contact:** Mr Serge Laperriere,

**SOREL-TRACY**

**Richardson International**  
 10 Rue de la Reine  
 Sorel-Tracy  
 Quebec  
 J3P 4R2  
 Canada  
**Contact:** Mr Serge Laperriere,

Director, Operations  
**T:** + 1 450 743 3893 ext. 7008  
**F:** + 1 450 743 5566  
**E:** serge.laperriere@richardson.ca  
**W:** www.richardson.ca  
**Bulk Berths:** 275m  
**Total Covered Storage:** 150,000t

**SQUAMISH**

**Squamish Terminals Ltd**  
 PO Box 1520  
 37500 Third Avenue  
 Squamish  
 British Columbia  
 V8B 0B1  
 Canada  
**Contact:** Mrs Kim Stegeman-Lowe, President  
**T:** + 1 604 892 3511  
**F:** + 1 604 892 5623  
**E:** info@sqterminals.com  
**W:** www.sqterminals.com/  
**Location:** 32 nautical miles north of the Port of Vancouver, British Columbia, Canada - at the north end of the Howe Sound  
**Equipment & Capacity:** Break Bulk Facility  
**Bulk Berths:** 2 Berths, which handle common size Panamax vessels. Break Bulk Facility  
**Total Uncovered Storage:** 50,000sqm  
**Total Covered Storage:** 47,000sqm  
 Squamish Terminals is a public terminal, open to all major break-bulk shipping lines providing its customers with access to markets world-wide and is capable of handling a wide variety of cargoes.

**SQUAMISH**

**St Catharines**  
**The St Lawrence Seaway Management Corporation**  
 508 Glendale Avenue  
 St Catharines  
 Ontario  
 L2R 6V8  
 Canada  
**Contact:** Mr Bruce Hodgson, Director, Market Development  
**T:** + 1 905 641 1932  
**F:** + 1 905 641 1343  
**E:** bhodgson@seaway.ca  
**W:** www.greatlakes-seaway.com  
**Location:** St. Lawrence Seaway Great Lakes  
 Servicing 41 ports the Gateway to the North American Heartland.

**ST CATHARINES**

**St Johns**  
**Port of Stephenville**  
 Transport Canada  
 Harbours & Ports Directorate  
 PO Box 1300  
 St Johns  
 Newfoundland  
 A1C 6H8  
 Canada  
**Contact:** Mr Wayne Hamilton,  
**T:** + 1 709 772 6197  
**F:** + 1 709 772 5127  
**E:** portharmonauth@nf.aibn.com  
**W:** www.portharmonauthority.ca

**ST JOHNS**

**Ports & Harbours**  
 Transport Canada  
 Harbours and Ports Directorate  
 PO Box 1300  
 St Johns  
 Newfoundland  
 Canada  
**Contact:** Ms Candice Keats, Operations Manager  
**T:** + 1 709 772 5199  
**F:** + 1 709 772 5127  
**E:** keatsc@tc.gc.ca

**ST JOHNS**

**Port Weller Marine Terminal Inc.**  
 21 Welland Canals Parkway  
 Scale House

Port Weller, Wharf no. 2  
 St. Catharines  
 Ontario  
 L2M 0A8  
 Canada  
**T:** + 1 418 522 4701  
**F:** + 1 418 522 9770  
**E:** info@qsl.com  
**W:** www.qsl.com/en/ports/weller.html  
**Location:** Along Lake Ontario, on the north eastern end of the Welland Canal  
**Bulk Berths:** Length 430m, Depth 8.2m  
**Total Uncovered Storage:** 24,000sqm  
**Total Covered Storage:** 2,230sqm  
 Accessible during the opening of the St. Lawrence Seaway System from late March to the end of December.

**SYDNEY**

**Sydney Ports**  
 Tourism Cape Breton  
 Marine and Development  
 PO Box 1448  
 Sydney  
 Nova Scotia  
 B1P 6R7  
 Canada  
**Contact:** Mr Donald Rowe, General Manager  
**T:** + 1 902 564 8452  
**F:** + 1 902 564 0911  
**E:** don@sydneyport.ca

**THUNDER BAY**

**Mission Terminal**  
 Thunder Bay  
 Ontario  
 Canada  
**Contact:** Mr Paul Kennedy,  
**T:** + 1 807 623 8968  
**F:** + 1 807 623 8823  
**E:** pkennedy@missionterminal.ca

**THUNDER BAY**

**Richardson International Ltd**  
 PO Box 10339  
 Thunder Bay  
 Ontario  
 P7B 6T8  
 Canada  
**Contact:** Mr Gerry Heinrichs, Regional Manager  
**T:** + 1 807 343 5571  
**F:** + 1 807 345 0522  
**E:** gerry.heinrichs@jrj.ca  
**W:** www.jrj.ca

**THUNDER BAY**

**Thunder Bay Port Authority**  
 100 Main Street  
 Thunder Bay  
 Ontario  
 P7B 6R9  
 Canada  
**Contact:** Mr Tim Heney, CEO  
**T:** + 1 807 346 7387  
**F:** + 1 807 345 9058  
**E:** tport@tbaytel.net  
**W:** www.portofthunderbay.ca  
**Location:** Mid-Canada - Lake Superior on Great Lakes St. Lawrence Seaway  
 Grain handled through eight grain terminals. Other bulk commodities handled through two bulk terminals. See port website for details.

**THUNDER BAY**

**Thunder Bay Terminals Ltd**  
 McKellar Island  
 PO Box 1800  
 Station 'F'  
 Thunder Bay  
 Ontario  
 P7C 5J7  
 Canada  
**Contact:** Mr John Kepes,  
**T:** + 1 807 625 7800  
**F:** + 1 807 623 5749  
**E:** j.kepes@tbaytel.net  
**W:** www.portauthority.thunder-

bay.on.ca  
**Location:** On Lake Superior

**THUNDER BAY**

**Western Grain By-Products**  
 Thunder Bay  
 Ontario  
 Canada  
**Contact:** Mr Maurice Mailhot,  
**T:** + 1 807 6238500  
**F:** + 1 807 622 0482  
**E:** wstgrain@tbaytel.net

**TORONTO**

**Toronto Port Authority**  
 60 Harbour Street  
 Toronto  
 Ontario  
 M5J 1B7  
 Canada  
**Contact:** Mr Alain Lefebvre, Manager Trade Developments  
**T:** + 1 416 462 0263  
**F:** + 1 416 462 1612  
**E:** alefebvr@logistec.com  
**W:** www.torontoport.com  
**Location:** 43 deg 40' north, 79 Deg 25' west on the North shore of Lake Ontario  
**Equipment & Capacity:** 8 docks at Seaway depth up to 300 MT capacity cranes  
**Bulk Berths:** 8 bulk docks  
**Total Uncovered Storage:** 50,632sqm  
**Total Covered Storage:** 19,821sqm  
 This major inland port has 2720m of dock wall at Seaway depth specializing in general, bulk, and project cargo. 40 acres of container storage, 62 plug-ins for reefers. Container packing/unpacking Special lifting equipment for all types of cargo.24/7 security and ISPS certified

**TROIS-RIVIÈRES**

**Groupe Somavrac**  
 3450 Boul. Gene H. Kruger  
 C.P. 294  
 Trois-Rivières  
 Quebec  
 G9A5G1  
 Canada  
**Contact:** Mr Sylvain Desbiens, Vice President  
**T:** + 1 819 379 3311  
**F:** + 1 819 379 5584  
**E:** info@grpm.com  
**W:** www.groupe-somavrac.com

**TROIS-RIVIÈRES**

**Port of Trois Rivières**  
 1545 rue du Fleuve  
 Room 300  
 Trois-Rivières  
 Quebec  
 G9A 6K4  
 Canada  
**Contact:** Ms Virginie Deschambeault, Director of Communications  
**T:** + 1 819 379 2887 ext 207  
**E:** virginie.deschambeault@porttr.com  
**W:** www.porttr.com

**TROIS-RIVIÈRES**

**Somavrac Inc.**  
 3450 gene-h-kruger  
 Trois-Rivières  
 Quebec  
 G9A5G1  
 Canada  
**Contact:** Mr Nicholas Tremblay, Maritime Foreman  
**T:** + 1 819 379 9639  
**F:** + 1 819 379 3311  
**E:** ntremblay@somavrac.com  
**W:** www.prommel.com/en/companies/somavrac/default.asp

## TROIS-RIVIÈRES

### Three Rivers Elevators

PO Box 35  
Trois-Rivières  
Quebec  
G9A 5E3  
Canada  
**Contact:** Mr Gilles Morin, General Manager  
T: + 1 819 374 6203  
F: + 1 819 374 6392  
E: g.morin@gls.qc.ca

## VALLEYFIELD

### Valport Maritime Services Inc

Port de Valleyfield  
Boul. Cadieux  
Valleyfield  
Quebec  
J6T 6L4  
Canada  
**Contact:** Mr Frank Dunn, Partner  
T: + 1 450 377 6886  
F: + 1 450 337 2521  
E: frank@valport.ca  
W: www.valport.ca  
**Location:** Valleyfield, Quebec, Canada near Montreal (50 km)  
**Equipment & Capacity:** see www.valport.ca  
**Bulk Berths:** see www.valport.ca  
**Total Uncovered Storage:** see www.valport.ca  
**Total Covered Storage:** see www.valport.ca

## VANCOUVER

### Cascadia Terminal

3333 New Brighton Road  
Vancouver  
BC V5K 5JX  
Canada  
**Contact:** Mr John Dewar, Director  
T: + 1 604 293 6207  
F: + 1 604 293 6214  
E: jdewar@cascadiaterminal.com  
W: www.viterra.ca  
**Location:** South Shore of Burrard Inlet, Vancouver, BC  
**Bulk Berths:** Max 120,000dwt  
**Total Covered Storage:** 282,830t

## VANCOUVER

### Port of Vancouver

100 The Pointe  
999 Canada Place  
Vancouver, BC  
V6C 3T4  
Canada  
**Contact:** Ms. Katherine Bamford, Director, Trade Development  
T: + 1 604 665 9065  
F: + 1 866 284 4271  
E: katherine.bamford@portvancouver.com  
W: portvancouver.com  
**Location:** West coast of Canada, located in Burrard Inlet in Vancouver, Roberts Bark in Delta, and along the Fraser River.  
**Equipment & Capacity:** 27 major marine cargo terminals  
**Total Uncovered Storage:** Please see portvancouver.com/cargo-terminals for details per terminal  
**Total Covered Storage:** Please see portvancouver.com/cargo-terminals for details per terminal.  
The Port of Vancouver is Canada's largest and most diversified deep-sea port and is the number one foreign export tonnage port in North America.

## VICTORIA

### Little Narrows Gypsum Company Ltd

RR 1 Little Narrows  
Victoria  
Nova Scotia  
BOE 1T0  
Canada  
**Contact:** Mr Mike Bishop,

T: + 1 902 756 2081  
F: + 1 902 756 2493  
E: awbishop@usg.com

## VILLE DE LA BAIE

### Rio Tinto Alcan Port Alfred

262 1st Street  
Ville de La Baie  
Quebec  
G7B 3R1  
Canada  
**Contact:** Mr Eric Favre, Director Operations  
T: + 1 418 544 9615  
F: + 1 418 544 9622  
E: eric.favre@riotinto.com  
W: www.riotintoalcan.com  
**Location:** North East of Canada  
**Equipment & Capacity:** 4 unloaders, 1,000tph each  
**Bulk Berths:** 385m, 12m draught  
**Total Uncovered Storage:** 120KT  
**Total Covered Storage:** 400KT

## WAWA

### Michipicoten Harbour

c/o Landfill Mining of Canada Ltd  
WaWa  
Ontario  
POS 1K0  
Canada  
**Contact:** Mr Mike Mezzonello, Dock Superintendent  
T: + 1 705 856 0606  
F: + 1 705 856 9783  
E: info@superioraggregates.com  
W: www.superioraggregates.com

## WEST VANCOUVER

### Canpotex Terminals Limited

1111-100 Park Royal  
West Vancouver  
BC  
V7T 1A2  
Canada  
**Contact:** Ms Jennifer Siemens, Manager, Corporate Communications  
T: + 1 306 931 2200  
F: + 1 306 653 5505  
E: jennifer.siemens@canpotex.com  
W: www.canpotex.com

## WINDSOR

### ADM Agri-Industries Company/

Windsor Grain Terminal Ltd.  
5550/5600 Maplewood Drive  
Windsor  
Ontario  
N9C 4G9  
Canada  
**Contact:** Mr Brian Brohman, Plant Manager  
T: + 1 519 972 8100  
F: + 1 519 972 2355  
E: b\_brohman@admworld.com  
**Location:** South side of the Detroit River between Lake St. Clair and Lake Erie  
**Bulk Berths:** 1000' dock X 30' foot draught  
**Total Covered Storage:** 110,000 tonnes

## WINDSOR

### Port of Windsor

Windsor Port Authority/Admin.  
Portuaire de Windsor  
3190 Sandwich Street  
Windsor  
Ontario  
N9C 1A6  
Canada  
**Contact:** Mr Peter Berry, Harbour Master/Capitaine de Port  
T: + 1 519 258 5741 ext 211  
F: + 1 519 258 5905  
E: pberry@portwindsor.com  
W: www.portwindsor.com

## WINNIPEG

### Viterra

CanWest Global Place  
201 Portage Ave  
Winnipeg  
MB  
R3C 3A7  
Canada  
**Contact:** Mr Walter Fox, VP Terminals  
T: + 1 207 944 5488  
F: + 1 207 944 5476  
E: info@viterra.ca  
W: www.viterra.ca

## CANARY

## ISLANDS

## SANTA CRUZ

### Junta del Puerto de Sto Cruz

Av Francisco Larroche 49  
Santa Cruz  
Tenerife  
38071  
Canary Islands  
**Contact:** Mr Miguel Pinter,  
T: + 34 922 605 426  
E: web@puertosdetenerife.org

## CAPE VERDE

## PRAIA

### Capitania dos Portos de Sotavento

PO Box 38  
Praia  
Cape Verde  
**Contact:** Mr Albertino Graca, Port Director  
T: + 238 612382  
F: + 238 616133  
E: Portodosotavento@enapor.cv

## CHILE

## ANTOFAGASTA

### Caleta Coloso

Ultramar Agencia Maritima  
Copia PO 574  
Casilla 1210  
Antofagasta  
Chile  
**Contact:** Mr Alberto Varas, Director  
T: + 56 55 201793  
F: + 56 55 227341

## ARICA

### Puerto Arica

Maximo Lira 389  
Arica  
Arica  
1000002  
Chile  
**Contact:** Mr Mario Moya Montenegro,  
T: + 56 58 202080  
F: + 56 58 202090  
E: mmoya@puertoarica.cl  
W: www.puertoarica.cl

## CASTILLA

### Tocopilla

c/o Servicios Integrales de Transitos y Transferencias  
Arturo Prat No 1060  
Castilla  
Tocopilla  
2098  
Chile  
**Contact:** Mr D Daniel Zarzosa, Captain Port Authority  
T: + 56 55 813 279  
E: cptocopilla@directemar.cl

## CONCEPCION

### Neuling Granelos SA

San Martin  
553 Oficina  
Concepcion  
805

## CHILE

### Contact: Mr Sergio Ulloa, General Manager

T: + 56 41 2254 205  
E: sergio.ulloa@neulingsa.cl  
**Location:** South America, Chile, Bahía de Concepcion  
**Equipment & Capacity:** 20 trucks for bulk transportation  
1 belt conveyors 40 meters  
6 grabs (8 cub meters, each one)  
**Total Uncovered Storage:** 15,000 sqm  
**Total Covered Storage:** 5,200 sqm  
We are a stevedors company in ports of Bahía de Concepcion, Chile  
These ports are : San Vicente, Coronel, Lirquen.

## IQUIQUE

### Empresa Portuaria Iquique

Avenida Jorge Barrera #62  
Iquique  
Chile  
**Contact:** Mr Alvaro Espinosa,  
T: + 56 57 400100  
F: + 56 57 413 176  
E: epi@epi.cl  
W: www.epi.cl/z

## LA SERENA

### Port Authority of Guayacan

Compania Minera del Pacifico S.A.  
Pedro Pablo Munoz 675  
La Serena  
Guayacan  
Chile  
**Contact:** Mr Eduardo Bauer, Port Manager  
T: + 56 51 208025  
F: + 56 51 208140

## LIRQUEN

### Port of Lirquen SA

Recinto Muelle s/n Lirquen  
Casilla no 937  
Correo Concepcion  
Lirquen  
Chile  
**Contact:** Mr Jorge Baksai Marquez, Terminal Manager  
T: + 56 41 451037  
F: + 56 41 451030  
E: plirquen@puerto.cl

## MEJILLONES

### Puerto Angamos

Avenida Longitudinal  
Mejillones  
Antofagasta  
Chile  
**Contact:** Mr Pablo Ortega Van Giel, Commercial department  
T: + 56 55 883622  
E: portega@puertoangamos.cl  
W: www.puertoangamos.cl

## MEJILLONES

### Puerto de Mejillones S.A

Casilla 108  
Avenida Costanera Norte 2800  
Mejillones  
Antofagasta  
1310000  
Chile  
**Contact:** Mr Natalia Amira, Sales  
T: + 56 55 883632  
E: namira@puertomejillones.cl  
W: www.puertomejillones.cl  
**Location:** Bay of Mejillones, North of Chile  
**Equipment & Capacity:** Two Berths:  
Berth N°1: Two level Luffing cranes, nominal capacity 1,200tph, conventional conveyor belt. One Shiploader, nominal capacity 1,500tph, pipe conveyor belt.  
Berth N°2: Unloading/Loading sulfuric acid, nominal capacity 7550tph.  
**Bulk Berths:** Berth N°1: Length (LOA): 230 m  
Beam: 34 m

## DWT: 85,344 tonnes

Berth N°2:  
Length (LOA): 230 m  
Beam: 34 m  
DWT: 80,000 tonnes  
**Total Uncovered Storage:** 5,000sqm  
**Total Covered Storage:** Zinc and Lead concentrates Stockpile: 6,274sqm  
Sulfuric Acid Terminal Tanks: 35,000sqm  
Puerto de Mejillones inland facilities includes one stockpile 50.000 tonnes capacity, one spot uncovered area for 30.000 tonnes and 200.000 tonnes sulfuric acid storage capacity in 10 tanks.

## MEJILLONES

### Terminal Granelos del Norte S.A.

Calle Puerto Uno N°7100  
Barrio Industrial  
Mejillones  
Antofagasta  
Chile  
**Contact:** Mr Boris Behrens S., Terminal Manager  
T: + 56 055 2883761  
E: bbehrens@puertotgn.cl  
W: www.puertotgn.cl  
**Location:** Mejillones, North of Chile, Antofagasta Region, Pacific coast  
**Equipment & Capacity:** Two Liebherr cranes model CBG 35/32, three discharge hoppers, 1300 mts of pipe conveyor system. 25.5 tons Smag Grabs.  
**Bulk Berths:** Wharf Platform of 138 mts length x 16 mts width. Max. Draft 14.4 mts, max LOA 250 mts.  
**Total Uncovered Storage:** 250,000 m2 (25 Há)  
**Total Covered Storage:** N/A

**Location:** Mejillones, North of Chile, Antofagasta Region, Pacific coast  
**Equipment & Capacity:** Two Liebherr cranes model CBG 35/32, three discharge hoppers, 1300 mts of pipe conveyor system. 25.5 tons Smag Grabs.  
**Bulk Berths:** Wharf Platform of 138 mts length x 16 mts width. Max. Draft 14.4 mts, max LOA 250 mts.  
**Total Uncovered Storage:** 250,000 m2 (25 Há)  
**Total Covered Storage:** N/A

## PUERTO NATALES

### Port of Puerto Natales

Empresa Portuaria De Chile  
Pedromot 325  
Puerto Natales  
Chile  
**Contact:** Mr Miguel Chaves, Managing Director  
T: + 56 61 411 570  
F: + 56 61 411 409

## QUINTERO

### Port Authority of Quintero

Gobernacion Maritima de Valparaiso  
Avenida 21 Mayos/n  
Quintero  
Chile  
**Contact:** Mr L Fernandez, General Manager  
T: + 56 3293 0366  
E: cpquintero@directemar.cl

## SAN ANTONIO

### Puerto Panul S.A.

Antonio Nunez de Fonseca No. 440  
Torre Bioceanica Piso 6 Of. 606  
San Antonio  
Barros Luco  
1613  
Chile  
**Contact:** Mr Carlos Valenzuela S,  
T: + 56 35-355900  
F: + 56 35-355919  
E: puertopanulsa@puertopanul.cl  
W: www.sanantonioport.cl/html/sist\_portuario/panul.php

## SANTIAGO

### E.CL S.A.

Av Apoquindo 3721 Floor 6th  
Las Condes  
Santiago  
Metropolitana  
7550177  
Chile  
**Contact:** Mr Emilio Bouchon, Gerente de Puerto

T: + 56 23533208  
F: + 56 23533210  
E: emilio.bouchon@e-cl.cl  
W: www.e-cl.cl

**Location:** North of Chile (22°05'30"S; 70°12'50"W)  
**Equipment & Capacity:** Cranes: 1 Liebherr 1,500 TPH, 1 Binsa 750 TPH  
**Bulk Berths:** DWT=85,000T, LOA 250m, Draft 14.14m  
**Total Uncovered Storage:** 40,000m2, (400,000T of coal)  
7 tanks, diesel fuel-oil chemicals

## SANTIAGO

### Portuaria Puchoo SA

Av Bdo. O'Higgins 949 Of.1206  
Casilla  
Santiago  
2511  
Chile  
**Contact:** Mr Jamie Barahona V,  
T: + 56 2 699 0330

## TOCOPILLA

### Central Termoelectrica

Tocopilla  
Avda Dr Leonardo Guzman 0780  
Tocopilla  
Casilla 1999  
Chile  
**Contact:** Mr Andres Tomquist  
Fernandes,  
T: + 56 55 813279  
F: + 56 55 813279

## VALPARAISO

### Saam

Blanco 895  
Valparaiso  
Valparaiso  
Chile  
**Contact:** Mr Manuel Inostroza, Bulk Manager  
T: + 56 32 2201 229  
F: + 56 32 2201 481  
E: servicioalcliente@saamsa.com  
W: www.saamsa.com

## VALPARAISO

### Valparaiso Port Authority

Pier No 6-10  
Errazuiz 25  
Valparaiso  
Chile  
**Contact:** Mr Gonzalo Davagnino  
Vergara, Commercial Manager  
T: + 56 3244 8727  
F: + 56 3222 4190  
E: info@portvalparaiso.cl  
W: www.portvalparaiso.cl

## CHINA

## ANQING

### Anqing Port Authority

Administration Office  
7 Yanjiang Zhong Road  
Anqing  
Anhui  
246030  
China  
**Contact:** Port Master  
T: + 86 556 521 7018  
F: + 86 556 554 2843

## BEIHAI

### Behai Harbour

Administration  
Administration Office  
75 Haijiao Road  
Beihai  
Guangxi 536000  
China  
**Contact:** Mr Yue Zhiwei, Port Manager  
T: + 86 779 303 3481  
F: + 86 779 303 6387



**CHIWAN**

**Chiwan Harbour Container Office Building**  
11th Floor Marine Building  
Chiwan  
Shenzhen  
518 068  
China

**Contact:** Mr Du Xaiokun, Commercial Department  
T: + 86 755 2669 4228  
F: + 86 755 2669 4297  
E: wuzm@cwcc.com  
W: www.cwcc.com

**CHONGQUIN**

**Chongquin Port Authority**  
3 Chaoqian Road  
Yuzhong District  
Chongquin  
Sichuan Province  
400011  
China  
T: + 86 23 6310 0374  
F: + 86 23 6310 0612  
W: www.cqg.com.cn

**DALIAN**

**Dalian Bay Coal Terminal**  
1 Gangwan Street  
Zhongshan District  
Dalian  
Liaoning Province  
116004  
China  
**Contact:** Mr Zang Feng Chiang,  
T: + 86 411 8263 7873  
F: + 86 411 8280 7148  
W: www.chinaports.com.cn/dalian.htm

**DALIAN**

**Dalian Port Authority**  
1 Gangwan Street  
Zhongshan District  
Dalian  
116001  
China  
**Contact:** Mr Hong Sun, Deputy Director of Marketing  
T: + 86 411 8263 7873  
F: + 86 411 280 7148  
E: info@portdalian.com  
W: www.portdalian.com

**DALIAN**

**DCW Group Co**  
350 Zhong Nan Road  
Zhongshan District  
Dalian  
116022  
China  
**Contact:** Mr Lu Kaili,  
T: + 86 411 289 3900  
F: + 86 411 289 1756  
E: info@dalian-gov.net

**DALIAN**

**Ganjingzi Coal Terminal**  
1 Gangwan Street  
Zhongshan District  
Dalian  
116004  
China  
**Contact:** Mr Zang Feng Qiang,  
T: + 86 411 8263 7873  
F: + 86 411 8280 7148

**DONGFANG COUNTY**

**Basuo Port Corporation**  
Basuo  
Dongfang County  
Hainan  
China  
**Contact:** Mr Zhao Huang Yong, General Manager  
T: + 86 8003 522 512  
F: + 86 8003 521 054

**FANGCHENG**

**Fangcheng Harbour Administration**  
Port Administration Office  
22 Youyi Road

Fangcheng  
Guangxi Province  
China  
**Contact:** Mr Ye Shixiang, Director General  
T: + 86 770 289 8141  
F: + 86 770 282 2663  
W: www.infomarine.gr/china/fangcheng

**FUJIAN PROVINCE**

**Dongshan Port Authority**  
Port Administration Office  
Shipping Building Dongshan Port,  
Fujian Province  
363401  
China  
**Contact:** Port Master  
T: + 86 596 562 2374  
F: + 86 596 202 8622

**FUZHOU**

**Fuzhou Port**  
79 Chieh Fang Road West  
Fuzhou  
Fujian  
China  
**Contact:** Mr C Xiguan, Deputy Director  
T: + 86 591 559 934  
F: + 86 591 839 87696

**GUANGZHOU**

**Xinggang No1**  
30 Yangjiang No1 Road  
Guangzhou  
Guangzhou Province  
510000  
China  
**Contact:** Mr Leung,  
T: + 86 20 227 9412  
F: + 86 20 227 8303

**HAIKOU**

**Haikou Port Authority**  
Hainan Port Affairs  
Hsui ying Wharf  
Haikou  
China  
**Contact:** Port Master  
T: + 86 898 866 6830  
F: + 86 898 866 2180  
E: bgs@shqj.com.cn

**HONG KONG**

**China Cement Co (HK) Ltd**  
General Office  
7 Lung Yiu Street  
Tap Shek Kok  
Tuen Mun NT  
Hong Kong  
China  
**Contact:** Mr Li Ka-Shing, Chairman of the Board  
T: + 852 2122 3133  
F: + 852 2411 3421  
E: chairfof@ckph.com.hk

**HONG KONG**

**CLP Power HK Limited**  
Castle Peak Power Station  
Tuen Mun  
Hong Kong  
China  
**Contact:** Mr Andrew C W Brandler, CEO  
T: + 852 2678 8111  
F: + 852 2760 4448  
E: csd@clp.com.hk  
W: www.clp.com.hk/Pages/home.aspx

**HONG KONG**

**The Hongkong Electric Company Ltd**  
44 Kennedy Road  
Hong Kong  
China  
**Contact:** Mr Francis C. Y. Cheng, General Manager (Generation)  
T: + 852 2982 6201  
F: + 852 2982 1654  
E: mail@hkelectric.com

W: www.hkelectric.com  
Location: Lamma Island, Hong Kong  
**Equipment & Capacity:** Five ship unloaders (2 of them are grab type with a capacity of 1,000tph each and 3 are continuous type with a capacity of 1,500tph each). One Stacker with a capacity of 3,000tph. One Stacker/Reclaimer with a stacking and reclaiming capacity of 3,000tph and 2,000tph respectively.  
**Bulk Berths:** Two berths (each 290m in length) capable of handling two coal vessels (max dwt 100,000MT) simultaneously.  
**Total Uncovered Storage:** 63,000sqm  
**Total Covered Storage:** 4,300sqm  
Facilities for the handling of limestone and gypsum are available at the East Heavy Unloading Area of the power station. The wharf is capable of unloading limestone barges up to 6,000 MT dwt with a screw-type unloader of 350tph capacity.

**HUALIEN**

**Hualien Harbour Bureau**  
No.66 Hai-Ann Road  
Hualien  
Taiwan  
97059  
China  
**Contact:** Mr Chung-Hsiung Wang, Director  
T: + 886 38 325 131  
F: + 886 38 333 757  
E: dtppd100@mail.hlhb.gov.tw  
W: www.hlhb.gov.tw

**JIANGSU**

**Port of Lianyungang**  
Jiangsu Lianyungang Port Authority  
99 Zhongshan Rd  
Lianyungang  
Jiangsu  
222046  
China  
T: + 86 518 238 2501  
F: + 86 518 238 2906  
E: info@lygport.com.cn  
W: www.lygport.com.cn

**JINZHOU**

**Jinzhou Port Authority**  
Port Administration Office  
11-2 Zhongyand Street  
1 Jingsang Street  
Jinzhou  
Liaoning  
121007  
China  
**Contact:** Port Manager  
T: + 86 416 312 7123  
F: + 86 416 312 2419  
E: msc@jinzhouport.com  
W: www.jinzhouport.com

**LIANYUNGANG**

**Lianyungang Port Authority**  
99 Zhongshan Road  
Lianyungang  
Jiangsu  
222046  
China  
**Contact:** Mr Chen Gang, Assistant Economist  
T: + 86 518 238 2502  
F: + 86 518 233 2419  
E: wangmx@lyg.gov.cn  
W: www.lygport.com.cn

**LONGKOU CITY**

**Longkou Port Authority**  
Longkou Port Administration B  
24 Huanhai Road  
Longkou City  
Shandong Province  
265700  
China  
**Contact:** Mr Wang Shu-Bo,

T: + 86 535 884 2091  
F: + 86 535 884 1137

**NANJING**

**Nanjing Port Authority**  
19 Jianbian Road  
Xia Guan District  
Nanjing  
210011  
China  
**Contact:** Mr Wu Deming,  
T: + 86 25 5858 2721  
F: + 86 25 5882 3898

**NANTONG**

**Nantong Port Authority**  
12 Qingnian Road (W)  
Nantong  
Jiangsu Province  
226006  
China  
**Contact:** Mr GE Jian-hua, Port Director  
T: + 86 8 513 831 7591  
E: ntct@public.nt.js.cn  
W: www.ntport.com.cn

**NINGBO**

**Ningbo Port Authority**  
496 Yanjiangdong Road E  
Zhenhai District  
Ningbo  
Zhejiang Province  
315200  
China  
**Contact:** Mr Linghong Li,  
T: + 86 574 769 5142  
F: + 86 574 2769 5233  
E: npa\_office@nbport.com.cn  
W: www.nbport.com.cn/wps/portal

**PINGHU**

**Zhapu Port Authority**  
Huhang Road  
Zhapu  
Pinghu  
Zhejiang  
314201  
China  
**Contact:** Port Director  
T: + 86 573 552 2035  
F: + 86 573 552 2035

**PUTIAN**

**Port of Xiuyu**  
Rm422-425, Pacific Centre  
Licheng Boulevard  
Putian  
Fujian  
China  
**Contact:** Zhang Jingsong, General Manager  
T: + 86 594 2696 290  
F: + 86 594 2696 690  
E: penavico@penavicomz.com  
Location: South of China on the South Coast  
**Equipment & Capacity:** Shore crane (2\*8T 2\*10T 2\*40T 2\*16T 2\*25T) & conveyor  
**Bulk Berths:** 25° 13.0N 118° 59.0E(APPROX)  
**Total Uncovered Storage:** 138,000 m<sup>2</sup>  
**Total Covered Storage:** 120,000 m<sup>2</sup>

**QINGDAO**

**Port of Qingdao**  
Gang Qing Road 6  
Qingdao  
Shandong Province  
266011  
China  
**Contact:** Mr Chang Dechuan, President  
T: + 86 532 298 2011  
F: + 86 532 282 2878  
E: president@qdport.com  
W: www.qdport.com/en

**QINGDAO**

**Port of Qingdao Coal Terminal**  
Gang Qing Road 6  
Qingdao  
Shandong Province  
266011  
China  
**Contact:** Mr Chang Dechuan, President  
T: + 86 532 298 2011  
F: + 86 532 282 2878  
E: kefu@qdport.com  
W: www.qdport.com/en

**QINGDAO**

**Xigang Company**  
65 Chongmingdao West Rd.  
Huangdao District  
Qingdao  
Shandong  
266500  
China  
T: + 86 532 8298 8085  
F: + 86 532 8298 8085  
E: bgs\_xg@qdport.com  
W: www.qdport.com/info/gkgk/gsgk\_gs\_xg/en/

**QINHUANGDAO**

**Qinhuangdao Port Authority**  
35 Haibin Road  
Qinhuangdao  
Heilbei  
066002  
China  
**Contact:** Mr Huang Jianhua,  
Chairman of the Board  
T: + 86 335 309 3222  
F: + 86 335 341 5467

**RIZHAO CITY**

**Rizhao Port Authority**  
Huanghai Road 1  
Rizhao City  
Shandong Province  
276826  
China  
**Contact:** Mr Wang Yan, Office Director  
T: + 86 633 838 2900  
F: + 86 633 838 2282  
E: info@mail.rzport.com  
W: www.rzport.com

**SANYA**

**Sanya Port**  
Sanya Port Administration  
Jiangang Road  
Sanya  
Hainan Province  
572100  
China  
**Contact:** Port Director  
T: + 86 899 827 4031  
F: + 86 899 827 4153

**SHANGHAI**

**Ming Sheng Stevedores No 3/4 Terminals**  
No 3 Ming Sheng Rd  
Pudong New District  
Shanghai  
200135  
China  
**Contact:** Mr Lin Huizheng,  
T: + 86 21 588 536 75  
F: + 86 21 588 534 71  
E: minsheng.port@online.sh.cn

**SHANGHAI**

**Shanghai Biny Electric Co., Ltd.**  
No. 2240 South Pudong Road  
Shanghai  
200127  
China  
**Contact:** Mr Song,  
T: + 86 21 5132 5016  
F: + 86 21 5132 5039  
E: biny@mail@binygrp.com  
W: www.binygrp.com

**SHANGHAI**

**Shanghai International Port (Group) Co., Ltd**  
358 East Daming Road  
Shanghai  
200080  
China  
**Contact:** Mr. Steven , Port Director  
T: + 86 21 5533 3388  
F: + 86 21 6321 7936  
E: contact@portshanghai.com.cn  
W: www.portshanghai.com.cn

**SHANGHAI**

**Shanghai Peiner Smag Machinery Co.,Ltd**  
6098 Huqingping Road, Zhujiujiao  
Qingou  
Shanghai  
201713  
China  
**Contact:** Mr ELLAN Chan, General Manager  
T: + 86 21 5924 7798  
F: + 86 21 5924 0057  
E: ellan.chan@shpeiner.com  
W: www.shpeiner.com

**SHANGHAI**

**Shanghai Port Luojing Bulk Terminals**  
8 Shi Gang Road  
Baoshan District  
Shanghai  
China  
**Contact:** Mr Shao Xue Gang,  
Managing Director  
T: + 86 21 6323 1871  
F: + 86 21 6323 0184

**SHANTOU**

**Shantou Port**  
Shantou Port Affairs Bureau  
1 Shang Ping Road  
Shantou  
Guangdong  
515011  
China  
**Contact:** Mr Shen Jingchang,  
T: + 886 754 893 2345  
F: + 86 754 885 0425

**SHENZHEN**

**Chiwan Port Authority**  
c/o China Ocean Shipping Agency  
Gangwan Yi Road, Shekou  
Shenzhen  
Guangdong  
518067  
China  
**Contact:** Mr Du Xaiokun,  
T: + 86 755 2669 4888  
F: + 86 755 2669 4297

**SHENZHEN**

**Shekou Port Service Co Ltd**  
Gang Wan Yi Lu  
Shekou Industrial Zone  
Shekou  
Shenzhen  
Guangdong Province  
518067  
China  
**Contact:** Mr J Gao,  
T: + 86 755 699 1135  
F: + 86 755 688 5859

**SHENZHEN**

**Shenzhen Haixin Harbour Development Co Ltd**  
Mawan Port  
Nanshan District  
Shenzhen  
Guangdong  
518052  
China  
**Contact:** Mr Zhou Zhong, Port Manager  
T: + 86 755 669 3755  
F: + 86 755 667 9353

## SHENZHEN

**Shenzhen Yantian Port**  
Yantian Port Group Co  
7/F Shatuojiao Office Building  
Shenzhen  
518090  
China  
**Contact:** Mr Ding Tong Liu,  
Administrator  
T: + 86 755 8379 7111  
F: + 86 755 8379 7138

## SHIJIAZHUANG

**Hebei Port Group Co, Inc**  
35 Yuhuadong Road  
Shijiazhuang  
Hebei  
050019  
China  
**Contact:** Mr Edward Wong, Chief,  
Public Relations  
T: + 86 311 8780 0528/+ 86 335  
309 4924  
F: + 86 311 8790 0111  
E: wangcong@portqhd.com  
W: www.porthebei.com

## TAIZHOU CITY

**Port of Haimen**  
Port Administration Office  
Jiaojiang District  
Taizhou City  
Zhejiang Province  
318000  
China  
**Contact:** Mr Ji Jie Chao, Port  
Director  
T: + 86 576 822 4571  
F: + 86 576 888 1169

## TANGGU

**Tianjin Port Authority**  
2 Xingang Road  
Gate 35  
Tanggu  
Tianjin  
300456  
China  
**Contact:** Mr Lin Chen, Division  
Chief  
T: + 86 22 2570 5239  
F: + 86 22 2570 9747

## TANGGU

**Tianjin Xingang Sino**  
**Terminal Co Ltd**  
No 1 Road East Xingang  
Tanggu  
Tianjin  
300456  
China  
**Contact:** Mr Svein Weie, General  
Manager  
T: + 86 22 2570 6666  
F: + 86 22 2570 6969  
E: sw@gearbulk.com  
W: www.gearbulk.com

## TANGSHAN

**Jintang Port**  
Harbour Administration Office  
Haigang  
Development Zone  
Tangshan  
Hebei  
063600  
China  
T: + 86 315 291 4059  
F: + 86 315 291 4287

## WENZHOU

**Wenzhou Port**  
Wenzhou Port Affairs Bureau  
7th and 8th Floor  
Jiangrun Mansion  
Jiangbin Road  
Wenzhou  
Zhejiang Province  
325000  
China  
**Contact:** Port Director  
T: + 86-577-88192999  
F: + 86-577-88186775

E: office@wzport.com

## WUHU

**Wuhu Port Authority**  
Port Administration Office  
32 Jiang'an Rd  
Wuhu  
Anhui Province  
241000  
China  
**Contact:** Port Master  
T: + 86 553 383 9153  
F: + 86 553 381 1064

## XIAMEN

**Xiamen Harbour Authority**  
127 Dongdu Road  
Xiamen  
Fujian Province  
361012  
China  
**Contact:** Mr Huang He Rong,  
Manager  
T: + 86 592 561 4889  
F: + 86 592 561 2682  
E: xpgco@public.xm.fj.cn  
W: www.portxiamen.com.cn

## YANTAI

**Yantai Port Authority**  
Yantai Port Group Limited  
155 Beima Road  
Yantai  
Shandong Province  
264000  
China  
**Contact:** Mr Liu Zhen Hu, General  
Manager  
T: + 86 535 674 2134  
F: + 86 535 624 1892  
E: ytpport@yantaiport.com.cn  
W: www.yantaiport.com.cn

## YINGKOU

**Port of Yingkou**  
Yingkou Harbour Administration  
1 Xingang Road  
Bayuquan District  
Yingkou  
Liaoning  
115007  
China  
**Contact:** Port Director  
T: + 86 417 625 1778  
F: + 86 417 625 1523

## ZHANJIANG

**Zhanjiang Port Authority**  
Port Administration Office  
1 You Yi Rd, Xiashan  
Zhanjiang  
Guangdong  
524027  
China  
**Contact:** Mr Liang da Tong,  
Managing Director  
T: + 86 759 225 5516  
F: + 86 759 228 0814

## ZHANJIANG

**Zhanjiang Port Authority**  
Ganggu Road  
Zhanjiang  
Jiangsu Province  
215633  
China  
**Contact:** Mr Zhen Riqiang,  
Managing Director  
T: + 86 759 2250102  
F: + 86 759 2280814  
E: zjport@163.net  
W: www.zjport.com

## ZHENJIANG

**Zhenjiang Port Authority**  
Administration Office  
19 Changjiang Road  
Zhenjiang  
Jiangsu Province  
212001  
China  
**Contact:** Mr Xia Mao Xiang,  
Harbour Master

T: + 86 511 527 4892  
F: + 86 511 257 7837  
E: zjport@163.net

## ZHOUSHAN

**Zhoushan Port**  
**Administrative Bureau**  
1 Ding Harbor Terminal  
Zhoushan  
Zhejiang  
China  
**Contact:** Mr Sheng Liding, Director  
T: + 86 580 206 7164  
F: + 86 580 206 7164  
E: zsport@zhoushan.gov.cn  
W: www.zsport.com.cn/english

## ZHOUSHAN

**Zhoushan Port Haitong**  
**Transhipment & Storage Co**  
**Ld**  
Loatangshan Port Area  
Dinghai  
Zhoushan  
316043  
China  
**Contact:** Ms Li Yading, General  
Manager  
T: + 86 580 801 0202  
E: zsport@zhoushan.gov.cn  
W: www.zsport.com.cn

## COLOMBIA

### BARRANQUILLA

**Carbones del Carrejon LLC**  
Cra 54 # 72-80  
Barranquilla  
Colombia  
**Contact:** Mr Ricardo Acosta,  
T: + 57 53 50 6802  
F: + 57 53 50 2111  
E: ricardo.acosta@cerrejoncoal.com  
W: www.cerrejon.com  
**Location:** North coast of Colombia  
**Equipment & Capacity:** 28 Mtpa

### BARRANQUILLA

**Cementos del Caribe**  
Via 40 Las Flores  
Barranquilla  
Colombia  
**Contact:** Mr Enrique Esparragoza,  
Shipping Manager  
T: + 57 5 361 9389  
E: eesparragoza@argos.com.co

### BARRANQUILLA

**Compas SA**  
Via 40 Las Flores  
Former Cementos Argos SA  
Barranquilla  
Atlantico  
575  
Colombia  
**Contact:** Mr Uriel Duarte, Terminal  
Manager  
T: + 575 3322 020 Ext 5400  
F: + 575 3619 222  
E: uduarte@compas.com.co  
W: www.compas.com.co  
**Location:** North East coast of  
Colombia  
**Equipment & Capacity:** Movable  
shiploader & 900tph  
**Bulk Berths:** 250m piled platform  
**Total Uncovered Storage:**  
85,000sqm  
**Total Covered Storage:** 6,000sqm  
Presently building a second berthing  
position to accommodate an  
additional large vessel.

### BARRANQUILLA

**Port of Puerto Bolivar**  
International Colombia Resources  
Corporation  
Apartado Aero 52499  
Barranquilla  
Colombia  
**Contact:** Capt Steve C Catton, Port  
Superintendent  
T: + 57 53 799545

### BARRANQUILLA

**Port of Puerto Bolivar**  
International Colombia Resources  
Corporation  
Apartado Aero 52499  
Barranquilla  
Colombia  
**Contact:** Capt Steve C Catton, Port  
Superintendent  
T: + 57 53 799545

F: + 57 53 502121  
E: opprbv@navescolombia.com  
W: www.navescolombia.com/  
ports/pbolivar.htm

### BARRANQUILLA

**Sociedad Portuaria Del Norte**  
Calle 2  
No. 41N - 28  
Barrio Villanueva  
Barranquilla  
Atlantico  
Colombia  
**Contact:** Mr Carlos Rosado,  
General Manager  
T: + 575 344 57 37  
F: + 575 344 6814  
E: crosado@spdelnorte.com  
W: www.spdelnorte.com

### BARRANQUILLA

**Sociedad Portuaria Regional**  
**de Barranquilla SA**  
Carrera 38  
Calle 1a Orilla del Rio  
Terminal Maritimo y Fluvial de  
Barranquilla  
Barranquilla  
Colombia  
**Contact:** Mr Pablo Riveira,  
Operations Manager  
T: + 575 37 16200  
F: + 575 37 16310  
E: priveira@  
puertodebarranquilla.com  
W: www.sprb.com.co

### BARRANQUILLA

**Tolu**  
c/o Tolcementsos  
Carrera 58 Nos 75-78  
Barranquilla  
Colombia  
**Contact:** Mr Enrique Olarte,  
T: + 57 58 451 288  
F: + 57 58 454 548  
W:  
www.navescolombia.com/ports/tolu.  
htm  
**Bulk Berths:** Max LOA 200m, Max  
Draft alongside 34ft., Max Beam  
30m

### BOGOTA

**Puertos de Colombia**  
Carrera 10a No 15-22  
Piso 10  
Bogota  
Colombia

### BOGOTA

**Santa Marta Coal Terminal**  
Carbanandes  
Transv 19 No 122-42  
Bogota  
Colombia  
**Contact:** Mr Jairo Caicedo,  
T: + 57 1 248 7034  
F: + 57 3 310 2544330  
E: jairoca@cc-net.net

### BUENAVENTURA

**Sociedad Portuaria Regional**  
**de Buenaventura S.A**  
Avenida Portuaria  
Edificio Administracion  
Buenaventura  
Colombia  
**Contact:** Ms Matilde Correa,  
T: + 57 2 691 4348  
F: + 57 2 691 43 52  
E: matildec@sprbun.com  
W: www.sprbun.com

### SANTA MARTA

**CTS de Colombia**  
Cra. La. #10A-12  
Muelle 6  
Santa Marta  
Colombia  
**Contact:** Mr Scott Harcourt, Project  
Manager  
T: + 57 54 211 754

F: + 57 54 233 369  
E: scott.harcourt@coopertsmith.com

### SANTA MARTA

**Port of Santa Marta**  
Carrera 1 No. 10 A - 12  
Santa Marta  
Magdalena  
AA655  
Colombia  
**Contact:** Mr Rodolfo Schmulson,  
Commercial Director  
T: + 57 5 4217970 ext 103  
F: + 57 5 4212161  
E: comercial@spsm.com.co  
W: www.spsm.com.co

**Location:** Located at the northwest  
end of Santa Marta-Colombia.  
**Equipment & Capacity:** Shore  
crane: 104 tons  
Mobile crane: 50 tons  
Reach Stacker: 45 tons  
Low Boy: 70 tons  
Forklift: 2.5; 3.0; 5.5; 7.0; 15.0 tons  
Electric Forklift: 2.4 y 3.8 tons  
Pallet Jack: 2.0 y 2.72 tons  
Trucks: 35 tons  
2 STS CRANES: 100 tons each  
4 RTG'S: 50 tons each  
Pneumatic unloading system  
(VIGAN): 600 ton/h  
**Bulk Berths:** Berth # 4: Longitud  
240 Mts, Calado 46'  
Berth # 5: Longitud 94 Mts,  
Calado 25'  
Berth # 6: Longitud 150 Mts,  
Calado 60'  
Berth #7: Longitud 156 Mts,  
Calado 55'  
**Total Uncovered Storage:**  
35,000sqm  
**Total Covered Storage:** 4  
warehouses: 6.400 m2  
5 automated grain warehouses with  
storing capacity: 31.500 tons  
Metallic Storage Silo facility: 69.000  
tons

The Port serves Colombian foreign  
commerce on a 24-hour daily basis  
all year round. It further provides the  
benefits of a safe storage within its  
yards and warehouses.  
Plan of Expansion designed towards  
the specialization of the Container,  
Grain, General Cargo and Coal Sub  
Terminals.

### SANTA MARTA

**Puerto Prodeco**  
Centro Comercial Prado Plaza  
Cra 4 C126A Esq 3er  
Santa Marta  
Colombia  
**Contact:** Mr Andrew Lyons,  
T: + 57 5 4 21 4400  
F: + 57 5 4 21 4698

## CROATIA

### PLOCE

**Luka Ploce (Port of Ploce)**  
Trg kralja Tomislava 21  
Ploce 20340  
Croatia  
**Contact:** Mr Ivan Pavlovic,  
President of Board  
T: + 385 20 67 86 62  
F: + 385 20 67 91 03  
E: i.pavlovic@luka-ploce.hr  
W: www.luka-ploce.hr  
**Location:** South of CROATIA,  
South Adriatic Coast  
**Equipment & Capacity:** New Bulk  
cargo terminal, 460.000t (500.000t  
for coal)  
**Bulk Berths:** Draught 17m, 317m  
berth length, ships up to 180.000dwt  
& up to 219m of length  
**Total Uncovered Storage:**  
275,000sqm  
**Total Covered Storage:** 80,000sqm  
New Bulk terminal in operation form  
December 31st 2017.

## RIJEKA

**LUKA Rijeka d.d./Port of**  
**Rijeka j.s.c.**  
Riva 1  
Rijeka  
51000  
Croatia  
**Contact:** Mr Vedran Dev i,  
President of Management Board  
T: + 385 51 496 202  
F: + 385 51 496 203  
E: uprava@lukarijeka.hr  
W: www.lukarijeka.hr  
**Bulk Berths:** Post Panamax and  
Capesize (296m +)

## RIJEKA

**Terminal Bakar**  
LUKA Rijeka dd  
Riva 1  
Rijeka  
51000  
Croatia  
**Contact:** Mr Alen Sikic, Terminal  
Manager  
T: + 385 51 496 000 / 4969 40  
F: + 385 51 332 203  
E: info@lukarijeka.hr  
W: www.lukarijeka.hr

## ZADAR

**Zadar Port Authority**  
Lucka Kapetanija  
Libumska Obala 8  
Zadar  
57000  
Croatia  
**Contact:** Mr Milivoj Maricic, Harbour  
Master  
T: + 385 23 254 888  
F: + 385 23 254 876  
E: lucka-uprava-zadar@zd.t-com.hr

## CUBA

### ANTILLA

**Antilla Port Authority**  
Avenida 28 de Enero No 65  
Apartado No 33  
Antilla  
Province de Holguin  
Cuba  
**Contact:** Mr Ramon Pavon,  
Harbour Master  
T: + 53 24 88248  
F: + 53 24 88437  
E: cantilla@enet.cu

### ANTILLA

**Nicaro**  
c/o Agencia de Antilla  
Avenida 28 de Enero No 65  
Apartado No 33  
Antilla  
Prov de Holguin  
Cuba  
**Contact:** Port Manager  
T: + 53 24 88248  
F: + 53 24 88127

### ANTILLA

**Port of Felton**  
c/o Agencia de Antilla  
Avenida 28 de Enero No 65  
Apartado No 33  
Provenida de Antilla  
Antilla  
Cuba  
**Contact:** Mr Ramon Pavon, Port  
Manager  
T: + 53 24 88248/88225  
F: + 53 248 8437

### CARDENAS

**Port of Cardenas**  
c/o Agencia Cardenas  
Calle 2 entre Cespedes y Ave 2da  
Apartado No 2847  
Cardenas  
Prov de Mantanzas  
Cuba



**CIENFUEGOS**

**Port of Cienfuegos**  
 c/o Agencia Cienfuegos  
 PO Box 420  
 Avenida 50  
 Cienfuegos  
 No 2712  
 Cuba  
**Contact:** Mr M Roderiquez, Port Manager  
 T: + 53 432 27455  
 F: + 53 432 8466

**HAVANA**

**Port Authority of Havana**  
 Ministry of Transport  
 c/o Agencia Havana  
 Lamprilla No2  
 Havana  
 Cuba  
**Contact:** Mr Miguel Izquierdo, Port Captain  
 T: + 53 7 61 6706

**MARIEL**

**Port of Mariel**  
 c/o Agencia Mariel  
 Avenida 65 No 12411 124-126  
 Apartado No 5  
 Mariel  
 Cuba  
**Contact:** Mr Manuel Ares, Director  
 T: + 53 92305  
 F: + 53 639 2510

**MATANZAS**

**Port Authority of Matanzas**  
 c/o Agencia Matanzas  
 Milanes No 28002  
 Apartado No 245  
 Matanzas  
 Cuba  
**Contact:** Mr Orestes Bravo, Manager  
 T: + 53 52 3804  
 F: + 53 52 3804

**PUERTO TARAFÁ**

**NUEVITAS**  
**Port of Nuevitas**  
 Agencia Nuevitas  
 PO Box 350  
 Puerto Tarafá Nuevitas  
 Provincia de Camaguey  
 Cuba  
**Contact:** Mr D Jose, Manuel Tores  
 T: + 53 322 4646  
 F: + 53 322 4646

**SANTIAGO DE CUBA**

**Port of Santiago de Cuba**  
 Avenida Jesus Menendez No 658  
 Apartado No 522  
 Santiago de Cuba  
 Prov de Oriente  
 Cuba  
**Contact:** Mr Ruben Callard, Port Master  
 T: + 53 2262 8543  
 F: + 53 2268 6274

**CURACAO**

**WILEMSTAD**

**Curacao Ports Authority**  
 Harbour Office  
 Werf de Wilde z/n  
 Wilemstad  
 Curacao  
**Contact:** Mr Dimitri Cloose,  
 Commercial & Marketing Manager  
 T: + 599 9 434 5922  
 F: + 599 9 461 3907  
 E: D.Cloose@curports.com  
 W: www.curports.com  
**Location:** uth Coast of Curacao at the Port of Wilemstad or Fuikbay  
**Equipment & Capacity:** 3 multi-purpose cargo quays at Brionwharves at the Port of Wilemstad, length: 305m, draught:

10.2m, plus platform for RO/RO  
 2 berths at Fuikbay, length: 109.7m,  
 draught 7.3m, conveyer & loading  
 tower with 8.53 fixed arm (150 tph)  
**Bulk Berths:** Multi-purpose cargo  
 (Willemsstad), phosphate and  
 limestone shipment, cement storage  
 silos, 5,500 Tonnes (Fuikbay)

**CYPRUS**

**LIMASSOL**

**Global Ports Investments PLC**  
 Kanika International Business  
 Center, Office 201  
 Profitli Iliia Street, 4,  
 Germasogeia,  
 Limassol  
 P.C. 4046  
 Cyprus  
**Contact:** Mr Mikhail Loganov, Chief Executive Officer  
 T: + 357 25 313475  
 F: + 357 25 503 162  
 E: globalports@teneolubruticon.com  
 W: www.globalports.com

**NICOSIA**

**Cyprus Port Authority**  
 PO Box 2007  
 Nicosia  
 1516  
 Cyprus  
**Contact:** Mr Y Kokkinos, General Manager  
 T: + 357 2 450100  
 F: + 357 2 365420  
 E: cpa@cypnet.com.cy  
 W: kypros.org/CPA/

**NICOSIA**

**Lemesos Port c/o Cyprus Port Authority**  
 PO Box 22007  
 Nicosia  
 1516  
 Cyprus  
**Contact:** Captain George Pourous, Port Manager  
 T: + 357 258 19200  
 F: + 357 255 66374  
 E: cpa@cypnet.com.cy  
 W: www.cpa.gov.cy  
**Location:** Latitude E 34 40° N  
 Longitude E 33 02° E  
**Equipment & Capacity:** Conveyor belt, grabs, pneumatic machinery-vacuum  
**Bulk Berths:** 10.40-12m depth  
 Silo 70,000 ton capacity approximate

**NICOSIA**

**Port of Vassiliko c/o Cyprus Ports Authority**  
 23 Crete Street,  
 Nicosia  
 1516  
 Cyprus  
**Contact:** Captain G. Mousoulotis, Operations Manager  
 T: + 357 248 15 225  
 F: + 357 248 35 630  
 E: gmousoulotis@cypa.gov.cy  
 W: www.cpa.gov.cy  
**Location:** Latitude 34° 43' .0 N  
 Longitude 033° 19' .0 E  
**Equipment & Capacity:** Grabs & mobile shore cranes  
**Bulk Berths:** 9m depth, max draught 8.5m  
**Total Uncovered Storage:** 20,000sqm  
 Private Port : Operated by Vassiliko Cement Works Co.

**NICOSIA**

**Vassiliko Cement Works Ltd**  
 PO Box 22281  
 Nicosia  
 1519

Cyprus  
**Contact:** Mr Georgios Stavrou,  
 Technical Manager  
 T: + 357 24 845 504  
 F: + 357 24 332651  
 E: g.stavrou@vassiliko.com  
 W: www.vassiliko.com

**NICOSIA**

**Vassiliko Port**  
 PO Box 22281  
 Nicosia  
 1519  
 Cyprus  
**Contact:** Mr Marios Averkiou,  
 General Manager  
 T: + 357 24845305  
 F: + 357 24845413  
 E: m.averkiou@vassiliko.com

**DENMARK**

**AABENRAA**

**Aabenraa Havn Port Authority**  
 Aabenraa Port  
 Mellemvej 25  
 Aabenraa  
 DK 6200  
 Denmark  
**Contact:** Mr Henrich , Port Manager  
 T: + 45 74 62 25 14  
 F: + 45 74 62 31 43  
 E: port@aabenraakom.dk  
 W: www.aabenraaport.dk

**AABENRAA**

**Ensted Bulk Terminal A/S**  
 Flensborgvej 185c  
 Aabenraa  
 Sydjylland  
 DK-6200  
 Denmark  
**Contact:** Mr Chresten Nissen,  
 Harbour Master  
 T: + 45 9189 0045  
 E: chmi@ebt-ensted.dk  
 W: www.ebt-ensted.dk  
**Location:** Port of Ensted is located at Aabenraa Inlet, 55°01,5'N 9°26,5'E - nautical map no. 159.  
**Equipment & Capacity:** 1 CSU & 1 GUL - 2,000 mtpH  
**Bulk Berths:** Import quay = 350m. Export quay = 325m.  
**Total Uncovered Storage:** 130,000 m2  
 Ensted Bulk Terminal is the largest transshipment terminal for coal and bulk in Northern Europe.

**AALBORG**

**Aalborg Bulk Terminal**  
 Landdybet 9  
 Aalborg  
 DK-9220  
 Denmark  
**Contact:** Mr Lars Andersen,  
 T: + 45 982 577 00  
 E: inter@mail.tele.dk  
**Equipment & Capacity:** 35,000 t  
**Total Covered Storage:** 7,500sqm

**AALBORG**

**Aalborg Portland**  
 Rordalsvej 44  
 PO Box 165  
 Aalborg  
 DK 9100  
 Denmark  
**Contact:** Mr Morten Knudsen,  
 T: + 45 99 33 77 41  
 F: + 45 99 33 77 21  
 E: mk@aalborg-portland.dk  
 W: www.aalborg-portland.dk

**AALBORG**

**Port of Aalborg**  
 PO Box 8530  
 Langerak 19  
 Aalborg  
 9220

Denmark  
**Contact:** Mr Jasper ,  
 T: + 45 9930 1500  
 F: + 45 9930 1515  
 E: info@aalborghavn.dk  
 W: www.aalborghavn.dk  
**Location:** Denmark  
**Equipment & Capacity:** 3 mobile harbour cranes  
 Capacity about 200tph each  
**Bulk Berths:** More berths. Up to 400m  
 draught: Max: 9.30m  
**Total Uncovered Storage:** approx. 5,000sqm  
**Total Covered Storage:** approx. 4,000sqm

**AARHUS**

**Cargo Service A/S**  
 Oceanvej 13  
 Aarhus  
 DK 8000  
 Denmark  
**Contact:** Mr Lars Krabbe, Managing Director  
 T: + 45 8730 8000  
 F: + 45 8730 8101  
 E: info@cargoservice.dk  
 W: www.cargoservice.dk  
**Location:** Central Denmark  
**Total Uncovered Storage:** 400,000sqm  
**Total Covered Storage:** 17,000sqm

**AARHUS**

**Port of Aarhus**  
 PO Box 130  
 Mindet 2  
 Aarhus  
 DK - 8100  
 Denmark  
**Contact:** Mr Jakob Christensen,  
 Port Director CEO  
 T: + 45 89 36 82 14  
 F: + 45 86 12 76 62  
 E: jfc@port.aarhus.dk  
 W: www.aarhushavn.dk

**BANDHOLM**

**Port of Bandholm**  
 c/o Knuthenborg Godskontor  
 Birketvej 1  
 Havnepladsen 6  
 Bandholm  
 4941  
 Denmark  
**Contact:** Mr N A Hovmand, Port Manager  
 T: + 45 54 76 36 11  
 F: + 45 53 88 80 11  
 E: alfr@hovmand.dk  
 W: www.hovmand.dk

**CHARLOTTENLUND**

**Copenhagen Merchants**  
 Lindegårdsvej 17  
 Charlottenlund  
 DK 2920  
 Denmark  
**Contact:** Mr Simon Rodian  
 Christensen,  
 T: + 45 3996 5308  
 F: + 45 3963 1057  
 E: src@copmer.dk  
 W: www.copmer.com  
**Location:** Kalundborg Bulk Terminal I/S: Kalundborg, Denmark (North West of Zealand)  
 Fredericia Bulk Terminal I/S: Fredericia, Denmark  
 Aalborg Bulk Terminal: Aalborg, Denmark.  
 Grenaa Bulk Terminal, Grenaa, Denmark  
 Gdansk Bulk Terminal, Gdansk, Poland  
 CM Terminal, Banie, Poland  
 Danstora, Liepaja, Latvia  
**Equipment & Capacity:**  
 Kalundborg: 600-900 tph  
 Fredericia: 300-600 tph  
 Aalborg: 300-400 tph  
 Grenaa: 300-400 tph  
 Gdansk: 400 tph

Banie: 200 tph  
 Danstora: 1,000 tph  
**Bulk Berths:** Kalundborg: 230 m, 11.6 m draught (brackish)  
 Fredericia: 400m, 13,5 m draught  
 Aalborg: 400m, 9,5 m draught  
 Grenaa: 400m, 11,0 m draught  
 Gdansk: 150m, 7,6m draught  
 Liepaja: 450m, 10,0m draught  
**Total Uncovered Storage:**  
 Southern Denmark  
 Kalundborg: 1,400 sqm  
 Fredericia: 2,000 sqm  
 Grenaa: 2,000 sqm  
**Total Covered Storage:**  
 Kalundborg: 23,000 sqm - 110,000 mt  
 Fredericia: 20,500 sqm - 100,000 mt  
 Aalborg: 7,000 sqm - 35,000 mt  
 Grenaa: 8,000 sqm - 30,000 mt  
 Gdansk: 3,000 sqm - 38,000 mt  
 Banie: 5,000 sqm - 38,000 mt  
 Liepaja: 9,000 sqm - 90,000 mt  
 Kalundborg Bulk Terminal is the largest export terminal in Denmark for grains.  
 Fredericia Bulk Terminal is particularly involved in exports of malling barley, imports of feedstuffs, imports/bagging of wood pellets/salt/fertilizer, and containerization of bulk commodities.  
 Grenaa Bulk Terminal is a specialised wood pellet terminal that however also handles grains and feedstuffs.  
 Gdansk Bulk Terminal is focusing on exports of grains and imports of feedstuffs and biomass.  
 CM Terminal is an inland grain facility.  
 Danstora is focused on exports and imports of grains, feedstuffs and wood pellets.

**COPENHAGEN**

**Copenhagen Malmo Port AB**  
 Containervej 9  
 PO Box 900  
 Nordhavn  
 Copenhagen  
 DK-2100  
 Denmark  
**Contact:** Mr Soren Balken,  
 Communications and Public Relations Coordinator  
 T: + 45 3546 1112  
 F: + 45 3546 1164  
 E: soren.balken@cmport.com  
 W: www.cmport.com  
**Location:** Copenhagen Malmö Port is located in the Øresundregion with terminals in both Denmark and Sweden  
**Equipment & Capacity:** CMP: 3 stationary cranes 20 tons  
 1 mobilecrane 64 tons, capacity 12,000 tonnes of coal a day  
 2 multidocker, 1 Fuchs  
**Bulk Berths:** CMP facilities:  
 Swede Harbour: /1001,1002 - 200m - 13.5m  
 Sødra Bulk/ 740, 750, 751 - 6.0m  
 Prøvestenen/855,856,857,858,859,8 60,861 - 679m - 10.5 - 6.0m  
 Prøvestenen/862,863 - 250m, 864,865,866 - 400m  
 Private operators:  
 Amagerværket/835,836,837,838 - 440m - 12.0m  
 Margretheholm/825 - 140m - 6.0m  
 Kalkbrænderihavnen/401,402 - 230m - 6.7m  
**Total Uncovered Storage:** Approx 680,000sqm  
**Total Covered Storage:** 60,000sqm

**ESBJERG**  
**Port of Esbjerg**  
 Hulvej 1  
 Esbjerg  
 DK-6700  
 Denmark  
**Contact:** Mr Soren Clemmensen,  
 Sales Manager  
 T: + 45 75 13 4144  
 F: + 45 75 13 4050

E: oi@portesbjerg.dk  
 W: www.port-of-esbjerg.dk

**FREDERICIA**

**ADP - Port of Fredericia and Nyborg**  
 Centerhavsvej 13  
 Fredericia  
 Southern Denmark  
 DK-7000  
 Denmark  
**Contact:** Miss Tina Grønholdt  
 Hansen, Communications  
 T: + 4 579 215 036  
 E: tgh@adp-as.dk  
 W: www.adp-as.com

**FREDERICIA**

**ADP A/S, Port of Fredericia**  
 Centerhavsvej 13  
 Fredericia  
 DK-7000  
 Denmark  
**Contact:** Mr Ole Haugsted  
 Jørgensen, Strategic Sales Manager  
 T: + 45 79 21 50 35  
 F: + 45 79 21 50 05  
 E: ohj@adp-as.dk  
 W: www.adp-as.com  
**Location:** Located at the Great Belt at the entrance to the Baltic Sea.  
**Equipment & Capacity:** 10 cranes (4 mobile). Capacity 500 - 600 tph/crane depending upon commodity.

**Bulk Berths:** Several bulk berths - water depths down to 15m, ice-free  
**Total Covered Storage:** 60,000sqm  
 Specialized in direct discharge into trucks. Short distance to motorway system.

**FREDERICIA**

**DLA Agro**  
 Centerhavsvej 13  
 Fredericia  
 DK-7000  
 Denmark  
**Contact:** Ms Heidi ,  
 T: + 45 7921 2133  
 F: +45 79 21 21 79  
 E: jhl@dlaaagro.com  
 W: www.dla.dk

**FREDERICIA**

**Fredericia Bulk Terminal c/o Fredericia Shipping**  
 Moellebugtvej 5  
 Fredericia  
 DK-7000  
 Denmark  
**Contact:** Mr Johnny B. Nielsen,  
 Commercial Terminal Manager  
 T: + 45 76 20 20 20  
 F: + 45 76 20 20 25  
 E: bulk@fredericiashipping.dk  
 W: www.fredericiashipping.dk  
**Location:** Denmark, East coast of Jylland  
**Equipment & Capacity:**  
 Cranes/Conveyor - 600 tph load  
**Bulk Berths:** Up to 14m draught - 350 m length  
**Total Uncovered Storage:** 10,000sqm  
**Total Covered Storage:** 12,000sqm

**GRENAA**

**Grenaa Bulk Terminal**  
 Neptunvej 8  
 Grenaa  
 Denmark  
**Contact:** Mr Klaus Andersen,  
 T: + 45 76 20 20 02  
 E: bulk@fredericiashipping.dk

**GRENAA**

**Port of Grenaa Ltd.**  
 Grenaa Harbour  
 Nordhavsvej 1  
 Grenaa  
 8500  
 Denmark

**Contact:** Mr Henning Laursen, Managing Director  
**T:** + 45 87 58 76 00  
**F:** + 45 86 32 43 71  
**E:** info@port-of-granaa.com  
**W:** www.port-of-granaa.com

## HADERSLEV

**Port of Haderslev**  
 PO Box 11  
 Havnekajen  
 Honnoerkajen 3  
 Haderslev  
 6100  
 Denmark  
**Contact:** Mr J C Hansen, Harbour Master  
**T:** + 45 7452 2404  
**F:** + 45 7452 5639  
**E:** jchansen@vip.cybercity.dk

## HORSENS

**Port Authority Horsens**  
 Ove Jensens Alle 35  
 Horsens  
 8700  
 Denmark  
**Contact:** Mr Peter Larsens, Port Manager  
**T:** + 45 75 62 10 14/14 33  
**F:** + 45 75 62 14 57  
**E:** pchl@horsens.dk  
**W:** www.horsenshavn.dk

## KALUNDBORG

**Asnaes Power Station**  
 Asnaes Port Authority  
 Asnaesvej 16  
 Kalundborg  
 4400  
 Denmark  
**Contact:** Mr Arne Krogh, Manager  
**T:** + 45 59 55 0600  
**F:** + 45 9955 0699  
**E:** ark@e2.dk  
**W:** www.e2.dk

## KALUNDBORG

**Kalundborg Bulk Terminal**  
 Schulz Shipping A/S  
 Vestre Havneplads 2  
 Kalundborg  
 DK-4400  
 Denmark  
**Contact:** Mr Simon Rodian Christensen,  
**T:** + 45 3996 5300  
**F:** + 45 3963 1057  
**E:** src@copmer.dk  
**W:** www.schultzshipping.com or www.copmer.dk

## KALUNDBORG

**Kalundborg Port Authority**  
 Baltic Plads 2  
 Kalundborg  
 4400  
 Denmark  
**Contact:** Mr Bent Rasmussen, Port Director  
**T:** + 45 5953 4000  
**F:** + 45 5953 4003  
**E:** info@portofkalundborg.dk  
**W:** www.portofkalundborg.dk  
**Location:** At the head of a sheltered inlet in Kalundborg Fjord, on the W coast of Sjælland, at the Great Belt  
**Equipment & Capacity:** 2 gantry rocker cranes (on rail) each 300 ts/hour  
 2 mob. harbourcrane 300 ts/hour  
 Containerhandling gear  
 1 mobile crane 200 ts/hour  
**Bulk Berths:** Southharbour (12+13) 445 mtrs - draught 11,60 mtrs.  
 Eastharbour (05+06) 320 mtrs - draught 9,60 mtrs.  
 Eastharbour (09) 230 mtrs / - draught 7,50 mtrs  
 Eastharbour (10) 330 mtrs / - draught 7,50 mtrs.  
 Vestharbour (01) 250 mtrs - draught 5,30 mtrs

**Total Covered Storage:** 46.500 sqm  
 Cap. covered Grain Storage: 177.000 tons

## KOLDING

**Kolding Port Authority**  
 Jens Holmsvej 1  
 Kolding  
 6000  
 Denmark  
**Contact:** Mr Anders Vangsbjerg Sørensen,  
**T:** + 45 75 50 20 66  
**F:** + 45 75 50 20 58  
**E:** post@koldinghavn.dk  
**W:** www.koldinghavn.dk  
**Location:** East Coast Jutland, Denmark  
**Equipment & Capacity:** 2.4 km Quay, waterdepth 7m  
 1 crane - max capacity 100ts  
 6 mobile cranes, including three hydraulic  
**Total Uncovered Storage:** 60,000sqm  
**Total Covered Storage:** 40,000sqm  
 Ships, cranes and open space operated by Port authority.  
 Warehouses by commercial warehouse owners.

## KORSØER

**Port of Korsøer**  
 Amerikakajen 1  
 Korsøer  
 DK-4220  
 Denmark  
**Contact:** Mr Jesper Kokholm, Harbour Master  
**T:** + 45 5837 0085  
**F:** + 45 5835 2598  
**E:** info@korsøerhavn.dk  
**W:** www.portofkorsøer.com

## NAESTVED

**Naestved Port**  
 Tolbodgade 4  
 Naestved  
 4700  
 Denmark  
**Contact:** Mr Jesper Pieterosen, Harbour Master  
**T:** + 45 55 78 51 82 / +45 55 98 5200  
**F:** + 45 55 72 51 83  
**E:** port@naestvedport.dk  
**W:** www.naestvedport.dk

## NAKSKOV

**Nakskov Port**  
 Havnegade 2  
 Nakskov  
 4900  
 Denmark  
**Contact:** Mr Jørgen Buhl, Harbour Manager  
**T:** + 45 54 67 73 30  
**F:** + 45 54 92 51 13  
**E:** havne@lolland.dk  
**W:** www.nakskovhavn.dk  
**Location:** Denmark on vest coast of Lolland  
**Equipment & Capacity:** 1 mobile crane and a tower crane max load 100 tonnes.  
**Bulk Berths:** Max water dept 8,5 meters total length 1,5 km.  
**Total Uncovered Storage:** 80.000 sqm  
**Total Covered Storage:** 7000sqm

## NYKØBING FALSTER

**Guldborgsund Havne**  
 Port Office  
 Fejøgade 2  
 Nykøbing Falster  
 4800  
 Denmark  
**Contact:** Ms Laila Nielsen, Harbour Manager  
**T:** + 45 54 85 05 63  
**F:** + 45 54 82 05 64  
**E:** lel@guldborgsund.dk

**W:** www.guldborgsundhavn.dk  
**Location:** Isle of Falster  
 Ports of Guldborgsund content:  
 Port of Nykøbing Falster (Comm. Port)  
 Port of Orehoved (Comm. Port)  
 Port of Stubbeboing (Comm. And)  
 Port of Gedser (fishing port)

## ODENSE

**Port of Odense**  
 Londongade 1  
 Odense  
 5000  
 Denmark  
**Contact:** Mr Finn Vinther, Harbour Master  
**T:** + 45 66 12 07 92  
**F:** + 45 65 91 47 74  
**E:** info@odensehavn.dk  
**W:** www.odensehavn.dk

## RANDERS

**Randers Port**  
 Kulhulmsvej 1  
 Randers 8900  
 Denmark  
**Contact:** Mr John Morgen, Harbour Director  
**T:** + 45 86 42 10 57  
**F:** + 45 86 40 71 81  
**E:** john.morgen@randers.dk  
**W:** www.randershavn.dk  
**Location:** Close to the Eastcoast of Jutland, with access to the sea Kattegat  
**Equipment & Capacity:** One rail situated coal crane - Several mobile cranes of up to 140 t. Molasses pipe line connections of 6" and 8".  
**Bulk Berths:** Maximum size of vessel: LOA 145 m ; Breadth 19 m  
 Several areas available for storage of cargo. Temperarily storage on keystone also possible.

## RODBY

**Rodby Port Authority**  
 c/o Scandlines  
 Østre Kaj 3  
 Rodby  
 4970  
 Denmark  
**Contact:** Mr Torben Christiansen, Port Captain  
**T:** + 45 54 605722  
**F:** + 45 54 605722  
**E:** torben.christiansen@scandlines.dk

## ROENNE

**BAF (Bornholms Andels Foderstofforretning)**  
 Port of Rønne  
 Roenne  
 Denmark  
**Contact:** Mr Cladio Pelsen, + 45 33 68 44 00  
**T:** + 45 5694 3000  
**F:** + 45 5694 3009  
**E:** info@baf.dk  
**W:** www.baf.dk

## ROENNE

**Port of Roenne Ltd.**  
 Munch Petersens Vej 2  
 PO Box 47  
 Roenne  
 3700  
 Denmark  
**Contact:** Mr Hans Kumler, Port Director  
**T:** + 45 56 95 06 78  
**F:** + 45 56 95 06 31  
**E:** hk@roennehavn.dk  
**W:** www.roennehavn.dk  
**Location:** The Baltic  
**Equipment & Capacity:** 2 Demac Cranes - Mc 300  
 1 Liebherr 954 B  
 Other commodities: Broken stone products.

## ROENNE

**Roenne Port Authority**  
 Munch Petersens' Way no. 2  
 Roenne  
 3700  
 Denmark  
**Contact:** Mr Hans Kumler, Harbour Master  
**T:** + 45 56950678  
**F:** + 45 56950631  
**E:** hk@roennehavn.dk

## SKAELSKOR

**Skaelskor Port Authority**  
 Skaelskor Havnekontoret  
 Naestvedvej 15  
 Skaelskor  
 4230  
 Denmark  
**Contact:** Mr Jacob Lund,  
**T:** + 45 58 19 80 17  
**F:** + 45 53 59 03 57  
**E:** skaelskor-havn@skaelskor.dk

## SKAELSKOR

**Stignaesværkets Port Authority**  
 S K Energi  
 Sjaellandske Kraftvaerker  
 Stignaesværket  
 Skaelskor  
 4230  
 Denmark  
**Contact:** Mr John Slangstrup Slangstrup, Port Manager  
**T:** + 45 58 16 40 00  
**F:** + 45 58 16 40 40  
**E:** sla@e2.dk

## SKOODSTRUP

**Strudstrup Port Authority**  
 Elsam t-Strudstrupværket  
 Skoodstrup  
 8541  
 Denmark  
**Contact:** Mr Paul Rokkaer,  
**T:** + 45 87 49 17 00  
**F:** + 45 87 49 17 73  
**E:** pro@elsam.com

## VORDINGBORG

**Vordingborg Port Authority**  
 Harbour Office  
 Valdemarsgade 43  
 Vordingborg  
 Sjælland  
 4760  
 Denmark  
**Contact:** Mr Claus Christensen, Harbour Master  
**T:** + 45 55 362461  
**F:** + 45 55 362500  
**E:** clch@vordingborg.dk  
**W:** www.vordingborg-shipping.com

## DOMINICAN

## REPUBLIC

## SANTA DOMINGO

**Port of Santo Domingo**  
 c/o Maritima Dominicana SA  
 PO Box 1301  
 Carretera Sanchez KM  
 Santa Domingo  
 12 1/2  
 Dominican Republic  
**Contact:** Harbour Master  
**T:** + 1809 593 5904  
**F:** + 1809 592 0910  
**E:** mail@fschad.com

## SANTA DOMINGO

**Agencias Navieras B&R, S.A.S**  
 Av. Abraham Lincoln No. 504, Torre B&R  
 Santo Domingo  
 Distrito Nacional  
 Dominican Republic  
**Contact:** Mr Jeff Rannik, President -

CEO  
**T:** + 1 809 793 7000  
**F:** + 1 809 562 3383  
**E:** chartering@navierasbr.com, ops@navierasbr.com  
**W:** www.navierasbr.com  
**Location:** Dominican Republic (Caribbean)  
**Equipment & Capacity:** According to Owners' request.  
**Bulk Berths:** According to Owners' request.  
**Total Uncovered Storage:** According to Owners' request.  
**Total Covered Storage:** According to Owners' request.  
 Agencias Navieras B&R is the oldest ship agency and stevedoring company of our country with lengthy experience handling bulk carriers and multiple commodities across all Dominican ports.

## SANTO DOMINGO

**Cabo Rojo Port Authority**  
 Maritima Dominicana SA  
 PO Box 1301  
 Santo Domingo  
 Dominican Republic  
**Contact:** Port Master  
**T:** + 1 809 537 0055  
**F:** + 1 809 537 1706  
**E:** sugerencia@apordom.gov.do  
**W:** www.apordom.gov.do

## SANTO DOMINGO

**Maritima Dominicana SA**  
 PO Box 1301  
 Carretera Sanchez Km 12 1/2  
 Santo Domingo  
 Dominican Republic  
**Contact:** Mr Karsten Windeler, President of the Board of Directors  
**T:** + 1 809 539 6000  
**F:** + 1 809 539 7200  
**E:** info@mardom.com OR trafico@mardom.com  
**W:** www.mardom.com  
**Location:** Rio Haina, south coast of the Dominican Republic.  
**Equipment & Capacity:** Grabs of up to 12 cu yds capacity, hoppers and payloaders.  
**Bulk Berths:** Several berths with up to 10m draught.

## ECUADOR

## GUAYAQUIL

**Port Authority of Guayaquil**  
 PO Box 5739  
 Puerto Maritimo  
 Guayaquil  
 Guayas Province  
 Ecuador  
**Contact:** Mr Luz Rendón, Secretary  
**T:** + 593 4 268 7930  
**F:** + 593 4 2687931  
**E:** lrendon@iantaylor.com  
**W:** www.puertodeguayaquil.com

## EGYPT

## ALEXANDRIA

**Alexandria Port Authority**  
 106 El-Horreya Avenue  
 Alexandria  
 Egypt  
**Contact:** Mr Mohamad Sammy, General Manager  
**T:** + 203 4843532 / 4 / 8 / 487 4321 22 23  
**F:** + 20 3 48 69177  
**E:** agency@msalex.com  
**W:** www.apa.gov.eg

## ALEXANDRIA

**Kamaria Grain Terminal**  
 106 EL Horreya Street  
 Alexandria  
 Egypt  
**Contact:** Admiral Ahmed Hamia,

General Manager  
**T:** + 20 3 483 1640  
**F:** + 20 3 48 07245

## CAIRO

**Abu Zenima Port Authority**  
 Sinai Manganese Co SAE  
 Head Office  
 1 Kasr El Nil Street  
 Cairo  
 Egypt  
**Contact:** Mr Hassan Eid, Chairman  
**T:** + 20 2 574 1096  
**F:** + 20 2 574 0142  
**E:** info@smc.eg.com

## CAIRO

**El Sokhna Port Development Company**  
 10 Abo-Gaafar Al-Nahaas St  
 Al-Nozha St, Ard El Golf  
 Heliopolis  
 Cairo  
 Egypt  
**Contact:** Captain Ossama Al-Sharif,  
**T:** + 20 2 37103222/ 3710320  
**F:** + 20 2 3331117/3321120  
**E:** redseaut@dscl.gov.eg

## CAIRO

**El Wadi Holdings**  
 Mohandseen  
 Cairo  
 Mohandseen  
 00202  
 Egypt  
**Contact:** Mr Tony Freiji, Vice President  
**T:** + 202 330 43 837  
**F:** + 202 3344 71 36  
**E:** amira\_hussien@medsofts.net  
**W:** www.wadigroup.com

## CAIRO

**Medsofts**  
 40, 206St. Degla  
 Cairo  
 Maadi  
 00202  
 Egypt  
**Contact:** Mr Tarek Tawfik, General Manager  
**T:** + 202 27 05 89 13  
**F:** + 202 27 54 40 54  
**E:** tawfik@medsofts.net  
**W:** www.medsofts.net

## CAIRO

**Sinai Manganese Co S A E**  
 1 Kasr El Nil Street  
 Cairo  
 Egypt  
**Contact:** Mr Sinai Manganese, Managing Director  
**T:** + 20 2 574 1096  
**F:** + 20 2 574 0142  
**E:** info@smc.eg.com

## DAMIETTA

**Damietta Port Authority**  
 PO Box 13  
 Damietta  
 345511  
 Egypt  
**Contact:** Mr Ossama Kamel, Chairman  
**T:** + 20 57 325940  
**F:** + 20 57 325930  
**E:** contactus@dam-port.com  
**W:** www.dam-port.com

## DAMIETTA

**Mina Damyat Terminal**  
 PO Box 13  
 Damietta  
 345511  
 Egypt  
**Contact:** Mr Ibrahim Shafiq, General Manager  
**T:** + 20 57 325 940  
**F:** + 20 57 325 930



**HAMRAWAIN**

**Hamrawein Port Authority**  
4, Ptolemy Street  
Bab Sharky  
Hamrawein  
Alexandria  
21514  
Egypt  
T: +20 65 342 0124  
F: +20 65 342 0124  
E: [contact@mts.gov.eg](mailto:contact@mts.gov.eg)  
W: [www.mts.gov.eg](http://www.mts.gov.eg)

**ISMAILIA**

**Port Authority of Safaga**  
c/o The Suez Canal Authority  
Ismailia  
Egypt  
Contact: Com Serrag Emara, Port Manager  
T: + 20 065 45 1222  
F: + 20 062 33 1126  
E: [info@pan-marine.net](mailto:info@pan-marine.net)  
W: [www.mts.gov.eg](http://www.mts.gov.eg)

**ISMAILIA**

**Suez Canal Authority**  
Depart. Of Planning, Research & Studies  
Information Centre - Library  
Ismailia  
41515  
Egypt  
Contact: Ms Dina Emara, Librarian  
T: + 20 064 3910000  
F: + 20 064 3914784  
E: [euscaeg@yahoo.com](mailto:euscaeg@yahoo.com)

**PORT SAID**

**Port Said Port Authority**  
Intersection of Mostafa Kamel and Azmy Street  
Railway Square  
Port Said  
Egypt  
Contact: Adm M Maged Hamza, Chairman  
T: + 20 66 3348270  
F: + 20 66 3348262  
E: [info@psdports.org](mailto:info@psdports.org)  
W: [www.psdports.org](http://www.psdports.org)

**PORT TEWFIK**

**Red Sea Port Authority**  
PO Box 1  
Port Tewfik  
Suez  
Egypt  
Contact: Vice Adm Thanaa Ahmed Kamel, Chairman  
T: + 20 62 220740  
F: + 20 62 226761  
E: [mmmt@idsc.net.eg](mailto:mmmt@idsc.net.eg)  
W: [www.mts.gov.eg](http://www.mts.gov.eg)

**SAFAGA**

**Safaga Grain Berth No1**  
Ports and Lights Administration  
Safaga  
Egypt  
Contact: Cdr Serrag Emara, Harbour Master  
T: + 20 65 45 12222  
F: + 20 62 33 1126  
E: [info@ramseystours.com](mailto:info@ramseystours.com)  
W: <http://safagaport.com>

**EL SALVADOR**

**ACAJUTLA**

**Port of Acajutla**  
CEPA  
Zona Industrial  
Acajutla  
El Salvador  
Contact: Mr Francisco Portillo, Engineer  
T: + 503 452 3145  
F: + 503 452 3145  
E: [webmaster@cepa.gob.sv](mailto:webmaster@cepa.gob.sv)  
W: [www.puertoacajutla.gob.sv](http://www.puertoacajutla.gob.sv)



*Oy M. Rauanheimo Ab working at the Port of Kokkola, Finland.*

**ERITREA**

**ASSAB**

**Assab Port Administration**  
PO Box 58  
Assab  
Eritrea  
Contact: Mr Mohammed Said Jassir, Port Manager  
T: + 291 11 552 431  
F: + 291 13 552 157  
E: [contact@ecss-online.com](mailto:contact@ecss-online.com)

**ESTONIA**

**TALLINN**

**AS Baltic Chemical Terminal**  
Narva mnt. 7d  
Tallinn  
Harjumaa  
10117  
Estonia  
Contact: Ms Julia Smirnova,  
T: + 372 66 46 507  
F: + 372 62 61 100  
E: [j.smirnova@bct.ee](mailto:j.smirnova@bct.ee)  
W: [www.bct.ee](http://www.bct.ee)  
Location: Sillamäe, East of Estonia  
Equipment & Capacity: Output of over 1 million tons of ammonia and 1 million tons of UAN  
Bulk Berths: For liquid commodities - up to 13m at the deepest berths  
Total Covered Storage: 120,000 m3  
AS BCT (Baltic Chemical Terminal) is a modern and high-tech terminal for handling liquid fertilizers to Europe and throughout the world.

**TALLINN**

**AS Coal Terminal**  
4a, Joe Street  
Tallinn  
10151  
Estonia  
Contact: Ms Nadia Manzhos, Office Manager  
T: + 372 626 36 52  
F: + 372 630 36 53  
E: [info@coalterminal.ee](mailto:info@coalterminal.ee)

W: [www.coalterminal.ee](http://www.coalterminal.ee)

**Location:** Located in the eastern part of the largest port in Estonia, Muuga, which almost never freezes; it is situated within 210km from the Russian border.  
**Equipment & Capacity:** Equipment: 2 stackers, 2 retrievers, 2 vessel loaders, a carriage dumper  
Capacity 5 000 000 tn per year  
**Bulk Berths:** Berth 31: length 210m, depth 11m; Berth 33: length 198 m, depth 11m; Berth 32: length 365m, depth 17.5m  
**Total Uncovered Storage:** 45,000sqm

**TALLINN**

**AS DBT (Dry Bulk Terminal)**  
13 Korma Street  
Haabneeme alevik, Viimsi vald, Harjumaa  
Tallinn  
74115  
Estonia  
Contact: Mrs Viktoria Jurjeva, Head of External Relations & Commercial Department  
T: + 372 66 46 509 / + 372 6 319 389  
F: + 372 6 319 189  
E: [vika@dbtmuuga.ee](mailto:vika@dbtmuuga.ee)  
W: [www.dbtmuuga.ee](http://www.dbtmuuga.ee)  
Location: Muuga Harbour  
Equipment & Capacity: 1 gantry crane and 1 shiploader  
**Bulk Berths:** 1 berth 288 m long and 14.5 m deep  
**Total Uncovered Storage:** 14,800 sqm  
**Total Covered Storage:** Storage capacity 192 000 tons  
Storage in a Customs Free Zone in 1 arched type warehouse and 8 domes, transport logistics, forwarding services, blending and bagging facility, container-stuffing (big-bags or bulk) services.

**TALLINN**

**AS MGT Muuga Grain Terminal**  
57 Maardu Street  
Tallinn

**TALLINN**

**AS MGT Muuga Grain Terminal**  
57 Maardu Street  
Tallinn

74115  
Estonia  
Contact: Capt. Artur Kivistik, Port Director  
T: + 372 6319 521  
F: + 372 6319 544  
E: [mgt@mgt.ee](mailto:mgt@mgt.ee)  
W: [www.mgt.ee](http://www.mgt.ee)  
Location: Estonia, Baltic Sea

**Equipment & Capacity:** 4 unloaders - 2500 mt/h  
1 loader - 1200 mt/h  
**Bulk Berths:** 2 berths, length-300m each, depth- 17.4 m  
**Total Covered Storage:** silo - 300 000 mt  
import capacity - 5 mln.mt/ year  
export capacity - 3 mln.mt/ year  
grain laboratory  
railcar /truck loading/unloading certificate ISO 9001:2000

**TALLINN**

**KS Stevedoring**  
Pajjassaare Harbour  
Pajjassaare tee 28E,  
Tallinn  
10313  
Estonia  
Contact: Mr Mati Roosioja, Executive Director  
T: + 372 6100 999  
E: [mati.roosioja@stevedore.ee](mailto:mati.roosioja@stevedore.ee)  
W: [www.stevedore.ee](http://www.stevedore.ee)

**TALLINN**

**Muuga (Novotallinskiy)**  
Maardu tee 57  
Tallinn Eesti Vabariik  
Tallinn  
EE 0030  
Estonia  
Contact: Mr Anatoliy Kanaev, Port Director  
T: + 372 6 319 205  
F: + 372 2 234 313  
E: [tk@tk.ee](mailto:tk@tk.ee)

**TALLINN**

**PETROMAKS SPEDITORI**  
AS  
Nolva 9A  
Tallinn

10416  
Estonia  
Contact: Mrs Kadi Neemelaid, Economic Expert  
T: + 372 650 7702  
F: + 372 650 7700  
E: [kadi@pmg.ee](mailto:kadi@pmg.ee)  
W: [www.petromaks.com](http://www.petromaks.com)

**TALLINN**

**Port of Tallinn**  
Sadama 25  
Tallinn  
15051  
Estonia  
Contact: Mr Margus Sitsi, Business Manager (General cargo, dry bulk, Ro-Ro)  
T: + 372 631 8 467  
E: [m.sitsi@ts.ee](mailto:m.sitsi@ts.ee)  
W: [www.portoftallinn.com](http://www.portoftallinn.com)

**Location:** South Coast of the Finnish Gulf in the Baltic Sea  
**Equipment & Capacity:** Dedicated coal, grain & fertilizers terminals in Muuga Harbour. Scrap metal, gravel, peat, wood pellets and other dry cargo handled in Muuga and also Paldiski South Harbour. Services provided by terminal operators - list available at [www.portoftallinn.com/terminal-operators](http://www.portoftallinn.com/terminal-operators)

**Bulk Berths:** Up to 20 berths for different bulk cargo. Max draught ca 17 m; max length of the vessel - 300m  
**Total Uncovered Storage:** 1,137,000 sqm  
**Total Covered Storage:** 160,000 sqm / 6,900 sqm reefer warehouse  
Port of Tallinn - large vessels, high loading/unloading speed and free terminals capacity - efficient corridor for cargo transportation between east and west.

**VIIMSI VALD**

**AS Stivis**  
1 Koorma Street  
Viimsi Vald  
74115  
Estonia  
Contact: Mr Jan Lipinski, Board

Member  
T: + 372 600 3872  
F: + 372 600 3873  
E: [j@stivis.ee](mailto:j@stivis.ee)  
W: [www.stivis.ee](http://www.stivis.ee)

**FIJI**

**SUVA**

**Port Authority of Fiji**  
PO Box 780  
Suva  
Viti Levu  
Fiji  
Contact: Mr Ben Naidu, Chairman  
T: + 679 331 2700  
F: + 679 330 0064  
W: [www.fijiports.com.fj](http://www.fijiports.com.fj)

**FINLAND**

**HAMINA**

**Port of Hamina Ltd**  
PO Box 14  
Hamina  
49401  
Finland  
Contact: Mr Esa Eenikainen, Port Manager  
T: + 358 5 225 5400  
F: + 358 5 749 5419  
E: [esa.eenikainen@portofhamina.fi](mailto:esa.eenikainen@portofhamina.fi)  
W: [www.portofhamina.fi](http://www.portofhamina.fi)

**KOKKOLA**

**Oy M Rauanheimo Ab**  
PO Box 254  
Kokkola  
FIN - 67101  
Finland  
Contact: Mr Joakim Laxaback, Managing Director  
T: + 358 50 387 3303  
F: + 358 20 777 1320  
E: [joakim.laxaback@rauanheimo.com](mailto:joakim.laxaback@rauanheimo.com)  
W: [www.rauanheimo.com](http://www.rauanheimo.com)

## KOKKOLA

Port of Kokkola Ltd.



Kantasatamantie 50  
Kokkola  
67900  
Finland

**Contact:** Mr Torbjörn Witting, Port Director  
T: + 358 68 2424 00

E: torbjorn.witting@kokkola.fi  
W: www.port.of.kokkola.fi

**Location:** The Port of Kokkola is the largest of the four major ports located along the coast of Ostrobothnia, Finland.

**Equipment & Capacity:** Conveyor systems from railway wagons into the warehouses and from the warehouse with loading conveyor systems into the vessel's hold. Multipurpose 40 ton cranes on rails.

**Bulk Berths:** 13m draught in the Deep Port, offering Panamax class vessels of up to 80,000 DWT

**Total Covered Storage:** Warehouses and terminals: A total of 70,000 sqm of covered warehouse space

## KOTKA

Port Of Kotka Ltd

PO Box 196  
Kotka  
48101  
Finland

**Contact:** Mrs Nanna Sirola, Marketing Manager  
T: + 358 20790 8800  
F: + 358 20 790 8891

E: nanna.sirola@portofkotka.fi  
W: www.portofkotka.fi

## KOTKA

Steveco Oy  
PO Box 44

Kotka  
48101  
Finland

**Contact:** Mr Tapio Mattila, Director of Marketing and Development

T: + 358 5 23 231  
F: + 358 5 232 3392  
E: tapio.mattila@steveco.fi  
W: www.steveco.fi

**Location:** South East of Finland on the south coast

**Equipment & Capacity:** 4 multi-purpose cranes, 1 shiploader  
**Bulk Berths:** Length 600m, depth 13.5 - 15.3m

**Total Uncovered Storage:** 20,000sqm  
**Total Covered Storage:** 30,000sqm  
Steveco offers handling and warehousing services for dry bulk such as fertilisers and paper fillers. In the future Steveco will concentrate on project cargoes.

## LOVIISA

Port of Loviisa

Loviisa  
Valko  
FI-07910  
Finland

**Contact:** Mr Aki Marjasvaara, Port Director / Harbour Office  
T: + 358 19 555 1  
E: aki.marjasvaara@loviisa.fi  
W: www.loviisa.fi

## NAANTALI

Port of Naantali

Satamatie 13  
Naantali  
21100  
Finland

**Contact:** Mr Yrjö Väinälä, Port Director  
T: + 358 2 437 5511  
F: + 358 2 435 1727

E: yrjo.vainiala@naantali.fi  
W: www.naantali.fi

## NAANTALI

Port of Olkiluoto

PL 41  
Naantali  
21101  
Finland

**Contact:** Mr Jussi Malkia,  
T: + 358 400 785 489  
F: + 358 5 531 320

E: jussi.malkia@meriaura.fi  
W: www.meriaura.fi/  
PrivatePortOfOlkiluoto.html

## OULU

Herman Andersson Oy

PO Box 37  
Oulu  
90401  
Finland

**Contact:** Mr Jari Rantamäula, Managing Director  
T: + 358 8 315 0100  
F: + 358 8 371743  
E: info@hermandersson.fi  
W: www.hermanandersson.fi

## OULU

Oulu Stevedoring OY

PO Box 16  
Oulu  
90400  
Finland

**Contact:** Mr Kari Himanen, Port Director  
T: + 358 8 5584 2750  
F: + 358 8 5584 2799  
E: kari.himanen@ouka.fi

## OULU

Port of Oulu

PO Box 23  
Oulu  
90015 Oulun Kaupunki

Finland

**Contact:** Mr Päivi Vähänikkilä-Kuronen, Business Development Manager  
T: + 358 44 703 2764  
E: paivi.vahanikkila-kuronen@ouluport.com  
W: www.ouluport.com

## PORI

Port of Pori Ltd

Mensatamantie 4  
Pori  
FI-28880  
Finland

**Contact:** Ms Sari (De Meulder) Virtanen, Managing Director  
T: + 358 400 568 501 (mobile)  
F: + 358 2 634 9498

E: info.pori@pori.fi  
W: www.portofpori.fi/en  
**Location:** Port of Pori is centrally located on the west coast of Finland with fast access to the hinterlands.

**Equipment & Capacity:** - 13x Cranes, 1x Loader, 1x Stackers.  
Lifting capacity 10-200 t

**Bulk Berths:** Max draught 10m-15.3m.

Quay length 2,700m

**Total Covered Storage:** 140,500sqm

Deep fairways, easy to navigate, best winter conditions in Finland.

## RAAHE

Port of Raahе

Lapaluodontie 342  
Raahе 92180  
Finland

**Contact:** Mr Kaarlo Heikkinen, Port Director, Port marketing and development

T: + 358 08 439 3930  
F: + 358 82 22 37 155  
E: Kaarlo.Heikkinen@raahе.fi

## RAUMA

Euroports Rauma

Hakunintie 23  
PO Box 68  
Rauma  
FIN-26101  
Finland

**Contact:** Mr Juha Vannio, Sales and Marketing Manager  
T: + 358 2 83 121  
F: + 358 2 8312 444

E: juha.vannio@euroports.fi  
W: www.euroports.com

**Location:** West Coast of Finland

**Equipment & Capacity:** Lifting capacity with shore cranes 200 ton  
**Total Covered Storage:** abt 240,000sqm, 30,000sqm heated storages

Break bulk, heavy lifts and project shipments.

## RAUMA

Port of Rauma Ltd

Hakunintie 19  
Rauma  
26100  
Finland

**Contact:** Mr Hannu Asumalahti, Managing Director

T: + 358 2 837111  
F: + 358 2 822 6369  
E: office@portofrauma.com  
W: www.portofrauma.com

## TURKU

Port of Turku Authority

Juhana Herttuan puistokatu 21  
Turku  
FIN-20100  
Finland

**Contact:** Mr Kari Riutta, Harbour Master

T: + 358 2 2674 123  
F: + 358 2 2674 125  
E: kari.riutta@portofturku.fi  
W: www.portofturku.fi

**Location:** South West Finland  
**Equipment & Capacity:** Shore cranes and grabs available.  
New mobile crane with 20 tons capacity.

**Bulk Berths:** Depth 6.5m to 8.0m  
**Total Covered Storage:** Grain silo available  
Port of Turku is mainly a passenger and ro-ro port but small amounts of bulk are handled such as grain, soya and recycled glass.

## VAASA

Port of Vaasa

PO Box 2  
Vaasa  
65101  
Finland

**Contact:** Mr Lars Holmqvist, Port Director  
T: + 358 6325 4500 / +358 400 680 199

F: + 358 6 325 4514  
E: lars.holmqvist@vaasa.fi  
W: www.vaasa.fi/port

**Location:** West coast of Finland  
**Total Uncovered Storage:** 100,000 sqm approx.

**Total Covered Storage:** 30,000 sqm

## VANTAA

Suomen Viljava Oy

Kielotie 5 B  
Vantaa  
01300  
Finland

**Contact:** Mr Hannu Korttesmaa, Project Manager

T: + 358 10 3464 204  
F: + 358 01 3464 200  
E: hannu.korttesmaa@suomenviljava.fi

# An amazing mineral deposit!

The mountains of mineral at the Port of Kokkola are proof of not only the large volumes we handle but also of our skill, extensive experience and considerable, customer-driven machinery and equipment investments. All this has made us the top port in Finland for shipping mining industry products.



**PORT OF KOKKOLA**

Tel. +358 6 824 2400  
satama@portofkokkola.fi  
www.portofkokkola.fi





**W:** www.suomenviljava.fi  
**Location:** 16 inland grain storages in Finland  
 5 port terminals for grain in Finland  
**Equipment & Capacity:** At port terminals capacity 250-500tph  
 Oat fibre (betaglucane) factory in Kokemäki, Finland (business to business product).

**W:** www.sea-invest.be  
**BASSENS**  
**Ste Aquitaine du Silo de Bordeaux-Bassens**  
 10 Quai Alfred de Vial  
 Bassens  
 33530  
 France  
**Contact:** Mr Yannick M Collet, General Manager  
**T:** + 33 566 33 47 00  
**F:** + 33 566 06 22 76

**W:** www.bordeaux-port.fr  
**Location:** South West France, on the Atlantic seaboard  
**Equipment & Capacity:** Specialised in bulk cargoes handling. Many facilities available locally. Specificity of each equipment is subject to the type of product handled, same to be checked with local stevedoring company.  
**Bulk Berths:** Various bulk berths available - mainly pier type.  
**Total Uncovered Storage:** 90 000 sqm  
**Total Covered Storage:** Details to be discussed with port authorities or local stevedoring company.  
 Other Commodities handled: scrap iron, shredded tyres and crushed glass.  
 Please contact our Commercial Dept for any specific enquiry:  
 www.bordeaux-port.fr  
 developpement@bordeaux-port.fr

France  
**Contact:** Mr Th. Audiger,  
**T:** + 33 5 57 77 84 50  
**F:** + 33 5 57 77 84 51

**BOUCAU**  
**Maisica**  
 Quai du Base  
 Port de Bayonne  
 Boucau  
 64340  
 France  
**Contact:** Mr Xavier Guihard, Director  
**T:** + 33 679 99 82 99  
**F:** + 33 5 59 64 57 18  
**E:** contact@maisica.com  
**W:** www.maisica.com

**BREST**  
**CCI – Port of Brest**  
 Avenue de KIEL  
 Brest  
 29200  
 France  
**Contact:** Mr Jean-Christophe Hattenville,  
**T:** + 33 298 46 23 80  
**F:** + 33 298 43 24 56  
**E:** info@brest.port.fr  
**W:** www.brest.port.fr  
**Location:** 48° 23' 8" N, 4° 28' 8" W  
 Brest is located in the heart of the Atlantic Arc. The port is a gateway to France, Europe and a connection to ongoing worldwide sailings.

**Equipment & Capacity:** 7 cranes  
 3 conveyors belts (1 000 tph each)  
 4 mobile cranes/ 1 linkspan  
 Loading/unloading rail/road station (1 000 tpd)  
**Bulk Berths:** 4 berths from 175m to 300m length  
 Draught from 6m to 12m  
**Total Covered Storage:** 160 000 tons (7 warehouses + 8 vertical silos)  
 The terminal is enclosed, guarded 24/24h and controlled by video-surveillance; ISPS approved; ISO 14001 / 9001

2014 Figures :  
 Agro bulks : 896 000 tons  
 Oils (soyal/cloza/palm) : 112 000 tons  
 Other bulks : 455 000 tons  
 Containers : 55 000TEU  
 Fuel/gas : 790 000 tons

**BREST**  
**CCIMBO – Port of Brest**  
 1 avenue de kiel  
 Brest  
 29200  
 France  
**Contact:** Mr Gilles Fourré, Operations Manager  
**T:** + 33 (0) 298 46 23 80  
**F:** + 33 (0) 298 43 24 56  
**E:** info@brest.port.fr  
**W:** www.brest.port.fr  
**Location:** 48° 23' 27" North 4° 29' 08" West  
**Bulk Berths:** 3 piers, 700m long, draught 13m  
**Total Uncovered Storage:** 13,000t

**CALAIS**  
**Port of Calais**  
 Chambre Du Commerce  
 24 Blvd. Des Allies  
 Calais  
 Cedex 62104  
 France  
**Contact:** Mr Patrick Fourgeaud, General Manager  
**T:** + 33 321 460 000  
**F:** + 33 321 460 099  
**E:** patrickfourgeaud@calais.cci.fr  
**W:** www.calais-port.com/

**CHERBOURG-OCTEVILLE**  
**Port de Cherbourg**  
 Port de Cherbourg SAS  
 Quai de Normandie  
 BP 50231  
 Cherbourg-Octeville  
 Cedex  
 50102  
 France

**Contact:** Mr Thierry Lenepveu, Development Manager  
**T:** + 33 2 33 236453  
**F:** + 33 2 33 236455  
**E:** tlenepveu@portdecherbourg.fr  
**W:** www.port-cherbourg.com

**DIEPPE CEDEX**  
**Dieppe Port**  
 Capitainerie, Quai de la Cale  
 No 1  
 BP 227  
 Dieppe Cedex  
 Seine Maritime  
 76203  
 France  
**Contact:** Mr Thierry Brocquet, Harbour Master  
**T:** + 33 235 841 055  
**F:** + 33 235 06 12 56  
**E:** thierry.brocquet@seine-maritime.gouv.fr

**W:** www.portdedieppe.fr  
**Location:** North of France, between Le Havre and Dunkerque  
**Equipment & Capacity:** 3 railed hoisting cranes of 8 tons capacity at 25m (6 tons capacity at 32m, 3 tons capacity at 40m), 2 mobile cranes of 40 tons capacity.  
**Bulk Berths:** Quay of Norway, 700m long, berthing on 678m Quay of India, 150m long, berthing on 135m Quay of Morocco, 675m long, berthing on 555m  
**Total Uncovered Storage:** Open quay surface of 10,000m² at Quebec quay Open quay surface of 18,000m² at Paris dock (Marocco & Norway quays)  
**Total Covered Storage:** More than 20,000m² shed storage in Paris dock 8,000m² shed at Marocco quay Maximum vessels' dimensions 160m LOA, 24m breadth, 9m draught Vessels' inbound/outbound traffic taking place from 2h before to 1h after high tide Contact with "Dieppe port" on VHF channel 12.

FRANCE

**BASSENS**  
**CIMALIT**  
 Zone Portuaire  
 Quai Alfred de Vial  
 Bassens  
 33530  
 France  
**Contact:** Mr Christina Moracchini, Managing Director  
**T:** + 33 5 57 77 56 56  
**F:** + 33 5 57 77 56 50  
**E:** cimality@wanadoo.fr  
**W:** www.cimalit.com

**BASSENS**  
**Gemadocks**  
 Supporting and auxiliary transport  
 Zi Bellevue Avenue des Moines  
 Bassens  
 33530  
 France  
**Contact:** Mr Franck Humbert, Director  
**T:** + 33 5 56 31 50 34  
**F:** + 33 5 56 74 11 10

**BASSENS**  
**Sea-invest Bordeaux**  
 Rue Richelieu 1  
 Bassens  
 33530  
 France  
**Contact:** Mr Franck Humbert,  
**T:** + 33 557 77 49 51  
**F:** + 33 557 77 82 11  
**E:** franck.humbert@sea-invest-france.com

**BLAINVILLE SUR ORNE**  
**SOGEMAR**  
 Zi Caen Canal  
 Blainville Sur Orne  
 14550  
 France  
**Contact:** Mr Douglas Draper, Agency/Stevedoring  
**T:** + 33 231 35 65 68  
**F:** + 33 231 720 520  
**E:** d.draper@sogemar-caen.com  
**W:** www.sogemar-caen.com/

**BLAYE**  
**Blaye Grain Terminal**  
 Silo Portaire  
 BP 15  
 Blaye  
 33390  
 France  
**Contact:** Mr Rabu,  
**T:** + 33 557 42 0307  
**F:** + 33 557 42 3918

**BORDEAUX**  
**Bordeaux Port Authority (Grand Port Maritime de Bordeaux)**  
 152 quai de Bacalan  
 Bordeaux  
 33 082  
 France  
**Contact:** Development and Marketing Department  
**T:** + 33 5 56 90 57 18  
**E:** developpement@bordeaux-port.fr

**BORDEAUX**  
**SAIPOL**  
 Port of Bordeaux  
 Bordeaux  
 France  
**Contact:** Mr Asneres, Director  
**T:** + 33 5 57 80 87 50  
**F:** + 33 5 57 80 87 69  
**E:** sofiproteol@prolea.com

**BORDEAUX**  
**SEMABLA**  
 Port of Bordeaux  
 Bordeaux  
 France  
**Contact:** Mr Jean-François Rabu,  
**T:** + 33 5 57 42 74 91  
**F:** + 33 5 57 42 39 18  
**E:** jf.rabu@sodistock.fr

**BORDEAUX**  
**SPBL**  
 Port of Bordeaux  
 Bordeaux



# DUNKERQUE PORT

## THE FRENCH PORT FOR DRY BULK



# DUNKERQUE PORT



+33 (0)3 28 28 77 20



commercial@portdedunkerque.fr



[www.dunkerque-port.fr](http://www.dunkerque-port.fr)



NORLINK PORTS  
Ports Hauts-de-France



**DUNKERQUE**



**Port of Dunkerque**  
Terre Plein Guilan  
BP 6534  
Dunkerque  
Cedex 1  
59386  
France  
**Contact:** Mrs Marie-Elizabeth Bogucki, Communication & Relations Publiques  
T: + 33 3 28 28 7911  
F: + 33 3 28 28 79 17  
E: mebogucki@portdunkerque.fr  
W: www.dunkerque-port.fr/en/  
**Location:** Northern France, on the North Sea. Situated 40 km from the English port of Dover, 10 km from the Belgian frontier.  
**Bulk Berths:** Eastern Port: mex draught 14.2m  
Western Port: mex draught 22m  
France's leading port for ore, coal and copper imports.

**DUNKERQUE**  
**Sea-Bulk Terminal**

Route du Quai à Pondéroux Ouest  
Looon-Plage  
Dunkerque  
59279  
France  
**Contact:** Mr Philippe Bertoneche, Terminal Manager  
T: + 33 328 28 79 40  
F: + 33 328 28 79 15  
E: philippe.bertoneche@sea-invest-france.com  
W: www.sea-invest.be

**DUNKERQUE**  
**SGD - Silo a Grain**

**Dunkerque**  
Route du Fosse Defensif  
Port Est  
Dunkerque  
59140  
France  
**Contact:** Mr Olivier Albrecht, Commercial Director  
T: + 33 3 28 24 90 10  
F: + 33 3 28 24 90 15  
E: olivieralbrecht.dmt@orange.fr

**DUNKERQUE**  
**Silonor**

Quai Cerealiier- Port Est  
Dunkerque  
59140  
France  
**Contact:** Mr Olivier Albrecht, Commercial Director  
T: + 33 3 28 24 90 10  
F: + 33 3 28 24 90 15  
E: olivieralbrecht.dmt@orange.fr

**FECAMP**  
**Fecamp Port Authority**

16 Grand Quai  
PO Box 167  
Fecamp  
76400  
France  
**Contact:** Mr Y Morel, Harbour Master  
T: + 33 235 28 23 76  
F: + 33 235 28 75 86  
E: info@fecamp.cci.fr  
W: www.fecamp.cci.fr

**LA ROCHELLE**  
**Atlantic Port La Rochelle**

17001  
La Rochelle  
BP 70394  
France  
**Contact:** Ms Patricia Hagerty, Marketing & Sales  
T: + 33 5 46 00 7492  
F: + 33 5 46 43 19 28  
E: p.hagerty@alrochelle.port.fr

W: www.larochelle.port.fr

**LA ROCHELLE-PALLICE**  
**Silo de la Rochelle Pallice**

(SICA Manutention Porteur)  
69 Rue Montcalm  
La Rochelle-Pallice  
17000  
France  
**Contact:** Mr Jean-Pierre Esterez, Director  
T: + 33 546 43 9922  
F: + 33 546 43 2494  
E: jp.esterez@sica-atlantique.com

**LE HAVRE**  
**Coal Terminal**

Port of Le Havre Authority  
Terre Plein de la Barre  
PO Box 1413  
Le Havre  
Cedex  
76067  
France  
**Contact:** Mr Eric Esneu, Bulk Traffic Manager  
T: + 33 2 32 74 76 05  
F: + 33 2 32 74 76 09  
E: eric.esneu@havre-port.fr  
W: www.havre-port.net  
**Location:** North West of France (Normandy) on the North Coast  
**Equipment & Capacity:** 2 Grab unloaders- Discharging rate: 25,000tpd  
**Bulk Berths:** Max ships draught: 17m  
**Total Uncovered Storage:** 2 storage areas : 40,000sqm + 60,000sqm  
Reloading facilities: max ships draught 6m

**LE HAVRE**  
**Le Havre Multi-Bulk Terminal**

BP 1142  
CIPHA Centre of Commerce Intl  
quai George V  
Le Havre  
76063  
France  
**Contact:** Ms Miugendit ,  
T: + 33 232 74 24 80  
F: + 33 235 21 38 15  
E: lechevallier@shgt.fr  
W: www.cipha.com  
**Location:** East Channel France Seine mouth  
**Equipment & Capacity:** 2x 30t gantry cranes  
**Bulk Berths:** 1 berth: draught 17.5m  
**Total Uncovered Storage:** 300,000sqm  
**Total Covered Storage:** 12,000sqm  
Screening crushing facility

**LE HAVRE**  
**Port of Le Havre Authority**

PO Box 1413  
Terre Plein de la Barre  
Le Havre  
Cedex  
76067  
France  
**Contact:** Ms. Marie Héron, Communications Dept.  
T: + 33 232 74 74 00  
F: + 33 232 74 74 29  
E: marie.heron@haropaports.com  
W: www.haropaports.com/fr/le-havre  
**Location:** Located at the crossroads of major communication highways, at the heart of the west seaboard of the European continent, Le Havre is the first port of call for large transoceanic mother-ships. The Port of Le Havre provides the shortest transport times for commercial exchanges with all the other continents.  
**Equipment & Capacity:** Multibulks Centre: can operate direct transhipment from ships to barges

and coasters.  
Ore Centre ("Terminal MC-6"): sorting station dispatches products to storage yards, loading berths and loading tower for freight cars and trucks.

Agribusiness Centre Grain terminal: Mechanised machines for unloading freight cars and lorries at Hermann du Pasquier quay. Gantry crane (1,800 tph) for loading large grain carriers at Joannes Couvert quay. Agribusiness Centre Sugar terminal: Lorry and freightcar reception facilities and sacking station. Gantry crane for loading bulk sugar on specialised BIBO ships.

**Bulk Berths:** Multibulks Centre: Main berth - unloading ships up to 180,000 dwt, loading 35,000/50,000dwt. Additional berth loading of 5,000dwt pusher trains of barges or coasters up to 8,000dwt. Ore Centre ("Terminal MC-6"): Length 300m, 180,000 DWT. Main berth and loading berth for river barge convoys and coasters. Agribusiness Centre: Bellot dock 30,000 DWT. Tidal dock can accommodate the largest grain carriers.

**Total Uncovered Storage:** Multibulks Centre: private storage yard of 2 million tonnes. Ore Centre ("Terminal MC-6"): public yard of 530,000 tonnes, private yard of 250,000 tonnes.

**Total Covered Storage:** Agribusiness Centre Grain terminal: 80,000 tonnes grain silo. Agribusiness Centre Sugar terminal: 45,000 tonnes sugar silos operated by SHGT ("Societe Havraise de Gestion et de transport"). The Multibulks Centre has the necessary technical means for screening, grinding, mixing, long-term storage and re-forwarding onto complete trains, trucks and barges.

**LE PORTEL**  
**Gie Boulogne Clinker**

Quai de l'Europe  
Le Portel  
62480  
France  
**Contact:** Mr Jacques Duron, Administrator  
T: + 33 6 21 31 85 97  
F: + 33 6 21 33 94 57

**LORIENT**  
**Port de Commerce-Lorient**

3 Bd de la Rade  
Lorient  
56100  
France  
**Contact:** M J P Greverie,  
T: + 33 297 371 670  
F: + 33 297 379 073  
E: lorient.port.commerce@morbihan.cci.fr

**MARSEILLE**  
**Marsilles Grain Terminal**

Grand Port Maritime de Marseille  
Direction des Opérations -  
Terminaux de Marseille -  
23, place de la Joliette  
CS 81965  
Marseille  
13226 Cedex 02  
France  
**Contact:** Mr Christophe Piloix, Port Operation Manager  
T: + 33 4 91 39 49 50  
F: + 33 4 91 39 40 50  
E: gpm@marsaille-port.fr  
W: www.marsaille-port.fr

**MARSEILLE**  
**Port Autonome de Marseille/Fos**

23 Place de la Joliette  
Hotel de la Direction du Port

Marseille  
Cedex 02  
13226  
France  
**Contact:** Mr Vincent Mutel, Public Relations  
T: + 33 0491 395320  
F: + 33 0491 394024  
E: gpm@marsaille-port.fr  
W: www.marsaille-port.fr

**MARTIGUES**  
**Carfos**

13, Boulevard Maritime  
Martigues  
13500  
France  
**Contact:** Mr Xavier Hauterat,  
T: + 33 424 06 71 82  
F: + 33 424 06 34 94  
E: xavier.hauterat@sea-invest-france.com  
W: www.sea-invest.be

**MONTOIR-DE-BRETAGNE**  
**Sea-invest Montoir**

Rue de la Goelette - BP 36  
Montoir-de-Bretagne  
44550  
France  
**Contact:** Mr Pascal Vialard,  
T: + 33 240 17 31 71  
F: + 33 240 17 31 79  
E: pascal.vialard@sea-invest-france.com  
W: www.sea-invest.be

**MONTOIR-DE-BRETAGNE**  
**SONASTOCK & ATLANTIQUE STOCKAGE**

Montoir Export & Import Terminals  
Montoir-de-Bretagne  
France  
**Contact:** Mr Thierry Coiffard, Director  
T: + 33 2 40 90 01 37  
F: + 33 2 40 90 46 17  
E: t.coiffard@sodistock.fr  
W: www.sodistock.fr/anglais/accueilgb.htm

**NANTES**  
**Grand Port Maritime Nantes St Nazaire**

1 894  
Centre De Documentation  
18 Quai Ernest Renaud  
BP 18 609  
Nantes  
Cedex 04  
44186  
France  
**Contact:** Mr Laurent Buvry, Commercial Manager  
T: + 33 2 40 44 20 26  
F: + 33 2 40 44 21 81  
E: l.buvry@nantes.port.fr  
W: www.nantes.port.fr  
**Location:** Westlem France, on the Atlantic Seashore  
**Equipment & Capacity:** 1 Gantry crane - 700 t/h  
1 Crane - 700 t/h  
5 Cranes - 500 t/h each  
3 Continuous unloaders - 1200 t/h each  
1 Mobile conveyor belt - 350 t/h  
**Bulk Berths:** Montoir - Agrinul Terminal  
4 Berths; Total length - 930 m; Drafts up to 13,5 m  
**Total Covered Storage:** 70,000 sqm  
Leading French port for cattle feed imports, with a 60% market share. Special focus on traceability, cleaning, dedicated conveyors & storage, allowing strict separation of products. Quality control through HACCP process

**NANTES**  
**Montoir Agri-Bulk Terminal**

18 Quai Ernest Renaud  
Nantes  
44031  
France  
**Contact:** Mr L Buvry, Port Director  
T: + 33 240 442 020  
F: + 33 240 442 181  
E: lbuvry@nantes.port.fr  
W: www.nantes.port.fr

**NANTES**  
**Montoir Coal Terminal**

Port Atlantique Nantes Saint-Nazaire  
18 quai Ernest Renaud  
BP 18609  
Nantes  
44186  
France  
**Contact:** Mr Pascal Freneau, Marketing & Advertising Manager  
T: + 33 2 40 44 2113  
F: + 33 2 40 44 20 01  
E: p.freneau@nantes.port.fr  
W: www.nantes.port.fr

**NANTES**  
**Port Atlantique-Montoir Agri-Bulk Terminal**

18 quai Ernest Renaud  
BP 18609  
Nantes  
Cedex 4  
44186  
France  
**Contact:** Mr Pascal Freneau, Communication Manager  
T: + 33 2 40 44 20 06  
F: + 33 2 40 44 21 81  
E: p.freneau@nantes.port.fr  
W: www.nantes.port.fr  
**Location:** Westlem France

**NANTES**  
**Roche-Maurice Terminal**

18 Quai Ernest Renaud  
Nantes  
44031  
France  
**Contact:** Mr M Buvry, Commercial Manager  
T: + 33 2 40 442 020  
F: + 33 2 40 442 181  
E: m.buvry@nantes.port.fr

**NANTES**  
**SODISTOCK Group**

35 Rue des Usines  
Nantes  
cedex 4  
44 000  
France  
**Contact:** Mr Daniel Finon, Director  
T: + 33 2 40 95 08 08  
F: + 33 2 40 58 01 22  
E: d.finson@sodistock.fr  
W: www.sodistock.fr

**NANTES**  
**SONASTOCK - Nantes Export Terminal**

Sortie No 30 - Porte de l'Estuaire  
Nantes  
44186  
France  
**Contact:** Mr Daniel Finon, Directeur Général  
T: + 33 2 40 95 60 61  
F: + 33 2 40 58 15 59  
E: d.finson@sodistock.fr  
W: www.sodistock.fr/anglais/accueilgb.htm

**PARIS**  
**Port of Paris Authority**

1, quai de Grenelle  
Paris  
Cedex 15  
75732  
France  
**Contact:** Mr Christophe Duchatellier,

T: + 33 140 58 27 40  
F: + 33 140 58 27 50  
E: christophe.duchatellier@paris-ports.fr  
W: www.paris-ports.fr

**PORT DE MONTOIR**  
**Sea-invest France (Stocaloire)**

Terminal Agro Alimentaire  
Port De Montoir  
44550  
France  
**Contact:** Mr Florent Massart,  
T: + 33 232108516  
F: + 331 55 66 81 50  
E: trampset@sea-invest-france.com

**PORT-LA-NOUVELLE**  
**Port of Port-la-Nouvelle**

c/o Chambre de Commerce  
876 avenue Adolphe Turrel  
Port-La-Nouvelle  
F-11210  
France  
**Contact:** Mr Laurent Moullie, Commercial Director  
T: + 33 4684 89484  
F: + 33 4684 81550  
E: pln.commercial@aude.cci.fr  
W: www.port-la-nouvelle.com  
**Location:** French Mediterranean coast  
**Equipment & Capacity:** Port activities = 2 Mt per year. Liquid bulk : 3 terminals (145,000 + 80,000 + 35,000 cbm storage capacity). Grain : 1 terminal with 3 silos (75,600 t capacity). Dry bulk and breakbulk : 1 terminal (2 port operators). Shore cranes up to 84 Mt lifting capacity. Dust-free hoppers.

**Bulk Berths:** Berth accessible to ships of maxi 145 m loa x 22 m boa x 8 m draught in the actual port. The future port (delivery of first port facilities expected by 2021) will be accessible to larger vessels. It has been particularly designed for ships of 225 m length x 36 m beam x 14.50 m draught.  
**Total Uncovered Storage:** 20,000 sqm  
**Total Covered Storage:** 150,000 sqm (actual port)  
Construction of a large port expansion (future deep sea port) with new Dry Bulk terminals. Open to investors. Please contact pln.commercial@aude.cci.fr

**ROUEN**  
**HAROPA PORTS**

34 Boulevard de Boisguilbert  
B.P. 4075  
Cedex 3  
Rouen  
76022  
France  
**Contact:** Mr Olivier Van Hoorde, Advertising Director  
T: + 33 235 529 616  
E: olivier.vanhoorde@haropaports.com  
W: www.haropa-solutions.com  
**Location:** HAROPA, the 5th largest port complex in Northern Europe, is a joint venture between the ports of Le Havre, Rouen and Paris. Connected to every continent owing to a first-rate international shipping offer (with connections to more than 600 ports worldwide), the "one-stop" hub forms a global transport and logistics system, capable of providing a comprehensive end-to-end service. HAROPA handles over 120 million tons of cargo by sea and waterway each year. HAROPA business represents 160,000 jobs.

**ROUEN**  
**Lecureur**

Val de la Haye  
QuennePort

Canteleu  
Rouen  
7630  
France  
**Contact:** Mr Patrick Chevallier,  
Director  
T: + 33 2 35 36 25 23  
F: + 33 2 35 36 48 52  
E: p.chevallier@lecurer.com

**ROUEN**  
**Maprochim**  
Centre Tertiaire Portuaire  
19 Boulevard du Midi  
Rouen  
76100  
France  
**Contact:** Mr Michael Fouche,  
Managing Director  
T: + 33 2 3281 9633  
F: + 33 2 3572 2691  
E: commercial@maprochim.fr  
W: www.maprochim.fr

**ROUEN**  
**Port of Rouen**  
34 Blvd de Boisquibert  
Rouen  
Rouen  
Cedex 3  
F 76022  
France  
**Contact:** Mr Martin Butruille, Traffic  
and Port Activity Manager  
T: + 33 235 52 54 30  
F: + 33 235 52 54 95  
E: dtap@rouen.port.fr  
W: www.rouen.port.fr  
**Location:** On the River Seine,  
between the Channel and Paris

**ROUEN**  
**SENALIA**  
Presqu'île Elie  
Rouen  
76100  
France  
**Contact:** Mr Kindelberger,  
T: + 33 235 726 904  
F: + 33 235 723 054  
E: contact@senalia.com  
W: www.senalia.com

**ROUEN**  
**SENALIA**  
Boulevard Maritime  
BP 71  
Grand Couronne  
Rouen  
76530  
France  
**Contact:** Mr Marc Blaiset,  
T: + 33 235 183 030  
F: + 33 235 183 033  
E: MarcBlaiset@senalia.com  
W: www.senalia.com

**ROUEN**  
**Silos Soufflet - SOCOMAC**  
**I/II Terminals**  
Quai de Danemark  
Dieppendalle Croisset  
PO Box 1010  
Rouen  
76380  
France  
**Contact:** Mr De Braquillanges,  
T: +33 3 25 39 41 11 / + 33 235 36 145  
F: + 33 235 085 671  
E: pbrochot@soufflet-group.com

**ROUEN**  
**Simarex Villette**  
Mole de la Darse des Docks  
BP 7  
Rouen  
Petit Couronne  
76650  
France  
**Contact:** Mr Charles Vedie,  
Operations  
T: + 33 2 3568 2402  
F: + 33 2 3567 2993

E: c.vedie@simarex.fr  
W: www.portofrouen.com/

**ROUEN**  
**Sogema**  
Boulevard Maritime - BP 3  
Grand-Couronne Terminal  
Rouen  
76530  
France  
**Contact:** Mr Robert Goudon,  
Director  
T: + 33 232 11 51 01  
F: + 33 232 11 51 25  
E: info@sea-invest.be  
W: www.sea-invest.be

**SAINT MALO**  
**St Malo Port Authority**  
Terre-Plain de l'Écluse du Naye  
Saint Malo  
35402  
France  
**Contact:** Mr Atrehu, Vice Captain  
T: + 33 299 20 25 00  
F: + 33 029 94 02 58 7  
E: atrehu@saintmalofougeres.cci.fr  
**Location:** North Brittany (France)  
West of Channel France  
**Equipment & Capacity:** 3 cranes -  
400 tph  
1 crane - 200 tph  
2 cranes - 100 tph  
**Bulk Berths:** 5 x 120 m - draft 9 m  
5 x 100m - draft 550 m  
**Total Uncovered Storage:** 190 000  
sqm  
**Total Covered Storage:** 30 000  
sqm

**SÈTE**  
**Port of Sète**  
1 quai Philippe Regy  
BP 10853  
Sète  
Cedex  
34201  
France  
**Contact:** Mr Amaud Rieurtort,  
Directeur Commercial  
T: + 33 4 67 46 34 04  
F: + 33 4 67 46 34 07  
E: rieurtort.amaud@  
portsuddefrance-sete.fr  
W: www.sete.port.fr  
**Location:** French West  
Mediterranean coast  
**Equipment & Capacity:** 10 cranes,  
1 mobile crane, 2 ship to shore  
gantry cranes  
**Bulk Berths:** Max draught: 13.5m  
**Total Uncovered Storage:**  
482,000sqm (Public) and  
538,250sqm (private)  
**Total Covered Storage:**  
130,000sqm  
Port authority since 2007 :  
Languedoc Regional Council. 300 M  
euros invested from 2007 to 2018

**SÈTE**  
**Sea-invest Sète**  
Z.I. portuaire Darse 2  
Quai Minéralier  
C.S10068  
Sète  
Cedex 34201  
France  
**Contact:** Mr Loïc Texier,  
T: + 33 467 51 63 10  
F: + 33 467 48 30 85  
E: l.texier@sea-invest-france.com  
W: www.sea-invest.be  
**Location:** South of France on the  
Mediterranean coast

**ST MALO**  
**SMG - Societe Malouine et**  
**Granvillaise**  
12 Avenue Louis-Martin  
St Malo  
Cedex  
35401  
France

**Contact:** Mr Franck Rose,  
Marketing  
T: + 33 2 99 563 381  
F: + 33 2 99 401 210  
E: f.rose@blp.bollore.com

**STRASBOURG**  
**MTS SAS**  
7 rue de Dunkerque  
Strasbourg  
67016  
France  
**Contact:** Mr Eric Mathon, CEO  
E: eric.mathon@mts-strasbourg.fr

**TARNOS**  
**Matrama Bayonne**  
Rue de l'Industrie  
Tarnos  
40220  
France  
**Contact:** Mr Vincent Boullault,  
T: + 33 240 321 735  
F: + 33 240 650 745  
E: vincent.boullault@sea-invest.fr  
W: www.ports-  
basques.com/ports/bayonne/  
**Location:** Mouth of the Adour river  
in the corner of the Bay of Biscay  
**Total Covered Storage:** 30,000  
sqm warehouse

**TOULON**  
**Port of Toulon**  
PO Box 501  
244, avenue de L'Infanterie de  
Marine  
Toulon  
Cedex 9  
83041  
France  
**Contact:** Mr Thierry Herve, Harbour  
Master  
T: + 33 494 03 27 60 (harbour  
office)  
F: + 33 494 03 38 69  
E: thierry.herve@equipement.gouv.fr

## GABON

**LIBREVILLE**  
**Libreville Port Authority**  
Office et Rades du Gabon  
PO Box 1051  
Libreville  
Gabon  
**Contact:** Mr P Andzembé, Manager  
T: + 241 70 00 48  
F: + 241 70 37 35  
E: info@ports-gabon.com  
W: www.ports-gabon.com

**LIBREVILLE**  
**Owendo Port Authority**  
PO Box 1051  
Libreville  
Gabon  
**Contact:** Port Manager  
T: + 241 70 00 48 / 17 59 / 17 98  
F: + 241 70 37 35  
E: info@ports-gabon.com  
W: www.ports-gabon.com

## GEORGIA

**POTI**  
**Poti Sea Port Corporation**  
52, D. Agmashenebeli Street  
Poti  
4401  
Georgia  
**Contact:** Mr Zviad Chkharitshvili,  
Marketing and Sales Manager  
T: + 995 493277 500  
E: zviad.chkharitshvili@  
apmterminals.com  
W: http://apmterminalspoti.com/

## GERMANY

**BRAKE**  
**J. Müller Breakbulk Terminal**  
**GmbH & Co. KG**  
Nordsir. 2  
Brake  
26912  
Germany  
**Contact:** Mr Wilhelm Heyer, VP -  
Breakbulk Logistic Centre  
T: + 49 4401 914 470  
E: wilhelm.heyer@jmueller.de  
W: www.jmueller.de  
**Location:** German North Sea coast  
**Equipment & Capacity:** 2x 88t  
container gantries, 3x 25t luffing  
cranes, 1x 1,000tph shiploader, 1x  
32t slewing luffing crane, 1x 20t  
hydraulic crane  
**Bulk Berths:** Stropmier (river pier);  
max draught 11.9m; length 275m  
Binnenhafen (inner port); max  
draught 5.35m;  
**Total Uncovered Storage:**  
115,000sqm  
**Total Covered Storage:**  
155,000sqm

**BRAKE**  
**J. Müller Weser GmbH &**  
**Co. KG**  
Neustadtstraße 15  
Brake  
Lower Saxony  
26919  
Germany  
**Contact:** Mr Lars Gottschenkis,  
Sales Manager  
T: + 49 4401 914 211  
F: + 49 4401 914 228  
E: lars.gottschenkis@jmueller.de  
W: www.jmueller.de  
**Location:** North of Germany.  
**Equipment & Capacity:**  
Discharging: 20,000 mtpd  
Loading: 10,000 mtpd  
**Bulk Berths:** Max draught inward  
bound: 12.2m  
Max draught outward bound: 11.9m  
**Total Covered Storage:** 512,000  
mt silo and flat storage (for Agri  
Products)  
60,000 sqm for pulp and paper  
Crushing, drying, aspiration  
available. 4 self service truck  
loadingsystems. Certified: GMP  
B2, B3, B4, Q+S, Oco-VO 834/  
2007. AEO Certificate, IFS  
Certificate. ISO 14001  
(Environmental Management) and  
ISO 50001 (Energy Management)

**BRAKE**  
**Niedersachsen Ports GmbH**  
**& Co. KG**  
PO Box 1262  
Brommstraße 2  
Brake  
26919  
Germany  
**Contact:** Mr Harald Ludwig, Branch  
Manager  
T: + 49 4401 9250  
F: + 49 4401 3272  
E: brake@nports.de  
W: www.nports.de  
**Location:** German Bight, River  
Weser  
**Equipment & Capacity:** 4  
Overhead cranes up to 80t, 2 luffing  
job cranes up to 25t, 2 mobile  
harbour cranes up to 140t, 1  
material handling machines, 2  
vacuum conveying systems 800tph,  
3 ship loaders up to 1000t.  
**Bulk Berths:** 8 bulk berth up to  
11,90 m draught  
**Total Uncovered Storage:**  
122,000sqm  
**Total Covered Storage:**  
211,000sqm

**BREMEN**  
**Weserport GmbH**  
Huettenstrasse 20  
Bremen  
28237  
Germany  
**Contact:** Mr Dieter Kopp, Sales/Key  
Account Manager  
T: + 49 421 64 301 89  
F: + 49 421 64 301 64  
E: dkopp@weserport.de  
W: www.weserport.de  
**Location:** German Bight, at River  
Weser.  
**Equipment & Capacity:** 9  
Shorecranes fitted for bulk and  
breakbulk cargo, heavylifts up to  
100ts  
**Bulk Berths:** 1,85km berths, max.  
draught 10,50m  
**Total Uncovered Storage:** 300,000  
sqm  
**Total Covered Storage:** 35,000  
sqm  
Further services like stevedoring,  
agency, chartering of deepsea  
vessels and river barges are offered  
out of one hand.

**BREMERHAVEN**  
**bremenports GmbH & Co.**  
**KG**  
Am Strom 2  
Bremerhaven  
27570  
Germany  
**Contact:** Mr Ronald Schwarze,  
Marketing  
T: + 49 421 30901 612  
F: + 49 421 30901 624  
E: ronald.schwarze@  
bremenports.de  
W: www.bremenports.de  
**Location:** The Ports of Bremen and  
Bremerhaven, Northern Germany

**BRUNSBÜTTEL**  
**Brunsbüttel Ports GmbH**  
Elbehafen  
Brunsbüttel  
Schleswig-Holstein  
D-25541  
Germany  
**Contact:** Mr Frank Schnabel,  
Managing Director  
T: + 49 4852 884 35  
F: + 49 4852 884 26  
E: f.schnabel@schrammgroup.de  
W: www.schrammgroup.de  
**Location:** At the lower Elbe and at  
the Kiel-Canal, direct access to  
North and Baltic Sea  
**Equipment & Capacity:** 4 cranes  
up to 120 t, 2 Oil-fueling devices,  
etc.  
**Bulk Berths:** Vessel length up to  
350m, Vessel width up to 55m,  
draught limits dry cargo pier 14.8m  
**Total Uncovered Storage:**  
483,900sqm  
**Total Covered Storage:** 27,900sqm  
Brunsbüttel Ports GmbH is the  
owner of three ports at Brunsbüttel,  
Elbehafen Oilport and Port of  
Ostermoor

**DUISBURG**  
**Duisburger Hafen AG**  
Alte Ruhrorter Straße 42 - 52  
Duisburg  
47119  
Germany  
**Contact:** Mr Wilhelm Klumper,  
T: + 49 203 803 4465  
F: + 49 203 803 4409  
E: wilhelm.klumper@duisport.de  
W: www.duisport.de  
**Location:** North Rhine-Westphalia,  
in the western part of the Ruhr  
district.  
**Equipment & Capacity:** 1.350 ha  
area  
200 km of track  
9 container terminals with 15 gantry  
cranes

130 cranes up to 500 t lifting  
capacity  
2 Ro/Ro facilities  
**Bulk Berths:** 21 port basins, 5  
import coal terminals  
10 Dry Bulk Terminals  
**Total Covered Storage:** 2 Mio.  
Duisburger Hafen AG is the holding  
and management company of the  
Port of Duisburg, the largest inland  
port in the world.

**DUISBURG**  
**Rhenus AG & Co. KG**  
August-Hirsch-Strasse 3  
Duisburg  
North Rhine-Westphalia  
47119  
Germany  
**Contact:** Mr Stefan Schwarzkopf,  
T: + 49 203 8009 317  
F: + 49 203 8009 263  
E: stefan.schwarzkopf@  
de.rhenus.com  
W: www.rhenus.com

**EMDEN**  
**Emden Port Authority**  
Niedersächsisches Hafenannt  
Emden  
Friedrich Naumann Strasse 7-9  
Emden  
26725  
Germany  
**Contact:** Mr Frederick Voss,  
Marketing department  
T: + 49 4921 51770  
F: + 49 4921 979 860  
E: fvoss@ports.de  
W: www.seaport-dmden.de

**EMDEN**  
**EVAG Emden Verkehrs und**  
**Automotive**  
Gesellschaft mbH  
Schweckendieckplatz 1  
Emden  
Lower Saxony  
26721  
Germany  
**Contact:** Mr Torsten Meinke, Area  
Manager  
T: + 49 4921 895 150  
F: + 49 4921 895 1510  
E: torsten.meinke@evag.com  
W: www.evag.com  
**Location:** North-West Germany /  
River Ems (North-Sea)  
**Equipment & Capacity:** 3/Cranes  
Dischrate 10-15,000 tpd  
Crane reach 34m  
Airdraught 14m  
**Bulk Berths:** Length : 300m -  
EVAG controlled berth  
Draught alongside berth approx.  
10.5m - 11m  
Limited by lock dims of 260 x 40m  
max experienced sizes: 242 x  
32.4m (loa/beam)  
max inward draught 34-35'  
max outward draught 33-34'  
**Total Uncovered Storage:** About  
8,500sqm  
**Total Covered Storage:** On request  
(occupied at present)  
Port Operator: Niedersachsen Ports  
GmbH Co KG Emden  
Direct access to Railway/Highway

**FLensburg**  
**Flensburg Port Authority**  
Stadwerke Flensburg GmbH, Abt  
Hafenbetrieb  
PO Box 2751  
Flensburg  
24917  
Germany  
**Contact:** Mr Frank Partik, Harbour  
Master  
T: + 49 461 487 1505  
F: + 49 461 487 1699  
E: frank.partik@flensburghafen.de



**HAMBURG**

**Buss Group GmbH & Co. KG**

Am Sandtorkai 48  
Hamburg  
20457  
Germany  
**Contact:** Dr Johann Killinger, Managing Partner  
**T:** + 49 40 3198-0  
**F:** + 49 40 31 98 20 00  
**E:** j.killinger@buss-group.de  
**W:** www.buss-group.de  
**Location:** Port of Hamburg  
**Equipment & Capacity:** - 1 double boom crane with capacity of 40t, outreach max. 50 m, grab operation 16t  
- 1 crane with capacity of 45 t, outreach max. 50 m, grab operation 16t  
- 2 single boom cranes with capacity of 8t, outreach max. 36 m  
- 1 mobile crane with capacity of 140t, outreach max. 51 m, grab operation 30t  
Discharge rate 15 t/day.  
2 double-link level luffing slew cranes (40-45t lifting capacity).  
2 single-link level luffing slew cranes (8t lifting capacity).  
**Bulk Berths:** Draught 11.5m, Main berth 380m  
**Total Uncovered Storage:** 215,000 sqm  
**Total Covered Storage:** 65,000 sqm  
The terminal has direct connections to the goods station Hamburg-Süd and to the BAB 1 und BAB 7 motorways.

**HAMBURG**

**BUSS Ross Terminal GmbH & Co KG**

Am Travehafen / Schuppen 80-82  
Hamburg  
20457  
Germany  
**Contact:** Mr Heinz J Wasser, MD  
**T:** + 49 40 751 93 3500  
**F:** + 49 40 751 93 3100  
**E:** h.wasser@buss-group.de  
**W:** www.buss-group.de  
**Location:** Port of Hamburg  
**Equipment & Capacity:** 1x 104t mobile crane, various grabs. Discharge rate 8,000 - 10,000 tpd.  
**Bulk Berths:** Main berth 230m. Draught 11.5m.  
**Total Uncovered Storage:** Terminal area: 50,000 sqm  
Direct connections to the BAB1 and BAB7 motorways.

**HAMBURG**

**Diamant Mühle Hamburg GmbH**

Trettaustrasse 49  
Hamburg  
21107  
Germany  
**Contact:** Ms Gusco, Marketing Department  
**T:** + 49 40 75 109 01  
**F:** + 49 40 75 109 131  
**E:** info@diamant-mehl.de  
**W:** www.diamant-mehl.de  
**Location:** Hamburg, Germany  
**Equipment & Capacity:** 1 floating pontoon. 10m floating pontoon. 1 suction tube. 100tph for grain.  
**Bulk Berths:** Max Depth 5m. Grain discharge only.

**HAMBURG**

**Eichholtz GmbH**

Rossweg 20  
Hamburg  
20457  
Germany  
**T:** + 49 40 741 39 00 0  
**F:** + 49 40 741 39 00 21  
**E:** info@eichholtz.de

**W:** www.eichholtz.de

**Location:** Rosshafen/Hachmannkai, Port of Hamburg  
**Equipment & Capacity:** Mobile cranes.  
**Bulk Berths:** 3 berths. Quay length 440m. Max Depth 11m.  
**Total Covered Storage:** 165,000sqm warehouse, of which 100,000sqm in the Free Port

**HAMBURG**

**GTH - Getreide Terminal Hamburg (GmbH & Co.KG)**

Eversween 11  
Hamburg  
D-21107  
Germany  
**Contact:** Mr Kay Boehmer,  
**T:** + 49 40 75106 121  
**F:** + 49 40 75106 133  
**E:** k.boehmer@getreide-terminal.de  
**W:** www.getreide-terminal.de  
**Location:** Port of Hamburg  
**Equipment & Capacity:** Discharge rate 1,000t/h.  
2 loading systems with up to 22,000t/day capacity.  
**Bulk Berths:** Draught 12.4m. Length 270m.  
**Total Covered Storage:** Two warehouses capable of holding 35,000 tons of heavy grain.  
Eleven silo complexes that can hold a total of 220,000 tons, divided up into 550 cells with a capacity of between 60 and 3,000 tons.  
Drying, cleaning, cooling fumigation, customs clearance, sample check etc

**HAMBURG**

**H J M (H Jürgen Müller GmbH)**

1 Hafenstrasse 12-14  
Hamburg  
21079  
Germany  
**T:** + 49 40 725 86 90  
**F:** + 49 40 725 86 929  
**E:** info@hjm-hamburg.de  
**W:** www.hjm-hamburg.de  
**Location:** Seehafen 1, Port of Hamburg  
**Equipment & Capacity:** 3 track-bound cranes, 2 mobile cranes, 4 silo hoppers.  
**Bulk Berths:** 2 berths. Quay length 250m. Max Depth 6.6m plus height of tide about 3.5m.  
**Total Uncovered Storage:** 20,000sqm  
**Total Covered Storage:** 3 enclosed silos of 32,500m3 total.

**HAMBURG**

**HaBeMa Futtermittel GmbH & Co KG**

Pollhornweg 25  
Hamburg  
D - 21107  
Germany  
**T:** + 49 040 752705 0  
**F:** + 49 40 75 27 05 33  
**E:** kontakt@habema.com  
**W:** www.habema.com  
**Location:** Reiherstieg-Süd, Port of Hamburg.  
**Equipment & Capacity:** Travelling crane, bridge slew crane, shiploader.  
Discharge capacity up to 10,000t/day.  
Loading capacity up to 15,000t/day.  
**Bulk Berths:** 2 berths. Quay length 330m, Max depth 12m.  
**Total Covered Storage:** 61,000sqm warehouse space for approx. 150,000t of cargo.  
Rail connection to freight railway station Hohe Schaar, grain and animal feed loading for standard sea containers.

**HAMBURG**

**Hamburg Port Authority**

Neuer Wandrahm 4  
Hamburg  
D - 20457  
Germany  
**Contact:** Mr Wolfgang Hurtienne, Head of Port Planning Division  
**T:** + 49 40 4 2847 2311  
**F:** + 49 40 4 2847 2499  
**E:** wolfgang.hurtienne@hpa.hamburg.de  
**W:** www.hpa.hamburg.de

**HAMBURG**

**Hamburg Süd**

Willy-Brandt-Straße 59-61  
Hamburg  
20457  
Germany  
**Contact:** Mr Christin Terjung-Fehlant,  
**T:** + 49 40 3705 2958  
**E:** svenja.struve@hamburgsud.com  
**W:** www.hamburgsud.com

**HAMBURG**

**HANSAPORT**

Hafenbetriebsgesellschaft mbH  
Am Sandauhafen 20  
Hamburg  
21129  
Germany  
**Contact:** Mr Erhard Meller,  
**T:** + 49 40 74003 201  
**F:** + 49 40 74003 222  
**E:** info@hansaport.de  
**W:** www.hansaport.de  
**Location:** Port of Hamburg  
**Equipment & Capacity:** 4x discharge bridges each with 38t lifting capacity.  
Handling capacity 15,000,000tpa  
**Bulk Berths:** 3 berths. Draught 15.1m. Length 760m for large vessels, 240m for small vessels.  
**Total Uncovered Storage:** 350,000 sqm  
Rail connection with 15 tracks for block trains.

**HAMBURG**

**K+S Terminal (Kalikai)**

K+S Transport GmbH  
Blumensand 27  
Hamburg  
D-21107  
Germany  
**T:** + 49 40 75275 0  
**F:** + 49 40 75275 122  
**E:** kalitransport@k-plus-s.com  
**W:** www.kalitransport.com  
**Location:** Port of Hamburg  
**Equipment & Capacity:** 1x grabs (12 mt).  
3x Shiploaders.  
Loading rate 2,000/3,000 mt/hour  
**Bulk Berths:** Main berth 500m. Draught 11.00m  
**Total Covered Storage:** Total storage 405,000mt in 12 sheds and 7 silos.

**HAMBURG**

**Kali- Transport Gesellschaft GmbH**

Glockengießerberwall 3  
Hamburg  
20095  
Germany  
**Contact:** Mr Frank Firmkes,  
**T:** + 49 40 30906 0  
**F:** + 49 40 30906 113  
**E:** frank.firmkes@k-plus-s.com

**HAMBURG**

**Louis Hagel (GmbH & Co. KG)**

Eversween 19  
Hamburg  
Hamburg  
21107  
Germany  
**Contact:** Mrs Sandra Reidock,

**T:** + 49 40 751651  
**F:** + 49 40 7533440  
**E:** info@louis-hagel.com  
**W:** www.louis-hagel.com  
**Location:** Port of Hamburg  
**Equipment & Capacity:** One 12t crane, one dry bulk loader (600-800t/h), three warehouses with several boxes, three truck loading facilities, a company owned railroad track  
**Bulk Berths:** The constant water-depth of 11 m (tide independent) allows loading and unloading of vessels with a breadth up to 25m and a loading tonnage of approximately 30,000t.  
**Total Covered Storage:** 6.400 m², 36.000t  
The Hagel bulk terminal with a high-tech loader and a brand-new grab-crane and combined storage capacities guarantees a quick and flexible handling of vessels up to 30,000 tons.

**HAMBURG**

**Mittal Steel Hamburg GmbH**

Dradenaustr. 33  
Hamburg  
21129  
Germany  
**Contact:** Ms Stephanie Tremblay,  
**T:** + 49 40 74 080  
**F:** + 49 40 74 01432  
**E:** stephanie.tremblay@arcelormittal.com  
**W:** www.mittalsteel.com  
**Location:** Dradenauhafen, Port of Hamburg  
**Equipment & Capacity:** 1 level luffing crane 12.5t, 1 crane bridge 25t, 1 mobile grabber.  
**Bulk Berths:** Quay length 460m, Max Depth 12.5m  
Company terminal, rail connection.

**HAMBURG**

**NHG - Neuhof Hafengesellschaft mbH**

Köhlbrandstraße 3  
Hamburg  
D-21107  
Germany  
**Contact:** Mrs Kleinschmidt,  
**T:** + 49 40 752 7070  
**F:** + 49 40 752 2512  
**E:** info@neuhof-hafen.de  
**W:** www.neuhof-hafen.de  
**Location:** Port of Hamburg  
**Equipment & Capacity:** 3 elevator systems of which, 1 mechanical discharge tower - 1,000tph, 2 pneumatic elevators - 350tph each, 1 loading-discharge tower - 250tph, 1 loader 1,200tph.  
Approx capacity 2.5 million tpa  
**Bulk Berths:** 4 berths, Draught 12.4m  
Length 175m / 110m  
**Total Covered Storage:** 180,000 tonnes  
Rail connection, truck dispatch.

**HAMBURG**

**OAM Baustoffe GmbH**

Kirchenpauerkai 29  
Hamburg  
20457  
Germany  
**T:** + 49 40 81 97 870  
**F:** + 49 40 81 97 8720  
**E:** info@oam-bau.de  
**W:** www.oam-bau.de  
**Location:** Afrika-Terminal, Port of Hamburg.  
**Equipment & Capacity:** Inland-waterways vessels, barges, grabbers, Panamax. 2 million tonnes capacity.  
**Bulk Berths:** 4 berths. Quay length 100m. Max Depth 10.5m  
Quay facility with parallel rail siding, warehouse capacity.

**HAMBURG**

**Port of Hamburg Marketing Association**

Pickhuben 6  
5th Floor  
Hamburg  
D-20457  
Germany  
**Contact:** Mr Bengt van Beuningen, Director Communications  
**T:** + 49 40 3770 9110  
**F:** + 49 40 3770 9199  
**E:** vanbeuningen@hafen-hamburg.de  
**W:** www.hafen-hamburg.de  
**Location:** Universal port Hamburg located in northern Germany  
Information about the different bulk terminals under <https://www.hafen-hamburg.de/en/portlog>

**HAMBURG**

**Silo P. Kruse Betriebs-GmbH & Co. KG**

Blumensand 31 - 33  
Hamburg  
D - 21107  
Germany  
**Contact:** Mrs Kleinschmidt, Management  
**T:** + 49 40 75206 0  
**F:** + 49 40 75206 206  
**E:** info@silo-p-kruse.de  
**W:** www.silo-p-kruse.de  
**Location:** Port of Hamburg  
**Equipment & Capacity:** 2 pneumatic systems, 1 travelling crane bridge. Handling capacity approx. 1,000tph.  
**Bulk Berths:** 2 berths. Draught 12.5m. Length 275m  
**Total Covered Storage:** 80,000 tons in 200 silo compartments (ranging from 100 to 7,000 tons)  
Drying, cleaning

**HAMBURG**

**Wilhelm Mulch GmbH & Co KG**

Ziadenellenstrasse 8  
Hamburg  
21079  
Germany  
**Contact:** Mr Beyer,  
**T:** + 49 40 77 14 41  
**F:** + 49 40 77 40 94  
**E:** beyer@mulch-umschlag.de  
**W:** www.mulch-umschlag.de  
**Location:** Port of Hamburg, Germany.  
**Equipment & Capacity:** 2 handling cranes with calibrated electro-mechanical grabber weighing system, product-specific grabbers for a range of bulk/general cargo.  
**Bulk Berths:** Quay length 156m  
**Total Uncovered Storage:** 8,000sqm of reinforced, enclosed open storage  
Rail connection.

**ITZEHOE**

**Itzehoe Port Authority**

Stadwerke Itzehoe  
Gasstrasse 18  
Itzehoe  
25524  
Germany  
**Contact:** Mr Lausecker, Harbour Master  
**T:** + 49 4821 774409  
**F:** + 49 4821 774417  
**E:** info@stadwerke-itzehoe.de  
**W:** www.stadwerke-itzehoe.de

**KIEL**

**Port of Kiel**

Schwedenkai 1  
Kiel  
24103  
Germany  
**Contact:** Dr Timo Rosenberg, Marketing Director  
**T:** + 49 431 9822 141

**E:** trosenberg@portofkiel.com

**W:** www.portofkiel.com  
**Location:** Baltic Sea Port at the entrance to the Kiel-Canal  
**Equipment & Capacity:** RoRo and LoLo handling

**KREFELD**

**Krefeld Port Authority**

Oberstrasse 13  
Krefeld  
Uerdingen  
D-47829  
Germany  
**Contact:** Mrs Elizabeth Lehnen,  
**T:** + 49 2151 49270  
**F:** + 49 2151 492750  
**E:** hafen-und-bahnbetriebe@krefeld.de

**LEER**

**Rhenus AG & Co. KG**

Hafenstrasse 14  
Leer  
26789  
Germany  
**Contact:** Mr Heiner Voskuhl,  
**T:** + 49 491 92512 29  
**F:** + 49 491 92512 66  
**E:** heiner.voskuhl@de.rhenus.com  
**W:** www.rhenus.com  
**Location:** North West Germany  
**Equipment & Capacity:** 25,000 storage area  
**Bulk Berths:** Up to 5.3m draught seaport  
**Total Uncovered Storage:** 25,000sqm  
**Total Covered Storage:** 7,000sqm  
Trimodal terminal

**NEUSS**

**Neuss Port Authority**

Städtische Hafenbetriebe Neuss  
Hammer Landstrasse 3  
Neuss  
41460  
Germany  
**Contact:** Mr Scheffer, Harbour Master  
**T:** + 49 2131 53 230  
**F:** + 49 2131 5323105  
**E:** info@nd-haefen.de

**NORDENHAM**

**Rhenus Midgard GmbH & Co. KG**

Midgardstr. 50  
Nordenham  
26954  
Germany  
**Contact:** Mr Norbert Schrewe,  
**T:** + 49 4731 81 222  
**F:** + 49 4731 81 228  
**E:** cargo@de.rhenus.com  
**W:** www.rhenus.com  
**Location:** Nordenham, on the mouth of the River Weser (Germany)  
Well connected to the hinterland by barge and rail;  
The Rhenus Group operates barges and rail and offers the whole logistics to final destinations.

**NUREMBERG**

**Hafen Nürnberg-Roth GmbH**

Rottendamer Str 2  
Nuremberg  
Bavaria  
90451  
Germany  
**Contact:** Mr Harald Leupold, Managing Director  
**T:** + 49 911 6429 418  
**F:** + 49 911 6429 410  
**E:** h.leupold@gvz-hafen.com  
**W:** www.gvz-hafen.com  
**Location:** South Germany  
**Equipment & Capacity:** More than 11 Mill. tons cargo turn over p.y.  
**Total Uncovered Storage:** 3,370,000sqm  
260 companies located with more

than 5,500 employees, multimodal gateway for South-East-Europe.

## OLDENBURG

### Seaports of Niedersachsen GmbH

Hindenburgstrasse 28  
Oldenburg  
Niedersachsen D-26122  
Germany  
**Contact:** Ms Inke Onnen-Lübben, Managing Director  
T: + 49 441 361 88888  
F: + 49 441 361 88889  
E: onnen-luebben@seaports.de  
W: www.seaports.de

**Location:** Geographical prime location in Germany, directly on the estuaries of the large waterways in the German Bight and adjacent to the Kiel Canal.  
Seaports of Niedersachsen GmbH represents nine seaports with numerous port handling operators, trans-regionally active logistical networks and specialists for every type of cargo and port service.

## ROSTOCK

### Bulk Terminal Rostock GmbH

Liebherrstraße 3  
Rostock  
D-18147  
Germany  
**Contact:** Mr Günter Fett, Managing Director  
T: + 49 381 6662 120  
F: + 49 381 6662 575  
E: guenter.fett@portofrostock.de  
W: www.portofrostock.de

## ROSTOCK

### Getreide Service Rostock GmbH

Am Getreidehafen 3  
Rostock  
D-18147  
Germany  
**Contact:** Mr Karsten Lentz, Managing Director  
T: + 49 381 6662 580  
F: + 49 381 6662 505  
E: karsten.lentz@portofrostock.de  
W: www.portofrostock.de  
**Location:** Baltic Sea  
**Equipment & Capacity:** Loading/unloading cap. 300-1000 tph  
**Total Covered Storage:** Silos 360.000 t

## ROSTOCK

### Seehafen Rostock Umschlagsgesellschaft mbH

Am Hansakai 14  
Rostock  
18147  
Germany  
**Contact:** Mrs Monica Muller, Assistant  
T: + 49 381 6662101  
F: + 49 381 6662 205  
E: info@portofrostock.de  
W: www.portofrostock.de

## STRALSUND

### Port of Stralsund

Stralsunder Hafen und Lagerhaus  
Hafenstrasse 20  
Stralsund  
18439  
Germany  
**Contact:** Mr Wolfgang Ostenberg, Port Manager  
T: + 49 3831 25420  
F: + 49 3831 254297  
E: ostenberg@seehafen-stralsund.de

## WILHELMSHAVEN

### Rhenus Midgard Wilhelmshaven GmbH & Co.

## KG

Lüneburger Str. 6  
Wilhelmshaven  
Lower Saxony  
26384  
Germany  
**Contact:** Mr Jürgen Kleemeyer, Coal Logistics Projects / Marketing & Sales  
T: + 49 4421 936 135  
F: + 49 4421 936 104  
E: juergen.kleemeyer@de.rhenus.com  
W: www.rhenus.com  
**Location:** Port of Wilhelmshaven, Jade Bay (Germany)  
**Equipment & Capacity:** Discharging rate 25,000tpd  
**Bulk Berths:** BTW (Bulk Terminal Wilhelmshaven) draught 18.5m (60') sw  
**Total Uncovered Storage:** 120,000sqm  
BTW is fully developed for fully loaded Capesize with a draught up to 18.50m sw, discharging rate > 50,000tpd, 10 M tpa coal, 1.0 M t stockpile (extension for 3.0 M t) etc.

## GHANA

### TAKORADI

#### Ghana Ports & Harbours Authority

PO Box 708  
Takoradi  
Ghana  
**Contact:** Mr Nester P Galley, Director of Port  
T: + 233 312 4073  
F: + 233 312 2814  
E: takoradi@ghanaports.gov.gh  
W: www.ghanaports.gov.gh/

### TAKORADI

#### Takoradi Port Authority

Ghana Ports Authority  
PO Box 708  
Takoradi  
Ghana  
**Contact:** Mr J E Quanash, Port Manager  
T: + 233 31 24073  
F: + 233 31 22814  
E: takoradi@ghanaports.net  
W: www.ghanaports.gov.gh

## TEMA

### Tema Port

Valco Private Berth  
c/o Ghana Ports Authority  
PO Box 488  
Tema  
Ghana  
**Contact:** Mr I Carson, Port Services Director  
T: + 233 221 204136 8  
F: + 233 31 22814  
E: tema@ghanaports.net  
W: www.ghanaports.gov.gh

## GREECE

### ALEXANDROUPOLIS

#### Alexandroupolis Port Authority

Alexandroupolis  
68100  
Greece  
**Contact:** Mr N Papanikolopoulos, Harbour Master  
T: + 30 255 102 6468  
F: + 30 255 102 1430  
E: alex@ygen.gr

## ALIVERI

### Mylaki Port Authority

c/o Milaki Shipping Agency Ltd  
18 A Nikka Street  
Aliveri  
345 00  
Greece

## ATTICA

### Milaki Port-East Mediterranean Coal Terminal

49-51 Sof Venizelou Str  
Lykovissi  
Attica  
14123  
Greece  
**Contact:** Mr Andrew Healey, General Manager  
T: + 30 1 2898 111  
F: + 30 1 2840 021

## CHALKIS

### Chalkis Port Authority

1 Athinon Avenue  
Chalkis  
34100  
Greece  
**Contact:** Mr George Papanicolaou, Harbour Master  
T: + 30 222 102 8888  
F: + 30 222 108 8888  
E: halk@ygen.gr

## CHANIA CRETE

### Suda Bay Port

c/o Port Authority of Chania  
21 Akti Tompazi  
Chania Crete  
Greece  
T: + 30 282 10 98888  
F: + 30 282 10 28387

## CORFU

### Corfu Port Authority

Xen Stratigou 2  
Corfu  
Greece  
T: +30 266 103 2655  
F: +30 266 103 9918

## ITEA

### Itea Port Authority

Itea Harbour  
Akti Poseidonos & 1, Iroon Str. 332  
Itea  
Greece  
**Contact:** Port Master  
T: + 30 266 503 2319  
F: + 30 226 503 2100

## KALAMATA

### Kalamata Port Authority

Harbour Office  
Kalamata  
24101  
Greece  
**Contact:** Executive Director  
T: + 30 272 102 2218  
F: + 30 272 109 6880

## MILOS ISLAND

### Milos Island Port Authority

Adhamas Harbour  
Milos Island  
84800  
Greece  
**Contact:** Port Authority Employees,  
T: +30 22870 22100 / 1/ 23360  
F: + 30 22870 22100  
E: milos@hcg.gr

## NISSYROS

### Yali Island Port Authority

Port of Nissyros Island  
Nissyros Island  
Greece  
**Contact:** Mr Boutsis Evangelos, Harbour Master  
T: + 30 224 203 1222  
F: + 30 224 203 1426

## PIRAEUS

### Piraeus Port Authority

10 Atiki Miaouli

## PIRAEUS

18538  
Greece  
**Contact:** Mr George Anoneripis, President / CEO  
T: + 30 210 4550229  
F: + 30 210 4550310  
E: prol@olp.gr  
W: www.olp.gr

## PYLOS

### Pylos Port Authority

Harbour Office  
Pylos  
24001  
Greece  
**Contact:** Mr T Kakalis, Harbour Master  
T: + 30 272 302 2225  
F: + 30 272 302 2007  
E: pylo@ygen.gr

## THESSALONIKI

### Thessaloniki Port Authority SA

1st Pier  
Port of Thessaloniki  
Thessaloniki  
Central Macedonia  
54110  
Greece  
**Contact:** Mr Stylianos Aggeloudis, Chairman & CEO  
T: + 30 2310 593 105  
F: + 30 2310 510 500  
E: secretariat@thpa.gr  
W: www.thpa.gr  
**Location:** Mediterranean Sea, Northern part of the Aegean Sea  
**Equipment & Capacity:** 44 quay sea to shore gantry cranes 3-40 tonnes lifting capacity  
**Bulk Berths:** 14 berths, total length 3650m, draught 10-12m  
**Total Uncovered Storage:** 500,000sqm  
**Total Covered Storage:** 100,000sqm

## GUADELOUPE

### POINT A PITRE

#### Pointe-a-Pitre Port

Guadeloupe Port Authority  
PO Box 485  
Point A Pitre  
Cedex 97165  
Guadeloupe  
**Contact:** Mr Bernard Le Gall, Harbour Master  
T: + 590 590 686 320  
F: + 590 590 686 301  
E: b-legal@port-guadeloupe.com  
W: www.port-guadeloupe.com

## GUAM

### PITI

#### Apra Harbour

Port Authority of Guam  
Suite 201  
1026 Cabras Highway  
Piti  
96925  
Guam  
**Contact:** Mrs Mary C. Torres, Port General Manager  
T: + 671 477 5831  
F: + 671 477 4445  
E: webmaster@portguam.com  
W: www.portguam.com/  
**Location:** Western Pacific Region  
**Equipment & Capacity:** Tractor-31; Toploader-4; Sideloaders-4; 40 ft. Shoreside Gantry-5; 20 ton Forklift-2; 10 ton Forklift-4; 3 ton Forklift-1; 5 ton Forklift-9; 150 ton Mobile Harbor Crane-1; R.T.G.'s-2  
**Bulk Berths:** 3 containers; 2 general cargo; access to 2 big tanker fuel piers  
**Total Uncovered Storage:** 33

## ACRES

### Total Covered Storage: 86,000 sq. ft.

The Port of Guam is currently undergoing a \$200 million modernization program to upgrade its facility.

## GUYANA

### GEORGETOWN

#### Georgetown Port Authority

Transport and Harbours Department  
Battery Road and Fort Street  
Kingston  
Georgetown  
Guyana  
**Contact:** Mr William Joseph, General Manager  
T: + 592 225 9350  
F: + 592 227 8545  
E: gns@guayana.net.gy  
W: www.gnsc.com

## KINGSTON

### Linden Port Authority

Transport and Harbours Department  
Battery Road  
Kingston  
Georgetown  
Guyana  
**Contact:** Mr I English, General Manager  
T: + 592 2 59350  
F: + 592 2 78545  
E: gns@guayana.net.gy  
W: www.gnsc.com

## KINGSTON

### New Amsterdam Port Authority

c/o Transport and Harbours Department  
Battery Road  
Kingston  
Georgetown  
Guyana  
**Contact:** Mr I English, General Manager  
T: + 592 2 67842  
F: + 592 2 78545  
E: gns@guayana.net.gy  
W: www.gnsc.com

## HAITI

### PORT AU PRINCE

#### Port Au Prince Port Authority

National Port Authority  
PO Box 616  
Port Au Prince  
Haiti  
**Contact:** Mr J B Vital, Port Master  
T: + 509 223 2440  
F: + 509 221 3479  
E: apnpap@apn.gov.ht  
W: www.apn.gov.ht

## HONDURAS

### PUERTO CORTES

#### Terminales de Cortes, S.A de C.V.

Bo. El Centro 2 av. 1-2 st.  
Apartado Postal 298  
Puerto Cortes  
11111  
Honduras  
**Contact:** Mr Francisco Laylle, General Manager  
T: + 504 2665 3040  
F: + 504 2665 1104  
E: gmanager@termisa.com  
W: www.termisa.com  
**Location:** Puerto Cortes (Caribbean sea), San Lorenzo (Pacific Ocean)  
**Equipment & Capacity:** Bulk discharge with clamshells and hoppers, we can discharge 3 handysize vessel at same time.

## Average discharge rate for bulk is 1500 MT/WWD per workable hold with dedicated crane

### Bulk Berths: Berth #3 draft: 34ft; Berth #4 draft: 28ft

**Total Uncovered Storage:** No uncovered storage inside the port

## PUERTO CORTÉS

### National Port Company

Barrio EL Centro  
1 ave  
1 calle  
Puerto Cortés  
Nº. 18  
Honduras  
**Contact:** Mr José Manuel Arriaga Yacamán, General Manager  
T: + 504 665 0987  
F: + 504 665 1402  
E: gerencia@emp.hn

## PUERTO CORTÉS

### Puerto Cortes Port Authority

Empresa Nacional Portuaria  
PO Box 18  
Puerto Cortés  
Honduras  
**Contact:** Sr Fernando E Alvarez L., Assistant General Manager  
T: + 504 665-0987  
F: + 504 665-1402  
E: gerencia@emp.hn

## ICELAND

### GRUNDARTANGI

#### Grundartangi Port

c/o Icelandic Alloys Ltd  
Skilmannahreppur, 301 Akranes  
Grundartangi  
Iceland  
**Contact:** Mr Smali, Transport Manager  
T: + 354 432 0390  
F: + 354 432 0101  
E: smali@klafi.is

## HAFNARFJORDUR

### Port of Hafnarfjordur

Öseyrarbraut 4  
Hafnarfjordur  
Iceland  
**Contact:** Mr Kristinn Aadnegard, Harbour Master  
T: + 354 414 2300  
0  
F: + 354 414 2301  
E: port@hafnarfjordur.is  
W: www.hafnarfjardarhofn.is  
**Location:** South West Iceland, 10 km. south of Reykjavik, Iceland's Capital

## RAOHUSINU

### Vestmannaeyjar Port Authority

Hanvarstjorn Vestmannaeyjar  
Raohusinu  
Vestmannaeyjar  
900  
Iceland  
**Contact:** Mr S Olafsson,  
T: + 354 481 1207  
F: + 354 481 3115  
E: olisnorra@vestmannaeyjar.is

## REYKJAVIK

### Associated Icelandic Ports

Hafnarhusioi/Tryggvagotgi 17  
Reykjavik  
121  
Iceland  
**Contact:** Mr Gisli Gislason, Port Director  
T: + 354 525 8900  
F: + 354 525 8990  
E: gislig@faxi.is  
W: www.faxaports.is



INDIA

ADYAR

Subarnarekha Port Private Ltd

New No.84, Old No.50 "Dakshin", 1st Ave, Indranagar Adyar Chennai 600020 India

Contact: Mr Ramani Ramaswamy, Joint Managing Director T: + 914424431900 F: + 91442607368 - Ext 18 E: subarnarekha.port@gmail.com W: www.creativeports.com

BHAVNAGAR GUJARAT

Bhavnagar Port Authority

Gujarat Maritime Board New Port Bhavnagar Bhavnagar Gujarat 364005 India

Contact: Port Officer T: + 91 2712 38346 F: + 91 2712 34703 E: gmbad1@sanchamnet.in

BHUBANESWAR

DPCL - Dhamra Port Company Limited

Fortune Towers, 2nd floor Chandrasekharpur Bhubaneswar Orissa 751 023 India

Contact: Mr Santosh Mohapatra, Chief Executive Officer T: + 91 674-2303829 F: + 91 674-2303828 E: ceo@dhamraport.com W: www.dhamraport.com

CALCUTTA

Calcutta Port Trust

15 Strand Road Calcutta 700 001 India

Contact: Captain Akbagchi, Director Marine Department T: + 91 33 2230 3451 F: + 91 33 2230 3214 E: calport@vsnl.com W: www.portofcalcutta.com

CALICUT

Calicut Port Authority

Port Officer Calicut PO Box 1108 Kerala 673 032 Calicut 673032 India

Contact: Capt AK Bagchi, Director of Marine Department T: +91 495 274604 F: + 91 495 274604 E: portsdirector@asianet.in

CHENNAI

Ennore Port Limited

No.23, First Floor, P.T. Lee Chengalvaraya Naicker Maaligai Rajaji Salai, Chennai 600 001 India

Contact: Mr Shri S. Velumani, Chairman T: + 91 44 25251666 / 1 F: + 91 44 25251665 E: svm@epil.gov.in W: www.ennoreport.gov.in

CHENNAI

Karaikal Port Private Limited

4th Floor, MARG Panchar

Block B, No. 334, Futura IT Park Rajiv Gandhi Salai (OMR) Sholinganallur Chennai Tamil Nadu 600119 India

Contact: Mr N Suresh, Senior VP, Business Development T: + 91 44 4562 4000 F: + 91 44 4562 4617 E: business@karaikalport.com W: www.karaikalport.com

Location: 300 kms south of Chennai on the Tamil Nadu coast

Equipment & Capacity: 3 MHC with 35 cbm grabs, 105 tonnes each Bulk Berths: 2 Capesize berths, 2 panamax size berths and 1 for smaller vessels up to 30,000dwt. Total Uncovered Storage: 450,000sqm Total Covered Storage: 63,000sqm - Multi Cargo Port. - Handles Gearless Panamax vessels. - Good connectivity through rail & road. - Handled Over 15 MMT of cargo so far. - Achieved good discharge rates. - No berthing delays. - Port capacity 50 MMT by 2016. - Great potential for port based industries available near the port.

CHENNAI

Port of Chennai

Rajaji Salai Chennai 600 001 India

Contact: Marketing Manager T: + 91 253 6111 39 ext 2505 F: + 91 253 602 78 E: info@chennaiport.gov.in W: www.chennaiport.com

CHENNAI

Sical Logistics Limited

4th Floor, Spic House 88 Mount Road Guindy Chennai 600 032 India

Contact: Mr K Sridhar, T: + 91 44 42118611 F: + 91 44 42118620 E: information@sical.com W: www.sical.com

CHURCHGATE

Yogaytan Ports Pvt. Ltd.

4, Vaswani Mansions, 120, Dinsha Vaccha Road Churchgate Mumbai 400020 India

Contact: Mr Hariharadas Raj, Sr. Executive T: + 91 22-2288 0000 F: + 91 22-2204 0000 E: info@yogayatgroup.com W: www.yogayatgroup.com/

COCHIN

Cochin Port Trust

Willingdon Island Cochin Kerala State 682 009 India

Contact: Mr Jimmy George, Traffic Manager T: + 91 484 266 6418 F: + 91 484 266 6418 E: tm@cochinport.gov.in W: www.cochinport.gov.in

Location: On the western coast of India towards Southwest 930km south of Mumbai and 320km north of Kanyakumari Latitude: 09°-57'-45" North Longitude: 76°-08'-59" East

Equipment & Capacity: Mobile Harbour Crane(MHC)-1 no. of 40T cap. Fork Lift Trucks-22nos. of 3T cap.(includes 2 new Komatsu made) New Reach stacker-2 no. of 45T cap.

Bulk Berths: Dedicated berth for FACT Ltd. with Grab unloader and mechanical conveyor for handling Fertiliser raw material Total Uncovered Storage: 3 lakh sqm at wharves. Vast open area available outside the wharves also. Total Covered Storage: 30,000sqm All weather port. Walk-in berthing. Deep draught. Road and rail connectivity to national grid.

DEVANAMPATTINAM

Cuddalore Port Authority

Tamilnadu Port Department Marine House Beach Road Devanampattinam Tamil Nadu 605 003 India

Contact: Mr S Sainath, Port Officer T: + 91 4142 2025

DIST. NELLORE

Krishnapatnam Port Company Limited

P.O. Bag No. 1 Muthukur Dist. Nellore Andhra Pradesh 524 344 India

Contact: Mr Johnson Martis, Manager Brand Communications T: + 91 22 2551 8865 E: customerservice@krishnapatnamport.com W: www.krishnapatnamport.com

Location: -> 14° 15' N latitude, 80° 08' E longitude. -> 180 km north of Chennai. -> Located in Nellore (District HQ of Andhra Pradesh), on National Highway 5 (Chennai-Kolkata).

-> 26 km from Venkatachalam, the nearest rail head on the Chennai-Kolkata main line. -> Vast hinterland covering Southern Andhra Pradesh, Districts of Rayalseema, North Tamil Nadu and Eastern Karnataka.

Equipment & Capacity: -> 13 shore cranes (90 Liebherr, 4 Gottwald, 1 Sennebogen) with a capacity of 750 to 1,000 Mtpch per crane -> Dedicated port-owned cargo-handling equipment - tippers, loaders, excavators and dozers -> 5 locomotives for rake movements -> 23 weighbridges. Bulk Berths: -> 11 multi-purpose berths (8 at north side, 2 at south side, 1 at west side) -> 18m draught; deepest port in India. -> Dedicated Project Cargo berth with 12 MT per CBM

Total Uncovered Storage: 6,500 acres Total Covered Storage: 1.75 Lakh Sq. Meters warehouse storage space with 16 nos of warehouse. -> All weather port with 24 x 7 operations, all throughout the year -> Deep draught capable of handling Capesize vessels up to 18m draught -> High load & discharge rates leading to faster turnaround of vessels -> Strategically located port in terms of road / rail distances -> Port provides single window clearance system for port users from stevedoring to custom

documentation without the inconvenience of multiple interfaces (CHA, Stevedores, Customs, Port) -> KPCL is now certified to the ISO 9001, ISO 14001, OHSAS 18001 and ISO 28000 management system standards by DNV

GANDHINAGAR

Gujarat Maritime Board

GMB Head Quarters Sector 10-A, Opp. Air Force Station Gandhinagar Gujarat 382 010 India

Contact: Shri H K Dash, CEO T: + 91 79 232 383 46 F: + 91 79 232 347 03 E: gmbad1@sanchamnet.in W: www.gmbports.org

GOA

Mormugao Port Trust

Headland Sada Goa 403804 India

Contact: Mr KC Kuncheria, Traffic Manager/Chief Mechanical Engineer T: + 91 0832 2521170 F: + 91 0832 2521175 E: cme@mptgoa.com W: www.mptgoa.com

Location: West Coast of India

Equipment & Capacity: Mechanical Ore Handling Plant with a loading capacity of 8,000 tph Bulk Berths: 2 no. Multipurpose General Cargo Berths 1 no. Iron Ore handling berth. 2 no. Coal/Coke handling berths operated on BOOT basis. Total Uncovered Storage: 3.25 lakh sqm Total Covered Storage: 41562 sqm. Besides Mechanical Ore Handling Plant, Iron Ore is also handled in mid stream by transhippers, floating cranes, ship's own gears and at Mooring Dolphins.

GUJARAT

Dahej Port Authority

Gujarat Maritime Board Sector 10-A, Opp. Air Force Station Gandhinagar Gujarat 382 010 India

Contact: Mr M S Sulochana Ghosh, RIC T: + 91 079 2323 8346 F: + 91 079 2323 4703 E: gmbad1@sanchamnet.in W: www.gmbports.org

GUJARAT

Kandla Port Trust

PO Box 50 Gandhidham Kutch Gujarat 370 201 India

Contact: Mr K.L. Bhowmick, Chief of Port Operations T: + 91 2836 239055 F: + 91 2836 239055 E: bdc@kandlaport.com W: www.kandlaport.com

HALDIA

TM International Logistics Ltd.

Finger Jetty Road Chiranjibpur Haldia East Midnapore(WB) 721604 India

Contact: Mr K.L. Bhowmick, Chief of Port Operations T: + 91 3224 252150 E: kb\_hal@tmlltd.com W: www.tmlltd.com/

HYDERABAD

Gangavaram Port Limited

Hansa Crest, 1st Floor Plot No.62, Road No.1 Jubilee Hills Hyderabad Andhra Pradesh 500 033 India

Contact: Mr Sanjay Gupta, Director - Commercial T: + 91 40 4434 9999 F: + 91 40 4434 9990 E: sgupta@gangavaram.com W: www.gangavaram.com

KARNATAKA STATE

Karwar Port Authority

clo Tata Marine Agencies The Director of Ports & IWT Uttar Kannada District Karnataka State Karwar 581302 India

Contact: Port Officer T: + 91 8382-21494 F: + 91 8382 21488 E: directorate@sanchamnet.in

KARNATAKA STATE

New Mangalore Port Trust

Panamburg Karnataka State Mangalore 575 010 India

Contact: Mr Shri P C Parida, Chairman T: + 91 824 240 7300 F: + 91 824 240 8390 E: nmptchairman@sify.com W: www.newmangalore-port.com

KOLKATA

Riverine Group

5 A, N. C. DUTTA SARANI 3rd Floor Kolkata West Bengal 700001 India

Contact: Mr Shrey Tayal, Director T: + 91 33 4005 4949 F: + 91 33 4005 4909 E: shreytaylor@riverinegroup.co.in W: www.riverine-group.com

KOLKATA

TM International Logistics Limited

subsidiary of TATA Steel TATA Centre 14th Floor 43 Jawaharlal Nehru Road Kolkata 70071 India

Contact: Mr M S Sulochana Ghosh, RIC T: + 91 33 2300 9003 F: + 91 33 2288 3011 E: gsulochana@tatasteel.com

MINAPORE

Haldia Port Authority

Calcutta Port Trust Haldia Dock Complex Jawahar Tower Annexe Minapore 721 607 India

Contact: Mr Rajeev Dube, General Manager-Operations T: + 91 3224 263 209 F: + 91 3224 6310 0151 E: haldia.dock@nic.in W: www.kolkataporttrust.gov.in

MUMBAI

Bombay Port Trust

Shoorji Vallabhdas Marg Ballard Estate Mumbai

400038

India

Contact: Shri V. R. Joglekar, Chief Public Relations Officer T: + 91 22 261 4321 F: + 91 22 261 1011 E: pro@mptmail.com W: http://mumbaiport.gov.in/ Equipment & Capacity: LOA 110, beam: 32, dwt: 12,500 tonnes. Two heavy-duty cranes, discharging boom, hoppers, conveyor system on board, discharging rate 18,000 tonnes per day.

MUMBAI

Essar Ports Ltd.

6th Floor, Essar House 11 K. K. Marg, Opp. Race Course Mumbai Mahalaxmi 400034 India

Contact: Captain Tej Nargundkar, CEO Essar Ports, Mozambique T: + 91 9811 9730 172 F: + 91 226 6601 390 E: tej.nargundkar@essar.com W: www.essar.com

MUMBAI

J.M. Baxi & Co

Sapt Building 2nd Floor 18 J.N. Heredia Marg Ballard Estate Mumbai 400 001 India

Contact: Mr John C. Alexander, Senior VP Business Development T: + 91 22 2270 3779 / 82 F: + 91 22 2210 3629 E: jca@jmbaxi.com W: www.jmbaxi.com

MUMBAI

Seacrest Marine Services Pvt. Ltd.

201, Remi Biz Court A Wing Plot - 9, Shah Industrial Estate, Veera Desai Road, Andheri (w) Mumbai 400053 India

Contact: Captain Sanjay Kumar, T: + 91 22 27 566 813 F: + 91 22 27 566 815 E: operations@crestsea.com W: www.crestsea.net

MUMBAI

Skil Infrastructure Ltd

Skil House 209 Bank Street Cross Lane, Fort Mumbai 400023 India

Contact: Mr Nikhil Gandhi, Group Chairman T: + 91 22 66199163 F: + 91 22 2269023 E: excellentindia@gmail.com W: www.pipavav.com

MUNDRA

Adani Ports and Special Economic Zone Limited

Navinal Island Mundra 370421 India

Contact: Mr Sadhu Ravindra, Engineering Services T: +91-9687639233 E: ravindra.sadhu@mndraport.com W: www.portofmundra.com

## NAGAPATTINAM

**Nagapattinam Port Authority**  
Port Office  
PO Box No 6  
Nagapattinam  
Tamil Nadu State  
611 001  
India  
**Contact:** Captain M Anbarasan,  
Port Captain  
T: + 91 4356 242255  
F: + 91 4365 242363

## NUNGAMBAKKAM

**International Seaports (India)**  
**Pvt Ltd**  
East India Chambers, 3rd Floor  
3 Village Road  
Nungambakkam  
Chennai  
600 034  
India  
**Contact:** Vice President  
T: + 91 44 2 8238804  
F: + 91 44 2 8238809  
E: info@ispl.co.in

## ORISSA

**Paradip Port Trust**  
PO Paradip Port  
District Jagatsinghpur  
Orissa  
754 142  
India  
**Contact:** Mr SS Mishra, Chairman  
T: +91 672222 046 /127  
F: + 91 6722 22256

E: chmpt@paradipport.gov.in  
W: www.paradipport.gov.in/  
**Location:** East Coast of India  
**Equipment & Capacity:** Capacity:  
108.5 Million tpa  
2x Wharf cranes capacity 20.00T  
**Bulk Berths:** 2x Fertiliser Berths:  
max draught 12.5m, quay length  
250m, max 60,000-65,000dwt  
2x Coal Berths: max draught 14m,  
quay length 520m, max 60,000-  
80,000dwt  
Multipurpose Berth: max draught  
12.5m, quay length 235m, max  
40,000-60,000dwt  
**Total Uncovered Storage:**  
2,128,865 qm inside port,  
69,500sqm outside port  
**Total Covered Storage:** 1,400sqm  
inside port, 7,700sqm outside port

## PORBANDER

**Porbandar Port Authority**  
Bandar Road  
Porbandar  
Gujarat State  
360 575  
India  
**Contact:** Port Director  
T: + 91 286 20147  
F: + 91 286 44013  
E: gmbad1@sanchamnet.in  
W: www.gmbports.org

## PORT OKHA

**Port Okha Port Authority**  
Port Officer  
Gujarat Maritime Board  
Port Okha  
Gujarat State  
India  
**Contact:** Captain G.G Panday, Port  
Officer  
T: + 91 2892 262 001  
F: + 91 2892 262 002  
E: gmbad1@sanchamnet.in  
W: www.gmbports.org

## TUTICORIN

**Tuticorin Port Trust**  
Tuticorin  
Tamil Nadu  
628 004  
India  
**Contact:** Mr N K Raghupathy IAS,  
Chairman  
T: + 91 461 235 2290

F: + 91 461 235 2031  
E: info@tuticorinport.gov.in  
W: tuticorinport.gov.in/  
**Location:** Located in the Gulf of  
Mannar. Latitude: 8° 45' North.  
Longitude: 78° 13' East on the east  
coast of India  
**Equipment & Capacity:** VOC I & II;  
800,000tpa, AB I & II; 890,000tpa,  
VIII BERTH; 1,280,000tpa  
**Bulk Berths:** VOC I & II; 9.3m  
draught each, 25,000dwt and  
40,000dwt, AB I & II; 8.6m & 9.3m  
draught, 40,000dwt, VIII BERTH;  
10.8m draught, 65,000dwt  
**Total Uncovered Storage:**  
60,000sqm + 5 hectares  
**Total Covered Storage:** 10,800sqm

## VISAKHAPATNAM

**Port of Visakhapatnam**  
Visakhapatnam  
Andhra Pradesh  
530-035  
India  
**Contact:** Mr Ajeya Kallam,  
Chairman  
T: + 91 891 256 2758  
F: + 91 891 256 5023  
E: info@vizagport.com  
W: www.vizagport.com

## INDONESIA

### BANDAR LAMPUNG

**PT. Bukit Asam (Persero)**  
Tbk  
Jl. Soekarno Hatta Km. 15  
Tarahan  
Bandar Lampung  
DKI Jakarta  
Indonesia  
**Contact:** Mr Edy Purwanto, Senior  
Manager Marketing  
T: + 62 21 525 4014  
F: + 62 21 525 3992  
E: epurwanto@bukitasam.co.id  
W: www.ptba.co.id

### BANJARMASIN

**Port of Banjarmasin**  
PT (Persero) Pelabuhan Indonesia  
III Banjarmasin  
Jl Barito Hilir No 6  
Banjarmasin  
70117  
Indonesia  
**Contact:** Mr Anton Tri Agung,  
Shipping Superintendent  
T: + 62 51 153 670  
F: + 62 51 152 552  
E: inaport3@pp3.co.id  
W: www.pp3.co.id

### BITTUNG

**Port of Bitung**  
Bitung Port Administration  
Indonesian Port Corp IV  
Jl DS Sumolang No 1  
Bitung  
95522  
Indonesia  
**Contact:** Mr Soedaryono, Manager  
T: + 62 43 821196  
F: + 62 43 821380

### CILACAP

**Cilacap**  
Port Administrator  
Jalan Niaga  
Cilacap  
Indonesia  
**Contact:** Port Director  
F: + 62 282 34217

### CILEGON

**PT Krakatau Bandar Samudera**  
J.L. May. Jend S. Parman  
Km. 13  
Cigading  
Ciwandan

Cilegon  
Banten  
42447  
Indonesia  
**Contact:** Mr Zamhari Hamid,  
Comercial Director  
T: + 62 254 311182 / 0  
F: + 62 254 311178  
E: azhar@cigadingport.com  
W: www.cigadingport.com

### IRIAN JAYA

**Amamapare**  
Freeport Indonesia Inc  
Irian Jaya  
Indonesia  
**Contact:** Mr S Rizal,  
T: + 62 967 34018

### JAKARTA

**Balikkapan Coal Terminal**  
PT Bayan Resources  
Office 8 Building 29th Floor  
Sudirman Central Business District  
(SCBD) Lot 28  
Jl. Jendral Sudirman Kav. 52-53  
Jakarta  
12190  
Indonesia  
**Contact:** Mr David Low Yi Ngo,  
Director Sales & Marketing  
T: + 62 21 29356888  
F: + 62 21 29356999  
E: enquiry@bayan.com.sg  
W: www.bayan.com.sg/

### JAKARTA

**Gebe Island**  
c/o PT Pelayaran Bahtera Adhiguna  
10-12 Jl Kalibesar Timur  
PO Box 1315  
Jakarta  
Indonesia  
**Contact:** Port Director  
T: + 62 21 691 2547  
F: + 62 21 690 1450

### JAKARTA

**North Pulau Laut Coal Terminal**  
PT Arutmin Indonesia  
Mid Plaza 2, 9th Floor  
Jalan Jenderal Sudirman Kav. 10-11  
Jakarta  
10220  
Indonesia  
T: + 62 21 5720012  
F: + 62 21 5741689  
E: marketing@arutmin.com  
W: www.arutmin.com

### JAKARTA

**P T Indominco Mandiri**  
Ventura Building  
8th Floor  
J1 RA Kartini No 26 Cilandak  
Jakarta 12430  
Indonesia  
**Contact:** Mr Suriya, President  
Director  
T: + 62 021 750 8376  
F: + 62 021 750 8380  
E: dharmasubur@cbn.net.id

### JAKARTA

**PT Indonesia Bulk Terminal**  
Jl. HR Rasuna Said  
Blok X-5, Kav. 1-2  
Menara Karya, 23rd Floor  
Jakarta  
12950  
Indonesia  
**Contact:** Mr Bram Surjadi,  
Marketing  
T: + 62 21 5211 265 / + 62 21  
25533000 ext 3244  
F: + 62 21 522 4341  
E: marketing@ibt.co.id  
W: www.ptibt.com  
**Location:** South Kalimantan,  
Indonesia  
**Equipment & Capacity:** 2  
discharging wharfs - 1500tph rate, 2

shiploaders - 3000 tph rate.  
12 m tonnes annual throughput  
capacity  
**Bulk Berths:** Max vessel size  
80,000dwt, max LOA 230m, max  
beam 36m, max draught 14.5m, 1  
berth, 280m wharf length  
**Total Uncovered Storage:** 8  
stockpiles, total capacity 800,000  
tonnes  
Please see our website  
www.ptibt.com

### JAKARTA

**PT Miang Besar Coal Terminal**  
Ventura Building  
5th Floor Suite 503  
Jl. R. A. Kartini No. 26  
Cilandak Barat  
Jakarta  
12430  
Indonesia  
**Contact:** Mr Jim Dracopoulos,  
Commercial and Marketing  
T: + 62 21 765 2544  
F: + 62 21 765 2627  
E: jdrao@mbct.co.id  
W: www.mbct.co.id

### JAKARTA

**Pt. Pulau Laut**  
Jl. Raya Pelabuhan No.41  
Tanjung Priok  
Jakarta  
14310  
Indonesia  
**Contact:** Mr Djoko (Tommy)  
Oetomo, President Director  
T: + 62 21 494 769  
F: + 62 21 430 0922

### JAKARTA

**PT. Terminal Batubara Indah**  
World Trade Centre, 07th floor  
Jl. Jend. Sudirman Kav. 29-31  
Jakarta  
12920  
Indonesia  
**Contact:** Mrs Lilly,  
T: + 62 21 5712579  
F: + 62 21 571 2597  
W: www.ptbti.co.id

### JAKARTA

**Pulau Laut**  
World Trade Centre 7 Floor  
JL Send  
Surdiman Kav 31  
Jakarta  
12920  
Indonesia  
**Contact:** Mr B T Kuan, General  
Manager  
T: + 62 21 522 9250  
F: + 52 21 522 4341

### JAKARTA

**Tanjung Priok**  
PT (Persero) Pelabuhan Indonesia  
II  
Jalan Raya Pelabuhan No 9  
Tanjung Priok  
Jakarta  
14310  
Indonesia  
**Contact:** Mrs Lani, Port Manager  
T: + 62 21 430 1080  
F: + 62 21 437 2933  
E: priok@inaport2.co.id  
W: www.priokport.co.id

### KIJANG

**Port of Kijang**  
c/o PT Aneka Tambang  
Unit-pertambangan Bauksit  
Kijang  
Tanjung Pinang  
Indonesia  
**Contact:** Port Director  
T: + 62 622 21177  
F: + 62 622 61561

## KOTABARU

**PT Indonesia Bulk Terminal**  
Pulau Laut Coal Terminal  
PO Box. 118 Kalsel  
Kotabaru  
Kalimantan Selatan  
72111  
Indonesia  
**Contact:** Mr Wan Yazid, Terminal  
Manager  
T: + 62 5183 8800  
F: + 62 5183 8822  
E: marketing@ibt.co.id  
W: www.ptibt.com  
**Location:** Pulau Laut on the  
Kalimantan Selatan  
**Equipment & Capacity:** Unloading  
Barges and Loading Vessels,  
3,000tph  
10,000,000tpa of coal handled.  
**Total Uncovered Storage:** 120  
hectare  
**Total Covered Storage:** 60 hectare

## LAMPUNG

**Pelabuhan Panjang**  
Dit Jen Perhubungan Laut  
Pelabuhan Panjang  
Lampung  
Indonesia  
**Contact:** Mr Prayitno, Port  
Manager  
T: + 62 721 31098  
F: + 62 721 33237

## LHOKSEUMAWE

**Port of Lhokseumawe**  
Ji Pelabuhan Lama 3  
Lhokseumawe  
Aceh  
Indonesia  
**Contact:** Mr M Sandi, Port Manager  
T: + 62 645 43485  
F: + 62 645 43485

## PADANG

**Port of Teluk Bayur**  
Jl Semarang No 3  
Teluk Bayur  
Padang  
25217  
Indonesia  
**Contact:** Mr Sarwediona, Port  
Manager  
T: + 62 751 61646  
F: + 62 781 61169  
E: corp\_sec@inaport2.co.id  
W: www.telukbayurport.com

## PADANG

**Teluk Bayur Coal Terminal**  
PT Tambang Batubara Bukit Asam  
(PTBA)  
Jl Tanjung Priok  
No 01 Teluk Bayur  
Padang  
West Sumatra  
Indonesia  
**Contact:** Mr Muztavi Sjab, Taluk  
Bayur Coal Terminal Manager  
T: + 62 734 4510 96  
F: + 62 21 525 4002  
E: corsec@bukitasam.co.id  
W: www.ptba.co.id

## PALEMBANG

**Kertapati Coal Terminal**  
PT Tambang Batubara Bukit Asam  
(PTBA)  
Jl Stasiun Kerata Api  
Palembang  
South Sumatra  
Indonesia  
**Contact:** Mr Dadan Ruswandana,  
Coal Terminal Manager  
T: + 62 711 512 617  
F: + 62 711 511 388  
W: www.bukitasam.co.id

## PALEMBANG

**Port Authority Palembang**  
Jl. Blihyu nomor 1  
Boom Baru

Palembang  
South Sumatera  
30115  
Indonesia  
**Contact:** Mr Housan,  
T: + 62 711 710611 / +62  
8159946494  
F: + 62 711 711758  
E: datin@palembangport.com  
W: www.palembangport.com  
**Location:** Latitude 02° - 58' - 48" S.  
Longitude 104° - 46' - 36" E.  
**Bulk Berths:** Max LOA 151m.  
Max Length: 475m  
**Total Uncovered Storage:** Boom  
Baru: 8,173 sqm  
Sungai Lais: 16,700 sqm  
**Total Covered Storage:** Boom  
Baru - Warehouse: 9,785 sqm  
Sungai Lais - Shed: 230 sqm

## SABANG

**Port of Sabang**  
Sabang Port Administration Office  
Dit Jen Perhubungan Laut  
Cabang Sabang  
Sabang  
Aceh  
Indonesia  
**Contact:** Operations Manager  
T: + 62 652 21207  
E: humas@tps.co.id  
W: www.tps.co.id

## SURABAYA

**Surabaya Port Authority**  
Jalan Tanjung Perak  
Timur 610  
Surabaya  
Indonesia  
**Contact:** Mr Mrfugand Briyanpo,  
Manager  
T: + 62 31 3291364  
F: + 62 31 313835  
E: humas@tps.co.id  
W: www.tps.co.id/

## TANJUNG PRIOK

**Bogasari Flour Mills Terminal**  
Tanjung Priok  
Indonesia  
**Contact:** Mr Joko,  
T: + 62 31 329 3082  
F: + 62 31 329 1843  
E: lagansa@bogasariflour.com  
W: www.bogasariflour.com

## IRAN

### TEHRAN

**Bandar Abbas Port Authority**  
Ports and Shipping Organisation  
751 Enghelab Avenue  
Tehran  
15994  
Iran  
**Contact:** Mr Sarwediona, Port  
Manager  
T: + 62 751 33533  
F: + 62 751 33569

### TEHRAN

**Chah Bandar Port Authority**  
Ports and Shipping Organisation  
751 Enghelab Avenue  
Tehran  
15994  
Iran  
**Contact:** Mr M R Ghaderi, Director  
General-Maritime Affairs  
T: + 98 21 880 9280  
F: + 98 21 880 9324

### TEHRAN

**Khorramshar Port Authority**  
Ports and Shipping Organisation  
751 Enghelab Avenue  
Tehran  
15994  
Iran  
**Contact:** Mr Mohammad Hossein



Alaee, Public Relations Manager  
 T: + 98 21 880 9280  
 F: + 98 21 880 9324  
 E: m\_alaae@khmail.ir  
 W: www.khport.ir

**IRELAND**

**ARKLOW**

**Arklow Port Authority**  
 Harbour Office  
 South Quay  
 Arklow  
 Ireland  
**Contact:** Mr Tommy Myler, Harbour Master  
 T: + 353 402 32466  
 F: + 353 402 31068  
 E: gavin@arklowporharbour.com

**CORK**

**Port of Cork Company**  
 Custom House Street  
 Cork  
 Munster  
 Ireland  
**Contact:** Mrs Sara Mackeown, Marketing Executive  
 T: + 353 21 427 3125  
 F: + 353 21 427 6484  
 E: smackeown@portofcork.ie  
 W: www.portofcork.ie  
**Location:** South Coast of Ireland  
**Equipment & Capacity:** 2 high output dockside cranes (rated capacity 400 tonnes per hour) and one mobile (rated capacity 600 tonnes per hour)  
**Bulk Berths:** Ringaskiddy Deepwater Berth: Length 485m Depth 13.4m CD  
 South Jetties: Length 411m Depth 8.8m CD

**CORK**

**Ringaskiddy Deepwater Terminal**  
 Port of Cork Company  
 Custom House Street  
 Cork  
 Cork  
 0  
 Ireland  
**Contact:** Mr Sean Geary,  
 T: + 353 21 4273125  
 F: + 353 21 4276484  
 E: info@portofcork.ie  
 W: www.portofcork.ie

**DUBLIN**

**Dublin Port & Docks Board**  
 Port Centre  
 Alexandra Road  
 Dublin  
 Ireland  
 T: + 353 1887 60 00  
 F: + 353 1874 12 41  
 W: www.dublinport.ie

**DUNDALK**

**Dundalk Harbour Commissioners**  
 Harbour Office  
 40 Quay Street  
 Dundalk  
 Co Louth  
 Ireland  
**Contact:** Captain Frank Allen, Harbour Master  
 T: + 353 42 9334096  
 F: + 353 42 35481  
 E: dundalkport@eircom.net

**FOYNES**

**Shannon Foynes Port Company**  
 Harbour Offices  
 Main Street  
 Foynes  
 County Limerick  
 Ireland  
**Contact:** Mr Martin Morrissey,

Commercial Manager  
 T: + 353 69 73100  
 F: + 353 69 65 142  
 E: mmorrissey@sfp.ie  
 W: www.sfp.ie  
**Location:** West Coast of Ireland  
**Equipment & Capacity:** Varies by terminal, see www.sfp.ie  
**Total Uncovered Storage:** Varies by terminal, see www.sfp.ie  
**Total Covered Storage:** Varies by terminal, see www.sfp.ie

**GALWAY**

**Galway Harbour Company**  
 Harbour Office  
 New Docks  
 Galway  
 Ireland  
**Contact:** Captain Brian Sheridan, Harbour Master  
 T: + 353 91 561874  
 F: + 353 91 563738  
 E: info@galwayharbour.com  
 W: www.galwayharbour.com

**KILRUSH**

**Kilrush Port Authority**  
 Kilrush Urban District Council  
 Town Hall  
 Kilrush  
 Co Clare  
 Ireland  
**Contact:** Mr John Corrie, Town Clerk  
 T: + 353 65 905 1047  
 F: + 353 65 905 2821  
 E: kilrush@clarecoco.ie

**KINSALE**

**Cork County Council**  
 Harbour Office  
 Pier Road  
 Kinsale  
 Co Cork  
 Ireland  
**Contact:** Capt. Phil Devitt, Harbour Master/Secretary  
 T: + 353 21 477 2503  
 F: + 353 21 477 4695  
 E: kharbour@iol.ie  
 W: www.kinsaleharbour.com  
**Location:** South Coast of Ireland  
**Equipment & Capacity:** 1 Crane & Bob Cat  
**Bulk Berths:** 84m long (Can handle vessels of 95m long ...up to 4,000 D/W)  
**Total Uncovered Storage:** N/A  
**Total Covered Storage:** N/A  
 Bandon Co-op, Agents, Hauliers and storage facilities (covered of approx. 5,000m<sup>2</sup>)

**KINSALE**

**Henry Good Limited**  
 Waterlands  
 Kinsale  
 Co Cork  
 Ireland  
**Contact:** Mr Roger Dale, Director  
 T: + 353 21 4772300  
 F: + 353 21 4772548

**LOUTH**

**Greenore Port**  
 Greenore Port  
 Louth  
 Leinster  
 Ireland  
**Contact:** Mr Niall McCarthy, General Manager  
 T: + 353 42 93 73170  
 E: niall@greenore.net  
 W: www.greenoreport.ie/  
**Location:** East Coast of Ireland  
**Equipment & Capacity:** Harbour Mobile Cranes max capacity 124T  
**Bulk Berths:** Vessels of 190m LOA, 33m beam, 8m draught  
 External stores available on request

**NEW ROSS**

**New Ross Port Company**  
 Harbour Office  
 The Quay  
 New Ross  
 Co Wexford  
 Ireland  
**Contact:** Captain L J Foley, Harbour Master/CEO  
 T: + 353 5142 1303  
 F: + 353 5142 1294  
 E: ceo@newrossport.iol.ie  
**Location:** South coast Ireland.

**TRALEE**

**Fenit Port Authority**  
 Tralee and Fenit Harbour Commissioners  
 Harbour Offices  
 Fenit  
 Tralee  
 Co Kerry  
 Ireland  
**Contact:** Mr David Buttmer, Port Manager  
 T: + 353 66 36231  
 F: + 353 66 36231  
 E: fenit.harbour@kerrycoco.ie

**TURVEY**

**Moneypoint**  
 Electricity Supply Board  
 Moneypoint Generating Station  
 Unit 19, Turvey Business Centre  
 Turvey  
 County Dublin  
 Ireland  
**Contact:** Mr Paul Dunne,  
 T: + 353 1 8900466  
 F: + 353 1 8900575  
 E: info@moneypoint.ie

**WATERFORD**

**Port of Waterford Company**  
 3rd Floor  
 Marine Point  
 Belview Port  
 Slievue  
 Waterford  
 Munster  
 X91 WDXW  
 Ireland  
**Contact:** Mr Frank Ronan, CEO  
 T: + 353 51 874907  
 F: + 353 51 874908  
 E: fr@portofwaterford.com  
 W: www.portofwaterford.com  
**Location:** South East of Ireland  
**Equipment & Capacity:** 1 x Liebherr 280 Harbour Mobile Crane - 84t lift capacity - 30m3 Grab - 1500tph  
 1 x Liebherr 250 Harbour Mobile Crane - 50t lift capacity - 20m3 Grab - 800tph  
 2 x Liebherr 1081 Harbour mobile Cranes - 32t lift capacity - 12m3 Grab - 600tph  
 400tph pneumatic ship discharge unit  
**Bulk Berths:** 513m of bulk quay  
**Total Uncovered Storage:** Substantial  
**Total Covered Storage:** Substantial

**WICKLOW**

**Wicklow Port Co**  
 Harbour Office  
 North Quay  
 Wicklow  
 Ireland  
**Contact:** Harbour Office,  
 T: + 353 404 67455  
 F: + 353 404 67455  
 E: wicklowport@gmail.com  
**Location:** South East Ireland (Irish Sea)  
**Equipment & Capacity:** All mobile cranes depending on cargo. 150 tonne (plus) per hour on timber.  
**Bulk Berths:** 110 metres length, draught 5.5m. Total of 3 berths.  
**Total Uncovered Storage:** To be advised on request

**Total Covered Storage:** To be advised on request  
 All other cargoes can be accommodated by direct delivery. (Off hook)

**ISRAEL**

**ASHDOD**

**Ashdod Port Co. Ltd**  
 Ports and Railways Authority  
 PO Box 9001  
 Ashdod  
 77191  
 Israel  
**Contact:** Capt Yaakov Tzemach, Harbour Master  
 T: + 972 8 851 7279  
 F: + 972 8 851 7296  
 E: yaakovt@ashdodport.co.il  
 W: www.ashdod.org.il

**ASHKELON**

**The National Coal Supply Corporation (N.C.S.C.)**  
 Ashkelon Coal Terminal  
 Ashkelon  
 Israel  
 T: + 972 3625 7000  
 F: + 972 3625 7001  
 E: ncsc@ncsc.co.il  
 W: www.ncsc.co.il

**EILAT**

**Eilat Port Ltd - Israel**  
 PO Box 37  
 Eilat  
 88100  
 Israel  
**Contact:** Captain Guy Gilron, Harbour Master  
 T: + 972 7 6358341  
 F: + 972 7 63589300  
 E: gilrong@eilatport.co.il  
 W: www.israports.org.il  
**Location:** South Israel  
**Equipment & Capacity:** Shipping & Ports  
**Total Uncovered Storage:** 200,000sqm  
**Total Covered Storage:** 30,000sqm  
 Eilat port is the south entrance to Israel.

**HADERA**

**Port of Hadera**  
 PO Box 314  
 Hadera  
 38102  
 Israel  
**Contact:** Mr Yoram Nachshol, Managing Director  
 T: + 972 4 622 5577  
 F: + 972 4 634 3034

**HADERA**

**The National Coal Supply Corporation Ltd (NCSC)**  
 Hadera Coal Terminal  
 Hadera  
 Israel  
 T: + 972 3625 7000  
 F: + 972 3625 7001  
 E: ncsc@ncsc.co.il  
 W: www.ncsc.co.il

**HAIFA**

**Haifa Grain Terminal**  
 Israel Ports and Railways Authority  
 PO Box 33539  
 Haifa  
 31334  
 Israel  
**Contact:** Mr Mendy Zaltzman, Port Manager  
 T: + 97 24 851 8111  
 F: + 97 24 867 4853

**HAIFA**

**Haifa Port Company Ltd**  
 Haifa Port and Railways Authority  
 PO Box 33539

Haifa  
 31334  
 Israel  
**Contact:** Mr Mendy Zaltzman, Port Manager & Managing Director  
 T: + 972 4 851 8111  
 F: + 972 4 867 4853  
 E: mendy.zaltzman@haifaport.co.il  
 W: www.haifaport.com

**TEL AVIV**

**Israel Ports Company**  
 74 Derech Menachem Begin  
 Tel Aviv  
 67215  
 Israel  
**Contact:** Mr Dov Frohlinger, COO  
 T: + 972 3565 7060  
 F: + 972 3562 2281  
 E: dov@israports.co.il  
 W: www.israports.co.il  
 Government owned company responsible for the management and development of Israel's seaport infrastructure.

**ITALY**

**ANCONA**

**Ancona Coal Terminal**  
 Ancona  
 Italy  
**Contact:** Mr Paolo Galli,  
 T: + 39 071 2071664  
 F: + 39 071 2077736  
 E: operativo@anconamerici.it

**ANCONA**

**Ancona Port Authority**  
 Banchina Nazario Sauro 12  
 Ancona  
 60100  
 Italy  
**Contact:** Mr Plavigi, Port Director  
 T: + 39 071 207891  
 F: + 39 071 2078940  
 E: info@autoritaportuale.ancona.it  
 W: www.autoritaportuale.ancona.it

**BARLETTE**

**Barletta Port Authority**  
 Port Captain  
 1 Campanone  
 Via Colombo 30  
 Barletta  
 70051  
 Italy  
**Contact:** Commandant Carbonara, Port Director  
 T: + 39 088 353 1020  
 F: + 39 088 353 3400  
 E: barletta@guardiacostiera.it

**CAGLIARI**

**Port of Cagliari**  
 Port Captain  
 Cagliari  
 09100  
 Italy  
**Contact:** Mr N Silenti, Operations Director  
 T: + 39 070 679 531  
 F: + 39 070 679 533 45  
 E: autorita.portuale@tiscali.it  
 W: www.porto.cagliari.it

**CHIOGGIA**

**Chioggia Port Authority**  
 Port Captain  
 Piazza Santa Croce 1290  
 Chioggia  
 30015  
 Italy  
**Contact:** Mr R Bamabei, Port Commander  
 T: + 39 041 520 5600  
 F: + 39 041 550 6812  
 E: info@chioggia.evanel.it

**CIVITAVECCHIA**

**Civitavecchia Port Authority**  
 Consorzio Autonomo Pier Di

Civitavecchia  
 Porto di Civitavecchia  
 Civitavecchia  
 00053  
 Italy  
**Contact:** Mr Marinucci, Port Director  
 T: + 39 076 636 6201  
 F: + 39 766 501717  
 E: marinucci@portodocivitavecchia.it  
 W: www.portodiroma.it

**CROTONE**

**Crotone Port Authority**  
 Liga Navale Italiana  
 Port Captain  
 Crotone  
 Italy  
**Contact:** Captain Valentini, Port Captain  
 T: + 39 0962 20721  
 F: + 39 0962 290 2094  
 E: info@portodigiogliatauro.it  
 W: www.portodigiogliatauro.it

**GAETA & CIVITAVECCHIA**

**Intergroup S.r.l.**  
 Lungomare Caboto 110  
 Gaeta & Civitavecchia  
 Rome area  
 04024  
 Italy  
**Contact:** Mr Giovanni Migliaccio, General Manager  
 T: + 39 771 310 077  
 F: + 39 771 472 114  
 E: info@intergroup.it  
 W: www.intergroup.it  
**Location:** Central Italy, port of Romes.  
**Equipment & Capacity:** Gotwald cranes, Terberg tag master, Scania trucks, Caterpillere, inde forklifts, concetti packaging equipment.  
**Bulk Berths:** 12m  
 Services: National and International transport, warehousing, packaging, special cargo handling.

**GELA**

**Gela Port Authority**  
 Gela Ufficio Circondariale Marittimo  
 Street Mare no 156  
 Gela  
 93012  
 Italy  
**Contact:** Mr Com Adrogano, Harbour Master  
 T: + 39 0933 917755  
 F: + 39 0933 913700  
 E: gela@guardiacostiera.it

**GENOVA**

**Port of Genova**  
 Palazzo San Giorgio  
 Via Della Mercanzia 2  
 Genova  
 16123  
 Italy  
**Contact:** Snr Pietro Oddone, Marketing Disector  
 T: + 39 010 241 2793  
 F: + 39 010 241 2309  
 E: p.oddone@porto.genova.it  
 W: www.porto.genova.it

**GENOVA**

**Terminal Rinfuse Genova SpA**  
 Palazzina Uffici  
 Calata Rubattino  
 Genova  
 16126  
 Italy  
**Contact:** Commercial Director  
 T: + 39 010 248 8620  
 E: alessandro.vianello@euroports.it  
 W: www.porto.genova.it

**LA SPEZIA**

**La Spezia Port Authority**  
 Viale Italia 4

La Spezia  
Italy  
**Contact:** Mr Sergio Somaglia,  
Marketing Manager  
T: + 39 0187 546328  
F: + 39 0187 599664  
E: sergio.somaglia@porto.laspezia.it  
W: www.portolaspezia.it

## LIVORNO

**Livorno Port Authority**  
Scali Rosciano 6  
Livorno  
57123  
Italy  
**Contact:** Mr Roberto Lippi, Head of  
Promotions Dept.  
T: + 39 0586 624 9411  
F: + 39 0586 249 515  
E: marketing@porto.livorno.it  
W: www.portauthority.li.it  
**Location:** Central Italy on the west  
coast

**Equipment & Capacity:**  
Multipurpose and container port with  
31 terminals equipped.  
1,600,000sqm of harbour, useable  
land area of 2,500,000sqm,  
11,250m of quays with 97 berths for  
vessel with up to 13 m draughts.  
**Bulk Berths:** Cereals - 340 metres  
quay  
Dry bulk cargo - 450 metres quay  
Forest, Pulp and Paper - 860  
metres quay  
**Total Uncovered Storage:**  
1,000,000 sqm  
**Total Covered Storage:** 70,000  
sqm covered storage facilities  
A Logistic platform ( Interporto  
Vespucci) is 5 km away from the  
port and directly connected with 4  
lane fast road and rail. Total  
uncovered storage of 822,000 sqm,  
total covered storage of  
325,000sqm

## MANFREDONIA

**Manfredonia Port Authority**  
Port Captain  
Piazza Marconi  
Manfredonia  
Italy  
**Contact:** Captain Antonio Vincenzo  
Ranieri, Port Captain  
T: + 390 884 583 871  
F: + 39 0884 587388  
E: manfredonia@guardiacostiera.it

## PALERMO

**Palermo Port Authority**  
Via Paino dell'Ucciardone 4  
Palermo  
90139  
Italy  
**Contact:** Mr Riccardo Damico,  
General Manager  
T: + 39 091 627 7111  
F: + 39 091 637 4291  
E: promocion@autport.pa.it  
W: www.portpalermo.it

## PIAZZALE CABATO

**Gaeta Port Authority**  
Port Captain  
Piazzale Cabato  
Gaeta  
04024  
Italy  
**Contact:** Mr Mario Magliulo, Port  
Director  
T: + 39 0771 460 088  
F: + 39 771 464 724  
E: gaeta@guardiacostiera.it

## PIOMBINO (LI)

**Autorità Portuale di  
Piombino**  
Ente di Diritto Pubblico  
Legge 28 gennaio 1994, n. 84  
Piombino (LI)  
Toscana  
57025  
Italy  
**Contact:** Mr Giampiero Costagli,  
Responsabile Promozione,  
Comunicazione e PR  
T: + 39 0565 229210  
F: + 39 0565 229229  
E: g.costagli@ap.piombinoelba.it  
W: www.porto.piombino.li.it

**Equipment & Capacity:** LOA 110,  
beam: 32, dwt: 12,5000 tonnes.  
Two heavy-duty cranes, discharging  
boom, hoppers, conveyor system on  
board, discharging rate 18,000  
tonnes per day.

## PORTO TORRES

**Porto Torres Port Authority**  
Capitaneria di Porto Torres  
Porto Torres  
Italy  
**Contact:** Mr Luigi Gargiulo, Port  
Captain  
T: + 39 079 502258  
F: + 39 79 502090  
E: info@portodigiorgiauro.it  
W: www.portodigiorgiauro.it

## RAVENNA

**Ravenna Port Authority**  
Via Antico Squero, 31  
Ravenna 48122  
Italy  
**Contact:** Mr Luca Antonellini,  
Planning & Development Dept.  
(Chief)  
T: + 39 0544 608811  
F: + 39 0544 608888  
E: info@port.ravenna.it  
W: www.port.ravenna.it

**Location:** North East of Italy 44°  
29' N 12° 17' East  
**Equipment & Capacity:** Quay  
travelling equipment  
42 cranes, 10 gantry cranes, 4  
portainers, 1 bag chutes, 7 suchers,  
11 others  
**Bulk Berths:** 13,928m quay length  
(port total)  
**Total Uncovered Storage:**  
991,900sqm storage yards (general  
cargo & solid bulk)  
**Total Covered Storage:**  
2,439,750m<sup>3</sup> bulk cargo  
warehouses  
289,900m<sup>3</sup> Silos capacity

## SANT ANTIOCO

**Sant Antioco Port Authority**  
Localita Ponta  
Sant Antioco  
Sardinia  
I-09017  
Italy  
**Contact:** Mr Maurizio Paganini,  
Harbour Master  
T: + 39 078 18 3071  
F: + 39 078 18 3071  
E: compamareaup@interfree.it  
W: www.harbours.net/augusta

## SAVONA

**Autorità Potuata di Savona**  
vai Gramsci  
Savona  
17100  
Italy  
**Contact:** Mr Agostino Ghiglione,  
T: + 39 01982 5541  
F: + 39 01982 7399  
E: authority@porto.sv.it  
W: www.porto.sv.it/english/The-  
Port/Port-s-Ope/Terminals/Rinfuse-  
So/savonasilos.htm\_cvt.htm#

## SAVONA

**Port Authority of Savona**  
Via Gramsci, 14  
Savona  
17100  
Italy  
T: + 39 019 85 541  
F: + 39 019 827399  
E: authority@porto.sv.it  
W: www.porto.sv.it  
**Location:** Northern Italy-Tyrrhenian

Sea  
**Bulk Berths:** Max depth 19.5m:  
Zone 16: length 128m, depth 11m;  
Zone 26, length 393m, depth 15.5m;  
Public Berths; draught 15.5m;  
Zone 29, length 275 m, depth  
19.5m;  
Zone 30, length 175m, depth 15.5m;  
Zone 31, length 162m, depth 15m  
Zone 32, length 260m, depth 15m;  
Zone 14/15, length 292m, depth  
10m  
A number of terminals handling dry  
bulk exist at the Port

## SAVONA

**Terminal Alti Fondali Savona  
S.r.l.**  
Terminal Darsena Alti Fondali 29  
Savona  
17100  
Italy  
**Contact:** Ing. Luca Odero, Direttore  
Terminal  
T: + 39 01981 3072  
F: + 39 019829057  
E: luca.odero@tfs.it

## SICILY

**Siracusa Port Authority**  
Capitaneria di Porto  
Siracuse  
Sicily  
Italy  
T: + 39 93 166 713  
F: + 39 93 169 260  
E: siracusa@guardiacostiera.it

## TORRE ANNUNZIATA

**(NA)  
SOLACEM Spa**  
Molo di Levante - Interno Porto  
Torre Annunziata (NA)  
Naples  
80058  
Italy  
**Contact:** Dr Giuseppe Rocco,  
Managing Director  
T: + 39 081 8621199  
F: + 39 081 8615991  
E: direzione@solacem.it  
W: www.solacem.it

**Location:** South west Italy between  
Naples and Salerno.  
**Equipment & Capacity:** 50 of 40m  
high cylindrical silos  
**Bulk Berths:** 260m for bulk and  
centas for silos and 300m for  
general cargo, roro, breakbulk and  
containers.  
**Total Uncovered Storage:**  
25,000sqm  
**Total Covered Storage:** 55,000  
tons in silos + 6,500sqm in  
warehouse  
Vessel draught will increase to 11m,  
quay length to 100m and a further  
50,000sqm storage will be made  
available. Security is being  
upgraded, new equipment is being  
purchased, and transport links  
between the Port and Naples-  
Salerno motorway will be made up  
a new and direct rail link to the  
national network.

## TRIESTE

**Port of Trieste**  
PO Box 569  
Punto Franco Vecchio  
Trieste  
34100  
Italy  
**Contact:** Mr Franco Giannelli,  
Business Activity Manager  
T: + 39 040 673 2335  
F: + 39 040 673 2406  
E: fgjannelli@porto.trieste.it  
W: www.porto.trieste.it

## TRIESTE

**Trieste Port, Pier 7**  
Coelcerici Logistics

Via Diaz 7  
Trieste  
34121  
Italy  
**Contact:** Mr Giovanni Steccoli,  
T: + 39 010 605 3440  
F: + 39 010 605 3444  
E: info@coelcerici.com  
W: www.coelcerici.com  
**Equipment & Capacity:** Floating  
terminal Bulk Trieste, storage  
capacity 120,000dwt. Four  
Cavaletto systems, each with a  
discharging capacity of 11,000  
tonnes per day. One mobile crane.

## VADO LIGURE (SV)

**Terminal Rinfuse Vado**  
Via Montegrappa 1  
Vado Ligure (SV)  
17047  
Italy  
**Contact:** Mr Vittorio Barzilai,  
Marketing and Sales  
T: + 39 019 216 06253  
F: + 39 019 216 06299  
E: vittorio.barzilai@  
terminalrinfuseitalia.it

## VENEZIA

**T.M.B SRL Venezia**  
Zattere 1401  
Venezia  
I-30123  
Italy  
T: + 39 041 533 4484  
F: + 39 041 533 4570

## VENICE

**Port Authority of Venice**  
Santa Marta - Fabbricatto 13  
Venice  
30123  
Italy  
**Contact:** Mr Antonio Revedin,  
Director  
T: + 39 041 533 4284  
F: + 39 041 533 4254  
E: antonio.revedin@port.venice.it  
W: www.port.venice.it

## VENICE

**Port of Venice Marghera**  
Porto Commerciale Molo B  
Zattere 1401  
Venice 30123  
Italy  
**Contact:** Mr Stefano Bonaldo,  
Statistics  
T: + 39 041 533 4281  
F: + 39 041 533 4577  
E: stefano.bonaldo@port.venice.it  
W: www.port.venice.it

## IVORY COAST

### ABIDJAN

**Port Autonome d'Abidjan**  
PO Box V85  
Abidjan  
Ivory Coast  
**Contact:** Mr Jean-Michel Moulou,  
Managing Director  
T: + 225 21 21 620  
F: + 225 21 24 80 80  
W: www.paa-ci.org/

## JAMAICA

### KINGSTON

**Kingston Port Authority**  
PO Box 116  
NewPort East  
Kingston  
Jamaica  
**Contact:** Mr H C De Lisser, Vice  
President  
T: + 1 876 922 0290  
F: + 1 876 924 9437  
E: hdelisser@portjam.com

### KINGSTON

**Port Authority of Jamaica**  
PO Box 474  
40 Harbour Street  
Kingston  
Jamaica  
**Contact:** Mr Lucian M Rattray,  
T: + 1 876 922 0290  
F: + 1 876 922 6516  
E: paj@portjam.com  
W: www.portjam.com

### KINGSTON

**Port Kaiser**  
Kaiser Terminal  
Port Authority of Jamaica  
15-17 Duke Street, PO Box 116  
Newport East  
Kingston  
Jamaica  
**Contact:** Mr J McFarlane, Port  
Director  
T: + 1 809 922 67 66  
F: + 1 809 922 64 19

### KINGSTON

**Port of Port Rhoades**  
Port Authority of Jamaica  
15-17 Duke Street  
Kingston  
Jamaica  
**Contact:** Operations Manager  
T: + 1 876 922-0290  
F: + 1 876 924-9437  
E: paj@portjam.com  
W: www.portjam.com

### SAINT ANN'S BAY

**Ocho Rios Port**  
Jamaica Bauxite Mines  
Lydford PO  
Saint Ann's Bay  
Jamaica  
**Contact:** Mr Williams, Port  
Manager  
T: + 1 876 974 2603  
F: + 1 876 973 1556  
E: paj@portjam.com  
W: www.portjam.com

### ST CATHERINE

**Port Esquivel**  
c/o WINDALCO (West Indies  
Alumina Company)  
PO Box 2  
Old Harbour  
St Catherine  
Jamaica  
**Contact:** Mr Gilbert Callaghan,  
Director  
T: + 1 876 983 9300  
F: + 1 876 983 2215  
E: gilbert.callaghan@windalco.com  
W: www.portjam.com

**Bulk Berths:** Western Berth: Bulk  
loading Alumina - Max draught  
11.9m.  
Eastern Berth: General Cargo - Max  
draught 11m, wharf length 198.12m.  
Mini Berth: Max draught 5m, length  
70m.

### ST CATHERINE

**West Indies Alumina  
Company**  
Port Esquivel  
PO Box 2  
Old Harbour  
St Catherine  
WI  
Jamaica  
**Contact:** Mr Gilbert Callaghan, Port  
& Railway Operations Manager  
T: + 876 525 2215  
F: + 876 983 2215  
E: gilbert.callaghan@windalco.com  
W: www.windalco.com  
**Location:** West Indies  
**Equipment & Capacity:** 1500  
tonne/hr loading rate  
**Bulk Berths:** Berthing of caustic,  
oil, alumina, ethanol, lime, grain and  
general cargo  
**Total Uncovered Storage:** None

**Total Covered Storage:** 73 MT  
Alumina, 55,000 MT Caustic,  
380,000 bbls Oil

## JAPAN

### AKIGUN

**Port of Mitsukojima**  
Mitsukojima Transshipment Co  
24-1 Tonoko 2-chome, Ono-cho  
Akigun  
Hiroshima Pref  
Japan  
T: + 81 82 3253336

### AKITA CITY

**Port of Akita**  
c/o Akita Kairiku Unso Co Ltd  
5-9, Nishi-2 Chome  
Tsuchizaki-Minato  
Akita City  
011  
Japan  
T: + 81 18 845 2021  
E: agent@kairiku.co.jp  
W: www.kairiku.co.jp  
**Location:** Geographical  
39°46 North / 140°00 East  
**Equipment & Capacity:** One  
unloader (600MT/hr) for Bulk  
Concentrates  
**Bulk Berths:** Gaiko -13M No.1 Pier  
(for Bulk Concentrates)  
Max LOA 200M Max Draft 11.8M  
Nippon Daishowa Itagami Tohoku  
Dolphin (For Woodchip)  
Max LOA 210M Max Draft 10.0M

### ANAN CITY

**Port of Anan**  
Anan Dobuku Office  
Aotani, Tomioka-cho  
Anan City  
Tokushima Prefecture  
Japan  
**Contact:** Mr Hirao Hisao, Director  
General  
T: + 81 886 212580  
F: + 81 886 212874

### AOMORI

**Port of Aomori**  
Aomori Port Admin Office  
5-5, Hon-cho 4 chome  
Aomori  
Japan  
T: + 81 177 344101  
F: + 81 177 344101  
E: kowan@pref.aomori.lg.jp  
W: www.pref.aomori.lg.jp/

### AOMORI

**Port of Hachinohe**  
Hachinohe Port Administration  
Office  
1-131 Kitanuma, Kawaragi  
Hachinohe-Shi  
Aomori  
039-1161  
Japan  
**Contact:** Mr Ishitori Masahiko,  
Director  
T: + 81 178 282105  
F: + 81 178 204746

### CHIBA CITY

**Chiba Port**  
Port & Harbor Division  
Chiba Prefectural Government  
1-1 Ichiba-cho Chou-ku  
Chiba City  
260-8667  
Japan  
**Contact:** Port and Harbour  
Management  
T: + 81 43 223 3835  
F: + 81 43 227 0928  
E: kousin2@mz.pref.chiba.lg.jp  
W: www.pref.chiba.lg.jp/  
kouwan/chibanokouwan  
**Location:** Located in the  
northeastern part of Tokyo Bay and



Japan's largest seaport.  
**Equipment & Capacity:** Public berth: 12m quay until 30,000 DWT Private berth: 19m quay more than 30,000 DWT aside of JFE Steel Company.  
**Bulk Berths:** Public for forest products and private for many kinds of commodities. Only one hour's drive from central of Tokyo

**CHIBA CITY**

**Kisarazu Port**  
 Port & Harbor Division  
 Chiba Prefectural Government  
 1-1 Ichiba-cho Chuoku  
 Chiba City  
 260-8667  
 Japan  
 T: + 81 43 223 3835  
 F: + 81 43 227 0928  
 E: kousin2@mz.pref.chiba.lg.jp  
 W: www.pref.chiba.lg.jp/kouwan/chibanokouwan  
**Location:** Inside Tokyo bay area and stands by the Trans Tokyo Bay bridge

**Equipment & Capacity:** Public berth: 12 m quay until 30,000 DWT Private berth: 19 m quay more than 30,000 DWT  
**Bulk Berths:** Private berth is managed by big steelmaker works (Nippon Steel & Sumitomo Metal) Kisarazu port is appointed one of International Strategic Bulk Port for Iron Ore by Minister of Land & Transportation

**CHIYODA-KU**

**Idemitsu Bulk Terminal-Chiba**  
 c/ Industrial Energy Dpt. Idemitsu Kosan  
 1-1 Marunouchi 3-chome  
 Chiyoda-ku  
 Tokyo  
 100-8321  
 Japan  
**Contact:** Mr T Nio,  
 T: + 81 3 3746 8721  
 F: + 81 3 3746 3645  
 W: www.idemitsu.co.jp

**FUKUOKO CITY**

**Hakata Port & Harbour Bureau**  
 Hakata Port Center Building  
 12-1 Okihama-Machi  
 Hakata-ku  
 Fukuoka City  
 812-8620  
 Japan  
**Contact:** Mr Tsutomu Nomiyama, Director General  
 T: + 81 92 282 7111  
 F: + 81 92 282 7772  
 E: shinko.PHB@city.fukuoka.lg.jp  
 W: http://port-of-hakata.city.fukuoka.lg.jp/english/index.php  
**Location:** North coast of the westernmost island among major islands in Japan  
**Equipment & Capacity:** Unloader 400t/h x 5  
**Bulk Berths:** -12m x 5 berth (1,033m)  
**Total Uncovered Storage:** N/A  
**Total Covered Storage:** 9,000sqm  
 The above-stated facilities are public only and do not include privately-owned facilities.

**HAKODATE**

**Hakodate Port and Airport Department**  
 4-13 Shinonome-cho  
 City of Hakodate  
 Hakodate  
 Hokkaido  
 040-8666  
 Japan  
**Contact:** Ms Yoshie Yorozuya,

Promotion Section Manager  
 T: + 81 138 21 3488  
 F: + 81 138 26 2656  
 E: yorozuya.y@city.hakodate.hokkaido.jp  
 W: www.city.hakodate.hokkaido.jp/harbor/  
**Location:** The southern part of Hokkaido and the southern entrance of Hokkaido.

**Equipment & Capacity:** 1 Jib Crane and 1 reach stacker.  
**Bulk Berths:** Nishi(West) Pier:(-4)312m (-5)140m, (-9)165m, (-6.5)105m  
 Bandai Pier:(-4)67m, (-5.5)90m(-7.5)130m, (-10)185m, (-5.5)90m(-7.5)130m  
 Kita(North) Pier:(-5)130m, (-5.5)88m, (-7.5)130m, (-5.5)330m  
 Chuo(Central) Pier:(-8)133m, (-5.5)130m, (-5.5)90m(-9)165m(-9)165m  
 Minato-cho Pier: (-14)280m, (-12)240m

**Total Uncovered Storage:** Minato-cho Pier: 1.5ha (1.84ha During December to June)  
**Total Covered Storage:** Minato-cho Pier: 0.09ha  
 Reefer plug 220V:2 440V:28  
 Spare:12 Total 40

**HANDA CITY**

**Port of Kinuura**  
 Kinuura Port Authority  
 1-1. 11-Gochi  
 Handa City  
 Aichi Prefecture  
 Japan  
 T: + 81 569 21 2451  
 F: + 81 569 21 2459  
 E: kinuura-komu@pref.aichi.lg.jp  
 W: www.pref.aichi.jp/kensetsu-somu/kinuura-komu/index.html

**HIROSHIMA**

**Fukuyama Port Authority**  
 Port Section of Hiroshima Prefecture  
 Motomashi, 10-52 Naka-ku  
 Hiroshima  
 730  
 Japan  
 T: + 81 849 45 3238  
 F: + 81 849 45 3442

**HIROSHIMA**

**Hiroshima Port Authority**  
 23-53 Ujina Kaigan  
 2-chome, Minami-ku  
 Hiroshima  
 Japan  
**Contact:** Mr M Shimizu, Port Manager  
 T: + 81 82 251 7117  
 F: + 81 82 253 8250  
 E: soukouhou@pref.hiroshima.lg.jp

**HIROSHIMA**

**Kure Port Authority**  
 1-6 Chou, 4-chome  
 Kure City  
 Hiroshima  
 Japan  
**Contact:** Mr Hiroyuki Shindo,  
 T: + 81 823 25 3334  
 F: + 81 823 25 1361  
 E: kureport@alto.ocn.ne.jp

**HIROSHIMA**

**Port of Takehara No 1P/S**  
 3035-13 Nagahama  
 Tadami-cho  
 Takehara-shi  
 Hiroshima  
 729-23  
 Japan  
**Contact:** Captain Yamada,  
 T: + 81 846 27 0211  
 F: + 81 846 24 1506

**IBARAKI**

**Hitachi Port Authority**  
 Hitachi City Office  
 Kuji-Cho 1-3-21  
 Ibaraki  
 Japan  
 T: + 81 294 524 000  
 F: + 81 294 535 337  
 E: kowan5@pref.ibaraki.jp  
 W: www.pref.ibaraki.jp

**IYUMISHIMA CITY**

**Port of Mishima-Kawano**  
 Marine Safety Agency  
 Mishima-Kawano Branch  
 6-45 Kamiya-Cho  
 Iyushima City  
 Ehime Pref  
 799-04  
 Japan  
 T: + 81 89 623 5267  
 E: mtjtm-888s3@pa.skr.mlit.go.jp

**KAGOSHIMA CITY**

**Pacific Grain Terminal**  
 4-20 Nanei  
 Kagoshima City  
 Japan  
**Contact:** Mr Shigeichi Koriyama, Senior MD  
 T: + 81 99 268 8291  
 F: + 81 99 269 5553

**KAGOSHIMA CITY**

**Port of Kagoshima**  
 Kagoshima Port and Harbour  
 Kagoshima Port Operation Office  
 18-16 Izumi-cho  
 Kagoshima City  
 Kagoshima  
 892-0822  
 Japan  
**Contact:** Mr Tatarou Suga, Governor  
 T: + 81 225 956 271  
 F: + 81 225 956 273  
 E: kowan@pref.kagoshima.lg.jp  
 W: www.pref.kagoshima.jp/home/kowan/ka/cruise-net/english/01kagoshima

**KAKOGAWA CITY**

**Higashi-Harima Port Authority**  
 c/o Kakogawa Dabuku  
 Public Works Office Tenjingi  
 Jike-machi  
 Kakogawa City  
 Hyogo Pref  
 Japan  
 T: + 81 78 3417711  
 F: + 81 78 3416477  
 E: wss.kobe@wilhelmsen.com

**KAMISU-CITY**

**Kanto Grain Terminal Co. Ltd**  
 2-3 Higashi Fukashiba  
 Kamisu-City  
 Ibaraki-ken  
 314-0103  
 Japan  
**Contact:** Mr H Omori,  
 T: + 81 299 92 6531  
 F: + 81 299 92 6548  
 E: h.omori@kanto-grain.co.jp  
**Location:** Kamisu-City, Japan.  
**Equipment & Capacity:** 1x Pneumatic unloader - 400tph  
 2x Mechanical unloader - 400tph  
 Chain conveyors & bucket elevators  
 400tph loading into silo via 3 routes,  
 200tph loading out to feed factories and trucks via 8 routes.  
 3x Hoppers 5 Mt loading in  
 9x 2.5 Mt loading out.

**Bulk Berths:** Max length 280m, Max depth 13m, Max DWT 73,000 (Panamax)  
**Total Uncovered Storage:** Site area 29,865sqm  
**Total Covered Storage:** Concrete silo with steel plate lined and steel silo.

135 bins, 176,881t for corn, sorghum, barley etc  
 15 bins, 16,264t for soybean meal etc.

**KANDA-MACHI**

**Kanda Port**  
 Kanda Port Administration Office  
 29 Branch minato-machi  
 Kanda-Machi  
 Fukuoka Pref  
 Japan  
**Contact:** Mr K Yano, General Manager  
 T: + 8193 434 0585  
 F: + 8193 436 2875  
 E: kowan@pref.fukuoka.lg.jp

**KASAOKA CITY**

**Kasaoka Port**  
 Kasaoka Public Works Office  
 2-5 Rokuban-cho  
 Kasaoka City  
 Okayama Pref  
 Japan  
 T: + 81 86 563 5252  
 E: wss.kobe@wilhelmsen.com

**KAWASAKI CITY**

**Port of Kawasaki**  
 Port & Harbour Bureau of Kawasaki  
 1-Miyamoto-cho, Kawasaki-ku  
 Kawasaki City  
 210  
 Japan  
 T: + 81 44 200 2111  
 F: + 81 44 222 0219  
 E: 58yuuti@city.kawasaki.jp

**KITAKYUSHU CITY**

**Kitakyushu Port & Harbour Authority**  
 2-7 Nishi-Kaigan  
 1-chome, Moji-ku  
 Kitakyushu City  
 Fukuoka Pref  
 801-8555  
 Japan  
**Contact:** Mr Tashiro, Marketing  
 T: + 81 93 3215933  
 F: + 81 93 3215915  
 E: kqport@kitaqport.or.jp  
 W: www.kitaqport.or.jp/

**KITAKYUSHU CITY**

**Port of Hibikinae**  
 c/o Kitakyushu Port and Harbour Bureau  
 Nishi-Kaigan 1-2-7 Moji-ku  
 Kitakyushu City  
 Fukuoka Pref  
 801  
 Japan  
 T: + 81 93 321 5941  
 F: + 81 93 321 5933  
 E: wss.tokyo@wilhelmsen.com

**KITAKYUSHU CITY**

**Port of Kokura**  
 c/o Kitakyushu Port & Harbour Bureau  
 2-7 Nishi-Kaigan 1-chome Moji-ku  
 Kitakyushu City  
 Fukuoka Pref  
 801  
 Japan  
**Contact:** Mr Tashiro, Marketing  
 T: + 81 93 321 5941  
 F: + 81 93 321 5915  
 E: kqport@kitaqport.or.jp

**KITAKYUSHU CITY**

**Port of Yawata**  
 Kitakyushu Port and Harbour Bureau  
 2-7 Nishi-Kaigan 1-chome, Moji-ku  
 Kitakyushu City  
 Fukuoka Pref  
 801  
 Japan  
**Contact:** Ms Keiko Katsura, Marketing  
 T: + 81 93 321 5941

F: + 81 93 321 5933  
 E: kqport@kitaqport.or.jp

**KITAKYUSHU CITY**

**Yawata Hibikinada**  
 Port/Harbour Bureau of Kitakushu City  
 2-7 Nishikaigan  
 1-Chrome  
 moji-ku  
 Kitakyushu City  
 801  
 Japan  
 T: + 81 93 331 1331  
 F: + 81 93 321 5915

**KOBE**

**Port Authority of Himeji**  
 Public Works Division  
 Hyogo Prefecture  
 5-10-1 Shimoyamate-dori  
 Chu-ku  
 Kobe  
 Japan  
 T: + 81 78 362 9274  
 F: + 81 78 322 6120  
 E: kouwanaka@pref.hyogo.jp  
 W: www.shikamakaiun.co.jp/ne47.htm

**KOBE**

**Port of Kobe**  
 Port & Harbour Bureau  
 5-1, 6-chome Kano-cho  
 Chou-ku  
 Kobe  
 Hyogo  
 650  
 Japan  
**Contact:** Mr Makato Yoshii, Director General  
 T: + 81 78 331 8181  
 F: + 81 78 322 6120  
 E: info\_kobeport@office.city.kobe.lg.jp  
 W: www.city.kobe.jp/cityoffice/39/port/index.htm  
**Location:** The centre of Japan (Latitude 34 38-43N, Longitude 35 5-18E)  
**Equipment & Capacity:** Total Berths 232  
 Berths 223, 43, 144m  
 Dolphins 9 31  
**Total Uncovered Storage:** 107,835sqm  
**Total Covered Storage:** 2765,499sqm

**MOJI-KU KITAKYUSHU CITY**  
**Moji Port Authority**  
 Port and Harbour Bureau  
 2-7 Nishi-Kaigan  
 Moji-ku Kitakyushu City  
 Fukuoka Pref  
 Japan  
**Contact:** Mr Tashiro, Head of International Affairs  
 T: + 81 93 321 5941  
 F: + 81 93 321 5933  
 E: wss.moji@wilhelmsen.com  
 W: www.japanwelcomesyou.com/cssweb/ports/port/html/kitakyushu.html

**MOJI-KU KITAKYUSHU CITY**  
**Moji Port Authority**  
 Port and Harbour Bureau  
 2-7 Nishi-Kaigan  
 Moji-ku Kitakyushu City  
 Fukuoka Pref  
 Japan  
**Contact:** Mr Tashiro, Head of International Affairs  
 T: + 81 93 321 5941  
 F: + 81 93 321 5933  
 E: wss.moji@wilhelmsen.com  
 W: www.japanwelcomesyou.com/cssweb/ports/port/html/kitakyushu.html

**KOCHI CITY**

**Port of Kochi**  
 Kochi Maritime Safety Office  
 5-4-55, Sanbashi-dori  
 Kochi City  
 780  
 Japan  
**Contact:** Port Manager  
 T: + 81 888 239888  
 F: + 81 888 372111  
 E: 175201@ken.pref.kochi.lg.jp

**KOMATSUSHIMA CITY**

**Port of Tokushima**  
 Komatsushima  
 Komatsushima Port and Harbour Office  
 37,Shinko, Komatsushima-cho  
 Komatsushima City  
 Tokushima Pref  
 Japan  
 T: + 81 88 621 2028  
 E: koe@city.komatsushima.tokushima.jp

**KURASHIKI CITY**

**Mizushima Port Authority**  
 1-12 Mizushima Fukuzaki-cho  
 Kurashiki City  
 Okayama  
 712-8056  
 Japan  
**Contact:** Mr Imoue, Director  
 T: + 81 864 447141

F: + 81 841 483010  
 E: wss.kobe@wilhelmsen.com  
 W: www.pref.okayama.jp/bichu/mizu/port.htm

**KUSHIRO CITY**

**Kushiro Port Authority**  
 Port & Harbour Department  
 Kushiro Kowan Goda Chosha  
 100-17 Shin Fujich  
 Kushiro City  
 Hokkaido  
 Japan  
 T: + 81 154 533 373  
 F: + 81 154 533 373  
 E: ku210101@city.kushiro.hokkaido.jp  
 W: www.city.kushiro.hokkaido.jp/kouwan/minato/

**MAIZURU CITY**

**Maizuru Port Authority**  
 Maizuru Port Admin Office  
 19-5 Koaza Shimazaki Aza  
 Malsukage  
 Maizuru City  
 Japan  
 T: + 81 773 75 7184  
 F: + 81 773 75 7198  
 E: m-port@mxa.nkansai.ne.jp  
 W: www5.nkansai.ne.jp/off/m-port/index\_e.htm

**MARUGAME CITY**

**Port of Marugame**  
 Marugame Harbour Office  
 127-16 Fukushima-cho  
 Marugame City  
 Kagawa  
 Japan  
 T: + 81 877-23-7696

**MINATOKU**

**Niihama Coal Centre**  
 Sumitomo Coal Mining  
 204, 3-Chrome  
 Nishi-Shimbashi  
 Minatoku  
 Tokyo  
 Japan  
**Contact:** Mr Yoshitoyo Nakayama, Deputy General Manager  
 T: + 81 3 5404 0410  
 F: + 81 3 5404 0447

**MOJI-KU KITAKYUSHU CITY**

**MOJI-KU KITAKYUSHU CITY**  
**Moji Port Authority**  
 Port and Harbour Bureau  
 2-7 Nishi-Kaigan  
 Moji-ku Kitakyushu City  
 Fukuoka Pref  
 Japan  
**Contact:** Mr Tashiro, Head of International Affairs  
 T: + 81 93 321 5941  
 F: + 81 93 321 5933  
 E: wss.moji@wilhelmsen.com  
 W: www.japanwelcomesyou.com/cssweb/ports/port/html/kitakyushu.html

**MOJI-KU KITAKYUSHU CITY**

**MOJI-KU KITAKYUSHU CITY**  
**Port of Tobata**  
 c/o Kitakyushu Port Bureau  
 2-7 Nishikaigan, 1-chome,  
 Moji-ku Kitakyushu City  
 Fukuoka Pref 801  
 Japan  
**Contact:** Mr Hiroyuki Tagami,  
 T: + 81 93 321 5941  
 F: + 81 93 321 5915  
 E: hiroyuki\_tagami01@city.kitakyushu.lg.jp  
 W: www.kitaqport.or.jp

**MORIOKA**

**Port of Kamaishi**  
 Port and Harbour Department  
 10-1 Uchimaru  
 Morioka

Iwate Pref  
020  
Japan  
T: + 81 19 629 5912  
F: + 81 193 243962  
E: AG0010@pref.iwate.jp

## MORIOKA

**Port of Ofunato**  
Port & Harbour Section of Iwate  
Prefecture  
10-1 Uchimaru  
Morioka  
Iwate-Pref  
020  
Japan  
**Contact:** Mr H Kimura,  
T: + 81 192 273111  
F: + 81 196 515 604  
E: wss.tokyo@wilhelmsen.com

## MUBANTI

**Shukuzu Coal Centre**  
Kowwan-Bu  
Hokkaido Muroran-shi  
Kaigan-Choo  
1-Chrome  
Mubanti  
Japan  
**Contact:** Mr T Nakamura, Manager  
T: + 81 143 244466  
F: + 81 143 240011

## MURORAN CITY

**Muroran Port Authority**  
20-30 Kaigan-cho  
1-chome  
Muroran City  
Hokkaido Province  
Japan  
**Contact:** Mr Asei Sakata,  
T: + 81 143 22 3191  
F: + 81 143 22 6069  
E: oport@city.muroran.hokkaido.jp  
W: www.city.muroran.hokkaido.jp

## NAGASAKI CITY

**Port of Matsushima**  
Matsushima Port Authority  
Port and Harbour Section  
2-13 Edo-Machi  
Nagasaki City  
850  
Japan  
T: + 81 95 824 1111

## NAGOYA

**Gamagori Port Authority**  
c/o Port and Harbour Section of  
Aichi Prefecture,  
3-1-2 Sannomaru  
Naka-Ku  
Nagoya  
460-01  
Japan  
T: + 81 52 654 7840  
F: + 81 52 650 7995

## NIIGATA CITY

**Port of Niigata**  
Bureau of Port and Airport  
Development  
Niigata Prefecture  
4-1 Shinko-cho  
Niigata City  
Niigata  
950-8570  
Japan  
**Contact:** Mr T Sugimoto,  
T: + 81 0 25 280 5456  
F: + 81 25 284 5042  
E: T1700102@mail.pref.niigata.jp  
W: Port of Niigata

## NIHAMA CITY

**Port of Niigata**  
5-1 Ikku-cho  
1 chome  
Niigata City  
Ehime Pref  
792-0025  
Japan  
T: + 81 897 33 5151

F: + 81 897 324 515  
E: wss.kobe@wilhelmsen.com

## OITA CITY

**Port of Oita**  
Oita Port Authority  
Shin Sangyotoshi Kaihatsu Kyoku  
3-33 Mukaibaru  
Oita City  
Nishi 1-chrome Oita Pref  
Japan  
T: + 81 97 558 5111  
F: + 81 97 553 0655  
W: www.pref.oita.jp/14300/f  
az/faz1/english/faz\_en.html

## OSAKA CITY

**Port of Osaka**  
Osaka Port and Harbors Bureau  
WTC Bldg 41F  
1-14-16 Nanko-Kita  
Suminoe-ku  
Osaka City  
559-0034  
Japan  
**Contact:** Mr Tadashi Ito, Manager,  
Port Promotion  
T: + 81 6 6615 7764  
F: + 81 6 6615 7769  
E: na0004@city.osaka.lg.jp  
W: www.city.osaka.jp/port

## OTARU CITY

**Port of Otaru**  
Otaru Port Authority  
4-2 Minato-Machi  
Otaru City  
Hokkaido Pref  
Japan  
T: + 81 134 23 1109  
E: kowan@city.otaru.hokkaido.jp  
W: www.city.otaru.hokkaido.jp/  
minato/mina\_s.htm

## SAKAIDE CITY

**Sakaide Port Administration**  
5-32 Irifune-cho  
1-chome  
Sakaide City  
Kagawa Pref  
Japan  
T: + 81 877 46 2518  
E: kowan1@city.sakaide.lg.jp

## SASEBO CITY

**Port of Sasebo**  
Port and Harbour Bureau  
3-5 Yorozu-cho  
Sasebo City  
Nagasaki Pref  
Japan  
T: + 81 956 226128  
F: + 81 956 226149

## SCHIMONOSEKI CITY

**Schimonoseki Port & Harbour Bureau**  
Schimonoseki City Government  
Nabe-cho  
1-1  
Schimonoseki City  
Yamaguchi Pref  
Japan  
**Contact:** Mr Toshihiko Nakano,  
Director General  
T: + 81 832 31 1111  
F: + 81 832 33 0860  
E: webmaster@schimonoseki-  
port.com  
W: www.schimonoseki-port.com

## SENDAI

**Port of Ishinomaki**  
Ports & Harbors Promotion Division  
Public Works Department  
Miyagi Prefectural Government  
Aoba-ku  
Sendai  
Miyagi Pref.  
980-8570  
Japan  
**Contact:** Mr Kimio Doi, Chairman  
T: + 81 22 211 3221

F: + 81 225 956 273  
E: kousin@pref.miyagi.jp  
W: www.port-ishinomaki.jp

## SHIBUSHI-SHI

**Port of Shibushi**  
Shibushi Port Administrative Office  
6617-17 Cho Shibushi-cho,  
Shibushi-shi  
Kagoshima Pref  
899-7102  
Japan  
T: + 81 994 73 1651  
F: + 81 994 73 1671  
E: shibushi-  
minato@pref.kagoshima.lg.jp  
W: www.pref.kagoshima.jp/infra/  
port/minato/shibushi/index.html

## SHIZUOKA CITY

**Port Authority of Shimizu**  
9-25 Hinode-cho  
Shimizu-ku  
Shizuoka City  
Shizuoka Prefecture 424-0922  
Japan  
**Contact:** Mr Aritsuka Kobayashi,  
Planning & Development Manager  
T: + 81 543 53 2203  
F: + 81 543 54 0380  
E: port@mail.wbs.jp  
W: www.portofshizuoka.com  
**Location:** 35 01 N  
138 32 E  
**Bulk Berths:**  
Grain,Cement,LNG,Oil,etc.  
**Total Uncovered Storage:** 335,901  
sqm  
**Total Covered Storage:** 62,947  
sqm  
Shimizu is the mail port of Shizuoka  
prefecture.The total container  
volume of Shimizu is 518,742 TEU  
in 2004 (7th in Japan). Shimizu  
open 24 hours a day.

## SHIZUOKA CITY

**Port of Tagonoura**  
Port Administrative Office  
2-1 Suzukawa-cho  
Fuji Shi  
Shizuoka City  
417  
Japan  
**Contact:** Mr Kyusaku Sato, Master  
of Tagonoura Port Office  
T: + 81 5 433 0495  
F: + 81 5 433 1009

## TAKAMTSU CITY

**Naoshima Port Authority**  
Port & Harbour Department  
1-10 Bancho 4-chome  
Takamtsu City  
Kagawa Pref  
Japan  
T: + 81 87 831 1111  
E: wss.tokyo@wilhelmsen.com

## TOKUYAMA CITY

**Tokuyama Port Authority**  
13-23 Chikko-cho  
Tokuyama City  
Yamaguchi Pref  
745-0025  
Japan  
**Contact:** Mr Hidoshi Onishi, Port  
Manager  
T: + 81 834 211787  
F: + 81 834 325090

## TOKUYAMA CITY

**Tonda Port Authority**  
c/o Shunan Port Admin Office  
13-23 Chikko-cho  
Tokuyama City  
Yamaguchi Pref  
Japan  
**Contact:** Mr Masaru Kaneno, Port  
Manager  
T: + 81 834 211787  
F: + 81 834 325090

## TOKYO

**Tokyo Metropolitan Government**  
Bureau of Port and Harbour 8-1  
Nishi-Shinjuku 2-chome,  
Shinjuku-ku  
Tokyo  
163-8001  
Japan  
**Contact:** Ms Toshiko Seki,  
T: + 81 3 5320 5549  
F: + 81 3 5388 1576  
E:

S0000517@section.metro.tokyo.jp  
W: www.kouwan.metro.tokyo.jp  
**Location:** The port is on the north-  
western part of the Tokyo Bay. It is  
located in the area between the  
estuaries of the Arakawa and  
Tamagawa Rivers.  
**Equipment & Capacity:**  
Breakwater Length : 8,781m  
Mooring Facilities :  
-Wharves and Piers : 23,059m  
20s berths (incl. 4,479m, 15 berths  
for  
container)

-Buoys : 3 2 berths  
-Dolphins : 31 19 berths  
-Landing Stage : 2,094m  
Timber Basins : 999,213 sqm 6  
berths  
**Bulk Berths:** Bulk Cargo Terminal :  
1 berth, 240m, -12m OI  
Construction-Materials Terminal : 4  
berths, 280m, -5m OI Food Stuff  
Terminal : 3 berths, 610m, -12m/-  
11m Shinagawa Terminal(Domestic)  
: 5 berths, 856m, -8m Shibaura  
Terminal : 7 berths, 870m, -7.5m/-  
5.5m  
**Total Uncovered Storage:** Open-  
air Storage Yards (public) :  
1,010,595 sqm  
**Total Covered Storage:** Transit  
Sheds (public) : 209,487 sqm

## TOMAKOMAI CITY

**Tomakomai Port Authority**  
6-38, Minato-Machi 1-chome  
Tomakomai City  
Hokkaido  
053-0004  
Japan  
**Contact:** Mr Junichi Suzuki,  
Executive Vice President  
T: + 81 144 345551  
F: + 81 144 345559  
E: t-masuda@jptmk.com  
W: www.jptmk.com

## TOYAMA CITY

**Toyama Port Authority**  
Administration Office  
5 Kaigan-dori  
Higashi Iwase,  
Toyama City  
Toyama  
931-8358  
Japan  
**Contact:** Mr K Yamaguchi,  
T: + 81 764 377 131  
F: + 81 764 419 050

## TOYAMA CITY

**Toyama-Shinko Public Berths**  
Fushiki Kairiku Unso  
Toyamashinko Branch  
4-2 Nagonoe  
Shinminato-shi  
Toyama City  
Japan  
T: + 81 766 82 1118  
F: + 81 766 84 3335

## TSURUGA CITY

**Tsuruga Port Authority**  
2-1 Sakura-machi  
Tsuruga City  
Fukui Pref  
Japan  
T: + 81 776 20 0489  
E: kowan@pref.fukui.lg.jp

## UBE CITY

**Port of Ube, Okinoyama Coal Terminal**  
12-32 Nishihon-machi  
1-Chrome  
Ube City  
Yamaguchi Pref  
Japan  
**Contact:** Mr Masayoshi Wanishi,  
General Manager  
T: + 81 335 31 5971  
F: + 81 838 31 5885

## USUI CITY

**Tsukumi Port Authority**  
Usuki Doboku Office  
72-254 Aza Susaki, Oaza Usaki  
Usui City  
Oita Pref  
875-0041  
Japan  
T: + 81 972 634136

## WAKAYAMA CITY

**Smikin Transport Service**  
1850 Minato  
Wakayama City  
Hokkaido Pref  
Japan  
**Contact:** Mr Tutomu Ononishi,  
T: + 81 734 51 5168  
F: + 81 734 51 5150

## WAKAYAMA CITY

**Wakayama Port Authority**  
Wakayama Shimotsu Admin Office  
22 Chikko 6- chome  
Wakayama City  
Hokkaido Pref  
Japan  
T: + 81 734 413154  
F: + 81 734 334839

## YATSUSHIRO CITY

**Yatsushiro Port Office**  
249 Minato-machi  
Yatsushiro City  
Kumamoto Pref  
Japan  
**Contact:** Port Office Superintendent  
T: + 81 96 333 2514  
E: kouwan@pref.kumamoto.lg.jp

## YOKOHAMA

**Port of Yokohama**  
Port and Harbour Bureau  
5F Sangyo-Boeki Center Boulevard  
2  
Yamashita-cho, Naka-ku  
Yokohama  
231-0023  
Japan  
**Contact:** Mr Kazuhiko Watanabe,  
Port Promotion Director  
T: + 81 45 671 7188  
F: + 81 45 671 7310  
E: porttoubu@city.yokohama.jp  
W: www.city.yokohama.jp/mel/port

## JERSEY

### ST HELLIER

**Induvac**  
Belrespiro  
La Route des Petits Camps  
St Hellier  
JE2 4JN  
Jersey  
**Contact:** Mr Ian Miller,  
T: + 44 1534 767623  
F: + 44 1534 874088  
E: belrespiro@aol.com

## JORDAN

### AQABA

**The Ports Corporation Aqaba**  
Port Corps of Aqaba  
PO Box 115  
Aqaba

77110  
Jordan  
**Contact:** Mr Awwad Maytah,  
Director General  
T: + 962 3 201 4042  
F: + 962 3 201 6204  
E: info@aqabaports.gov.jo  
W: www.adc.jo

## KENYA

### MOMBASA

**Grain Bulk Handlers Ltd**  
Grain House  
Beira Road  
Shimanzu  
PO Box 80469  
Mombasa  
Coast  
80100  
Kenya  
**Contact:** Mr Mujtaba Jaffer, CEO  
T: + 254 7030 17000  
F: + 254 7030 17444  
E: gbh@grainbulk.com  
W: www.grainbulk.com

### MOMBASA

**Kenya Ports Authority**  
PO Box 95009  
Mombasa  
Kenya  
**Contact:** Capt Twalib Khamis,  
General Manager - Operations  
T: + 254 41 312 211  
F: + 254 41 311 867  
E: tkhamis@kpa.co.ke  
W: www.kenya-ports.com  
**Location:** East Africa on the Indian  
Ocean

**Equipment & Capacity:** -Travelling  
Cranes - nos. 30, 5 - 20 tonne  
-Portal electric fixed cranes - nos. 3,  
- 3 tonne  
-Electric overhead travelling cranes  
- nos. 3, 2 - 10 tonne  
-Under hung jib - nos. 4, 1.5 tonne  
-Forklift trucks -nos. 50, 3 - 16 tonne  
-Mobile cranes - nos. 13, 5 - 43  
tonne  
**Bulk Berths:** -Grain Bulk Handlers  
Ltd - Berth No - 3, Total Length (m)  
166.4, Draft 10, 2 Ship unloaders -  
600 tonnes per hour  
-Magadi Soda Ltd - Berth No 9,  
Total length(m) 179.8, Draft 10.4, 1  
payloader  
-Mbaraki 1-Total length(m) 153,  
Draft 10.4 - 10.97  
-Mbaraki 2 -Total length(m) 153,  
Draft 10.4 - 10.97  
- Berth 11- Total length(m) 173.1,  
Draft 10.4 - 9.75  
- Berth 12, Total length(m) 166.4,  
Draft 10.4 - 9.75  
**Total Uncovered Storage:** 114,117  
sqm  
**Total Covered Storage:** 132,781  
sqm

### MOMBASA

**Port of Mombasa**  
Kenya Port Authority  
PO Box 95009  
Mombasa  
Kenya  
**Contact:** Mr Brown M. Ondego,  
Managing Director  
T: + 254 11 312211  
F: + 254 11 311867  
E: micid@kpa.co.ke

## KIRIBATI

### BETIO

**Kiribati Ports Authority**  
PO Box 506  
Betio  
Tarawa  
Kiribati  
**Contact:** Mrs Rubee Eromanga,  
T: + 686 25147



F: + 686 26164  
E: kpa@tskl.net.ki

**KUWAIT**

**SAFAT**  
**Shuaiba Port**  
Kuwait Ports Authority  
PO Box 3874  
Safat 13039  
PO Box 3874  
Safat 13039  
Safat 13039  
Kuwait  
**Contact:** Mr Karim Habib Ali,  
T: + 965 4812622  
F: + 965 4819 714  
W: www.kpa.com.kw

**SAFAT**  
**Shuwaikh Port**  
c/o Kuwait Port Authority  
PO Box 3874  
Safat 13039  
Kuwait  
**Contact:** Mr Alia Salem Al-Saba,  
Director General  
T: + 965 481 2622  
F: + 965 481 9714  
E: isaship@qualitynet.net  
W: www.isakwi.com/

**LATVIA**

**LIEPAJA**  
**Liepaja Port Authority**  
4 Feniksa Street  
Liepaja  
34201  
Latvia  
**Contact:** Mr I Boja, Port Director  
T: + 371 34 29605  
F: + 371 34 80252  
E: port@sez.lv  
W: www.liepaja-sez.lv

**LIEPAJA**  
**Liepaja Special Economic Zone Authority SEZ**  
4 Feniksa Street  
Liepaja  
3401  
Latvia  
**Contact:** Mr Aivers Boja, Port General Manager  
T: + 371 6 34 27605  
F: + 371 34 80252  
E: authority@sez.lv  
W: www.liepaja.lv

**RIGA**  
**Freeport of Riga Authority**  
12 Kalpaka Boulevard  
Riga LV 1010  
Latvia  
**Contact:** Ms Vita Gerharde, Sales specialist  
T: + 371 6 703 0874  
E: info@freoportofriga.lv  
W: www.freoportofriga.lv

**RIGA**  
**Freeport of Riga Authority**  
12 Kalpaka Boulevard  
Riga LV 1010  
Latvia  
**Contact:** Ms Vita Gerharde, Sales specialist  
T: + 371 6 703 0874  
E: info@freoportofriga.lv  
W: www.freoportofriga.lv

**RIGA**  
**Riga 1. Saldetava JSC**  
Eksporta str. 15 k-1,

Riga  
LV-1045  
Latvia  
**Contact:** Ms Kristine Vizule,  
Marketing and PR Manager  
T: + 371 673 29816  
F: + 371 673 26501  
E: Kristine.vizule@rto.lv  
W: www.rto.lv  
**Location:** Capital of Latvia (Middle Latvia)  
**Equipment & Capacity:** Equipment Quant. Capacity  
Portal cranes 29 up to 40t  
Caterpillar cranes 3 up to 21t  
Forklifts 65 up to 10t  
Forklifts 8 10t-25t  
Reach stacker 1 up to 45t  
Tug masters 5 up to 80t  
Scoop tractors 14 up to 7,5m3  
Wagon tractors 9 40 t  
Locomotives 3 60 wagons  
**Bulk Berths:** Berth / Length / Draught  
EO-7 / 190 / 9.5  
EO-9 / 130 / 6,6  
EO-10 / 150 / 7,0  
EO-11 / 140 / 7,2  
EO-12 / 159 / 7,0  
EO-14 / 210 / 11,7  
EO-15 / 212 / 11,7  
PM-16 / 145 / 9,5  
PM-17 / 145 / 9,5  
**Total Uncovered Storage:** 158,000 sqm  
**Total Covered Storage:** 59,800 sqm  
Total terminal area: 67.6 ha.  
Max vessel: length 225m; DWT 76000t.  
Railway access roads: 19.5 km,  
Operative capacity for 400 wagons.

**VENTSPILS**  
**JSC BALTIC COAL TERMINAL**  
39B Dzintaru Street  
Ventspils  
LV-3602  
Latvia  
**Contact:** Mr Ilya Sokolov, Member of the Board  
T: + 371 636 34 000  
F: + 371 636 34 001  
E: info@balticcoal.com  
W: www.balticcoal.com  
**Location:** Latvia, Ventspils, The Baltic Sea  
**Equipment & Capacity:** Throughput capacity - 6 mln tons coal per year  
**Bulk Berths:** For ships up to 120,000dwt  
**Total Uncovered Storage:** N/A  
**Total Covered Storage:** Warehouse 24,000 sqm with storage up to 210,000 tonnes of coal.  
Terminal uses modern coal transshipment technologies and has covered warehouse as well conveyor galleries to prevent environmental pollution. The deepwater pier depth is 16.0m and length 350m.

**RIGA**  
**WT Terminal Ltd**  
Flotes Street 3a  
Riga  
LV-1016  
Latvia  
**Contact:** Mr Janis Lapins,  
T: + 371 6780 6018  
F: + 371 6744 3001  
E: janis.lapins@wt-terminal.lv  
W: www.wt-terminal.lv  
**Location:** In Freeport of Riga, Latvia  
**Equipment & Capacity:** 3 cranes and 8 forklifts.  
500,000m3/tonnes/year  
**Bulk Berths:** 350m, 5.5m draught  
**Total Uncovered Storage:** 95,000sqm  
**Total Covered Storage:** 9,000sqm  
The terminal handles cargoes to/from vessels, trucks, railways wagons. The Terminal is able to store and tranship several types of bulk & general cargoes. Terminal is fully ISPS - compliant. Our customers enjoy on-line stock control.

**VENTSPILS**  
**AS Ventspils Tirdzniecibas Osta**  
22 Dzintaru Street  
Ventspils  
LV3602  
Latvia  
**Contact:** Ms Julianna Svedenko, Secretary  
T: +371 63668706  
F: + 371 36 68870  
E: Julianna.Svedenko@vto.lv  
W: www.vto.lv

**VENTSPILS**  
**Free Port of Ventspils Authority**  
19 J a Str.  
Ventspils  
LV 3601  
Latvia  
**Contact:** Mr Imanis Sarmulis,  
T: + 371 6 362 2586

F: + 371 6 362 1297  
E: marketing@portofventspils.lv  
W: www.portofventspils.lv  
**Location:** East coast of the Baltic Sea, West coast of Latvia, on the coasts of the river Venta.  
**Equipment & Capacity:** A deepwater port with opportunities to accommodate Aframax type vessels for liquid cargoes and Panamax type vessels for dry bulk and general cargoes.  
**Bulk Berths:** Max draught up to 15m.  
Dry bulk terminals are Kalija parks (transshipment of mineral fertilizers); Ventspils Commercial Port (transshipment of metals, coal, ferro-alloys, grain, raw sugar); grain transshipment terminal Ventspils Grain Terminal and closed storage coal terminal Baltic Coal Terminal.

**VENTSPILS**  
**JSC BALTIC COAL TERMINAL**  
39B Dzintaru Street  
Ventspils  
LV-3602  
Latvia  
**Contact:** Mr Ilya Sokolov, Member of the Board  
T: + 371 636 34 000  
F: + 371 636 34 001  
E: info@balticcoal.com  
W: www.balticcoal.com  
**Location:** Latvia, Ventspils, The Baltic Sea  
**Equipment & Capacity:** Throughput capacity - 6 mln tons coal per year  
**Bulk Berths:** For ships up to 120,000dwt  
**Total Uncovered Storage:** N/A  
**Total Covered Storage:** Warehouse 24,000 sqm with storage up to 210,000 tonnes of coal.  
Terminal uses modern coal transshipment technologies and has covered warehouse as well conveyor galleries to prevent environmental pollution. The deepwater pier depth is 16.0m and length 350m.

**VENTSPILS**  
**Kalija Parks**  
20a Dzintaru iela  
Ventspils  
3602  
Latvia  
**Contact:** Mr Dainis Treimanis, Member of the Board  
T: + 371 636 07232  
F: + 371 3625345  
E: director@kp.vcp.lv  
W: www.ventspils.lv

**VENTSPILS**  
**Ventspils Grain Terminal**  
41 Dzintaru Street  
Ventspils  
LV 3602  
Latvia  
**Contact:** Mr Vladislavs Safranskis, Board Chairman  
T: + 371 6 366 8802  
F: + 371 366 8850  
E: vgtl@vgt.lv  
W: www.vgt.lv

**LEBANON**

**BEIRUT**  
**Chekaa Bay**  
c/o Port of Beirut  
PO Box 1490  
Beirut  
Lebanon  
**Contact:** Mr J Khazen, Port Director  
T: + 961 1 580211  
F: + 961 1 585835

E: info@portdebeiryouth.com  
W: www.portdebeiryouth.com

**BEIRUT**  
**Port Authority of Selaata**  
c/o Port of Beirut  
PO Box 1490  
Beirut  
Lebanon  
**Contact:** Mr J Khazen, Port Director  
T: + 961 1 601602  
F: + 961 1 601602

**TRIPOLI**  
**Service d'Exploitation du Port de Tripoli**  
Al Mina - Port street  
Tripoli  
North Lebanon  
Lebanon  
**Contact:** Mr Ahmad Tamer, Manager  
T: + 96 1 350 6618  
F: + 96 1 622 0180  
E: info@oept.gov.lb  
W: www.oept.gov.lb

**LIBERIA**

**MONROVIA**  
**Monrovia Port**  
National Port Authority  
PO Box 10-18-49  
Monrovia  
1000  
Liberia  
**Contact:** Ms Elsie Dossen Bodio, President  
T: + 231 221332  
F: + 231 226388  
E: natport@liberia.net

**MONROVIA**  
**National Port Authority**  
Bushrod Island  
PO Box 1849  
Monrovia  
Liberia  
**Contact:** Mr Fassue Kellah, Managing Director  
T: + 231 221332  
F: + 231 226388  
E: natport@liberia.net

**ROBERTSFIELD**  
**Buchanan Port Authority**  
Lamco JV Venture Operating Co  
c/o Roberts International AirPort  
Robertsfield  
Liberia  
**Contact:** Mr D Uittenbogaard, Chief Agent  
T: + 231 221332  
F: + 231 226388  
E: natport@liberia.net

**LITHUANIA**

**KLAIPEDA**  
**BEGA, Stevedoring Company**  
Nemuno st. 2B  
Klaipeda  
LT - 91199  
Lithuania  
**Contact:** Mr Aloyzas Kuzmarskis, General Manager  
T: + 370 46 395 500  
F: + 370 46 380 384  
E: bega@bega.lt  
W: www.bega.lt  
**Location:** South-eastern coast of Baltic Sea; a good geographical location of the ice-free port of Klaipeda on the East-West trade route.  
**Equipment & Capacity:** 8 million tonnes of cargo a year.  
Mobile ship loaders (up to 1500 tph), cranes (120 tons), covered/uncovered rail wagons loading stations (up to 50 rail cars at

a time), own trucks and locomotives etc.  
**Bulk Berths:** Max length - 2km; Max draught - 13.2m  
**Total Uncovered Storage:** 300,000sqm  
**Total Covered Storage:** 525,000sqm tonnes  
Specialization: dry and liquid fertilizers, agribulks, minerals, cement, soda ash etc.  
Additional services: bulk packing, cargo forwarding, ships agency

**KLAIPEDA**  
**Joint-Stock Stevedoring Company**  
Klaipedos Smelte  
Nemuno Street 24  
Klaipeda 5804  
Lithuania  
**Contact:** Mr Eduardos Gawushkinas, General Manager  
T: + 370 46 496306  
F: + 370 46 496246  
E: info@smelte.lt

**KLAIPEDA**  
**Klaipeda Stevedoring Company (KLASCO)**  
Zauveino Street 18  
Klaipeda  
LT-92122  
Lithuania  
**Contact:** Mr Vidas Kuklierius, Senior Manager  
T: + 370 46 399031  
F: + 370 46 399325  
E: vidas@klasco.lt  
W: www.klasco.lt  
**Location:** Lithuania, South East Coast of the Baltic Sea  
**Equipment & Capacity:** Into the vessel up to 1,500 mtp, from railcars - up to 800 mtp  
**Bulk Berths:** Berth length - 220m - depth - 14m  
**Total Covered Storage:** For bulk products - 180,000 mt

**KLAIPEDA**  
**State Enterprise Klaipeda State Seaport Authority**  
J Janonio st. 24  
Klaipeda  
LT-92251  
Lithuania  
**Contact:** Mr Arturas Drungilas, Director for Marketing  
T: + 370 46 499 748  
F: + 370 46 499777  
E: a.drungilas@port.lt  
W: www.portofklaipeda.lt  
**Location:** Northernmost port on the Eastern coast of Baltic Sea.  
**Equipment & Capacity:** Mobile loaders, wheeled loaders, cranes, warehouses.  
**Bulk Berths:** 21 berths for bulk cargo  
**Total Uncovered Storage:** 780,300sqm  
**Total Covered Storage:** 368,000sqm

**KLAIPEDA**  
**Vakaru krova, UAB**  
Minijos g. 180  
Klaipeda  
LT-93269  
Lithuania  
**Contact:** Mr Nerijus Gričius, Director  
T: + 370 46 483 883  
F: +370 46 483 884  
E: nerijus.gricius@wsy.lt  
W: www.wsy.lt

**MADAGASCAR**

**TOAMASINA**  
**Societe d'Exploitation du Port de Toamasina**

PO Box 492  
Toamasina  
501  
Madagascar  
**Contact:** Mr Pierre Marolaha, General Manager  
T: + 261 5 32155  
F: + 261 5 335 58  
E: sept@ots.mg

**MALAYSIA**

**BINTULU**  
**Samalaju Industrial Port Sdn. Bhd.**  
12th Miles Tg. Kidurong Road,  
P.O. Box 996  
Bintulu  
Sarawak  
97008  
Malaysia  
**Contact:** Engr. Eddy Noriman Hossain, Manager, Port Operation Equipment  
T: + 60 128660669  
F: + 60 86296838  
E: eddy@bintuluport.com.my  
W: www.bintuluport.com.my/  
**Location:** Sarawak, Malaysia  
Samalaju Port is currently under construction (Phase 1), expected to be completed by Q2/2016 and commence its full operation by Q3/2016.

**BUTTERWORTH**  
**Penang Port SDN BHD**  
SBU Cargo Services  
Administration Building  
Butterworth  
Penang  
12100  
Malaysia  
**Contact:** Mr Haji Abdul Rahim Abu Bakar, General Manager  
T: + 60 4 3102200  
F: + 60 4 3324414  
E: info@penangport.com.my  
W: www.pgport.com.my

**JOHOR BAHRU**  
**Bulk & Breakbulk Terminal**  
Johor Port Berhad  
PO Box 151  
Wisma Kontena  
Pasir Gudang  
Johor Bahru  
Johor  
81707  
Malaysia  
**Contact:** Captain Mohd. Slim Mohd. Din, Head of Bulk and Break Bulk  
T: + 60 7253 5888  
F: + 60 7251 0980  
E: jpb@johorport.com.my  
W: www.johorport.com.my

**JOHOR BAHRU**  
**Johor Port BERHAD**  
PO Box 151  
Wisma Kontena  
Pasir Gudang  
Johor Bahru  
81707  
Malaysia  
**Contact:** Mr Ahmed Kamal, Head, Corporate Communications  
T: + 60 7 253 5888  
F: + 60 7 251 0980  
E: jpb@johorport.com.my  
W: www.johorport.com.my  
**Location:** Eastern side of the southern tip of Peninsular Malaysia  
**Equipment & Capacity:** Bulk/Break Bulk: 2 Gantry Cranes, 2 Level-Luffing Cranes, Continuous Chain Unloader, 2 Dedicated Conveyors (1000 tonnes/hour), Shore Cranes at up to 300 tonne capacity.  
**Bulk Berths:** Breakbulk: Berth Lighterage: 60m length, 6.0m depth, 6,500DWT displacement  
Berth W1: 110m length, 6.0m depth,

26,000DWT displacement  
 Berth W2: 183m length, 11.0m depth, 39,000DWT displacement  
 Berth W3: 183m length, 11.0m depth, 39,000DWT displacement  
 Dry Bulk:  
 Berth W4: 192m length, 12.7m depth, 78,000DWT displacement  
 Berth W5: 217m length, 12.9m depth, 78,000DWT displacement  
 Berth W6: 214m length, 13.0m depth, 78,000DWT displacement  
 Multipurpose (Break Bulk, Dry Bulk & Container Cargo):  
 Berth W7: 195m length, 13.5m depth, 80,000DWT displacement  
 Berth W8: 195m length, 13.5m depth, 80,000DWT displacement  
 Berth W9: 195m length, 13.5m depth, 80,000DWT displacement  
 Berth W10: 195m length, 13.5m depth, 80,000DWT displacement  
 Berth W11S: 230m length, 11.0m depth, 13,000DWT displacement  
 Berth W11N: 120m length, 5.0m depth, 13,000DWT displacement  
**Total Uncovered Storage:** Approximately 80,000 sqm  
**Total Covered Storage:** Approximately 164,000 sqm  
 JPB is listed on the London Metal Exchange for storage and handling of seven (7) non-ferrous metals: primary aluminium, aluminium alloy, lead, zinc, copper, nickel and tin. JPB runs its own Free Zone, which also has a rail depot.

## KLANG

**Westports Malaysia Sdn Bhd**  
 24 Lorong Peria  
 Taman Radzi  
 Klang  
 Selangor  
 41200  
 Malaysia  
**Contact:** Mr Sohan Singh, Conventional Marketing  
 T: +60 12 522 0853  
 F: +60 3 3169 4119  
 E: sohan\_singh@hotmail.com  
 W: www.westportsmalaysia.com/

## KOTA KINABALU

**Sabah Ports Authority**  
 Locked Bag No 2005  
 Kota Kinabalu  
 Sabah  
 88617  
 Malaysia  
**Contact:** Datuk Mayong Omar, General Manager  
 T: +60 88 538400  
 F: +60 88 223036  
 E: saboport@po.jaring.my  
 W: www.lpps.sabah.gov.my  
**Location:** East & West and North of Sabah  
**Total Uncovered Storage:** 2,800 sqm -26,800 sqm  
 Dry bulk cargo is currently handled using grabs and hoppers provided by the cargo owners/agents.

**Kuantan Port Consortium Sdn Bhd**  
 Wisma  
 PO Box 199  
 Tanjung Gelang

Kuantan  
 Pahang  
 25720  
 Malaysia  
**Contact:** Mr Haji Khasbullah Bin A. Kadir, Chief Operating Officer  
 T: +60 9 586 3888  
 F: +60 9 583 9393  
 E: irphko.kuantanport@jim.com  
 W: www.jim.com/infrastructure/port/KuantanPort/  
**Location:** East of Malaysia  
**Equipment & Capacity:** Grab Unloader  
**Bulk Berths:** Two - 400m  
**Total Uncovered Storage:** 30,000 sqm  
**Total Covered Storage:** 10,000 sqm  
 Port Terminal handling fertilizers, mineral ores, coal, gypsum etc

## KUANTAN

**Lembaga Pelabuhan Kuantan**  
 Tanjung Gelang  
 Peti Surat 161  
 Kuantan  
 Pahang Darul Makmur  
 25720  
 Malaysia  
**Contact:** Mr Mohamad Iramhan,  
 T: +60 9 585 8000  
 F: +60 9 583 3866  
 E: lpktn@lpkn.gov.my  
 W: www.lpktn.gov.my

## LABUAN

**Labuan Port Authority**  
 W-2 Liberty Port Storage Area  
 P.O. Box 81858  
 Labuan  
 87028  
 Malaysia  
**Contact:** Mr C Simon, Port Manager  
 T: +60 87 421699  
 F: +60 87 421850  
 E: labuanport@lpm.com.my  
 W: www.lpm.com.my

## MALACCA

**Malacca Port Authority**  
 Pelabuhan Tanjung Bruas  
 Tanjung Kling  
 Malacca  
 76400  
 Malaysia  
**Contact:** Mr Chua Yew Ling, Port Manager  
 T: +60 6 351 1766  
 F: +60 6 351 1216  
 E: arum@portsworld.com

## MIRI

**Miri Port Authority**  
 Jalan Miri Port  
 Kuala Baram Industrial Estate  
 Kuala Baram  
 PO Box 1179, 98008 Miri, Sarawak  
 Miri  
 Sarawak  
 98000  
 Malaysia  
**Contact:** Madam Serawa Budol, Manager, Business Development Services  
 T: +60 85 609 031  
 F: +60 8 560 4841  
 E: serawab@miriport.gov.my  
 W: www.miriport.gov.my  
**Location:** Lat 004 34' Long 114 2' 36" E  
**Equipment & Capacity:** 1 x 100t mobile harbour crane  
 2 x 41t reachstacker  
 9 x 3-4t, 1 x 7t and 3 x 3t forklifts  
 1 x 20' spreader  
 1 x 140t and 1 x 50t hydraulic truck mounted cranes  
 5 x terminal tractor  
 4 x 40' skeletal trailer  
 1 x 40' platform trailer  
**Bulk Berths:** Total Length ~ 390m (6 berths of 65m length each)

**Total Uncovered Storage:** 63,000sqm  
**Total Covered Storage:** 5,400sqm  
 Container Yard ~ 328 ground slots, 241 TGS, Reefer points 28 TGS  
 Dangerous Goods Storage ~ 200sqm

## PENANG

**Penang Port SDN BHD**  
 1 King Edward Place  
 Georgetown  
 Penang  
 10300  
 Malaysia  
**Contact:** Mr Ahmad Ibnihajar, Managing Director  
 T: +60 4 210 2211  
 F: +60 4 263 4792  
 E: info@penangport.com.my  
 W: www.penangport.com.my

## PENANG

**Prai Bulk Cargo Terminal**  
 Penang Port Commission  
 3A-6 Bangunan Sri Weld  
 Pangkalan Weld  
 Penang  
 10300  
 Malaysia  
**Contact:** Mr Noor Ariff bin Yusoff, General Manager  
 T: +60 4 263 3211  
 F: +60 4 263 2623  
 E: sopp@penangport.gov.my  
 W: www.penangport.gov.my

## PORT KELANG

**West Fertilizer Terminal Sdn Bhd**  
 Lot No 55709  
 Dry Bulk Terminal 2  
 Persiaran Teratai, Pulau Indah  
 Port Kelang  
 Selangor DE 42009  
 Malaysia  
**Contact:** Mr Leo Berntsen, General Manager  
 T: +60 3 31011886  
 F: +60 3 31011886  
 E: enquiry@chunyuconstruction.com

## PORT KLANG

**Northport (Malaysia) Bhd**  
 Jalan Pelabuhan  
 North Port  
 Port Klang  
 Selangor Darul Ehsan  
 42000  
 Malaysia  
**Contact:** Mr Rubani Dikon, Chief Executive Officer  
 T: +60 3 3169 8888  
 F: +60 3 3169 8621  
 E: ccdi@northport.com.my  
 W: www.northport.com.my  
**Location:** Central west coast of Peninsular Malaysia located along the Straits of Malacca.  
**Equipment & Capacity:** 2 Luffing Cranes at drybulk Wharf 24 & 25 and 3 Hybrid Quay Cranes at Wharf 21 for drybulk operations.  
**Bulk Berths:** Wharf 21 : Length 213m, Draught 13m, Displacement 80,000 MT  
 Wharf 24 : Length 213m, Draught 12m, Displacement 80,000 MT  
 Wharf 25 : Length 213m, Draught 12m, Displacement 80,000 MT  
**Total Uncovered Storage:** About 35,000 sq. ft. / 3,252 sqm  
**Total Covered Storage:** About 394,005 sq. ft. / 36,604 sqm  
 Handled more than 2.1 million tonnes of drybulk cargoes per annum (handled 2 million tonnes in 2014). Achieved highest record productivity rate of 15,000 tons per weather working day for maize.

## SIBU

**Rajang Port Authority**  
 Sibul  
 Sarawak  
 96000  
 Malaysia  
**Contact:** Mr Chong Siew Yang, General Manager  
 T: +60 84 319 009  
 F: +60 84 318 754  
 E: arum@portsworld.com  
 W: www.portsworld.com/Ports/rajangport.htm

## TERENGGANU DARUL

**IMAN**  
**Kemaman Port Authority**  
 Bangunan Demaga Timur  
 Telok Kalung  
 Terengganu Darul Iman  
 Kemaman  
 24000  
 Malaysia  
**Contact:** Mr Dato 'Tik bin Mustaffa', General Manager

Jalan Pelabuhan  
 Port Klang  
 Selangor  
 42005  
 Malaysia  
**Contact:** Mr G Shanti, Corporate Communications Manager  
 T: +60 3 3168 8211  
 F: +70 3 3167 0211  
 E: shanti@pka.gov.my  
 W: www.pka.gov.my  
**Location:** West Coast of Peninsular Malaysia - 40km from Kuala Lumpur.  
**Equipment & Capacity:** Conveyor - 3, 110,000t  
**Bulk Berths:** 6  
**Total Uncovered Storage:** 12,935sqm  
**Total Covered Storage:** 42,565sqm

## SANDAKAN

**Sandakan Port Authority**  
 PO Box 1368  
 Sandakan  
 Sabah  
 90008  
 Malaysia  
**Contact:** Mr Francis Lee Fah Hin, Port Manager  
 T: +60 89 612 411  
 F: +60 88 22 3036  
 E: info@portarea.com

## SERI MANJUNG

**Lumut Maritime Terminal Sdn Bhd**  
 Lekir Bulk Terminal (LBT)  
 Pulau Lekir 1  
 Jln Teluk Rubiah  
 Seri Manjung  
 Perak  
 32040  
 Malaysia  
**Contact:** Mr Amin Bin Halim Rasip, Chief Executive Officer  
 T: +60 3 2141 7728  
 F: +60 3 2141 2995  
 E: aminrasip@integrax.com.my  
 W: www.lumutport.com  
**Location:** On a reclaimed island, South East of Pangkor Island, Perak, West Malaysia (Off the Straits of Malacca)  
**Equipment & Capacity:** 2 Grab Ship Unloaders with rated capacity of 1,500mtp each and 2 import conveyors lines with rated capacity of 3,800mtp each  
**Bulk Berths:** Total quay length about 800m  
**Total Uncovered Storage:** About 80 acres (About 323,752sqm)  
**Total Covered Storage:** Nil  
 Minimum natural depth of 20m alongside the berth

## SIBU

**Rajang Port Authority**  
 Sibul  
 Sarawak  
 96000  
 Malaysia  
**Contact:** Mr Chong Siew Yang, General Manager  
 T: +60 84 319 009  
 F: +60 84 318 754  
 E: arum@portsworld.com  
 W: www.portsworld.com/Ports/rajangport.htm

## SIBU

**Rajang Port Authority**  
 Sibul  
 Sarawak  
 96000  
 Malaysia  
**Contact:** Mr Chong Siew Yang, General Manager  
 T: +60 84 319 009  
 F: +60 84 318 754  
 E: arum@portsworld.com  
 W: www.portsworld.com/Ports/rajangport.htm

## TERENGGANU DARUL

**IMAN**  
**Kemaman Port Authority**  
 Bangunan Demaga Timur  
 Telok Kalung  
 Terengganu Darul Iman  
 Kemaman  
 24000  
 Malaysia  
**Contact:** Mr Dato 'Tik bin Mustaffa', General Manager

T: +60 9 863 1590  
 F: +60 9 863 1599  
 E: arum@portsworld.com

## MALTA

### MARSA

**Port of Valletta**  
 Malta Transport Centre  
 Ports & Yachting Directorate  
 Xatt L-Ghassara Ta'L-Gheneb  
 Marsa  
 MRS 1917  
 Malta  
**Contact:** Mr David Bugeja, Chief Officer  
 T: +356 22914 401  
 F: +356 21222 208  
 E: david.bugeja@transport.gov.mt  
 W: www.transport.gov.mt

**Location:** Malta  
**Bulk Berths:** Coal Wharf (Inner): length 110m, min Draught 6.5m  
 Coal Wharf (Outer): length 120m, min Draught 4m  
 Many other quays for handling bulk and general cargo  
**Total Covered Storage:** Cement and Grain Silos(80,000sqm and 12,500t)

### MARSA

**Transport Malta**  
 Malta Transport Centre  
 Xatt L-Ghassara Ta'L-Gheneb  
 Marsa  
 MRS 1917  
 Malta  
**Contact:** Captain David Bugeja, Ports & Yachting Directorate  
 T: +356 22914441  
 F: +356 222208  
 E: info.tl@transport.gov.mt  
 W: www.transport.gov.mt

**Location:** Valletta  
**Equipment & Capacity:** Kordin Grain Terminal (KGT) Storage facility consists of 30 bins; 18 large bins with capacity of 3,800 metric tons each and 12 smaller bins 1,600 tons each.  
 Buhler installations including - mobile mechanical bulk ship unloader with a maximum unloading capacity of 1,100 mtp/h; a mechanical railmounted ship loader with a peak loading capacity of 1,250 mtp/h; and direct ship-to-ship transfer facilities without the need to intake into silo.  
 The terminal can accept fully laden Panamax grain bulk carriers of up to 80,000 DWT and can load coasters and feeder vessels of up to 20,000 DWT.  
**Bulk Berths:** Laboratory Wharf - length 190m, vessel loading.  
 Magazine Wharf - length 252m, vessel unloading  
 Fuel Wharf  
**Total Uncovered Storage:** N/A  
**Total Covered Storage:** 88,000 metric tons  
 Transport Malta has a concession agreement with two cement importers who had invested in their own Silo facilities at Fuel Wharf.

**Location:** Valletta  
**Equipment & Capacity:** Kordin Grain Terminal (KGT) Storage facility consists of 30 bins; 18 large bins with capacity of 3,800 metric tons each and 12 smaller bins 1,600 tons each.  
 Buhler installations including - mobile mechanical bulk ship unloader with a maximum unloading capacity of 1,100 mtp/h; a mechanical railmounted ship loader with a peak loading capacity of 1,250 mtp/h; and direct ship-to-ship transfer facilities without the need to intake into silo.  
 The terminal can accept fully laden Panamax grain bulk carriers of up to 80,000 DWT and can load coasters and feeder vessels of up to 20,000 DWT.  
**Bulk Berths:** Laboratory Wharf - length 190m, vessel loading.  
 Magazine Wharf - length 252m, vessel unloading  
 Fuel Wharf  
**Total Uncovered Storage:** N/A  
**Total Covered Storage:** 88,000 metric tons  
 Transport Malta has a concession agreement with two cement importers who had invested in their own Silo facilities at Fuel Wharf.

**Bulk Berths:** Laboratory Wharf - length 190m, vessel loading.  
 Magazine Wharf - length 252m, vessel unloading  
 Fuel Wharf  
**Total Uncovered Storage:** N/A  
**Total Covered Storage:** 88,000 metric tons  
 Transport Malta has a concession agreement with two cement importers who had invested in their own Silo facilities at Fuel Wharf.

## PAOLA

**Kordin Grain Terminal Company Ltd**  
 Telg et Ras an ir  
 Laboratory Wharf  
 Kordin  
 Paola  
 PLA 3000  
 Malta  
**Contact:** Mr Alex Agius, Chief Executive  
 T: +356 2360 4112  
 F: +356 2360 4180  
 E: alex@alexagius.com  
 W: www.kordingrain.com.mt  
**Location:** Malta in Valletta port  
**Equipment & Capacity:** Ship unloader 1100mtp  
 Ship loader 1200mtp  
**Bulk Berths:** Discharging facility: Magazine Wharf Grand Harbour, Valletta. 200m length, 14m draught.  
 Loading facility: Laboratory Wharf Grand Harbour, Valletta. 120m length, 10m draught.  
**Total Uncovered Storage:** 90,000t  
**Total Covered Storage:** 88,000t  
 Located in the natural deep-draught Valletta Harbour, Kordin is in a most strategic location for the handling, storage and transhipment of all types of free flowing grains reaching the Mediterranean

## MAURITANIA

### NOUADHIBOU

**Port Autonome de Nouadhibou**  
 PO Box 236  
 Nouadhibou  
 Mauritania  
**Contact:** Ms Gaye Sidatt, Harbour Director  
 T: +222 45 134  
 E: contact@pan.mr  
 W: www.portndb.com  
**Bulk Berths:** Draught 16.2m. Max LOA 310m. Max Beam 47m.

## MAURITIUS

### PORT LOUIS

**Mauritius Ports Authority**  
 PO Box 379  
 H. Ramnarain Building  
 Mer Rouge  
 Port Louis  
 Mauritius  
**Contact:** Mr Shekur Suntah, Ag. Director General  
 T: +230 206 5400  
 F: +230 240 0856  
 E: s.suntah@mauport.com  
 W: www.mauport.com  
**Location:** 2,400 km off east coast of Africa  
**Equipment & Capacity:** 26 x 1t and 47 x 3t Hyster forklifts, 7 x 5t forklifts, 3 x 7-10t empty handlers, 16 x 25t Douglas prime movers, 23 x 20t and 9 x 40t low bed trailers, 1 x 40t Gottwald crane.  
**Bulk Berths:** 6 quays with maximum dredged depth of -12.2m  
**Total Uncovered Storage:** 8.05 Ha  
**Total Covered Storage:** 17,900sqm

## MEXICO

### ACAPULCO

**Port Authority of Acapulco**  
 Costera Miguel Aleman, Malecon Fiscal  
 Col Centro  
 Acapulco  
 39300  
 Mexico  
**Contact:** Mr Francisco JE Lopez Stiles, Director General  
 T: +52 971 40668  
 F: +52 971 40436



E: marketing@apiacapulcoport.com  
W: www.apiacapulcoport.com

**ALTAMIRA**

**Cooper/T. Smith De Mexico SA de CV**

Mar Negro KM 0.380  
Puerto Industrial  
Col. Puerto De Altamira  
Altamira  
Tamaulipas  
89603  
Mexico

**Contact:** Mr Arturo Encinas, General Director  
T: + 52 833 260 45 00  
F: + 52 833 260 10 82  
E: arturo.encinas@coopertsmith.com  
W: www.coopertsmith.com  
**Location:** Port of Altamira, Mexico  
**Equipment & Capacity:** Two 45-ton gantry cranes with the capacity to unload 10,000 ton/day. Frontloaders and railcars.

**ALTAMIRA**

**Industrial Port of Altamira**

Altamira  
Tamaulipas  
89608  
Mexico  
**Contact:** Ing. Jose Luis Diaz Covarrubias Hanún, Director of Port Operations  
T: + 52 833 260 60 76  
F: + 52 833 260 60 70  
E: jldiaz@puertoaltamira.com.mx  
W: www.puerto-de-altamira.com.mx  
Fastest growing port in Mexico

**ALTAMIRA**

**Terminal Maritima de Altamira, SA de CV**

Altamira  
Tamaulipas  
89608  
Mexico  
**Contact:** Ing. Rogelio Maya Moncada, Terminal Manager  
T: + 52 833 260 1138  
F: + 52 833 260 1142  
E: tmamexplus@infosel.net.mx  
W: www.watapaltamira.com.mx  
**Location:** Port of Altamira, Mexico  
**Equipment & Capacity:** 3 grab gantry cranes. Conveyor bands. Loading/unloading ships: 10,000 ton/day. Loading/unloading barges: 10,000 ton/day. Loading/unloading trucks and railroad cars.  
**Bulk Berths:** Depth - 38 feet. Length - 783 feet. Max DWT - 55,000.  
**Total Uncovered Storage:** 4 acre product storage yard.  
**Total Covered Storage:** Grain warehouse: 70,000 ton capacity. Mineral grains warehouse: 45,000 ton capacity. Largest facility of it's type in Latin America.

**CHIAPAS**

**Port Authority of Puerto Madero**

Interior Recinto Portuario  
Puerto Madero  
Chiapas  
96400  
Mexico

**Contact:** Mr Jose Rafael Reyes Ruiz, Director General  
T: + 52 962 46757  
F: + 52 962 46758  
E: info@puertomadero.com

**ENSENADA**

**Port Authority of Ensenada**

Boulevard Teniente Azueta 224  
Ensenada  
22800  
Mexico

**Contact:** Mr Carlos Jauregui, General Director  
T: + 52 646 178 2860  
F: + 52 646 175 0301  
E: atencionclientes@puertoensenada.com.mx  
W: www.puertoensenada.com.mx/

**GARITA DE OTAY**

**Morro Redondo Port Authority**

Exportadora de sal SA de CV  
3a Oeste 17523-A Fracc  
Garita de Otay  
Tijuana  
BC ZP 22500  
Mexico  
**Contact:** Mr Orozco,  
T: + 52 66 8689891  
F: + 52 66 8689891  
E: info@portarea.com  
W: www.portarea.com /

**GUAYMAS**

**Port Authority of Guaymas**

Recinto Portuario Zona Franca Guaymas  
Sonora State  
85430  
Mexico  
**Contact:** Mr Felipe de Jesus Rivadeneira y Sauri, Director General  
T: + 52 622 41160  
F: + 52 622 24743  
W: www.puertoaguaymas.com

**LA PAZ**

**San Juan de la Costa Port Authority**

Port Office  
La Paz  
A Brocado  
Muelle y Comercio No 13  
La Paz  
Baja California State  
Mexico  
T: + 52 61 2122 7777  
F: + 52 61 2122 7778  
E: apibcs@prodigy.net.mx  
W: www.bajaport.com

**LAZARO CARDENAS**

**Terminales Portuarias Del Pacifico, S A P I de C V**

Recinto Portuario Lazaro Cardenas Canal Oriente s/n, Av. Los Rios Interior  
Isla del Cayacal, Apartado Postal 83  
Lazaro Cardenas  
Michoacán  
60950  
Mexico  
T: + 52 753 533 0090  
F: + 52 753 533 0090  
E: cargo.tpp@tpp.com.mx  
W: www.tpp.com.mx/

**Location:** Mexican Pacific Coast  
**Equipment & Capacity:** 2 LIEBHERR crane 550 & 600 4.0 million metric tons annual capacity  
**Bulk Berths:** One berth 180m  
**Total Uncovered Storage:** 23,410sqm  
Specialized Terminal for handling bulk Minerals and Steel products from Mexican Pacific coast, capable to handle Cape Size vessel up to 150,000dwt.

**MAZATLAN**

**Port Authority of Mazatlan**

Interior Recinto Fiscal Mazatlan  
Sinaloa 82000  
Mexico  
**Contact:** Mr Alfonso Gil Diaz,  
T: + 52 669 9823019  
F: + 52 669 9821960  
E: marketing@apimazatlan.com.mx  
W: www.apimazatlan.com.mx

**VERACRUZ**

**Port Authority of Veracruz**

Avenida Merina Mercante 210 7 piso  
Veracruz  
91700  
Mexico  
**Contact:** Mr Juan Jose Sanchez, Director  
T: + 52 229 923 2170

**SALINA CRUZ**

**Port Authority of Salina Cruz**

Administración Portuaria Integral de Salina Cruz  
Interior Recinto Fiscal S/N  
Col. Cantarranas  
Salina Cruz  
Oaxaca  
70680  
Mexico  
**Contact:** Ing. Ángel Pérez Cantú, Port Director  
T: + 52 971 717 30 70  
F: + 52 971 714 00 14  
E: puerto@puertosalacruz.com.mx  
W: www.puertosalacruz.com.mx

**Location:** Northern part of the Gulf of Tehuantepec, on the Pacific Ocean, at latitude 16°09'30" North and longitude 95°11'30" East.  
**Equipment & Capacity:** Grain Clams (2) 14 yd<sup>3</sup> (2) 7 ½ yd<sup>3</sup> (5) discharge hopper Ship side rails (2) Trackmobile  
**Bulk Berths:** Container Pier: LOA 202m / Beam 32m / Draught 33ft Fiscal Pier: LOA 202m / Beam 32m / Draught 33ft  
**Total Uncovered Storage:** 65,000sqm  
**Total Covered Storage:** 7,000sqm  
Hinterland includes the states of Oaxaca, Chiapas, and Veracruz. The rest of the market for the area of influence comprises the states of Puebla, Tabasco, and the Yucatan Peninsula.

**SAN CARLOS**

**San Carlos Port Authority**

Calle Puerto Acapulco s/n  
San Carlos  
Baja California State  
CP 23740  
Mexico  
**Contact:** Captain Rodriguez, Port Captain  
T: + 52 113 60133  
F: + 52 113 60198  
E: apibcs@prodigy.net.mx  
W: www.apibcs.com/

**TAMPICO**

**Port Authority of Tampico**

Edificio API Tampico s/n  
Recinto Portuario Tampico  
89000  
Mexico  
**Contact:** Ms Ana Laura Camanillo Torre, Commercial Manager  
T: + 52 833 241 14 41  
F: + 52 833 241 14 64  
E: acamanillo@puertodetampico.com.mx  
W: www.port-of-tampico.com.mx

**TOPOLOBAMPO**

**Topolobampo Port Authority**

Port Office  
Acceso al Parque Industrial Pesquero S. N.  
Topolobampo  
Sinaloa State  
81370  
Mexico  
**Contact:** Mr Cesar Madrazo Lozano, Director General  
T: + 52 686 20127  
F: + 52 686 20494  
E: comercial@apitopo.com.mx  
W: www.apitopa.com.mx



Port Klang, Malaysia.

F: + 52 29 323040  
E: accu@olem@puertodeveracruz.com.mx  
W: www.puertodeveracruz.com.mx

**MOROCCO**

**CASABLANCA**

**Office d'Exploitation des Ports**

4 rue Moussa Ibnou Nussair  
Casablanca  
Morocco  
**Contact:** Mr M Hashmi, Marketing Director  
T: + 212 2 317111  
F: + 212 2 313501  
E: administration@odep.org.ma  
W: www.odep.org.ma

**CASABLANCA**

**Port Nador**

c/o Marbar SA Casablanca  
81 Avenue Houmane  
Fegovaki  
Casablanca  
Morocco  
**Contact:** Mr Adil, Port Director  
T: + 212 2 224190  
F: + 212 2265398  
E: n\_ouakka@marsamaroc.com.ma

**EL JADIDA**

**Agence Nationale Des Ports**

Ani Jorf Lasfar  
Capitainerie du Port  
Km 22, Route Duzlidia  
El Jadida  
BP 407  
Morocco  
**Contact:** Mr Hamzaoui Mohamed, Harbour Master  
T: + 212 2334 5180  
F: + 212 2334 5093  
E: hamzaoui.mohamed25@menara.ma

**EL JADIDA**

**Jorf Lasfar Power Station**

Jorf Lasfar Energy  
8P 99  
Sidi Bouzid  
El Jadida  
Morocco  
**Contact:** Mr Boutaib Said,  
T: + 212 3 34 5371  
F: + 212 3 34 5375  
E: jllec@jllec.com.ma

**KENITRA**

**Port of Kenitra**

PO Box 23  
Kenitra  
Morocco  
**Contact:** Mr Hanough, Port Director  
T: + 212 7 371345  
F: + 212 7 372159

**TANGIER**

**Port of Tangier**

BP 305  
Tangier  
Morocco  
E: m\_saabou@marsamaroc.com.ma  
W: www.marsamaroc.com.ma

**MOZAMBIQUE**

**BEIRA**

**Cornelder de Moçambique, s.a.r.l**

Porto da Beira  
PO Box 236  
Largo dos CFM  
Beira  
150 Be  
Mozambique  
**Contact:** Mr Felix Machado, Sales & Marketing Manager  
T: + 258 2332 2734/5  
F: + 258 2332 2736  
E: Cornelder.mz@teledata.mz

**BEIRA**

**Largo dos CFM-C**

Porto da Beira  
PO Box 236  
Beira  
Sofala  
Mozambique  
**Contact:** Mr Rui Fonseca, President & Chairman of the Board of Directors  
T: + 258 21431706  
F: + 258 21313364  
E: rufonseca@cfmnet.co.mz  
W: www.cfmnet.co.mz

**MAPUTO**

**Grindrod Terminals - Maputo**

Praca dos Trabalhadores  
Porto de Maputo  
Maputo, Mozambique  
**Contact:** Mr Mark Flynn, Terminal Operations Manager  
T: + 258 21 720 350  
F: + 258 21 720 180  
E: markt@grindrod.co.mz  
W: www.grindrod.co.za  
**Location:** Port of Matola - Maputo, Mozambique.

**Equipment & Capacity:** Rail wagon tippers, conveyors, stacker/reclaimers and ship loaders. Current (2012) capacity - 6million tons pa but expanding to handle 7.3 million tons pa in 2013.  
**Bulk Berths:** 210m in length, can accommodate vessels up to 230m in length - depth at quayside current 12m, design 12m.  
**Total Uncovered Storage:** 70 000sqm  
Phase 4 development will add another 20mtpa coal terminal adjacent to the existing terminal.

**MAPUTO**

**Maputo Port Development Company SARRL**

Port Director's Building  
Port Maputo  
PO Box 2841  
Maputo  
Mozambique  
**Contact:** Mr Ricardo Roberts, Commercial Manager  
T: + 258 21 313 920  
F: + 258 21 313 921  
E: ricardo.roberts@portmaputo.com  
W: www.portmaputo.com  
**Location:** In the South of Mozambique - Maputo City  
**Equipment & Capacity:** 2 mobile cranes general cargo (40&60tons) 2 gantry cranes 40tons and 2 mobile cranes 100tons each at the container terminal  
**Bulk Berths:** Loading using skypys  
**Total Uncovered Storage:** 295,000sqm  
**Total Covered Storage:** 35,000sqm  
From middle next year, covered storage will increase to 65,000sqm.

**MAPUTO**

**Mozambique Ports and Railways - CFM**

Praca dos Trabalhadores  
Maputo  
2158  
Mozambique  
**Contact:** Mr Antonio Jorge Libombo, Director  
T: + 258 21301390  
F: + 258 21301390  
E: alibombo@cfmnet.co.mz  
W: www.portmaputo.com

**MAPUTO**

**New Coal Terminal Beira SA**

Avenue Armando Tivane no-1620-R/C  
Sommerscheid  
Maputo  
Mozambique  
**Contact:** Mr Abhishek Mohta, Manager  
T: + 91 22 66601391  
F: + 91 9930136884  
E: Abhishek.Mohta@essar.com

**MAPUTO**

**Portos e Caminhos De Ferro de Mozambique**

E.P.Praca dos Trabalhadores  
PO Box 2158  
Maputo  
Mozambique  
**Contact:** Mr Alberto Elias, Port Director  
T: + 258 21 303576  
F: + 258 21301508  
E: albertoelias@cfmnet.co.mz

## MATOLA



**Stema SA**  
Lingamo, 729  
Matola  
Mozambique  
**Contact:** Mr Silvino Moreno, Chief Executive Officer  
T: + 258 21 721 762 / +258 21 722770  
F: + 258 21 721 763  
E: stema@stema.co.mz  
W: www.stema.co.mz  
**Location:** Southern Africa, East Coast  
**Equipment & Capacity:** Mobile unloader 250tph, Loader 500tph  
**Bulk Berths:** 3 berthing Dolphin, 1 mooring Dolphin  
**Total Covered Storage:** 25,000t in bulk. 27 silo, 1700 each

## NACALA

**Nacala Port Authority**  
Direccao nacional dos Portos  
PO Box 70  
Nacala  
Mozambique  
**Contact:** Mr Boaventura M Cherinda, Port Director  
T: + 258 26 212927  
F: + 258 26 212034  
E: info@cdn.co.mz

## MYANMAR

## YANGON

**Yangon Port Authority**  
Myanmar Ports Corporation  
PO Box No 1  
Yangon

Myanmar  
**Contact:** Mr U K M Gyi, Port Manager  
T: + 95 1 283122  
F: + 95 1 95134  
E: mpa-sad@mptmail.net.mm  
W: www.mot.gov.mm/mpa/index.html

## NAMIBIA

### WALVIS BAY

**Grindrod Terminals - Walvis Bay**  
1st Floor Grindrod House  
174 Third Street East  
Walvis Bay  
9000  
Namibia  
**Contact:** Mr Shakespeare Masiza, Regional Manager  
T: + 264 271 270  
F: + 264 271 280  
E: shakespeare@grindrod.com.na  
W: www.grindrod.co.za  
**Location:** West coast of Africa in Namibia  
**Equipment & Capacity:** Conveyor belt, shiploader, rail discharge, screening plant. The facility has the capacity to handle 725 000 tons pa.  
**Bulk Berths:** Two Berths adjacent to facilities  
**Total Uncovered Storage:** 47 546  
Future projects/developments - 500 000 tons pa Sulphur handling facility  
120 000 tons Fluorspar shed and 140 000 tons copper concentrate facility.

### WALVIS BAY

**Namibian Ports Authority**  
PO Box 361  
Walvis Bay

9190  
Namibia  
**Contact:** Mr Cliff Shikuambi, Marketing Dept  
T: + 264 64 208 2207  
F: + 264 64 208 2323  
E: pr.assistent@namport.com.na  
W: www.namport.com  
**Location:** Situated on the central coastal region of Namibia  
**Equipment & Capacity:** 2 x 100 tonnes mobile cranes  
2 x 45 tonnes reach stackers  
1 x 42 tonnes container stacker  
1 x 42 tonnes forklift with spreader  
2 x 45 tonnes Kalmar Reach stacker

### WALVIS BAY

**Namport**  
No 17 13th Road  
PO Box 361  
Walvis Bay  
Namibia  
**Contact:** Mr Phillemon Mupupa, Marketing & Business Dvpt  
T: + 264 64 208 2111  
F: + 264 64 2082323  
E: p.mupupa@namport.com.na  
W: www.namport.com

## NAURU

### AIWO

**Nauru Port Authority**  
P O Box 5  
Aiwo  
Nauru  
**Contact:** Mr B Blundell, Marketing Manager  
T: + 674 555 4191  
F: + 674 444 7352

## NETHERLANDS

### ANTILLES

#### BONAIRE

**Bonaire Pilots**  
Fort Oradse z/n  
Bonaire  
Netherlands Antilles  
**Contact:** Captain L O Statie, Harbour Master  
T: + 559-717-8151  
F: + 559-717-8797

#### CURACAO

**Curacao Ports Authority**  
Werf de Wilde z/np o Box 689  
Curacao  
Netherlands Antilles  
**Contact:** Mr Richard Lopez-Ramirez, Managing Director  
T: + 599 9 434 5999  
F: + 599 9 461 3907  
E: cpamanag@cura.net  
W: www.curports.com

## NEW

### CALEDONIA

#### HOUAILOU

**Societe des Mines du Cap Bocage**  
Presqu'île du Cap Bocage  
Box no. 18  
Houailou 98816  
New Caledonia  
**Contact:** Mr Stephane, Mine Manager  
T: + 687 42 4855  
F: + 687 42 5284

E: smcb@canl.nc  
**Location:** Port : Baie UGUE on East Coast of New Caledonia  
Commodities handled: Nickel Ore

#### NOUVEA

**Port Authority of New Caledonia**  
PO Box 14  
Avenue James Cook  
Noumea  
98845  
New Caledonia  
**Contact:** Mr Philippe Lafleur, Port Manager  
T: + 687 255000  
F: + 687 283772  
E: noumeaportnc@canl.nc

## NEW ZEALAND

### AUCKLAND

**NZ Stevedoring Co Ltd**  
PO Box 1291  
Auckland  
New Zealand  
**Contact:** Mr R J Seamer,  
T: + 649 303 4048  
F: + 649 379 4836

### AUCKLAND

**Onehunga Port Authority**  
c/o Ports of Auckland Ltd  
PO Box 1281  
Auckland  
1140  
New Zealand  
**Contact:** Mr Brian Jarman, Port Coordinator  
T: + 64 9 6364264  
F: + 64 9 6346599  
E: harcon@poal.co.nz  
W: www.poal.co.nz

## AUCKLAND

**Ports of Auckland Limited**  
Sunderland Street  
PO Box 1281  
Auckland  
1010  
New Zealand  
**Contact:** Mr Tony Gibson, Chief Executive  
E: info@poal.co.nz  
W: www.poal.co.nz

## BLUFF

**South Port NZ Ltd**  
PO Box 1  
Bluff  
9842  
New Zealand  
**Contact:** Mr Mark O'Connor, Chief Executive  
T: + 64 3 2128159  
F: + 64 3 2128685  
E: reception@southport.co.nz  
W: www.southport.co.nz

## LYTTELTON

**Lyttelton Coal Terminal**  
Private Bag 501  
Norwich Quay  
Lyttelton  
Canterbury  
New Zealand  
**Contact:** Mr Peter Davie, Chief Executive  
T: + 64 3328 8198  
F: + 64 3328 7828  
E: peter.davie@ipc.co.nz  
W: www.ipc.co.nz

## MOUNT MAUNGANUI

**NZL Group Limited t/a NZ Marshalling & Stevedoring**  
Private Bag 12506  
Mount Maunganui



The Gateway for cereals  
Into the Southern Africa

**Location:**  
- Matola Harbor

**Served Countries:**

- Mozambique
- Swaziland
- South Africa
- Zimbabwe



**Provided Services:**

- Ship Loading & Unloading
- Truck Loading & Unloading
- Rolling Stock Loadin & Unloading
- Grain Storage (45.000 T)
- Fumigation
- Bagging
- Grain Cleaning



NM ISO 9001:2008

**HANDLED PRODUCTS:**



BEANS



SOYBEAN



WHEAT



MALT



MAIZE



PADDY



New Zealand  
**Contact:** Mr Tony Cousins, General Manager  
 T: + 64 7 575 4440

**NAPIER**  
**Port of Napier Ltd**  
 PO Box 947  
 Napier  
 4140  
 New Zealand

**Contact:** Mr Garth Cowie, Chief Executive  
 T: + 646 833 4400  
 E: info@napierport.co.nz  
 W: www.napierport.co.nz  
**Location:** East Coast of North Island  
**Equipment & Capacity:** Including 800tph conveyor. Please see website for more details.  
**Bulk Berths:** Cassidy Quay 250m, 2 North 200m, 2 South 200m  
**Total Covered Storage:** 16,600sqm

**NEW PLYMOUTH**  
**Port Taranaki Limited**  
 PO Box 348  
 New Plymouth  
 4340  
 New Zealand

**Contact:** Mr Roy J Weaver, Chief Executive  
 T: + 64 6 751 0200  
 F: + 64 6 751 0886  
 E: rweaver@porttaranaki.co.nz  
 W: www.porttaranaki.co.nz  
**Location:** Centrally located on the West coast of New Zealand's North Island.  
 For further information please refer to our website.

**PORT CHALMERS**  
**Port Otago Ltd**  
 PO Box 8  
 Port Chalmers  
 New Zealand

**Contact:** Mr Geoff Plunket, Chief Executive  
 T: + 64 3 472 7890  
 F: + 64 3 472 9891  
 E: pol@portotago.co.nz  
 W: www.portotago.co.nz  
**Location:** East Coast, South Island, New Zealand

**RUAKAKA**  
**Northport Ltd**  
 PO Box 44  
 Ruakaka  
 Northland  
 0151  
 New Zealand

**Contact:** Mr Jae Staitte, Operations & Marine Manager  
 T: + 64 9 4325010  
 F: + 64 9 4328749  
 E: shipping@northport.co.nz  
 W: www.northport.co.nz  
**Location:** North East of New Zealand on the East Coast.  
**Equipment & Capacity:** Gotwald HMK 4406 Mobile Harbour Crane  
 2x EMU TEU handlers  
 4x TEU/FEU Handlers 41MT capacity  
 7x 70MT bulk discharge hoppers  
**Bulk Berths:** 3 berths @ 580m with 13.0m to 14.5m at CD  
**Total Uncovered Storage:** 32 ha  
**Total Covered Storage:** 5,000sqm  
 850 tph woodchip ship loading facility

**TAURANGA**  
**C3 Limited (previously Toll Owens Ltd)**  
 Maritime House  
 10 Rata Street  
 Mount Maunganui  
 Private Bag 12501  
 Tauranga  
 Bay of Plenty

3143  
 New Zealand  
**Contact:** Mr Dean Camplin, Chief Executive  
 T: + 64 7572 8972  
 F: + 64 7575 2000  
 E: Dean.Camplin@C3.co.nz  
 W: www.c3.co.nz  
**Location:** New Zealand - All 13 Ports  
**Equipment & Capacity:** Various Stevedoring and Marshalling Equipment

**TAURANGA**  
**Port of Tauranga Ltd**  
 Sallsbury Avenue  
 Mount Maunganui  
 Private Bag 12504  
 Tauranga  
 3143  
 New Zealand

**Contact:** Mr Mark Cairns, Chief Executive  
 T: + 64 7 572 8899  
 F: + 64 7 572 8800  
 E: marketing@port-tauranga.co.nz  
 W: www.port-tauranga.co.nz  
**Location:** Bay of Plenty, North Island, New Zealand  
**Equipment & Capacity:** Twelve (12) Hoppers ranging in size from 300 tonne to 50 tonne capacity  
**Bulk Berths:** Berth no/ max length / max depth / max draught at LW:  
 8 / 180m / 12.5m / 11.7m  
 9 / 180m / 12.5m / 11.7m  
 10 / 200m / 12.5m / 11.7m  
 11 / 223m / 12.5m / 11.7m  
 12 / Cement/Tanker / 12.9m / 12.0m  
**Total Uncovered Storage:**  
 Combined Mount Maunganui wharves and Tauranga Container Terminal:  
 560,000sqm  
**Total Covered Storage:** Mount Maunganui:  
 Dry Storage 21,640sqm  
 Cold Storage 22,500sqm  
 General Cargo/Cool Storage 3,670sqm  
 Container Terminal :  
 Dry Storage 37,378sqm  
 Cold Storage 7,210sqm  
 Port of Tauranga's land holdings total 188 hectares.

**TIMARU**  
**PrimePort Timaru**  
 PO Box 544  
 Timaru 7940  
 New Zealand  
**Contact:** Mr Tony Cooper, Infrastructure Manager  
 T: + 64 3 687 2700  
 F: + 64 3 687 2709  
 E: tonyc@primeport.co.nz  
 W: www.primeport.co.nz  
**Location:** New Zealand - East Coast South Island.  
**Equipment & Capacity:** 6 x 75tn hoppers, environmental screens, 100tn weighbridge, front end loader, sweeper, and forklifts up to 12tn  
**Bulk Berths:** #1 Wharf Length 200m Draught -10.0m  
 #1X Wharf Length 200m Draught -10.2m  
 North-Mole Inner Length 200m Draught -10.5m  
 North-Mole Outer Length 200m Draught -11.5m  
 Plus one new wharf under construction.  
**Total Uncovered Storage:** Up to 90,000 - with other off-site options available  
**Total Covered Storage:** 5000m<sup>2</sup> with a significant amount of covered storage available under private ownership adjacent to the Port.  
 Within Timaru township there is 300 ha of land available for development situated next to State Highway 1 and the main truck rail line.

**WANGANUI**  
**Wanganui Port Authority**  
 c/o Wanganui Port (2010)  
 Castlecliff Wharf  
 PO Box 623  
 Wanganui  
 New Zealand  
**Contact:** Mr J S M Blaikie, Harbour Master  
 T: + 64 6 3447684  
 F: + 64 6 3447524  
 E: john.blaikie@wanganui.govt.nz  
 W: www.wanganui.govt.nz

**WELLINGTON**  
**Port of Wellington**  
 Port Operations  
 PO Box 794  
 Wellington  
 New Zealand  
 T: + 64 4 472 8912  
 F: + 64 4 499 0720  
 E: customerservices@centreport.co.nz

**WESTPORT**  
**Westport Harbour**  
 PO Box 335  
 Westport  
 7866  
 New Zealand  
**Contact:** Harbour Master/Port Manager  
 T: + 64 3 788 8086  
 F: + 64 3 789 6269  
 E: info@westportharbour.co.nz  
 W: www.westportharbour.co.nz  
**Location:** Situated on the NW coast of South Island, NZ.  
**Equipment & Capacity:** Tug/Pilot vessel & Trailing Suction Dredger  
**Bulk Berths:** Fish, Coal, Other Commodities  
**Total Uncovered Storage:** 10,000sqm  
**Total Covered Storage:** 2,000sqm

**NICARAGUA**  
**MANAGUA**  
**Empresa Portuaria Nacional (EPN)**  
 Residencial Bolonia  
 De Optica Nicaraguense 1 C. al Lago y 1 C. Abajo.  
 Managua  
 Nicaragua  
**Contact:** Licenciado Virgilio Rommel Silva Munguia, Presidente Ejecutivo  
 T: + 505 266 2545/4271  
 F: + 505 266 2555  
 E: vsilva@epn.com.ni  
 W: www.epn.com.ni

**SANDINO**  
**Port Sandino**  
 PO Box 100  
 Sandino  
 Leon  
 Nicaragua  
**Contact:** Mr Oscar Vindell, Port Manager  
 T: + 505 312226  
 F: + 505 312261

**NIGERIA**  
**LAGOS**  
**Nigerian Ports Authority**  
 (Lagos/Apapa)  
 PO Box 12588  
 Lagos, Nigeria  
**Contact:** Mr A A Suleiman, Port Director  
 T: + 234 1 260 0620  
 F: + 234 1 263 0306

**PORT HARCOURT**  
**Port Harcourt**  
 Nigerian Ports Authority

PO Box 5043  
 Port Harcourt  
 Nigeria  
 T: + 234 84 300370  
 F: + 234 84 335402

**NORWAY**

**BREVIK**  
**Greenland Port Authority**  
 Stromlengen  
 PO Box 20  
 Brevik  
 N-3951  
 Norway  
 T: + 47 3593 1000  
 F: + 47 3593 1011  
 E: ghv@grenland-havn.no  
 W: www.port.of.grenland.com

**DRUMMEN**  
**Port Authority of Drammen**  
 Hans Kiaersgaten 1A  
 Postboks 636T  
 Drammen  
 3041  
 Norway  
**Contact:** Mr Einar Olsen, Port Manager/Executive Director  
 T: + 47 32 20 86 50  
 F: + 47 32 20 86 51  
 E: einar.olsen@drammenhavn.no  
 W: www.drammenhavn.no

**FARSUND**  
**Elkem Aluminium Lista**  
 PO Box 128  
 Lista  
 Farsund  
 N-4551  
 Norway  
**Contact:** Mr Trygve Lundegaard, Shipping Manager  
 T: + 47 38 39 91 00  
 F: + 47 38 39 92 57  
 E: trygve.lundegaard@elkem.no

**FLORO**  
**Port Authority of Floro**  
 PO Box 17  
 Floro  
 6901  
 Norway  
**Contact:** Mr Arild Hovland, Harbour Master  
 T: + 47 57 75 6740  
 F: + 47 57 740 916  
 E: arild.hovland@floro.kommune.no

**GLOMFJORD**  
**Port Authority of Glomfjord**  
 c/o Norsk Hydro AS  
 Postboks 190  
 Glomfjord  
 8160  
 Norway  
**Contact:** Mr Erik Knutsson,  
 T: + 47 75 71 91 00  
 F: + 47 75 71 94 15  
 E: erik.knutsson@yarra.com

**HUSNES**  
**Aluminium Works Terminal**  
 PO Box 85  
 Husnes  
 N-5460  
 Norway  
**Contact:** Mr M Rosslund, Senior Manager Soral  
 T: + 47 53 47 50 00  
 F: + 47 53 47 53 98

**KIRKENES**  
**Port of Kirkenes**  
 Municipality of Sor-Varanger  
 PO Box 406  
 Kirkenes  
 9901  
 Norway  
**Contact:** Mr Arnt Kr. Marthinussen, Manager  
 T: + 47 78 99 91 00

F: + 47 78 99 12 00  
 E: arntkr@kirkenes-havn.no

**KRISTIANSUND**  
**Kristiansund and Nordmøre Port Authority**  
 Astrupsgate 9  
 Kristiansund  
 6509  
 Norway  
**Contact:** Mr Arnt Helge Honstad, Harbour Master  
 T: + 47 40 00 65 04  
 F: + 47 71 67 14 83  
 E: alh@knhavn.no  
 W: www.knhavn.no

**LARVIK**  
**Larvik Port Authority**  
 PO Box 246  
 Larvik  
 3251  
 Norway  
**Contact:** Mr Jan Fredrick Jonas, Port Director  
 T: + 47 33 16 57 50  
 F: + 47 33 16 57 59  
 E: jf@larvikhavn.no  
 W: www.larvikhavn.no

**MO I RANA**  
**Mo I Rana Port Authority**  
 PO Box 185  
 Mo I Rana  
 8601  
 Norway  
**Contact:** Mr P Nygaard,  
 T: + 47 75 13 47 00  
 F: + 47 75 13 47 01  
 E: pa.nygaard@rana.kommune.no  
**Bulk Berths:** Draught 11.4m. Max LOA 250m. Max Beam 32.2m.

**MOSJOEN**  
**Mosjoen Port Authority**  
 Havnegaten 60  
 Mosjoen  
 8650  
 Norway  
**Contact:** Mr Torbjorn Jorgensen, Harbour Master  
 T: + 47 75 10 18 70  
 F: + 47 75 10 18 71  
 E: torbjorn.jorgensen@vefsn.kommune.no

**MOSS**  
**Port Authority of Moss**  
 Moss Maritime Center  
 Postboks 5020  
 Moss  
 N-1503  
 Norway  
**Contact:** Mr F P Syvertsen, Harbour Master/Managing Director  
 T: + 47 69 25 10 39  
 F: + 47 69 25 07 38  
 E: firmapost@mosshavn.no

**NARVIK**  
**LKAB**  
 Bolagsgata 40  
 PO Box 314  
 Narvik N-8504  
 Norway  
**Contact:** Mr Svein Ivar Sivertsen, General Manager  
 T: + 47 959 23870  
 F: + 47 769 44925  
 E: svein.sivertsen@lkab.com  
 W: www.lkab.com  
**Location:** North of Norway  
**Equipment & Capacity:** 20 million tpa  
**Bulk Berths:** LOA, no limitation. Draught 27m. 350.000 dwt  
**Total Uncovered Storage:** 0.8 million tons  
**Total Covered Storage:** 0.5 million tons  
 From the end of 2009 all storage will be covered. Total 1.5 million tons

**NARVIK**  
**Narvik Port Authority**  
 PO Box 627  
 Narvik  
 N-8508  
 Norway  
**Contact:** Mr Ivan Jorgensen, Port Captain  
 T: + 47 76 95 03 70  
 F: + 47 76 95 03 84  
 E: ij@portofnarvik.com  
 W: www.portofnarvik.com  
**Location:** At the fjord head of Vestfjorden, North Norway  
**Equipment & Capacity:** LKAB Loading Facilities, 5-7000 tph  
**Bulk Berths:** 26 m depth, no length limit

**ORKANGER**  
**Port of Orkanger**  
 Thamshavn Verk A/S and Co  
 PO Box 10  
 Orkanger  
 7301  
 Norway  
**Contact:** Mrs Anita Berre,  
 T: + 47 72 48 04 00  
 F: + 47 72 48 19 30  
 E: anita.berre@orkla-shipping.no

**OVRE**  
**Aardalstangen**  
 Hydro Aluminium Terminal Berths No 1 and No 2  
 PO Box 303  
 Ovre  
 Aardalstangen  
 N-5870  
 Norway  
**Contact:** Mr Johnny Hovland, Manager Bulk Handling  
 T: + 47 57 64 98 53  
 F: + 47 57 64 97 53  
 E: johanny.hovland@hydro.com

**SAUDA**  
**Sauda Port Authority**  
 P.O.Box 111  
 Sauda  
 4201  
 Norway  
**Contact:** Mr Handelan, Harbour Master  
 T: + 47 52 78 62 72  
 F: + 47 52 78 15 65  
 E: sauski@online.no

**SENTRUM**  
**Oslo Port Authority**  
 PO Box 230  
 Sentrum  
 Oslo  
 N-0103  
 Norway  
**Contact:** Ms Anne Sigrd Hamran, Port Director  
 T: + 47 23 49 2610  
 F: + 47 23 49 2601  
 E: anne.sigrd.hamran@ohv.oslo.no  
 W: www.oslohavn.no  
 The Port of Oslo handles over 500,000 tonnes of cement annually, and up to 200,000 tonnes of grain a year.

**STAVANGER**  
**Port Authority of Stavanger**  
 Nedre Strandgt 51  
 Stavanger  
 4005  
 Norway  
**Contact:** Mr Bjorn Helgoy, Port Director  
 T: + 47 51 50 12 00  
 F: + 47 51 50 12 22  
 E: bjorn.helgoy@stavangerhavn.no  
 W: www.stavangerhavn.no

**STAVANGER**  
**Stavanger Havneseio**  
 Nedre Banegt 60  
 Potsboks 1569

Kjelvene  
Stavanger  
4004  
Norway  
T: + 47 51 89 10 45  
F: + 47 51 89 04 40

## SUNNDALSORA

**Hydro Aluminium Private Terminal**  
PO Box 51  
Sunndalsora  
N-6600  
Norway  
**Contact:** Mr Sigmund Elshaug, Port Manager  
T: + 47 71 69 3384  
F: + 47 71 69 36 07  
E: sigmund.elshaug@hydro.com  
**Location:** North West of Norway  
**Equipment & Capacity:** Two Portal Cranes 15 and 30 ton, 1 pneumatic unloading equipment  
**Bulk Berths:** 300 meter, draft: 10,40 meter high water (planned to increase draft to 13 meter)

## SVOLVAER

**Vagan**  
Vagan Havnevesen KF  
Skipsagentur  
PO Box 121  
Svolvaer  
N8301  
Norway  
**Contact:** Mr Kjell Hansen, Harbour Master  
T: + 47 76 06 79 90  
F: + 47 76 06 79 91  
E: post@vagan-havnevesen.no  
W: www.vagan-havnevesen.no

## PAKISTAN

### KARACHI

**Bulk Trade International**  
1A Anchor House 111  
15C 4th Commercial Lane  
Zamzama  
Karachi  
75600  
Pakistan  
**Contact:** Mr Syed Warasat Hussain, Director  
T: + 92 21 5833981  
F: + 92 21 5833982  
E: bti@atgglobal.net

### KARACHI

**Pak Shaheen Group**  
36-A/2, Lalazar, Opposite Beach  
Luxury Hotel  
Off M.T. Khan Road  
Karachi  
74000  
Pakistan  
**Contact:** Mr Yussuf Farrukh, COE - Services  
T: + 92 21 3285 1800  
F: + 92 21 561 2230  
E: yfarrukh@pakshaheen.com.pk  
W: www.pakshaheen.com.pk

### KARACHI

**PIBT Ltd**  
2nd Floor  
Business Plaza  
Mumtaz Hassan Road  
Off I.I Chundrigar Road  
Karachi  
Sindh  
74000  
Pakistan  
**Contact:** Mr Zeeshan Liaqat, Manager Project Coordination & Research Analyst  
T: + 92 21 3240 0450-53  
F: + 92 21 3240 0281  
E: info@pibt.com.pk  
W: www.pibt.com.pk  
**Equipment & Capacity:** 2 Ship Grab Unloading cranes with rated capacity of 1,850 tons/hr each for

Coal and 1 Ship loading crane with a rated capacity of 1,200 tons/hr for cement & clinker  
**Total Uncovered Storage:** ~160,000 sq.m

## KARACHI

**Port Muhammad Bin Qasim**  
Port Qasim Authority  
PO Box 75020  
Karachi  
75020  
Pakistan  
**Contact:** Captain Azhar, General Manager  
T: + 92 21 927 2111  
F: + 92 21 473 010  
E: info@portqasim.org  
W: www.portqasim.org.pk/

## PAPUA NEW GUINEA

### ALOTAU

**Alotau Port Authority**  
PNG Harbours Board  
PO Box 42  
Alotau  
Papua New Guinea  
**Contact:** Mr John Tungapit, Port Manager  
T: + 675 211 637  
F: + 675 611 276  
E: enquiries@pngports.com.pg  
W: www.pngports.com.pg/

### KAVIENG

**Kavieng Port Authority**  
PNG Harbours Board  
PO Box 127  
Kavieng  
New Ireland  
Papua New Guinea  
**Contact:** Mr S Gems, Port Manager  
T: + 675 984 2182  
F: + 675 984 1408

### KIMBE

**Kieta Port Authority**  
PO Box 65  
Kimbe  
Papua New Guinea  
T: + 675 935134  
E: BusinessManager.Kieta@pngports.com.pg  
W: www.pngports.com.pg

### KIMBE

**Kimbe Port Authority**  
PO Box 65  
Kimbe  
Papua New Guinea  
**Contact:** Mr John Tungapit, Port Manager  
T: + 675 211 637  
F: + 675 935 609  
E: enquiries@pngports.com.pg

### LAE

**Lae Port Authority**  
c/o PNG Harbours Board  
PO Box 563  
Lae  
Papua New Guinea  
**Contact:** Mr Joshua Taruna, Regional Port Manager  
T: + 675 426 434  
F: + 675 856 2506  
E: enquiries@pngports.com.pg

### LAE

**PNG Ports Corporation Limited**  
PO Box 563  
Lae  
Papua New Guinea  
**Contact:** Mr Tony Aelingian Willie, Senior Port Manager  
T: + 675 4722477  
F: + 675 4722543  
E: tony.willie@pngharbours.com.pg  
**Location:** North of Australia - Lae

Port is the biggest port in Papua New Guinea  
**Equipment & Capacity:** 30 tonnes allowed on all berths  
**Bulk Berths:** 400m berth length  
**Total Uncovered Storage:** Approx 1 sq km  
**Total Covered Storage:** Approx 0.5 sq km  
Lae Port handles Roro, Containerised, Bulk fuel Tankers, Gas Tankers, and Gen bulk vessels. Berth length up to 1 km. Port operates on 24 hours operations.

## POPONDETTA

**Oro Bay Port Authority**  
PNG Harbours Board  
PO Box 160  
Popondetta  
Papua New Guinea  
**Contact:** Port Manager  
T: + 675 3 229 263  
F: + 675 3 223 207  
E: enquiries@pngports.com.pg  
W: www.pngports.com.pg/

## RABAU

**Rabaul Port Authority**  
PO Box 592  
Rabaul  
Papua New Guinea  
**Contact:** Mr J Taruna, Regional Port Manager  
T: + 675 921317  
F: + 675 921367  
E: enquiries@pngports.com.pg

## PERU

### AREQUIPA

**Terminal Internacional del Sur SA**  
Tisur SA  
Puerto Matarani  
Arequipa  
Peru  
**Contact:** Snr Mario Hart Potesta,  
T: + 51 54 9 557197  
F: + 51 54 9 557044

### CALLAO

**Conchan Port Authority**  
Empresa Nacional de Puertos  
Terminal Marítimo  
Callao  
Peru  
T: + 51 1 429 9210  
F: + 51 1 465 6717  
W: www.cementoslima.com.pe

### CALLAO

**ENAPU SA**  
Port Terminal of Callao  
Callao  
1No260  
Peru  
**Contact:** Mr Luis Vargas Caballero  
Cooban, President and Chief Executive  
T: + 51 1429 9210  
F: + 51 1469 1011  
E: principal@enapu.gob.pe  
W: www.enapu.com.pe

### CHANCY

**Chancay Port Authority**  
c/o Agencias Unidas Chancay SA  
Malecon de Puerto 248  
Chancy  
Peru  
**Contact:** Port Manager  
T: + 51 2095

### ILO

**Agencia Maritima Busonich**  
c/o Moguegua no 100  
Ilo  
Peru  
**Contact:** Mr Marco Busonich,  
T: + 51 54 782962  
F: + 51 54 782962

E: maritima@cosapidata.com.pe  
W: www.iconet.net.pe/enapu

## IQUITOS

**Iquitos Port Authority**  
Avenida la Marina  
Iquitos  
s/n Panchana  
Peru  
**Contact:** Mr Hernan Marroquin  
Talavera, Port Manager  
T: + 51 94 251955  
F: + 51 94 252041  
W: www.enapu.com.pe

## LA CALETA

**Port Authority of Chimbote**  
Departamento de Ancash Region  
Chavin  
Malecon Grau s/n  
La Caleta  
Chimbote  
Peru  
**Contact:** Mr Julio Cesar Zamorano  
Calvo, Port Manager  
T: + 51 44 323831  
F: + 51 44 321199  
E: chenapu@iconet.net.pe  
W: www.iconet.net.pe/enapu

## LA PERLA

**Autoridad Portuaria Nacional**  
Av. Santa Rosa, 135  
La Perla  
Callao  
Peru  
**Contact:** Ms Veronica Zambrano  
Copello, General Manager  
T: + 511 630 9600 ext 1102  
F: + 511 630 9620  
E: Informes@apn.gob.pe  
W: www.apn.gob.pe

## MOQUEGUA

**ILO Port Terminal**  
Jr Matarana  
Moquegua  
104 100  
Peru  
**Contact:** Mr Julio Zamorano Calvo,  
Office Manager  
T: + 51 1429 9210  
F: + 51 1 465 6717  
E: info@enapu.gob.pe  
W: www.enapu.com.pe/

## PISCO

**General San Martin Port Authority**  
Punta Pejerrey Paracas  
Pisco, Peru  
**Contact:** Mr Alfredo Ibarcena  
Moran, Port Manager  
T: + 51 34 532972  
F: + 51 34 532972  
W: www.enapu.com.pe

## SUPE PUERTO

**Supe Port Authority**  
Giron Callao 302  
Empresa Nacional de Puertos  
Ancash Department  
Supe Puerto  
Peru  
**Contact:** Mr Comte Camino, Port Manager  
T: + 51 34 364045  
F: + 51 34 364045

## TRUJILLO

**ENAPU SA**  
Salaverry Port Terminal  
Calle Cordova s/n  
Salaverry  
Trujillo  
Peru  
**Contact:** Ms Eufrosina Hilda Santa  
Mania Rubio, Manager  
T: + 51 4443 7359  
F: + 51 4443 7359  
E: tpsalaverry@enapu.com.pe  
W: www.enapu.com.pe

## PHILIPPINES

### BATANGAS CITY

**Batangas Port Authority**  
Philippine Ports Authority  
Santa Clara  
Batangas City  
Luzon Island  
Philippines  
**Contact:** Mr Edmond Moreno,  
Manager  
T: + 63 437 231 701  
F: + 63 437 230 1604  
E: alex\_t.cruz@ppa.com.ph  
W: www.ppa.com.ph/  
Port%20Profile/SouthLuzon/  
batangas/batangas.htm

### CAGAYAN DE ORO CITY

**Masao Port Authority**  
Philippine Ports Authority  
Port Management Unit  
Cagayan de Oro City  
Philippines  
**Contact:** Mr Felix M Barcala, Port Manager  
T: + 63 920 8522468  
F: + 63 43 2886187  
E: pmocalapan@yahoo.com  
W: www.ppa.com.ph/

### CAGAYAN DE ORO CITY

**Philippine Ports Authority**  
Philippine Port Authority  
Port District Office of Northern Mindanao  
Agora Gate  
Port Area  
Cagayan de Oro City  
9000  
Philippines  
**Contact:** Mr Bienvenido P Basco,  
Port District Manager  
T: + 63 88 8562819  
F: + 63 88 8562820  
E: info@ppa.com.ph  
W: www.ppa.com.ph

### CEBU CITY

**Cebu Port Authority**  
Philippines Port Authority  
North Reclamation Area  
CIP Complex  
Cebu City  
Philippines  
**Contact:** Mr Manuel Gorme, Acting  
Manager  
T: + 63 32 96241  
E: cpa@cpa.gov.ph

### ILIGAN CITY

**Iligan Port Authority**  
Philippine Ports Authority  
Port Area  
Iligan City  
Philippines  
**Contact:** Mr E L Delacruz, Port  
Manager  
T: + 63 76 621013  
E: ppailigan@yahoo.com

### JOLO SULU

**Jolo Port Authority**  
Philippine Ports Authority  
Jolo Sulu  
Philippines  
**Contact:** Mr Sisali B Arap, Manager  
PMO-Jolo  
T: + 63 2 914  
E: info@ppa.com.ph

### LA UNION

**San Fernando Port Authority**  
Philippine Ports Authority  
Port Management Office  
San Fernando  
La Union  
Luzon Island  
Philippines  
**Contact:** Mr Adolfo Amor Junior,  
Port Manager  
T: + 63 72 412557

F: + 63 72 415580

## LAGAZPI CITY

**Lagazpi Port Management Authority**  
PMO Legazpi  
Pier Site  
Legazpi City  
4500  
Philippines  
**Contact:** Ms Hazel A Garchitorena,  
Acting Terminal Supervisor  
T: + 63 522 480 7890  
F: + 63 522 480 7890

## MAKATI CITY

**Mariveles Port-Smithbell & Co**  
Smith Bell Building  
2294 Pasong Tamo Extension  
Makati City  
1231  
Philippines  
T: + 63 2 816 7851  
F: + 63 2 813-6949  
E: ho@smithbell.com.ph

## MAKATI CITY

**Wilhelmsen-Smith Bell Shipping, Inc.**  
2294 Pasong Tamo Extension  
Makati City  
1231  
Philippines  
**Contact:** Mr Fausto R Preysler Jr,  
President & Chairman  
T: + 63 2 8167851 to 58  
F: + 63 2 8150199 / + 63 2 8136949  
E: preysler@smithbell.com.ph  
W: www.smithbell.com.ph

## MANILA

**Asian Terminals Incorporated**  
A Bonifacio Drive  
Port Area  
South Harbor  
Manila  
Bataan  
1018  
Philippines  
**Contact:** Mr Suhail Al Banna,  
Executive Vice President - Technical  
T: + 63 2 528 6000  
F: + 63 2 527 2467  
E: webmaster@  
asianterminals.com.ph  
W: www.asianterminals.com.ph

## MANILA

**Philippine Ports Authority**  
Port Management Unit  
Bonifacio Drive  
South Harbour Port Area  
Manila  
Philippines  
**Contact:** Atty. JUAN C STA. ANA,  
General Manager  
T: + 53 2 527 4856  
F: + 53 2 527 4854  
E: jcsaana@ppa.com.ph  
W: www.ppa.com.ph

## TACLOBAN

**Philippine Ports Authority**  
Brgy 1 & 4, Port Area,  
Tacloban City  
Tacloban  
Leyte  
6500  
Philippines  
**Contact:** Mr Dominador D. Licayan,  
Port Manager  
T: + 63 53 321 6704  
F: + 63 53 325 7248  
E: pmotacloban@ppavis.com  
W: www.ppavis.com  
**Location:** Lat 11° 15' N ; Long  
125°00' E.. The port is located on  
the NE of Leyte Island and is the  
regional capital of Eastern Visayas.  
**Equipment & Capacity:** Crane -  
25t  
**Bulk Berths:** Length 813m, Draught



along berth 5.78m below MLLW  
**Total Uncovered Storage:**  
 4,459sqm  
**Total Covered Storage:** 576.60sqm

**POLAND**

**GDANSK**

**GBT Sp. z o.o.**

ul. Promowa 1  
 Gdansk  
 80-702  
 Poland  
**Contact:** Mr Rafał Ró a ski,  
 Terminal Manager  
 T: + 48 58 77 09 100  
 F: + 48 58 77 09 119  
 E: rafal.rozanski@gbtgdansk.com

**GDANSK**

**Port of Gdansk Authority SA**

Zamknieta 18  
 Gdansk  
 Pomoranie  
 80-955  
 Poland  
**Contact:** Mr Julian Skelnik, Foreign  
 Relations, Mktng & Promo.  
 Director, Proxy  
 T: + 48 58 737 99 00  
 F: + 48 58 737 99 02  
 E: julian.skelnik@portgdansk.pl  
 W: www.portgdansk.pl

**Location:** Centre of the Southern  
 Coast of the Baltic Sea  
**Equipment & Capacity:** Cranes  
 from 3.2 t to 25t. Conveying  
 systems, defrosting systems,  
 automated sampling machines,  
 railcar tippers, railway sidings etc.  
**Bulk Berths:** PORT FREE ZONE:  
 Area 31 ha; Warehouses area  
 38,553sqm, Warehouses capacity  
 32,000t. Open stores 113,400sqm,  
 Cranes from 6 to 16t.

OLIWSKIE QUAY: Warehouses area  
 30,000sqm, Warehouses capacity  
 15,000t, Elevator 5,000t, Open  
 stores 35,534sqm, Cranes from 6 to  
 16t.

WISLANE QUAY - cranes from 6 to  
 25t,  
 Warehouses area 19,727sqm,  
 Grain elevator 8,500t, Open stores  
 91,307sqm, 2 bunkers 3,945sqm.

PRZEMYSLOWE QUAY - cranes 3t,  
 Warehouses area 11,839sqm,  
 Warehouses capacity 75,000t.

CHEMIKOW QUAY - cranes 8t and  
 gantry cranes 20t, warehouses  
 capacity 75,000t.

RUDDOWE QUAY - cranes from 8 to  
 25t, Open stores 34,610sqm, 2  
 bunkers 5,093sqm.

WEGLOWE QUAY - cranes from 8 to  
 25t, 5 bunkers 12,583sqm.

OBRONCOW POCZTY POLSKIEJ  
 QUAY - cranes from 3.2 to 6.3t,  
 open stores 20,000sqm.

COAL TERMINAL - Open stores  
 17,355sqm, 5 bunkers 73,085sqm.

In Port of Gdansk there are  
 acceptable the vessels with the  
 following parameters: up to 400m in  
 length and 15m draught.

**Total Uncovered Storage:**  
 549,525sqm  
**Total Covered Storage:**  
 107,022sqm

The Port of Gdansk is situated at  
 the intersection of the principal  
 European transport routes, providing  
 the most convenient connection  
 between both Central and Eastern  
 Europe and Scandinavia as well as  
 between Western and Eastern  
 Europe.

**GDANSK**

**PPS Port Polnocny Co Ltd**  
 23 Budowniczych Portu Polnocnego

Str  
 Gdansk  
 80-601  
 Poland  
**Contact:** Mr Andrzej Kasprzak,  
 President  
 T: + 48 58 737 60 52  
 E: polnocny@portgdansk.pl  
 W: www.portgdansk.pl

**GDYNIA**

**Baltic Grain Terminal**

Indyjska 2 Street  
 Gdynia  
 81-336  
 Poland  
**Contact:** Mr Marek Kwiatkowski,  
 Logistics Director  
 T: + 48 58 627 4372  
 F: + 48 58 621 5544  
 E: blztrade@blz.gdynia.pl  
 W: www.port.gdynia.pl

**Location:** North of Poland; Baltic  
 Sea

**Equipment & Capacity:** 2 berth's  
 reloaders: Buhler and Transmec; 1  
 mln tpa

**Bulk Berths:** 2 berths: Indyjskie of  
 245m length and 11m depth;  
 Norweskie of 115m length and 8.5m  
 depth

**Total Covered Storage:** 51,000t  
 (elevator, silos and flat warehouse)  
 The Terminal serves ships up to  
 70,000dwt

**GDYNIA**

**Baltic Ports Organization**

Secretariat  
 c/o Actia Forum  
 Gdynia  
 81-368  
 Poland  
**Contact:** Mr Bogdan Oldakowski,  
 Secretary General  
 T: + 48 58 627 24 67

F: + 48 58 627 24 27  
 E: bpo.office@actiaforum.pl  
 W: www.bpoports.com

**GDYNIA**

**BTDG - Baltic General Cargo**

**Terminal Gdynia Ltd**

Dokerów 7 St  
 Gdynia  
 81-336  
 Poland  
**Contact:** Mr Jacek Dubicki, General  
 Director  
 T: + 48 58 627 40 90  
 F: + 48 58 627 41 07  
 W: www.btdg.pl

**GDYNIA**

**Maritime Bulk Terminal  
 Gdynia Ltd**



ul. Węglowa 4  
 Gdynia  
 81-341  
 Poland  
**Contact:** Ms Dorota Roik, Marketing  
 Dept  
 T: + 48 508 375 146  
 F: + 48 586 215 354  
 E: marketing@mtmg.gdynia.pl  
 W: www.mtmg.gdynia.pl

**Location:** North of Poland on the  
 Baltic Sea

**Equipment & Capacity:** 15 shore  
 grab-hook cranes, capacity of 8, 10,  
 16 and 40 tonnes, 3 self-propelled  
 grab-hook cranes of the lifting  
 capacity of 24-124 tonnes,  
 stationary pneumatic-mechanical  
 conveyor, covered device for grain  
 reloading with the electronic  
 container scales, 2 weighbridges for

wagons and 3 weighbridges for  
 trucks, external parking for 122  
 trucks.

**Bulk Berths:** - Dutch quay: length  
 500m, depth 13m  
 - Southern Pier of Danish quay  
 (dedicated for liquid chemicals):  
 length 170m, depth 9,1m  
 - Swedish quay: length 444m, depth  
 10.6m  
 - Silesian quay: length 353m depth  
 8.6m

**Total Uncovered Storage:**  
 73,070sqm

**Total Covered Storage:** 17,055sqm  
 and 20,000 m3

**GDYNIA**

**Port of Gdynia**

Ul Rotterdamka 9  
 Gdynia 81-337  
 Poland  
**Contact:** Mr Janusz Jarosi ski,  
 Managing Director  
 T: + 48 58 627 40 02  
 F: + 48 58 621 69 16  
 E: marketing@port.gdynia.pl  
 W: www.port.gdynia.pl

**Location:** South-Eastern Baltic Sea  
 Coast

**Equipment & Capacity:** Grabs,  
 mobile hook cranes, conveyors  
 (300 to 1,000 t/h), ship loaders (600  
 t/h for vessels of up to 30,000 dwt)

**Bulk Berths:** Draught along quays:  
 7,90m – 13m  
**Total Uncovered Storage:** 747  
 391,25sqm

**Total Covered Storage:** 220  
 496,08sqm

Three main multipurpose Bulk  
 Terminals, all located close to main  
 maritime entrance and are well-  
 connected to national and  
 international rail and road networks.

**GDYNIA**

**Rudoport SA**

Kpt. Z W Witolda Poinca 1  
 Gdynia  
 80-955  
 Poland  
**Contact:** Dr Eng Jerzy Pasinski,  
 T: + 48 58 6213696  
 F: + 48 58 6213698  
 E: rudoport@portgdansk.pl  
**Location:** Poland Nord - Gdansk  
**Equipment & Capacity:** In  
 investing process  
**Total Uncovered Storage:** 140,000  
 sqm (total uncovered and covered)

**KOLOBRZEG**

**Port Authority of Kolobrzeg**

c/o Polish Baltic Shipping Co  
 ul Portowa 41  
 Kolobrzeg  
 78-100  
 Poland  
**Contact:** Mr W Grzesznik, Director  
 T: + 48 94 352 5211  
 F: + 48 94 352 6612  
 E: info@polferries.pl  
 W: www.polferries.pl

**POLICE**

**Grupa Azoty**

Zakłady Chemiczne "Police" SA  
 ul. Ku nicka 1  
 Police  
 72-010  
 Poland  
**Contact:** Mr Roman Polak, Port  
 Manager  
 T: + 48 91 317 1717  
 F: + 48 91 317 3603  
 E: roman.polak@grupazoty.com  
 W: www.grupazoty.com  
**Location:** = 53°33,7' N =  
 014°35,4' E



**MORSKI  
 TERMINAL  
 MASOWY  
 GDYNIA**



**quality in bulk**

**reliable partner  
 in business**

**MTMG - Morski Terminal Masowy Gdynia Sp. z o.o.**

**www.mtmg.gdynia.pl; mtmg@mtmg.gdynia.pl; ul. Węglowa 4; 81-341 Gdynia; tel. 48 58 627 43 18**

**Total Uncovered Storage:** 15 tys. m<sup>2</sup>  
**Total Covered Storage:** N/A

## SWINOUJSCIE

**Port Handlowy Swinoujscie Sp. z o.o.**

ul. Bunkrowa 1  
 Swinoujscie  
 Zachodniopomorskie  
 72-602  
 Poland

**Contact:** Mr Lukasz Przyszlak,  
 Trade & Marketing Director  
 T: + 48 91 32 77 524  
 F: + 48 91 32 77 520  
 E: lukasz.przyszlak@phs.com.pl  
 W: www.phs.com.pl

**Location:** North West of Poland on the Baltic Sea

**Equipment & Capacity:** 9 shore cranes (10-140 ton capacity), 1 coal loading device, Coal Terminal, Cereal Terminal, Iron Ore Terminal, Biomass Terminal  
**Bulk Berths:** 4 berths  
**Total Uncovered Storage:** 156,235sqm

**Total Covered Storage:** 23,930sqm  
 Max ships' draught 13.2m, port's annual handling potential ca 12 million tons

## SZCZECIN

**Andreas sp. z o.o.**

St Oder 72  
 Szczecin  
 71820  
 Poland  
**Contact:** Mr P Andreas, President  
 T: + 48 91 453 8691  
 F: + 48 91 421 5914  
 E: p.andreas@andreas.szczecin.pl  
 W: www.andreas.szczecin.pl

## SZCZECIN

**Bulk Cargo - Port Szczecin Sp. z o.o.**

Gdanska 21  
 Szczecin  
 Zachodniopomorskie  
 70-661  
 Poland

**Contact:** Mr Bogdan Walczak,  
 Marketing Director  
 T: + 48 91 4 307 112  
 F: + 48 91 4 307 115

**E:** bwalczak@bulkcargo.com.pl  
**W:** www.bulkcargo.com.pl

**Location:** At the mouth of the Odra river, the 65 km from the coast of the Baltic Sea, at the crossroads of transport routes from north to the south of Europe

**Equipment & Capacity:** Stationary cranes x 31, Mobile cranes x 14, Loaders x 14, Bulldozers x 5, Forklift trucks x 42, Locomotive x 3, Wheel tractors x 12, Conveyors x 20, Trailers x 22  
**Bulk Berths:** 11 quays available. From 188m - 525m length and 6.4m - 9.15m depth

**Total Uncovered Storage:** 300,000sqm

**Total Covered Storage:** 40,000sqm

We are the most multipurpose stevedoring company with comprehensive storing and reloading offer covering all groups of cargoes.

## SZCZECIN

**Przedsiębiorstwo Usług Portowych**

Elewator EWA S-ka z.o.o.  
 ul Hryniewieckiego 26  
 Szczecin  
 70-606  
 Poland  
**Contact:** Mr Wojciech Kazmierczak,

**President/Director**  
 T: + 48 91 4 308266  
 F: + 48 91 4 624165  
**E:** sekretariat@elewator-ewa.szczecin.pl  
**W:** www.elewator-ewa.szczecin.pl

## SZCZECIN

**Szczecin and Swinoujscie Seaports Authority**

ul Bytomska 7  
 Szczecin  
 70-603  
 Poland

**Contact:** Mrs Katarzyna Malinowska, Manager of Marketing Division  
 T: + 48 914 308 139  
 F: + 48 914 624 145

**E:** k.malinowska@port.szczecin.pl  
**W:** www.port.szczecin.pl

**Location:** North-west Poland, close to Germany border. The port of Swinoujscie is situated just on the Baltic coast. The port of Szczecin is situated alongside the arms of the Odra River - up-land 65km from the sea.

**Equipment & Capacity:** winoujcie: 1 x 40t and 1 x 25t gantry crane, 2 grab gantry cranes of 20t capacity, shiploader of 2 000tph capacity, 2 wagon tippers and defreezing station and a belt conveyors system. Szczecin: 1 x wagon tipper and 1,000tph shiploader. 2 cranes and 7 telescopic ship loaders. Loading/discharging of vessels at max rate of 10,000tpd for grain and 3,500tpd for feed.

**Bulk Berths:** Swinoujscie: Bulk carriers up to 270m in length, 13.2m draught  
 winoujcie quays: Górników (245m long, 12.8m draught), Hutników (329m long, 13.2m draught),

Chemików (282m long, 12.8m draught), Portowcow (245m long, 11.9m draught).

Szczecin: Vessels up to 210m in length and 9.15m draught  
 Szczecin: quays: Górniki (282m long, 9.15m draught), Noteckie (283m long, 6.4m draught), Regalica (210m long, 6.7m draught), Huk (268m long, 7.20m draught), Gliwickie (260m long, 9.15m draught), Bytomskie (342m long, 9.15m draught), Wa brzeskie (270m long, 8.7m draught), Pirs W głowy (188m long, 9.15m draught), Chorzowskie (290m long, 9.15m draught), Katowickie (525m long, 9.15m draught), Parnica (320m long, 7.0m draught).

Grain silo quays in Szczecin: Zbo owe quay (220m long, 9.15m draught), Snop (316m long, 5.8m draught), Bydgoskie (125m long, 5.8m draught), Poznanskie (80m long, 5.2m draught).

**Total Uncovered Storage:** winoujcie: 156,000sqm of open storage for up to 700,000 tonnes of coal. An open storage area of 70,000 tonne capacity for iron ore. Szczecin: 267,000 sqm. 35,000sqm of open storage for up to 170,000t of coal.

**Total Covered Storage:** winoujcie: 20,000 sqm. 100,000-tonne capacity warehouse with its belt conveyor installation. Szczecin: 27,000 sqm

Grain silo in Szczecin: 73,000 cu m. Silo EWA has a total capacity of 55,000t including 158 bins and 13 storeys of flat storage. There are three other silos, of total storage capacity over 15,000t.

The port complex of Szczecin and Swinoujscie is of crucial significance for Polish economics. That largest dry bulk cargo centre at Polish sea-coast handles nearly 50 % of the country's coal exports and nearly 100% of its sea-shipped iron ore imported.

computerized.

## BARREIRO

**Barreiro Terminal - Atlanport Sociedade de Exploração Portuária, S.A**

Largo Alexandre Herculano  
 Complexo Industrial da Quimiparque  
 Apartado 5109  
 Barreiro  
 2831-904  
 Portugal

**Contact:** Eng Ramalho de Nascimento, Executive Director  
 T: + 351 21 206 6610/11/12  
 F: + 351 21 206 6629

**E:** atlanport@atlanport.pt  
**W:** www.ete.pt/Grupo/Empresas/Atlanport\_E.htm

**Location:** Lisbon (Located on the south bank in the Tagus River)

**Equipment & Capacity:** Installed handling capacity: 800,000tpa  
 Equipment:

Quay no. 2: Two 10-Ton Porticos (500Tph each), Quay no. 5: Two 5-Ton Road cranes, 1 cargo conveyor belt with a rhythm of approximately 150tph and a power of 18.5 kw, 2 spinning cranes to handle scrap, 4 loading shovels + 3 forklifts, respectively, de 2,5, 3 and 10 Tons.

**Bulk Berths:** Length of quay: 170m  
 Depths: -10.5m and -9.5m ZH

This terminal receives mainly solid bulk.

## DOCA DE ALCÂNTARA

**Lisbon Port Authority**

Administração do Porto de Lisboa  
 Edifício Infante D. Henrique  
 Doca de Alcântara  
 Doca de Alcântara  
 1399-012 Lisboa  
 Portugal

**Contact:** Ms Sandra Rodrigues,  
 Commercial Relations  
 T: + 351 21 3611026 / 5  
 F: + 351 21 392 2041

**E:** srodrigues@portodelisboa.pt  
**W:** www.porto-de-lisboa.pt

**Location:** In the Tagus estuary.

**Equipment & Capacity:** Dry bulk cargo; more than 5,200,000t last year, of which 3,550,000t were agri-bulk.

**Bulk Berths:** The port of Lisbon has several specialised terminals for dry bulk cargo on both banks of the Tagus.

The port of Lisbon is a natural port, opened throughout the whole year. Please see our website www.porto-de-lisboa.pt for more information.

## FUNCHAL

**Port Authority of Madeira**

Avenida Sa Cameiro 4  
 Funchal  
 Madeira  
 9004-518  
 Portugal

**Contact:** Mr Fernando Silva,  
 Administration  
 T: + 351 291 208 600  
 F: + 351 291 220 196

**E:** marketing@apram.pt

## GAFANHA DA NAZARÉ

**APA - Administração do Porto de Aveiro, S.A.**

Edifício 9 - Forte da Barra  
 Apartado 91  
 Gafanha da Nazaré  
 3834-908  
 Portugal

**Contact:** Dr Luis Manuel Dionísio Marques, Board Member  
 T: + 351 234 393 300  
 F: + 351 234 393 399

**E:** geral@portodeaveiro.pt  
**W:** www.portodeaveiro.pt  
**Location:** Latitude 40° 39' N

Longitude 8° 48' 5 W  
 Situated in an internal lagoon, known as the Ria de Aveiro, in the Atlantic Eastern coast of Europe.  
**Bulk Berths:** Total Quay Length: North Terminal - 900 m, South Terminal - 400 m, Solid Bulk Terminal - 750m

**Total Uncovered Storage:** North Terminal - 328,000 sqm, South Terminal - 47,000 sqm, Solid Bulk Terminal - 260,000 sqm

Recording an annual traffic of 3 million tonnes, Aveiro is a multifunctional port, performing a primordial part in its area of influence rendering services to: ceramics; chemical; viticultural; metallurgical; wood and by-products; agri-products and building construction industries.

## LECA DA PALMEIRA

**Port Authority of Leixões**

Administração dos Portos do Douro e Leixões, S.A.  
 Avenida da Liberdade  
 Apartado 3004  
 Leca da Palmeira  
 Matosinhos  
 4451-851  
 Portugal

**Contact:** Mr Amadeu Ferreira da Rocha, Director do Gabinete de Estudos e Planeamento  
 T: + 351 229 990 700  
 F: + 351 229 955 062

**E:** correio@portofleixoes.pt  
**W:** www.apdl.pt

## LISBON

**APL - Administration of Port of Lisbon**

Doca de Alcântara  
 Lisbon  
 1399-012  
 Portugal

**Contact:** Mr Fernanda Silva,  
 Marketing  
 T: + 351 21 361 1023  
 F: + 351 21 862 0308

**E:** fpsilva@portodelisboa.pt  
**W:**

www.portodelisboa.pt/.../PORT\_FACILITIES/

Port of Lisbon is a strategic platform for the agri-food bulk segment that comes from America and then redistributed between Iberian and European markets, proclaiming its national leadership in this segment.

## LISBON

**Iberol - Sociedade Iberica de Biocombustíveis e Oleaginosas, SA**

Av. Frei Miguel Contreras  
 54-2  
 Lisbon  
 1700-213  
 Portugal

**Contact:** Snr José António, Logistic Director  
 T: + 351 21 843 16 24  
 F: + 351 21 843 16 92

**E:** jose.antonio.iberol@sortico.pt  
**W:** www.iberol.com.pt

## LISBON

**Portsines - Terminal Multipurpose de Sines**

Rua Nova do Carvalho, 71, 4º Floor  
 Lisbon  
 1200-291  
 Portugal

**Contact:** Eng Francisco Ramalho do Nascimento, Executive Director  
 T: + 351 21 112 8568  
 F: + 351 21 112 8568

**E:** sines@portsines.pt  
**W:** www.ete.pt/

**Location:** Sines, Portugal  
 37° 56' 18" N 8° 51' 00" W

**Equipment & Capacity:** 10 million tons

**A SEA OF SOLUTIONS FOR YOUR BUSINESS**

Shipping, port operations, inland waterways, logistics, shipping agents, shipbuilding and engineering.

URUGUAY  
 COLOMBIA  
 PORTUGAL  
 CAPE VERDE  
 MOZAMBIQUE

GRUPO E.T.E.

**ETE GROUP, YOUR RELIABLE PARTNER.**

ATLANPORT | AUTOGUER | AVEIPORT | EMPRESA DE TRÁFEGO E ESTIVA | ETE COLOMBIA | ETE LOGÍSTICA | ETE LOGÍSTICA DE MOÇAMBIQUE | ETE SGPS | ETG | EUROLINE | MANICARGAS | MARDANA | MAREAGOR | MARFRETE | MARFRETE AÇORES | MARFRETE PORTO | NAVALPRIME | NAVALTAGUS | NAVEX | PORTSINES | S & C | SOFRENA | TCGI | TRANSINSULAR | TRANSINSULAR AÇORES | TRANSINSULAR MADEIRA | TRANSFRAL TRADING | TRANSPORTES SOUSA MENDES | TSA | VIEIRA & SILVEIRA

www.ete.pt

## PORTUGAL

### AVEIRO

**Socarpor (Aveiro) SA**  
 Av. Dr. Lourenço Peixinho,  
 15-5B

Apartado 593  
 Aveiro  
 3801-901  
 Portugal

**Contact:** Capt Ferreira Jorge, Managing Director  
 T: + 351 234 378 790  
 F: + 351 234 378 791

**E:** socarpor@socarpor-aveiro.pt  
**W:** www.socarpor-aveiro.pt

**Location:** Port of Aveiro 40° 38,5' N 8° 44,9' W

**Equipment & Capacity:** Gottwald Mobile Harbour Cranes - 65 up to 120 Mtons lifting capacity  
 Unloading rate 1000 Mtp

**Bulk Berths:** 300m of quay length w/alongside draught up to 10m

**Total Uncovered Storage:** 130,000sqm

**Total Covered Storage:** 20,250sqm / 60.000 Mtons of steel silos storage capacity  
 Fully environment friendly Terminal

Completely enclosed conveying system from ship to silos and transfer from silos to truck or rail wagon. Monitor control room fully



2 Shiploaders, 2 stackers reclaimers, 1 shiploader, 1 railway loading station, 1 Wheel Crane capacity 40 tons, 1100 m of quay  
**Bulk Berths:** 190,000 DWT  
 Max Draught 18 m

**LISBON**

**Silopor - Empresa de Silos Portuários, SA**  
 (Beato Bulk Foodstuffs Terminal)  
 Terminal Portuário do Beato  
 Rua da Cintura do Porto de Lisboa  
 Lisbon  
 1900-263 Lisboa  
 Portugal  
**Contact:** Mr Carlos Silva, Commercial Manager  
 T: + 351 21 392 32 61  
 F: + 351 21 392 32 69  
 E: carlos.silva@silopor.com  
 W: www.silopor.pt  
**Location:** Lisbon (Located on the north bank in the Tagus River)  
**Equipment & Capacity:** Installed handling capacity: 1,320,000tpa. Equipment: 1 pneumatic unloader (600tph) with two telescopic lances, 1 mechanical unloader (600tph) with a lance.  
**Bulk Berths:** Length of Quay: 198m  
 Depths: -7.3m ZH  
 This terminal is equipped for handling solid bulk. Wheat, barley, corn, oatmeal, broad beans and alfalfa are the main merchandise handled.

**LISBON**

**Silopor - Empresa De Silos Portuários, SA**  
 (Trafaria Bulk Foodstuffs Terminal)  
 Rua das Matas Nacionais  
 Lisbon  
 2825-867 Trafaria  
 Portugal  
**Contact:** Mr Carlos Silva, Commercial Director  
 T: + 351 21 392 3260  
 F: + 351 21 290 3269  
 E: carlos.silva@silopor.com  
 W: www.silopor.com  
**Location:** Lisbon (Located on the south bank in the Tagus River)  
**Equipment & Capacity:** Installed handling capacity: 2,200,000tpa. Equipment: 3 pneumatic unloaders (1,000 tph each) with two reversible lances, 4 loaders with two loading shovels each, Conveyor belt to the silos.  
**Bulk Berths:** Length of Quay: 210m+220m+240m+225m  
 Depths: -7m/-14m/-13m/-17.5m ZH  
 The deep water terminal of Trafaria is one of the largest in Europe, with a total storage capacity of 200,000 tonnes for grain, derived products, and oleaginous products and other agricultural foodstuffs. It receives Panamax and Capesize vessels.

**LISBON**

**Sovena - Oilseeds Portugal, SA**  
 (Palença Bulk Foodstuffs Terminal)  
 Palença de Baixo - Apartado 24  
 Lisbon  
 2801-801Almada  
 Portugal  
**Contact:** Eng<sup>a</sup> Lina Dionísio,  
 T: + 351 21 294 90 00  
 F: + 351 21 294 90 19  
 E: lina.dionisio@sovena.pt  
 W: www.sovenagroup.com/  
**Location:** Lisbon (Located on the south bank in the Tagus River)  
**Equipment & Capacity:** Installed handling capacity: 1,570,000tpa. Equipment: 2 pneumatic unloaders (600tph each), 1 mechanical unloader (900tph), 1 mobile loader for vessels (600tph), 1 barge loader (600tph), 2 pipelines of 10" and 1 of

6" (Quay no. 2), 1 pipeline of 10" (Quay no. 1).  
**Bulk Berths:** Length of Quay: 100m+180m  
 Depths: -12.5m/-15m ZH  
 This terminal handles solid bulk (oleaginous seeds) and liquid bulk (edible oils).

**LISBON**

**TMPB - Poço Bispo Multipurpose Terminal**



Largo do Corpo Santo, 21  
 Lisbon  
 1200-129  
 Portugal  
**Contact:** Eng António Jordão, Operations Manager  
 T: + 351 211 128 048 / + 351 916 892 906  
 F: + 351 211 128 052  
 E: antonio.jordao@ete.pt  
 W: www.ete.pt/  
**Location:** Lisbon (Located on the north bank in the Tagus River)  
**Equipment & Capacity:** Installed handling capacity: 2,000,000tpa  
 Equipment: 2 Mobil Cranes, 40t and 64t respectively, 3x 6t Electrical rail crane, 2 reach stackers, 2 hoppers, 5 frontal forklifts, 3 loading shovel, 3 BobCats.  
 5 floating cranes, 15 barges with 45,000 tons capacity, 3 tug boats.  
**Bulk Berths:** Length of quay: 420m  
 Depths: -5 e -6m ZH  
**Total Uncovered Storage:** 9,950sqm  
**Total Covered Storage:** 10,100sqm  
 The terminal handles all types of general cargo, special break bulk and project and is particularly active on grain bulk.

**LISBON**

**TPB - SILOPOR SA**  
 (Beato Silopor Terminal)  
 R. Cintura do Porto de Lisboa  
 Lisbon  
 1900-263 Lisboa  
 Portugal  
**Contact:** Mr Helder Cruz,  
 T: + 351 21 862 11 60  
 F: + 351 21 862 03 08  
 E: comercial@tmb.pt  
 W: www.silopor.pt  
**Location:** Lisbon (Located on the north bank in the Tagus River)  
**Equipment & Capacity:** Installed handling capacity: 252,000tpa  
 Equipment: 3 Auto Cranes, respectively, de 70, 90 and 140 Ton, 6 6-Ton Electrical road cranes, 5 12-Ton Electrical road cranes, 31 electric/diesel forklifts; 4 loading shovels; 17 palette holders; 3 grain hoppers.  
**Bulk Berths:** Length of quay: 500m  
 Depths: -6 e -7m ZH  
**Total Uncovered Storage:** 5,500sqm  
**Total Covered Storage:** 15,000sqm  
 The TMB receives all types of general cargo, and is equipped to handle breakbulk cargo and some types of solid bulk. Roles of paper, aluminium, fruit and sugar are the merchandise which is mostly handled here.  
 Short-sea vessels mainly moor here.

**SETUBAL**

**Junta Autonoma Do Porto De Setubal**  
 Pracaj De Republica  
 Setubal  
 2900  
 Portugal

**Contact:** Mr Antonio Reairo,  
 T: + 351 265 235 667  
 F: + 351 265 534 622  
 E: suporte@mail.telepac.pt  
 W: www.cidadevirtual.pt

**SETUBAL**

**Sadomar**  
 Rua Praia Da Saude 231  
 Setubal  
 2900  
 Portugal  
**Contact:** Mr Jose M Sardinha,  
 T: + 351 65 2908  
 F: + 351 65 523 002

**SINES**

**Porto de Sines SA**  
 Apartado 16  
 Sines  
 750-953  
 Portugal  
**Contact:** Ms Ana-Rita Rosa, Marketing  
 T: + 351 269 860 600  
 F: + 351 269 860 790  
 E: ana.rosa@portodesines.pt  
 W: www.portodesines.pt

**TRAFARIA**

**Trafaria Terminal - Silopor**  
 Rua das Matas Nacionais  
 Trafaria  
 2825-867  
 Portugal  
**Contact:** Mr Francisco Belo, Manager  
 T: + 351 21 392 33 50/360  
 F: + 351 21 290 52 45  
 E: francisco.belo@silopor.com  
 W: www.silopor.pt  
**Location:** South Bank of Tagus River at Lisbon's Harbour  
**Equipment & Capacity:** Discharge: 3 Pneumatic mobil shipunloaders with a rate of 1,000tph each. Loading: Sea Going Vessels and Barges with a rate of 2, 000tph Loading Trucks: 7 000tpd  
**Bulk Berths:** Two intake quays for ships with 20m and 18m depths respectively, able to receive ships up to 100000 dwt.  
**Total Uncovered Storage:** Not applicable  
**Total Covered Storage:** 200,000 Tons in Vertical storage with 114 separated Vertical Bins  
 HACCP and SGSA Implemented  
 NP EN ISO 22000:2005 Certified

**VILA FRANCA DE XIRA**

**Alhandra Terminal- Cimpor Industria de Cimentos SA**  
 Centro de Produção de Alhandra - Praçeta Teófilo de Araújo Rato, Apartado 1  
 Vila Franca de Xira  
 2601-908 Alhandra  
 Portugal  
**Contact:** Dr Ana Cristina Ascenso,  
 T: + 351 21 940 87 00  
 F: + 351 21 940 87 33  
 E: aascenso@cimpor.com  
 W: www.cimpor.pt  
**Location:** Lisbon (Located on the north bank in the Tagus River)  
**Equipment & Capacity:** Installed handling capacity: 430,000tpa  
 Equipment: Loading station for bulk -300tph  
**Bulk Berths:** Length of Quay: 177m  
 Depth: -5m ZH  
**Total Uncovered Storage:** Licensed Area: 80,705sqm  
 Solid bulk cargo, destined for the production of cement, is handled at this terminal.

**PUERTO RICO**

**SAN JUAN**

**Port of Ponce**  
 Port of the Americas Authority  
 PO Box 362350  
 San Juan  
 00936-2350  
 Puerto Rico  
**Contact:** Mr Thomas E Kierce, Communications Management Consultants  
 T: + 1 787 274 8181  
 F: + 1 787 274 0140  
 E: cmccorporation@cmc-pr.com  
 W: www.portoftheamericas.com

**SAN JUAN**

**Puerto Rico Port Authority**  
 PO Box 362829  
 San Juan  
 PR 009366-2829  
 Puerto Rico  
**Contact:** Mr Herman Sulsona, Executive Director  
 T: + 1 787 29 8480  
 F: + 1 787 22 7867

**QATAR**

**DOHA**

**Qatar Flour Mills Co**  
 PO Box 1444  
 Doha  
 1444  
 Qatar  
**Contact:** Mr Tarique Mohammad, General Manager  
 T: + 974 4415000  
 F: + 974 4438137  
 E: qfmmgmt@qatar.net.qa  
 W: www.qatarflourmills.com

**DOHA**

**Umm Said Ports Authority**  
 Mesaieed  
 PO Box 313  
 Doha  
 Qatar  
**Contact:** Harbour Master  
 T: + 974 457 457  
 F: + 974 413 563  
 E: harbourdohaport@qatar.net.qa

**REPUBLIC OF**

**CONGO**

**POINTE NOIRE**

**Port Authority of Pointe Noire**  
 PO Box 711  
 Pointe Noire  
 Republic of Congo  
**Contact:** Administration Officer  
 T: + 242 940052  
 F: + 242 942042  
**Location:** Lat: 0° 47' 4" S  
 Long: 11° 49' 58" E  
**Bulk Berths:** Cargo pier max depth: 3.4m - 4.6m

**CONAKRY**

**Conakry Port Authority**  
 Direction du Port  
 PO Box 534  
 Conakry  
 Republic of Guinea  
**Contact:** Mr M Duocure, Harbour Master  
 T: + 224 442737  
 F: + 224 412604

**CONAKRY**

**Direction du Port de Kamsar**  
 Office d'Aménagement -de-Boke  
 PO Box 820  
 Conakry  
 Republic of Guinea

**Contact:** Mr M.L. Cisse, Director  
 T: + 224 163 2117  
 F: + 224 163 2116

**CONAKRY**

**Port Autonome de Conakry**  
 PO Box 805  
 Conakry  
 Republic of Guinea  
**Contact:** Mr Bangley Camara, Director General  
 T: + 224 412 737  
 F: + 224 412 604  
 E: pac@eti-bull.net

**REPUBLIC OF**

**YEMEN**

**HODEIDAH**

**Hodeidah Port**  
 Yemen Red Sea Ports Corporation  
 PO Box 3183  
 Hodeidah  
 Hodeidah  
 Republic of Yemen  
**Contact:** Eng. Issa A. Hashem, Executive Chairman  
 Chairman of the board  
 T: + 967 3 217064  
 F: + 967 3 211561  
 E: chairman@hodport.com  
 W: www.hodport.com

**REUNION**

**CEDEX**

**Port Réunion**  
 5 Bis Rue de Paris  
 Saint Denis  
 Cedex 97821  
 Reunion  
**Contact:** Ms Alix Diringier, Communications Director  
 T: + 262 262 26 6540  
 E: alix@21sud.net  
 W: www.reunion.cci.fr

**LE PORT CEDEX,**

**REUNION**

**Direction Departementale de L'Equiment**  
 2 Rue Evariste de Parry  
 PO Box 2002  
 Le Port Cedex, Reunion  
 97821  
 Reunion  
**Contact:** Capt M Berthelot, Harbour Master  
 T: + 262 420955  
 F: + 262 420602

**ROMANIA**

**AGIGEA**

**Silotrans SRL**  
 Constanta Port - South  
 Agigea  
 Dobrogea  
 907015  
 Romania  
**Contact:** Mr Djordje Krikjilo, Silo Manager  
 T: + 40 241 743350  
 F: + 40 241 743250  
 E: ConstantaSilotrans@chsinc.com  
 W: www.chsinc.com  
**Location:** Constanta Port (Romania)  
 West Coast of Black Sea  
**Equipment & Capacity:** Shiploader: 800tph  
 Shipunloaders: 2 x 400tph  
 Handling equipment: 800tph  
**Bulk Berths:** Unloading berth: water depth 11m  
 Loading berth: water depth 12.5m  
**Total Uncovered Storage:** -  
**Total Covered Storage:** 6,000sqm

(108,000mt wheat basis)

**BRAILA**

**Braila Port Authority**  
 Harbour Master's Office  
 Gara Fluviala Street  
 Braila  
 Romania  
**Contact:** Mr Vladut Branza,  
 T: + 40 239 612 184  
 F: + 40 2 39 612066  
 E: capitania-braila@rna.ro  
 W: www.rna.ro

**CONSTANTA**

**Comvex SA**  
 Incinta Port Dana 80-84  
 Constanta 900900  
 Romania  
**Contact:** Mr Viorel Panait, Terminal Manager  
 T: + 40 241 639 016  
 F: + 40 241 639 010  
 E: viorelpanait@comvex.ro  
 W: www.comvex.ro  
**Location:** Western Black Sea Coast  
**Equipment & Capacity:** Three Shipunloaders 50t lifting cap/2000tph discharging cap-each. Four Stackers reclaimers. Three barge loaders. One Railcars loading terminal.  
**Bulk Berths:** 18m depth  
 17.5m SWAD  
**Total Uncovered Storage:** 64 HA  
 Up to 3.0 mil mt storage capacity simultaneously; sprinkler installations for dust control; no other restrictions for vessels sizes; belt conveyors system with high operational flexibility, full covered transfer points and total length of 22km.

**CONSTANTA**

**SC MINMETAL SA**  
**Constanza / Romania**  
 Incinta Port  
 Berth 64  
 Constanta 900900  
 Romania  
**Contact:** Mr Ghebar Liviu, General Director  
 T: + 40 241 639 035  
 F: + 40 241 639091  
 E: office@minmetal.ro  
 W: www.minmetal.ro

**CONSTANTA**

**SC Silotrans Srl**  
 Incinta Port Constanta Sud Mol 1S  
 Constanta  
 907015  
 Romania  
**Contact:** Mrs Corina Ionescu, Economist  
 T: + 40 241 602290  
 F: + 40 241 743250  
 E: office@silotrans.ro

**CONSTANTZA**

**Constantza Port Administration**  
 Incinta Port  
 Gara Maritima  
 Constantza 8700  
 Romania  
**Contact:** Ms E. Ihagi, Marketing & Sales  
 T: + 40 241 601211  
 F: + 40 241 619 512  
 E: apmc@constantza-port.ro  
 W: www.constantza-port.ro

**CONSTANTZA**

**Sicim SA**  
 Incinta Port  
 Constantza  
 8700  
 Romania  
**Contact:** Mr Adrian Neagu, Terminal Manager  
 T: + 40 241 677 077

F: + 40 241 639015  
E: mamsicim@sicim.ro

## SULINA

**Sulina Free Zone Administration**  
Port Operations Department  
202 First Street  
Sulina  
8229  
Romania  
**Contact:** Ms Miranda Felizia,  
Commercial Director  
T: + 402 40 543241  
F: + 402 40 543294  
E: office@azsulin.ro

## RUSSIA

### ARKANGELSK

**Port of Arkangelsk**  
52 Triotsky Prospect  
Arkangelsk  
163000  
Russia  
**Contact:** Mr V N Titov, General Director  
T: + 7 8182 210 580  
F: + 7 8182 657 724  
E: port@ascp.ru  
W: www.ascp.ru

### KALININGRAD

**Transmarine**  
Kaliningrad Portovaya 24  
Kaliningrad  
Russia  
**Contact:** Mr Nikolai Apektin,  
Managing Director  
T: + 7 4012 632 256  
F: + 7 4012 632 210  
E: na@transmarine.ru  
W: www.transmarine.ru

### MOSCOW

**Lavna Seaport**  
Shubinsky per., 6/4  
Moscow  
Russia  
**Contact:** Mr Alexander Aliev,  
General Manager  
T: + 749 5660 5141 ext 858  
F: + 74957354332  
E: aar@portmc.ru

### MOSCOW

**North Western Management Co., Ltd**  
Gagarinsky per. 33  
Moscow  
119002  
Russia  
**Contact:** Mr Alexander Aliev,  
Department Chief  
T: + 749 5735 4331  
F: + 749 5735 4331  
E: aar@portmc.ru  
W: www.vpnet.ru

### MURMANSK

**Port of Murmansk Authority**  
Portoviy Proezd 19  
Murmansk  
183024  
Russia  
**Contact:** Mr Dmitriev Alexander,  
Harbour Master  
T: + 7 8152 689 111  
F: + 7 8152 423 127  
E: mmtp@mmtp.ru  
W: www.murmansk.ru

### NAKHODKA

**Nakhodka Port Authority**  
22 Port Street  
Nakhodka  
Primorsky Krai  
692900  
Russia  
**Contact:** Mr Nikolay L. Pesotsky,  
Commercial Director  
T: + 7 4236 6198 35

F: + 7 4236 6198 00  
E: nikolay.pesotsky@ncsp.ru  
W: www.ncsp.ru

### NAKHODKA (VRANGEL)

**Vostochny Port (OJSC)**  
Vnutriportovaya st. 47  
Nakhodka (Vrangel)  
Russia  
**Contact:** Mr Anatoly Lazarev,  
Managing Director  
T: + 7 4236 665 271  
F: + 7 4236 665 153  
E: vp@vpnet.ru  
W: www.vpnet.ru/eng/index\_eng.htm  
**Location:** Far East of Russia  
(Southeast of the Nakhodka Bay (Japan Sea)).  
**Equipment & Capacity:** 33-36 million tonnes  
**Bulk Berths:** LOA: 190 to 280  
Draught: 12.2 to 16  
DWT: 60,000 to 150,000  
**Total Uncovered Storage:** 377 120sqm  
Vostochny Port is a high-tech seaport located in the Far East of Russia. It is the largest coal port in Russia which includes Specialized Coal Terminal and General Cargo Terminal. In 2012 Vostochny Port commenced the expansion of the Specialized Coal Terminal which will allow the Port to increase its annual throughput to 33-36 mio t by 2020

### NOVOROSIYSK

**Novorossiysk Port Authority**  
2, Mira str.  
Novorossiysk  
Krasnodar Region  
353900  
Russia  
**Contact:** Mr Georgiy Antonyan,  
Harbour Master  
T: + 7 8617 602 516  
F: + 7 8617 676 378  
E: referent@nle.ru  
W: www.nle.ru

### SAINT PETERSBURG

**Port of Ust-Luga**  
Novgorodskaya St 13/A  
Saint Petersburg  
191144  
Russia  
**Contact:** Mr Dmitry Kolomiets,  
General Manager  
T: + 7 812 438 18 46  
E: info@ust-luga.ru  
W: www.ust-luga.ru/

### SAINT PETERSBURG

**Seaport of St Petersburg JSC**  
Mezhevoy Kanal 5  
Saint Petersburg  
198035  
Russia  
**Contact:** Ms Alexandra Chaschina,  
Specialist of Department of PR and Advertising  
T: + 7 812 714 91 25  
F: + 7 812 714 94 98  
E: a.chaschina@seaport.spb.ru  
W: www.seaport.spb.ru  
**Location:** North West Russia on the Baltic Sea  
**Equipment & Capacity:** 56 gantry cranes up to 40 tons hoisting capacity, a floating crane of 300 tons capacity, 2 Liebherr mobile rubber-tyred cranes LHM 600 with the lifting capacity up to 140 tons, 1 truck-mounted crane with the lifting capacity of 55 tons, 244 different specialized loading mechanisms.  
**Bulk Berths:** 32 berths in disposal with total length 5,3 km and draught up to 11.5m.  
**Total Uncovered Storage:** 412,000sqm  
**Total Covered Storage:** 46,000sqm  
The JSC "Seaport of St. Petersburg" is the largest operator providing dry cargo transshipment in Saint-

Petersburg port and the North-West of Russia.

### SAINT PETERSBURG

**Ust-Luga Coal Terminal "Rosterminalugol", JSC**  
Moskovsky avenue, 89, office 400  
Saint Petersburg  
196 084  
Russia  
**Contact:** Mr Artur Sedov, Operating Director  
T: + 7 812 324 54 03  
F: + 7 812 324 54 53  
E: info@oao-rtu.ru  
W: www.oao-rtu.ru

### TAMAN

**Management Company EFCO**  
Port of Taman  
Building 4  
119017 Mosco  
Ul. Big Ordynka 40  
Taman  
353555  
Russia  
**Contact:** Mr A Harlan,  
E: a.harlan@mgindustry.ru

### TUAPSE

**Port of Tuapse Authority**  
8 Gorkogo Street  
Tuapse  
352800  
Russia  
**Contact:** Mr Oleg Antonov, General Director  
T: + 7 86167 76 4 00  
F: + 7 86167 76 4 03  
E: map@tuapseport.ru  
W: www.tuapseport.ru

### UGLEGORSK

**Uglegorsk Port Authority**  
Primouskaya ul 7  
Uglegorsk  
Russia  
**Contact:** Port Manager  
T: + 7 42432 21771

### VANINO

**Vanino Commercial Sea Port, PJSC**  
1 Zheleznodorozhnaya Str.  
Vanino  
Khabarovsk Territory  
682860  
Russia  
**Contact:** Mr Apollon Shengeliya,  
General Director  
T: + 7 421 37 5 09 23  
F: + 7 872 140 26 10  
E: market@vcsp.ru  
W: www.vcsp.ru

### VANINO

**Vanino Port Authority**  
FEPCO, Khabarovskiy Krai  
Ul Zheleznodorozhnaya 1  
Vanino  
682860  
Russia  
**Contact:** Mr A G Briankina,  
T: + 7 421 377 7799  
F: + 7 421 377 7575  
E: vanino.port@gjin.ru

### VLADIVOSTOK

**Aqua-Resources Co., Ltd**  
Khersonskaya St. 5  
Vladivostok  
Primorsky Region  
690012  
Russia  
**Contact:** Mr Kirill Orekhov, Foreign Relations Manager  
T: + 7 4 232 499 771  
E: orekhov@aquares.ru  
W: www.terminal-astafiev.com/

### VLADIVOSTOK

**Vladivostok Port Authority**  
Vladivostok Commercial Port  
9 Strelnikova Street  
Vladivostok  
690600  
Russia  
**Contact:** Mr Yuri Sidorenko,  
Marketing Director  
T: + 7 4232 495 222  
F: + 7 4232 222364  
E: office@gavmvp.vladivostok.ru  
W: www.vladcomport.ru

### VYBORG

**Port of Vyborg Authority**  
Uitsa Yuzhny Val 1  
Vyborg 188900  
Russia  
**Contact:** Mr Ovechkin, Harbour Master  
T: + 7 812 782 0477  
F: + 7 812 783 2485  
E: mapvyb@vbg.spb.ru

## SAUDI ARABIA

### DAMMAM

**Arabian Agricultural Services (ARASCO)**  
Dammam - Al-Khobar, Coastal Road  
PO Box 6977  
Dammam  
Eastern  
31452  
Saudi Arabia  
**Contact:** Mr Abdulaziz Abdulla Al-Fayez, Logistic President  
T: + 966 3 859 1171  
F: + 966 3 859 4474  
E: a.alfayez@arasco.com  
W: www.arasco.com

### DAMMAM

**Gulf Agency Company (SA)**  
PO Box 335  
Dammam  
31411  
Saudi Arabia  
**Contact:** Mr David Burck, Managing Director  
T: + 966 3 832 8762  
F: + 966 3 832 3035  
E: dammam@gac.com  
W: www.gac.com/saudiarabia  
**Location:** All Saudi Arabian ports

### DAMMAM

**King Abdul Aziz Port Authority-Dammam**  
PO Box 28062  
Dammam  
Eastern Province  
31437  
Saudi Arabia  
**Contact:** Mr Abdullah Alhammad,  
Deputy Port Director  
T: + 966 3 858 3500  
F: + 966 3 858 3945  
E: kaap@ports.gov.sa  
W: www.ports.gov.sa

### JEDDAH

**AJWA Port Services Co.**  
PO Box 16645  
Jeddah  
21474  
Saudi Arabia  
**Contact:** Mr Saleh N Al-Fadhli,  
General Manager  
T: + 966 264 712 50  
F: + 966 264 704 25 / 906 06  
E: snalfadhli@ajwa.com  
W: www.ajwagroup.com  
**Location:** Jeddah Islamic Port and Yanbu Commercial Port.  
Both ports along the Red Sea coast of Saudi Arabia  
**Equipment & Capacity:** 5 Grain ship-unloaders: capacity from 200 to 400tph at Jeddah & Yanbu. A large fleet of different cargo handling equipment including 1x 100 ton swl

mobile harbor crane at Yanbu Commercial Port.  
**Bulk Berths:** Ajwa grain silos opp. Berth #03 in Jeddah and 7 berths in Yanbu.  
Maximum draught at Yanbu is 14m.  
**Total Uncovered Storage:** 450,000sqm in Yanbu.  
**Total Covered Storage:** 65,000sqm of shed & warehouse storage and 40,000t of vertical silos for dry bulk cargo storage in Yanbu. Bulk grain storage capacity at Jeddah port is 120,000t.

Ajwa handles bulk grain at Jeddah port. At Yanbu port cargo handled includes containers, general, bulk, Ro-Ro & live-stock, while transshipment cargo enjoys 3 months demurrage free storage.

### JEDDAH

**Jeddah Islamic Port**  
PO Box 9285  
Jeddah  
21188  
Saudi Arabia  
**Contact:** Mr Sahir M Tahlawi, Port Director General  
T: + 966 2 647 1200 ext 2121 / 6477702  
F: + 966 2 647 7411  
E: jip@ports.gov.sa  
W: www.ports.gov.sa  
**Location:** Red Sea Port, west coast of Saudi Arabia  
**Equipment & Capacity:** 19 unloaders, pneumatic and mechanical, 100 - 600tph capacity  
**Bulk Berths:** 5 x 250m long, 11.5 - 13.5m draught, 2 x 181m, 10.4 - 11.5m draught  
**Total Uncovered Storage:** No storage of grains in open area  
**Total Covered Storage:** 120,000t silos  
In addition, 2 unloaders should be in service within one year.

### JIZAN

**Jizan Port Management**  
PO Box 16  
Jizan  
Saudi Arabia  
**Contact:** Mr Abdul Hamid Saadi,  
Director General  
T: + 966 7 317 1000  
F: + 966 7 317 0777  
E: info@ports.gov.sa

### YANBU

**Yanbu Commercial Port**  
Yanbu Port Management  
PO Box 1019  
Yanbu  
Al Bahr  
Saudi Arabia  
**Contact:** Mr R A Al-Khateeb, Port Director  
T: + 966 4 322 1163  
F: + 966 4 322 7643  
E: info@ports.gov.sa

## SENEGAL

### DAKAR

**Port Autonome de Dakar**  
21 Boulevard de la Liberation  
PO Box 3195  
Dakar  
Senegal  
**Contact:** Mr Souleye Sall, Port Director  
T: + 221 234545  
F: + 221 233606  
E: pad@portdakarsn

## SEYCHELLES

### VICTORIA

**Seychelles Ports Authority**  
PO Box 47

New Port  
Mahe Quay  
Victoria  
Seychelles  
**Contact:** Captain Daniel Laporte,  
Harbour Master  
T: + 248 224701  
F: + 248 224004  
E: laporte@seyport.sc  
W: www.spa.sc

## SIERRA LEONE

### CLINE TOWN

**Sierra Leone Port Authority**  
PM Bag 386  
Cline Town  
Freetown  
Sierra Leone  
**Contact:** Mr Helmut Friedrichs,  
General Manager  
T: + 232 22 250 111  
F: + 232 22 250 616

### FREETOWN

**PepeI**  
c/o Marampa Iron Ore Mining Co  
PO Box 735  
Freetown  
Sierra Leone  
**Contact:** Harbour Master  
T: + 232 24542

### FREETOWN

**Sierra Leone Ports Authority**  
Queen Elizabeth II Quay  
PO Box 386  
Freetown  
Sierra Leone  
**Contact:** Capt P Schiffard, Director of Operations  
T: + 232 22 250111  
F: + 232 22 250616

## SINGAPORE

### JURONG

**Sembawang Terminal**  
c/o Port of Singapore Authority  
PO Box 300  
PSA Building Post Office  
Jurong  
0511  
Singapore  
**Contact:** Ms Karyn Yap, Marketing Manager  
T: + 65 274 7111  
F: + 65 274 4677

### SINGAPORE

**Jaldhi Overseas Pte Ltd**  
101 Cecil Street  
08-06 Tong Eng Building  
Singapore  
069533  
Singapore  
**Contact:** Mr Vira Chand Bothra,  
T: + 65 6223 8929  
F: + 65 6223 8920  
E: vcb@jaldhi.com  
W: www.jaldhi.com/

### SINGAPORE

**Jurong Port Pte Ltd**  
37 Jurong Port Road  
Singapore  
619110  
Singapore  
**Contact:** Mr Achaibar Gupta, Senior Manager Corporate Communications  
T: + 65 6265 0666 / 66609582  
F: + 65 6261 4359  
E: jpcss@jp.com.sg  
W: www.jp.com.sg

### SINGAPORE

**LD Ports & Logistics**  
45A Club Street  
Singapore  
069422



Singapore  
**Contact:** Capt Yann Jaubard, CEO  
**T:** + 65 6576 9877  
**E:** yann.jaubard@oms.sg  
**W:** www.lportslogistics.com

**SINGAPORE**  
**Maritime and Port Authority of Singapore**  
 460 Alexandra Road  
 # 19-00 PSA Building  
 Singapore 119963  
 Singapore  
**T:** + 65 6375 1600  
**F:** + 65 6275 9247  
**E:** qsm@mpa.gov.sg  
**W:** www.mpa.gov.sg

**SINGAPORE**  
**Offshore Bulk Terminal Pte Ltd**  
 50, Collyer Quay  
 OUE Bayfront, #06-04  
 Singapore 049321  
 Singapore  
**Contact:** Ms Lohita Ellylsiana,  
**E:** lohita.ellylsiana@obt-group.com  
**W:** www.obt-group.com

**SINGAPORE**  
**Sin Heng Chan (Singapore) Pte Ltd**  
 Lot A 5052 Jurong Port  
 Jurong Port Road  
 Singapore 619111  
 Singapore  
**Contact:** Mdm Poon Pooy Huang,  
 General Manager  
**T:** + 65 6268 4711 ext 216  
**F:** + 65 6268 5711  
**E:** info@sinhengchan.com.sg  
**W:** www.sinhengchan.com.sg

**SLOVENIA**

**KOPER**  
**Luka Koper d.d., Dry Bulk Cargo Terminal**  
 Vojkovo Nabra je 38  
 Koper SI-6501  
 Slovenia  
**Contact:** Mr Ivan Peric, Director -  
 Dry Bulk Cargo Terminal  
**T:** + 386 566 56 511  
**F:** + 386 566 56 509  
**E:** ivan.peric@luka-kp.si  
**W:** www.luka-kp.si  
**Location:** Slovenian coast, the  
 northernmost part of the Adriatic  
**Equipment & Capacity:** 3x Gantry  
 crane 16 ton; 1 kangeroo crane 16  
 ton  
**Bulk Berths:** 3 Berths  
**Total Uncovered Storage:**  
 40,000mt  
**Total Covered Storage:** 80,000mt  
 Different types of Minerals  
 Quayside 525 m  
 Sea depth 6 - 12.5 m  
 Special capacities for Alumina  
 Sea depth 9 m  
 Berth1  
 Storage capacity 20,000mt  
 Our terminal is also specialized in  
 handling and warehousing different  
 kinds of cereals and fodder

**SOUTH AFRICA**

**BISHOPSGATE**  
**South African Sugar Association**  
 SA Sugar Terminal Department  
 PO Box 61104  
 Bishopsgate  
 KZN  
 4008  
 South Africa

**Contact:** Mr S Suleman,  
**T:** + 27 31 365 8100  
**F:** + 27 301 1313  
**E:** shaffee.suleman@sasa.org.za  
**W:** www.sasa.org.za

**DURBAN**  
**Bidfreight Port Operations (Pty) Ltd**  
 PO Box 900  
 Durban 4000  
 South Africa  
**Contact:** Ms Belinda Kruger,  
 Executive Assistant & Corporate  
 Communications  
**T:** + 27 31 274 2400  
**F:** + 27 31 205 4116  
**E:** marketing@bidports.co.za  
**W:** www.bidports.co.za  
**Location:** All major ports in South  
 Africa  
 BPO offer an integrated port  
 operations solution to customers  
 importing or exporting in South  
 Africa.

**DURBAN**  
**Bulk Connections**  
 PO Box 21273  
 Bluff  
 Durban  
 KwaZulu Natal 4036  
 South Africa  
**Contact:** Mr Iain Geldart, MD  
**T:** + 27 31 466 1960  
**F:** + 27 31 466 9667  
**E:** iaing@bulkconnections.com  
**W:** www.bulkconnections.com  
**Location:** East Coast of South  
 Africa  
**Equipment & Capacity:** Sized  
 sensitive loading equipment.  
 Capacity of 3.5 million tpa.  
**Bulk Berths:** Three berths, up to  
 10.3m deep  
 Berth 3. Length 184m. Draught  
 8.8m.  
 Berth 4. Length 220m. Draught  
 10.3m.  
**Total Uncovered Storage:** 140,000  
 sqm  
**Total Covered Storage:** 4,000 sqm  
 Bulk Connections is an  
 import/export, multi modal bulk  
 terminal specialising in soft handling  
 of cargo.

**DURBAN**  
**Grindrod Terminals**  
 PO Box 1  
 Durban  
 KwaZulu Natal 4000  
 South Africa  
**Contact:** Mr Sean Rowan, CEO  
 Grindrod Terminals  
**T:** + 27 31 302 7700  
**F:** + 27 31 302 7701  
**E:** seanr@grindrod.co.za  
**W:** www.grindrod.co.za

**DURBAN**  
**Grindrod Terminals - Maydon Wharf**  
 34 Shadwell Road  
 Maydon Wharf  
 Durban  
 Kwazulu Natal 4001  
 South Africa  
**Contact:** Mr Paul Leisegang,  
 Regional Manager  
**T:** + 27 31 274 3270  
**F:** + 27 31 274 3277  
**E:** paul@grindrod.co.za  
**W:** www.grindrod.co.za  
**Location:** South Africa - Kwazulu  
 Natal  
**Bulk Berths:** Have access to 14  
 multi user berths of varying lengths.  
 Draught of between 9m and 10.3m .  
 Preferential berthing rights at one  
 berth.

**DURBAN**  
**Grain Terminal**  
 P O Box 101  
 East London 5200  
 South Africa  
**Contact:** Mr Neil Pettifer,  
**T:** + 27 43 700 2027  
**F:** + 27 43 700 2304  
**E:** neil.pettifer@transnet.net  
**W:** www.transnetnational  
 portsauthority.net

**EAST LONDON**  
**Transnet Port Terminals**  
 Head Office  
 Kingsmead Office Park  
 Stalwart Simelane/Stanger Street  
 Durban  
 KwaZulu Natal 4001  
 South Africa  
**Contact:** Ms Mbali Mathenjwa,  
**T:** + 27 31 308 8310  
**F:** + 27 31 308 8336  
**E:** Mbali.Mathenjwa@transnet.net  
**W:** www.transnetportterminals.net  
**Location:** 16 terminals situated in 7  
 commercial ports along South  
 Africa's coastline.  
 Transnet Port Terminals (previously  
 South African Port Operations) is  
 responsible for cargo handling and  
 logistics services.

**Total Uncovered Storage:**  
 Container terminal - in excess of  
 1300 container slots.  
**Total Covered Storage:** Storage  
 capacity of 150 000 tons (Bulk,  
 Break Bulk and Bagged).  
 Container handling and packing  
 facilities. Intermodal warehouse  
 and container yards - 176 655m<sup>2</sup>.

**DURBAN**  
**South African Bulk Terminals LTD**  
 101 Maydon Road  
 Maydon Wharf  
 Durban  
 KwaZulu Natal 4001  
 South Africa  
**Contact:** Mr Hampie Lourens,  
 Managing Director  
**T:** + 27 31 327 5000  
**F:** + 27 31 304 6794  
**E:** hampie.lourens@sabulk.co.za  
**W:** www.bidvest.co.za  
**Location:** Durban, South Africa  
**Equipment & Capacity:** MW5 -  
 SKT 800 + 300 tph/load 500 tph  
 IV3 - Pneumatic(2) 640 tph/load  
 1500 tph  
**Bulk Berths:** MW5 200m/9.3m  
 IV3 up to 200m/12.2m  
**Total Covered Storage:** MW5 - 150  
 000 tonnes silo/bin  
 IV3 - 69500 tonnes silos + 5650  
 vegetable oil storage tanks

**DURBAN**  
**South African Sugar Association (Pty) Ltd**  
 PO Box 700  
 Mount Edgecombe  
 Durban  
 KwaZulu Natal 0300  
 South Africa  
**Contact:** Mr Vino Naicker,  
**T:** + 27 31508 7000  
**F:** + 27 31508 7189  
**E:** vino@na@sasa.org.za  
**W:** www.sasa.org.za

**DURBAN**  
**Transnet Port Terminals**  
 Head Office  
 Kingsmead Office Park  
 Stalwart Simelane/Stanger Street  
 Durban  
 KwaZulu Natal 4001  
 South Africa  
**Contact:** Ms Mbali Mathenjwa,  
**T:** + 27 31 308 8310  
**F:** + 27 31 308 8336  
**E:** Mbali.Mathenjwa@transnet.net  
**W:** www.transnetportterminals.net  
**Location:** 16 terminals situated in 7  
 commercial ports along South  
 Africa's coastline.  
 Transnet Port Terminals (previously  
 South African Port Operations) is  
 responsible for cargo handling and  
 logistics services.

**EAST LONDON**  
**SA Port Ops East London Grain Terminal**  
 P O Box 101  
 East London 5200  
 South Africa  
**Contact:** Mr Neil Pettifer,  
**T:** + 27 43 700 2027  
**F:** + 27 43 700 2304  
**E:** neil.pettifer@transnet.net  
**W:** www.transnetnational  
 portsauthority.net

**EAST LONDON**  
**Transnet Port Terminals**  
 Head Office  
 Kingsmead Office Park  
 Stalwart Simelane/Stanger Street  
 Durban  
 KwaZulu Natal 4001  
 South Africa  
**Contact:** Ms Mbali Mathenjwa,  
**T:** + 27 31 308 8310  
**F:** + 27 31 308 8336  
**E:** Mbali.Mathenjwa@transnet.net  
**W:** www.transnetportterminals.net  
**Location:** 16 terminals situated in 7  
 commercial ports along South  
 Africa's coastline.  
 Transnet Port Terminals (previously  
 South African Port Operations) is  
 responsible for cargo handling and  
 logistics services.

South Africa  
**Contact:** Capt Naresh Sewnath,  
 Port Captain  
**T:** + 27 43 700 1176  
**F:** + 27 43 700 2227  
**E:** naresh.sewnath@transnet.net

**JOHANNESBURG**  
**Anglo Coal**  
 PO Box 61587  
 Marshalltown  
 Johannesburg  
 Gauteng 2107  
 South Africa  
**Contact:** Mr Kevin Martens,  
 General Manager, Logistics  
**T:** + 27 11 638 5422  
**F:** + 27 11 638 5428  
**E:** kmartens@angloamerican.co.za  
**W:** www.angloamerican.co.uk

**JOHANNESBURG**  
**National Ports Authority of South Africa (NPASA)**  
 30 Wellington Road  
 Parktown  
 Johannesburg  
 Gauteng 2193  
 South Africa  
**Contact:** Mr Pieter Smit, Marketing  
 Manager  
**T:** + 27 11 351 9019  
**F:** + 27 11 351 9023  
**E:** pieters@npa.co.za  
**W:** www.npa.co.za

**PORT ELIZABETH**  
**Portnet Port Elizabeth**  
 P O Box 162  
 Port Elizabeth 6000  
 South Africa  
**Contact:** Mr Manie Coetzee,  
 Marketing  
**T:** + 27 41 507 2604  
**F:** + 27 41 558 383  
**E:** manie.coetzee@transnet.net  
**W:** www.transnet.net

**PORT ELIZABETH**  
**Transnet Port Terminals**  
 PO Box 162  
 Port Elizabeth 6000  
 South Africa  
**Contact:** Ms Nandi Oliphant,  
**T:** + 27 41 507 1824  
**F:** + 27 41 507 1801  
**E:** nandi.oliphant@transnet.net  
**W:** www.transnetportterminals.net  
**Equipment & Capacity:** Over 2  
 million tons annual throughput.  
 Exports more than 1.7 million tons  
 of manganese ore.  
**Bulk Berths:** 4 berths  
 Value-added services include  
 packing and unpacking of  
 containers, storage and additional  
 logistics management.

**RICHARDS BAY**  
**Port of Richards Bay**  
 PO Box 181  
 Richards Bay  
 KwaZulu Natal 3900  
 South Africa  
**Contact:** Mr Preston Khomo, Port  
 Manager  
**T:** +27 35 905 3203  
**F:** +27 35 905 3333  
**E:** Preston.Khomo@transnet.net  
**W:** www.ports.co.za/richards-  
 bay.php  
**Location:** Located approximately  
 160km north-east of Durban and  
 465km south of Maputo on the  
 eastern seaboard of South Africa.  
**Equipment & Capacity:** Please see  
 our website for more information -  
 www.npa.co.za  
**Bulk Berths:** Please see our

website for more information -  
 www.npa.co.za  
**Total Uncovered Storage:** Please  
 see our website for more  
 information - www.npa.co.za  
**Total Covered Storage:** Please see  
 our website for more information -  
 www.npa.co.za  
 The port's hinterland comprises the  
 Northern KwaZulu Natal, Gauteng  
 and Mpumalanga regions. The port  
 boasts substantial bulk handling  
 capacity, excellent rail/port  
 connections, transshipment facilities  
 and growing container handling  
 facilities. It also offers easy access  
 to South Africa's national road and  
 rail network with substantial growth  
 capacity in rail network link.

**RICHARDS BAY**  
**Richards Bay Coal Terminal**  
 PO Box 56  
 Richards Bay  
 KwaZulu Natal 3900  
 South Africa  
**Contact:** Mr Ronald Liale, Acting  
 Corporate Affairs Manager  
**T:** + 27 35 904 4015  
**F:** + 27 35 907 7200  
**E:** rliale@rbct.co.za  
**W:** www.rbct.co.za  
**Location:** Eastern seaboard of  
 South Africa.  
**Equipment & Capacity:** 4x  
 shiploaders, 6x stacker reclaimers,  
 2 stackers, 1 reclaimers, 58m  
 conveyor belt system up to 2.5m  
 wide, travelling up to 22km/h  
**Bulk Berths:** 301, 302, 303, 304,  
 305. Permissible draught 17.5m  
**Total Uncovered Storage:** 6.7  
 million tonnes  
 Export capacity of 72 million tonnes  
 per annum.  
 Land surface area of 254,114  
 hectares

**RICHARDS BAY**  
**Transnet Port Terminals**  
 Dry Bulk Terminal  
 Customer Services Department  
 PO Box 1793  
 Richards Bay  
 KwaZulu Natal 3900  
 South Africa  
**Contact:** Mr Warren Vickers,  
 Customer Services Manager  
**T:** + 27 35 905 3105  
**F:** + 27 35 905 3216  
**E:** Warren.Vickers@transnet.net  
**W:** www.transnet.net  
**Location:** The port of Richards Bay  
 is located about 180 km north of  
 Durban, South Africa.  
**Equipment & Capacity:** 4 General  
 purpose ship loaders (2,500tph)  
 2 Pneumatic woodchip loaders (700  
 & 1,000 tph each)  
 3 Grab unloaders (1,500 tph)  
 3 Mobile harbour cranes (600 tph)  
 2 Pneumatic unloaders (600 & 500  
 tph)  
**Bulk Berths:** Berth 609 - 300m -  
 14.0m draught  
 Berth 701 - 240m - 14.0m draught  
 Berth 702 - 300m - 17.5m draught  
 Berth 703 - 240m - 17.5m draught  
 Berth 704 - 240m - 17.5m draught  
 Berth 705 - 280m - 17.5m draught  
 Berth 801 - 260m - 17.5m draught  
 Berth 804 - 260m - 17.5m draught  
**Total Uncovered Storage:** Import:  
 nil  
 Export: Area ABC West : 3 x 50  
 000 ton. Area ABC East : 2 x 100  
 000 ton  
**Total Covered Storage:** Import: 25  
 000m<sup>2</sup> (shed)  
 Export: 38 910m<sup>2</sup> (sheds)  
 Export: 120,600m<sup>3</sup> (silos & storage  
 bins)  
 Over 13 million tonnes of bulk cargo  
 is imported and exported via a fully

computerised conveyor belt system,  
 controlled from a central control  
 room. 40 Km of conveyor belt links  
 seven private harbour bays  
 industries to the quayside operation  
 of loading and discharging vessels.  
 NB Vessels must ballast during  
 discharge to maintain 18.0m max  
 air-draught.  
 Magnetite and Anthracite also  
 handled.

**RICHARD'S BAY**  
**Grindrod Terminals - Richard's Bay**  
 PO Box 10744  
 Meerensee  
 Richard's Bay  
 KwaZulu Natal 3901  
 South Africa  
**Contact:** Mr Christo Coetzer,  
 Executive - Terminals  
**T:** + 27 35 797 9092  
**F:** + 27 35 797 9033  
**E:** christoc@grindrod.co.za  
**W:** www.grindrod.co.za  
**Location:** South Africa - Kwazulu  
 Natal  
**Equipment & Capacity:** 4.0 million  
 tons handled annually. Four different  
 sites have the capacity to handle 5  
 million tons pa.  
**Bulk Berths:** Import: 3 berths (Max.  
 vessel length x max. Draught depth)  
 1@ 240 x 13.5m, 1@ 220 x 13.5  
 and 1@ 260 x 17.0m Export: 5  
 berths (Max. vessel length x max.  
 Draught depth) 2 @ 200 x 17.0m,  
 1@ 190 x 17.0 and 2 @ 230 x  
 17.0m.

**Total Uncovered Storage:**  
 35,400m<sup>2</sup> Silo storage 79,000  
 tonnes @ cargo SG of 2.5  
**Total Covered Storage:** 61,000m<sup>2</sup>  
 Terminals are belt connected to the  
 quayside for imports and exports.  
 Grindrod is well equipped to handle  
 all sorts of cargoes from tipping of  
 trains, bulk storage, bagging of  
 products and containerisation of  
 cargoes.

**SALDANHA**  
**S A Port Ops**  
 Private Bag X14  
 Saldanha 7395  
 South Africa  
**Contact:** Mr Deon Julies, Business  
 Unit Executive  
**T:** + 27 22 703 4710  
**F:** + 27 22 703 4832  
**E:** deon.julies@transnet.net

**SALDANHA**  
**Saldanha Bulk Terminal**  
 Private Bag X8  
 Saldanha 4395  
 South Africa  
**Contact:** Mr Christopher Gomez,  
 Communications Manager  
**T:** + 27 22 703 4204  
**F:** + 27 22 703 4828  
**E:** christopherg@saportops.co.za

**SOUTH KOREA**

**CHEJU**  
**Cheju Port Authority**  
 918-30 Geonip-Dong  
 Cheju  
 South Korea  
**Contact:** Port Manager  
**T:** + 82 64 22 1754  
**F:** + 82 64 57 5002

**DONGHAE CITY**  
**Donghae Port Authority**  
 806 Cheongok-dong  
 Donghae City  
 Gangwon

240-716  
South Korea  
**Contact:** Mr K Nam, Port Manager  
T: + 82 33 533 3011  
F: + 82 33-533-1415  
E: info@portarea.com  
W: www.portdonghae.go.kr

## DONGHAE CITY

**Mukho Port Authority**  
Donghae District Maritime Port  
Administration  
Donghae City  
South Korea  
**Contact:** Port Manager  
T: + 82 394 521 7000  
F: + 82 394 521 0317

## GWANG YANG-CITY

**Posco Terminal Co., Ltd**  
Gwang Yang CTS Yard, 861  
Geumbo-dong  
Gwang Yang-City  
Jeonam  
South Korea  
**Contact:** Mr Woo Sun-Moon, CEO  
T: + 82 61 793 7412  
F: + 82 61 790 6386  
E: info@poscoterminal.com  
W: www.poscoterminal.co.kr

## INCHON

**Korea Silo Company Pier 7**  
3 1-KA Puk Sung-Dong  
Chung-Gu  
Inchon  
South Korea  
T: + 82 32 763 3211  
F: + 82 32 763 9178  
E: marcello\_b@yahoo.com  
W: www.koreassilo.co.kr

## JUNG-GU

**Incheon Port Authority**  
193 Seohaero  
1-17 Hang-dong 7 ga  
Jung-gu  
Incheon  
402-705  
South Korea  
**Contact:** Mr Lee Jeong-Ryoul,  
Port Management Division  
T: + 82 32 880 6114  
F: + 82 32 884 3563  
E: demigod@jcpa.or.kr  
W: www.portincheon.go.kr/

## KUNSAN

**Changhang Port Authority**  
Kunsan Port Authority  
1-7 Jangmi-Dong  
Kunsan  
South Korea  
**Contact:** Port Manager  
T: + 82 654 420660  
F: + 82 654 433217

## KUNSAN

**Kunsan Port Authority**  
1-7 Jangmi-Dong  
Kunsan  
South Korea  
**Contact:** Port Manager  
T: + 82 654 420 660  
F: + 82 654 433 217

## MASAN-SOUTH

**Masan Port Authority**  
1-6 Wolpo-Dong  
Masan-South  
South Korea  
**Contact:** Port Manager  
T: + 82 551 456177  
F: + 82 551 456179

## NAM KU

**Ulsan Port Authority**  
Ulsan District Maritime  
139-9 Maeam Dong  
Nam Ku  
Ulsan  
South Korea

**Contact:** Port Manager  
T: + 82 522 614881  
F: + 82 522 614873

## POHANG

**Pohang District Maritime & Port Authority**  
58-7 Hangku-Dong  
Pohang  
South Korea  
T: + 82 562 421881  
F: + 82 562 451623

## POHANG

**Port of Pohang**  
Pohang District Maritime & Port  
Authority  
58-7 Hangku-dong  
Pohang  
South Korea  
T: + 82 562 421 812  
F: + 82 562 422 122

## ULSAN

**Port of Ulsan Public Piers 1&2**  
Ulsan District Maritime and Port  
Authority  
139-9 Maeam-dong  
Ulsan  
South Korea  
**Contact:** Mr Jeong Chang-won,  
T: + 82 52 228 5500  
F: + 82 52 228 5549  
W: www.ulsan.mitm.go.kr

## YOSU

**Samil Port Authority**  
c/o Ulsan District Maritime Port  
Authority  
335-2 Soojung-Dong  
Yosu  
South Korea  
**Contact:** Port Manager  
T: + 82 662 624953  
F: + 82 662 645 436

## YOSU

**Yeosu Port Authority**  
335-1 Sujeoung-dong  
Yosu  
South Korea  
**Contact:** Port Manager  
T: + 82 61 660 9000  
F: + 82 61 662 4054  
W: www.yosu.momaf.go.kr

## SPAIN

### ALCUDIA

**Port of Alcudia**  
Autoridad Portuaria de Baleares  
Ed. Arranque Muelle Pesquero, s/n  
Alcudia  
Balearic Islands  
07410  
Spain  
**Contact:** Ms Teresa Alonso,  
Estrategic Plan Manager  
T: + 34 971 22 81 50 ext 241  
F: + 34 971 54 91 67  
E: portsdebalears@portsdebalears.com  
W: www.portsdebalears.com  
**Location:** Eastern Mediterranean  
Sea.  
Balearic Islands Archipelago. North  
of Mallorca  
**Equipment & Capacity:** Muelle  
Ribera. Productos Asfálticos, S.A.  
Betunes asfálticos, descarga por  
tubería, 3 silos en Muelle Ribera de  
1.990 m3.  
Muelle Comercial. Portland de  
Mallorca. Cemento, descarga por  
tubería 200 Tn./hora  
**Total Uncovered Storage:** Muelle  
Adosado 3.200 e.m. (coal)

### ALGECIRAS

**Port Authority of La Bahia de Algeciras**  
Apartado No7

Paseo de la Conferencia S/N  
Algeciras  
Cadiz  
11207  
Spain  
**Contact:** Mr Gerardo Landaluce,  
Marketing Manager  
T: + 34 9 56 58 54 00  
F: + 34 9 56 58 54 45  
E: glandaluce@apba.es  
W: www.apba.es

### ALICANTE

**Port of Alicante**  
Muelle de Poniente 11  
Alicante  
03001  
Spain  
**Contact:** Mr Luis Charles Lopez,  
Marketing  
T: + 34 96 513 0134  
E: alicanteport@alicanteport.com  
W: www.alicanteport.com

### ALMERIA

**Carboneras**  
c/o Autoridad Portuaria de  
Almeriamotril  
Muelle de Levante s/n  
Almería  
04071  
Spain  
**Contact:** Mr Muelle Levante, Port  
Director  
T: + 34 9 50 23 60 33  
F: + 34 9 50 23 29 49  
E: almeria@apalmeria.com  
W: www.apalmeria.com/

### ALMERIA

**Port of Almeria**  
Muelle Levante s/n  
Almería  
04071  
Spain  
**Contact:** Mrs Trinidad Cabeo  
Rodríguez, President  
T: + 34 950 236 033  
F: + 34 950 232 949  
E: tcabeo@apalmeria.com  
W: www.apalmeriamotril.com

### ASTURIAS

**Port Authority of Aviles**  
El Muelle 8  
Avile  
Asturias  
33400  
Spain  
**Contact:** Ms Cristina Lopez, Head  
of Marketing  
T: + 34 9 8 554 11 11  
F: + 34 9 8 554 04 79  
E: cristinal@puertoaviles.com  
W: www.puertoaviles.es

### BARCELONA

**Cemex España**  
01B Adossat Wharf  
Port of Barcelona  
Barcelona  
08039  
Spain  
**Contact:** Almudeno Lomillo,  
Marketing  
T: + 34 918 00 78 00 / +34 902 23  
63 93  
F: + 34 93 221 93 44  
W: www.cemex.es

### BARCELONA

**Egransa**  
22B Contradic Est Wharf  
Barcelona  
Spain  
**Contact:** Mr Jordi Archs, General  
Manager and CEO  
T: + 34 93 2954580/4433716  
F: + 34 93 442 20 28  
E: gerencia@egransa.es  
W: www.egransa.es

### BARCELONA

**Egransa Terminal**  
11 Muelle Contradique  
Barcelona  
Spain  
**Contact:** Mr Jorge Arch Miguel,  
T: + 34 93 295 45 80  
F: + 34 933 173 042  
E: gerencia@egransa.es  
W: www.egransa.es

### BARCELONA

**Moyresa Molturacion y Refino SA**  
23A Oest Wharf  
Port of Barcelona  
Barcelona  
08039  
Spain  
T: + 34 934 43 40 00  
F: + 34 934 41 05 16

### BARCELONA

**Port of Barcelona**  
WTC, Ed. Est, Moll de Barcelona s/n  
Barcelona  
08039  
Spain  
**Contact:** Mrs Norma de la Fuente,  
Communications & Institutional  
Relations Director  
T: + 34 9 3 306 88 00  
F: + 34 9 3 306 88 58  
E: norma\_dela Fuente@  
portdebarcelona.es  
W: www.portdebarcelona.es  
**Location:** West Mediterranean

**Equipment & Capacity:** The Port of  
Barcelona has 6 companies  
dedicated to solid bulks:  
- Porcemen, S.A and Cemex  
España (Cement)  
- Egransa (Grain)  
- Cargill España, S.A and  
Moyresa/Bunge (Soya products)  
- Tramer, S.A (Potash)  
**Bulk Berths:** 1422 m.l  
**Total Uncovered Storage:**  
38,192sqm approx.  
**Total Covered Storage:** 17,659sqm  
approx.  
Total surface: 138,035sqm

### BARCELONA

**Portcemen, SA**  
22c Contradic Wharf  
Port of Barcelona  
Barcelona  
08039  
Spain  
**Contact:** Mr Eduard Duran,  
Managing Director  
T: + 34 93 443 05 14  
F: + 34 93 443 10 29  
E: portcemen@entorno.es  
W: www.portcemen.com

### BARCELONA

**Tramer SA**  
22a Contradic Nord Wharf  
Port of Barcelona  
Barcelona  
08039  
Spain  
T: + 34 93 442 19 40  
F: + 34 93 443 20 73  
E: tramer@iberposash.com

### BILBAO

**Autoridad Portuaria De Bilbao**  
Campo De Volantin 37  
Bilbao  
Bizkaia  
48007  
Spain  
**Contact:** Mr Julio Burgos,  
Desarrollo Comercial  
T: + 34 94 487 1200  
F: + 34 94 487 1410  
E: jburgos@bilbaoport.es  
W: www.bilbaoport.es  
**Location:** Inner quays: Nemar,  
Adosado & Princesa docks

Outer Abra: AZ1 & Punta Sollana  
docks  
**Equipment & Capacity:** Inner  
quays: 2 overhead gantries of 35t, 7  
luffing cranes of 16t  
Outer Abra quays: 2 on tyre wheel  
cranes of 105 & 140t, 1 mobile  
crane of 25t, conveyor belts for  
grains (2,000 tph) and clinker (1,000  
tph), continuous loader for sulphate  
(700 tph)  
**Bulk Berths:** Inner quays: total  
length 1,027m, draught 14m.  
Outer Abra quays: total length  
1,250m, draught 21m.  
**Total Uncovered Storage:**  
220,100sqm  
**Total Covered Storage:** 53,800 +  
silos for grain with 100,000t of  
storage capacity  
Industrial installations: grinder for oil  
seeds, clinker mill, drying shed for  
coke.

### CADIZ

**Cadiz Bay Port Authority**  
Plaza de Espana 17  
Cadiz  
11006  
Spain  
**Contact:** Ms Kate Bonet, Marketing  
Manager  
T: + 34 9 56 24 04 00  
F: + 34 9 56 24 04 76  
E: cadiz@puertocadiz.com  
W: www.puertocadiz.com

### CARTAGENA

**Port Authority of Cartagena**  
Plaza Heroes de Cavite s/n  
Cartagena  
Murcia  
30201  
Spain  
**Contact:** Mr Fernando Munoz,  
Commercial Director  
T: + 34 9 68 32 58 00  
F: + 34 9 68 32 58 15  
E: fmunoz@apc.es  
W: www.apc.es  
**Location:** 0° 59' O Longitude 37°  
35' N Latitude  
South East of Spain on the South  
Mediterranean Coast

**Equipment & Capacity:**  
Escobreras Basin  
ISO 9001/2008- Certification in solid  
bulks traffic, general merchandise  
traffic, container and Cruiser.  
ISO 14001:2004 - Environmental  
management system  
EMAS - Certificate  
OHSAS 18001:2007 - Management  
system of health and safety  
- 6 x 100 t mobile cranes capable  
of operating at both quays.  
- Cranes of 40T, 30T and 12T  
**Bulk Berths:** Principe Felipe E004:  
Length 180m, Draught 11.9m.  
Principe Felipe E005: Length 175m,  
Draught of 13.72m  
Principe Felipe E006: Length 175m,  
Draught 13.72m  
Isaac Peral E007: Length 240m,  
Draught 13.72m  
Isaac Peral E008: Length 240m,  
Draught 13.72m

Muelle Polivalente E021: Length  
288m, Draught 21.00m  
Muelle Polivalente E022: Length  
288m Draught 21.00m  
Muelle Sur E023: Length 300m,  
Draught 21.00m  
Muelle Sur E024: Length 301m,  
Draught 21.00m  
**Total Uncovered Storage:** 224,741  
sqm  
**Total Covered Storage:** 86,060  
sqm  
Industrial and logistics activities  
area: 28 Ha

### CARTAGENA

**Port of Aguilas**  
Port Services Parque 1 entresuela

Cartagena  
Murcia  
Spain  
**Contact:** Mr Pedro Albadalejo, Port  
Manager  
T: + 34 9 68 36 24 98  
F: + 34 9 68 36 23 27

### FERROL

**Port Authority of Ferrol – San Cibrao**  
Muelle Curuxearas s/n  
Ferrol  
A Coruña  
15401  
Spain  
**Contact:** Mr Julio Hernández,  
Commercial Manager  
T: + 34 981 338 064  
F: + 34 981 33 80 01  
E: jhernandez@apfsc.es  
W: www.apfsc.es

**Location:** North West of Spain  
**Equipment & Capacity:** Quays,  
cranes, berths, warehouses, etc.  
**Bulk Berths:** Draughts up to 20  
meters

### FERROL

**Port Authority of Ferrol-San Ciprian**  
Muelle de Curuxearas s/n  
Ferrol  
15401  
Spain  
**Contact:** Mr Miguel Villalobos, Port  
Director  
T: + 34 981 369 155  
F: + 34 981 35 31 74  
E: ferrol@ferrol.portel.es  
W: www.porto-ferrolsan Ciprian.com

### FORMENTERA

**Port of La Savina**  
Autoridad Portuaria de Baleares  
Passeig de la Marina, s/n  
Formentera  
Balearic Islands  
07870  
Spain  
**Contact:** Ms Teresa Alonso,  
T: + 34 91 32 21 30  
F: + 34 91 32 21 30  
E: portsdebalears@  
portsdebalears.com  
W: www.portsdebalears.com  
**Location:** Eastern Mediterranean  
Sea  
Balearic Islands Archipelago. North  
of Formentera

### GARRUCHA

**Garrucha**  
Empresa Publica de Puertos de  
Andalucia  
Puerto Pesquero de Garrucha  
Garrucha  
Almería  
04630  
Spain  
**Contact:** Mr AF Romero, Port  
Director  
T: + 34 9 50 46 02 36  
F: + 34 9 50 13 26 36

### GIJÓN

**AUTORIDAD PORTUARIA DE GIJÓN**  
Edificio de Servicios Múltiples  
El Musel s/n  
Gijón  
Asturias  
332012  
Spain  
**Contact:** President  
T: + 34 985 17 96 07  
F: + 34 985 35 99 17  
E: comunicacion@puertogijon.es  
W: www.puertogijon.es  
**Location:** Northwest of Spain on  
the Cantabrian Sea (Atlantic coast)  
5° 41' W 43°34' N  
**Equipment & Capacity:** 28 cranes  
(3 cranes of 2.200 tph)



**Bulk Berths:** Main bulk terminal for coal and iron ore: EBHISA (EUROPEAN BULK HANDLING INSTALLATION)  
Length: 800 m.  
Draught: 270 m with 20m. depth at L.W.O.S.T. and 530 m with 21 m depth at L.W.O.S.T.  
**Total Uncovered Storage:** 2,569,402 sqm  
**Total Covered Storage:** 60,459 sqm  
EBHISA is an enterprise owned by Port of Gijón -more than 80%- with other regional companies.

**GIJÓN**

**EBHI - European Bulk Handling Installation**

Muelle Marcelino León s/n  
El Musel  
Gijón  
Asturias  
33212  
Spain  
**Contact:** Mr Laureano Lourido, Managing Director  
T: + 34 985 308 507  
F: + 34 985 308 123  
E: lourido@ebhi.es  
W: www.ebhi.es  
**Location:** North coast of Spain.  
**Equipment & Capacity:** 17 Million tons per year capacity with a maximum daily throughput of 100,000 tons.  
**Bulk Berths:** No LOA / DWT limitation. 17.98m draught (59feet)  
**Total Uncovered Storage:** 260,000sqm

**HUELVA**

**Port Authority of Huelva**

Avda Real Sociedad Colombina  
Onubense 1  
Huelva  
21001  
Spain  
**Contact:** Mr Enrique P Gomez, Director  
T: + 34 9 59 21 31 00  
F: + 34 9 59 21 31 01  
E: aph@puertohuelva.com  
W: www.puertohuelva.com

**IBIZA**

**Port of Ibiza**

Autoridad Portuaria de Baleares  
Moll Interior, 1  
Ibiza  
Balearic Islands  
07800  
Spain  
**Contact:** Ms Teresa Alonso,  
T: + 34 971 31 06 11  
F: + 34 971 31 04 00  
E: portsdebalears@portsdebalears.com  
W: www.portsdebalears.com  
**Location:** Eastern Mediterranean Sea  
Balearic Islands Archipelago. South of Ibiza

**LA CORUÑA**

**Muelle del Centenario**

Autoridad Portuaria de la Coruña  
Avda de la Marina 3  
La Coruña  
15002  
Spain  
**Contact:** Mr Luis Felipe Fernandez Rueda,  
T: + 34 981 22 74 02  
F: + 34 981 205 862  
E: explotacion@puertocoruna.com  
W: www.puertocoruna.com

**LA CORUÑA**

**Port Authority of La Coruña**

Avenida del la Marina 3  
La Coruña  
15001  
Spain

**Contact:** Ms Marta Rodríguez Pantín, Commercial Unit Manager  
T: + 34 981 219 621  
F: + 34 981 219 600  
E: mrodrig@puertocoruna.com  
W: www.puertocoruna.com  
**Location:** North West of Spain  
**Bulk Berths:** More than 1000 m long  
**Total Uncovered Storage:** 32,000sqm  
**Total Covered Storage:** 66,400sqm  
New outer port in Punta Langosteira for bulks (250 ha surface; 22 m draft; 900 m long).

**LA CORUÑA**

**Terminales Marítimos de Galicia S.L.**

Muelle San Diego S/N  
La Coruña  
15006  
Spain  
**Contact:** Mr Juan Ibanez, Managing Director  
T: + 34 981 175690  
F: + 34 981 227556  
E: jibanez@tmconsiflet.com  
W: www.tmgas.es

**LA CORUÑA**

**Terminales Marítimos de Galicia, S.L.**

Muelle Calvo Sotelo S/N  
La Coruña  
15006  
Spain  
**Contact:** Mr Iago Mallo Sanz, Technical Manager  
T: + 34 981 12 61 69  
F: + 34 981 12 22 35  
E: imallo@tmgas.es  
W: www.tmgas.es  
**Location:** North West of Spain on the North Coast

**LOS BARRIOS**

**Endesa**

PO Box 11  
Los Barrios  
Cadiz  
11370  
Spain  
**Contact:** Mr Francisco Amoros, Commercial Department  
T: + 34 6256 04 167  
F: + 34 956 6782 11  
E: info@unesa.es

**MADRID**

**Ership S.A.U**

5th Floor  
Lagasca 88  
Madrid  
28001  
Spain  
**Contact:** Mr Carlos Nardiz, Operations and Port Terminals Manager  
T: + 34 959 21 51 52  
F: + 34 959 21 51 23  
E: ad.dir@ership.com  
W: www.ership.com  
**Location:** All Spanish ports and Aveiro (Portugal)  
**Equipment & Capacity:** Around 35 mobile harbour cranes  
**Total Covered Storage:** Around 250,000sqm  
Specialized agribulk terminals on some of the ports

**MAHON**

**Port of Mahon**

Autoridad Portuaria de Baleares  
Moll de Llevant, 1  
Mahon  
Balearic Islands  
07701  
Spain  
**Contact:** Ms Teresa Alonso,  
T: + 34 971 36 30 88/66  
F: + 34 971 36 31 01  
E: portsdebalears@

portsdebalears.com  
W: www.portsdebalears.com  
**Location:** Eastern Mediterranean Sea  
Balearic Islands Archipelago. East of Menorca  
**Equipment & Capacity:** Muelle Cos Nou. Valenciana de Cementos. 2 Silos cemento de 1.500 Tn. de capacidad, 1 silo de 1.900 Tn.  
**Total Uncovered Storage:** Muelle Cos Nou 58.945 e.m.

**MALAGA**

**Malaga Port Authority**

Muelle de Canovas s/n  
Malaga 29001  
Spain  
**Contact:** Mr Sebastian Camps, Managing Director of Malagaport A.I.E  
T: + 34 952 125 013  
F: + 34 952 125 014  
E: info@malagaport.net  
W: www.malagaport.net  
**Location:** Southern Spain, 80 miles from the Strait Gibraltar  
**Equipment & Capacity:** Total: 6,210 metres (ro ro ramps, containers, dry and liquid bulk, fishing and cruises berths)  
**Bulk Berths:** Docks 5, 6 and 7  
**Total Uncovered Storage:** 353,498sqm  
**Total Covered Storage:** 4,884sqm

**MARIN**

**Ceferino Nogueira SA**

Avenida Orensne 1-B  
Marin  
Pontevedra  
36900  
Spain  
**Contact:** Mr Ceferino Nogueira Garcia,  
T: + 34 986 88 0600  
F: + 34 986 88 4776  
E: info@nogar.es

**MELILLA**

**Port Authority of Melilla**

Avda of Spanish Navy No 4  
Melilla  
52001  
Spain  
**Contact:** Mr Alejandro Suarez, Marketing Department  
T: + 34 952 673 600  
F: + 34 952 674 838  
E: asuarez@puertodemelilla.es  
W: www.puertomelilla.com

**MOTRIL**

**Port of Motril**

C/ Recinto Portuario, S/N  
Motril  
Granada  
18613  
Spain  
**Contact:** Mr Domingo Reyes Martín, Operations & Port Services  
T: + 34 958 60 12 07  
F: + 34 958 60 12 34  
E: dreyes@apmotril.com  
W: www.apmotril.com  
**Location:** South East Spain, Strait of Gibraltar, Alboran Sea  
**Equipment & Capacity:** 2 cranes, 350 and 250 tph  
**Bulk Berths:** 607 / 260m length, 12m depth  
**Total Uncovered Storage:** 683,929sqm  
**Total Covered Storage:** 6,174sqm  
Please see our website www.apmotril.com for more details

**PALMA**

**Port of Palma**

Autoridad Portuaria de Baleares  
Muelle Viejo 3  
Palma  
Balearic Islands  
07012

Spain  
**Contact:** Mr M Ginard, Head of Marketing  
T: + 34 971 22 81 50  
F: + 34 971 72 69 48  
E: mginard@portsdebalears.com  
W: www.portsdebalears.com  
**Location:** Eastern Mediterranean Sea  
Balearic Islands Archipelago. South of Mallorca  
**Equipment & Capacity:** Dique del Oeste - 2ª alineación. Silos y almacenes Baleares, S.A.. 3 Silos de cemento de 3.800 Tn. de capacidad, 1 toma de descarga de 200 Tn.hora  
Dique del Oeste - 2ª alineación. Cemex España, S.A.. 3 Silos de cemento de 3.800 Tn. de capacidad, 1 toma de descarga de 200 Tn.hora  
**Total Uncovered Storage:** Muelle de Ribera-18.644 e.m.  
**Total Covered Storage:** Muelle de Ribera 4.651 e.m. (Grain/Agribulk)

**PASAJA**

**Port Authority of Pasaja**

Edificio Transatlántico, Zona Portuaria s/n  
Apartado 56  
Pasaja  
Puzoska, Basque Country  
20110  
Spain  
T: + 34 943 35 18 44  
F: + 34 943 35 01 41  
E: app@pasaiaport.eus  
W: www.pasaiaport.eus  
**Location:** North Spain, Bay of Biscay  
43° 19' 15,82" N.  
01° 55' 15,98" W.  
**Total Uncovered Storage:** 423,230sqm  
**Total Covered Storage:** 56,429sqm

**PTO. ALCUDIA**

**Transportes Marítimos Alcudia, SA**

Teodoro Canet No 26  
Pto. Alcudia  
Mallorca-Baleares  
07400  
Spain  
**Contact:** Mr Miguel Oliver, Managing Director  
T: + 34 971 545 932/28  
F: + 34 971 547 356  
E: moliver@tmalcudia.com  
W: www.portsdebalears.com

**SAGUNTO**

**Port of Sagunto**

Autoridad Portuaria de Valencia  
Muelle Centro SN  
Sagunto  
46520  
Spain  
**Contact:** Mr Ramon Izquierdo, Port Administrator  
T: + 34 96 269 9002  
F: + 34 96 3268 0972  
E: psagunto@valenciaport.com

**SANTA CRUZ DE**

**TENERIFE**

**Port Authority of Tenerife**

Avenida Francisco La Roche No 49  
Santa Cruz de Tenerife  
Canary Islands  
Spain  
**Contact:** Mr Manuel Fernandez del Castillo, Port Director  
T: + 34 9 22 605400  
F: + 34 9 22 605479  
E: comercial@puertosdetenerife.org  
W: www.puertosdetenerife.org

**SANTANDER**

**Autoridad Portuaria de Santander**

Puerto de Santander  
Muelles de Maliaño s/n  
Santander  
Cantabria  
E390 09  
Spain  
**Contact:** Mr Jaime González, Chairman  
T: + 34 942 20 36 00  
F: + 34 942 20 36 33  
E: info@puertosantander.com  
W: www.puertosantander.com  
**Location:** North of Spain on the north Cantabrian coast.  
**Equipment & Capacity:** Water Depth 13m  
Panamax  
**Bulk Berths:** 1,760m  
**Total Uncovered Storage:** 911,768sqm  
**Total Covered Storage:** 160,498sqm  
- Santander to Madrid 393 kilometers. tax free.  
- High intermodal accessibility  
- Multipurpose port. Last generation terminals

**SEVILLA**

**Port Authority of Sevilla**

Avenida de Molini No 6  
Sevilla  
41012  
Spain  
**Contact:** Mr Manuel A. Fernandez González, President  
T: + 34 954 24 73 00  
F: + 34 954 24 73 33  
E: sevilla@apsevilla.com  
W: www.apsevilla.com

**TARRAGONA**

**Berge Marítima**

Tarragona  
Spain  
**Contact:** Mr. Daniel Vega,  
T: + 34 977 55 05 00  
F: + 34 977 48 43 82  
E: consignacion.tar@berge-m.es  
W: www.berge-m.es

**TARRAGONA**

**Codemar-Iberbulk**

Muelle de Castilla, s.n.  
Tarragona  
43004  
Spain  
**Contact:** Mr Luis Fernández, General Manager  
T: + 34 9 77 21 5273  
F: + 34 9 77 22 98 53  
E: fernandez@codemar-iberbulk.es  
W: www.codemar-iberbulk.es  
**Location:** North East of Spain in the Mediterranean Coast. South of Barcelona. Distance to Barcelona 100km.  
**Bulk Berths:** Limitation according to the public information by the Port Authority of Tarragona.  
**Total Covered Storage:** Out 34,000 sqm covered flat stores  
Conveyor belts running from quayside to three of five flat stores in our facilities at the Muelle de Castilla yard.

**TARRAGONA**

**Euroports Iberica TPS**

Apto. Correos 839  
Tarragona  
Tarragona  
43080  
Spain  
**Contact:** Mr Javier Herrera, Commercial Manager  
T: + 34 977 22 22 19  
F: + 34 977 22 04 59  
E: jherrera@europortsiberica.com  
W: www.euroports.com

**Location:** North Mediterranean coast of Spain  
**Equipment & Capacity:** Unload: 24,000/day for coal, 14,000/day for agribulk  
**Bulk Berths:** Draught from 18.5m to 13.2m  
**Total Uncovered Storage:** 160,000sqm  
**Total Covered Storage:** 70,000sqm  
Handling Pulp, Steel and all type of General Cargo, developing at this step a new specialized terminal.

**TARRAGONA**

**Port Authority of Tarragona**

Passeig de l'Escullera s/n  
Tarragona  
43004  
Spain  
**Contact:** Mr Pedro Bernal, Commercial & Business Development Manager  
T: + 34 977 259 400  
F: + 34 977 241 372  
E: comercial@porttarragona.cat  
W: www.porttarragona.cat  
**Location:** North East of Spain.  
**Equipment & Capacity:** Bridge cranes, forklifts, mobile cranes,...., 1,850,000 tons capacity  
**Bulk Berths:** 3,000m wharf length and max. draught 14m  
**Total Covered Storage:** 230,000 sqm covered storage  
5,000,000 tpa of annual throughput  
5 dedicated terminals  
Unloading average productivity: 500 tph  
60% of the raw materials used to produce feed for Catalan livestock pass through the Port of Tarragona every year.

**TARRAGONA**

**Silos de Tarragona SA (SITASA)**

Muelle Castilla s/n Ap.160  
Tarragona  
43080  
Spain  
**Contact:** Mr Joan Marc Papiro, Director  
T: + 34 977 259 500  
F: + 34 977 259 530  
E: jmpapiro@silostgna.com  
W: www.silostgna.com

**TORREVEJIA**

**Torreveja Port Authority**

Espanlada del Mar s/n  
Torreveja  
Spain  
**Contact:** Port Director  
T: + 34 96 571 0234  
F: + 34 96 571 0234

**VALENCIA**

**Inst Portuarias de Estudios**

Puerto de Málaga  
Muelle de Cánovas  
Valencia  
46024  
Spain  
**Contact:** Mr Ramon Gomez-Ferrer Boldova, Director  
T: + 34 952 125 011  
F: + 34 952 125 014  
E: iep@puertomalaga.com  
W: www.puertomalaga.com/

**VALENCIA**

**Port Authority of Valencia**

Av. Muelle del Turia s/n  
Valencia 46024  
Spain  
**Contact:** Ms Francesca Antonelli, Marketing Manager  
T: + 34 9 6 393 95 00  
E: fantonelli@valenciaport.com  
W: www.valenciaport.com  
**Location:** Spain's Eastern Mediterranean Coastline

## VIGO

**Port Authority of Vigo**  
Plaza de la Estrella, 1 (VIGO)  
Vigo  
E: 36201  
Spain  
**Contact:** Ms Dolores Rois,  
Commercial Director  
T: + 34 9 86 26 80 00  
F: + 34 9 86 26 80 01  
E: drois@apvigo.es  
W: www.apvigo.es

## VILAGARCÍA DE AROUSA

**Autoridad Portuaria de Vilagarcía de Arousa**  
Muelle de Pasaxeiros, 1  
Vilagarcía de Arousa  
36600  
Spain  
**Contact:** Ms Patricia González  
Núñez, Jefa de Unidad de Relaciones Externas  
T: + 34 986 56 59 20  
E: comunicacion@portovilagarcia.es  
W: www.portovilagarcia.es  
**Location:** North West of Spain, on the Atlantic coast of Galicia  
**Equipment & Capacity:** Total length of berth in commercial docks: 2,665 metres. 9 lines of quay, 9 crane onto rails, 2 mobile high-tonnage cranes, pipelines systems for liquid bulks and for cement, 4 ro-ro ramps.  
**Bulk Berths:** - For solid bulks by specific installation: 427 linear metres, depth 11/13 m.  
- For solid bulks without specific installation: 950 linear metres, depth up to 13m.  
**Total Uncovered Storage:** 177,152 sqm  
**Total Covered Storage:** 65,409 sqm  
The Port enjoys a privileged location in a wide, sheltered bay, and has excellent communications by road and railway. It also has a Border Inspection Post.

## SRI LANKA

### GALLE

**Galle Port**  
Sri Lanka Ports Authority  
Closenbergh Jetty  
Magalla  
Galle  
Sri Lanka  
**Contact:** Harbour Master  
T: + 94 11 242 1201  
F: + 94 11 244 0651  
E: webmaster@slpa.lk

## ST PIERRE &

## MIQUELON

### SAINT-PIERRE AND

### MIQUELON

**Saint-Pierre Harbour**  
Quai de l'Alysee  
BP 4235  
Saint-Pierre and Miquelon  
97500  
St Pierre & Miquelon  
**Contact:** Mr Enrique Perez,  
Harbour Master  
T: + 11 508 410 974  
F: + 11 508 410 979  
E: enrique.perez@equipement.gouv.fr  
W: www.saint-pierre-et-miquelon.developpement-durable.gouv.fr  
**Location:** The North Atlantic Ocean, south of the Canadian province of Newfoundland and Labrador.  
**Equipment & Capacity:** 5 mobile cranes (5t-20t capacity).

Wheel crane (70 t).  
**Bulk Berths:** 3 wharfs up to 170sqm long. Draught: 6m-8.5m  
**Total Uncovered Storage:** 17,500sqm  
**Total Covered Storage:** 2,800sqm in warehouse  
The working VHF channel of the harbour is ch 12.  
Harbour Master cell phone: + 11 508 551 321

## ST VINCENT

## & THE

## GRENADINES

### KINGSTOWN

**Kingstown**  
St Vincent Port Authority  
PO Box 1237  
Kingstown  
St Vincent & The Grenadines  
**Contact:** Mr Brennan B King,  
Harbour Master  
T: + 1809 4561830  
F: + 1809 45626732  
E: portsvjg@mail.carbsurf.com

## SUDAN

### PORT SUDAN

**Sea Ports Corporation**  
PO Box 531  
Port Sudan  
Sudan  
**Contact:** Eng Ibrahim A. Ahmed,  
General Manager  
T: + 249 2910  
F: + 249 2127  
E: ohag\_ohag@hotmail.com  
**Location:** North East coast. 1200 miles south swiscanal-Egypt  
**Equipment & Capacity:** 16 quay cranes, 6 STS gantry, 15 RTG, 46 handling facilities with average loading capacity 3-50 tons  
**Bulk Berths:** 4 berths - overall length 861m, depth 16m for each  
**Total Uncovered Storage:** 850,000m  
**Total Covered Storage:** 1,350,000m  
New projects for container berths and Suakin Port, livestock & vegetables loading new terminal under construction.

## SULTANATE

## OF OMAN

### LIWA

**C. Steinweg Oman LLC**  
P O Box 338, pc 325  
Liwa  
Sohar  
Sultanate of Oman  
**Contact:** Mr Herman Zaanen,  
Terminal Facilities Manager  
T: + 96 8 2685 0418  
F: + 96 8 2685 0426  
E: h.zaanen@om.steinweg.com

### MUSCAT

**Oman Flour Mills Co SAOG**  
PO Box 566  
Ruwi-112  
Muscat  
Sultanate of Oman  
**Contact:** Mr Ali Habaj, General Manager  
T: + 968 24711155  
F: + 968 24714711  
E: flour@omantel.net.om  
W: www.omantflourmills.com

## MUSCAT

**Port Sultan Qaboos**  
Port Services Corporation (SAOG)  
PO Box 133  
Muscat  
100  
Sultanate of Oman  
**Contact:** Mrs Sunita Ramakrishnan,  
Marketing Manager  
T: + 968 24714000  
F: + 968 24714007  
E: mktg@pscoman.com  
W: www.pscoman.com

## N. AZAIBA

**Port of Duqm Company SAOC**  
3rd Floor, Al Mashreq Building  
18th November Street  
N. Azaiba 111  
Sultanate of Oman  
**Contact:** Mr Erwin Mortelmans,  
Commercial Director  
T: + 968 24 342800  
F: + 968 24 587343  
E: info@portduqm.com  
W: www.portduqm.com  
**Location:** Duqm - East Coast Oman  
**Equipment & Capacity:** 5 Million tons dry bulk loading capacity  
**Bulk Berths:** 300m  
**Total Uncovered Storage:** 100,000sqm  
**Total Covered Storage:** 0

## SURINAME

### PARAMARIBO

**N.V. Havenbeheer Suriname**  
Suriname Ports Management Company  
Havenlaan Zuid #5  
Paramaribo  
Suriname  
**Contact:** Mr John A. Defares,  
Managing Director/CEO  
T: + 597 40 2375  
F: + 597 40 3691  
E: smeport@sr.net  
**Location:** Nieuwe Haven  
Within the Capital (Paramaribo) about 20 km up stream of the "Suriname river".  
**Equipment & Capacity:** Cranes with lifting capacity of 100 tons  
**Bulk Berths:** No special Bulk facilities  
**Total Uncovered Storage:** 8.9 ha  
**Total Covered Storage:** Temporary shed about 2,000sqm  
The port is nearing the finalization of a rehabilitation process. In 2010 more covered storage space will be created.

## SWEDEN

### GAVLE

**Port of Gavle AB**  
Fredriksskans  
Gavle 806 47  
Sweden  
**Contact:** Ms Agneta Bast, Assistant T: + 46 26 178843  
E: info@gavle-port.se  
W: www.gavle-port.se/  
**Location:** On the east coast of Sweden, just north of Stockholm  
**Equipment & Capacity:** Mobile cranes, SWL 244MT, Gantry cranes for container handling etc.  
**Bulk Berths:** Draught 12.2 meters  
**Total Uncovered Storage:** 1,000,000 sqm  
**Total Covered Storage:** 100,000 sqm

### GÄVLE

**Baltic Sea Gateway AB**  
Fredriksskans  
Gävle

SE 806 47  
Sweden  
**Contact:** Mr Håkan Bergström,  
Managing Director  
T: + 46 70 082 61 83  
E: hakan.bergstrom@balticseagateway.com

## GÖTEBORG

**Port of Göteborg**  
Nordtältauten  
Gate 5  
Göteborg  
SE 403 38  
Sweden  
**Contact:** Ms Susan Hansel, Media Relations officer  
T: + 46 31 731 23 25  
F: + 46 31 731 22 03  
E: eva.jonasson@portgot.se  
W: www.portgot.se

## HALMSTAD

**Halmstad Port**  
PO Box 1  
Halmstad  
301 02  
Sweden  
**Contact:** Ms Birgitta Johansson,  
Production Manager  
T: + 46 35 15 53 14  
F: + 46 35 14 05 93  
E: birgitta.j@porthalmstad.com  
W: www.halmstadharbour.se

## HELSINGBORG

**Helsingborg Coal Terminal**  
PO Box 821  
Helsingborg  
S-25108  
Sweden  
**Contact:** Mr Andreas Eriksson,  
Information Officer  
T: + 46 4210 6300  
F: + 46 4212 4374  
E: andreas.eriksson@port.helsingborg.se  
W: www.port.helsingborg.se

## HELSINGBORG

**Helsingborgs Hamn, Port of Helsingborg**  
Oceangatan 3  
PO Box 821  
Helsingborg  
SE 251 08  
Sweden  
**Contact:** Mr Kjell-Åke Ranft, Sales Manager  
T: + 46 42 10 63 00  
F: + 46 42 22 22 99  
E: kjell.ranft@port.helsingborg.se  
W: www.port.helsingborg.se  
**Location:** Swedish southwest coast  
Handles fiberfuels and for the local powerplant.

## HELSINGBORG

**Lantmännen, Farmers Assoc.**  
Massgodsleden  
Helsingborg  
252 25  
Sweden  
**Contact:** Mr Claes Nilsson,  
Operations Manager  
T: + 46 10 556 33 82  
E: claes.nilsson@lantmannen.com  
W: www.lantmannen.com  
**Location:** South of Sweden  
**Equipment & Capacity:** Ship loader up to 800 tons per hour  
**Bulk Berths:** Length: 210 meters, depth: 12.5 meters  
**Total Covered Storage:** 240 000 ton  
Possibility to load up to Panamax size.

## HELSINGBORG

**Vänerhamn AB**  
Kajgatan 8  
Kristinehamn  
681 37  
Sweden  
**Contact:** Mr Klas Höggren,  
Operation Manager  
T: + 46 550 87760  
F: + 46 550 83897  
E: Klas.hoggren@vanerhamn.se  
W: www.vanerhamn.se  
**Location:** Lake Vänern

## HUSUM

**Husum Port**  
Mo ch Domsjö AB  
Harbour Department, Husum Mill  
Husum

890 35  
Sweden  
**Contact:** Mr Conny Sallander, Port Manager  
T: + 46 660 78714  
F: + 46 660 299 028  
E: conny.sallander@ovikshamn.se  
W: www.omskodsvikshamn.se

## KALMAR

**Kalmar Hamn AB (Port of Kalmar)**  
PO Box 810  
Kalmar  
391 28  
Sweden  
**Contact:** Mr Carl-Johan Nordheim,  
Managing Director  
T: + 46 480 45 14 50  
F: + 46 480 45 14 58  
E: info@kalmarhamn.se  
W: www.kalmar.se/kalmarhamn  
**Location:** South East Coast of Sweden  
**Equipment & Capacity:** 7 mobile cranes, 15-36 tonnes capacity  
**Bulk Berths:** max depths 7.7m  
**Total Uncovered Storage:** 75,000sqm  
**Total Covered Storage:** 13,000sqm

## KARLSHAMN

**Port of Karlshamn**  
PO Box 8  
Karlshamn  
374 21  
Sweden  
**Contact:** Mr Björn Nilsson,  
Marketing Manager  
T: + 46 454 30 50 00  
F: + 46 45 48 10 40  
E: info@karlshamnshamn.se  
W: www.karlshamnshamn.se

## KARLSTAD

**Vänerhamn AB**  
Stuvargatan 1  
Karlstad  
652 21  
Sweden  
**Contact:** Mr Tobias Uhn, Sales Manager  
T: + 46 54 14 48 60  
F: + 46 54 21 33 16  
E: tobias.uhn@vanerhamn.se  
W: www.vanerhamn.se  
**Location:** Five modern ports at lake Vänern, strategically located in the heart of Sweden. Ports are Vänersborg, Lidköping, Otterbäcken, Kristinehamn and Karlstad. Well-developed infrastructure and excellent opportunities for combining sea transport with road and rail.  
**Equipment & Capacity:** 11 railborne, 4 fixed and 6 mobile crane, Heavy lift crane 200 tonnes. Forklifts, loading machines and bobcats.  
**Bulk Berths:** argest vessel size 88 x 13,20 x 5,40 m (Vänernmax)  
**Total Uncovered Storage:** 312,000 sqm  
**Total Covered Storage:** 109,000 sqm

## KRISTINEHAMN

**Vänerhamn AB**  
Kajgatan 8  
Kristinehamn  
681 37  
Sweden  
**Contact:** Mr Klas Höggren,  
Operation Manager  
T: + 46 550 87760  
F: + 46 550 83897  
E: Klas.hoggren@vanerhamn.se  
W: www.vanerhamn.se  
**Location:** Lake Vänern

## LULEÅ

**Port of Luleå**  
Stromorvagen 9

Luleå  
SE 974 37  
Sweden  
**Contact:** Mr Roger Danell, Port Director  
T: + 46 9204 53000  
F: + 46 920 25 55 94  
E: leif.berg@hamn.lulea.se  
W: www.lulea.se/hamnen

## LYSEKIL

**Port of Lysekil**  
Hamnkoretet  
Lysekil  
S-453 80  
Sweden  
**Contact:** Mr Olle Samuelson,  
Harbour Master  
T: + 46 523 14090  
F: + 46 523 14094  
E: olle.samuelson@lysekil.se  
W: www.lysekilhamn.se  
**Location:** West of Sweden  
**Equipment & Capacity:** Cranes, Hopper, Fork-lifts etc  
**Total Uncovered Storage:** 30,000sqm  
**Total Covered Storage:** 30,000sqm

## MALMÖ

**Copenhagen Malmö Port AB**  
Terminalgatan 18  
Box 566  
Malmö  
S-201 25  
Sweden  
**Contact:** Mr Soren Balken,  
Communications and Public Relations Coordinator  
T: + 46 40 680 4100  
F: + 46 40 180 501  
E: soren.balken@cmport.com  
W: www.cmport.com  
**Location:** Copenhagen Malmö Port is located in the Öresundregion with terminals in both Denmark and Sweden.  
**Equipment & Capacity:** CMP: 3 stationary cranes 20 tons  
1 mobilecrane 64 tons, capacity 12,000 tonnes of coal a day  
1 multidocker 8.5 tons, 1 Fuchs  
**Bulk Berths:** CMP facilities:  
Svede Harbour/1001,1002 - 200 m - 13.5 m  
Sodra Bulk/ 740, 750, 751 - 6.0 m  
Provestenen/855,856,857,858,859,860,861 - 679 meters - 10.5 - 6.0 m  
Private operators:  
Amagerværket/835,836,837,838 - 440 meters - 12.0 m  
Margretholm/825 - 140 meters - 6.0 m  
Kalkbrænderihavnen/401,402 - 230 m - 6.7 m  
**Total Uncovered Storage:** Approx 500,000 sqm  
**Total Covered Storage:** 60,000 sqm  
A new 180,000sqm terminal for bulk is constructed. Taken into use 2015. Terminal has 650m of quay with a water depth of 11.4m.

## OXELSUND

**Oxelosunds Hamn AB**  
Box 1200  
Oxelosund  
SE-61324  
Sweden  
**Contact:** Mr Bo Ytterstrom,  
Marketing Manager  
T: + 46 155 258 000  
F: + 46 1553 4321  
E: bo.ytterstrom@oxhamn.se  
W: www.oxhamn.se  
**Bulk Berths:** Draught 15.3m. Max LOA 265m. Max Beam 41m.

## SÖDERTÄLJE

**Port of Sodertälje**  
PO Box 2016  
Södertälje  
151 02  
Sweden



**Contact:** Mr Erik Froste, Managing Director  
**T:** + 46 8 55 02 37 40  
**F:** + 46 8 55 03 19 49  
**E:** info@soeport.se  
**W:** www.soeport.se

**SONDERHAMN**

**Sonderhamn Port**  
 Strandgaten 4  
 Sonderhamn  
 826 60  
 Sweden  
**Contact:** Mr Tommi Eriksen, Harbour Master  
**T:** + 46 270 28 41 32  
**F:** + 46 270 28 41 26  
**E:** info@ssh.se

**STOCKHOLM**

**Port of Hargshamn**  
 742 50 Hargshamn  
 Stockholm  
 Sweden  
**Contact:** Mr Hakan Nilsson, Port Director  
**T:** + 46 173 20155  
**F:** + 46 173 20311  
**E:** hakan.nilsson@hargshamn.se  
**W:** www.hargshamn.se

**UDDEVALLA**

**Uddevalla Port**  
 Uddevalla Hamnterminal AB  
 PO Box 543  
 Bastiongatan 5  
 Uddevalla  
 451 21  
 Sweden  
**Contact:** Mr Ulf Stenberger, Harbour Master  
**T:** + 46 522 912 04 / + 46 522 91244  
**F:** + 46 522 33630  
**E:** ulf.stenberger@uddevalla-hamn.se  
**W:** www.stockholmshamn.se

**VÄSTERÅS**

**Mälarenhammar AB**  
 Box 3013  
 Västerås  
 720 03  
 Sweden  
**Contact:** Mr Magnus Johansson, Sales Manager  
**T:** + 46 21 150100  
**F:** + 46 21 150145  
**E:** magnus.johansson@malarhammar.se  
**W:** www.malarhammar.se  
**Location:** In the lake of Mälaren we have two ports, one in Köping and one in Västerås, Sweden  
**Equipment & Capacity:** Cranes, loaders, Reachstackers, trucks, etc.  
**Bulk Berths:** 7 berths  
**Total Uncovered Storage:** 100,000sqm  
**Total Covered Storage:** 55,000sqm  
 Receiving ships up to 7,000 tons net weight. Ongoing investments to receive 13,000 tons. Reaching 1/3 of Swedens population within 200 km radius (3 million people).

**YSTAD**

**Port of Ystad**  
 Bornholmsgatan 6  
 Ystad  
 Scania  
 27139  
 Sweden  
**Contact:** Mr Michael Torrnfeldt, Operational Manager  
**T:** + 46 411 577 661  
**F:** + 46 411 749 50  
**E:** michael.torrnfeldt@ystad.se  
**W:** www.port.ystad.se  
**Location:** Ystad is situated on the south coast of Sweden. N55 - 24.5 - E 013 - 43'  
**Equipment & Capacity:** Cranes: 1 mobile, capacity 40 tons.

Stevedoring: Ystad Stevedores, fork trucks (max 7 tons), terminal tugmasters, bobcats and loading machines.  
**Bulk Berths:** Bulk, ferry and industrial port guarantees a water depth of 7.2m at normal tide levels. Water depth in the anchorage basin 15m.  
 Quays: Length 1.100 m. Load allowed 2-3 t/m<sup>3</sup>. Axle pressure 10/16 t. 1,000m railway tracks in the dock area.  
**Total Covered Storage:** Warehouses: The Port Administration: 4.500 sqm, Ystads Stevedores 2.200 sqm and Pol-Line 400 sqm  
 The Port of Ystad is ISPS certified.

**SWITZERLAND**

**BASEL**

**Port of Switzerland**  
 Hochbergerstrasse 160  
 Basel  
 CH-4019  
 Switzerland  
**Contact:** Ms Carmen Koller, Director  
**T:** + 41 61 639 9577  
**F:** + 41 61 639 9514  
**E:** carmen.koller@portofch.ch  
**W:** www.port-of-switzerland.ch  
**Location:** North West of Switzerland  
**Equipment & Capacity:** 60 cranes  
**Bulk Berths:** 7 km, 3.2 m  
**Total Uncovered Storage:** 200,000 sqm  
**Total Covered Storage:** 250,000 sqm  
 Container terminals, distribution centers, tank storage, elevators

**BASEL**

**Rhenus-Alpina AG**  
 Basel  
 Switzerland  
**Contact:** Ms Claudia Bracher,  
**T:** + 41 61 639 33 33  
**F:** + 41 61 639 34 66  
**E:** info@rhenus.ch

**BASEL**

**Ultra-Brag AG**  
 Südquaistrasse 55  
 Basel  
 CH-4019  
 Switzerland  
**Contact:** Mr Beat Heydrich, CEO  
**T:** + 41 61 639 72 00  
**F:** + 41 61 639 72 10  
**E:** info@ultra-brag.ch  
**W:** www.u-b.ch  
**Location:** Ports of Basel, Switzerland (City of Basel, Birsfelden, Auhafen)  
**Equipment & Capacity:** Various cranes up to 600mt lifting capacity  
**Total Uncovered Storage:** 25,000sqm  
**Total Covered Storage:** 30,000sqm  
 3 silos for storage of up to 90,000mt grain and animal feeds

**BIRSFELDEN**

**BIRS Terminal AG**  
 Hafenstrasse 54  
 Postfach  
 Birsfelden  
 CH 4127  
 Switzerland  
**Contact:** Ms Sabine Schmid,  
**T:** + 41 61 377 8032  
**F:** + 41 61 377 8010  
**E:** sabine.schmid@birsterminal.ch  
**W:** www.birsterminal.ch

**LUGANO**

**Interbulk**  
 Via Bagutti 6  
 Lugano  
 6904

Switzerland  
**Contact:** Mr Michele Caffarena, International Terminals Department  
**T:** + 41 91 911 37 41  
**F:** + 41 91 911 37 29  
**E:** m.caffarena@interbulk.ch

**SYRIA**

**TARTOUS**

**Tartous Port Authority**  
 PO Box 86  
 Tartous  
 Syria  
**Contact:** Eng. Zaki-E Najib, Port Manager  
**T:** + 963 43 313 752  
**F:** + 963 43 315 602  
**E:** ta-pco@mail.sy  
**W:** www.tartousport.com

**TAIWAN**

**HUALIEN**

**Hualien Port**  
 Hualien Harbour Bureau  
 No 66 Hai-Ann Road  
 Hualien  
 Taiwan  
**Contact:** Mr Li Keh-Shul, Harbour Bureau Director  
**T:** + 886 38 325131  
**F:** + 886 38 333757  
**E:** lly@mail.hhnb.gov.tw  
**W:** www.hhnb.gov.tw

**KAOSHIUNG**

**Kaohsiung Harbour Bureau**  
 No. 62  
 Lin Hai 2nd Rd  
 Kaohsiung  
 Taiwan  
**Contact:** Mr Ting-Yi Tsai, Harbour Manager  
**T:** + 886 7 562 2100  
**F:** + 886 7 521 6915  
**E:** p04685@mail.khb.gov.tw  
**W:** www.khb.gov.tw  
**Location:** South West coast of Taiwan  
**Equipment & Capacity:** 18 cement silos (278,000t), 2 grain silos (180,000t), 1 coal silo (80,000t)  
**Bulk Berths:** 20 dry bulk cargo wharves  
**Total Uncovered Storage:** 6 open storage yards (44,885sqm)  
**Total Covered Storage:** 50 warehouses (221,662sqm)

**KEELUNG**

**Keelung Port Authority**  
 Keelung Harbour Bureau  
 Port Building  
 1 Chung Cheng Road  
 Keelung  
 202  
 Taiwan  
**Contact:** Mr Han Te An, Director  
**T:** + 886 2 428 1156  
**F:** + 886 2 428 5613  
**E:** dtdpd200@kphb.gov.tw  
**W:** www.jlhb.gov.tw

**MAI LIAO**

**Mai Liao Harbour Administration Corp**  
 No 1-1 Formosa Industrial Complex  
 Mai Liao  
 Yunlin County  
 638  
 Taiwan  
**T:** + 886 5681 2766  
**F:** + 886 5681 2135  
**E:** captliow@pg.com.tw  
**Location:** West South West of Taiwan  
**Equipment & Capacity:** 1x grab type/12,000tpd, 2x bucket type/15,000tpd, 5x screw type/ 25,000tpd  
**Bulk Berths:** E2, E3, E4, E5

Other commodities handled - industrial salt.

**SUAO PORT BUILDING**

**Su-Ao Port Authority**  
 Su-Ao Harbour Bureau  
 3rd Floor  
 Suao Port Building  
 Suao  
 Taiwan  
**Contact:** Mr Kuo-Hung Yeh, Port Manager  
**T:** + 886 39 972001  
**F:** + 886 39 952739  
**E:** srdykh@kphb.gov.tw

**TAICHUNG**

**Port of Taichung, Asia Cement Berth**  
 Taichung Harbour Bureau  
 Wuchi  
 Taichung  
 Taiwan  
**Contact:** Mr CT Huang, Director  
**T:** + 886 4 656 2611  
**F:** + 886 4 656 5703

**TAICHUNG**

**Taichung-Wharf No 1**  
 Pei Heng 11 Road  
 Ching Shui Chen  
 Taichung  
 Taiwan  
**T:** + 886 4 656 4211  
**F:** + 886 4 656 8069

**TAIPEI**

**Eastern Media International Corporation**  
 8th Floor  
 Yu Tai Enterprise Building  
 368 Fu Hsing South Road  
 Section 1  
 Taipei  
 106  
 Taiwan  
**Contact:** Mr Michael LY Pan, Executive Vice President  
**T:** + 886 2 2755 7565  
**F:** + 886 2 2702 8079  
**E:** spokesman@emic.com.tw  
**W:** www.emic.com.tw

**WUCHI**

**Taichung Port Authority**  
 Taichung Harbour Bureau  
 Harbour Building  
 Wuchi  
 Taichung District  
 Taiwan  
**Contact:** Mr C T Huang, Director  
**T:** + 886 4 656 2611  
**F:** + 886 4 656 5702  
**E:** director@mail.tchb.gov.tw  
**W:** www.tchb.gov.tw

**TANZANIA**

**DAR ES SALAAM**

**Tanzania Harbours Authority**  
 Bandari Street  
 PO Box 9184  
 Dar es Salaam  
 Tanzania  
**Contact:** Mrs Francisca K Muindi, Director of Marketing  
**T:** + 255 22 2115559  
**F:** + 255 22 2115559  
**E:** dm@tanzaniaports.com

**DAR ES SALAAM**

**Tanzania Ports Authority**  
 Dar es Salaam Port  
 PO Box 1130  
 Dar es Salaam  
 Tanzania  
**Contact:** Mr Iddi Mkwata, Port Manager  
**T:** + 255 22 2113642  
**F:** + 255 22 2113646  
**E:** pmdsm@tanzaniaports.com  
**W:** www.tanzaniaports.com

**Location:** Latitude 6.5 and Longitude 39.17 East Coast of East Africa  
**Equipment & Capacity:** General cargo Terminal- Mobile cranes 63T, 35T, Portal cranes, Tractors, Trailers, Frontloader, Forklifts, bagging units, hoppers, etc.  
**Bulk Berths:** 2 berths, designed water depth of 12.2m., length of 183m.each.  
**Total Uncovered Storage:** 82,700sqm  
**Total Covered Storage:** 66,900sqm

**KURASINI**

**Grindrod Terminals - Dar Es Salaam**  
 Bandari Road, Plot 2A,  
 Mission to Seafarer's Compound  
 Annex Building Ground Floor  
 Kurasini  
 Dar Es Salaam  
 Tanzania  
**Contact:** Mr Peter Buchholz, Regional Manager  
**T:** + 255 22 213 3848  
**F:** + 255 22 213 3848  
**E:** peterb@grindrod.co.tz  
**W:** www.grindrod.co.za  
**Location:** East coast of Africa in Tanzania  
**Equipment & Capacity:** 15 000 million tons bulk sulphur can be handled per vessel  
**Bulk Berths:** Berth No7  
**Total Covered Storage:** Shed No 4 2700m<sup>2</sup>  
 Currently discharge, store and bag commodity. Handle 80 000 tons of sulphur pa but have the capability of handling other commodities such as Nickel, copper concentrate, Ingots, Manganese ore and Fertilizer.

**THAILAND**

**BANGPLI**

**S.P. Intermarine Co., Ltd**  
 150/90 Moo 3 Soi Wongsepap  
 Teprarak Road (Km.10)  
 Bangpli Yai  
 Bangpli  
 Samutprakam  
 10540  
 Thailand  
**Contact:** Mr Kriehp Suwajanakom, Marketing Department  
**T:** + 662 385 5335  
**F:** + 662 385 5910  
**E:** info@spintermarine.co.th  
**W:** www.spintermarine.co.th  
**Location:** Gulf of Thailand  
**Equipment & Capacity:** 4 VERSA MAX transhipment stations. 10 high-speed floating cranes. Commodity-specific grabs. Transhipment capacity up to 2,000 TPH.  
 More than 2,000,000 metric tons of various cargoes per year.. Suitable for all agri and industrial bulks.

**SATTAHIP**

**Sattahip Port Authority**  
 102/21 Moo 6 Plutalaung  
 Sattahip  
 Choburi Province  
 Thailand  
**Contact:** Port Director  
**T:** + 66 38 43134850  
**F:** + 66 38 431261

**SINGHANAKORN**

**Chaophaya Terminal International Co. Ltd**  
 Songkhla Port  
 Moo 7, Huakao  
 Singhanakorn  
 Songkhla  
 90280  
 Thailand

**Contact:** Mr Jun Tao, Port Director  
**T:** + 66 74 3310738  
**F:** + 66 74 331199  
**E:** info.skp@ctic.co.th  
**W:** www.ctic.co.th

**THE GAMBIA**

**BANJUL**

**The Gambia Ports Authority**  
 Liberation Ave  
 Banjul  
 The Gambia  
**Contact:** Miss Naffi Macdougall,  
**T:** + 220 229940  
**F:** + 220 227268  
**E:** info@accessgambia.com  
**W:** www.accessgambia.com/

**THE**

**NETHERLANDS**

**AMSTERDAM**

**Amfert**  
 Fosfaatweg 48  
 PO Box 313  
 Amsterdam 1000 AH  
 The Netherlands  
**Contact:** Mr Rainer Marx, Logistics & Purchasing Manager  
**T:** + 31 20 581 5100  
**F:** + 31 20 686 8328  
**E:** marx@amfert.nl  
**W:** www.amfert.nl

**AMSTERDAM**

**B.V. Bouwgrondstoffen AGM**  
 Amerikahavenweg 12  
 Amsterdam 1045 AD  
 The Netherlands  
**Contact:** Mr Lennard Marthas, Terminal Manager  
**T:** + 31 20 614 7821  
**F:** + 31 20 614 5984  
**E:** l.martha@paes-nl.com

**AMSTERDAM**

**Civil and Marine Nederland**  
 Amerikahavenweg 11  
 Amsterdam 1045 AA  
 The Netherlands  
**Contact:** Mr Lennard Marthas, Operations Director  
**T:** + 31 20 614 7928  
**F:** + 31 20 614 7918  
**E:** hanson-do@wxs.nl

**AMSTERDAM**

**Graham - Grondstoffen Exp. Amsterdam (Arc Marine)**  
 Amerikahavenweg 14  
 Amsterdam  
 1045 AD  
 The Netherlands  
**Contact:** Mr Kees Van Der Steen, Commercial Manager  
**T:** + 31 20 614 6949  
**F:** + 31 20 613 4959

**AMSTERDAM**

**IGMA**  
 Coenhavenweg 3  
 Amsterdam  
 1013 BK  
 The Netherlands  
**Contact:** Mr Maarten Boot, Commercial Manager  
**T:** + 31 20 5808 600  
**F:** + 31 20 5808 606  
**E:** info@igma.nl  
**W:** www.igma.nl  
**Location:** Port of Amsterdam  
**Equipment & Capacity:** 4 cranes/ 2 siwertells / 2 sennebogen  
**Bulk Berths:** 5 berths for capes/panamax  
**Total Uncovered Storage:** Not available



# NEXT GENERATION

CRANE BARGE 6324



in stock

DAMEN TRANSSHIPMENT BARGES ARE DESIGNED FOR DRY BULK, CONTAINERS OR BREAKBULK. A COST-EFFECTIVE, FLEXIBLE SOLUTION DELIVERED FAST. BARGES YOU CAN RELY ON.



**Total Covered Storage:** 48000mt silo capacity for grains/soybeans, 70000 mt covered warehouse for derivatives  
Storage for derivatives/grains/seeds through barges

**AMSTERDAM**

**Maja Stuwadoors Rotterdam**

PO Box 57196  
Amsterdam  
1040 BB  
The Netherlands  
**Contact:** Mr Arie Holleman,  
T: + 31 20 684 2194  
F: + 31 20 684 7024  
E: info@majastuwadoors.nl  
W: www.majastuwadoors.nl  
**Location:** Port of Amsterdam, Rotterdam, Netherlands  
**Equipment & Capacity:** Floating operation with floating cranes in the ports of Amsterdam and Rotterdam. Operating with 8 floating cranes with capacities upto 1.000 mtp. Approx. 4 million tons a year throughput.  
**Bulk Berths:** Capesize vessels discharging on the buoys

**AMSTERDAM**

**OBA - Bulk Terminal**

**Amsterdam**  
Westhavenweg 70  
Amsterdam  
1042 AL  
The Netherlands  
**Contact:** Mr Hans Mattheijer,  
Commercial Director  
T: + 31 20 587 3750  
F: + 31 20 611 6908  
E: hans.mattheijer@oba-bulk.nl  
W: www.oba-bulk.nl  
**Location:** Amsterdam North Sea  
**Equipment & Capacity:** 4 gantry cranes: 60t, 50t, 2x 30t.; 1 floating crane: 50t; 1 floating weighing tower;  
2 Stackers; 2 Reclaimers; Conveyor belt systems with powerful magnetic separators; 1 ship loader (coaster); 2 barge loaders; 1 Train loader.  
**Bulk Berths:** 1,200m quay  
**Total Uncovered Storage:** 600,000sqm  
**Total Covered Storage:** 25,000sqm  
Annual volume 20 million tonnes.  
Products handled: Coal, Agribulk, Minerals, Biomass.  
Additional services: Mixing, crushing, screening.  
All transport modalities: Ships from Capes to Coasters, barges, rail, road.

**AMSTERDAM**

**Port of Amsterdam**

Harbour Building  
De Ruijterkade 7  
PO Box 19406  
Amsterdam  
N-Holland  
1000 GK  
The Netherlands  
**Contact:** Mr Lex de Ridder,  
Commercial Manager Unit Bulk  
T: + 31 20 523 4577  
F: + 31 20 523 5077  
E: lex.de.ridder@portofamsterdam.nl  
W: www.portofamsterdam.com  
**Location:** The Netherlands  
Amsterdam is one of Europe's leading dry bulk ports. Dedicated bulk terminals in all fields of drybulk logistics offer their flexible, personal services; for further information see above contact details.

**AMSTERDAM**

**Rietlanden Terminals BV**

PO Box 59191  
Amsterdam  
1040KD  
The Netherlands  
**Contact:** Mr Karl Schot, Managing Director

T: + 31 20 506 1144  
F: + 31 20 613 0724  
E: karl.schot@rietlanden.com  
W: www.rietlanden.com  
**Location:** Amsterdam  
**Equipment & Capacity:** 5 floating cranes  
**Total Uncovered Storage:** 60 hectares

**BOTLEK**

**Borax Rotterdam N.V.**  
Welplaatweg 104  
Botlek  
Rotterdam  
3197 ZG  
The Netherlands  
**Contact:** Mr Paul Fink, General Manager  
T: + 31 10 490 9600  
F: + 31 10 416 0023  
E: boraxrotterdam@borax.com  
W: www.borax.com/

**BOTLEK**

**Jewetmetal Stainless Processing**  
Quebecstraat 7  
Botlek  
Rotterdam  
3197 KL  
The Netherlands  
**Contact:** Mr Henk Aulich, Managing Director  
T: + 31 181 242 424  
F: + 31 181 242 425  
E: hauledich@jewetmetaal.com  
W: www.jewo.com

**DELFIJL**

**Aldel - Aluminium Delfzijl**  
PO Box 133  
Delfzijl  
NL 9930 AC  
The Netherlands  
**Contact:** Mr S Fokkens,  
T: + 31 0596 638357  
F: + 31 0596 638402  
E: info@aldel.nl  
W: www.aldel.nl  
**Location:** North East of The Netherlands  
**Equipment & Capacity:** Smelter 110KT

**DELFIJL**

**Groningen Seaports**  
Business Unit Logistics  
PO Box 20004  
Delfzijl  
9930 PA  
The Netherlands  
**Contact:** Mr Jannes Stokroos,  
Public Relations  
T: + 31 596 640 400  
F: + 31 596 630 464  
E: info@groningen-seaports.com  
W: www.groning-seaports.com

**DORDRECHT**

**BV Zeehavenbedrijf Dordrecht (ZHD Stevedoring)**  
PO Box 12  
Dordrecht  
3300 AA  
The Netherlands  
**Contact:** Mr Dico Regoord,  
Commercial Director  
T: + 31 78 61 11 009  
F: + 31 78 63 32 815  
E: leo.lokker@zhd.nl  
W: www.zhd.nl  
**Location:** Rotterdam, Dordrecht and Moerdijk  
**Equipment & Capacity:** 15 cranes - 8 up to 50 tons lifting capacity (incl. 3 self-propelled floating cranes)  
**Bulk Berths:** Dordrecht 1.750m draught 31'  
Moerdijk 950m draught 28'  
(Lightening in Rotterdam possible with floating cranes)

LOA: 201 m.  
Beam: 32.5 m.  
**Total Uncovered Storage:** 150,000 sqm  
**Total Covered Storage:** 80,000 sqm  
ZHD is an independent stevedoring company operating in Dordrecht, Moerdijk and Rotterdam. ZHD has large expansion plans, which includes development of 18 hectares "green field" (31'draught) and construction of new warehouses.

**DORDRECHT**

**Port Authority of Dordrecht**  
Menwekade 56  
Dordrecht  
3311 TH  
The Netherlands  
**Contact:** Mr Niek Ooijevaar,  
Harbour Master  
T: + 31 78 639 7875  
F: + 31 78 639 7879  
E: nooijevaar@dordrecht.nl

**FARMSUM**

**Akzonobel**  
Oosterhorn 4  
Farmsum  
Delfzijl  
9936 HD  
The Netherlands  
**Contact:** Mr Arend Niemeijer,  
Shipping Manager  
T: + 31 596 64 7000  
E: arend.niemeijer@akzonobel.com  
W: www.akzonobel.salt

**GORINCHEM**

**Damen Shipyards Gorinchem**  
  
P.O. Box 1  
Gorinchem  
4200 AA  
The Netherlands  
**Contact:** Mr Ben Littler,  
Communications Advisor  
T: + 31 183 65 5546  
E: ben.littler@damen.com  
W: www.damen.com  
Damen Shipyards Group operates 33 shipbuilding and repair yards, employing 9,000 people worldwide. Damen has delivered more than 6,000 vessels in more than 100 countries and delivers some 180 vessels annually. Based on its unique, standardised ship-design concept Damen is able to guarantee consistent quality and fast delivery.

**IJMUIDEN**

**Tata Steel Logistics & Shipping BV**  
PO Box 512  
Ijmuiden  
1970 AM  
The Netherlands  
**Contact:** Mr Marcel Botterhuis,  
Operations Manager  
T: + 31 251 495521  
F: + 31 251 470279  
E: marcel.botterhuis@tatasteel.com  
W: www.tatasteel-ls.com

**KOUDEKERK AAN DEN RIJN**

**ENBO BV**  
3 Hondsdijk  
Koudekerk aan den Rijn  
HG  
2396  
The Netherlands  
**Contact:** Mr Jan Lahuis, Advertising Manager  
T: + 31 713 413 600  
F: + 31 713 416 007  
E: info@enbo.nl

**MIERLO**

**International Bulk Handling Technology BV**  
PO Box 47  
Mierlo  
5730 AA  
The Netherlands  
**Contact:** Mr Johan M.A.M. Brands,  
Technical Manager  
T: + 31 492 664 885  
F: + 31 492 664 695  
E: info@ibbulk.nl  
W: www.ibbulk.nl  
Offers over 42 years of expertise in design, manufacturing and maintenance of bulkhandling systems. Recently completed projects include ship loading facilities, reclaimers, hoppers, bins, automated train and ship loading/unloading facilities, Beltwall and pipe conveyors. Located in Indonesia, China, Argentina, Germany, USA and The Netherlands.

**MOERDIJK**

**Combined Cargo Terminals B.V.**  
Graanweg 19  
Moerdijk  
Noord-Brabant  
4782 PP  
The Netherlands  
**Contact:** Mr Luc Smits, Managing Director  
T: + 31 168 334270  
F: + 31 168 381193  
E: info@cctoerdiijk.com  
W: www.cctoerdiijk.com  
**Location:** Moerdijk  
**Equipment & Capacity:** Crane cap till 150m  
**Bulk Berths:** Quay length 1,600m, draught 8.90m  
**Total Uncovered Storage:** 250,000sqm  
**Total Covered Storage:** 22,000sqm

**MOERDIJK**

**Euro-Rijn International B.V..**  
Plaza 6  
PO Box 77  
Moerdijk  
Noord-Brabant  
4780 AB  
The Netherlands  
**Contact:** Mr Albert Marcha van Ommen, Managing Director  
T: + 31 168 393201  
F: + 31 168 393202  
E: a.vanommerijn@eurorijn.com  
W: www.eurorijn.com  
**Location:** Rotterdam area (Moerdijk)  
**Equipment & Capacity:** 3 cranes - 6000 tons per month  
3 payloaders - 10 vt trucks  
2 weigh bridges  
**Bulk Berths:** Draught 8.90m, quay 700 metres  
**Total Uncovered Storage:** 30,000sqm  
**Total Covered Storage:** 60,000sqm  
We also offer processing and packing services.

**ROTTERDAM**

**C. Steinweg-Handelsvem BV**  
Parmentierplein 1  
Rotterdam  
Zuid-Holland  
3088 GN  
The Netherlands  
**Contact:** Mr Rob van Kerkhof,  
Manager, Ferro Alloys  
T: + 31 10 487 9225  
F: + 31 10 487 93 10  
E: r.vankerkhof@nl.steinweg.com  
W: www.steinweg.com  
**Location:** Waalhaven, The Netherlands. Rotterdam, Port NO. 2186  
**Equipment & Capacity:** Cranes,

crushing/screening possibilities  
**Bulk Berths:** Quayside of 300m. Draught approx. 10m.  
**Total Uncovered Storage:** 40,000 sqm  
**Total Covered Storage:** 60,000 sqm  
Stevedoring/storage/crushing/screening. Packing of bulk ferro alloy.

**ROTTERDAM**

**Ertsoverslagbedrijf Europoort C.V. (EECV)**  
Markweg 131, port number 6250  
Europoort  
Rotterdam  
Zuid-Holland  
3198 NB  
The Netherlands  
**Contact:** Mr Burkhard Decker,  
Management Board  
T: + 31 181 25 77 02  
F: + 31 181 25 77 03  
E: info.eecv@thysenkrupp.com  
W: www.eecv.nl  
**Location:** Port of Rotterdam  
Europoort  
**Equipment & Capacity:** 3 grab unloaders each 2300 tph, 1 continuous shipunloader 3000 tph, 6 stacker reclaimers 4600 tph each, 3 barge loaders 4600 tph each, 1 train loading station 2000 tph.  
**Bulk Berths:** 3 berths, 18.5-23.7m draught  
Vessel size up to 365,000dwt.  
**Total Uncovered Storage:** 40 ha

**ROTTERDAM**

**European Bulk Services (EBS) BV**  
Elbeweg 117, Port number 5820  
3198 LC Europoort-Rotterdam  
Rotterdam  
Zuid Holland  
3180 AE  
The Netherlands  
**Contact:** Mr Jan de Wit, Managing Director  
T: + 31 181 258 147  
F: + 31 181 258 154  
E: sales@ebsbulk.nl  
W: www.ebsbulk.nl  
**Location:** Rotterdam, The Netherlands  
**Equipment & Capacity:** Floating grab cranes; gantry cranes 36t  
**Bulk Berths:** Panamax, cape , coaster berth  
**Total Uncovered Storage:** 35 ha  
**Total Covered Storage:** 500,000m3  
1 agri-bulk/grain handling terminal  
1 multi purpose bulk terminal (coal, minerals, Agri, Biomass)  
Floating cranes  
Various storage modes for different products

**ROTTERDAM**

**Europees-Massagoed Overslagbedrijf (EMO) BV**  
PO Box 9000  
Maasvlakte RT  
Rotterdam  
3199 XA  
The Netherlands  
**Contact:** Mr Sjaak Roukema,  
Commercial Manager  
T: + 31 181 371113  
F: + 31 181 371222  
E: j.c.roukema@emo.nl  
W: www.emo.nl  
**Location:** Maasvlakte - Rotterdam  
**Equipment & Capacity:** 1 x 36 tonne lift capacity floating crane  
3 x 85 tonne lift capacity grab unloaders  
2 x 55 tonne lift capacity grab unloaders  
**Bulk Berths:** Draught 23m. Storage capacity 7 million mt  
**Total Covered Storage:** EMO offers a discharge capacity of around 42 mta. Daily unloading rates of up to 175,000 tonnes

4 bulk carriers can be accommodated simultaneously.

**ROTTERDAM**

**Marcor Stevedoring BV Rotterdam**  
Dodewaardstraat 14  
(Port Number 2175)  
Rotterdam  
3087 BA  
The Netherlands  
**Contact:** Mr Aad Groenenboom,  
Director  
T: + 31 10 299 21 21  
F: + 31 10 299 21 22  
E: a.groenenboom@marcor.nl  
W: www.marcor.nl  
**Location:** Throughout the Port of Rotterdam  
**Equipment & Capacity:** 4 floating cranes; up to 1,400 tph per crane  
2 floating weighing towers for agri bulk only  
**Bulk Berths:** No restrictions for Panamax vessels; even Cape size vessel are possible.  
**Total Uncovered Storage:** Floating storage vessel and numerous barges.  
**Total Covered Storage:** Floating storage vessel and numerous barges.  
Fast, flexible and reliable high quality standards.

**ROTTERDAM**

**Port of Rotterdam**  
Wilhelmakade 909  
Rotterdam  
3072 AP  
The Netherlands  
**Contact:** Mrs Kesih de Jong- Van den Berg, Manager dry and liquid bulk shipping  
T: + 31 10 252 1203  
F: + 31 6 2049 8548  
E: k.jong-berg@portofrotterdam.com  
W: www.portofrotterdam.com  
**Location:** Rotterdam, The Netherlands  
**Equipment & Capacity:** Total port area 10,500 ha  
Area of industrial sites 5,100 ha  
Bulk cranes 58  
Dry Bulk terminals 15  
**Bulk Berths:** Area of water 3,440 ha  
Infrastructure 1,960 ha  
Port length 40 km  
Quay length 74 km  
Slope length 187 km  
**Total Covered Storage:** 4.7 million (m2) total Rotterdam + other great Rotterdam  
The aim of the Port of Rotterdam Authority is to enhance the port of Rotterdam's competitive position as a logistics hub and world-class industrial complex. Not only in terms of size, but also quality. The core tasks of the Port Authority are to develop, manage and run the port in a sustainable way and to maintain a speedy and safe service for shipping.

**ROTTERDAM**

**RHB Stevedoring & Warehousing**  
Waalhaven NZ 4  
Port Number 2 1 5 7  
Rotterdam  
ZH  
3087 BL  
The Netherlands  
**Contact:** Mr Pieter van der Pluijm,  
Managing Director  
T: + 31 10 429 9433  
F: + 31 10 429 0261  
E: office@rhb.nl  
W: www.rhb.nl  
**Location:** Rotterdam - The Netherlands  
**Equipment & Capacity:** Shorecranes up to 208 mt/tons.

Floating cranes up to 1800 m/tons  
**Bulk Berths:** ISPS certified quay of 730m length with 8 shorecranes & 4 floating cranes, max draught 10m. AEO-F certified.  
**Total Uncovered Storage:** 30,000sqm  
**Total Covered Storage:** 15,000sqm  
 Handling project cargoes, industrial breakbulk, heavy lifts, metals, steel and general cargoes incl. oversized. Warehouse doors 10m width.

## ROTTERDAM

**Van Uden Bulk Logistics**  
 Gustoweg 68  
 Rotterdam  
 3029 AS  
 The Netherlands  
**Contact:** Mr Robert van Muiden, General Manager  
 T: + 31 10 221 40 20  
 F: + 31 10 476 19 27  
 E: r.vanmuiden@vubl.nl  
**W:** www.van-uden.nl  
**Location:** Port of Rotterdam  
**Equipment & Capacity:** 7 cranes, private owned terminal warehouses, weighing bridge etc.  
**Bulk Berths:** Merwehaven Bulk Terminal nr. 385  
**Total Uncovered Storage:** 50,000 sqm  
**Total Covered Storage:** 12,500 sqm  
 Specialized in door-to-door logistic services for drybulk minerals as well as packed in bigbags and/or pallets. GMP certified.

## ROTTERDAM

**Van Uden NedCargo**  
 Van Maasdijkweg 27  
 Rotterdam  
 3088 EC  
 The Netherlands  
**Contact:** Mr Diederik Antvelink,  
 T: + 31 10 7990200  
 F: + 31 10 7990299  
 E: d.antvelink@nedcargo.com  
**W:** www.NedCargo.com

## ROTTERDAM

**Van Uden Stevedoring**  
 Gustoweg 68  
 (Port number 385)  
 Rotterdam  
 3029 AS  
 The Netherlands  
**Contact:** Mr Gerard de Jong,  
 T: + 31 10 476 0171  
 F: + 31 10 476 1927  
 E: g.dejong@vanudenstevedoring.nl  
**W:** www.vanuden.nl  
**Location:** Rotterdam  
**Equipment & Capacity:** 6 cranes each a capacity of 500 tons an hour  
**Bulk Berths:** 650 mtr quay length, draft 10.2m (high tide), draft 9.65m (low tide)  
**Total Uncovered Storage:** 25,000 sqm  
**Total Covered Storage:** 20,000 sqm  
 10 bunkers with capacity of 500 tons each.

## ROZENBURG

**EP Shipping & Trading BV**  
 PO Box 1050  
 Rozenburg  
 3180 AB  
 The Netherlands  
**Contact:** Mr Eddy Van de Wijngaart (snr),  
 T: + 31 181 402 788  
 F: + 31 181 402 689  
 E: eps@epship.nl  
**W:** www.epship.nl

## SAS VAN GHENT

**Zuid-Chemie**  
 Westkade 38a  
 PO Box 70

Sas van Ghent  
 4550 AB  
 The Netherlands  
**Contact:** Mr Wim Wille, Marketing Department  
 T: +31 115 456 000  
 F: +31 115 451 647  
 E: info.nl@rosier.eu  
**W:** www.zuidchemie.nl

## SCHIEDAM

**Nieuwe Waterweg Silo BV**  
 Nieuwe Waterwegstraat 55  
 (Port 542)  
 Schiedam  
 3115 HE  
 The Netherlands  
**Contact:** Mr Jan Maasdam, Managing Director  
 T: + 31 10 427 12 30  
 F: + 31 10 473 75 73  
 E: info@nwsilo.nl  
**W:** www.nwsilo.nl  
**Location:** Schiedam, Netherlands.  
 Port of Rotterdam on the Main waterway  
**Equipment & Capacity:** 2 floating cranes. 500 tph  
**Bulk Berths:** Portnr 542 120m length - 8m depth  
 Portnr 543 120m length - 8m depth  
**Total Uncovered Storage:** 2,500sqm  
**Total Covered Storage:** Silo of 9 bins. 4200 m<sup>3</sup> capacity total (for cereals)

## SCHIEDAM

**Van Mannekus & Co**  
 Nieuwe Waterwegstraat 540  
 Schiedam  
 The Netherlands  
**Contact:** Mr Henk Don, Manager  
 T: + 31 10 409 15 00  
 F: + 31 10 473 08 80  
 E: h.don@mannekus.com

## STIENS

**EMG-Silo Groningen**  
 PO Box 22  
 Stiens  
 9050 AA  
 The Netherlands  
**Contact:** Mr Sjoerd De Vries,  
 T: + 31 566 625710  
 F: + 31 566 625711  
 E: sj.devaries@iell.devaries.nl  
**W:** www.feedlogistics.nl

## TERNEUZEN

**Ovet BV - Terneuzen Terminal**  
 Mr F.J. Haarmanweg 16 d  
 Terneuzen  
 Zeeland  
 NL-4538 AR  
 The Netherlands  
**Contact:** Mr Bram Peters, Commercial Manager  
 T: + 31 115 676 700  
 F: + 31 115 620 316  
 E: info@ovet.nl  
**W:** www.ovet.nl  
**Location:** Within the ARA-zone. In the South West of The Netherlands: Kalootherbour, Vlissingen + Massagedoerharbour, Terneuzen.  
**Equipment & Capacity:** 4 floating cranes / 80,000 tonnes per day / 1,000tph free digging capacity.  
**Bulk Berths:** - Vlissingen Terminal:  
 Capesize up to 180,000 tonnes / Max draught 16.5m salt water/ 1,000m quay  
 - Terneuzen Terminal:  
 Panamax up to 80,000 tonnes / Max draught 12.5m fresh water/ 1,400m quay  
 - 2 anchorage places on the river Scheldt for lightening activities  
**Total Uncovered Storage:** - Vlissingen Terminal: 2,000,000 tonnes open storage/ 315,000sqm paved terrain.

- Terneuzen Terminal:  
 600,000 tonnes open storage  
 160,000sqm paved terrain  
**Total Covered Storage:** 1 warehouse with 6 compartments of 1,000sqm each. So total 45,000 m<sup>3</sup>. GMP+ certified.  
 At both terminals:  
 Screening  
 Crushing  
 Blending  
 Magnet installations  
 Bagging equipment  
 Trainloading  
 Forwarding activities

## TERNEUZEN

**Verbrugge Terneuzen Terminals**  
 Zwedenweg 1  
 Harbour 1361  
 PO Box 5  
 Terneuzen  
 4530 AA  
 The Netherlands  
**Contact:** Mr Mario H. L. van Rijt, Director Bulk & Marine  
 T: + 31 115 646 491  
 F: + 31 115 646 490  
 E: mario.rijt@verbrugge.nl  
**W:** www.verbrugge.nl  
**Location:** South West of the Netherlands, at the North Sea, right at the Scheldt estuary  
**Bulk Berths:** Draught: 12.25m / Quay length: 1.800m / Harbour width: 250m

## TERNEUZEN

**Zeeland Seaports Port Authority**  
 PO Box 132  
 Schelpenpad 2  
 Terneuzen  
 4530 AC  
 The Netherlands  
**Contact:** Mr Francesco Faes, Commercial Manager  
 T: + 31 6 53 40 14 26 / + 31 115 647 400  
 F: + 31 115 647 500  
 E: francesco.faes@zeeland-seaports.com  
**W:** www.zeelandseaports.com  
**Location:** At the entrance of the Western Scheldt River  
 Zeeland Seaports represent the ports of Terneuzen and Vlissingen. Both ports have an open connection to the North Sea. Vessels with a draught of 16.5m can be accommodated.

## VLAARDINGEN

**Port of Vlaardingen**  
 PO Box 1002  
 Vlaardingen  
 3130 EB  
 The Netherlands  
**Contact:** Mrs Petra de Wit, Harbour Master  
 T: + 31 10 248 4561  
 F: + 31 10 434 43 73  
 E: p.de.wit@vlaardingen.nl  
**W:** www.havenkantoor.vlaardingen.nl  
**Location:** South West of Holland on the North Sea  
 ...being a neighbour of Rotterdam means sharing in the advantages of a world port. At the same time we can offer you a more personal approach!

## VLAARDINGEN

**Rotterdam Bulk Terminal (R.B.T.) B.V.**  
 Schiedamsedijk 16  
 (Harbour no. 610)  
 Vlaardingen  
 South Holland  
 3134 KK  
 The Netherlands  
**Contact:** Mrs Carola Broers-Keuning, Director  
 T: + 31 10 234 35 55

F: + 31 10 234 21 85  
 E: info@rbtrotterdam.com  
**W:** www.rbtrotterdam.com  
**Location:** Rotterdam Port Area  
**Equipment & Capacity:** 2 Gantry Cranes 350 - 600 tph per crane  
**Bulk Berths:** 525m quay length and 12m draught  
**Total Uncovered Storage:** 50,000 sqm  
**Total Covered Storage:** 20,000 sqm  
 Throughput capacity of 3,000,000 tpa

## VLISSINGEN

**Ovet BV - Vlissingen Terminal**  
 Monacoweg 3  
 Nieuworp  
 Zeeland  
 NL-4455 SZ  
 The Netherlands  
**Contact:** Mr Bram Peters, Commercial Manager  
 T: + 31 115 676 700  
 F: + 31 115 620 316  
 E: info@ovet.nl  
**W:** www.ovet.nl  
**Location:** Within the ARA-zone - South West of The Netherlands: Kalootherbour, Vlissingen + Massagedoerharbour, Terneuzen.  
**Equipment & Capacity:** 4 floating cranes / 80,000 tonnes per day / 1,000tph free digging capacity.  
**Bulk Berths:** - Vlissingen Terminal:  
 Capesize up to 180,000 tonnes / Max draught 16.5m salt water/ 1,000m quay  
 - Terneuzen Terminal:  
 Panamax up to 80,000 tonnes / Max draught 12.5m fresh water/ 1,400m quay  
 - 2 anchorage places on the river Scheldt for lightening activities  
**Total Uncovered Storage:** - Vlissingen Terminal: 2,000,000 tonnes open storage/ 315,000sqm paved terrain.  
 - Terneuzen Terminal: 600,000 tonnes open storage  
 160,000sqm paved terrain  
**Total Covered Storage:** 1 warehouse with 6 compartments of 1,000sqm each. So total 45,000 m<sup>3</sup>. GMP+ certified.  
 At both terminals:  
 Screening  
 Crushing  
 Blending  
 Magnet installations  
 Bagging equipment  
 Trainloading  
 Forwarding activities

## ZWIJNDRECHT

**Agro Delta Group**  
 Zwijndrecht  
 Lindtsedijk 62  
 PO Box 120  
 Zwijndrecht  
 ZH  
 3330 AC  
 The Netherlands  
**Contact:** Mr John van Belle, Managing Director/Owner  
 T: + 31 78 6100900  
 F: + 31 78 6100301  
 E: jvbelle@agro-delta.nl  
**W:** www.agro-delta.nl  
**Location:** The Netherlands, riverside near Rotterdam. Port of Dordrecht and Zwijndrecht.  
**Equipment & Capacity:** 2 bulkcranes, shovels, fork-lift trucks, 3 weighbridges, screening facilities for fertiliser, cleaning facilities for grains, seeds and pulses  
**Bulk Berths:** 4 berths, 3 with 4 mtr draught, 1 with 8,75 mtr draught  
**Total Covered Storage:** 54,000 sqm, 60,000 m.t. silo space  
 Storage and handling of grains, seeds, pulses, rice, fertiliser,

feedstuffs, breakbulk and rental of warehouses.

## TOGA

### LOME

**Office Togolaise des Phosphates**  
 PO Box 379  
 Lome  
 Toga  
**Contact:** Mr K Atefeibu, Harbour Master  
 T: + 228 213901  
 F: + 228 217105

## TRINIDAD &

### TOBAGO

### COUVRA TRINIDAD

**Point Lisas Industrial Port Development Corp Ltd**  
 PO Bag 191  
 Apdo Postal  
 Couvra Trinidad  
 Trinidad & Tobago  
**Contact:** Ms Cindy Asevero,  
 T: + 1 868 636 2201  
 F: + 1 868 679 7659  
 E: casevero@plipdeco.com  
**W:** www.trinidad.net/plipdeco

### PORT OF SPAIN

**Chaguaramas Terminals Ltd**  
 Chag Terminals Drive  
 PO Box 608  
 Port of Spain  
 Trinidad & Tobago  
**Contact:** General Manager  
 T: + 1 86 634 4384  
 F: + 1 86 634 4542

### PORT OF SPAIN

**Cronstad Island**  
 Baroid Trinidad Services Ltd  
 PO Box 765  
 Port of Spain  
 Trinidad & Tobago  
**Contact:** Mr C Fuller, General Manager  
 T: + 1 86 680 2428  
 F: + 1 86 627 5193

### PORT OF SPAIN

**Port Authority of Trinidad and Tobago**  
 1 Dock Road  
 Port of Spain  
 Trinidad & Tobago  
**Contact:** Mr Kelvin Harris, Divisional Manager Operations  
 T: + 1 868 625-2644  
 F: + 1 86 627 266  
 E: kelvinh@patnt.com  
**W:** www.patnt.com

### PORT OF SPAIN

**Port of Spain**  
 Port Authority of Trinidad and Tobago  
 Dock Road  
 Port of Spain  
 Trinidad & Tobago  
**Contact:** Ms Kathleen Maxwell, Manager  
 T: + 868 623 2901 5

## TUNISIA

### BIZERTE

**Office des Ports Nationaux Tunisiens**  
 Quai Tarek Ibn Ziad  
 Bizerte  
 7000  
 Tunisia  
**Contact:** Mr Mohamed Adel Mokhtar, Director

T: + 216 2 431139  
 F: + 216 2 433688  
 E: ommp@ommp.nat.tn  
**W:** www.ommp.nat.tn

### BIZERTE

**Port Authority of Bizerte**  
 Quai Tarek Ibn Zied  
 Bizerte  
 7000  
 Tunisia  
**Contact:** Mr Ben Sadhel, Port Director  
 T: + 216 71 735 300  
 F: + 216 71 735 812  
 E: ommp@ommp.nat.tn  
**W:** www.ommp.nat.tn

### PORT DE LA GOULETTE

**Port Authority of Tunis Goulette**  
 Batiment Administratif  
 Port de la Goulette  
 Tunisia  
**Contact:** Port Director  
 T: + 216 1 735 300  
 F: + 216 1 736 812  
 E: ommp@ommp.nat.tn  
**W:** www.ommp.nat.tn

### Sfax

**Port Authority of Sfax**  
 Office des Ports Nationaux Tunisiens  
 Rue Okba Ibn Nafaa  
 Sfax  
 3029  
 Tunisia  
**Contact:** Captain Lamere Chokri, Port Captain  
 T: + 216 4 225040  
 F: + 216 4 225107  
 E: ommp@ommp.nat.tn  
**W:** www.ommp.nat.tn

## TURKEY

### BURSA

**Gemlik Port**  
 Kocacukur Mevkii  
 101 Gemlik  
 Bursa  
 Turkey  
**Contact:** Mr Ali Kerim leil demirhan, Assistant General Manager  
 T: + 90 224 524 88 31  
 F: + 90 224 524 88 30  
 E: gemport@gemport.com.tr  
**W:** www.gemport.com.tr/

### EREGLI

**Eregli Port Authority**  
 Nevzat Direk  
 Karadeniz Eregli  
 Liman Baskanligi  
 Eregli  
 67330  
 Turkey  
**Contact:** Mr Turget Ege, Harbour Master  
 T: + 90 372 323 1007  
 F: + 90 372 323 1169  
 E: kdzeregl@denizcilik.gov.tr  
**W:** www.denizcilik.gov.tr

### HEREKE-IZMIT

**NUH Cement Factory of Hereke**  
 Akyar Mevkii  
 PO Box 7  
 Hereke-Izmit  
 1000  
 Turkey  
**Contact:** Mr Seyid Uluabay, General Manager  
 T: + 90 262 511 3975  
 F: + 90 262 511 412

### ISTANBUL

**Toros Tarim Sanayi ve Ticaret AS-TOROS Ceyhan Term**



**Buyukdere Caddesi**  
Tekfen Tower, 19th Floor  
4 Levent  
Sisli  
Istanbul  
Marmara  
34394  
Turkey

**Contact:** Mr Aydin Erdemir, Vice President - Terminal & Port Activities  
T: + 90 212 357 02 02 ext. 284/286  
F: + 90 212 357 02 31  
E: aydin.erdemir@toros.com.tr  
W: www.toros.com.tr

**Location:** South of Turkey, on the South East Coast of Mediterranean Sea.

Seaports Coordinates - West Jetty  
36 55 00 N - 35 58 54 E  
36 54 24 N - 35 59 06 E  
Seaport Coordinates - East Jetty  
36 55 12 N - 35 59 18 E  
36 54 30 N - 35 59 34 E

**Equipment & Capacity:** For Dry Bulk and General Cargo; up to 14,400,000 tons loading/unloading capacity per year.

For Liquids (including petroleum and chemical products); up to 13,500,000 tons loading/unloading capacity per year.

**Bulk Berths:** For dry bulk up to 110,000 DWT.

For oil and chemical liquid up to 40,000 DWT.

**Total Uncovered Storage:** 1,000,000 sqm

**Total Covered Storage:** Warehouse capacity is 160,000 ton. Storage Tanks capacity is 236,500 m<sup>3</sup>.

Ceyhan Terminal is located in the heart of the Ceyhan Energy Zone in the East Med in proximity to the BTC (Baku Tiblisi Ceyhan crude oil pipe line) and Keruk-Ceyhan (Botas Iraq) crude oil pipe lines.

**IZMIR**

**Izmir Port**  
General Directorate of Turkish State Railways  
Port of Izmir  
Atatürk Str. No. 97  
Alsancak/Konak  
Izmir  
35220  
Turkey

**Contact:** Mr Ismet Canbaz, Port Director  
T: + 90 232 463 2252  
F: + 90 232 463 2248  
E: izmiriman@tcdd.gov.tr  
W: www.tcdd.gov.tr

**Location:** 38° 25' 00"N 27° 04' 30"E. West of Turkey on the west coast.

**Equipment & Capacity:** Includes: 5x 50t Gantry cranes, 5x MHC, 7x Mobile cranes, 14x 35t RTG, stackers, loaders, forklifts

**Bulk Berths:** 3 berths, a total of 350m, draught 7m

**Total Uncovered Storage:** 219,345sqm

**Total Covered Storage:** 24,678sqm  
Izmir Port is the biggest state port in Turkey in terms of surface area.

**MERSIN**

**Famagusta Port Authority**  
Works and Tourism Ministry Ports Department  
Mersin  
North Cyprus  
10  
Turkey

**Contact:** Mr Enver Yetili, Director of Ports  
T: + 90 392 36 62627  
F: + 90 392 36 66465  
E: fpa@cc.emu.edu.tr

**SISLI**

**Toros Tarım Sanayi ve Ticaret**

**A.Ş**

Tekfen Tower, 4 Levent  
Sisli  
Instabul  
34394  
Turkey

**Contact:** Mr Ismail Turan, Toros Terminal Opr. Man  
T: + 90 2123570202  
F: + 90 2123570231  
E: ismail.turan@toros.com.tr  
W: www.toros.com.tr

**TEKIRDAG**

**Port of Tekirdag**  
Türkiye Denizcilik İşletmeleri Liman İşletmesi Mudurluğu  
Tekirdag  
59100  
Turkey

**Contact:** Mr Rasim Sinel, Port Director  
T: + 90 282 261 0800  
F: + 90 282 261 2346  
E: tekindaglimani@tdfi.gov.tr  
W: www.portoftekindag.net

**TRABZON**

**Trabzon Port**  
Ports Management  
Trabzon Liman İşletmesi Mudurluğu  
Trabzon  
Turkey

**Contact:** Mr Taner Kaskin, Harbour Master  
T: + 90 462 321 1073  
F: + 90 462 322 1004  
E: info@cerahogullari.com.tr

**UAE**

**ABU DHABI**

**Abu Dhabi Ports Company, ADPC**  
PO Box 54477  
Abu Dhabi  
UAE  
**Contact:** Ms Madyan Ayouch, Corporate Communication & Marketing  
T: + 971 2 695 2953  
F: + 971 2 695 2969  
E: madyan.ayouch@adpc.ae  
W: www.adpc.ae

**ABU DHABI**

**Abu Dhabi Seaport Authority**  
PO Box 422  
Mina Zayed  
Abu Dhabi  
UAE

**Contact:** Mr Mubarak Al Buainain, Port Director  
T: + 971 2 730 600  
F: + 971 2 731023  
E: mrkdebt@emirates.net.ae  
W: www.portzayed.ae

**ABU DHABI**

**E-ships Oldendorff Logistics**  
Villa 15/2  
4th Street  
Zone 1 Sector 15  
Abu Dhabi  
112575  
UAE

**Contact:** T: + 971 2 642 03 67  
F: + 971 2 642 03 57  
W: www.eol.ae/

**ABU DHABI**

**Port Zayed**  
Abu Dhabi  
UAE  
**Contact:** Mr Mohammed Wagdy, Corporate Communications & Branding Officer  
T: + 971 2 6975270  
F: + 971 2 6975166  
E: mohammed.wajdi@adterminals.ae  
W: www.portzayed.gov.ae

**AJMAN**

**Emirates Ports Services**  
PO Box 388  
Ajman  
UAE  
T: + 971 06 7470311  
F: + 971 06 7470333  
E: mail@ajmanport.gov.ae  
W: www.ajmanport.gov.ae/

**DUBAI**

**Dubai Port World**  
Commercial Department  
Terminal 1 Operations Building, 1st Floor  
PORT: JA,04-8815555,04-8876470  
Dubai  
UAE  
**Contact:** Mr Abdul Rahim Al Qassim, Director  
T: + 971 4 2621241  
F: + 971 4 2663331  
E: AbdulRahim.alQassim@dpworld.com  
W: www.dpworld.ae/

**DUBAI, SOHAR Free Zone L.L.C (JLT Branch)**

Office 2902, level 29,  
Reef Tower,  
Jumeirah Lake Towers,  
Dubai,  
UAE  
**Contact:** Mr Anders Kron, Commercial Manager- Middle East  
T: +971 44487169  
F: +971 44487112  
E: anders.kron@soharportandfreezone.com  
W: www.soharportandfreezone.com/

**FUJAIRAH**

**Port of Fujairah**  
PO Box 787  
Fujairah  
UAE  
**Contact:** Captain Mousa Morad, General Manager  
T: + 971 9222 8800  
F: + 971 9222 8811  
E: Gms\_pof@fujairahport.ae  
W: www.fujairahport.ae

**UK**

**AYR**

**Associated British Ports (Ayr and Troon)**  
Associated British Ports  
Port Office  
North Harbour Street  
Ayr  
KA8 8AH  
UK  
**Contact:** Mr Colin Hume, Commercial & Administration Manager  
T: + 44 1292 281687  
F: + 44 1292 287787  
E: chume@abports.co.uk  
W: www.abports.co.uk

**Location:** West Coast of Scotland, entrance to the Firth of Clyde  
**Equipment & Capacity:** 4 hydraulic excavator cranes, several shovels, telehandlers, FLTs 1 rail wagon discharge, rail connected quays  
**Bulk Berths:** Various - Max Length 110m, Max Draught 5.8m - 6.2m  
**Total Uncovered Storage:** Extensive  
**Total Covered Storage:** 20,000sqm  
Also experienced in Heavy Lift operations.

**AYR**

**Ayr**  
ABP Port Office  
Ayr  
Ayrshire  
KA8 8AH  
UK

**Contact:** Mr P Creswell, Port Manager  
T: + 44 1292 281 687  
F: + 44 1292 287 787  
E: ayr@abports.co.uk  
W: www.abports.co.uk

**BARROW UPON HUMBER**

**New Holland Bulk Services**  
PO Box 1, Old Ferry Terminal  
New Holland  
Barrow upon Humber  
South Humber  
South Humber  
DN19 7SD  
UK  
**Contact:** Mr James Lyne, Managing Director  
T: + 44 1469 531 102  
F: + 44 1469 531 966  
E: james.lyne@newhollandbulkservices.co.uk

**BARROW-IN-FURNESS**

**Port of Barrow-in-Furness**  
Associated British Ports  
Ramsden Dock Road  
Barrow-in-Furness  
Cumbria  
LA14 2TW  
UK  
**Contact:** Mr Chris Clouter, Port Operations Manager  
T: + 44 1229 822911  
F: + 44 1229 835822  
E: barrow@abports.co.uk  
W: www.abports.co.uk  
**Location:** North West England, West Coast, Irish Sea  
**Total Uncovered Storage:** 200,000sqm  
**Total Covered Storage:** 6,000sqm  
Ideal base port for offshore wind farm installation projects and long term O & M.

**BELFAST**

**Belfast Harbour Commissioners**  
Harbour Office  
Corporation Square  
Belfast  
BT1 3AL  
UK  
**Contact:** Deputy Harbour Master  
T: + 44 2890553015  
E: michael.evans@belfast-harbour.co.uk  
W: www.belfast-harbour.co.uk/  
**Location:** N. Ireland  
**Equipment & Capacity:** Over 3 million tonnes of Dry Bulk products each year.  
Almost 500,000 tonnes of Break Bulk in 2003.  
Please see website for equipment details.

**BERWICK-UPON-TWEED**

**Berwick Harbour Commission**  
Harbour Master's Office  
Tweed Dock  
Berwick-Upon-Tweed  
Northumberland  
TD15 2AB  
UK  
**Contact:** Mr Alan Irving, CEO  
T: + 44 1289 307404  
F: + 44 1289 332 854  
E: info@bhshipping.com  
W: www.portofberwick.co.uk

**BLYTH**

**Port of Blyth**  
South Harbour  
Blyth  
Northumberland  
NE24 3PB  
UK  
**Contact:** Mr Martin Lawlor, Commercial Director

T: + 44 1670 352066  
F: + 44 1670 368540  
E: commercial@blythport.co.uk  
W: www.portofblyth.co.uk  
**Location:** East coast of the UK.  
**Equipment & Capacity:** 10-15,000 tonnes per 24 hours  
Rail loading facility and an extensive array of handling equipment including bulk tippers, rail shovels, dozers and bobcats.  
**Bulk Berths:** Vessels up to 35,000 DWT  
**Total Uncovered Storage:** Available with water spray dust suppression systems, concrete pads and bulk walling as appropriate  
**Total Covered Storage:** A complex of 10 modern dry bulk warehouses with integrated bulk walling and some with additional facilities such as under floor aeration.  
Additional services such as blending, screening, temperature monitoring etc can also be provided. The Port also operates a specialist terminal for finer dry bulks suitable for pneumatic discharge to silo and then onto rail or road.

**BOOTLE**

**E-ON UK Liverpool**  
Bulk Terminal  
Gladstone Dock  
Bootle  
Merseyside  
L20 1BE  
UK  
**Contact:** Mr Ken Jones,  
T: + 44 151 933 0860  
F: + 44 151 933 0867  
E: ken.jones@eon-uk.com

**BOSTON**

**Lingrain Services Ltd**  
The Dock  
Boston  
Lincs  
PE21 6BJ  
UK  
**Contact:** Mr Tony A Drew, Manager  
T: + 44 1205 366 484  
F: + 44 1205 368242  
E: tony.drew@centaurgrain.com

**BRISTOL**

**The Bristol Port Company**  
St Andrews House  
St Andrews Road  
Avonmouth  
Bristol  
Avon  
BS11 9DQ  
UK  
**Contact:** Mrs Julie Gough, Commercial Executive  
T: + 44 117 982 0000  
F: + 44 117 982 0698  
E: julie.gough@bristolport.co.uk  
W: www.bristolport.co.uk  
**Location:** Bristol Port - South West England  
**Equipment & Capacity:** Royal Portbury Dock - 2 Continuous Ship Unloaders 2500tph, , Shiploader 2000tph.  
Avonmouth Dock - Gottwald 260 HMK, 3 x mobile cranes & numerous jib cranes.  
**Bulk Berths:** 300m loa, 41m breath, 14,5m draught  
**Total Uncovered Storage:** Royal Portbury - 700,000t Coal  
**Total Covered Storage:** Royal Portbury - 200,000t AFS

**CARDIFF**

**ABP South Wales (Ports of Newport, Cardiff, Barry, Port Talbot & Swansea)**  
Queen Alexandra House  
Cargo Road  
Cardiff  
South Glamorgan

CF10 4LY  
UK  
**Contact:** Mr Matthew Kennerley, Port Director  
T: + 44 870 609 6699  
F: + 44 2920 835001  
E: mkennerley@abports.co.uk  
W: www.abports.co.uk

**CARDIFF**

**Associated British Ports**  
Queen Alexandra House  
Cargo Road  
Cardiff  
CF10 4LY  
UK  
**Contact:** Mr Callum Couper, Port Manager  
T: + 44 870 609 6699  
F: + 44 29 208 35001  
E: ccouper@abports.co.uk  
W: www.abports.co.uk  
**Location:** South Wales  
**Equipment & Capacity:** Cranes up to 45MT, Materials Handlers, Various Quayside Equipment and mobile plant  
**Bulk Berths:** Up to 35,000 dwt  
**Total Uncovered Storage:** In excess of 250,000sqm  
**Total Covered Storage:** Circa 100,000sqm  
Port of Cardiff has road connections to the M4 and links to the Midlands as well as rail connections to the national network.

**COLERAINE**

**Coleraine Harbour Commissioners**  
Harbour Office  
4 Riversdale Road  
Coleraine  
Co Londonderry  
BT52 1RY  
UK  
**Contact:** Mr Pat McKeegan, Harbour Manager  
T: + 44 28 703 42012  
F: + 44 28 703 52000  
E: coleraineharbour@aol.com  
W: www.ports.org.uk/

**DUNDEE**

**Forth Ports PLC - Port of Dundee**  
King George V Wharf  
Port Control Office  
Dundee  
DD1 3LJ  
UK  
**Contact:** Mr Matt North, Port Manager  
T: + 44 1382 224211  
F: + 44 1382 200834  
E: matt.north@forthports.co.uk  
W: www.forthports.co.uk

**DUNDEE**

**Grainfax**  
Carolina Port  
Dundee Harbour  
Dundee  
DD1 3LW  
UK  
**Contact:** Mr Alan Burns,  
T: + 44 132 4668 400  
F: + 44 1382 878 135  
E: alan.burns@forthports.co.uk  
W: www.grainfax.co.uk  
**Location:** Dundee, East of Scotland  
**Equipment & Capacity:** 2 Cranes - 300 t per hour  
**Bulk Berths:** Up to 9.5 m, 400 m lda  
**Total Covered Storage:** 20 000 sqm

**EGHAM**

**Cemex UK**  
Coldharbour Lane  
Thorpe  
Egham  
Surrey  
TW20 8TD  
UK

**Contact:** Mr Gavin Cowen, Plant Director  
**T:** + 44 1932 568 833  
**F:** + 44 1375 856618  
**E:** gavin.cowen@cemex.com  
**W:** www.cemex.co.uk/

## FALMOUTH

### A & P Falmouth Ltd

The Docks  
 Falmouth  
 Cornwall  
 TR11 4NR  
 UK

**Contact:** Mr Drystan Jones, Port Operations Director  
**T:** + 44 1326 214860  
**F:** + 44 1326 211635  
**E:** drystan.jones@ap-group.co.uk  
**W:** www.ap-group.co.uk

**Location:** South West of England  
**Equipment & Capacity:** 1 X Liebherr LHM 150.

Grab cranes, up to 500 tonnes per hour

**Bulk Berths:** 3 berths total length: 640m, maximum draught 8.2m

**Total Uncovered Storage:** 10,000 sqm

**Total Covered Storage:** 7,500 sqm  
 Strategically placed in SW approaches of English Channel. Rail connected and capable of handling a wide range of commodities.

## FELIXSTOWE

### Felixstowe Dock & Railway Company

Tomline House  
 The Docks  
 Felixstowe  
 Suffolk  
 IP11 8TB  
 UK

**Contact:** Mr Richard Pearson, Managing Director  
**T:** + 44 1394 604500  
**F:** + 44 1394 604929  
**E:** enquiries@fdrc.co.uk  
**W:** www.portoffelixstowe.co.uk/

## FOWEY

### Fowey Harbour Commissioners

Harbour Office  
 Albert Quay  
 Fowey  
 Cornwall  
 PL23 1AJ  
 UK

**Contact:** Mr M J Sutherland, Chief Executive Officer/Harbour Master  
**T:** + 44 1726 832472  
**F:** + 44 1726 833738  
**E:** info@foweyharbour.co.uk

## GARSTON

### ABP - Garston

Dock Road  
 Garston  
 Liverpool  
 L19 2JW  
 UK

**Contact:** Mr Paul Jarvis, Port Manager  
**T:** + 44 151 427 5971  
**F:** + 44 151 494 3232  
**E:** p.jarvis@abports.co.uk  
**W:** www.abports.co.uk

**Location:** North West England on North Bank of River Mersey. 10km upstream from Liverpool City Centre Lat 50 21'N Long 02 54'W

**Equipment & Capacity:** 2 Mobile exc/Heavy Lift crane/Grain conveyors

**Bulk Berths:** Various upto 150m LOA

**Total Uncovered Storage:** 30,000sqm

**Total Covered Storage:** 10,000sqm  
 Duty Free/TASCC/Soil Association approved bulk stores.

## GLASGOW

### Clyde Port Authority

16 Robertson Street  
 Glasgow  
 Strathclyde  
 G2 8DS  
 UK

**Contact:** Mr David Jerome, Marketing  
**T:** + 44 141 241 8530  
**E:** david.jerome@clydeport.co.uk  
**W:** www.clydeport.co.uk

## GRANGEMOUTH

### Casper Shipping Ltd

2nd Floor  
 5 Kerse Road  
 Grangemouth  
 FK3 8HQ  
 UK

**Contact:** Mr Douglas Couser, Office Manager  
**T:** + 44 1324 486486  
**F:** + 44 1324 486444  
**E:** dcouser@casperitd.com  
**W:** www.casperitd.com

## GRANGEMOUTH

### Forth Ports Plc

Carron House  
 Central Dock Road  
 Grangemouth  
 Stirlingshire  
 FK3 8TY  
 UK

**Contact:** Mr Dave Mc Pherson, Port Manager  
**T:** + 44 1324 668 400  
**F:** + 44 1324 668 484  
**E:** marketing@forthports.co.uk  
**W:** www.forthports.co.uk

## GRANGEMOUTH

### Grangemouth

Forth Ports Limited  
 Dock Office  
 Grangemouth  
 Stirlingshire FK3 8UE  
 UK

**Contact:** Mr Derek Knox, Port Manager  
**T:** + 44 1324 482591  
**F:** + 44 1324 665106  
**E:** enquiries@forthports.co.uk  
**W:** www.forthports.co.uk

**Location:** Grangemouth on the Firth of Forth

**Equipment & Capacity:** 2 x Ship-to-shore Container Cranes, 13 x Straddle Carriers, 3 x Empty Container Handlers, 2 x 40tonne FLT's

**Total Uncovered Storage:** 10,000sqm

**Total Covered Storage:** 19,000sqm

## GRANGEMOUTH

### Leith Docks

Forth Ports PLC  
 Carron House  
 Central Dock Road  
 Grangemouth  
 Scotland SK38TY  
 UK

**Contact:** Mr Alan C Burns,  
**T:** + 44 131 555 8750  
**F:** + 44 131 555 1212  
**E:** alan.burns@forthports.co.uk  
**W:** www.forthports.co.uk

## GRAVESEND

### Port of London Authority

London River House  
 Royal Pier Road  
 Gravesend  
 DA12 2BG  
 UK

**Contact:** Mr Doug Kempster, Marketing  
**T:** + 44 14 7456 2366  
**F:** + 44 14 7456 2398

**E:** martin.garside@hotmail.com  
**W:** www.portoflondon.co.uk

## GREAT YARMOUTH

### East Port UK

EastPort House  
 South Beach Parade  
 Great Yarmouth  
 Norfolk  
 NR30 3GY  
 UK

**Contact:** Mr Richard Goffin, Port Director  
**T:** + 44 1493 335500  
**F:** + 44 1493 857120  
**E:** bcoupland@eastportuk.co.uk  
**W:** www.eastportuk.co.uk

**Location:** Norfolk (East Coast)  
**Equipment & Capacity:** Fleet of cranes up to 80 tonne truck mobile equivalent, forklift trucks, mechanical loading shovels. Full specifications available on application.

**Bulk Berths:** 6 kilometres of commercial quays. Main bulk berths located at East Quay, and Outer Harbour.

**Total Uncovered Storage:** Open Storage in excess of 40 acres available

**Total Covered Storage:** Warehouses, varying in size, are located at strategic points around the port.

Access is normally available on a round-the-clock basis. Very low tidal range (less than 2m). No locks or bridges in the commercial area. 2 weighbridges and state of the art grain testing equipment available on site.

## GRIMSBY

### Associated British Ports - Grimsby

Port Office  
 Cleethorpe Road  
 Grimsby  
 North East Lincolnshire  
 DN31 3LL  
 UK

**Contact:** Mr Simon Bird, Port Director  
**T:** + 44 1472 359 181  
**F:** + 44 1472 242 488  
**E:** sbird@abports.co.uk  
**W:** www.abports.co.uk

## HARTLEPOOL

### Tees and Hartlepool Port Authority

Hartlepool Docks  
 Middleton Road  
 Hartlepool  
 Cleveland  
 TS24 0SE  
 UK

**Contact:** Ms Kirsten Potter, Marketing  
**T:** + 44 1642 87 7000  
**F:** + 44 1642 87 7056  
**E:** kirsten.potter@pdports.co.uk  
**W:** www.thpal.co.uk

## HOLYWELL

### Mostyn Docks Limited

Mostyn  
 Holywell  
 Clwyd  
 CH8 9HD  
 UK

**Contact:** Mr R C Hyde-Linaker, Harbour Master  
**T:** + 44 1745 560335  
**F:** + 44 1745 560324  
**E:** harbourmaster@portofmostyn.com  
**Location:** North East Wales

**Equipment & Capacity:** One crane up to 26t, FLT up to 25t. Loading Shovels Bobcats Etc.

**Bulk Berths:** Up to 120m length overall and 6m draught.

**Total Uncovered Storage:** 5 Acres adjacent to berths  
**Total Covered Storage:** 25,000sqm

## HULL

### ABP - Port of Hull

PO Box 1  
 Port House  
 Northern Gateway  
 Hull  
 HU9 5PQ  
 UK

**Contact:** Mr James Leeson, Head of Commercial  
**T:** + 44 1472 246 204  
**F:** + 44 1482 326 283  
**E:** jleeson@abports.co.uk  
**W:** www.abports.co.uk

Hull's has trade links with Europe, Scandinavia and the Baltic, in addition to world-wide deep-sea services. Hull is the UK's leading softwood timber port, and is the only passenger port on the Humber estuary.

## HULL

### Frontier Agriculture Ltd

King George Dock  
 Hull  
 HU9 5PR  
 UK

**Contact:** Mr Tony Greendale, Silo Manager  
**T:** + 44 1482 701281  
**F:** + 44 1482 784891  
**E:** tony.greendale@frontierag.co.uk

## HULL

### Titan Cement UK

Shed 12  
 King George Dock  
 Hull  
 HU9 5PR  
 UK

**Contact:** Mr Phil Langdale, General Manager  
**T:** + 44 1482 784 012  
**F:** + 44 1482 784 013  
**E:** info@titanuk.co.uk  
**W:** www.titanuk.co.uk

## IMMINGHAM

### Associated British Ports

Dock Office  
 Immingham Dock  
 Immingham  
 North Lincolnshire  
 DN40 2LZ  
 UK

**Contact:** Mr Simon Bird, Director, Humber  
**T:** + 44 1472 242 200  
**E:** humber.commercial@abports.co.uk  
**W:** www.abports.co.uk

**Location:** Yorkshire & The Humber  
**Equipment & Capacity:** See website for full details (www.abports.co.uk)

**Bulk Berths:** See website for full details (www.abports.co.uk)

**Total Covered Storage:** 30,000sqm

Immingham is the UK's largest port by tonnage, handling up to 55 million tonnes. The port has both river and in-dock deep-water facilities with easy access to the major trade routes.

## IMMINGHAM

### Casper Shipping Ltd

Riverside House  
 East Riverside  
 Immingham  
 NE Lincolnshire  
 DN40 2LZ  
 UK

**Contact:** Mr David Healey,  
**T:** + 44 1469 575 246  
**F:** + 44 1469 575 589  
**E:** immingham@casperitd.com  
**W:** www.casperitd.com

**Location:** North East Lincolnshire

**Equipment & Capacity:** 3 x shore mobile and 2 x shore gantry  
**Bulk Berths:** LOA 295m x beam 45m x airdraft 17m x draught 14.20m - subject to tidal conditions

Tidal predictions available on request.

## IPSWICH

### ABP - Port of Ipswich

Old Custom House  
 Key Street  
 Ipswich  
 Suffolk  
 IP4 1BY  
 UK

**Contact:** Mr Alan Mason, Sales Manager  
**T:** + 44 1473 231010  
**F:** + 44 1473 230914  
**E:** amason@abports.co.uk  
**W:** www.abports.co.uk

**Location:** East coast, Suffolk, England

**Equipment & Capacity:** All equipment necessary for bulk/neo bulk cargoes.

**Bulk Berths:** Vessels up to 15,000dwt.

**Total Uncovered Storage:** Various areas at all port berths.

**Total Covered Storage:** 74,000sqm  
 Extensive variety of purpose built, modern storage facilities adjacent to berths.

## IPSWICH

### ABP Port of Lowestoft

Old Custom House  
 Key Street  
 Ipswich  
 Suffolk  
 IP4 1BY  
 UK

**Contact:** Mr Alastair MacFarlane, Port Manager  
**T:** + 44 147 323 1010  
**F:** + 44 147 328 8488  
**E:** amacfarlane@abports.co.uk  
**Location:** East of England on the North Sea

**Bulk Berths:** Silo berth 10,000t grain & 4,000t cement

**Total Uncovered Storage:** 6m draught m.a.a.b.j.a. 10,000 approx

**Total Covered Storage:** 10,000sqm

## IPSWICH

### Clarksons Port Services

Sentinel Terminal  
 East Bank  
 Cliff Quay  
 Ipswich  
 IP3 OBS  
 UK

**Contact:** Mr Julian Scott, Director  
**T:** + 44 1473 254435  
**F:** + 44 1473 254438  
**E:** Julian.Scott@clarksons.com  
**W:** www.clarksons.com  
**Location:** East Anglia

## IPSWICH

### The Grain Terminal (Ipswich) Ltd

Cliff Quay  
 Ipswich  
 Suffolk  
 123 OBG  
 UK

**Contact:** Mr Tim Capey, Director  
**T:** + 44 1473 250461  
**F:** + 44 1473 233212

**E:** info@grainterminal-ips.com  
**W:** www.ipswichgrainterminal.com/

**Location:** East Anglia

**Equipment & Capacity:** Ipswich (600 mt load rate/hr)

Ipswich (5 cranes)  
 Harwich Grain Terminal (6000 mt load rate /day)

**Total Covered Storage:** Ipswich 80,000 mt

Harwich 25,000 mt

## ISLE OF MAN

### Port of Ramsey

Harbour Master's Office  
 East Quay

Ramsey  
 Isle of Man  
 IM8 IBG  
 UK

### Contact: The Manager

**T:** +44 1624 812 245

**F:** + 44 1624 815 361

**E:** ramsey.port@gov.im

**W:** www.gov.im/harbours

**Location:** Isle of Man

**Equipment & Capacity:** Private.

Mobile cranes

**Bulk Berths:** L = 58m. Max draught 4.0m spring tide

**Total Uncovered Storage:** None

**Total Covered Storage:** Private warehouse

## KINGS LYNN

### King's Lynn Conservancy Board

Harbour Office  
 Common Staithe  
 Kings Lynn  
 Norfolk  
 PE30 1LL  
 UK

**Contact:** Mr J Lorking, Harbour Master

**T:** + 44 1553 773411

**F:** + 44 1553 768185

**E:** harbourmaster@

portauthoritykingslynn.fsnet.co.uk

## LIVERPOOL

### Mersey Docks & Harbour Company

Maritime Centre  
 Port of Liverpool  
 Liverpool  
 Merseyside  
 L21 1LA  
 UK

**Contact:** Ms Ruth Hodgson,

**T:** + 44 15 194 96 324

**E:** ruth.hodgson@peelports.co.uk

**W:** www.peelports.com

**Location:** North West of England at mouth of River Mersey

**Equipment & Capacity:** Specialist craneage and equipment to handle all cargoes specific to the Port

**Bulk Berths:** Numerous berths and facilities located in both Liverpool and Birkenhead Dock systems.

**Total Uncovered Storage:** 8,100,000 sqm

**Total Covered Storage:** 500,000 sqm

A multi functional Port with individual companies specialising in the handling, storage, and distribution of the various commodities handled through the Port's facilities.

## LIVERPOOL

### Royal Seaforth Grain Terminal

Royal Seaforth Dock  
 Liverpool  
 L21 1JD  
 UK

**Contact:** Mr Colin McLoughlin,

**T:** + 44 151 949 6201

**F:** + 44 151 949 6461

**E:** colin.mcloughlin@peelports.com

## LONDON

### MacQuarie Capital (Europe) Limited

28 Ropemaker Street  
 London  
 EC2Y 9HD  
 UK

**Contact:** Mr Jim Lennon, Executive Director

**T:** + 44 20 3037 4271

**F:** + 44 20 3037 4306

**E:** jim.lennon@macquarie.com

## LONDONDERRY

### Londonderry Port & Harbour Commissioners

Harbour Office



Port Road  
Lisahally  
Londonderry  
Northern Ireland  
BT47 6FL  
UK  
**Contact:** Mr Bill McCann, Harbour Master  
T: +44 287 186 1113  
F: +44 28 7186 1168  
E: bill@londonderry-port.co.uk  
W: www.londonderryport.com

**MANNINGTREE**  
**Mistley Quay & Forwarding**  
High Street  
Mistley  
Manningtree  
Essex  
CO11 1HB  
UK  
**Contact:** Mr John Jenkins, Port Manager  
T: +44 1206 394431  
F: +44 1206 393882  
E: jrjenkins@twlogistics.co.uk

**MERTON**  
**ABP**  
Merton Lane  
Merton  
York  
YO19 5GH  
UK  
**Contact:** Mr David Wood, General Manager  
T: +44 1904 488333  
F: +44 1904 489837  
E: david.wood@abpbeef.com

**METHIL**  
**Port of Burntisland**  
Forth Ports PLC  
Dock Office  
Methil  
Fife  
KY8 3RE  
UK  
**Contact:** Mr Murray  
Murray Cheyne, Port Superintendent  
T: +44 1383 413 366  
F: +44 1333 424 873  
E: alan.burns@forthports.co.uk

**MIDDLESBROUGH**  
**Casper Shipping Ltd**  
Tees Wharf  
Dockside Road  
Middlesbrough  
Cleveland  
TS3 6AH  
UK  
**Contact:** Mr Michael Shakesheff, Managing Director  
T: +44 1642 243 662  
F: +44 1642 243 936  
E: mshakesheff@casperitd.com  
W: www.casperitd.com  
**Location:** UK - Nationally

**MIDDLESBROUGH**  
**Redcar Bulk Terminal Limited**  
Lackenby Main Office  
Lackenby Works  
Middlesbrough  
TS6 7RP  
UK  
**Contact:** Mr Garry O'Malley, General Manager  
T: +44 1642 406444  
E: Garry.omalley@redcarbulterminal.com  
W: www.redcarbulterminal.co.uk  
**Location:** North East Coast of the UK on the South Bank Of The River Tees  
**Equipment & Capacity:** 2 x Ship Unloaders - 40k tpd  
**Bulk Berths:** 320 metre Quay max draught 17m  
**Total Uncovered Storage:** 320

Acres  
**Total Covered Storage:** 2,000  
Capacity to handle Cape Size  
Vessels up to 17m draught. Terminal is rail linked with bulk handling facilities for speedy handling of rail traffic.

**MONTROSE**  
**Montrose Port Authority**  
South Quay  
Ferryden  
Montrose  
Angus  
DD10 9SL  
UK  
**Contact:** Mr Nik Scott-Gray, Chief Executive  
T: +44 1674 672302  
F: +44 1674 675530  
E: info@montroseport.co.uk  
W: www.montroseport.co.uk  
**Location:** East Coast of Scotland  
**Equipment & Capacity:** Craneage/Elevators etc.  
**Bulk Berths:** Quayside Bulk Stores  
**Total Uncovered Storage:** 60,000sqm  
**Total Covered Storage:** 200,000sqm  
Common user quaysides in close proximity to storage facilities. Depth alongside 8.5m.

**NEAR HULL**  
**Hull Agency (Goole)**  
Casper Shipping Ltd  
Saltend Office DL1 (Upper Floor)  
Saltend Hedon  
Near Hull  
East Yorkshire  
HU12 8DS  
UK  
**Contact:** Mr Don Mussett,  
T: +44 1482 891533  
F: +44 1482 891186  
E: hull@casperitd.com  
W: www.casperitd.com

**NEWPORT**  
**ABP - Port of Newport**  
Dock Office  
Alexandra Dock  
Newport  
Gwent  
NP20 2UW  
UK  
**Contact:** Mr Clive Thomas, Deputy Port Manager  
T: +44 870 609 6699  
F: +44 1633 221285  
E: cthomas@abports.co.uk  
W: www.abports.co.uk  
**Location:** South Wales

**NEWPORT**  
**Newport Stevedores Ltd**  
Eastway Road, North Dock  
Alexandra Dock  
Newport  
Gwent  
NP9 2NP  
UK  
**Contact:** Mr Matthew Kennerley, Port Director  
T: +44 1633 220969  
F: +44 1633 221371  
E: info@abports.co.uk

**NORTH KILLINGHOLME**  
**Humber Sea Terminal**  
Simon Warehousing and Distribution  
Clough lane  
North Killingholme  
DN40 3JP  
UK  
**Contact:** Mr Hugh Gates,  
T: +44 1469 542 125  
F: +44 1469 541 121  
E: hugh.gates@simonports.co.uk  
W: www.simongroup.plc.uk

**NOTTINGHAM**  
**Hull Bulk Handling Ltd**  
Fernwood House  
Fernwood Drive  
Main Road  
Watnall  
Nottingham  
NG16 1LA  
UK  
**Contact:** Mr Charles Holehouse, Managing Director  
T: +44 11 593 893 78  
F: +44 1482 784 895  
E: charles.holehouse@fernwood.co.uk  
W: www.hullbulk.co.uk  
**Location:** North East of England on the North Sea, Humber Estuary.  
**Equipment & Capacity:** 2 x Butlerley 15 tonne grab crane up to 1300 tph  
**Bulk Berths:** 10 Quay, Queen Elizabeth Dock  
195m LOA.  
10.4m Draught.  
25.5m Beam  
**Total Uncovered Storage:** 165,000 sqm (storage capacity: 950,000 tonnes)  
**Total Covered Storage:** 7,500 sq metres (Storage Capacity: 60,000 tonnes)  
Terminal is road /rail and barge connected see website : www.hullbulk.co.uk for further details.

**OBAN**  
**Glensanda Harbour**  
Yeoman Glensanda  
Rhugh Garbh Depot  
Barcaldine  
Oban  
Argyll  
PA37 1SE  
UK  
**Contact:** Captain John Jackson, Harbour Master/Pilot  
T: +44 1631 730537  
F: +44 1631 730460  
E: john.jackson@foster-yeoman.co.uk  
**Location:** West Coast of Scotland.  
**Equipment & Capacity:** One ship loader capable of loading Panamax size vessels at 6 000 tph.  
**Bulk Berths:** Berth length 100m with mooring dolphins on shore. Max length 256m - max draught 14.5 m on high tide. Approximately 7 000 000 mt crushed granite aggregates are shipped out annually from Glensanda.

**PADSTOW**  
**Padstow Harbour Commissioners**  
Harbour Office  
West Quay  
Padstow  
Cornwall  
PL28 8AQ  
UK  
**Contact:** Mr R M Atkinson, Harbour Master  
T: +44 1841 532239  
F: +44 1841 533346  
E: padstowharbour@btconnect.com  
W: www.padstow-harbour.co.uk

**PENZANCE**  
**Penzance Harbour**  
Harbour Office, North Arm  
Wharf Road  
Penzance  
Cornwall  
TR18 4AH  
UK  
**Contact:** Mr Neil Clark, Harbour Master  
T: +44 1736 366113  
F: +44 1736 366114  
E: neil.clark@penwith.gov.uk  
W: www.penwith.gov.uk

**PERTH**  
**Perth Harbour**  
Perth Harbour Office  
Friarton Road  
Perth  
Scotland  
NG16 8BB  
UK  
**Contact:** Harbour Master  
T: +44 1738 624056  
F: +44 1738 622263  
**Location:** An inland port on the east coast of Scotland approx. 26 miles from the fairway buoy on the River Tay.  
**Bulk Berths:** Vessels up to 90 metres accepted.  
All stevedoring and storage is handled by independent operators.

**POOLE**  
**Poole Harbour Commissioners**  
20 New Quay Road  
Hamworthy  
Poole  
Dorset  
BH15 4AF  
UK  
**Contact:** Mr Jim Stewart, Chief Executive  
T: +44 1202 440210  
F: +44 1202 440212  
E: chiefexecutive@phc.co.uk  
W: www.phc.co.uk

**PORT TALBOT**  
**ABP - Port Talbot**  
Puckey House  
The Docks  
Port Talbot  
West Glamorgan  
SA13 1RB  
UK  
**Contact:** Mr Matthew Kennerley, Port Director  
T: +44 870 609 6699  
F: +44 1275 372 255  
E: mkennerley@abports.co.uk  
W: www.abports.co.uk

**PORTBURY**  
**Agricultural Bulk Services**  
Royal Portbury Dock  
Portbury  
Bristol  
BS20 9XL  
UK  
**Contact:** Mr James Reeson,  
T: +44 1275 375 777  
F: +44 1275 374932  
E: james.reeson@bristolport.co.uk

**PORTLAND**  
**Portland Port Ltd**  
Port Office  
Castletown  
Portland  
Dorset  
DT5 1PP  
UK  
**Contact:** Mr Steve Davies, Director and General Manager  
T: +44 1305 824044  
F: +44 1305 823045  
E: l.green.pa@portland-port.co.uk  
W: www.portland-port.co.uk  
**Location:** UK SouthCoast  
**Equipment & Capacity:** 50t - 15t  
2 Cranes  
6t 2 Cranes  
300t 1 Crane  
**Bulk Berths:** 13 Commercial Berths  
-Max Draft13m  
Max LOA250m  
**Total Uncovered Storage:** 30,000m<sup>2</sup>  
**Total Covered Storage:** 10,000m<sup>2</sup>

**ROSYTH**  
**Port of Methil**  
Forth Ports PLC  
Exmouth Building  
Rosyth

Fife  
KY11 2XP  
UK  
**Contact:** Mr Alan Burns, Port Manager  
T: +44 1383 413 366  
F: +44 1383 414 499  
E: alan.burns@forthports.co.uk

**RUNCORN**  
**Manchester Ship Canal Company Ltd**  
Engineering Workshops  
Runcom Docks  
Perceival Lane  
Runcom  
Cheshire  
WA7 4UY  
UK  
**Contact:** Mr Dean Hammond, General Manager  
T: +44 01928 508550  
F: +44 01928 567469  
E: mail@shipcanal.co.uk  
W: www.shipcanal.co.uk

**RYE**  
**Rastrum Ltd**  
Rye Wharf  
Harbour Road  
Rye  
East Sussex  
TN31 7TE  
UK  
**Contact:** Mr Rod Chapman, Director  
T: +44 1797 224778  
F: +44 1797 223650  
E: rodco@ryewharf.co.uk  
W: www.ryewharf.co.uk  
**Location:** South East Coast of England  
**Equipment & Capacity:** Mechanical Handling 500tph  
**Bulk Berths:** 2 x 2,500 tonnes  
**Total Uncovered Storage:** 50,000sqm  
**Total Covered Storage:** 30,000sqm

**SEAHAM**  
**Seaham Harbour Dock Company**  
Cargo Durham Distribution Centre  
Seaham  
Durham  
SR7 7NZ  
UK  
**Contact:** Mr Alan Luscombe, Managing Director  
T: +44 191 516 1700  
F: +44 191 516 1701  
E: alanluscombe@victoriagroup.co.uk  
W: www.portofseaham.demon.co.uk

**SHARPNES**  
**Port of Sharpness**  
c/o Sharpness Docks Ltd  
Sharpness  
Gloucester  
GL13 9UX  
UK  
**Contact:** Mr Garry Strickland, General Manager/Director  
T: +44 1453 811644  
F: +44 1453 811990  
E: info@sharpnessdock.co.uk  
**Location:** South West England  
Bristol Channel  
**Equipment & Capacity:** 4 x Portal cranes at 6.0 mts capacity  
1 x Cement pump  
2 x Grain elevators  
3 x WCK mobile cranes  
200 mts per hour  
**Bulk Berths:** 14 berths - 6 metres draft  
**Total Uncovered Storage:** 50 000 sqm  
**Total Covered Storage:** 250 000 sf  
2 x Grain export silos with combined capacity of 16 000 tonnes

**SILLOTH**  
**ABP - Port of Silloth**  
Dock Office  
New Dock  
Silloth  
Cumbria  
CA7 4JQ  
UK  
**Contact:** Captain Tim Riley, Harbour Master & Port Superintendents Office  
T: +44 1697 331358  
F: +44 1697 332709  
E: silloth@abports.co.uk  
W: www.abports.co.uk/Marine/Short\_Sea\_a\_Ports/Silloth/  
**Location:** North West England  
**Equipment & Capacity:** Contracted in Bulk Molasses storage. Heavy lift any bulk cargo can be handled.

**SOUTH SHIELDS**  
**Port of Tyne**  
Maritime House  
Tyne Dock  
South Shields  
Tyne & Wear  
NE34 9PT  
UK  
**Contact:** Mr Nolan Gray, Business Development Director  
T: +44 191 440 7403  
E: nolan.gray@portofityne.co.uk  
W: www.portofityne.co.uk  
**Location:** Riverside Quay, north east of England on the north east coast

**Location - South Side River Tyne** 54 degrees 59.13'N 001 degrees 27.3'West (Chart BA 1934)  
**Distance to sea** 2.2 miles  
**Equipment & Capacity:** - 6.9 ha Container Terminal  
- Heavy duty harbour mobile cranes and associated equipment (Gottwald and Liebherr)  
- Heavy-duty mobile loading shovels  
- Fork lift trucks  
- Pallet storage: 58,000 pallet slots available  
- Intermodal rail terminal and in-house distribution fleet  
**Bulk Berths:** Riverside Quay: 574m long Depth of Water 12.1m below Chart Datum  
**Total Uncovered Storage:** 20,000sqm Customs Approved open storage area  
**Total Covered Storage:** 21,000sqm Customs Approved transit shed storage  
The Port of Tyne is a deep river port open 24 hours/7 days a week and situated to the A1, M1, A19 road links and with a rail terminal linking to the main London Edinburgh rail network.

**SOUTHAMPTON**  
**ABP - Southampton**  
Ocean Gate  
Atlantic Way  
Eastern Docks  
Southampton  
SO1 1XQ  
UK  
**Contact:** Mr Douglas Morrison, Port Director  
T: +44 2380 48 88 00  
F: +44 2380 33 64 02  
E: dmorrison@abports.co.uk  
W: www.abports.co.uk

**SOUTHAMPTON**  
**Solent Stevedores Ltd**  
King George V Dock  
Western Avenue  
Western Docks  
Southampton  
Hampshire  
SO15 0HH  
UK  
**Contact:** Mr Stuart Cullen,

Managing Director  
T: +44 1453 544 449  
F: +44 1453 549 149  
E: stuart@solentstevedores.com  
W: www.solentstevedores.co.uk  
**Location:** Southampton on the Solent, Hampshire; Silvertown on the Thames, London  
**Equipment & Capacity:** Mobile harbour cranes, quay cranes, conveyor system, quayside equipment, 4 x public weighbridges  
**Total Uncovered Storage:** 75,000sqm  
**Total Covered Storage:** 20,000sqm

**SOUTHAMPTON**  
**Southampton Grain Terminal Ltd**  
Gate 4 Berth 36  
Test Road  
Eastern Docks  
Southampton  
SO14 3GG  
UK  
**Contact:** Mr Richard Pollard, Director  
T: +44 2 380 334433  
F: +44 2 380 330657  
E: richard.pollard@sgtsilos.co.uk  
**Location:** South of England on English Channel  
**Equipment & Capacity:** Ship loader at up to 1,000tph  
**Bulk Berths:** 36 Berth vessels up to 220m - tidal min 9.3m  
**Total Uncovered Storage:** Not applicable  
**Total Covered Storage:** Concrete silos - 28,000t  
Vessels up to 235m may be accommodated

**SUNDERLAND**  
**Port of Sunderland**  
Capstan House  
Greenwells Quay  
South Docks  
Barrack Street  
Sunderland  
Tyne & Wear  
SR1 2BU  
UK  
**Contact:** Mr Matthew Hunt, Port Director  
T: +44 191 553 2100  
F: +44 191 553 2120  
E: ian.duncan@portofsunderland.org.uk  
W: www.portofsunderland.org.uk  
**Location:** North East of England on the East Coast  
**Bulk Berths:** East Quay South, Hudson Dock: 183m long, 5.5m draught  
**Total Uncovered Storage:** 6 400 sqm  
**Total Covered Storage:** Nil  
Current bulk materials are accommodated on a self-handled basis. All berths are serviced by a crawler crane if required.

**SWANSEA**  
**ABP - Port of Swansea**  
Dock Office  
Alexandra Dock  
Newport  
Gwent  
NP20 2UW  
UK  
**Contact:** Mr Clive Thomas, Deputy Port Manager  
T: +44 870 609 6699  
F: +44 1633 221285  
E: cthomas@abports.co.uk  
W: www.abports.co.uk/swansea

**TEIGNMOUTH**  
**ABP - Teignmouth**  
Teignmouth  
Devon  
UK  
**Contact:** Mr Colin Greenwell, Port

Manager  
T: +44 1626 774044  
F: +44 1626 776240  
E: teignmouth@abports.co.uk

**TILBURY**  
**European Metal Recycling Ltd**  
13-19 Berth  
Tilbury Dock  
Tilbury  
Essex  
RM18 7EH  
UK  
**Contact:** Mr Bob Garwood, Southern Director  
T: +44 1322 336970  
F: +44 1322 331581  
E: bob.garwood@emrgroup.com  
W: www.emrtd.com  
**Location:** Deep Sea Terminals for bulk handling at Tilbury, Tyne Dock, Liverpool and Cardiff  
**Equipment & Capacity:** 1,000,000 tonnes per annum at each site  
**Bulk Berths:** Generally 10.5m draught.  
**Total Uncovered Storage:** 10,000sqm  
**Total Covered Storage:** None

**TILBURY**  
**Port of Tilbury London Limited**  
Lesley Ford House  
Tilbury FreePort  
Tilbury  
Essex  
RM18 7EH  
UK  
**Contact:** Mrs Tracey Sampson,  
T: +44 1375 852 200  
F: +44 1375 855 106  
E: caroline.gerrard@potll.com  
W: www.forthports.co.uk

**TILBURY**  
**Port of Tilbury London Ltd - Grain Terminal**  
Tilbury FreePort  
Tilbury  
Essex  
RM18 7EH  
UK  
**Contact:** Mr Peter Ward, Senior Asset Manager - Grain & Bulks  
T: +44 1375 852485  
F: +44 1375 852250  
E: peter.ward@potll.com  
W: www.forthports.co.uk/ports/tilbury/  
**Location:** South East England  
**Equipment & Capacity:** 2 continuous unloaders, 2,000mt per hour.  
2 harbour mobile grab cranes.  
**Bulk Berths:** Grain 12.5m. Bulks 10.5m  
**Total Uncovered Storage:** 120,000 silos.  
80,000 flat stores.  
1 Grain Terminal for import/export.  
2 Bulk Handling berths.

**TILBURY**  
**Stema Shipping UK**  
Powell Duffryn House  
21 Berth  
Tilbury Docks  
Tilbury  
Essex  
RM18 7JT  
UK  
**Contact:** Mr Terje Johansen,  
T: +44 1375 857890  
F: +44 1375 857456  
E: enquiries@stema.co.uk  
W: www.stema.co.uk

**WARRENPOINT**  
**Warrenpoint Harbour Authority**  
The Docks  
Warrenpoint

Co Down  
BT34 3JR  
UK  
**Contact:** Mr Kerin Grant, Operations Director  
T: +44 28 4175 2878  
F: +28 4175 2875  
E: bmccjury@warrenpointharbour.co.uk  
**Location:** East Coast - Northern Ireland  
**Equipment & Capacity:** 4 Mobile, 2 Grantry - up to 43 tonnes swc  
**Bulk Berths:** 6 Berths

**WHITSTABLE**  
**Whitstable Harbour**  
Harbour Office  
Whitstable  
Kent  
CT5 1AB  
UK  
**Contact:** Mr Michael Weir, Port Manager & Harbour Master  
T: +44 1227 274086  
E: whitstable.harbour@canterbury.gov.uk  
W: http://whitstable.seapublish.co.uk/  
**Location:** South East Kent  
**Equipment & Capacity:** Cranes to be hired from private contractor  
**Bulk Berths:** West Quay 170m East Quay 140  
**Total Uncovered Storage:** 5700 sqm  
**Total Covered Storage:** 0

**WOLVERHAMPTON**  
**Tarmac Limited**  
Millfields Road  
Ettingshall  
Wolverhampton  
West Midlands  
WV4 6JP  
UK  
**Contact:** Mr Paul Burgess, Production Manager  
T: +44 1206 332 464  
E: enquiries@tarmac.co.uk  
W: www.tarmac.co.uk/

**WORKINGTON**  
**Port of Workington**  
Cumbria County Council  
Prince of Wales Dock  
Port of Workington  
Workington  
Cumbria  
CA14 2JH  
UK  
**Contact:** Mr Jeremy Lihou, Port Manager  
T: +44 1900 602301  
F: +44 1900 604696  
E: gateway@portofworkington.co.uk  
W: www.portofworkington.gov.uk  
**Location:** North West of England on the Cumbrian coast  
**Equipment & Capacity:** Up to 12,000 tonne DWAT  
**Bulk Berths:** 7 berths 772m total inc. ro-ro  
**Total Uncovered Storage:** 20,000sqm  
**Total Covered Storage:** 6,500sqm  
Bulk, break bulk, project cargo, containers across sea, rail and road. In-house stevedoring and marine section.

## UKRAINE

**BERDYANSK**  
**Berdiansk Port Authority**  
13/7 Maxim Gorky Street  
Berdiansk  
Zaporizh'ie Province  
71112  
Ukraine  
**Contact:** Mr Anatoliy Reznikov, Director General  
T: +380 61 53 32210  
F: +380 61 53 36593

E: post@bstport.berdiansk.net  
W: www.ukrport.org.ua/  
p-berdiansk-e.htm

**IICHIEVSK**  
**Port of Ilichevsk Authority**  
6 Trouda Square  
Ilichevsk  
270901  
Ukraine  
T: +380 48 68 691 600  
F: +380 48 68 693 606  
E: pm@ilport.com.ua

**IZMAIL**  
**Commercial Sea Port of Izmail**  
Str. Portovaya 7  
Izmail  
68600  
Ukraine  
**Contact:** Mr Valentin F Kotelny, Port Director  
T: +380 4841 25601  
F: +380 4841 26258  
E: ves@izmport.com.ua

**KERCH**  
**The Kerch Merchant Port**  
28 Kirova Street  
Kerch  
Crimea  
334512  
Ukraine  
T: +380 654 777-83-80  
F: +380 654 35-64-01  
E: ukrport@ukrport.org.ua  
W: www.ukrport.org.ua

**KYIV**  
**PORTINVEST LLC**  
Velyka Vasylykivska street 77A  
Kyiv  
Kyiv 03150  
Ukraine  
**Contact:** Ms Olena Svitychna, PR-Manager  
T: +38 044 581 81 24  
F: +38 050 359 95 00  
E: olena.svitychna@portinvest.com.ua  
W: www.portinvest.com.ua

**MARIUPOL**  
**State Enterprise "Mariupol Sea Commercial Port"**  
99, Admiral Lunin Avenue  
Mariupol  
Donetsk Region  
87510  
Ukraine  
**Contact:** Mr Aleksandr Oleynik, Port Director  
T: +380 629 408 634  
F: +380 629 408 660  
E: all@marport.net; mail@marport.net  
W: www.marport.net  
**Location:** South East of Ukraine, North West part of Taganrog Gulf of the Sea of Azov, 14 miles from the gulf entry.  
**Equipment & Capacity:** Portal cranes 5-50 in capacity  
Floating cranes 100-150 in capacity  
Container loaders 40 in capacity, RTG cranes  
**Bulk Berths:** 18 Berths TOTAL, 8 Berths - BULK cargo, 10 Berths - GENERAL cargo  
**Total Uncovered Storage:** 270,033.3 sqm  
**Total Covered Storage:** 14,073.3 sqm  
Mariupol Port is one of the leading ports in Ukraine on mechanization, hydro-engineering construction. It is one of 4 Ukrainian largest ports as to dry cargo handling volumes.

**ODESSA**  
**Transship LTD**  
Marazilevskaya Str, 8  
Odessa  
65014  
Ukraine  
**Contact:** Mr Eugene Mashtakov,  
T: +380 482 33 33 32  
F: +38 482 34 74 07  
E: e.mashtakov@transship.ua  
W: www.transship.com.ua

**PORT OF KILIA**  
**Kiliya Transhipment Point**  
4 Zheleznyakova Street  
Port of Kilia  
Odessa Region  
683000  
Ukraine  
**Contact:** Mr Bladimir Chernobykin, Managing Director  
T: +38 04843 238 81  
F: +38 04843 237 03  
E: kilport.kiliya.upl.net

Nikoleav  
327004  
Ukraine  
**Contact:** Port Director  
T: +380 512 508 400  
F: +380 512 508 807  
E: nmtp@portnikoleav.com  
W: www.portnikoleav.com

**ODESSA**  
**Port of Odessa Authority**  
1 Vakulenchuk Square  
Merskyo Port  
Odessa  
27004  
Ukraine  
**Contact:** Mr AP Kharitoshin, Harbour Master  
T: +380 482 218081  
F: +380 482 348328  
E: info@portgdansk.pl

**ODESSA**  
**PortInvest**  
11 Polskyj Uzviz  
Odessa  
65026  
Ukraine  
**Contact:** Mr Ilija Cerkasskis, Project Manager  
T: +38 048 740 04 06  
F: +38 048 710 04 01  
E: ilija.cerkasskis@portinvest.com.ua  
W: www.portinvest.com.ua

**ODESSA**  
**Transinvestservice (TIS) Ltd**  
50 Chapayev Str  
Vizirka Village  
Kominternovo District  
Odessa  
67543  
Ukraine  
**Contact:** Mr Andrey Stavntser, Deputy Director  
T: +380 482 300 711  
F: +380 482 300 735  
E: mail@tis.ua  
W: www.tis.ua  
**Location:** Yuzhny port, North Coast of the Black Sea  
**Equipment & Capacity:** Total truck discharge - 1000 trucks/day.  
Total RW discharge - 1000 wagons/day  
5 million tonnes per year  
**Bulk Berths:** Depth 14m. Length 760m  
Vessel size limitation: Capesize DWT up to 130,000 tons  
**Total Uncovered Storage:** Total storage: 770,000 mt  
380,000 tonnes - total storage for grains  
20,000 sqm  
**Total Covered Storage:** 65,000 sqm

**ODESSA**  
**Transship LTD**  
Marazilevskaya Str, 8  
Odessa  
65014  
Ukraine  
**Contact:** Mr Eugene Mashtakov,  
T: +380 482 33 33 32  
F: +38 482 34 74 07  
E: e.mashtakov@transship.ua  
W: www.transship.com.ua

**ODESSA**  
**Transship LTD**  
Marazilevskaya Str, 8  
Odessa  
65014  
Ukraine  
**Contact:** Mr Eugene Mashtakov,  
T: +380 482 33 33 32  
F: +38 482 34 74 07  
E: e.mashtakov@transship.ua  
W: www.transship.com.ua

**ODESSA**  
**Transship LTD**  
Marazilevskaya Str, 8  
Odessa  
65014  
Ukraine  
**Contact:** Mr Eugene Mashtakov,  
T: +380 482 33 33 32  
F: +38 482 34 74 07  
E: e.mashtakov@transship.ua  
W: www.transship.com.ua

**ODESSA**  
**Transship LTD**  
Marazilevskaya Str, 8  
Odessa  
65014  
Ukraine  
**Contact:** Mr Eugene Mashtakov,  
T: +380 482 33 33 32  
F: +38 482 34 74 07  
E: e.mashtakov@transship.ua  
W: www.transship.com.ua

**RENI**  
**Port of Reni**  
188 Dunayskaya Str.  
Reni  
Odessa  
68802  
Ukraine  
**Contact:** Mr Yuriy Pishchalo, Manager of Marketing and Commerce Dpt  
T: +380 4840 42652  
F: +380 4840 26739  
E: ovspor@reni.upl.net  
W: www.portreni.com.ua  
**Location:** South-west of Ukraine at the junction of the Ukrainian, Romanian and Moldovian borders, at the crossing of 4 transport corridors: Cretan No. 7 and No. 9, Euro-Asian and Black Sea.  
**Equipment & Capacity:** 2 x cranes, lifting capacity 36t and 250t  
3 x floating cranes, lifting capacity 5t, 16t and 100t  
Variety of gantry cranes, fork lift trucks, bucket loaders etc.  
**Bulk Berths:** 39 specialised berths, handling cargoes including general, bulk, and loose bulk.  
Vessel size limitation - draught enabling passage along Sulinsky Canal (7 m.), which connects the Danube with the Black Sea.  
**Total Uncovered Storage:** 195,000sqm  
**Total Covered Storage:** 30,000sqm

**VIKOVO**  
**Port of Ust-Dunaysk**  
2 Pridunayskaya Street  
Vikovo  
Odessa  
272626  
Ukraine  
**Contact:** Mr Pavel V Kosinets, General Director  
T: +380 4843 31135

**YALTA**  
**Yalta Sea Trade Port Authority**  
5 President F D Roosevelt Street  
Yalta  
Crimea  
334200  
Ukraine  
**Contact:** Mr Sergiy Tarakanov, General Manager  
T: +380 654 230 065  
F: +380 654 323 926  
E: yasoo@mail.ylt.crimea.com

**YUZHNY**  
**JV Transinvestservice TIS**  
Chapayeva Str  
50 v Vizirka  
Kominter-Novsk District  
Yuzhny  
Odessa Region  
67543  
Ukraine  
**Contact:** Mr Oleg Sologul, Industrial Engineer  
T: +380 482 725711  
F: +380 480 300735  
E: mail@tis.ua  
W: www.tis.ua

**YUZHNY**  
**Port Yuzhny**  
Bulk and General Cargo Terminal  
Yuzhny  
Odessa Region  
65481  
Ukraine  
**Contact:** Mr V Ivanov, General Port Director  
T: +380 487 507 254  
F: +380 48 750 7254  
E: boss@port-yuzhny.com.ua  
W: www.port.yuzhny.odessa.ua



## URUGUAY

### MONTEVIDEO

**Corporación Navios S.A.**  
Juan Carlos Gomez 1445 esc 701  
esquina 25 de Mayo  
Montevideo  
Montevideo  
11.000  
Uruguay  
**Contact:** Mr Pablo Soler Brusa,  
General Manager  
T: + 598 2 9163310  
F: + 598 2 9162874  
E: psoler@naviosterminals.com  
W: www.naviosterminals.com

### MONTEVIDEO

**Paysandu Coordinadora de Puertos Uruguay**  
Administración Nacional de Puertos  
Rambla 25 de Agosto de 1825 No 160  
Montevideo  
Uruguay  
**Contact:** Port Director  
T: + 598 2917 0731  
F: + 598 2916 0754  
E: info@puertos.com.uy  
W: http://puertos.com.uy

### MONTEVIDEO

**T.G.U.S.A Uruguayan Grain Terminals**  
Rondeau Ave 1908 .5  
Montevideo  
11800  
Uruguay  
**Contact:** Mr A Deambrosi,  
President  
F: + 598 2929 0603  
W: www.tgu.com.uy

### NUEVA PALMIRA

**Terminal Nueva Palmira**  
Ruta 12km  
Nueva Palmira  
Uruguay  
**Contact:** Mr R Grien,  
T: + 5982 628 80 59  
F: + 5982 628 65 62  
E: rgrien@anp.com.uy  
W: www.tgu.com.uy

### RIO NEGRO

**Terminal Fray Bentos**  
Puerto Fray Bentos  
Rio Negro  
Uruguay  
F: + 598 4562 7428  
W: www.tgu.com.uy

## USA

### ABERDEEN

**Pasha Stevedoring & Terminals LP**  
1620 E. Terminal Way  
Aberdeen  
WA  
98520  
USA  
**Contact:** Mr Tim Ryker, General  
Manager  
T: + 1 360 580 6623  
F: + 1 360 533 2695  
E: ghops@pssterminals.com  
W: http://pssterminals.com/  
**Location:** Washington State's west  
coast, 2 hour sailing time from open  
ocean  
**Equipment & Capacity:** Forklift -  
up to 34-ton capacity  
Yard Tractor - 5th wheel lifting  
capacity 70,000 lbs  
**Bulk Berths:** T-4 - 1,400ft of dock,  
800 lbs/cbft capacity  
T-2 - Grain terminal, loading rate of  
1,000mt/hr  
T-1 - Liquid bulk facility  
**Total Uncovered Storage:** >100

acres of outdoor secured storage  
**Total Covered Storage:** 3  
warehouses, totaling over 100,000  
sqft of storage space  
On dock rail available, 100' of apron  
width, warehouse storage in direct  
proximity to berth

### ABERDEEN

**Port of Grays Harbor**  
PO Box 660  
Aberdeen  
Washington  
98520-0141  
USA  
**Contact:** Mr Seth Taylor, Marine  
Terminal Manager  
T: + 1 360 533 9528  
F: + 1 360 533 9505  
E: staylor@portgrays.org  
W: www.portofgraysharbor.com  
**Location:** PNW North America  
**Equipment & Capacity:** Dry bulk  
loader 1200tph  
**Bulk Berths:** Terminal 2, 600', -  
41MLLW  
**Total Uncovered Storage:**  
160,000sqm  
**Total Covered Storage:** 6,500sqm

### ALBANY

**Albany Port District Commission**  
Administration Building  
Port of Albany  
Albany  
NY 12202  
USA  
**Contact:** Mr Rich Hendrick, General  
Manager  
T: + 1 518 463 8763  
F: + 1 518 463 8767  
E: Rhendrick@portofalbany.us  
W: www.Portofalbany.us  
**Location:** 124 miles north of New  
York Harbor on the Hudson River.  
**Equipment & Capacity:** Forklifts  
and cranes of various capacities.  
**Bulk Berths:** 1 grain berth of 228m  
in length with a draught of 9.45m  
and various multi-use berths.  
**Total Uncovered Storage:** 8 ha.  
**Total Covered Storage:** 27,900  
sqm

### ALEXANDRIA

**American Association of Port Authorities (AAPA)**  
1010 Duke Street  
Alexandria  
VA  
22314  
USA  
**Contact:** Mr Aaron Ellis, Public  
Affairs Director  
T: + 1 703 684 5700  
F: + 1 703 684 6321  
E: aellis@aapa-ports.org  
W: www.aapa-ports.org  
Trade association representing ports  
throughout the Western  
Hemisphere.

### AMA

**ADM Gromark-Destrehn**  
PO Box 120  
Ama  
LA 70031  
USA  
**Contact:** Ms Ruth Sacra,

T: + 1 504 431 8245  
F: + 1 504 431 7275  
E: ruth\_sacra@admworld.com

### ANACORTES

**Metro Ports**  
PO Box 406  
Anacortes  
WA  
98221  
USA  
**Contact:** Mr Geir Kalhagen,  
Director, Northern California &  
Pacific Northwest  
T: + 1 209 943 7252  
F: + 1 310 816 6519  
E: info@metroports.com  
W: www.metroports.com  
**Location:** Port of Anacortes

### ANACORTES

**Metro Ports**  
Pier 2  
Port of Anacortes  
Anacortes  
Washington  
98221  
USA  
**Contact:** Mr Sean Clancy, Terminal  
Manager  
T: + 1 360 299 2931  
F: + 1 360 299 3932  
E: Sean.clancy@metroports.com  
W: www.metroports.com  
**Location:** USA; Pacific Northwest  
**Equipment & Capacity:** 1,100  
MT/Hour shiploader (fixed)  
**Bulk Berths:** Max depth 13.4m,  
Wharf Length 140.8/345.3m  
(dolphine)  
Truck access; truck wash

### ANACORTES

**Port of Anacortes**  
100 Commercial Ave  
Anacortes  
WA  
98221  
USA  
**Contact:** Mr Josh Beaner, Director  
of Operations  
T: + 1 360 299 1828  
F: + 1 360 293 9608  
E: josh@portofanacortes.com  
W: www.portofanacortes.com  
**Location:** Pacific Northwest  
**Equipment & Capacity:** Mobile  
Bulk Outloader 450+ tph  
**Bulk Berths:** 1 berth, 465', 1,028'  
w/dolphins  
**Total Uncovered Storage:** 12.5  
acres  
**Total Covered Storage:** 0.75 acre  
We have two other terminals mainly  
used for lay status, port cruise  
vessels and Drop & Vac's.

### ANCHORAGE

**North Star Terminal Stevedore Company**  
PO Box 102019  
Anchorage  
AK 99501  
USA  
**Contact:** Mr Steve Post, Manager  
T: + 1 907 272 7537 X117  
F: + 1 907 272 8755  
W: www.northstarak.com

### ANCHORAGE

**Port of Anchorage**  
2000 Anchorage Port Road  
Anchorage  
Alaska  
AK 99501  
USA  
**Contact:** Mr Richard Wilson, Port  
Director  
T: + 1 907 343 6200  
F: + 1 907 277 5636  
E: port@ci.anchorage.ak.us  
W: www.portofalaska.com  
**Location:** Anchorage, Alaska

### ARABI

**Associated Terminals of St Bernard**



#### ASSOCIATED TERMINALS

8000 St. Bernard Hwy  
Reserve  
Arabi  
Louisiana  
70032  
USA  
**Contact:** Mr Zeljko Franks, Vice  
President  
T: + 1 504 277 5101  
F: + 1 504 279 8353  
E: zfranks@associatedterminals.com  
W: www.associatedterminals.com  
**Location:** Lower Mississippi River  
miles 86 to 91  
**Equipment & Capacity:** Fleet of  
midstream stevedoring cranes, dock  
cranes, conveyors, mobile  
equipment  
**Bulk Berths:** Four midstream  
berths, one set of mooring dolphins,  
and wharves for handling bulk and  
general cargoes  
**Total Uncovered Storage:** 150,000  
sq ft  
**Total Covered Storage:** 240,000 sq  
ft  
ATSB is the major terminal facility  
on the Mississippi River handling  
both bulk and breakbulk cargoes.  
Multiple docks and berths, as well  
as warehouses for bulk and  
breakbulk, rail and truck  
connections make ATSB the right  
choice for shippers.

### ARGO

**Kinder Morgan Terminals**  
Midwest Regional Office  
8500 West 68th Street  
Argo  
Illinois  
60501  
USA  
**Contact:** Mr Brian Feyereisen,  
Commercial Director  
T: + 1 708 496 2890  
F: + 1 708 496 2888  
E: Brian\_Feyereisen@  
kindermorgan.com  
W: www.kindermorgan.com

### BALTIMORE

**Baltimore Terminal**  
CNX Marine Terminals Inc.  
3800 Newgate Avenue  
Baltimore  
Maryland  
MD 21224-6404  
USA  
**Contact:** Mr Chris Marsh, Vice  
President  
T: + 1 410 631 6426  
F: + 1 410 631 6425  
E: chrismarsh@consolenergy.com  
W: www.consolenergy.com

### BALTIMORE

**CSX - Curtis Bay Coal Piers**  
Chesapeake Bay Area  
1910 Benhill Avenue  
Baltimore  
Maryland  
21226  
USA  
**Contact:** Mr Craig Blinker,  
T: + 1 410 355 6302  
F: + 1 410 355 2088  
E: Craig\_Blinker@csx.com

### BALTIMORE

**Maryland Port Administration**  
The World Trade Centre  
Baltimore  
Maryland  
21202-304

USA  
**Contact:** Mr Louis LoBianco,  
T: + 1 410 385 4455  
F: + 1 410 333 1126  
E: sras@mdot.state.md.us  
W: www.mpa.state.md.us

### BALTIMORE

**Port of Baltimore**  
Maryland Port Administration  
World Trade Center  
401 East Pratt Street  
Baltimore  
MD 21202-3041  
USA  
**Contact:** Mr Richard Scher, Director  
of Communications  
T: + 1 410 385 4483  
F: + 1 410 385 4485  
E: rscher@marylandports.com

### BALTIMORE

**Rukert Terminals Corp**  
2021 S. Clinton St  
PO Box 5163  
Baltimore  
MD  
21224  
USA  
**Contact:** Mr John Coulter,  
T: + 1 410 276 1013  
F: + 1 410 327 2315  
E: john@rukert.com  
W: www.rukert.com  
**Location:** Rukert Terminals is  
located on the Northwest branch of  
the Patapsco River, a tributary of  
the Chesapeake Bay. Baltimore  
gains great advantage over other  
East Coast ports with a geographic  
location that is closest to the U. S.  
Midwest.

**Equipment & Capacity:** 4 cranes  
1 Rapid discharge Bulk Unloader  
400tph  
2 175 ton Crawlers  
1 70 ton Mobile  
**Bulk Berths:** Pier 5 Bulk (PECO  
Gantry Crane) 875 feet 39.5 feet  
Lazaretto A Bulk / Break-Bulk /  
Containers 525 feet 35 feet  
Pier C Break-Bulk / Special Projects  
1000 feet 35  
**Total Uncovered Storage:** 160,000  
sqm  
**Total Covered Storage:** 112,000  
sqm  
Since 1921, Rukert Terminals  
Corporation has been a privately-  
owned and operated company  
which specializes in the handling of  
metals, ores, fertilizers, alloys, and  
other dry bulk and break-bulk  
cargoes. Services include  
stevedoring, warehousing, and  
transfer to and from vessel, rail or  
truck.

### BAYONNE

**Duraport Marine & Rail Terminal, LLC**  
PO Box 1009  
85 East 2nd Street  
Bayonne  
New Jersey  
07002  
USA  
**Contact:** Mr Vincent Alessi,  
President  
T: + 1 201 437 0703  
F: + 1 201 437 0158  
E: Vincent@AlessiOrg.com  
W: www.Duraport.Net  
**Location:** New York City  
Metropolitan Area  
**Equipment & Capacity:** 60 Car  
Rail Capacity with Rail Scale, 4  
Truck Scales  
**Bulk Berths:** 900' Bulkhead Deep  
Water  
Multi Modal Port Terminal

### BEAUMONT

**Beaumont Bulk Terminal Inc**  
1399 Carroll Street

Beaumont  
Texas 77701  
USA  
**Contact:** Mr Rusty Harris,  
T: + 1 409 839 4888  
F: + 1 409 835 0838  
E: dahrel\_harris@  
kindermorgan.com  
W: www.tgsgroup.com

### BEAUMONT

**Port of Beaumont**  
PO Drawer 2297  
1255 Main St  
Beaumont  
Texas  
USA  
**Contact:** Mr John Roby,  
Transportation Manager  
T: + 1 409 835 5367  
F: + 1 409 835 0512  
E: info@portofbeaumont.com  
W: www.portofbeaumont.com

### BELLE CHASSE

**Plaquemines Port**  
PO Box 547  
Belle Chasse  
LA  
70037  
USA  
**Contact:** Mr John L Pennison,  
Deputy Port Director  
T: + 1 504 682 7920  
F: + 1 504 682 0649  
E: plaqport@bellsouth.net  
W: www.portofplaquemines.com  
**Location:** Lower Mississippi River  
South of New Orleans, La., Mid-Gulf  
Coast

### BELLINGHAM

**Port of Bellingham**  
PO Box 1677  
1801 Roeder Avenue  
Bellingham  
WA  
98277  
USA  
**Contact:** Mr Dan Stahl, Director of  
Marine Services  
T: + 1 360 676 2500  
F: + 1 360 671 6411  
E: dans@portofbellingham.com  
W: www.portofbellingham.com  
**Location:** North Puget Sound - 15  
miles south of Canadian Border  
**Bulk Berths:** 1600 ft of berthing  
area of 32' depth  
**Total Uncovered Storage:** 35,000  
sqm  
**Total Covered Storage:** 8,000 sqm

### BENICIA

**Port of Benicia Authority**  
PO Box 315  
Benicia  
CA  
94510  
USA  
**Contact:** Mr Jimmy Triplett, Port  
Manager  
T: + 1 707 745 2394  
F: + 1 707 746 1485  
E: jtriplett@amports.com  
W: www.amports.com  
**Location:** San Francisco Bay Area,  
California, USA

### BOSTON

**Massport Maritime Department**  
One Harborside Drive  
Boston  
MA  
02128-2909  
USA  
**Contact:** Ms Lynn Vikesland,  
Market Research Manager  
T: + 1 617 946 4445  
F: + 1 617 946 4466  
E: lvikesland@massport.com  
W: www.massport.com

CT  
06604  
USA  
**Contact:** Mr Joseph C Savino Jnr,  
Harbour Master  
T: + 1 956 831 4592  
F: + 1 956 831 5006  
E: [bjpt.port.auth@snet.net](mailto:bjpt.port.auth@snet.net)  
W: [www.portcomneticut.com](http://www.portcomneticut.com)

## BROWNSVILLE

**Port of Brownsville**  
1000 Foust Rd.  
Brownsville  
Texas  
78521  
USA  
**Contact:** Mr Eduardo Campirano,  
CEO & Port Director  
T: + 1 956 831 4592  
F: + 1 956 831 5006  
E: [ecampirano@portofbrownsville.com](mailto:ecampirano@portofbrownsville.com)  
W: [www.portofbrownsville.com](http://www.portofbrownsville.com)  
**Location:** The Port of Brownsville is located at the southernmost tip of Texas on the U.S. -Mexico border. The 17-mile long channel flows into the Gulf of Mexico at the Brazos Santiago Pass. The Port of Brownsville is the only deepwater port located on the U.S. and Mexico border.

**Equipment & Capacity:** - Derrick barges: two 150-ton, one 275-ton, and one 700-ton.  
- Twelve 90-ton mobile cranes  
- Two 120-ton mobile harbor cranes  
**Storage:**  
100 acres open, bulk liquids over 3.4 million barrels; 635,000 sq. ft. covered, transit sheds; 4 million bushel grain elevator; Foreign Trade Zone 62: site zoning.

**Bulk Berths:** 11 Bulk Cargo Docks; 8 storage sheds at Bulk Cargo Docks, 6 open storage areas (patios); 42 ft. Authorized Depth Channel, with a current Feasibility Study to deepen to 52 ft.; 36 ft. Authorized Depth Turning Basin.  
**Total Uncovered Storage:** 3+ million sq. ft. open storage  
**Total Covered Storage:** 635,000 sq. ft. covered storage  
The Port of Brownsville is the largest land owner public port authority in the U.S. The port is grantee for Foreign Trade Zone No. 62, which ranks No. 2 nationally in exports.

## BRUNSWICK

**Marine Port Terminals Inc**  
225 Newcastle Street  
Brunswick  
GA  
31520  
USA  
**Contact:** Mr David Proctor, Terminal Manager  
T: + 1 912 264 4044 x238  
F: + 1 912 267 6352  
E: [dproctor@logistec.com](mailto:dproctor@logistec.com)

## BUFFALO

**Port of Buffalo**  
Gateway Metroport  
PO Box 880  
2544 Clinton Street  
Buffalo  
New York  
14224  
USA  
**Contact:** Mr Jim Pfohl, Port Director  
T: + 1 716 826 2890  
F: + 1 716 826 1342  
E: [jpfohl@buffalocrushedstone.com](mailto:jpfohl@buffalocrushedstone.com)  
**Location:** Lackawanna, New York south of Buffalo on Lake Erie.  
**Total Uncovered Storage:** 60,000 sqm  
**Total Covered Storage:** None currently available.

## BURLINGAME

**Ports America**  
1270 Drake Avenue  
Burlingame  
CA  
94010  
USA  
**Contact:** Mr Gregory White, Chief Commercial Officer  
T: + 1 732 635 3818  
F: + 1 201 216 9393  
E: [corporate@portsamerica.com](mailto:corporate@portsamerica.com)  
W: [www.portsamerica.com/](http://www.portsamerica.com/)  
**Location:** US West Coast, South & Mid-Atlantic

## CAMDEN

**Delaware River Port Authority**  
One Port Centre  
2 Riverside Drive  
Camden  
NJ 08101  
USA  
**Contact:** Mr Raymond A Lawler, Asst. Director  
T: + 1 856 968 2000  
F: + 1 856 968 2226  
E: [info@lists.drpa.org](mailto:info@lists.drpa.org)

## CAMDEN

**South Jersey Ports Corp**  
PO Box 129  
2500 Broadway  
Camden  
NJ  
08104  
USA  
**Contact:** Mr Joseph A Balzano,  
T: + 1 856 757 4969  
F: + 1 856 757 4903  
E: [sjpc@southjerseyport.com](mailto:sjpc@southjerseyport.com)

## CANONSBURG

**CONSOL Energy Inc.**  
CNX Center  
1000 Consol Energy Drive  
Canonsburg  
PA 15317-6506  
USA  
**Contact:** Mr Jim Latham, General Manager  
T: + 1 410 631 6426  
E: [patrickmangin@consolenergy.com](mailto:patrickmangin@consolenergy.com)  
W: [www.consolenergy.com](http://www.consolenergy.com)

## CAPE CANAVERAL

**Port Canaveral**  
Canaveral Port Authority  
445 Challenger Road  
Suite 301  
Cape Canaveral  
FL 32920  
USA  
**Contact:** Ms Samantha Cornelius,  
Director - Cargo Business Development  
T: + 1 321 394 3211  
F: + 1 321 783 3748  
E: [SCornelius@portcanaveral.com](mailto:SCornelius@portcanaveral.com)  
W: [www.portcanaveral.com](http://www.portcanaveral.com)  
**Location:** Center of State of Florida, on Atlantic Ocean; due East of Orlando  
**Equipment & Capacity:** Bulk conveyors, breakbulk facilities available, waterfront refrigerated warehousing. Land available.  
**Bulk Berths:** South Cargo Piers 4 & 5 at 12 meters draught MLW  
North Cargo Piers 1, 2, 3, & 4 at 12 meters draught MLW  
**Total Uncovered Storage:** 101,175sqm  
**Total Covered Storage:** 70,000sqm  
We've handled bulk and breakbulk since 1955. See our website [www.portcanaveral.com](http://www.portcanaveral.com) for more information.

## CARTERET

**Kinder Morgan Liquid Terminals, LLC**  
1 Terminal Road  
Carteret  
New Jersey 07008  
USA  
**Contact:** Mr Scott Johnston,  
Director, Business Development  
T: + 1 732 969 5721  
F: + 1 732 969 3575  
E: [scott.johnston@kindermorgan.com](mailto:scott.johnston@kindermorgan.com)

## CARUTHERSVILLE

**Pemiscot County Port Authority**  
111 E 3rd Street  
Caruthersville  
MO 63830  
USA  
**Contact:** Mr John Ferguson II,  
Director  
T: + 1 573 333 4125  
F: + 1 573 333 4216  
E: [john@pemiscotport.com](mailto:john@pemiscotport.com)  
W: [www.pemiscotport.com](http://www.pemiscotport.com)  
**Location:** Lower Mississippi River mile 849.9

**Equipment & Capacity:** Public dock; tower crane  
**Bulk Berths:** Nine (9) barge berths  
Rail access; two interstate highways; many large available sites

## CATOOSA

**Gavilon Fertilizer, LLC**  
5640 W Channel Road  
Catoosa  
Oklahoma  
74015  
USA  
**Contact:** Mr Matt Benda, Terminal Manager  
T: + 1 918 266 1244  
F: + 1 918 266 6129  
E: [matthew.benda@gavilon.com](mailto:matthew.benda@gavilon.com)  
**Location:** River mile 445 on the Arkansas River  
**Total Covered Storage:** 70,000t  
Other commodities handled: salt

## CATOOSA

**Tulsa Port of Catoosa**  
5350 Cimarron Road  
Catoosa  
OK 74015 - 3027  
USA  
**Contact:** Mr Robert W Portiss, Port Director  
T: + 1 918 266 2291  
F: + 1 918 266 7678  
E: [bob@tulsaport.com](mailto:bob@tulsaport.com)  
W: [www.tulsaport.com](http://www.tulsaport.com)  
**Location:** Central US.  
**Equipment & Capacity:** See website  
**Bulk Berths:** See website  
**Total Uncovered Storage:** 10 acres  
**Total Covered Storage:** 80,000 short tons

## CEREDO

**Kanawha River Terminal Inc**  
Main and River  
PO Box 308  
Ceredo  
West Virginia 25507  
USA  
**Contact:** Mr Matt Gaston, Manager  
T: + 1 304 526 0753  
F: + 1 304 453 5521

## CHARLESTON

**Kinder Morgan Terminals**  
1500 Greenleaf Street  
Charleston  
South Carolina  
29405  
USA  
**Contact:** Mr Wilson J. Browning,  
Commercial Director, Southeast Region  
T: + 1 843 577 2073  
F: + 1 843 722 5720  
E: [Wilson\\_Browning@Kindermorgan.com](mailto:Wilson_Browning@Kindermorgan.com)

W: [www.kindermorgan.com](http://www.kindermorgan.com)  
**Location:** 155 terminals nationwide across USA  
Please contact  
[Wilson\\_Browning@Kindermorgan.com](mailto:Wilson_Browning@Kindermorgan.com)  
for specifics on a given terminal/location.

## CHARLESTON

**Port of Charleston**  
South Carolina State Ports Authority  
PO Box 22287  
Charleston  
SC  
29413  
USA  
**Contact:** Mr Fred Stribling, VP Marketing & Sales  
T: Port of Bellingham  
F: + 1 843 577 8710  
E: [SCSPAMktg\\_Sales@scspa.com](mailto:SCSPAMktg_Sales@scspa.com)

## CHARLESTON

**Stevens Shipping & Terminal Co**  
PO Box 22826  
Charleston  
SC 29413-2826  
USA  
**Contact:** Mr Norman Massey,  
Operations Manager  
T: + 1 912 651 4000  
F: + 1 843 527 4577

## CHARLOTTE

**CSX World Terminals**  
2101 Rexford Road  
Suite 250 West  
Charlotte  
North Carolina 28211  
USA  
**Contact:** Mr Bert De Piper, Senior Vice President, Chief  
T: + 1 704 973 7200  
F: + 1 704 973 7246  
W: [www.csxwt.com](http://www.csxwt.com)

## CHESAPEAKE

**Kinder Morgan Elizabeth River Terminals**  
4100 Buell Street  
Chesapeake  
VA 23324  
USA  
**Contact:** Ms Jennifer Darden,  
T: + 1 757 543 0335  
F: + 1 757 543 8936  
E: [jennifer\\_darden@kindermorgan.com](mailto:jennifer_darden@kindermorgan.com)  
W: [www.kindermorgan.com](http://www.kindermorgan.com)  
**Location:** Southern Branch Elizabeth River  
**Bulk Berths:** 2x 100' berths @ 35'  
**Total Uncovered Storage:** 110 acre terminal  
**Total Covered Storage:** Over 600,000 sq feet  
Storage and handling, including valve added services, of dry bulk materials.

## CHICAGO

**Illinois International Port District**  
3600 East 95th Street  
Chicago  
IL 60617  
USA  
**Contact:** Mr Clayton Harris III,  
Executive Director  
T: + 1 773 646 4400  
F: + 1 773 221 7678  
E: [iipd@iipd.com](mailto:iipd@iipd.com)  
W: [www.iipd.com](http://www.iipd.com)  
**Location:** South of Chicago on Lake Michigan and the Calumet River.

## CHICAGO

**KCBX Terminals Company**  
10730 South Burley Ave.  
Chicago  
IL

60617  
USA  
**Contact:** Mr Tom Kramer, General Manager  
T: + 1 773 933 5302  
F: + 1 773 933 5309  
E: [kramer@kochind.com](mailto:kramer@kochind.com)  
**Location:** 108th Street & Calumet River, Chicago, IL  
**Equipment & Capacity:** Rotary dump 2,000tph unloading system  
Bottom dump 2,000 tph unloading system  
Single 1,500 tph ship loader  
6,000,000t annual capacity  
**Bulk Berths:** Single loading berth 800ft length  
**Total Uncovered Storage:** 2,000,000t  
River barge unloading and loading services.

## CHICAGO

**North American Stevedoring Company LLC**  
Iroquois Landing Terminal  
9301 South Kreiter Avenue  
Port of Chicago  
Chicago  
Illinois  
60617-6465  
USA  
T: + 1 773 734 4885  
F: + 1 773 734 4831  
E: [info@qsl.com](mailto:info@qsl.com)  
W: [www.qsl.com/en/port/chicago.html](http://www.qsl.com/en/port/chicago.html)  
**Location:** 20km from Chicago, at the mouth of the Calumet River.  
**Equipment & Capacity:** Reach stackers, forklifts, mobile cranes, overhead cranes.  
**Bulk Berths:** Length: 823.17m, Draught 8.23m  
**Total Uncovered Storage:** 365,000sqm  
**Total Covered Storage:** Warehouses: 22,000sqm, Climate Controlled Building: 2,375sqm  
100 acres of additional outside storage space next to the terminal are available for future development.

## CLEVELAND

**Port of Cleveland**  
1375 E. 9th Street  
#2300  
Cleveland  
Ohio  
44114-1786  
USA  
**Contact:** Mr Eric Hirsimaki,  
Marketing  
T: + 1 216 241 8004  
F: + 1 216 241 8016  
E: [eric.hirsimaki@portofcleveland.com](mailto:eric.hirsimaki@portofcleveland.com)  
W: [www.portofcleveland.com](http://www.portofcleveland.com)  
**Location:** Downtown Cleveland, Ohio USA on Lake Erie  
**Equipment & Capacity:** 4 Cranes to 150 tons  
**Bulk Berths:** Cleveland Bulk Terminal: 300m length, 8.3m depth  
**Total Uncovered Storage:** 40 hectares  
**Total Covered Storage:** 35000sqm  
Good rail and road access

## CONNEAUT

**Pittsburgh & Conneaut Dock Co.**  
950 Ford Ave  
Conneaut  
Ohio  
44030  
USA  
**Contact:** Mr James Rogers, Senior Manager of Dock Operations  
T: + 1 440 599 0242  
F: + 1 440 599 0245  
E: [James.Rogers@cnworldwide.com](mailto:James.Rogers@cnworldwide.com)  
W: [www.cn.ca](http://www.cn.ca)  
**Location:** West Of Erie Pa. on Lake Erie

Erie  
USA  
**Equipment & Capacity:** 4 reclaimers and 4 stackers  
**Total Uncovered Storage:** 5 million sqm

## CONVENT

**Associated Terminals LLC**



**ASSOCIATED TERMINALS**  
9100 Safety Dr. Street  
Convent  
LA  
70723  
USA  
**Contact:** Mr Todd Fuller, Sr. Vice President  
T: + 1 985 536 4520  
F: + 1 985 536 4521  
E: [todd@associatedterminals.com](mailto:todd@associatedterminals.com)  
W: [www.associatedterminals.com](http://www.associatedterminals.com)  
**Location:** Lower Mississippi River miles 56.8 to 141.5  
**Equipment & Capacity:** Fleet of high-capacity floating cranes plus mobile equipment  
**Bulk Berths:** 12 midstream berths  
**Total Uncovered Storage:** 427,000 sq ft  
**Total Covered Storage:** 536,000 sq ft  
Associated Terminals is one of the largest midstream stevedoring companies on the Mississippi River, operating a fleet of twelve high capacity floating cranes. The company transloads cargo to and from vessels and barges at twelve mid-stream anchorage facilities on the lower Mississippi, as well as at additional dockside and on-site locations.

## CONVENT

**IC RailMarine Terminal (ICRMT)**  
7790 LA, Highway 44  
Convent  
LA  
70723  
USA  
**Contact:** Mr Bruce Conti, President  
T: + 1 225 562 5201  
F: + 1 225 562 9948  
E: [bruce.conti@cn.ca](mailto:bruce.conti@cn.ca)  
**Location:** MP 161.0 AHP Mississippi River (East bank between Baton Rouge and New Orleans)  
**Equipment & Capacity:** IMPSA Ship Unloader - 1500 Mtp, Gottwald Ship Unloader - 900 Mtp, Metaina Traveling Ship Loader-2700 Mtp, EMS Tech Barge Loader - 450 Mtp (all nameplate rates)  
**Bulk Berths:** Vessels 850' LOA-Beam 150'  
**Total Uncovered Storage:** 34 acres - two pads - 1.2 million tons  
**Total Covered Storage:** none  
Italmimpianti Traveling Radial Stacker, Heyl & Patterson Rotary/Bottom Car Dumper, Kanawha Railcar Batch Loader, 130 Railcar Unit Train Loop Track. Railroad: Canadian National Railroad

## CONVENT

**St. James Stevedoring Partners, LLC**  
9100 Safety Drive  
Convent  
LA  
70723  
USA  
**Contact:** Mr John C Crane, Vice President  
T: + 1 225 562 3918  
F: + 1 225 562 3515  
E: [jcrane@sjustevedore.com](mailto:jcrane@sjustevedore.com)  
W: [www.sjustevedore.com](http://www.sjustevedore.com)  
**Location:** Mississippi River, Texas



# EXCELLENCE

is **ASSOCIATED** with **US.**



When it comes to the movement of bulk, breakbulk and project cargo along the Lower Mississippi River, turn to Associated Terminals. We have assembled a team of experts and invested in modern facilities, equipment and related assets to best service your cargo shipping needs. Add to that our total commitment to safety and it is easy to see that Associated Terminals is an excellent choice for all of your cargo handling and logistical solutions.

[www.associatedterminals.com](http://www.associatedterminals.com)



Gulf  
**Equipment & Capacity:** 8 Gottwald Floating Cranes  
**Bulk Berths:** 6 midstream berths for handling up to cape sized vessels  
 St. James operates a coal auger barge for obtaining mechanical coal samples.

## COOS BAY

**Oregon International Port of Coos Bay**  
 PO Box 1215

Coos Bay  
 OR  
 97420  
 USA  
**Contact:** Mr John Burns, CEO  
 T: + 1 541 267 7678  
 F: + 1 541 269 1475

E: jburns@portofcoosbay.com  
 W: www.portofcoosbay.com  
**Location:** Southwest Oregon Coast in United States  
**Equipment & Capacity:** An average of 1.5 million tons of cargo is exported out of Coos Bay annually.

There are multiple terminals along the Coos Bay harbor, shipping forest products such as bulk break logs and wood chips.

## CORA

**Kinder Morgan Terminals - Cora**

Mid Atlantic Regional Office  
 1801 Milford Street  
 Charleston  
 South Carolina  
 29405  
 USA

**Contact:** Mr Brian Feyereisen,  
 T: + 1 843 853 0453  
 F: + 1 843 853 7971  
 E: brian\_feyereisen@kindermorgan.com  
 W: www.kindermorgan.com

## CORDOVA

**Port of Cordova**

P.O.Box 1210  
 Cordova  
 Alaska  
 AK 99574  
 USA  
**Contact:** Mr Dale R Muma, Port Director  
 T: + 1 907 4246400  
 F: + 1 907 4246000  
 E: harbor@cityofcordova.net

## CORPUS CHRISTI

**Boyd-Campbell Company**

210 S. Carancahua  
 Suite 620  
 Corpus Christi  
 Texas  
 78401  
 USA

**Contact:** Mr Sonny Boyd, Manager/Agent  
 T: + 1 361 884 9321  
 F: + 1 361 884 9067  
 E: eagency@boyd-campbell.com  
**Location:** Corpus Christi and Point Comfort, Texas, USA

**Equipment & Capacity:** Stevedore bulk cargoes, break bulk cargoes and heavy lift cargoes.  
**Bulk Berths:** Bulk Materials Dock #1 - one rolling gantry crane with grab bucket that can be used for loading or unloading bulk cargoes. Bulk Materials Dock #2 - one radial loader.

**Total Uncovered Storage:** Port owned property may be leased short term or long term.  
 Port public pads for bulk cargoes at Bulk Handling Terminal .  
 Large amounts of pads for break bulk cargo in South and North Side Cargo Terminals.

**Total Covered Storage:** Limited private covered storage for bulk cargoes.

Port has 1 large covered storage area in their North Side Cargo Terminal and 2 large covered storage areas in their South Side Cargo Terminal that can be used for bulk or break bulk cargoes.  
 North and South Side Cargo Terminals have wide aprons or open docks for discharge direct to trucks or rail.

## CORPUS CHRISTI

**Port Corpus Christi**

222 Power Street  
 Corpus Christi  
 TX  
 78403  
 USA

**Contact:** Mr Ruben C Medina, Director Business Development  
 T: + 361 885 6109  
 F: + 361 882 7110  
 E: RubenM@pocca.com  
 W: www.portofcorpuschristi.com  
**Location:** Corpus Christi, Texas, USA

**Equipment & Capacity:** Gantry Crane & one Liebherr Terex 100t crane  
**Bulk Berths:** Ships' LOA 835', Dock length 400'  
**Total Uncovered Storage:** 20 acres

**Total Covered Storage:** NIL  
 Alongside draught 35', Channel draught 45'

## CORPUS CHRISTI

**Port of Corpus Christi - Bulk Terminal**

PO Box 1541  
 222 Power Street  
 Corpus Christi  
 TX  
 78403  
 USA

**Contact:** Mr Paul (Skip) Kaup, Bulk Terminal Manager  
 T: + 1 361 883 1162  
 F: + 1 361 883 1652  
 E: paulg@pocca.com  
 W: www.portofcorpuschristi.com  
**Location:** Gulf of Mexico  
**Equipment & Capacity:** Gantry Crane 600tph. Shiploader 1,500tph  
**Bulk Berths:** Depth: 45'

## CORPUS CHRISTI

**Public Elevator**

PO Box 2229  
 Corpus Christi  
 TX 78403  
 USA

**Contact:** Mr Ed Altemus, Director of Trade  
 T: + 1 361 882 1456  
 F: + 1 361 882 1998

## CORPUS CHRISTI

**Sherwin Alumina, L.P.**

PO Box 9911  
 Corpus Christi  
 Texas  
 78469  
 USA

**Contact:** Mr Josh Autenrieth, Port Superintendent  
 T: + 1 361 7772434  
 F: + 1 361 7772347  
 E: raabrajano@sherwinalumina.com

## DARROW

**Impala Terminals**

4258 Highway 44  
 Darrow  
 LA  
 70725  
 USA

**Contact:** Mr Mike Tenchuk, CEO  
 T: + 1 225 289 5211  
 F: + 1 225 474 3719

E: mike.tenchuk@ormet.com  
 W: www.impalaterminals.com/

## DECATUR

**ARTCO**

4666 Faries Parkway  
 Decatur  
 IL  
 62526  
 USA

**Contact:** Mr Kevin Van Meter, Director  
 T: + 1 217 424 5556  
 F: + 1 217 451 4122  
 E: kevin.vanmeter@adm.com  
 W: www.admworld.com

## DECATUR

**Kinder Morgan Terminals - Decatur**

Lower River Regional Office  
 7116 Highway 22  
 PO Box 625  
 Sorrento  
 LA  
 70778-0625  
 USA

**Contact:** Mr Hans Luetkemeier, Commercial Director  
 T: + 1 225 675 0308  
 F: + 1 225 675 8259  
 E: hans\_luetkemeier@kindermorgan.com  
 W: www.kindermorgan.com/  
 bulk\_terminals/

## DETROIT

**Detroit / Wayne County Port Authority**

8109 E. Jefferson Ave.  
 Detroit  
 MI  
 48214  
 USA

**Contact:** Miss Cheryl Solomon, Marketing Director  
 T: + 1 313 331 3842x310  
 F: + 1 313 331 5457  
 E: solomon@portdetroit.com  
 W: www.portdetroit.com

## DETROIT

**Port of Detroit**

8109 Jefferson Avenue  
 Detroit  
 Michigan  
 48214  
 USA

**Contact:** Ms Cheryl Graham Solomon, Marketing Director  
 T: + 1 313 331 3842 ext 310  
 F: + 1 313 331 5457  
 E: solomon@portdetroit.com  
 W: www.portdetroit.com

## DULUTH

**AGP Grain Limited**

602 Arthur Avenue  
 Duluth  
 MN  
 55802-2602  
 USA

**Contact:** Superintendent  
 T: + 1 218 722 0538  
 F: + 1 218 722 0076  
 E: info@agp.com  
 W: www.agp.com/

## DULUTH

**Duluth Seaway Port Authority**

1200 Port Terminal Drive  
 Duluth  
 MN 55802-2609  
 USA

**Contact:** Ms Adele Yorde, Public Relations Director  
 T: + 1 218 727 8525  
 F: + 1 218 727 6888  
 E: ayorde@duluthport.com  
 W: www.duluthport.com  
**Location:** Western-most tip of Lake Superior and the Great Lakes/ Saint

Lawrence Seaway System in North America.

**Bulk Berths:** 20 privately owned/operated commercial docks: 10 bulk cargo, 2 ore docks, 1 coal terminal, 7 grain elevators; 1 fueling depot; tug/barge services; plus 1 breakbulk terminal.  
 On average, the Port of Duluth-Superior sees nearly 900 vessel calls and handles 35 million net tons each year with principal cargoes: iron ore, coal, grain, limestone, cement, salt and other commodities plus heavy-lift and project cargo.

## DULUTH

**General Mills Elevator A**

200 Garfield Ave.  
 Duluth  
 MN  
 55802  
 USA

**Contact:** Mr Douglas Christiansen, General Manager  
 T: + 1 218 722 7759  
 F: + 1 218 727 7956  
 E: doug.christiansen@genmills.com

## DULUTH

**Krech Ojard & Assoc**

227 W 1st St  
 Suite 200  
 Duluth  
 Minnesota  
 55082  
 USA

**Contact:** Mr Kevin Ehrenreich, Director Infrastructure Services  
 T: + 1 218 727 3282  
 F: + 1 218 727 1216  
 E: kevin.ehrenreich@krechojard.com  
 W: www.krechojard.com

## EAST LIVERPOOL

**Columbiana County Port Authority**

1250 St. George Street  
 East Liverpool  
 Ohio  
 43920  
 USA

**Contact:** Ms Penny J Traina, Executive Director/CEO  
 T: + 1 330 386 9051  
 F: + 1 330 386 1122  
 E: ccpa@ccpa-ohiover.com  
 W: www.ccpa-ohiover.com

**Location:** Wellsville Intermodal Facility - Ohio River mile Post 48. Pittsburgh-Cleveland Area.

**Equipment & Capacity:** 60 ton bridge crane/bulk/rail access  
**Bulk Berths:** Conveyor System/Material Handler Operator.  
 Pier 48 Stevedoring, LLC  
 Larry Heck, Owner/President  
 100 Albright Way/PO Box 32  
 Wellsville OH 43968  
 Call: 330-853-3533  
 lheck@pier48.org

## EASTPORT

**Eastport Port Authority**

PO Box 278  
 3 Madison Street  
 Eastport  
 ME  
 04631  
 USA

**Contact:** Mr Christopher Gardner, Executive Director  
 T: + 1 207 853 4614  
 F: + 1 207 583 9584  
 E: eportauth@maine.com  
 W: www.portofeastport.org

## ERIE

**Mount Fort Terminal**

PO Box 179  
 2 East Bay Drive  
 Erie

PA  
 16512-0179  
 USA

**Contact:** Mr Callaghan, Terminal Manager  
 T: + 1 814 453 6721  
 F: + 1 814 453 5138  
 E: dtodeagleton@aol.com

## EUREKA

**Humboldt Bay Harbour District**

P.O.Box 1030  
 Eureka  
 California  
 CA 95502-1030  
 USA

**Contact:** Mr David Hull, Chief Executive Officer  
 T: + 1 707 4430801  
 F: + 1 707 443080  
 E: info@portofhumboldtby.org

## EVANSVILLE

**Kinder Morgan Terminals - Evansville**

Midwest Regional Office  
 8500 West 68th Street  
 Argo  
 Illinois  
 60501  
 USA

**Contact:** Mr Roy Cook,  
 T: + 1 414 769 1901 ext-120  
 F: + 1 414 769 1144  
 E: roy\_cook@kindermorgan.com  
 W: www.kindermorgan.com

## EVERETT

**Port of Everett**

PO Box 538  
 Everett  
 WA  
 98206  
 USA

**Contact:** Ms Lisa Lefebvre, PR/Communication Administrator  
 T: + 1 425 259 3164  
 F: + 1 425 252 7366  
 E: lisam@portofeverett.com  
 W: www.portofeverett.com

**Location:** West Coast of USA  
**Equipment & Capacity:** Lift up to 100 tons  
**Bulk Berths:** 7  
**Total Covered Storage:** 36,000 sq ft  
 2 x 40 LT Mitsubishi Gantry Cranes will be in service year 2005.

## FIELDS LANDING

**Port of Eureka**

Fields Landing  
 PO Box 266  
 Fields Landing  
 CA 95537  
 USA

**Contact:** Mr Slamwood A Murphy Jnr, Port Owner  
 T: + 1 707 443 5631  
 F: + 1 707 443 3553  
 W: www.humboldtby.org

## FORT LAUDERDALE

**Port Everglades Department of Broward County**

1850 Eller Drive  
 6th Floor Administration Building  
 Fort Lauderdale  
 FL  
 33316  
 USA

**Contact:** Ms Ellen Kennedy, Assistant Director/Communications  
 T: + 1 954 523 3404  
 F: + 1 954 525 1910  
 E: portevergladescargo@broward.org  
 W: www.co.broward.fl.us/port.htm

## FRESNO

**Penny Newman Grain Co**

PO Box 12147

Fresno  
 California  
 93776  
 USA

**Contact:** Mr Mike Nicoletti,  
 T: + 1 559 448 8800  
 F: + 1 559 448 0500  
 E: mike@penny-newman.com

## GALVESTON

**Farmland Elevator G**

3100 Wharf Rd  
 PO Box 2647  
 Galveston  
 Texas  
 77553  
 USA

**T: + 1 409 763 6447  
 F: + 1 409 763 8608**

## GALVESTON

**Metro Ports**

306 Kempner Street  
 Suite 300  
 Galveston  
 TX  
 77550  
 USA

**Contact:** Mr Matt Woolen, General Manager  
 T: + 1 409 762 8131  
 F: + 1 409 762 1006  
 E: matt.woolen@metroports.com  
 W: www.metroports.com

**Location:** Port of Galveston

## GALVESTON

**Port of Galveston**

PO Box 328  
 Galveston  
 Texas  
 77553  
 USA

**Contact:** Captain John G Peterlin III, Senior Director of Marketing  
 T: + 1 409 766 6112  
 F: + 1 409 766 6107  
 E: jpeterlin@portofgalveston.com  
 W: www.portofgalveston.com

## GEORGETOWN

**Liberty Terminals, LLC**

PO Box 1498  
 Georgetown  
 29442  
 USA

**Contact:** Mr Perrt R Collins, Managing Member  
 T: + 1 843 527 1743  
 F: + 1 843 527 1743  
 E: sc@liberty-terminals.com

## GEORGETOWN

**Port of Georgetown**

South Carolina State Ports Authority  
 PO Box 601  
 1324 Dock Street, Pier 31  
 Georgetown  
 SC  
 29440  
 USA

**Contact:** Mr L David Schronce, Director  
 T: + 1 843 527 4476  
 F: + 1 843 527 2601  
 E: dschronce@scspa.com

## GEORGETOWN

**Stevedoring Services of America (SSA)**

609 Kaminski Street  
 Georgetown  
 SC  
 29442  
 USA

**Contact:** Mr Buddy Wiggins, Operations Manager  
 T: + 1 843 971 2900  
 F: + 1 843 971 2919  
 E: buddy.wiggins@ssamarine.com



**GEORGETOWN**

**Winyah Stevedoring Inc**  
PO Box 1498  
Georgetown  
SC  
29442  
USA  
**Contact:** Mr Perry Collins,  
T: +1 843 527 2823  
F: +1 843 527 1179

**GEORGETOWN**

**WSI of the Southeast llc**  
PO Box 1498  
Georgetown  
SC  
29442  
USA  
**Contact:** Mr Perry Collins, General  
Manager  
T: +1 843 527 2823  
F: +1 843 527 1179  
E: perry.collins@wsijason.com  
W: www.wsijason.com

**GLEN CARBON**

**Mobilc Grain**  
20A Kettle River Drive  
Glen Carbon  
IL  
62034  
USA  
**Contact:** Mr Sheldon Affleck,  
President  
T: +1 618 655 1201  
F: +1 618 656 1363  
E: sheldon.affleck@mobilgrain.com

**GREEN BAY**

**Port of Green Bay**  
Brown County  
2561 S. Broadway Street  
Green Bay  
WI  
54304  
USA  
**Contact:** Mr Dean Haen, Port  
Manager  
T: +1 920 492 4950  
F: +1 920 492 4957  
E: haen\_dr@co.brown.wi.us  
W: www.portofgreenbay.com

**GRETNA**

**Associated Grain Terminals**  
848 Behrman Hwy  
Gretna  
Louisiana  
70053  
USA  
**Contact:** Mr Bill Sullivan, Terminal  
Manager  
T: +1 985 536 4520  
F: +1 985 536 4521  
E: bill@associatedterminals.com  
W: www.associatedterminals.com  
**Location:** Lower Mississippi River  
miles 56 to 58  
**Equipment & Capacity:** Floating  
grain elevator and fleet of  
midstream stevedoring cranes.  
**Bulk Berths:** Three midstream  
berths  
**Total Uncovered Storage:** 0  
**Total Covered Storage:** 0  
AGT offers a flexible and reliable  
one-stop shop for moving bulk cargo  
on the Lower Mississippi. Short  
vessel transit times make this an  
ideal port to move cargo efficiently  
at midstream berths.

**GULFPORT**

**Mississippi State Port  
Authority at Gulfport**  
One Hancock Plaza  
Suite 1401  
Gulfport  
MS  
39501/39502  
USA  
**Contact:** Mr John H Webb, Deputy  
Director of Engineering  
T: +1 228-865 4300

F: +1 228-865 4335  
E: jwebb@shipmspa.com  
W: www.shipmspa.com

**HILO**

**Hilo Harbor**  
Department of Transportation  
Harbours Division  
80 Kuhio Street  
Hilo  
HI  
96720  
USA  
**Contact:** Mr Jeff D Hood, District  
Manager  
T: +1 808 933 8850  
F: +1 808 933 8851  
E: Jeff.Hood@hawaii.gov

**HILO**

**State of Hawaii, Department  
of Transportation**  
Harbours Division, Hawaii District  
Hilo  
HI  
96720  
USA  
**Contact:** Mr Jeff D. Hood, District  
Manager  
T: +1 808 933 8850  
F: +1 808 933 8851  
E: jeff.d.hood@hawaii.gov  
W: www.state.hi.us/dot/harbors  
**Location:** Hawaii Island  
**Equipment & Capacity:** None  
**Bulk Berths:** 1265 feet  
**Total Uncovered Storage:** n/a  
**Total Covered Storage:** n/a  
Hawaii Island Harbors District has  
two ports, Hilo & Kawaihae. Hilo is  
on the east side & Kawaihae is on  
the west side of the island.

**HOMER**

**City of Homer Port and  
Harbor**  
4350 Homer Spit Road  
Homer  
Alaska  
99603  
USA  
**Contact:** Mr Bryan Hawkins, Port  
Director/Harbor Master  
T: +1 907 235 3160  
F: +1 907 235 3152  
E: port@ci.homer.ak.us  
W: www.cityofhomer-ak.gov/port  
**Location:** End of Homer Spit in  
Kachemak Bay, Alaska  
**Equipment & Capacity:** Small  
Harbor with 920 reserved stalls and  
over 6,000 linear feet of transient  
moorage available; Port consisting  
of two commercial docks; Fish dock  
for loading/unloading seafood

**HONOLULU**

**Honolulu Port Authority**  
700 Fort Street  
Honolulu  
HI  
96813  
USA  
**Contact:** Mr Scott Cunningham,  
Harbour Master  
T: +1 808 587 2050  
F: +1 808 587 2065  
E: dotpao@hawaii.gov  
W: www.ehawaii.gov/dakine/index.html  
**Location:** Pier 23  
South coast of island of Oahu  
**Bulk Berths:** Max draught 34' /  
10.36m

**HOUSTON**

**Cooper/T. Smith Stevedoring**  
2315 McCarty Drive  
Houston  
Texas  
77029  
USA  
**Contact:** Mr Britton Cooper, Vice  
President Operations

T: +1 713 675 0017  
F: +1 713 675 2370  
E: britton.cooper@coopersmith.com  
W: www.coopersmith.com

**HOUSTON**

**Kinder Morgan Terminals**  
1001 Louisiana St  
Suite 1000  
Houston  
Texas  
77002  
USA  
**Contact:** Mr Hans Luetkemeier,  
Vice President - Sales, Marketing  
and Business Dev  
T: +1 504 620 4628  
F: +1 504 377 8431  
E: hans\_luetkemeier@  
kindermorgan.com  
W: www.kindermorgan.com

**HOUSTON**

**Port of Houston Authority**  
111 East Loop North  
Houston  
Texas  
77209-4326  
USA  
**Contact:** Mr Stan Swigart, Director  
of Marketing  
T: +1 713 670 2644  
E: sswigart@poha.com  
W: www.portofhouston.com

**HOUSTON**

**Public Elevator 2**  
PO Box 2562  
Houston  
Texas  
77252-2562  
USA  
**Contact:** Mr Jimmy Jamison,  
T: +1 713 670 2676  
F: +1 713 670 2562

**HOUSTON**

**Texas Terminals, LP**  
15902 Peninsula Blvd  
Houston  
Texas  
77015  
USA  
**Contact:** Mr Robert Schwarz,  
General Manager  
T: +1 281 457 3131  
F: +1 281 457 3232  
E: info@texasterminals.com  
W: http://texasterminals.com/  
**Location:** Gulf of Mexico, Houston  
Ship channel, Port of Houston  
**Equipment & Capacity:** Liebherr  
Mobile Harbor Cranes. LHM320 &  
LHM 550. Clam shell buckets of  
various size. Average discharge  
production 14-16,000 Mt pwwd.  
Large number of wheel loaders,  
dozers, forklifts yard & dump trucks.  
**Bulk Berths:** 2 berths w/11 1320' ft  
of waterfront. Max allowable draught  
40' ft (12.19m). Max LOA 760' ft, No  
air-draft restriction, No beam  
restriction  
**Total Uncovered Storage:** 59  
acres  
**Total Covered Storage:** 5 acres  
Non-union, independent facility.  
Marseo/USCG restricted with 247  
security.

**HOUSTON**

**Tx Tx Corporation**  
11811 Interstate  
10 East  
Suite 630  
Houston  
Texas  
77029  
USA  
**Contact:** Mr Gary Nixon,  
T: +1 713 453 0664  
F: +1 713 453 2756

**HOUSTON**

**United Bulk Terminals USA,  
Inc.**  
Three Allen Center,  
333 Clay Street, Suite 2400  
Houston  
Texas  
77002  
USA  
**Contact:** Mr Fredrik Knutsen,  
Commercial Manager  
T: +1 281 457 7957  
E: fredrik.knutsen@unitedbulkterminals.com  
W: www.unitedbulkterminals.com  
**Location:** Lower Mississippi river  
Mile Post 55. Davant, LA USA.  
**Bulk Berths:** 4 Berths  
Buoys; #1 Dock- 2200 ft; #2 Dock  
1000 ft  
**Total Uncovered Storage:** 200  
acres- storage space for 5 million  
tonnes  
**Total Covered Storage:** N/A  
United Bulk Terminals-Davant is a  
full service bulk stevedore. We can  
handle four panamax vessels at one  
time. Most storage space on the  
Mississippi River. Package  
Logistics opportunities available.

**HUMBLE**

**P&O Ports Texas, Inc.**  
5810 Wilson Road  
Suite 220  
Humble  
Texas  
77396  
USA  
**Contact:** Mr Norman Lamb, Vice  
President  
T: +1 832 615 7201  
F: +1 832 615 7250  
E: norman.lamb@portsamerica.com  
W: www.portsamerica.com  
**Location:** Houston, Tx; Galveston,  
TX; Beaumont, TX,  
Corpus Christi, TX and Freeport, TX  
Contract Stevedore and Terminal  
Operator

**INDIANA**

**Port of Indiana**  
Burns Int'l Harbour 6600  
US Highway  
12 Portage  
Indiana  
46368  
USA  
**Contact:** Mr Peter Becarthy,  
T: +1 219 787 8636  
F: +1 219 787 8842  
E: info@portsindiana.com

**INDIANAPOLIS**

**Burns International Harbour-  
Port of Indiana**  
Indiana Port Commission  
150 West Market Street  
Suite 603  
Indianapolis  
IN  
46204  
USA  
**Contact:** Mr Jody Peacock,  
Marketing  
T: +1 317 232 9200  
F: +1 317 232 0137  
E: jpeacock@portsindiana.com  
W: www.portsindiana.com

**JACKSONVILLE**

**CSX**  
500 Water St  
HQ Bldg, 6th Floor  
Speed Code J842  
Jacksonville  
FL  
32202  
USA  
**Contact:** Mr Russ Epling, Director  
Coal Facilities  
T: +1 904 366 5493

F: +1 904 359 3341  
E: Russ\_Epling@csx.com  
W: www.csx.com

**JACKSONVILLE**

**Jacksonville Electric  
Authority**  
21 West Church St  
Jacksonville  
FL 32202  
USA  
**Contact:** Mr Wanyonyi Kendrick,  
Chief Information Officer  
T: +1 904 665 7217  
E: kendwj@jea.com  
W: www.jea.com

**JACKSONVILLE**

**Jacksonville Port Authority**  
2831 Talleyrand Avenue  
Jacksonville  
FL 32206  
USA  
**Contact:** Ms Whitney Croxton,  
Communications  
T: +1 904 357 3120  
E: Whitney.Croxton@jaxport.com  
W: www.jaxport.com

**JUNEAU**

**Port of Juneau**  
City Dock and Alaska Steam Dock  
155 South Seward  
Juneau  
Alaska  
AK 99801  
USA  
**Contact:** Mr John Stone, Port  
Director  
T: +1 907-586-0292  
F: +1 907-586-0295  
E: john.stone@ci.juneau.ak.us  
W: www.juneau.lib.ak.us

**KALAMA**

**Harvest States Elevator**  
400 Toteff Road  
Kalama  
Washington  
98625  
USA  
**Contact:** Mr Lance Helgeson,  
T: +1 360 673 2011  
F: +1 360 673 5101  
E: lance.helgeson@chscinc.com

**KALAMA**

**Peavy Elevator**  
2211North Hendricks Drive  
PO Box 1008  
Kalama  
Washington  
98625  
USA  
**Contact:** Mr Steve Oakes,  
T: +1 360 673 3900  
F: +1 360 673 3910

**KENAI**

**Port of Kenai**  
210 Fidalgo  
Kenai  
Alaska  
AK 99611  
USA  
**Contact:** Mr Keith Kornelis, Port  
Director  
T: +1 907 2837535  
F: +1 907 2621892  
E: bfrates@ci.kenai.ak.us  
W: www.ci.kenai.ak.us

**KENOVA**

**Big Sandy Terminal Inc**  
Big Sandy River Road  
Kenova  
West Virginia  
25530  
USA  
**Contact:** Mr Alan Johnson,  
President  
T: +1 304 453 4000  
F: +1 304 453 1177

E: alan.johnson@nscorp.com

**KIRKLAND**

**Macquarie Ports Inc**  
620 Kirkland Way  
Suite 206  
Kirkland  
WA  
98033  
USA  
**Contact:** Mr James Leonard,  
E: james.leonard@macquarie.com  
W: www.macquarie.com

**KIRTLAND**

**Pickands Mather Group**  
9717 Chillicothe Road  
Kirtland  
Ohio  
44094  
USA  
T: +1 440 256 7622  
F: +1 440 256 1998  
E: info@pmdataservices.com  
W: www.pmdataservices.com/

**KODIAK**

**City of Kodiak Harbour  
Department**  
403 Marine Way  
Kodiak  
Alaska  
AK 99815  
USA  
**Contact:** Mr G V McCorkle, Harbour  
Master  
T: +907 486 8080  
F: +907 486 8090  
W: www.kodiak.org

**LA PLACE**

**Port of South Louisiana**  
171 Belle Terre Boulevard  
La Place  
Louisiana 70068  
USA  
**Contact:** Ms Linda Prudhomme,  
Director of Business Development  
T: +1 985 652 9278  
F: +1 985 652 9518  
E: lprudhomme@portsl.com  
W: www.portsl.com  
**Location:** Lower Mississippi River  
**Equipment & Capacity:** 60 private  
and public docks and facilities - 292  
million tonnes/year

**Bulk Berths:** Globalplex Intermodal  
Terminal Bulk Cargo Handling  
Facility - 570'x44" and a 204 x 660  
ft dock with a 700 ft x 65 ft finger  
pier  
(Port-Owned)  
**Total Uncovered Storage:** 177,000  
sq ft storage pad  
**Total Covered Storage:** Two  
50,000 ton cement domes and over  
250,000 sq ft of covered warehouse  
space  
The Port of South Louisiana covers  
54 miles on the lower Mississippi  
River (mile 114.9-168.5). "Largest  
tonnage port in the western  
hemisphere".

**LAKE CHARLES**

**Lake Charles Harbor &  
Terminal District**  
PO Box 3753  
150 Marine Street  
Lake Charles  
LA 70602  
USA  
**Contact:** Mr Dan Loughney,  
Director of Marketing & Trade  
Development  
T: +1 337 439 3661  
F: +1 337 493 3528  
E: marketing@portlc.com  
W: www.portlc.com

**LAKE CHARLES**

**Port of Lake Charles**  
150 Marine Street

Lake Charles  
LA  
70602  
USA  
**Contact:** Mr. Winn,  
T: + 1 337 439 3661  
F: + 1 337 439 3523  
E: marketing@portic.com  
W: www.portic.com

## LAMBERTS POINT Norfolk Southern - Lamberts Point

Coal Business Group  
110 Franklin Rd  
Roanoke  
VA  
24042-0026  
USA  
**Contact:** Mr Mark H Bower, Group  
VP Export & Metallurgical Coal  
Marketing  
T: + 1 540 985 6711  
F: + 1 540 985 6398  
E: Mark.Bower@nscorp.com  
W: www.nscorp.com  
**Location:** Hampton Roads, Virginia  
USA

## LONG BEACH Cooper/T. Smith Stevedoring

PO Box 229  
Long Beach  
California  
90801  
USA  
**Contact:** Mr Ed Viner, Assistant  
Vice President/Operations Manager  
T: + 1 562 436 2259  
F: + 1 562 590 0547  
E: ed.viner@coopertsmith.com  
W: www.coopertsmith.com

## LONG BEACH MCC-Lucky Cement Terminal

1150 Pier F Avenue  
Pier F Berth 208  
Long Beach  
California  
90802  
USA  
**Contact:** Mr Marty Marcum,  
Manager of Operations  
T: + 1 562 495 0600  
F: + 1 562 495 5929

## LONG BEACH Metro Ports

1045 Pier G Avenue  
Long Beach  
California  
90802  
USA  
**Contact:** Mr Rob Waterman, Vice  
President Operations  
T: + 1 310 816 6557  
F: + 1 310 816 6519  
E: info@metroports.com  
W: www.metroports.com  
**Location:** Port of Long Beach  
Berths G212-214  
**Equipment & Capacity:** 1 x 2500  
Mtp, 1 X 4,500 Mtp traveling  
shiploaders  
**Bulk Berths:** 2 berths, 1900' total (1  
x 40' draught, 1 x 50' draught at  
MLLW)

## LONG BEACH

**Metro Ports**  
3806 Worsam Avenue  
Long Beach  
California  
90808  
USA  
**Contact:** Mr Rob Waterman, Vice  
President, Bulk Operations  
T: + 1 310 816 6557  
F: + 1 310 816 6519  
E: rob.waterman@metroports.com  
W: www.metsteco.com  
**Location:** The Port of Long Beach,  
CA USA

**Equipment & Capacity:** 2  
shiploaders 5,000tp, 2,500tp  
capacity  
**Bulk Berths:** 2 berths (40', 50'  
draught) 1800' total wharf length,  
rotary and bottom dump rail car  
receiving  
**Total Uncovered Storage:** 2 truck  
bottom dump pits  
The operations staff at Metropolitan  
Stevedore Company has extensive  
experience in the handling of bulk  
cargoes. Metropolitan has a rich  
history of every kind and of every  
description. From grab buckets to  
highly automated, fully enclosed  
systems. We are the experts in our  
field.

## LONG BEACH

**Oxbow Energy Solutions**  
330 Golden Shore, Suite 210  
Long Beach  
CA  
90802  
USA  
**Contact:** Mr Don Covert, Facility  
Manager  
T: + 1 409 944 3500  
F: + 1 409 944 3523  
E: Don.Covert@oxbow.com  
W: www.oxbow.com  
**Location:** Texas Gulf Coast, USA  
**Equipment & Capacity:** Stationary  
Dry Bulk Ship Loader.  
Load Rate 20, 000 metric tons per  
weather working day of 24  
consecutive hours.  
**Bulk Berths:** Dock #45, 1 berth  
**Total Uncovered Storage:** 22  
acres  
**Total Covered Storage:** n/a

## LONG BEACH

**Port of Long Beach**  
PO Box 570  
Long Beach  
CA  
90801  
USA  
**Contact:** Ms Maria D Pangelinan,  
Communications Division  
T: + 1 562 283 7723  
F: + 1 562 901 1735  
E: maria.pangelinan@polb.com  
W: www.polb.com

## LONGVIEW

**Port of Longview**  
10 Port Way  
Longview  
WA  
98632  
USA  
**Contact:** Mrs Laurie Nelson-Cooley,  
Business Development Manager  
T: + 1 360 425 3305  
F: + 1 360 425 8650  
E: lnelson-  
cooley@portoflongview.com  
W: www.portoflongview.com  
**Location:** Southwest Washington  
State, USA  
**Equipment & Capacity:** Bulk,  
breakbulk and project cargo  
handling  
**Bulk Berths:** Berth 2, Berth 5,  
Berth 7  
**Total Uncovered Storage:** 2 million  
sq. ft.  
**Total Covered Storage:** 1 million  
sq. ft.  
Premier bulk, breakbulk and project  
cargo handling port in SW  
Washington State on the deep draft  
Columbia River.

## LOUISVILLE

**Kinder Morgan Terminals - Louisville**  
Midwest Regional Office  
8500 West 68th Street  
Argo  
Illinois  
60501

USA  
**Contact:** Mr Roy Cook,  
T: + 1 414 769 1901 ext-120  
F: + 1 414 769 1144  
E: roy.cook@kindermorgan.com  
W: www.kindermorgan.com

## LOUISVILLE

**Schaefer-Cooper Warehousing**  
7200 Riverport Drive  
Louisville  
Kentucky  
KY 40258  
USA  
**Contact:** Mr Jeff McCord, Sales  
Manager  
T: + 1 317 374 5240  
E: jeff.mccord@coopertsmith.com  
W: www.coopertsmith.com

## MANDEVILLE

**Consolidated Terminals & Logistics Company**  
PO Box 249  
Mandeville  
LA  
70470-0249  
USA  
**Contact:** Mr Mo Aleman, Director,  
Business Development  
T: + 1 985 871 3590  
F: + 1 985 867 3509  
E: mo.aleman@cgb.com  
W: www.ctlonline.com  
**Location:** Mississippi River mile  
post 133 - 180 AHP  
**Equipment & Capacity:** 11 high  
capacity floating cranes  
**Bulk Berths:** 9 midstream vessel  
anchorage  
In addition to being the largest  
stevedoring group in the US Gulf,  
CTLC offers full inland logistics  
including vessel Stevedoring,  
Barging, Terminal, Truck and Rail  
delivery to all inland destinations.

## MANDEVILLE

**Cooper/Consolidated**  
PO Box 249  
Mandeville  
LA  
70470-0249  
USA  
**Contact:** Mr Billy Fitzpatrick,  
Managing Director Sales & Logistics  
T: + 1 985 871 2510  
E: Billy.Fitzpatrick@cooper-  
consolidated.com  
W: www.cooperconsolidated.com  
**Location:** Lower Mississippi River  
**Equipment & Capacity:** Multiple  
high capacity floating cranes  
Mid-stream coal transfer facility aka  
"LMO"  
and mid-stream grain transfer facility  
aka "The America"  
**Bulk Berths:** 11 mid-stream berths  
(mp 111-180)  
**Total Uncovered Storage:** n/a  
**Total Covered Storage:** n/a  
We specialize in full logistics  
solutions. Services include  
stevedoring, barging, trucking, rail,  
inland terminaling, as well as barge  
fleeting, cleaning and repairs.

## MAUMEE

**Kuhlman Corporation**  
1845 Indian Wood Circle  
Maumee  
Ohio  
43537  
USA  
**Contact:** Mr Steve Smigelski,  
General Manager  
T: + 1 419 897 6000  
F: + 1 419 897 6061  
E: ssmigelski@kuhlman-corp.com  
W: www.kuhlman-corp.com  
**Location:** Western Lake Erie Basin  
**Total Uncovered Storage:** 175,000 MT  
**Total Covered Storage:** 140,000 MT

## MAUMEE

**The Andersons - Maumee Grain Marine facilities**  
Kuhlman & Edwin Drive  
General offices  
PO Box 119  
480 W. Dussel Drive  
Maumee  
Ohio  
43537  
USA  
**Contact:** Mr Jim McKinstry,  
Director, Development and  
Transportation  
T: + 1 419 891 6565  
F: + 1 419 891 6513  
E: jim\_mckinstry@  
andersonsinc.com  
W: www.andersonsinc.com  
**Location:** Maumee River / Toledo,  
OH  
**Bulk Berths:** 2 x 1000 ft @ Seaway  
draught  
**Total Covered Storage:** 1 million  
metric tons  
Load rate at each facility  
approximately 1,000tp

## MAUMEE

**The Andersons, Inc**  
PO Box 119  
Maumee  
Ohio  
43537-0119  
USA  
**Contact:** Mr Don Wray,  
T: + 1 419 241 8943  
F: + 1 419 255 5366  
E: don\_wray@andersonsinc.com  
W: www.andersonsinc.com  
**Location:** Toledo/Lake Erie  
**Equipment & Capacity:** Grain  
Merchant  
**Bulk Berths:** 1,000 ft/seaway draft  
Grain shipping and receiving, Bulk  
liquid and dry ag fertilizer. NSRR.

## METROPOLIS

**AEP/Cook Coal Terminal**  
PO Box 870 3316 N. US 45 Rd.  
Metropolis  
IL  
62960  
USA  
**Contact:** Mr Robert Korte, Plant  
Manager  
T: + 1 618 524 9345  
F: + 1 618 524 1968  
E: rskorte@aep.com  
W: www.aep.com  
**Location:** Metropolis, Illinois - Ohio  
River 947.5

## MIAMI

**Panama Canal Authority (ACP)**  
8619 NW 68 Street  
PO Box 526725  
Miami  
FL  
33195-2685  
USA  
**Contact:** Mr Yumiko E Casiano,  
Marketing Department  
T: + 1-507-272-1586  
F: + 1-507-272-1622  
E: ycasiano@pancanal.com  
W: www.pancanal.com

## MIAMI

**Port of Miami**  
1015 N America Way  
Miami  
FLA  
33132  
USA  
**Contact:** Mr Bill Johnson, Director  
T: + 1 305 371 4859  
F: + 1 305 347 4843  
E: BJ4@miamidade.gov  
W: www.co.miami-  
dade.fl.us/portofmiami/

## MILWAUKEE

**Continental Grain Elevator**  
960 East Bay Street  
Milwaukee  
Wisconsin  
53207  
USA  
T: + 1 414 482 1900  
F: + 1 414 482 1733

## MILWAUKEE

**Milwaukee Bulk Terminals**  
1900 S Harbour Drive  
Milwaukee  
WI  
53207  
USA  
**Contact:** Mr Roy Cook, President  
T: + 1 414 769 1901 x120  
F: + 1 414 769 1144  
E: mbrmc@aol.com

## MILWAUKEE

**Port of Milwaukee**  
2323 S Lincoln Memorial Drive  
Milwaukee  
WI  
53207  
USA  
**Contact:** Mr Peter Hirth, Marketing  
(Senior Trade Development)  
T: + 1 414 286 8131  
E: phirth@milwaukee.gov  
W: www.milwaukee.gov/port  
**Location:** Located on the  
Southwestern shore of Lake  
Michigan.  
**Equipment & Capacity:** Cranes  
from 58,000 to 200,000 KG capacity  
**Bulk Berths:** Terminals 1 and 4  
dedicated to handling and storage  
of dry bulk commodities.  
**Total Uncovered Storage:** 36  
acres  
**Total Covered Storage:** Four  
storage domes totaling 50,000 tons.  
Terminal 4 warehouse = 7,100 m2  
Approximately 2.5 million tons of  
bulk commodities are handled  
yearly, coal, salt, cement, limestone,  
aggregates and grain.

## MOBILE

**Alabama State Port Authority**  
PO Box 1588  
Mobile  
AL  
36633  
USA  
**Contact:** Ms Judith Adams, Vice  
President, Marketing  
T: + 1 251 441 7003  
F: + 1 334 441 7216  
E: jadams@asdd.com  
W: www.asdd.com

## MOBILE

**Cooper/T. Smith Stevedoring**  
118 North Royal Street  
Mobile  
Alabama  
36602  
USA  
**Contact:** Mr John Murray, Vice  
President  
T: + 1 251 415 7360  
F: + 1 251 431 6200  
E: john.murray@coopertsmith.com  
W: www.coopertsmith.com  
**Location:** Mobile, Alabama, USA  
**Equipment & Capacity:** Four  
Floating Cranes-One Land Based  
Gantry  
Floating Cranes Direct to  
Barge/Storage  
Gantry to Storage  
Wood Pellet System to Receive  
Trucks to Barge  
**Bulk Berths:** Three Berths - 40'  
Fresh Water Arrival Draught  
Pan-Max Type Ships  
**Total Uncovered Storage:** Two  
Storage Areas  
1. Capacity for 300,000

Out By Barge/Truck  
2. Storage Area for Ores/Pig Iron/Scrap  
600'x100' approx. 65,000tons  
Rail Siding on Site & Certified  
Rail Scale  
**Total Covered Storage:** None  
CMT Barge Line With 250 Barges  
(Covered/Open Barges)  
3 Fleeting Area in Mobile, AL -  
capacity 275 barges -17 Pushboats  
Several Inland Terminals on  
Alabama/Miss. Waterways

## MOBILE

**FGDI LLC - ASPA Pier D Grain Elevator**  
Mobile  
Alabama  
USA  
**Contact:** Mr Lamar Willis,  
T: + 1 251 432 2211  
E: lamarw@fcstone.com

## MOBILE

**McDuffie Coal Terminal**  
Alabama State Port Authority  
PO Box 1588  
Mobile  
Alabama  
36633  
USA  
**Contact:** Mr Melvin Barnett,  
Superintendent - Operations  
T: + 1 251 441 7675  
F: + 1 251 441 7216  
E: mbarnett@asdd.com  
W: www.asdd.com  
**Location:** At mouth of Mobile River,  
Mobile, Alabama, USA  
22 miles from Gulf of Mexico  
**Equipment & Capacity:** 6 Slacker-  
Reclaimers, 3 off loaders, 2 ship  
loaders, 22 million tonne capacity  
**Bulk Berths:** 3 ship berths, 3 barge  
loaders, 2 barge unloaders  
**Total Uncovered Storage:** 2.4  
million tonnes

## MOBILE

**Port of Mobile**  
Alabama State Port Authority  
PO Box 1588  
Mobile  
AL  
36633 1588  
USA  
**Contact:** Ms Judith Adams,  
Manager, Media Relations  
T: + 1 251 441 7003  
F: + 1 334 441 7216  
E: jadams@asdd.com  
W: www.asdd.com  
**Location:** Eastern Gulf of Mexico  
**Equipment & Capacity:** 5 bulk  
cranes 750-15000 tph  
5 bulk loaders 1000-3000 tph  
40t paceco container crane  
Gottwald 330 mobile harbor  
**Bulk Berths:** 3 berths at 45' draft  
1000' length  
2 berths at 40' draft 750' length  
Grain berth 40' draft 900' length  
Cement berth 40' draft 750' length  
25 general cargo berths 40' draft  
**Total Uncovered Storage:** 180,000  
square meters general cargo  
25,000 square meters bulk  
Served by 5 class one railroads, 2  
interstate highways, and a 1500  
mile inland waterway system

## MOBILE

**Stevedoring Services Services of America**  
PO Box 2188  
Mobile  
AL 36652  
USA  
**Contact:** Mr Brian R. Frennea,  
T: + 1 334 438 4771  
F: + 1 334 432 3180



**MONACA**

**Colona Terminal Services**  
1755 Pennsylvania Ave  
Monaca  
Pennsylvania  
15061  
USA  
**Contact:** Mr Mark McClmonds,  
President  
T: + 1 724 368 8040  
F: + 1 724 368 0550  
E: sales@colonatransfer.com  
W: www.colonatransfer.com

**MONROE**

**Tower Monroe Port**  
**Commission**  
PO Box 585  
Monroe  
MI 48161  
USA  
**Contact:** Mr M McCray, Executive  
Director

**MOREHEAD CITY**

**North Carolina State Ports  
Authority/Morehead City**  
113 Arendell St.  
Morehead City  
NC  
28557  
USA  
**Contact:** Ms Shannon Moody,  
Director, Communications  
T: + 1 910 343 6482  
F: + 1 910 343 6225  
E: shannon\_moody@ncports.com  
W: www.ncports.com

**Location:** Port of Morehead  
situated along the Newport River  
and Bogue Sound  
**Equipment & Capacity:** 2 gantry  
cranes, 1 container crane, 3 mobile  
cranes & cargo handling equipment  
**Bulk Berths:** Dry bulk facility (used  
mainly for phosphate) w/ 225,000  
ton capacity warehouse, conveyor  
system & shiploader. Open storage  
dry bulk facility which can outload  
1,000 tons per hr. w/ a two-million-  
ton annual capacity.  
**Total Uncovered Storage:**  
Approximately 14 acres of paved,  
open storage.  
**Total Covered Storage:** 457,564  
sq. ft. of covered, sprinklered  
warehouse storage.  
Approximately 205 acres, w/ 150  
(+/-) acres suitable for port industrial  
development on Radio Island (In  
Morehead City)

**MOUNT PLEASANT**

**Strachan Shipping Co**  
950 Houston Northcutt Boulevard  
Watermark Plaza, Suite 200  
Mount Pleasant  
SC  
29464  
USA  
**Contact:** Mr Bill Adams,  
T: + 1 843 856 1000  
F: + 1 843 856 1013

**MOUNT VERNON**

**Ports Of Indiana**  
Southwind Maritime Centre  
2751 Bluff Rd  
Mount Vernon  
IN  
47620-8521  
USA  
**Contact:** Mr Phillip Wilzbacher, Port  
Director  
T: + 1 812 833 2166  
F: + 1 812 838 4377  
E: pwilzbacher@portsofindiana.com  
W: www.portsofindiana.com

**MYRTLE GROVE**

**International Marine  
Terminals**  
Myrtle Grove Terminal  
18559 HWY 23

Myrtle Grove  
LA  
70083-9722  
USA  
**Contact:** Mr Adam Smith, General  
Manager  
T: + 1 504 310 5000  
F: + 1 255 656 2071  
E: adam\_smith@kindermorgan.com  
W: www.kindermorgan.com  
**Location:** Myrtle Grove, Louisiana,  
Milepost 57 Mississippi River, 30  
miles south of New Orleans  
**Equipment & Capacity:** Full  
Service Marine Terminal which also  
operates a fleet service for up to  
300 barges.  
**Bulk Berths:** Three vessel berths  
and one barge berth, including  
midstream mooring buoys for direct  
transfer cargoes.  
**Total Uncovered Storage:**  
1,300,000 tons capacity  
**Total Covered Storage:** N/A  
24/7 SHINC  
A Kinder Morgan Operated Terminal

**NEW HAVEN**

**New Haven**  
Gateway Terminal  
400 Waterfront Street  
New Haven  
CT  
06512  
USA  
**Contact:** Mr Tom Dubno,  
T: + 1 203 230 0778  
F: + 1 203 437 7251

**NEW HAVEN**

**New Haven Terminal**  
Logistec Connecticut Inc  
PO Box 9411  
100 Waterfront Street  
New Haven  
CT  
06534-0411  
USA  
**Contact:** Mr James Schine, Sales  
and Marketing Manager  
T: + 1 203 468 0805  
F: + 1 203 469 1318

**NEW ORLEANS**

**Port of New Orleans**  
1350 Port of New Orleans Place  
New Orleans  
LA  
70130  
USA  
**Contact:** Ms Janine Mansour,  
Commercial Manager  
T: + 1 504 528 3533  
E: info@portno.com  
W: www.portno.com

**NEWARK**

**Metal Management NE**  
Foot Hawkins Street  
Newark  
New Jersey  
NJ 07105  
USA  
**Contact:** Mr Mike Henderson Jr.,  
T: + 1 973 344 5575 / 4570  
F: + 1 973 344 8155  
E: mhendersonjr@mtm.com  
W: www.mtm.com

**NEWPORT NEWS**

**Dominion Terminal  
Associates LLP**  
600 Harbor Road  
Pier 11  
Newport News  
Virginia  
VA-23607  
USA  
**Contact:** Mr Rick Cole, President  
T: + 1 757 245 2275  
F: + 1 757 247 9729  
E: rcole@dominionterminal.com  
W: www.dominionterminal.com  
**Location:** Port of Hampton Roads,

Virginia, USA  
**Equipment & Capacity:** 1 tandem  
rotary dumper, 2 stacker/reclaimers,  
1 reclaimer, 1 finger pier, 1  
shiploader  
Capacity: 20 million tonnes (net)  
annually.  
**Bulk Berths:** Depth at mean low  
water; 50 feet (15.24m)  
**Total Uncovered Storage:** 1.7  
million tonnes (net)  
Inbound and Outbound sampling,  
Blending, using two 4,000 tonne  
silos

**NEWPORT NEWS**

**Kinder Morgan -Pier IX  
Terminal**  
1900 Harbor Access Road  
Newport News  
Virginia  
23607  
USA  
**Contact:** Mr Joseph De Matteo,  
Terminal Manager  
T: + 1 757 928 1520  
F: + 1 757 928 1560  
E: Joseph\_DeMatteo@  
kindermorgan.com  
W: www.kindermorgan.com  
**Location:** Mid Atlantic US; Newport  
News VA  
**Equipment & Capacity:** Coal and  
Cement Handling Equipment; Export  
and Import; 14m tpa capacity  
**Bulk Berths:** Cape and Panamax  
vessel berthing

**NORFOLK**

**Host Terminals**  
150 W. Main Street  
Suite 1600  
Norfolk  
VA  
23510  
USA  
T: +1 757 627 6286  
W: www.tparkerhost.com  
Host Terminals has over 16 terminal  
and stevedoring operations that we  
manage for third parties. Annually,  
we handle approximately 560  
vessels, 250 million gallons of liquid  
bulk, and 9 million tons of dry bulk.

**NORFOLK**

**Virginia International  
Terminals Inc**  
PO Box 1367  
Norfolk  
VA 23501  
USA  
**Contact:** Mr Dave Rudloff, Dir.  
Engineering & Maintenance  
T: + 1 757 440 7000  
F: + 1 757 391 6223  
W: www.vit.org

**NORFOLK**

**Virginia Maritime Association**  
236 East Plume Street  
Norfolk  
Virginia  
23510  
USA  
**Contact:** Mr David , Administrator  
T: + 1 757 622 2639  
F: + 1 757 622 6302  
E: vma@portofhamptonroads.com  
W: www.portofhamptonroads.com

**NORFOLK**

**Virginia Port Authority**  
Hampton Roads District  
600 World Trade Centre  
Norfolk  
VA  
23510 1696  
USA  
**Contact:** Ms Linda Ford, Director of  
Port Promotion  
T: + 1 757 683 8000  
F: + 1 757 683 8500  
E: lford@portofvirginia.com

W: www.portofvirginia.com

**NORTH CHARLESTON**

**Cooper/T. Smith Stevedoring**  
2030 Hayler Street  
Building 58A Pier C  
North Charleston  
South Carolina  
29405  
USA  
**Contact:** Mr Ronnie Turner, Vice  
President  
T: + 1 843 744 1613  
F: + 1 843 554 2975  
E: ronnie.turner@coopertsmith.com  
W: www.coopertsmith.com

**OAKLAND**

**Port of Oakland**  
PO Box 2064  
Oakland  
California  
94604  
USA  
**Contact:** Mr Robert Bernardo,  
Media/Public Relations Manager  
T: + 1 510 627 1401  
E: rbernardo@portoakland.com  
W: www.portofoakland.com

**OAKVILLE**

**The Andersons**  
500 Oakville Road  
Oakville  
IN  
47367  
USA  
**Contact:** Ms Dawn Betancourt,  
General Manager  
T: + 1 765 288 1951  
F: + 1 765 288 4176  
E: dawn\_betancourt@  
andersonsinc.com  
W: www.andersonsgrain.com

**OGDENSBURG**

**Ogdensburg Bridge & Port  
Authority**  
1 Bridge Plaza  
Ogdensburg  
NY 13669  
USA  
**Contact:** Mr Wade Davis, Executive  
Director  
T: + 1 315 393 4080  
F: + 1 315 393 7068  
E: wadavis@ogdensport.com  
W: www.ogdensport.com

**OLYMPIA**

**Port of Olympia**  
915 Washington Street NE  
Olympia  
WA 98501-6931  
USA  
**Contact:** Mr Jim Amador, Marine  
Terminal Director  
T: + 1 360 528 8032  
F: + 1 360 528 8093  
E: JimA@portolympia.com  
**Location:** Northwest Coast of  
United States

**Equipment & Capacity:** 2-40 LT  
gantry cranes, 15 forklifts (8,000-  
30,000 lb lift capacity), container  
handling equipment, log loaders,  
bucket loaders  
**Bulk Berths:** No bulk facilities.  
Continuous berth face (berths 1-2-3)  
equalling 1,750 feet  
**Total Uncovered Storage:** 57  
acres  
**Total Covered Storage:** 2 acres  
(76,000 square feet)

**OMAHA**

**Hansen-Mueller Company**  
12231 Emmet Street  
Omaha  
NE  
68164  
USA  
**Contact:** Mr John W. Orr, President

T: + 1 402 491 3385  
F: + 1 402 491 0645  
E: john@hmgain.com  
W: www.hmgain.com  
**Location:** Houston, TX  
**Equipment & Capacity:** 1,500tph  
(3 x 21 m3 grabs + 2 x 10 m3 grabs  
+ 3 vessel receiving hoppers)  
**Total Covered Storage:** 135,000  
tonnes

**OSWEGO**

**Port of Oswego Authority**  
1 East Second Street  
Oswego  
NY  
13126  
USA  
**Contact:** Mr Jonathan Daniels,  
Executive Director  
T: + 1 315 806 6405  
F: + 1 315 343 5498  
E: jdaniels@portoswego.com  
W: www.portoswego.com

**OWENSBORO**

**Kinder Morgan Terminals -  
Owensboro**  
Midwest Regional Office  
8500 West 68th Street  
Argo  
Illinois  
60501  
USA  
**Contact:** Mr William Patterson,  
T: + 1 708 496 2891  
F: + 1 708 496 2540  
E: william\_patterson@  
kindermorgan.com  
W: www.kindermorgan.com

**PADUCAH**

**PEBCO®**  
PO Box 7506  
225 North 4th Street (42001)  
Paducah  
KY  
42002-7506  
USA  
**Contact:** Ms Jo Masters, Marketing  
Coordinator & AA to Senior VP  
T: + 1 270 442 1996 (ext 231)  
F: + 1 270 442 5214  
E: sales@pebco.com  
W: www.pebco.com

**PAGO PAGO**

**Port of Pago Pago**  
Department of Port Administration  
Government Of American Samoa  
PO Box 1539  
Pago Pago  
American Samoa  
96799  
USA  
**Contact:** Mr Matagi R Ma'ilo  
Momoore, Port Director  
T: + 1 684 6343251  
F: + 1 684 6335281  
E: MatagiMomoore@  
Americansamoa.gov  
W: www.americansamoa.gov

**PALMER**

**Port MacKenzie, Matanuska-  
Susitna Borough**  
350 E. Dahlia Avenue  
Palmer  
AK  
99645  
USA  
**Contact:** Mr Marc Van Dongen, Port  
Director  
T: + 1 907 357 6153  
F: + 1 907 357 6836  
E: Port.Mackenzie@matsugov.us  
W: www.portmackenzie.com  
**Location:** NW of Anchorage Alaska  
- 2 miles

**PALMETTO**

**Port Manatee Forestry  
Terminal Inc**

600 Regal Cruise Way  
Palmetto  
Florida  
34221  
USA  
T: + 1 941 729 2424  
F: + 1 941 729 4343  
E: tamw@gearbulk.com  
W: www.gearbulk.com

**PASCAGOULA**

**Port of Pascagoula**  
3033 Pascagoula Street  
Pascagoula  
MS  
39667 0070  
USA  
**Contact:** Ms Betty Ann White,  
Manager, Government Affairs &  
Public Relations  
T: + 1 228 762 4041  
F: + 1 228 762 7476  
E: info@portofpascagoula.com  
W: www.portofpascagoula.com

**PENSACOLA**

**Port of Pensacola**  
PO Box 889  
700 S Barracks Street  
Pensacola  
FL  
32594-0889  
USA  
**Contact:** Ms Amy Miller, Business  
Development Manager  
T: + 1 850 436 5070  
F: + 1 850 435 1879  
E: info@portofpensacola.com  
W: www.portofpensacola.com

**PHILADELPHIA**

**Agway**  
3501 S C Columbus Blvd  
Pier 122 South  
Philadelphia  
PA  
19148  
USA  
**Contact:** Mr George Moore,  
Foreman  
T: + 1 215 467 5861  
F: + 1 215 467 5874  
E: gmoore@growmark.com  
W: www.agway.com

**PHILADELPHIA**

**Port of Philadelphia &  
Camden**  
3460 North Delaware Avenue  
2nd Floor  
Philadelphia  
PA 19134  
USA  
**Contact:** Mr Sean E Mahoney,  
T: + 1 215 426 2441  
F: + 1 215 426 2447  
E: semahoney@philaport.com  
**Location:** North East on the  
Delaware River  
**Equipment & Capacity:** 9 Cranes  
**Bulk Berths:** 21 - 20 180' - 40'  
**Total Uncovered Storage:** 1 132  
922 sqm  
**Total Covered Storage:** 355 353  
sqm

**PITI**

**Port Authority of Guam**  
1026 Cabras Highway  
Suite 201  
Piti  
Guam  
96915  
USA  
**Contact:** Mr Joseph W. Duenas,  
General Manager  
T: + 671 71 477 5931/35  
F: + 671 71 477 2689  
E: mphenderson@portofguam.com  
W: www.portofguam.com  
**Location:** Western Pacific  
**Equipment & Capacity:** 2 Ship-  
shore container gantries 1 Hitachi  
40t, 1 Paceco 40t; Mobile cranes

(truck-mounted) 1 Grove 150t; Yard gantries 2 Paccoc 40t; Front end handlers/reachstackers 3 Hyster 40t, 5 Hyster 7.5t.

**Total Uncovered Storage:** Total Area 132,000sqm  
**Total Covered Storage:** 3,300sqm

## POINT COMFORT

### Port of Point Comfort/Port Lavaca

The Calhoun County Navigation District  
PO Box 397  
Point Comfort  
TX 77978  
USA

**Contact:** Mr Robert Van Borssum, Port Director  
T: + 1 361 987 2813  
F: + 1 361 987 2189  
E: RHVB@portofplpc.com.

## PORT ALLEN

### Associated Terminals of Baton Rouge/Port Allen



ASSOCIATED TERMINALS

1133 Mahaffey Road  
Port Allen  
Louisiana  
70876  
USA

**Contact:** Mr Barry Hoth, Vice President  
T: + 1 985 479 6358  
F: + 1 985 479 6360

**E:** barry@associatedterminals.com  
**W:** www.associatedterminals.com  
**Location:** Lower Mississippi River Baton Rouge / Port Allen  
**Equipment & Capacity:** Dock cranes, conveyors, mobile equipment.

**Bulk Berths:** 400-linear ft. of water frontage.

**Total Uncovered Storage:** 50,000 sq ft

**Total Covered Storage:** 30,000 sq ft

Barge terminal just inside of the Port Allen locks. Facility meets a demand for cargo transfers between barge, storage and truck. The terminal is located on the Intracoastal Waterway in Port Allen, adjacent to the Port of Greater Baton Rouge.

## PORT ALLEN

### Port of Greater Baton Rouge

PO Box 380  
Port Allen  
LA  
70767  
USA

**Contact:** Ms Karen St. Cyr, Director of Public Affairs  
T: + 1 225 342 1660 ext. 1206  
F: + 1 225 342 1666  
E: stcyrk@portgbr.com  
**W:** www.portgbr.com

## PORT ANGELES

### Port of Port Angeles

338 West First Street  
Port Angeles  
Washington  
98362  
USA

**Contact:** Mr Ken O'Hollaren, Executive Director  
T: + 1 360 457 1138  
F: + 1 360 452 3959  
E: keno@portofpa.com  
**W:** www.portofpa.com

## PORT ARTHUR

### Pabtex

209 Taft Ave. Extension  
PO Box 3635  
Port Arthur

TX 77643  
USA

**Contact:** Mr Greg Alder, Terminal Manager

T: + 1 409 962 8343  
F: + 1 409 962 8581

E: gregalder@savageservices.com  
**W:** www.savageservices.com

## PORT ARTHUR

### Port of Port Arthur

PO Box 1428  
221 Houston Avenue  
Port Arthur  
TX  
77641  
USA

**Contact:** Mr Anthony Therio, Senior Director of Trade Development  
T: + 1 409 983 2011  
F: + 1 409 985 9312

E: orlando@portofportarthur.com  
**W:** www.portofportarthur.com/

**Location:** On Gulf Intracoastal Waterway - 19 miles Gulf of Mexico

**Equipment & Capacity:** 75 ton level lifting gantry crane

**Bulk Berths:** Dock length 946m; Road Dock 25m; 31m April; 40' water

**Total Uncovered Storage:** 69m  
**Total Covered Storage:** 48m

## PORT HUENEME

### Port Hueneme Port Authority

PO Box 608  
Port Hueneme  
CA  
93044  
USA

**Contact:** Mr Tony J., Executive Director  
T: + 1 805 488 3677  
F: + 1 805 488 2620  
E: wberg@portofhueneme.org

## PORT NEWARK

### Port Authority of NY & N Jersey

260 Kellogg Street  
3 Rd Floor  
Port Newark  
NY  
N.J. 07114  
USA

**Contact:** Mr Robert Gaffney, Director  
T: + 1 212 435 6001  
F: + 1 212 435 6030  
E: rgaffney@panynj.gov

## PORT ROYAL

### Port of Port Royal

South Carolina State Ports Authority  
601 Paris Avenue  
Port Royal  
SC 29935-2431  
USA

**Contact:** Mr A J Pesavento, Terminal Manager  
T: + 1 803 524 9311  
F: + 1 803 524 5397  
E: scspainfo@scspa.com  
**W:** www.portofcharleston.com/proyal.htm

## PORT SMITH

### Granite State Minerals

227 Market Street  
Port Smith  
New Hampshire  
03801  
USA

**Contact:** Mr Paul Wentworth, Marketing  
T: + 1 603 436 8505  
E: info@gsmst.com  
**W:** http://gsmst.com  
**Location:** Mid-Atlantic- USA

**Equipment & Capacity:** Conventional/Self-un-loader Capacity

**Total Uncovered Storage:** 40 Acres

**Total Covered Storage:** 100,000 Sq Ft  
Dry Cargo Specialist

## PORTLAND

### Columbia Grain Elevator

1300 SW 5th Avenue  
Suite 2929  
Portland  
Oregon  
97201  
USA

**Contact:** Mr Amer Badawi, VP  
T: + 1 503 224 8624  
F: + 1 503 241 0296

E: web-info@columbiagrains.com  
**W:** www.columbiagrains.com

## PORTLAND

### International Terminals

PO Box 10047  
Portland  
Oregon  
97296-0047  
USA

**Contact:** Mr Chuck Ford, Terminal Superintendent

T: + 1 503 286 6923  
F: + 1 503 286 6960

E: cferhune@schn.com  
**W:** www.intterm.com

## PORTLAND

### Port of Portland

PO Box 3529  
Portland  
OR  
97208  
USA

**Contact:** Mr Josh Thomas, Media Relations Manager  
T: + 1 503 415 6054

E: joshua.thomas@portofportland.com  
**W:** www.portofportland.com

**Location:** The Port is located in Portland, Ore. at the confluence of the Columbia and Willamette Rivers.  
**Equipment & Capacity:** Terminal 2: 49 acres, bulk, breakbulk steel, heavy lift project cargo.

Terminal 4: 280 acres, autos, mineral and liquid bulks.  
Terminal 5: 159 acres, mineral bulks, grain, manufacturing.  
Terminal 6: 386 acres, containers, autos, breakbulk steel.

**Bulk Berths:** Terminal 2: 4 berths, draught 35-43', 50t and 40t cranes.  
Terminal 4: 7 berths, draught 35-43'  
Terminal 5: 2 berths, 1 industrial dock, draught 43'

Terminal 6: 5 berths, 9 quayside gantry cranes, draught 43'  
**Total Covered Storage:** 310,000 sq ft

The Port's proximity to major highways, mainline railroads, and barging on the Columbia-Snake River system provide auto, bulk, breakbulk, liquid bulk and container shippers with cost-effective, reliable gateways to domestic and international markets.

## PORTSMOUTH

### Sprague Energy

Two International Drive  
Suite 200  
Portsmouth  
New Hampshire  
03801  
USA

**Contact:** Mr James Theriault, VP Marketing  
T: + 1 603 430 5372  
F: + 1 603 766 7448

E: jtheriault@spragueenergy.com  
**W:** www.spragueenergy.com  
**Location:** North East United States. Searsport Maine, Portland Maine, Portsmouth NH, Boston MA, Providence RI  
Twenty terminals

## PROVIDENCE

### Waterson Terminal Services

35 Terminal Road  
Providence  
RI 02905  
USA

**Contact:** Mr Christopher Waterson, General Manager

T: + 1 401 461 9900 ext 230  
F: + 1 401 461 6240

E: chris@watersonllc.com  
**W:** www.watersonllc.com

**Location:** Port of Providence, Rhode Island

**Equipment & Capacity:** Including 2x Barge Cranes with 140 ton stevedoring capacity and up to 1,500 TPH production rates.

**Bulk Berths:** 6 berths - 3500 linear feet of berthing. Please see website www.watersonllc.com for further details.

**Total Uncovered Storage:** 20+ acres paved open lay down area.

**Total Covered Storage:** Two warehouses totaling over 250,000 square feet of storage.

Situated on our 105 acres we offer over 3,500 feet of linear berthing capable of working 6 vessels at any one time.

## PUEBLO

### Association of American Railroads

PO Box 11130  
Pueblo  
CO 81001  
USA

**Contact:** Ms Patricia Reilly, Vice President Communications

T: + 1 719 584 0749  
F: + 1 719 585 1895

E: preilly@aar.org  
**W:** www.aar.org

## REDWOOD CITY

### Port of Redwood City

675 Seaport Blvd  
Redwood City  
CA  
94063-2794  
USA

**Contact:** Mr Steve Wright, Operations Manager  
T: + 1 650 306 4150 ext 16  
F: + 1 650 369 7636

E: swright@redwoodcityport.com  
**Location:** San Francisco Bay in Northern California - mid way between San Francisco and San Jose

**Equipment & Capacity:** Not applicable - Private equipment

**Bulk Berths:** 5 Wharves with 34 draught

## RESERVE

### Associated Terminals at Globalplex



ASSOCIATED TERMINALS

1342 Highway 44  
Reserve  
Louisiana  
70084  
USA

**Contact:** Mr Barry Hoth, Vice President

T: + 1 985 479 6358  
F: + 1 985 479 6360

E: barry@associatedterminals.com  
**W:** www.associatedterminals.com  
**Location:** Miles 136-141 Lower Mississippi River

**Equipment & Capacity:** Two dock-mounted gantry cranes, fleet of midstream stevedoring cranes as well as mobile cargo handling equipment

**Bulk Berths:** Five berths

**Total Uncovered Storage:** 177,000 sq ft

**Total Covered Storage:** 206,000 sq ft

Associated Terminals at Globalplex is one of the largest multiple purpose terminals on the Lower Mississippi River. Both bulk and breakbulk cargoes can be handled and stored in multiple warehouses as well as in open storage. Rail and truck connections are available.

## RICHMOND

### Levin Richmond Terminal Corporation (LRTC)

402 Wright Avenue  
Richmond  
CA 94804  
USA

**Contact:** Ms Barbara N. O'Neill, Vice President of Marketing

T: + 1 510 307 4009  
F: + 1 510 236 0129

E: barbara@levinterminal.com  
**W:** www.levinterminal.com

**Location:** West Coast of United States

**Equipment & Capacity:** Three 50-tonne diesel/hydraulic gantry cranes.

Two ship-loaders rated at 1,000tph.

**Bulk Berths:** 2 Berths, A-Berth Depth is -12.5m, 182.9m length. Berth, Depth is -9.1m, 243.8m length

**Total Uncovered Storage:** 12.14 hectares

**Total Covered Storage:** 15,850m covered storage being used for calcined petroleum coke.

Privately owned and operated diversified marine dry bulk facility.

Rail served by RPRC, which connects with the UPRR and BNSF.

## RICHMOND

### Port of Richmond

1411 Harbour Way South  
Richmond  
California CA 948404  
USA

**Contact:** Mr Jim Matzorkis, Executive Director

T: + 1 510 215 4600  
F: + 1 510 233 3105

E: Richmondport@yahoo.com

## ROANOKE

### Ashtabula Coal Pier

110 Franklin Road  
Roanoke  
VA 24042-0026  
USA

**Contact:** Mr Randy Carter, Director  
T: + 1 540 985 6795 / + 1 540 524-6044

F: + 1 540 985 6398  
E: Randy.Carter@nscorp.com

## SAINT PAUL

### Port of St Paul

Village Cove  
St Paul Port Authority  
PO Box 901  
Saint Paul  
Alaska  
AK 99660  
USA

**Contact:** Mr Larry Merculet, City Manager

T: + 1 907 546 3140  
F: + 1 907 546 3140

E: info@sppa.com

## SALT LAKE CITY

### Savage Companies

6340 South  
3000 East Suite 600  
Salt Lake City  
Utah 84121  
USA

**Contact:** Mr Nathan Savage, Director Marketing Coal & Petoake

T: + 1 801 944 6600

E: nathans@savagecompanies.com

## SAN DIEGO

### Port of San Diego

601 Switzer St  
10th Avenue marine Terminal  
San Diego  
California  
CA 92101-7811  
USA

**Contact:** Ms Marguerite Elicone, Principal PR/Marketing Representative

T: + 1 619 686 6281  
F: + 1 619 686 7288

E: helpdesk@portofsandiego.org  
**W:** www.portofsandiego.org

## SAN FRANCISCO

### Port of San Francisco

Pier 1, The Embarcadero  
San Francisco  
California  
CA 94111-4263  
USA

**Contact:** Mr Brendan O'Meara, Maritime Marketing Manager

T: + 1 415 274 0458  
F: + 1 415 274 0528

E: Brendan.O'Meara@sport.com  
**W:** www.sport.com

**Location:** West Coast of United States in Central California.

**Equipment & Capacity:** 6 gantry cranes

**Bulk Berths:** 6 deepwater berths

**Total Uncovered Storage:** 120,000sqm

Deep water berth and 40 acre facility available for future bulk handling operation.

## SAN PEDRO

### Los Angeles Export Terminal

160 W 6th Street  
San Pedro  
CA  
90731  
USA

**Contact:** Mr Jim Holland, T: + 1 562 436 5234

F: + 1 310 732 0107  
E: jeholland@axtinc.com

## SAN PEDRO

### Los Angeles Harbour Department

425 South Palos Verdes Street  
PO Box 151  
San Pedro  
CA  
90733  
USA

**Contact:** Mr Jim Mac Lellan, Director of Trade Services

T: + 1 310 732 3870  
E: jmaclellan@portla.org

## SAN PEDRO

### Marine Terminals Corporation

2001 John S. Gibson Blvd  
San Pedro  
CA  
90731  
USA

**Contact:** Mr Dan Wylie, Executive V P - General Stevedoring Operations

T: + 1 510 4 208 578  
F: + 1 510 5 479 352

E: danwyl@mtcorp.com

## SAN PEDRO

### Port of Los Angeles

PO Box 151  
San Pedro  
California  
90733-0151  
USA

**Contact:** Ms Geraldine Knatz, Executive Director

T: + 1 310 7323456  
F: + 1 310 8316936

E: kos-read@portla.org  
**W:** www.portoflosangeles.org



**SAN PEDRO**

**World Port LA (Port of Los Angeles)**  
425 S.Palos  
Verdes St  
PO Box 151  
San Pedro  
CA  
90733  
USA  
**Contact:** Ms Geraldine Knatz, Executive Director  
T: + 1 310 732 7678  
E: gknatz@portla.org  
W: www.portoflosangeles.org

**SANDUSKY**

**CT Stevedoring**  
2705 West Monroe Street  
PO Box 2647  
Sandusky  
OH  
44870  
USA  
**Contact:** Mr Ron House, General Manager  
T: + 1 419 626 0801  
F: + 1 419 626 8248  
E: Ron.house@coopertsmith.com  
W: www.coopertsmith.com

**SANDUSKY**

**Sandusky Dock Corporation, Pier #3**  
2705 West Monroe Street  
PO Box #899  
Sandusky  
Ohio  
44870  
USA  
**Contact:** Mr Jeff Smith, Superintendent  
T: + 1 419 626 1215  
F: + 1 419 483 1296  
E: jeff.smith@nscorp.com  
W: www.nscorp.com  
**Location:** Pier #3 is nearly a mile in length and surrounded on three sides by the waters of Sandusky Bay, Ohio, USA  
**Equipment & Capacity:** Ship-loader is capable of loading 9,000 tons per hour (cars and reclaim combined) with a 75' outboard reach

**SAVANNAH**

**Georgia Ports Authority USA**  
PO Box 2406  
Savannah  
Georgia  
31402  
USA  
**Contact:** Mr Bill Jakubsen, Global Manager, Ro-Ro, Bulk & General Cargo  
T: + 1 912 964 3891  
F: + 1 912 964 3869  
E: bjakubsen@gaports.com  
W: www.gaports.com  
**Location:** Georgia's deepwater ports of Savannah & Brunswick are geographically positioned on the U.S. East Coast, centrally located to service the U.S. Southeast and Midwest.  
**Equipment & Capacity:** The GPA maintains an extensive inventory of bulk handling equipment. Visit www.gaports.com for handling equipment details by terminal and port. Or, email bjakubsen@gaports.com.  
**Bulk Berths:** Deepwater Berthing, All Terminals  
Visit www.gaports.com for berthing details by terminal and port. Or, email bjakubsen@gaports.com.  
**Total Uncovered Storage:** Multiple Terminal Operations combining to provide over 85 ha of open storage.  
**Total Covered Storage:** Multiple Terminal Operations combining to provide 190,500sqm of covered storage.  
Port of Brunswick:

1. East River Bulk Terminal in Brunswick, Georgia has been leased to Logistec USA. Contact bjakubsen@gaports.com for additional information.

**SAVANNAH**

**Metro Ports**  
16 Foundation Drive  
Garden City  
Savannah  
GA  
31408  
USA  
**Contact:** Mr Dave Parrott, Director of Operations  
T: + 1 912 965 1770  
F: + 1 912 963 5640  
E: david.parrott@metroports.com  
W: www.metroports.com  
**Location:** Port of Savannah Berth 1A

**SEATTLE**

**Port of Seattle**  
Pier 69  
PO Box 1209  
Seattle  
WA 98111  
USA  
**Contact:** Mr Mic Dinsmore, Executive Director  
T: + 1 206 728 3000  
F: + 1 206 728 3754  
E: info@portseattle.org  
W: www.portseattle.org

**SEATTLE**

**Stevedoring Services of America**  
1131 SW Klickitat Way  
Seattle  
WA  
98134  
USA  
**Contact:** Pay Roll  
T: + 1 206 623 0304  
F: + 1 206 623 0179  
E: info@ssamarine.com  
W: www.ssofa.com

**SEWARD**

**Aurora Energy Services, LLC**  
PO Box 1789  
Seward  
Alaska  
99664  
USA  
**Contact:** Mr Victor Stoltz, General Foreman  
T: + 1 907 224 3120  
F: + 1 907 224 3921  
E: vstoltz@uisibelli.com  
**Location:** Seward, Alaska, USA  
**Equipment & Capacity:** Bucketwheel stacker reclaimer. Fixed position luffing & slewing shiploader. Load rate 700-1,000mtph.  
**Bulk Berths:** Berth type: dolphin 900ft (berth face), 1,360ft (dolphin to dolphin)  
**Total Uncovered Storage:** Stockpile capacity 190,000mt  
Year round ice free port

**SEWARD**

**Port of Seward**  
PO Box 167  
Seward  
Alaska  
AK 99664  
USA  
**Contact:** Mr Foster Singleton, Harbour Master  
T: + 1 907 2243331  
F: + 1 907 2247187  
E: harbormaster@cityofseward.net

**SKAGWAY**

**Port of Skagway**  
City of Skagway  
PO Box 415  
Skagway

Alaska  
AK 99840  
USA  
**Contact:** Mr Matt O'Boyle, Harbour Master  
T: + 1 907 983 2628  
F: + 1 907 983 3087  
E: m.oboye@skagway.org  
W: www.skagway.org

**St LOUIS**

**Bunge St Louis**  
PO Box 28500  
St Louis  
Missouri  
63146  
USA  
**Contact:** Mr Roy Tomson,  
T: + 1 314 292 2000  
E: bnaebusiness@bunge.com  
W: www.bungenorthamerica.com

**St LOUIS**

**Cahokia Marine Services**  
1441 Hampton Avenue  
St Louis  
MO  
63139  
USA  
**Contact:** Mr John Brereton, Vice President Marketing  
T: + 1 314 647 7529  
F: + 1 314 647 8084  
E: jbrereton@slay.com

**STAMFORD**

**Oxbow Carbon Minerals**  
850 Canal Street  
Stamford  
Connecticut  
CT 06902  
USA  
**Contact:** Mr Gary J. Dielsi, Vice President, Operations  
T: + 1 203 353 8888  
E: gary.dielsi@oxbow.com

**STOCKTON**

**Metropolitan Stevedore Company**  
2321 West Washington Street  
Suite J  
Stockton  
CA  
95203  
USA  
**Contact:** Mr Thomas Mogan, Terminal Manager  
T: + 1 209 943 7252  
F: + 1 209 943 2656  
E: thomas.mogan@metsteco.com  
W: www.metsteco.com  
**Location:** California Delta  
**Equipment & Capacity:** 3,000 Mtpm  
**Bulk Berths:** 11.3m Draught; 335m Berth (with Dolphins)  
**Total Uncovered Storage:** 48,600 sqm (Other Port tenants)  
**Total Covered Storage:** None  
Truck pit and rotary rail car tipper

**STOCKTON**

**Port of Stockton**  
2201 W. Washington Street  
Stockton  
CA  
95203  
USA  
**Contact:** Mr Jason Katindoy, Director of Maritime Operations  
T: + 1 209 946 0246  
F: + 1 209 466 5986  
E: jkatindoy@stocktonport.com  
W: www.portofstockton.com  
**Location:** 75 nautical miles (120 km) East from San Francisco Bay, California USA.  
**Equipment & Capacity:** Bulk export loading tower  
**Bulk Berths:** Average channel depth of 10.6m  
**Total Uncovered Storage:** 809 hectares

**Total Covered Storage:** 715,000 sqm  
Served by both Union Pacific & BNSF RR  
Adjacent to Interstate 5, with over 600 acres available for development.

**STOCKTON**

**Sunshine Cement, Inc**  
Suite I  
2321 West Washington  
Stockton  
CA 95203  
USA  
**Contact:** Mr Randy Snyder, VP / GM  
T: + 1 209 467 8325  
F: + 1 209 467 8065  
E: rsnyder@sunshinecement.com

**SUPERIOR**

**Cenex Harvest States**  
41 Dock St  
PO Box 518  
Superior  
WI  
54880  
USA  
**Contact:** Mr Lance Helgeson, Superintendent  
T: + 1 715 392 4734  
F: + 1 715 394 6926  
E: lance.helgeson@chsinc.com

**SUPERIOR**

**Peavy Company - Connor's Point Elevator**  
400 N Mail Street  
PO Box 937  
Superior  
WI  
54880  
USA  
**Contact:** Mr Mick Sertich, Superintendent  
T: + 1 715 392 9853  
F: + 1 715 392 9874  
E: msertich@conagrains.com

**SUPERIOR**

**Superior Midwest Energy Terminal**  
PO Box 787  
Superior  
Wisconsin  
54880  
USA  
**Contact:** Mr Fred Shusterich, Vice President  
T: + 1 715 392 9807  
F: + 1 715 392 9137  
E: fshusterich@midwestenergy.com  
W: www.midwestenergy.com

**TACOMA**

**Port of Tacoma**  
PO Box 1837  
Tacoma  
WA  
98401  
USA  
**Contact:** Mr Larry Kvidera, Manager, Marketing & Trade, Commercial Team  
T: + 1 253 428 8650  
E: lkvidera@portoftacoma.com  
W: www.portoftacoma.com  
**Location:** Pacific Northwest on the U.S. West Coast  
**Equipment & Capacity:** Cargill Grain Terminal (TEMCO) - Elevator Capacity: 105,517 kiloliters  
- Loading capacity: 3 shipping belts with capacity of 40,000 bushels per hour each; two shipping legs with capacity of 3,600 short tons per hour each  
**Bulk Berths:** Cargill Grain Terminal (TEMCO) - 4.5 hectares, 1 dolphin pier, -22.3 meters MLLW - privately operated

West Hylebos Log Facility - 6.5 hectares, 1-305 meter berth, - 10 to -12 meters at MLLW - privately operated  
Tacoma is a leading North American seaport, handling more than \$52 billion in international trade in 2015. In addition to bulk and breakbulk, the Port also handles containers and automobiles.

**TACOMA**

**Stevedoring Services of America**  
1980 Milwaukee Way  
Tacoma  
WA 98421  
USA  
**Contact:** Mr Bob Luxa, General Manager  
T: + 1 253 383 1763  
F: + 1 253 272 9570  
E: robert.luxa@ssamarine.com  
W: www.ssamarine.com

**TALLAHASSEE**

**Florida Ports Council**  
315 Calhoun Street  
Suite 712  
Tallahassee  
FL  
32301  
USA  
**Contact:** Mr Michael Rubin,

**TAMPA**

**Kinder Morgan Terminals - Tampaplex Terminal**  
Southeast Regional Office  
4942 Port Sutton Road  
Tampa  
Florida  
33619  
USA  
**Contact:** Mr Roy Cook,  
T: + 1 414 769 1901 ext-120  
F: + 1 414 769 1144  
E: roy\_cook@kindermorgan.com  
W: www.kindermorgan.com

**TAMPA**

**Tampa Bay Stevedores Ltd**  
4801 Port Sutton Road  
Tampa  
Florida  
33619  
USA  
**Contact:** Mr William Rudolph,  
T: + 1 813 248 1971  
F: + 1 813 242 8011

**TAMPA**

**Tampa Port Authority**  
1101 Channelside Drive  
Tampa  
Florida  
33602  
USA  
**Contact:** Mr Greg Lovelace, Director of Marketing  
T: + 1 813 9055123  
F: + 1 813 9055109  
E: glovelace@tampaport.com  
W: www.tampaport.com  
**Location:** Central west coast of Florida (USA)  
**Bulk Berths:** max draft/berth dimension: max alongside/height of dock face/commmodities handled:  
berth 1: 10.28m/198m/2.28m/scrapp  
berth 2: 10.21m/198m/2.28m/liquid sulphur  
berth 3: 9.44m/168m/2.28m/cement  
berth 21: 5.8m/137m/2.4m  
berth 22: 10.4m/213m/3m/liquid sulphur  
berth 23: 10.5m/304m/3.65m/fertilizer  
berth 24: 10.28m/217.9m/2.4m/chemical  
berth 24b: 4.3m/68.5m/1.9m/bergahe  
berth 26: 9.6m/243.8m/3.35m/cement, aggregate  
berth 30: 13.1m/304.7m/2.6m/LPG  
berth 31: 13.1m/304.7m/2.6m/cement, aggregate  
berth 204: 10.3m/280m/3m/fertilizer

berth 205: 10.3m/176.7m/2.6m/juice  
berth 219: 11.4m/263.6m/3.35m/bulk  
berth 220: 12.4m/274m/3.35m/bulk  
berth 223: 10.2m/228.5m/2.4m/petro  
berth 224: 4.2m/54.8m/2.4m/bulk  
berth 226: 12.1m/268m/2.4m/petro  
berth 227: 12.1m/268m/2.4m/petro  
berth 256: 10.28m/230m/3.04m/dry bulk  
**Total Uncovered Storage:** Contact Tampa Port Authority  
**Total Covered Storage:** Contact Tampa Port Authority  
As Florida's largest port, Tampa handles nearly 50 M tpa, or half of the State of Florida's total seaborne cargo tonnage.

**TAMPA**

**United Maritime Group**  
601 S Harbour Island Boulevard  
Suite 230  
Tampa  
Florida  
33602  
USA  
**Contact:** Mr Robin Hastings, Vice President, Commercial  
T: + 1 813 209 4218  
F: + 1 813 273 0248  
E: sales@united-mar.com  
W: www.unitedmaritimegroup.com

**TEXAS CITY**

**Port of Texas City**  
Texas City Terminal Railway Co  
2425 Highway 146 N  
Texas City  
TX 77590  
USA  
**Contact:** Mr Dennis Jennings, Director of Rail Operations  
T: + 1 409 945 4461(x23)  
F: + 1 409 945 8479  
E: info@railporttc.com  
W: www.railporttc.com

**THEODORE**

**Millard Maritime**  
7730 Deer River Road  
Theodore  
AL 36582  
USA  
**Contact:** Mr Bobby Wein, Vice President, Business Development  
T: + 1 251 443 6743  
E: bwein@millardmaritime.com  
W: http://millardmaritime.com/

**TOLEDO**

**ADM Grain Company Ltd**  
1301 Miami St.  
Toledo  
Ohio  
43605  
USA  
**Contact:** Mr Marty Wendt, Regional Manager, Northern Ohio & Michigan  
T: + 1 419 324 0800  
F: + 1 419 324 0791  
E: marty\_wendt@admworld.com  
W: www.admworld.com  
**Location:** Lake Erie  
**Equipment & Capacity:** Load and discharge vessels  
**Bulk Berths:** 2 berths  
**Total Covered Storage:** 9.2 million bushel  
CSXT 65 car train Loader. Can also unload covered hoppers. In addition, Inbound and Outbound trucks.

**TOLEDO**

**CSX Coal Dock**  
PO Box 8279  
Station A  
Toledo  
OH 43605  
USA  
**Contact:** Mr Paul LeCompte,  
T: + 1 419 697 2353  
F: + 1 419 697 2320  
E: paul\_lecompte@csx.com  
W: www.csx.com

## TOLEDO

**Midwest Terminals of Toledo International, Inc**  
3518 St. Lawrence Drive  
Toledo  
OH  
43605  
USA

**Contact:** Mr Jason Lowery, Director of Business Development  
T: + 1 419 897 6868 ext 211  
F: + 1 419 691 7016  
E: jason.lowery@mwiti.com

**W:** www.midwestterminals.com  
**Location:** Great Lakes (West end of Lake Erie)

**Equipment & Capacity:** 6 shore cranes, ship loading conveyor  
**Bulk Berths:** 7 berths for a total of 4,000 feet of dock frontage  
**Total Uncovered Storage:** 100 acres

**Total Covered Storage:** 675,000 square feet

- Located at the mouth of the Maumee River with no air draught restrictions
- Seaway Draught at all berths
- 24 hour discharge service
- Foreign Trade Zone
- NYMEX approved warehouse space
- Central location to several markets; 40 percent of US households within 10 hours
- Truck and Rail served

## TOLEDO

**Toledo-Lucas County Port Authority**

One Maritime Plaza, 7th Floor  
Toledo  
Ohio  
43604  
USA

**Contact:** Mr Joseph Cappel, Vice President, Business Development  
T: + 1 419 243 8251  
F: + 1 419 243 1835

E: jcappel@toledoport.org  
**W:** www.toledoport.org  
**Location:** Western Basin of Lake Erie at the mouth of the Maumee River.

**Equipment & Capacity:** General Cargo Facility (Midwest Terminals of Toledo International Inc.) has mobile harbor cranes and gantry cranes for bulk, project cargo, break-bulk handling. Ship loading conveyor system, hoppers and loaders for bulk material handling, on-dock rail, FTZ #8, warehousing, LME and NYMEX approved facility.

**Bulk Berths:** General Cargo Facility (Midwest Terminals of Toledo International Inc.) has 1,250 m. of dock frontage with a Seaway draft of 8.5 m. accommodates multiple loaded vessels with no air draft restrictions.

**Total Uncovered Storage:** 1,133,120sqm

**Total Covered Storage:** 62,710sqm  
As the most cargo diverse and largest land mass Port on the Great Lakes, we have a terminal to match your cargo's handling requirements and your logistics needs. Please contact the Toledo-Lucas County Port Authority for additional information.

## VALDEZ

**Port of Valdez**

PO Box 307  
Valdez  
Alaska  
AK 99686  
USA

**Contact:** Ms Diane Kinney, Ports & Harbour Director  
T: + 1 907 835 4564  
F: + 1 907 835 4479  
E: portofvaldez@ci.valdez.ak.us

**W:** www.ci.valdez.ak.us/port

**Location:** Valdez, Alaska

## VANCOUVER

**Port of Vancouver, USA**

3103 Lower River Road  
Vancouver  
Washington  
98660  
USA

**Contact:** Mr Alastair Smith, Sr. Director of Marketing and Operations  
T: + 1 360 693 3611  
F: + 1 360 735 1565  
E: info@portvanusa.com

**W:** www.portvanusa.com

**Location:** Pacific Northwest on the Columbia River approximately 106 miles from the Pacific Ocean.  
**Equipment & Capacity:** Liebherr 500S model Crane capable of 140 tonnes. P&H Crane/80 tonne capacity. Paccoc Crane/ 53 tonne capacity w/spreader bar. Big Washington Crane/60 tonne capacity.

**Bulk Berths:** Grain Elevator, Berth 1  
715' length w/dolphins  
Depth: 40' draught  
One mobile gantry spout served by conveyor system, one marine leg serving belt conveyor, silos. Total storage capacity about 5 million bushels.

**Bulk Berths:** Grain Elevator, Berth 1

715' length w/dolphins  
Depth: 40' draught  
One mobile gantry spout served by conveyor system, one marine leg serving belt conveyor, silos. Total storage capacity about 5 million bushels.

Dry bulk dock, Berth 7

800' length

Depth: 40' draft

Telescoping conveyor loader

**Total Uncovered Storage:** 250 acres of open storage and marshalling yards

**Total Covered Storage:** 1,194,610 sq feet

Accessible by river, road and rail, the Port of Vancouver, USA is well-equipped to handle all kinds of bulk cargo including mineral concentrates, bentonite clay, copper concentrates, bauxite, hydrate aluminum and ores.

## VANCOUVER

**United Grain Corp**

900 Washington Street  
Suite 700  
Vancouver  
WA  
98660  
USA

**Contact:** Mr Augusto Bassanini, CEO

T: + 1 360 816 1901

E: abassanini@ugcprnw.com

**W:** www.ugcprnw.com

**Location:** Pacific Northwest

## VANCOUVER

**Vancouver-United Grain Elevator**

1927 Elevator Way

Vancouver

Washington

98660

USA

**Contact:** Mr John Todd, Manager

T: + 1 360 693 1521

F: + 1 360 694 1986

E: jtodd@unitedharvest.com

## WHEELERSBURG

**Norfolk Southern - Wheelersburg Terminal**

110 Franklin Road

Roanoke

Virginia

24042-0026

USA

**Contact:** Mr Randy Carter, Director

Industrial Coal Marketing & Transloading

T: + 1 540 985 6795

F: + 1 540 985 6398

E: Randy.Carter@nscorp.com

**W:** www.nscorp.com

## WHITTIER

**Whittier Port Authority Commission**

PO Box 639

Whittier

Alaska

99693

USA

**Contact:** Mr Kyle Sinclair, Harbourmaster

T: + 1 907 4722327 Ext 113

F: + 1 907 4722472

E: harbormaster@whittieralaska.gov

**W:** www.whittieralaska.gov

## WILMINGTON

**Metro Ports**

2601 Iron Gate Drive

Suite 202

Wilmington

NC

28412

USA

**Contact:** Mr Ted H Winter, Vice President Business Development

T: + 1 310 816 6545

F: + 1 910 798 6188

E: ted.winter@metroports.com

**W:** www.metroports.com

**Location:** Port of Wilmington

## WILMINGTON

**Metropolitan Stevedoring Company**

PO Box 547

Wilmington

California

90748

USA

**Contact:** Mr Malcolm Pitt,

T: + 1 562 983 8425

F: + 1 562 983 8520

E: malcolm.pitt@metstecco.com

**W:** www.metstecco.com

**Location:** USA; South California, Port of Long Beach

**Equipment & Capacity:** 2 travelling shiploaders. #1 - 2,500 MT/Hour, #2 - 5,000 MT/Hour

**Bulk Berths:** 1548m - wharf. 5.24m Draught - Berth 212.

12.2m Draught - Berth 214

**Total Uncovered Storage:** 12,787 sqm

**Total Covered Storage:** 81,550 sqm (5 Port Tenants)

2 truck receiving pits, rotary rail car tipper, 2 rail bottom dumps.

## WILMINGTON

**North Carolina State Ports Authority/ Wilmington**

PO Box 9002

2202 Burnett Road

Wilmington

NC

28402

USA

**Contact:** Ms Susan Pridgen, Editorial Specialist, External Affairs

T: + 1 910 343 6492

E: susan.pridgen@ncports.com

**W:** www.ncports.com

**Location:** Located on the eastbank of the Cape Fear River

**Equipment & Capacity:** 7 container cranes, 2 gantry cranes, 4 x 100ft gauge container cranes to be delivered early 2007, 9 top-lift container handlers & various other cargo handling equipment.

**Bulk Berths:** 42' shipping channel, bulk and general cargo berths.

Open and covered storage dry bulk facility. Covered dry bulk facility w/2.5 million cubic foot storage capacity & import conveyor system for grain which can handle 1,000 tons per hour. Export woodchip facility.

**Total Uncovered Storage:** 80 acres of paved, open area; nearly 25 acres of semi-improved open storage area.

**Total Covered Storage:** Almost 1 million sq. ft. of covered, sprinklered storage.

Nearly 100 acres available for dev. North of present terminal. 94 acres available for development South of present terminal.

## WILMINGTON

**Pasha Stevedoring & Terminals**

802 S Froses Ave

Wilmington

CA

9074

USA

**Contact:** Mr Fred Vanderventer, VP, Contract Administration

T: + 1 310 233 2000

E: fred.vanderventer@psterminals.com

**W:** www.psterminals.com/

**Location:** Port of Los Angeles, California

Berths 174-181

Berths 153-155,

Berths 207-209

**Equipment & Capacity:** Forklifts 2T-45T For all cargoes, Top handlers, Side Handlers, Mafi Trailers, Bobcats & UTR's, 3-41mt hammerhead shore cranes

**Bulk Berths:** 174-181-40 acres - 255,000 ft transit shed/storage, Water depth 35ft-45ft Rail access, 3300 Linear feet berth space

153-155 - 12 acres - 180,000 ft covered storage, water depth 32-35 ft, 1700 linear feet berth space

207-209-86 acres - 2180 linear feet berth space, 40-45 water depth, 50,000 ft covered space

With supporting omni-terminal operations, and diversified in international vessel loading, Pasha Stevedoring & Terminals excels in containers, breakbulk, steel, and heavy-lift cargo, providing personalized solutions for faster, safer shipments.

**Wilmington**

**Port of Wilmington, Delaware/Diamond State Port Co**

Robert F. Senseny Administration

Building

1 Hausel Road

Wilmington

Delaware

19801-5852

USA

**Contact:** Mr Gene Bailey, Executive Director

T: + 1 302 472 7802

F: + 1 302 472 7825

E: gbailey@port.state.de.us

**W:** www.portofwilmington.com

**Location:** Mid-Atlantic Port on the confluence of the Christina and Delaware Rivers, 65 miles from the Atlantic

**Equipment & Capacity:** Two 50 ton capacity gantry container/bulk cranes

**Bulk Berths:** 7 deep-water berths on the Christina and another berth on the Delaware River

**Total Uncovered Storage:** 33 acres on-dock, adjacent off-site storage and distribution facilities available

**Total Covered Storage:** 250 sf of dry warehouse, adjacent off-site storage and distribution facilities available

Specialized services:

Product tarping, scale weighs, project management, engineering oversight, customized on-site processing, site facilitating, inventory management, material bagging / packaging, palletizing, material sizing, material blending, crushing / Screening, dust management / control, in-plant operations, rail access.

**VENEZUELA**

**ESTADO**

**Venterminals**

Apartado 234

Puerto Cabello

Estado

Carabobo

Venezuela

**Contact:** Mr Johan Vermeulen,

T: + 58 242 769 647

F: + 58 242 769 358

E: agemar@agemar.com.ve

**GUIDAD GUAYANA**

**Interalumina**

Zone Ind Mantanzas Apt 289

Estado Boliver

Guidad Guayana

Venezuela

**Contact:** Mr L. Mok, Gerente de Planta

T: + 58 212 911 411

F: + 58 212 911 411

E: info@interalumina.com.ar

**MARACAIBO**

**BDV - Bulkguasare de Venezuela, SA**

(subsidiary of Coeclerici Logistics SPA)

Calle 77

Esq. Av 3C - Edif. Los Cerros

Piso 4. of 4B

Maracaibo

Zulia

4001

Venezuela

**Contact:** Captain Guido Villani, Terminal Manager

T: + 58 414 364 1331

F: + 58 261 793 3576

E: guidu200@hotmail.com

**W:** www.coeclerici.com

**Location:** Lake of Maracaibo

**Equipment & Capacity:** 8,000,000tpa

**Bulk Berths:** Max Beam: 44m

**Total Covered Storage:** 60,000

Commercial Contact: Capt

Giordano Scotto Coeclerici Logistics

Spa- Piazza Diaz 7- 20123 Milan-

email: newprojects@coeclerici.com

## MARACAIBO

**Carbones del Guasare SA**

Centro De Operaciones Guasare

Av 9B Edif Banco

Industrial Piso 5

Maracaibo

Zulia

4001

Venezuela

**Contact:** Mr Jose Rios, Marketing

T: + 58 261 797 3831

F: + 58 261 790 6664

E: jrios@guasare.com

**W:** www.guasare.com

## MARACAIBO

**Port Authority of Maracaibo**

Av 2 El Milagro

Modulo de



# PORTS & TERMINALS COMMODITIES HANDLED

**KEY:**

- CL = coal
- CC = coking coal
- PC = petcoke
- G-A = grain/agribulk
- AF = animal feed
- CM = cement
- CLK = clinker
- IO = iron ore
- BX = bauxite
- AL = alumina
- FR = fertilizer
- G-FGD = gypsum & FGD
- AG = aggregates
- SU = sugar
- SOY = soya products
- SODA = soda ash
- MIN = mineral concentrates
- CHEM = powdered chemicals
- BIO = biomass
- R/M = recycled materials
- BC = bagged cargoes
- FRS = forest products
- STL = steel products
- P&P = pulp & paper
- MB = minor bulks
- OTH = other commodities



Port of Longview.

COMMODITIES	CL	CC	PC	G-A	AF	CM	CLK	IO	BX	AL	FR	G-FGD	AG	SU	SOY	SODA	MIN	CHEM	BIO	R/M	BC	FRS	STL	P&P	MB	OTH	
<b>ALBANIA</b>																											
<b>Durres</b>																											
Port Authority of Durres				✓																							
<b>ALGERIA</b>																											
<b>Algiers</b>																											
Entreprise Portuaire d'Alger																											
<b>Annaba</b>																											
Entreprise Portuaire de Annaba	✓	✓		✓	✓	✓	✓	✓			✓			✓	✓	✓		✓			✓	✓	✓	✓	✓	✓	✓
<b>Bejaia</b>																											
Entreprise Portuaire de Bejaia																											
<b>Beni Saf</b>																											
Entreprise Portuaire de Beni Saf																											
<b>Ghazaouet</b>																											
Port Authority of Ghazaouet	✓			✓							✓																
<b>Mostaganem</b>																											
Entreprise Portuaire de Mostaganem																											
<b>Skikda</b>																											
Entreprise Portuaire de Skikda				✓																							
<b>ANGOLA</b>																											
<b>Lobito</b>																											
Porto do Lobito E.P.				✓	✓	✓	✓	✓	✓		✓		✓		✓							✓	✓	✓	✓	✓	✓
<b>Luanda</b>																											
Cabinda Gulf Oil Company Limited																											
<b>Luanda</b>																											
Porto de Luanda								✓																			
<b>ARGENTINA</b>																											
<b>Bahia Blanca</b>																											
Bahia Blanca Port																											
Bahia Blanca				✓																							
Glencore/Toepfer Grain Elevator																											
Bahia Blanca				✓																							
Oleaginosa Moreno Hermanos SA																											
Bahia Blanca				✓																							
Puerto De Bahia Blanca																											

# COMMODITIES HANDLED

COMMODITIES	CL	CC	PC	G-A	AF	CM	CLK	IO	BX	AL	FR	G-FGD	AG	SU	SOY	SODA	MIN	CHEM	BIO	RM	BC	FRS	STL	P&P	MB	OTH	
<b>Bahia Blanca</b>																											
Terminal Bahia Blanca, Piers 5/6, 7/8/9				✓																							
<b>Barranqueras</b>																											
Puerto de Barranqueras						✓		✓																			
<b>Buenos Aires</b>																											
ACA Berth - San Lorenzo Port				✓																							
ACA Berth Nbr 3 - Quequen Port				✓																							
Del Bene SA				✓																							
Quebracho Elevator				✓																							
SA Berth				✓																							
Terminal 4				✓																							
Terminal Buenos Aires SA				✓																							
Terminal EMCYM				✓																							
Terminals Rio de la Plata																											
TPA Terminals Portuarias Argentinas																											
<b>Diamante</b>																											
Port of Diamante				✓																							
<b>Ensenada</b>																											
La Plata Port Administration								✓																✓	✓		
<b>Puerto General San Martin</b>																											
Terminal 6 S.A.				✓											✓												
<b>Quequen</b>																											
Consorcio de Gestion del Puerto de Quequen				✓							✓				✓											✓	
<b>Rosario</b>																											
Neptun SA - Operadores Maritimos				✓																							
<b>San Lorenzo</b>																											
Port of San Lorenzo				✓																							
<b>San Pedro</b>																											
Terminal Puerto San Pedro S.A.				✓							✓											✓		✓	✓		
<b>Santa Fe</b>																											
Administration Puerto Santa Fe				✓																					✓	✓	
<b>Villa Constitucion</b>																											
Villa Constitucion Port Authority				✓				✓															✓		✓	✓	
<b>Zarate</b>																											
Zarate Port SA											✓							✓			✓	✓	✓				
<b>ARUBA</b>																											
<b>Oranjestad</b>																											
Port of Oranjestad													✓														
<b>San Nicolas</b>																											
San Nicolas Bay Port			✓								✓																
<b>AUSTRALIA</b>																											
<b>Adelaide</b>																											
Flinders Ports Pty Ltd						✓																					✓
<b>Adelaide</b>																											
Flinders Ports Pty. Ltd				✓	✓	✓	✓	✓			✓					✓	✓					✓				✓	
<b>Adelaide</b>																											
Port Giles Grain Terminal				✓																							
<b>Adelaide</b>																											
Port Pirie Grain Terminal Berth 2				✓																							
<b>Adelaide</b>																											
SACBH Ardrossan Grain Terminal				✓																							



COMMODITIES	CL	CC	PC	G-A	AF	CM	CLK	IO	BX	AL	FR	G-FGD	AG	SU	SOY	SODA	MIN	CHEM	BIO	R/M	BC	FRS	STL	P&P	MB	OTH
<b>Adelaide</b>																										
Thevenard Grain Terminal				✓																						
<b>Adelaide</b>																										
Walleroo Grain Terminal Berth 2				✓																						
<b>Albany</b>																										
Port of Albany				✓							✓															
<b>Bondi Junction</b>																										
ADM				✓	✓						✓			✓	✓											
<b>Brisbane</b>																										
Cape Flattery																									✓	
<b>Brisbane</b>																										
Mitchell Ports																										
<b>Brisbane</b>																										
North Queensland Bulk Ports Corp Ltd	✓	✓		✓					✓		✓			✓												✓
<b>Brisbane</b>																										
Port Weipa									✓																	✓
<b>Brisbane</b>																										
Queensland Bulk Handling Coal Export Term	✓																									
<b>Bunbury</b>																										
Southern Ports Authority - Port of Bunbury				✓	✓						✓	✓											✓			✓
<b>Burnie</b>																										
Tasmanian Ports																										
<b>Cairns</b>																										
Ports North											✓			✓												✓
<b>Carrington</b>																										
GrainCorp Operations Ltd				✓																						
<b>Carrington</b>																										
Newcastle Agri Terminal				✓																						
<b>Carrington</b>																										
Port Waratah Coal Services Limited (PWCS)	✓																									
<b>Dampier</b>																										
Dampier Port Authority									✓																	✓
<b>Darwin</b>																										
Darwin Port Corporation									✓																	✓
<b>Darwin</b>																										
P&D Automotive and General Stevedoring	✓			✓	✓	✓	✓	✓			✓	✓			✓	✓	✓	✓			✓	✓	✓	✓	✓	✓
<b>East Davenport</b>																										
P & O Automotive & General Stevedoring									✓																	
<b>East Perth</b>																										
James Point Pty Ltd (JPPL)																										
<b>Esperance</b>																										
Esperance Ports - Sean & Land				✓					✓		✓						✓									✓
<b>Fremantle</b>																										
Fremantle Ports	✓			✓							✓															✓
<b>Geelong</b>																										
Geelong Port				✓	✓		✓		✓	✓	✓	✓	✓	✓	✓	✓	✓					✓	✓	✓	✓	✓
<b>Geraldton</b>																										
Geraldton Port Authority				✓					✓		✓							✓								✓
<b>Gladstone</b>																										
Barney Point Coal Terminal	✓																									
<b>Gladstone</b>																										
Central Queensland Ports Authority												✓														✓
<b>Gladstone</b>																										
Gladstone Ports Corporation	✓	✓	✓	✓		✓	✓		✓	✓		✓	✓	✓							✓	✓			✓	✓
<b>Gladstone</b>																										
Grainco Queensland Gladstone Term Berth 2				✓																						
<b>Hastings</b>																										
Port of Hastings Authority																								✓		✓
<b>Kooragang Island</b>																										
Newcastle Coal Infrastructure Group	✓																									
<b>Mackay</b>																										
BMA Hay Point Services	✓																									
<b>Mackay</b>																										
Dalrymple Bay Coal Terminal (DBCT)	✓																									
<b>Melbourne</b>																										
Port of Melbourne Corporation										✓				✓												
<b>Newcastle</b>																										
Newcastle Port Corporation	✓	✓	✓	✓	✓	✓			✓	✓	✓				✓	✓	✓	✓			✓	✓	✓	✓	✓	✓
<b>North Sydney</b>																										
Patrick Stevedores Operations Pty Limited				✓	✓						✓											✓	✓	✓	✓	✓
<b>Perth</b>																										
CBH Albany Grain Terminal				✓																						

# COMMODITIES HANDLED

COMMODITIES	CL	CC	PC	G-A	AF	CM	CLK	IO	BX	AL	FR	G-FGD	AG	SU	SOY	SODA	MIN	CHEM	BIO	R/M	BC	FRS	STL	P&P	MB	OTH	
<b>Perth</b>																											
CBH Esperance Grain Terminal				✓																							
<b>Perth</b>																											
CBH Geraldton Grain Terminal				✓																							
<b>Perth</b>																											
CBH Kwinana Grain Terminal				✓																							
<b>Pinekenba</b>																											
Grainco Queensland Pinekenba Terminal				✓																							
<b>Port Adelaide</b>																											
Flinders Ports - Port Pirie	✓			✓				✓			✓						✓						✓			✓	
<b>Port Hedland</b>																											
Port Hedland Port Authority								✓																		✓	
<b>Port Kembla</b>																											
Port Kembla Port Corporation	✓	✓		✓		✓	✓	✓	✓		✓	✓	✓	✓		✓	✓						✓	✓	✓	✓	
<b>Port Lincoln</b>																											
Flinders Ports P/L				✓							✓																
<b>Port of Brisbane</b>																											
Port of Brisbane Pty Ltd	✓			✓		✓	✓				✓	✓	✓	✓	✓	✓							✓	✓		✓	
<b>Portland</b>																											
Port of Portland Pty Ltd			✓	✓	✓					✓	✓											✓	✓	✓	✓	✓	✓
<b>Portland</b>																											
Vicgrain Portland Terminal				✓																			✓				
<b>Thevenard</b>																											
Thevenard Port				✓								✓															✓
<b>Toowoomba</b>																											
Grainco Queensland Fisherman Island Term				✓																							
<b>Townsville</b>																											
Port of Townsville Limited		✓		✓	✓	✓		✓			✓			✓			✓							✓	✓		✓
<b>Walsh Bay</b>																											
Sydney Ports Corporation				✓		✓		✓			✓			✓										✓			
<b>West Perth</b>																											
Co-Operative Bulk Handling Ltd				✓																							
<b>Wollongong</b>																											
Port Kembla Coal Terminal Limited	✓		✓					✓				✓															
<b>Wollongong</b>																											
Port Kembla Grain Terminal -				✓																							
<b>Wyndham</b>																											
CGL Wyndham Port					✓													✓				✓					✓
<b>Wynnum Central</b>																											
Patrick Stevedores																										✓	✓
<b>BAHAMAS</b>																											
<b>Freeport</b>																											
Grand Bahama Port Authority																											
<b>BAHRAIN</b>																											
<b>Manama</b>																											
Mina Salman Port Authority			✓						✓																		
<b>BANGLADESH</b>																											
<b>Chittagong</b>																											
Chittagong Port Authority				✓		✓					✓																
<b>BARBADOS</b>																											
<b>Bridgetown</b>																											
Barbados Port Authority						✓								✓													
<b>BELGIUM</b>																											
<b>Antwerp</b>																											
Alfaport Antwerpen	✓			✓		✓					✓			✓									✓	✓	✓		
<b>Antwerp</b>																											
Antwerp Bulk Terminal (ABT)	✓						✓	✓	✓		✓	✓	✓													✓	
<b>Antwerp</b>																											
Antwerp Port Authority	✓			✓	✓	✓	✓	✓	✓		✓	✓	✓	✓									✓	✓	✓	✓	
<b>Antwerp</b>																											
Boortmalt Group				✓																							
<b>Antwerp</b>																											
Euroports Belgium NV									✓		✓			✓		✓											
<b>Antwerp</b>																											
Havenbedrijf Antwerpen NV	✓	✓	✓	✓	✓	✓	✓	✓	✓	✓	✓	✓	✓	✓	✓	✓	✓	✓	✓	✓	✓	✓	✓	✓	✓	✓	✓
van publiek recht																											
<b>Antwerp</b>																											
Manuport Logistics NV						✓		✓	✓		✓			✓										✓			
<b>Antwerp</b>																											
SCR - Sibelco																										✓	



COMMODITIES	CL	CC	PC	G-A	AF	CM	CLK	IO	BX	AL	FR	G-FGD	AG	SU	SOY	SODA	MIN	CHEM	BIO	R/M	BC	FRS	STL	P&P	MB	OTH	
<b>Brasschaat</b>																											
United Bulk Terminals																											
<b>Brugge</b>																											
Firma Germain D'Hoore - Ostende																											
<b>Gent</b>																											
Arcelor Steel Belgium NV	✓		✓					✓																		✓	
<b>Gent</b>																											
Ensagent NV			✓						✓		✓																
<b>Gent</b>																											
Euro-Silo NV				✓																							
<b>Gent</b>																											
Ghent Coal Terminal NV - GCT	✓	✓	✓																				✓			✓	
<b>Gent</b>																											
Ghent Port Company ampc	✓	✓	✓	✓	✓	✓	✓	✓	✓	✓	✓	✓	✓	✓	✓	✓	✓	✓			✓	✓	✓	✓	✓	✓	✓
<b>Gent</b>																											
Ghent Transport & Storage				✓	✓			✓			✓		✓	✓	✓												
<b>Gent</b>																											
Mekol																											
<b>Gent</b>																											
Reyniers Havenbedryf NV											✓																
<b>Gent</b>																											
Stukwerkers Havenbedrijf NV				✓	✓						✓			✓									✓	✓	✓		✓
<b>Kallo</b>																											
Belgian Scrap Terminal NV																								✓			
<b>Kallo</b>																											
Metal Terminals International (MTI)																								✓			✓
<b>Liege</b>																											
Liege Port Authority	✓	✓	✓	✓	✓	✓	✓	✓	✓	✓	✓	✓	✓		✓		✓	✓				✓	✓	✓	✓	✓	✓
<b>Liege</b>																											
Terval S.A.	✓											✓															
<b>Oostende</b>																											
Ter Polder	✓				✓		✓			✓	✓						✓	✓				✓	✓		✓	✓	
<b>Puurs</b>																											
SMEG Belgium NV				✓																							
<b>Roeselare</b>																											
Van Eeckhout Vervoermaatschappij						✓																					
<b>Seraing</b>																											
CTB Logistics SA	✓	✓	✓	✓	✓		✓	✓			✓							✓					✓	✓		✓	
<b>Zeebrugge</b>																											
Devreese & Simon NV																											
<b>Zeebrugge</b>																											
Zeebrugse Behandelings Maatschappij																											
<b>BENIN</b>																											
<b>Cotonou</b>																											
Port Autonome de Cotonou																											
<b>BERMUDA</b>																											
<b>Hamilton</b>																											
Department Marine & Port Services						✓																					
<b>BRAZIL</b>																											
<b>Anchieta</b>																											
Port Authority of Ponta Uba								✓																			
<b>Angra dos Reis</b>																											
Port of Angra dos Reis				✓																							
<b>Aracruz</b>																											
Portocel-Terminal Especializado de Barra do Riacho																							✓		✓		
<b>Baia de Aratu</b>																											
Port of Aratu									✓		✓								✓								
<b>Belem</b>																											
Port Authority of Para				✓																							
<b>Belem</b>																											
Port of Belem				✓																							
<b>Fortaleza</b>																											
Port of Fortaleza				✓																							
<b>Ilheus</b>																											
Port of Ilheus				✓																							
<b>Imbituba</b>																											
Imbituba Port Authority	✓		✓								✓																
<b>Itaguaí</b>																											
CSN - Terminal de Carvão e Minério TECAR	✓																										

# COMMODITIES HANDLED

COMMODITIES	CL	CC	PC	G-A	AF	CM	CLK	IO	BX	AL	FR	G-FGD	AG	SU	SOY	SODA	MIN	CHEM	BIO	R/M	BC	FRS	STL	P&P	MB	OTH	
<b>Jaragua</b>																											
Port of Maceio				✓										✓													
<b>Manaus</b>																											
Port of Manaus				✓																							
<b>Município de Oriximiná</b>																											
Trombetas Port									✓																		
<b>Natal</b>																											
Natal Port Authority				✓																							
<b>Niteroi</b>																											
Port of Niteroi				✓																							
<b>Para State</b>																											
Port Authority of Vila Do Conde									✓																		
<b>Paranagua</b>																											
Paranagua Port Authority				✓																							
<b>Paranagua</b>																											
PFT-Paranaguá Forestry Terminals																						✓					
<b>Paranagua</b>																											
Port Silo/Socopar Berths 1/2; Gransol Berth 3				✓																							
<b>Pelotas</b>																											
Port of Pelotas				✓																							
<b>Porto Alegre</b>																											
Port of Porto Alegre	✓			✓																							
<b>Recife</b>																											
Port of Recife				✓										✓													
<b>Rio de Janeiro</b>																											
Cia Docas Do Rio de Janeiro																											
<b>Rio de Janeiro</b>																											
Companhia Portuaria Baia de Sepetiba																											
<b>Rio de Janeiro</b>																											
Petroleo Brasileiro SA-Petrobras				✓																							
<b>Rio de Janeiro</b>																											
Port of Forno				✓																					✓		
<b>Rio de Janeiro</b>																											
Rio de Janeiro Port Authority	✓							✓	✓		✓																
<b>Rio Grande</b>																											
Bianchini Terminal				✓																							
<b>Rio Grande</b>																											
Port of Rio Grande				✓				✓			✓																
<b>Salvador</b>																											
Port Authority of Salvador																											
<b>Santos</b>																											
Companhia Docas do Estado de São Paulo - CODESP	✓			✓	✓						✓			✓	✓	✓						✓	✓	✓			
<b>Santos</b>																											
Port of Santos	✓	✓						✓			✓			✓	✓												
<b>Sao Francisco do Sul</b>																											
Sao Francisco do Sul Port Authority	✓			✓				✓			✓												✓	✓		✓	
<b>Sao Luis</b>																											
Port of Ponta da Madeira				✓				✓	✓																		
<b>Sao Paulo</b>																											
Coinbra - Grain				✓																							
<b>Vitoria</b>																											
Capuaba Guay Grain Terminal/Port of Vitoria				✓																							
<b>Vitoria</b>																											
Port Authority of Espirito Santo				✓				✓																			
<b>Vitoria</b>																											
Tubarao Port Authority	✓		✓					✓																	✓		
<b>BULGARIA</b>																											
<b>Bourgas</b>																											
Bulk Terminal 2A	✓																										
<b>Bourgas</b>																											
Port of Bourgas JSC	✓	✓	✓	✓	✓		✓	✓	✓		✓			✓	✓		✓					✓	✓			✓	
<b>CAMBODIA</b>																											
<b>Sihanoukville</b>																											
Sihanoukville Autonomous Port (PAS)				✓																							
<b>CAMEROON</b>																											
<b>Douala</b>																											
Cameroon National Ports Authority																											
<b>Douala</b>																											
Delmas Cameroon (CMA-CGM Group)				✓					✓													✓					



COMMODITIES	CL	CC	PC	G-A	AF	CM	CLK	IO	BX	AL	FR	G-FGD	AG	SU	SOY	SODA	MIN	CHEM	BIO	R/M	BC	FRS	STL	P&P	MB	OTH	
<b>CANADA</b>																											
<b>Baie-Comeau</b>																											
Tessier Ltd						✓											✓					✓	✓		✓	✓	
<b>Becancour</b>																											
Becancour Waterfront Industrial Park	✓		✓	✓	✓				✓	✓					✓						✓		✓			✓	
<b>Belledune</b>																											
Eastern Canada Stevedoring																							4	4		4	
<b>Belledune</b>																											
Port of Belledune	✓	✓	✓								✓	✓	✓				✓				✓	✓		✓		✓	
<b>Burlington</b>																											
Lloyd's Register																											
<b>Churchill</b>																											
Hudson Bay Port Terminal				✓																							
<b>Contrecoeur</b>																											
Logistec	✓						✓	✓	✓		✓		✓				✓				✓					✓	
<b>Contrecoeur</b>																											
Terminal Maritime Contrecoeur Inc	✓	✓				✓	✓	✓	✓		✓						✓										
<b>Corner Brook</b>																											
Corner Brook Port Corporation						✓																					
<b>Dartmouth</b>																											
Port Authority of Georgetown																								✓			
<b>Delta</b>																											
Westshore Terminals	✓	✓	✓																								
<b>Goderich</b>																											
Southpier Terminals Limited				✓							✓																
<b>Guelph</b>																											
Parrish & Heimbecker				✓	✓								✓		✓												
<b>Halifax</b>																											
Halifax Grain Elevator Ltd				✓																							
<b>Halifax</b>																											
Halifax Port Corporation				✓																						✓	
<b>Hamilton</b>																											
Great Lakes Stevedoring Company Ltd																								✓		✓	
<b>Hamilton</b>																											
Hamilton Port Authority	✓		✓	✓			✓	✓			✓	✓	✓		✓								✓	✓		✓	
<b>Hamilton</b>																											
Richardson International Ltd				✓																							
<b>Johnstown</b>																											
Port of Johnstown				✓		✓					✓		✓	✓									✓	✓			
<b>La Baie</b>																											
Rio Tinto Alcan				✓					✓	✓							✓										
<b>Milford</b>																											
National Gypsum Co Ltd												✓															
<b>Montreal</b>																											
Federal Marine Terminals	✓					✓			✓					✓												✓	
<b>Montreal</b>																											
Les Silos Port-Cartier																											
<b>Montreal</b>																											
Logistec Corporation	✓				✓	✓	✓	✓	✓		✓	✓	✓	✓									✓	✓		✓	
<b>Montreal</b>																											
Montreal Port Authority (Grain Term)				✓																							
<b>Montreal</b>																											
Port of Montreal	✓	✓	✓	✓	✓	✓	✓	✓		✓	✓	✓	✓	✓	✓	✓	✓	✓	✓	✓	✓	✓	✓	✓	✓	✓	✓
<b>North Vancouver</b>																											
Kinder Morgan Canada Terminals Limited Partnership				✓	✓						✓						✓				✓				✓	✓	
<b>North Vancouver</b>																											
Neptune Bulk Terminals (Canada) Ltd		✓									✓																
<b>North Vancouver</b>																											
Richardson International Ltd				✓																							
<b>Nova Scotia</b>																											
Port of Hantsport												✓															
<b>Oshawa</b>																											
Oshawa Harbour Commission																								✓			
<b>Oshawa</b>																											
Oshawa Stevedoring Inc.				✓													✓						✓			✓	
<b>Ottawa</b>																											
Portha Inc																											
<b>Ottawa</b>																											
Transport Canada									✓																		
<b>Owen Sound</b>																											
Great Lakes Elevator				✓																							

# COMMODITIES HANDLED

COMMODITIES	CL	CC	PC	G-A	AF	CM	CLK	IO	BX	AL	FR	G-FGD	AG	SU	SOY	SODA	MIN	CHEM	BIO	R/M	BC	FRS	STL	P&P	MB	OTH
<b>Parrsboro</b>																										
Port Authority of Parrsboro																										
<b>Port Cartier</b>																										
Les Silos Port Cartier div.				✓																						
Louis Dreyfus Company Canada ULC.																										
<b>Port Colborne</b>																										
Port Colborne Grain Terminal				✓																						
<b>Port Moody</b>																										
Pacific Coast Terminals Co Ltd				✓							✓															
<b>Prince Rupert</b>																										
Prince Rupert Port Authority	✓	✓		✓																			✓	✓	✓	✓
<b>Prince Rupert</b>																										
Prince Rupert, Ridley Island Grain Elevator				✓																						
<b>Prince Rupert</b>																										
Ridley Terminals Inc	✓	✓	✓					✓			✓												✓			
<b>Quebec</b>																										
Bunge of Canada Elevator				✓																						
<b>Quebec</b>																										
QSL	✓		✓	✓	✓	✓	✓	✓	✓	✓	✓	✓	✓	✓	✓	✓	✓	✓	✓	✓	✓	✓	✓	✓	✓	✓
<b>Quebec</b>																										
Quebec Port Authority																										
<b>Quebec</b>																										
Sillery Distribution Center Inc.				✓																						
<b>Quebec</b>																										
St Lawrence Stevedoring	✓	✓	✓				✓	✓	✓	✓	✓	✓	✓	✓			✓									✓
<b>Regina</b>																										
Viterra Inc				✓																						
<b>Saint John</b>																										
Saint John Port Authority			✓								✓		✓									✓	✓	✓	✓	✓
<b>Saint-Joseph-de-Sorel</b>																										
Sorel-Tracy Maritime Terminal (STMT)																								✓		
<b>Salaberry-de-Valleyfield</b>																										
Valport Maritime Services Inc.	✓			✓			✓		✓		✓		✓				✓					✓	✓	✓	✓	✓
<b>Saskatoon</b>																										
Canpotex Limited											✓															
<b>Sept-Îles</b>																										
Iron Ore Company of Canada								✓																		
<b>Sept-Îles</b>																										
Porlier Express Inc	✓	✓	✓	✓				✓	✓	✓			✓	✓			✓					✓	✓	✓	✓	✓
<b>Sept-Îles</b>																										
Sept-Îles Port Authority		✓	✓					✓		✓			✓	✓			✓					✓	✓	✓	✓	✓
<b>Sept-Îles</b>																										
Wabush Mines																										
<b>Sorel-Tracy</b>																										
Richardson International (Quebec)				✓																						
<b>Squamish</b>																										
Squamish Terminals Ltd																						✓	✓	✓	✓	✓
<b>St Catharines</b>																										
The St Lawrence Seaway Management Corporation	✓	✓	✓	✓	✓	✓	✓	✓	✓	✓	✓	✓	✓	✓	✓	✓	✓	✓	✓			✓	✓	✓	✓	✓
<b>St Johns</b>																										
Port of Stephenville																										✓
<b>St Johns</b>																										
Ports & Harbours																										✓
<b>St. Catharines</b>																										
Port Weller Marine Terminal Inc.																								✓		✓
<b>Sydney</b>																										
Sydney Ports	✓																									
<b>Thunder Bay</b>																										
Mission Terminal				✓																						
<b>Thunder Bay</b>																										
Richardson International Ltd				✓																						
<b>Thunder Bay</b>																										
Thunder Bay Port Authority	✓		✓	✓							✓		✓				✓					✓	✓	✓	✓	✓
<b>Thunder Bay</b>																										
Thunder Bay Terminals Ltd	✓		✓	✓							✓															
<b>Thunder Bay</b>																										
Western Grain By-Products				✓																						
<b>Toronto</b>																										
Toronto Port Authority	✓	✓		✓	✓	✓	✓				✓	✓	✓	✓	✓	✓	✓	✓	✓				✓	✓	✓	✓
<b>Trois-Rivières</b>																										
Groupe Somavrac																										
<b>Trois-Rivières</b>																										
Port of Trois Rivières	✓		✓	✓		✓	✓			✓	✓	✓			✓								✓	✓	✓	✓



COMMODITIES	CL	CC	PC	G-A	AF	CM	CLK	IO	BX	AL	FR	G-FGD	AG	SU	SOY	SODA	MIN	CHEM	BIO	R/M	BC	FRS	STL	P&P	MB	OTH		
<b>Trois-Rivières</b>																												
Somavrac Inc.																							✓	✓	✓			
<b>Trois-Rivières</b>																												
Three Rivers Elevators				✓																								
<b>Valleyfield</b>																												
Valport Maritime Services Inc	✓			✓	✓				✓		✓	✓	✓					✓	✓			✓	✓	✓	✓			
<b>Vancouver</b>																												
Cascadia Terminal				✓																								
<b>Vancouver</b>																												
Port of Vancouver	✓			✓	✓						✓		✓	✓				✓					✓	✓	✓	✓	✓	
<b>Victoria</b>																												
Little Narrows Gypsum Company Ltd								✓																				
<b>Ville de La Baie</b>																												
Rio Tinto Alcan Port Alfred				✓						✓	✓																	
<b>WaWa</b>																												
Michipicoten Harbour									✓	✓													✓					
<b>West Vancouver</b>																												
Canpotex Terminals Limited												✓																
<b>Windsor</b>																												
ADM Agri-Industries Company/				✓													✓											
<b>Windsor</b>																												
Port of Windsor				✓		✓							✓	✓	✓								✓	✓		✓		
<b>Winnipeg</b>																												
Viterra				✓																								
<b>CANARY ISLANDS</b>																												
<b>Santa Cruz</b>																												
Junta del Puerto de Sto Cruz																												
<b>CAPE VERDE</b>																												
<b>Praia</b>																												
Capitania dos Portos de Sotaventos																												
<b>CHILE</b>																												
<b>Antofagasta</b>																												
Caleta Coloso																												
<b>Arica</b>																												
Puerto Arica	✓			✓				✓			✓					✓		✓	✓									
<b>Castilla</b>																												
Tocopilla	✓																											
<b>Concepcion</b>																												
Neuling Graneles SA	✓			✓				✓	✓		✓																	
<b>Iquique</b>																												
Empresa Portuaria Iquique																												
<b>La Serena</b>																												
Port Authority of Guayacan									✓																			
<b>Lirquen</b>																												
Port of Lirquen SA												✓																
<b>Mejillones</b>																												
Puerto Angamos	✓			✓				✓																				✓
<b>Mejillones</b>																												
Puerto de Mejillones S.A	✓			✓				✓																				✓
<b>Mejillones</b>																												
Terminal Graneles del Norte S.A. ,	✓																						✓	✓				
<b>Puerto Natales</b>																												
Port of Puerto Natales																												✓
<b>Quintero</b>																												
Port Authority of Quintero	✓			✓					✓																			
<b>San Antonio</b>																												
Puerto Panul S.A.																												
<b>Santiago</b>																												
ECL S.A.	✓	✓	✓			✓	✓	✓		✓								✓	✓								✓	
<b>Santiago</b>																												
Portuaria Puchoo SA	✓			✓																								
<b>Tocopilla</b>																												
Central Termoelectrica Tocopilla	✓																											
<b>Valparaíso</b>																												
Saam				✓																				✓				
<b>Valparaíso</b>																												
Valparaiso Port Authority	✓																											
<b>CHINA</b>																												
<b>Anqing</b>																												
Anqing Port Authority	✓								✓				✓															

# COMMODITIES HANDLED

COMMODITIES	CL	CC	PC	G-A	AF	CM	CLK	IO	BX	AL	FR	G-FGD	AG	SU	SOY	SODA	MIN	CHEM	BIO	R/M	BC	FRS	STL	P&P	MB	OTH	
<b>Beihai</b>																											
Beihai Harbour Administration				✓																							
<b>Chiwan</b>																											
Chiwan Harbour Container Office Building				✓		✓					✓			✓													
<b>Chongquin</b>																											
Chongquin Port Authority	✓								✓		✓																
<b>Dalian</b>																											
Dalian Bay Coal Terminal	✓																										
<b>Dalian</b>																											
Dalian Port Authority	✓			✓																							
<b>Dalian</b>																											
DCW Group Co																											
<b>Dalian</b>																											
Ganjingzi Coal Terminal	✓																										
<b>Dongfang County</b>																											
Basuo Port Corporation	✓		✓	✓		✓		✓					✓										✓			✓	
<b>Fangcheng</b>																											
Fangcheng Harbour Administration	✓																										✓
<b>Fujian Province</b>																											
Dongshan Port Authority						✓						✓															
<b>Fuzhou</b>																											
Fuzhou Port																											✓
<b>Guangzhou</b>																											
Xinggang No1				✓																							
<b>Haikou</b>																											
Haikou Port Authority								✓																			
<b>Hong Kong</b>																											
China Cement Co (HK) Ltd						✓																					
<b>Hong Kong</b>																											
CLP Power HK Limited	✓																										
<b>Hong Kong</b>																											
The Hongkong Electric Company Ltd	✓											✓															
<b>Hualien</b>																											
Hualien Harbour Bureau	✓																										
<b>Jiangsu</b>																											
Port of Lianyungang	✓											✓															
<b>Jinzhou</b>																											
Jinzhou Port Authority						✓		✓	✓																		✓
<b>Lianyungang</b>																											
Lianyungang Port Authority	✓			✓								✓															
<b>Longkou City</b>																											
Longkou Port Authority				✓		✓						✓												✓			✓
<b>Nanjing</b>																											
Nanjing Port Authority								✓															✓				
<b>Nantong</b>																											
Nantong Port Authority	✓			✓								✓															
<b>Ningbo</b>																											
Ningbo Port Authority	✓			✓				✓				✓												✓			✓
<b>Pinghu</b>																											
Zhapu Port Authority	✓			✓		✓																					
<b>Putian</b>																											
Port of Xiuyu	✓			✓																			✓			✓	✓
<b>Qingdao</b>																											
Port of Qingdao	✓			✓								✓												✓		✓	
<b>Qingdao</b>																											
Port of Qingdao Coal Terminal	✓																										
<b>Qingdao</b>																											
Xigang Company				✓				✓		✓	✓												✓	✓	✓		
<b>Qinhuangdao</b>																											
Qinhuangdao Port Authority	✓			✓		✓		✓			✓												✓	✓		✓	
<b>Rizhao City</b>																											
Rizhao Port Authority	✓			✓		✓		✓	✓		✓																
<b>Sanya</b>																											
Sanya Port	✓			✓							✓			✓												✓	
<b>Shanghai</b>																											
Ming Sheng Stevedores No 3/4 Terminals				✓																							
<b>Shanghai</b>																											
Shanghai Biny Electric Co., Ltd.																											
<b>Shanghai</b>																											
Shanghai International Port (Group) Co., Ltd	✓			✓				✓	✓		✓																
<b>Shanghai</b>																											
Shanghai Peiner Smag Machinery Co.,Ltd	✓			✓																							



COMMODITIES	CL	CC	PC	G-A	AF	CM	CLK	IO	BX	AL	FR	G-FGD	AG	SU	SOY	SODA	MIN	CHEM	BIO	R/M	BC	FRS	STL	P&P	MB	OTH	
<b>Shanghai</b>																											
Shanghai Port Luojing Bulk Terminals	✓																										
<b>Shantou</b>																											
Shantou Port																											✓
<b>Shenzhen</b>																											
Chiwan Port Authority				✓		✓					✓			✓													
<b>Shenzhen</b>																											
Shekou Port Service Co Ltd				✓																							
<b>Shenzhen</b>																											
Shenzhen Haixin Harbour Develop't Co Ltd											✓													✓			
<b>Shenzhen</b>																											
Shenzhen Yantian Port								✓			✓												✓				✓
<b>Shijiazhuang</b>																											
Hebei Port Group Co, Inc	✓																										
<b>Taizhou City</b>																											
Port of Haimen	✓																										
<b>Tanggu</b>																											
Tianjin Port Authority	✓			✓					✓		✓														✓		
<b>Tanggu</b>																											
Tianjin Xingang Sinor Terminal Co Ltd																							✓	✓			
<b>Tangshan</b>																											
Jintang Port	✓																										
<b>Wenzhou</b>																											
Wenzhou Port																											✓
<b>Wuhu</b>																											
Wuhu Port Authority	✓			✓					✓		✓																
<b>Xiamen</b>																											
Xiamen Harbour Authority	✓			✓							✓																✓
<b>Yantai</b>																											
Yantai Port Authority	✓												✓											✓			
<b>Yingkou</b>																											
Port of Yingkou	✓			✓				✓			✓															✓	
<b>Zhanjiang</b>																											
Zhanjiang Port Authority	✓					✓		✓	✓																		✓
<b>Zhanjiang</b>																											
Zhanjiang Port Authority	✓			✓		✓			✓		✓		✓											✓			
<b>Zhenjiang</b>																											
Zhenjiang Port Authority	✓			✓				✓			✓															✓	
<b>Zhoushan</b>																											
Zhoushan Port Administrative Bureau	✓					✓																					
<b>Zhoushan</b>																											
Zhoushan Port Haitong Transhipment & Storage Co Ltd	✓																										
<b>COLOMBIA</b>																											
<b>Barranquilla</b>																											
Carbones del Carrejon LLC	✓																										
<b>Barranquilla</b>																											
Cementos del Caribe						✓																					
<b>Barranquilla</b>																											
Compas SA	✓	✓				✓	✓	✓	✓		✓	✓	✓									✓		✓			
<b>Barranquilla</b>																											
Port of Puerto Bolivar	✓																										
<b>Barranquilla</b>																											
Sociedad Portuaria Del Norte	✓			✓																							
<b>Barranquilla</b>																											
Sociedad Portuaria Regional de Barranquilla SA	✓																										
<b>Barranquilla</b>																											
Tolu	✓																										
<b>Bogota</b>																											
Puertos de Colombia																											
<b>Bogota</b>																											
Santa Marta Coal Terminal	✓																										
<b>Buenaventura</b>																											
Sociedad Portuaria Regional de Buenaventura SA				✓							✓																
<b>Santa Marta</b>																											
CTS de Colombia	✓																										
<b>Santa Marta</b>																											
Port of Santa Marta	✓			✓											✓									✓			✓
<b>Santa Marta</b>																											
Puerto Prodeco	✓																										

# COMMODITIES HANDLED

COMMODITIES	CL	CC	PC	G-A	AF	CM	CLK	IO	BX	AL	FR	G-FGD	AG	SU	SOY	SODA	MIN	CHEM	BIO	R/M	BC	FRS	STL	P&P	MB	OTH	
<b>CROATIA</b>																											
<b>Ploce</b>																											
Luka Ploce (Part of Ploce)	✓	✓	✓	✓	✓	✓	✓	✓	✓	✓	✓	✓	✓	✓	✓	✓			✓	✓	✓	✓	✓	✓	✓	✓	✓
<b>Rijeka</b>																											
LUKA Rijeka d.d./Port of Rijeka j.s.c.								✓							✓							✓					
<b>Rijeka</b>																											
Terminal Bakar	✓							✓																			
<b>Zadar</b>																											
Zadar Port Authority				✓		✓									✓												
<b>CUBA</b>																											
<b>Antilla</b>																											
Antilla Port Authority				✓										✓													
<b>Antilla</b>																											
Nicaro	✓																										
<b>Antilla</b>																											
Port of Felton											✓																
<b>Cardenas</b>																											
Port of Cardenas											✓			✓													
<b>Cienfuegos</b>																											
Port of Cienfuegos				✓		✓								✓													
<b>Havana</b>																											
Port Authority of Havana	✓			✓							✓																
<b>Mariel</b>																											
Port of Mariel														✓													
<b>Matanzas</b>																											
Port Authority of Matanzas											✓																
<b>Puerto Tarafa Nuevitas</b>																											
Port of Nuevitas						✓								✓													
<b>Santiago de Cuba</b>																											
Port of Santiago de Cuba				✓		✓								✓													
<b>CURACAO</b>																											
<b>Wilemstad</b>																											
Curacao Ports Authority				✓		✓								✓							✓				✓	✓	
<b>CYPRUS</b>																											
<b>Limassol</b>																											
Global Ports Investments PLC	✓							✓																			
<b>Nicosia</b>																											
Cyprus Port Authority																											
<b>Nicosia</b>																											
Lemesos Port c/o Cyprus Port Authority				✓	✓										✓							✓	✓		✓		
<b>Nicosia</b>																											
Port of Vassiliko c/o Cyprus Ports Authority		✓	✓	✓	✓	✓	✓				✓				✓											✓	
<b>Nicosia</b>																											
Vassiliko Cement Works Ltd			✓			✓																					
<b>Nicosia</b>																											
Vassiliko Port				✓		✓																					
<b>DENMARK</b>																											
<b>Aabenraa</b>																											
Aabenraa Havn Port Authority				✓		✓																					
<b>Aabenraa</b>																											
Ensted Bulk Terminal A/S	✓							✓														✓					
<b>Aalborg</b>																											
Aalborg Bulk Terminal				✓	✓						✓				✓							✓		✓		✓	
<b>Aalborg</b>																											
Aalborg Portland						✓																					
<b>Aalborg</b>																											
Port of Aalborg				✓	✓		✓					✓	✓									✓	✓		✓		
<b>Aarhus</b>																											
Cargo Service A/S				✓	✓						✓		✓		✓								✓	✓			
<b>Aarhus</b>																											
Port of Aarhus	✓			✓		✓																					
<b>Bandholm</b>																											
Port of Bandholm				✓							✓																
<b>Charlottenlund</b>																											
Copenhagen Merchants				✓	✓						✓				✓								✓				
<b>Copenhagen</b>																											
Copenhagen Malmo Port AB	✓		✓	✓		✓						✓		✓					✓	✓		✓	✓	✓	✓	✓	✓
<b>Esbjerg</b>																											
Port of Esbjerg	✓																										
<b>Fredericia</b>																											
ADP - Port of Fredericia and Nyborg				✓	✓						✓												✓				



COMMODITIES	CL	CC	PC	G-A	AF	CM	CLK	IO	BX	AL	FR	G-FGD	AG	SU	SOY	SODA	MIN	CHEM	BIO	R/M	BC	FRS	STL	P&P	MB	OTH	
<b>Fredericia</b>																											
ADP A/S, Port of Fredericia				✓	✓	✓					✓		✓	✓	✓			✓	✓	✓	✓	✓	✓	✓	✓	✓	
<b>Fredericia</b>																											
DLA Agro				✓																							
<b>Fredericia</b>																											
Fredericia Bulk Terminal c/o				✓	✓						✓				✓								✓	✓	✓	✓	
Fredericia Shipping																											
<b>Grenaa</b>																											
Grenaa Bulk Terminal				✓																							
<b>Grenaa</b>																											
Port of Grenaa Ltd.				✓							✓												✓				
<b>Haderslev</b>																											
Port of Haderslev				✓							✓																
<b>Horsens</b>																											
Port Authority Horsens				✓																						✓	
<b>Kalundborg</b>																											
Asnaes Power Station									✓		✓																
<b>Kalundborg</b>																											
Kalundborg Bulk Terminal				✓																							
<b>Kalundborg</b>																											
Kalundborg Port Authority				✓	✓						✓	✓		✓	✓								✓	✓	✓	✓	
<b>Kolding</b>																											
Kolding Port Authority				✓	✓	✓					✓				✓					✓		✓	✓				
<b>Korsøer</b>																											
Port of Korsøer				✓		✓																					
<b>Næstved</b>																											
Næstved Port				✓							✓															✓	
<b>Nakskov</b>																											
Nakskov Port	✓			✓	✓						✓			✓								✓	✓	✓			
<b>Nykøbing Falster</b>																											
Guldborgsund Havne	✓			✓							✓			✓								✓	✓		✓	✓	
<b>Odense</b>																											
Port of Odense				✓		✓					✓													✓		✓	
<b>Randers</b>																											
Randers Port	✓			✓	✓	✓	✓		✓		✓		✓		✓		✓					✓	✓		✓	✓	
<b>Rodby</b>																											
Rodby Port Authority				✓							✓																
<b>Roenne</b>																											
BAF (Bornholms Andels Foderstofforretning)				✓																							
<b>Roenne</b>																											
Port of Roenne Ltd.	✓			✓	✓	✓					✓		✓		✓								✓		✓		
<b>Roenne</b>																											
Roenne Port Authority				✓																							
<b>Skaelskor</b>																											
Skaelskor Port Authority				✓																							
<b>Skaelskor</b>																											
Stigsnaesvaerkets Port Authority	✓																										
<b>Skodstrup</b>																											
Studstrup Port Authority	✓																										
<b>Vordingborg</b>																											
Vordingborg Port Authority				✓							✓		✓													✓	
<b>DOMINICAN REPUBLIC</b>																											
<b>Santa Domingo</b>																											
Port of Santo Domingo				✓							✓																
<b>Santo Domingo</b>																											
Agencias Navieras B&R, S.A.S	✓	✓	✓	✓	✓	✓	✓	✓	✓	✓	✓	✓	✓	✓	✓	✓	✓	✓	✓	✓	✓	✓	✓	✓	✓	✓	
<b>Santo Domingo</b>																											
Cabo Rojo Port Authority									✓																	✓	
<b>Santo Domingo</b>																											
Maritima Dominicana SA	✓		✓	✓		✓	✓				✓		✓	✓	✓	✓	✓					✓	✓	✓	✓	✓	
<b>ECUADOR</b>																											
<b>Guayaquil</b>																											
Port Authority of Guayaquil				✓																							
<b>EGYPT</b>																											
<b>Alexandria</b>																											
Alexandria Port Authority	✓			✓		✓					✓																
<b>Alexandria</b>																											
Kamania Grain Terminal				✓																							
<b>Cairo</b>																											
Abu Zenima Port Authority									✓																		
<b>Cairo</b>																											
El Sokhna Port Development Company									✓		✓																

# COMMODITIES HANDLED

COMMODITIES	CL	CC	PC	G-A	AF	CM	CLK	IO	BX	AL	FR	G-FGD	AG	SU	SOY	SODA	MIN	CHEM	BIO	R/M	BC	FRS	STL	P&P	MB	OTH	
<b>Cairo</b>																											
El Wadi Holdings				✓																							
<b>Cairo</b>																											
Medssofts				✓																							
<b>Cairo</b>																											
Sinai Manganese Co S A E																											
<b>Damietta</b>																											
Damietta Port Authority				✓																							
<b>Damietta</b>																											
Mina Damyat Terminal				✓																							
<b>Hamrawein</b>																											
Hamrawein Port Authority									✓		✓																
<b>Ismailia</b>																											
Port Authority of Safaga				✓							✓		✓														
<b>Ismailia</b>																											
Suez Canal Authority																											
<b>Port Said</b>																											
Port Said Port Authority				✓																							
<b>Port Tewfik</b>																											
Red Sea Port Authority																											
<b>Safaga</b>																											
Safaga Grain Berth No1				✓																							
<b>EL SALVADOR</b>																											
<b>Acajutla</b>																											
Port of Acajutla				✓							✓																
<b>ERITREA</b>																											
<b>Assab</b>																											
Assab Port Administration				✓							✓																
<b>ESTONIA</b>																											
<b>Tallinn</b>																											
AS Baltic Chemical Terminal											✓																
<b>Tallinn</b>																											
AS Coal Terminal	✓																										
<b>Tallinn</b>																											
AS DBT (Dry Bulk Terminal)											✓										✓						
<b>Tallinn</b>																											
AS MGT Muuga Grain Terminal				✓																							
<b>Tallinn</b>																											
KS Stevedoring				✓																							
<b>Tallinn</b>																											
Muuga (Novotallinskiy)	✓			✓							✓		✓												✓		
<b>Tallinn</b>																											
PETROMAKS SPEDIITORI AS	✓			✓																							
<b>Tallinn</b>																											
Port of Tallinn	✓			✓	✓		✓			✓	✓		✓	✓	✓						✓	✓	✓	✓	✓	✓	
<b>Viimsi Vald</b>																											
AS Stivis	✓										✓											✓	✓				
<b>FIJI</b>																											
<b>Suva</b>																											
Ports Authority of Fiji									✓																		
<b>FINLAND</b>																											
<b>Hamina</b>																											
Port of Hamina Ltd																						✓					
<b>Kokkola</b>																											
Oy M Rauanheimo Ab									✓		✓										✓	✓	✓				
<b>Kokkola</b>																											
Port of Kokkola Ltd.							✓														✓	✓	✓				
<b>Kotka</b>																											
Port Of Kotka Ltd				✓							✓											✓			✓		
<b>Kotka</b>																											
Steveco Oy				✓							✓				✓		✓					✓				✓	
<b>Loviisa</b>																											
Port of Loviisa				✓	✓																						
<b>Naantali</b>																											
Port of Naantali	✓			✓		✓																					
<b>Naantali</b>																											
Port of Olkiluoto																											
<b>Oulu</b>																											
Herman Andersson Oy																											
<b>Oulu</b>																											
Oulu Stevedoring OY																											



COMMODITIES	CL	CC	PC	G-A	AF	CM	CLK	IO	BX	AL	FR	G-FGD	AG	SU	SOY	SODA	MIN	CHEM	BIO	R/M	BC	FRS	STL	P&P	MB	OTH	
<b>Oulu</b>																											
Port of Oulu				✓		✓																		✓			
<b>Pori</b>																											
Port of Pori Ltd	✓	✓		✓									✓									✓	✓	✓		✓	
<b>Raahe</b>																											
Port of Raahe																										✓	
<b>Rauma</b>																											
Euroports Rauma											✓	✓										✓	✓	✓	✓	✓	
<b>Rauma</b>																											
Port of Rauma Ltd				✓	✓																		✓	✓	✓	✓	
<b>Turku</b>																											
Port of Turku Authority				✓																			✓	✓	✓	✓	
<b>Vaasa</b>																											
Port of Vaasa	✓			✓	✓																						
<b>Vantaa</b>																											
Suomen Viljava Oy				✓																							
<b>FRANCE</b>																											
<b>Bassens</b>																											
CIMALIT						✓																					
<b>Bassens</b>																											
Gemadocks											✓																
<b>Bassens</b>																											
Sea-invest Bordeaux																											
<b>Bassens</b>																											
Ste Aquitaine du Silo de Bordeaux-Bassens				✓																							
<b>Blainville Sur Orne</b>																											
SOCEMAR				✓				✓			✓																
<b>Blaye</b>																											
Blaye Grain Terminal				✓																							
<b>Bordeaux</b>																											
Bordeaux Port Authority (Grand Port Maritime de Bordeaux)	✓		✓	✓	✓	✓	✓	✓	✓		✓	✓	✓									✓	✓	✓	✓	✓	✓
<b>Bordeaux</b>																											
SAIPOL				✓																							
<b>Bordeaux</b>																											
SEMABLA				✓																							
<b>Bordeaux</b>																											
SPBL				✓																							
<b>Boucau</b>																											
Maisica				✓		✓					✓																✓
<b>Brest</b>																											
CCI - Port of Brest				✓	✓	✓					✓	✓	✓									✓		✓			✓
<b>Brest</b>																											
CCIMBO - Port of Brest				✓	✓	✓																	✓	✓			
<b>Calais</b>																											
Port of Calais																											
<b>Cherbourg-Octeville</b>																											
Port de Cherbourg	✓																										
<b>Dieppe Cedex</b>																											
Dieppe Port				✓									✓										✓	✓		✓	
<b>Dunkerque</b>																											
Port of Dunkerque	✓			✓				✓	✓		✓		✓	✓									✓	✓			
<b>Dunkerque</b>																											
Sea-Bulk Terminal																											
<b>Dunkerque</b>																											
SGD - Silo a Grain Dunkerque				✓																							
<b>Dunkerque</b>																											
Silonor				✓																							
<b>Fecamp</b>																											
Fecamp Port Authority																										✓	✓
<b>La Rochelle</b>																											
Atlantic Port La Rochelle	✓																										
<b>La Rochelle-Pallice</b>																											
Silo de la Rochelle Pallice				✓																							
<b>Le Havre</b>																											
Coal Terminal	✓																										
<b>Le Havre</b>																											
Le Havre Multi-Bulk Terminal	✓		✓	✓	✓											✓											
<b>Le Havre</b>																											
Port of Le Havre Authority	✓			✓	✓	✓		✓	✓		✓		✓	✓									✓	✓	✓		
<b>Le Portel</b>																											
Gie Boulogne Clinker						✓	✓																				

# COMMODITIES HANDLED

COMMODITIES	CL	CC	PC	G-A	AF	CM	CLK	IO	BX	AL	FR	G-FGD	AG	SU	SOY	SODA	MIN	CHEM	BIO	R/M	BC	FRS	STL	P&P	MB	OTH	
<b>Lorient</b>																											
Port de Commerce-Lorient				✓																							
<b>Marseille</b>																											
Marseilles Grain Terminal				✓																							
<b>Marseille</b>																											
Port Autonome de Marseille/Fos									✓																		
<b>Martigues</b>																											
Carfos	✓																										
<b>Montoir-de-Bretagne</b>																											
Sea-invest Montoir																											
<b>Montoir-de-Bretagne</b>																											
SONASTOCK & ATLANTIQUE STOCKAGE				✓																							
<b>Nantes</b>																											
Grand Port Maritime Nantes St Nazaire	✓	✓	✓	✓	✓	✓	✓				✓	✓	✓	✓	✓						✓	✓	✓		✓	✓	
<b>Nantes</b>																											
Montoir Agri-Bulk Terminal				✓							✓																
<b>Nantes</b>																											
Montoir Coal Terminal	✓																										
<b>Nantes</b>																											
Port Atlantique-Montoir Agri-Bulk Terminal	✓	✓	✓	✓	✓	✓	✓	✓	✓	✓	✓	✓	✓	✓	✓	✓	✓	✓	✓			✓	✓	✓	✓	✓	✓
<b>Nantes</b>																											
Roche-Maurice Terminal				✓																							
<b>Nantes</b>																											
SODISTOCK Group				✓																							
<b>Nantes</b>																											
SONASTOCK - Nantes Export Terminal				✓																							
<b>Paris</b>																											
Port of Paris Authority				✓		✓							✓														✓
<b>Port De Montoir</b>																											
Sea-invest France (Stocaloire)	✓			✓																							
<b>Port-la-Nouvelle</b>																											
Port of Port-la-Nouvelle	✓			✓	✓	✓					✓	✓	✓			✓			✓	✓	✓	✓	✓	✓	✓	✓	✓
<b>Rouen</b>																											
HAROPA PORTS	✓	✓	✓	✓	✓	✓	✓	✓	✓	✓	✓	✓	✓	✓	✓	✓	✓	✓	✓			✓	✓	✓	✓	✓	✓
<b>Rouen</b>																											
Lecureur				✓																							
<b>Rouen</b>																											
Maprochim											✓																
<b>Rouen</b>																											
Port of Rouen	✓			✓	✓				✓		✓		✓	✓									✓	✓	✓	✓	✓
<b>Rouen</b>																											
SENALIA				✓																							
<b>Rouen</b>																											
SENALIA				✓																							
<b>Rouen</b>																											
Silos Soufflet - SOCOMAC I / II Terminals				✓																							
<b>Rouen</b>																											
Simarex Villette				✓																							
<b>Rouen</b>																											
Sogema																											
<b>Saint Malo</b>																											
St Malo Port Authority	✓			✓	✓	✓	✓	✓	✓		✓	✓	✓	✓									✓	✓	✓	✓	✓
<b>Sète</b>																											
Port of Sète	✓	✓		✓	✓	✓	✓		✓	✓	✓		✓			✓							✓	✓	✓	✓	✓
<b>Sète</b>																											
Sea-invest Sète	✓		✓	✓	✓	✓	✓	✓	✓	✓	✓				✓	✓							✓		✓		
<b>St Malo</b>																											
SMG - Societe Malouine et Granvillaise				✓							✓																
<b>Strasbourg</b>																											
MTS SAS																											
<b>Tarnos</b>																											
Matrama Bayonne				✓		✓					✓												✓	✓			
<b>Toulon</b>																											
Port of Toulon						✓	✓		✓																		
<b>GABON</b>																											
<b>Libreville</b>																											
Libreville Port Authority													✓														
<b>Libreville</b>																											
Owendo Port Authority								✓	✓																		✓
<b>GEORGIA</b>																											
<b>Poti</b>																											
Poti Sea Port Corporation	✓	✓	✓	✓	✓	✓	✓	✓	✓	✓	✓	✓	✓	✓	✓	✓	✓	✓	✓			✓	✓	✓	✓	✓	✓



COMMODITIES	CL	CC	PC	G-A	AF	CM	CLK	IO	BX	AL	FR	G-FGD	AG	SU	SOY	SODA	MIN	CHEM	BIO	R/M	BC	FRS	STL	P&P	MB	OTH
<b>GERMANY</b>																										
<b>Brake</b>																										
J. Müller BreakbulkTerminal GmbH & Co. KG																							✓	✓	✓	
<b>Brake</b>																										
J. Müller Weser GmbH & Co. KG				4	4					4				4	4	4	4				4	4		4	4	4
<b>Brake</b>																										
Niedersachsen Ports GmbH & Co. KG				✓	✓						✓			✓	✓		✓		✓		✓	✓	✓	✓		
<b>Bremen</b>																										
Weserport GmbH	✓	✓	✓	✓	✓	✓	✓	✓	✓		✓	✓											✓	✓	✓	✓
<b>Bremerhaven</b>																										
bremenports GmbH & Co. KG	✓	✓		✓		✓		✓															✓	✓	✓	
<b>Brunsbüttel</b>																										
Brunsbüttel Ports GmbH	✓	✓	✓			✓	✓	✓	✓	✓	✓	✓						✓	✓			✓	✓	✓	✓	✓
<b>Duisburg</b>																										
Duisburger Hafen AG	✓	✓			✓	✓		✓		✓	✓			✓					✓			✓	✓	✓	✓	
<b>Duisburg</b>																										
Rhenus AG & Co. KG	✓																									
<b>Emden</b>																										
Emden Port Authority				✓																					✓	
<b>Emden</b>																										
EVAG Emden Verkehrs und Automotiv	✓	✓	✓	✓	✓	✓	✓		✓	✓	✓	✓						✓					✓	✓	✓	✓
<b>Flensburg</b>																										
Flensburg Port Authority	✓			✓							✓		✓												✓	
<b>Hamburg</b>																										
Buss Group GmbH & Co. KG													✓						✓							
<b>Hamburg</b>																										
BUSS Ross Terminal GmbH & Co KG																								✓		✓
<b>Hamburg</b>																										
Diamant Mühle Hamburg GmbH				✓																						
<b>Hamburg</b>																										
Eichholtz GmbH				✓																						
<b>Hamburg</b>																										
GTH - Getreide Terminal Hamburg (GmbH & Co.KG)				✓																						
<b>Hamburg</b>																										
H J M (H Jürgen Müller GmbH)	✓		✓	✓	✓		✓	✓	✓		✓	✓	✓		✓				✓			✓	✓	✓	✓	
<b>Hamburg</b>																										
HaBelMa Futtermittel GmbH & Co KG				✓																						
<b>Hamburg</b>																										
Hamburg Port Authority																										
<b>Hamburg</b>																										
Hamburg Sud																										
<b>Hamburg</b>																										
HANSAPORT	✓							✓																		
<b>Hamburg</b>																										
K+S Terminal (Kalikai)				✓							✓									✓						
<b>Hamburg</b>																										
Kali- Transport Gesellschaft GmbH											✓															
<b>Hamburg</b>																										
Louis Hagel (GmbH & Co. KG)				✓							✓															
<b>Hamburg</b>																										
Mittal Steel Hamburg GmbH								✓																✓		
<b>Hamburg</b>																										
NHG - Neuhof Hafengesellschaft mbH				✓																						
<b>Hamburg</b>																										
OAM Baustoffe GmbH												✓														
<b>Hamburg</b>																										
Port of Hamburg Marketing Association	✓	✓		✓	✓	✓		✓	✓	✓	✓	✓	✓	✓	✓	✓	✓	✓	✓	✓	✓	✓	✓	✓	✓	✓
<b>Hamburg</b>																										
Silo P. Kruse Betriebs-GmbH & Co. KG				✓																						
<b>Hamburg</b>																										
Wilhelm Mulch GmbH & Co KG																										✓
<b>Itzehoe</b>																										
Itzehoe Port Authority				✓							✓															
<b>Kiel</b>																										
Port of Kiel				✓							✓												✓	✓	✓	✓
<b>Krefeld</b>																										
Krefeld Port Authority				✓																						
<b>Leer</b>																										
Rhenus AG & Co. KG				✓	✓	✓		✓			✓				✓							✓	✓	✓	✓	
<b>Neuss</b>																										
Neuss Port Authority				✓																						

# COMMODITIES HANDLED

COMMODITIES	CL	CC	PC	G-A	AF	CM	CLK	IO	BX	AL	FR	G-FGD	AG	SU	SOY	SODA	MIN	CHEM	BIO	R/M	BC	FRS	STL	P&P	MB	OTH	
<b>Nordenham</b>																											
Rhenus Midgard GmbH & Co. KG	✓	✓	✓	✓	✓	✓	✓	✓	✓		✓	✓										✓	✓	✓	✓	✓	
<b>Nuremberg</b>																											
Hafen Nürnberg-Roth GmbH	✓			✓		✓	✓	✓			✓				✓									✓		✓	
<b>Oldenburg</b>																											
Seaports of Niedersachsen GmbH	✓	✓	✓	✓	✓	✓	✓	✓	✓	✓	✓	✓	✓	✓	✓	✓	✓	✓	✓	✓	✓	✓	✓	✓	✓	✓	
<b>Rostock</b>																											
Bulk Terminal Rostock GmbH	✓			✓				✓			✓																
<b>Rostock</b>																											
Getreide Service Rostock GmbH				✓	✓		✓				✓																
<b>Rostock</b>																											
Seehafen Rostock Umschlagsgesellschaft	✓			✓				✓			✓																
<b>Stralsund</b>																											
Port of Stralsund				✓							✓		✓													✓	
<b>Wilhelmshaven</b>																											
Rhenus Midgard Wilhelmshaven GmbH & Co.	✓	✓						✓																			
<b>GHANA</b>																											
<b>Takoradi</b>																											
Ghana Ports & Harbours Authority																											
<b>Takoradi</b>																											
Takoradi Port Authority	✓			✓					✓		✓		✓														
<b>Tema</b>																											
Tema Port									✓																		
<b>GREECE</b>																											
<b>Alexandroupolis</b>																											
Alexandroupolis Port Authority				✓																							
<b>Aliveri</b>																											
Mylaki Port Authority	✓					✓																					
<b>Attica</b>																											
Milaki Port-East Mediterranean Coal Terminal	✓																										
<b>Chalkis</b>																											
Chalkis Port Authority	✓					✓					✓																
<b>Chania Crete</b>																											
Suda Bay Port				✓																							
<b>Corfu</b>																											
Corfu Port Authority				✓																							
<b>Itea</b>																											
Itea Port Authority									✓																		
<b>Kalamata</b>																											
Kalamata Port Authority				✓																		✓					
<b>Milos Island</b>																											
Milos Island Port Authority								✓	✓																		
<b>Nissyros</b>																											
Yali Island Port Authority													✓														
<b>Piraeus</b>																											
Piraeus Port Authority				✓							✓																
<b>Pylos</b>																											
Pylos Port Authority																									✓		
<b>Thessaloniki</b>																											
Thessaloniki Port Authority SA	✓			✓	✓	✓	✓	✓	✓		✓	✓			✓							✓	✓	✓	✓		
<b>GUADELOUPE</b>																											
<b>Point A Pitre</b>																											
Pointe-a-Pitre Port	✓			✓			✓				✓	✓	✓	✓													
<b>GUAM</b>																											
<b>Piti</b>																											
Apra Harbour													✓										✓		✓		
<b>Georgetown</b>																											
Georgetown Port Authority				✓										✓													
<b>Kingston</b>																											
Linden Port Authority									✓																		
<b>Kingston</b>																											
New Amsterdam Port Authority									✓																		
<b>HAITI</b>																											
<b>Port Au Prince</b>																											
Port Au Prince Port Authority				✓		✓		✓						✓													
<b>HONDURAS</b>																											
<b>Puerto Cortes</b>																											
Terminales de Cortes, S.A de C.V				✓	✓	✓	✓				✓			✓								✓	✓	✓			



COMMODITIES	CL	CC	PC	G-A	AF	CM	CLK	IO	BX	AL	FR	G-FGD	AG	SU	SOY	SODA	MIN	CHEM	BIO	R/M	BC	FRS	STL	P&P	MB	OTH	
<b>Puerto Cortés</b>																											
National Port Company																											
<b>Puerto Cortés</b>																											
Puerto Cortes Port Authority				✓				✓	✓		✓			✓													
<b>ICELAND</b>																											
<b>Grundartangi</b>																											
Grundartangi Port	✓																										
<b>Hafnarfjordur</b>																											
Port of Hafnarfjordur									✓	✓			✓													✓	
<b>Raohusinu</b>																											
Vestmannaeyjar Port Authority																										✓	
<b>Reykjavik</b>																											
Associated Icelandic Ports				✓		✓					✓																
<b>INDIA</b>																											
<b>Adyar</b>																											
Subarnarekha Port Private Ltd	✓	✓	✓	✓		✓	✓	✓																			
<b>Bhavnagar Gujarat</b>																											
Bhavnagar Port Authority																										✓	
<b>Bhubaneswar</b>																											
DPCL - Dhamra Port Company Limited	✓	✓						✓																			
<b>Calcutta</b>																											
Calcutta Port Trust	✓			✓		✓		✓	✓					✓												✓	
<b>Calicut</b>																											
Calicut Port Authority				✓				✓	✓																		
<b>Chennai</b>																											
Ennore Port Limited	✓							✓																			
<b>Chennai</b>																											
Karaikal Port Private Limited	✓	✓	✓	✓		✓		✓			✓	✓	✓	✓							✓	✓	✓	✓	✓	✓	
<b>Chennai</b>																											
Port of Chennai	✓																										
<b>Chennai</b>																											
Sical Logistics Limited																											
<b>Churchgate</b>																											
Yogaytan Ports Pvt. Ltd.																											
<b>Cochin</b>																											
Cochin Port Trust	✓			✓		✓	✓	✓			✓	✓	✓			✓	✓					✓	✓	✓	✓	✓	
<b>Devanampattinam</b>																											
Cuddalore Port Authority	✓							✓																			
<b>Dist. Nellore</b>																											
Krishnapatnam Port Company Limited	✓	✓	✓	✓	✓	✓	✓	✓			✓	✓		✓		✓	✓	✓			✓	✓	✓	✓	✓	✓	
<b>Gandhinagar</b>																											
Gujarat Maritime Board	✓			✓		✓					✓																
<b>Goa</b>																											
Mormugao Port Trust	✓	✓	✓					✓	✓	✓	✓											✓		✓		✓	
<b>Gujarat</b>																											
Dahej Port Authority													✓														
<b>Gujarat</b>																											
Kandla Port Trust				✓							✓																
<b>Haldia</b>																											
TM International Logistics Ltd.	✓	✓	✓																				✓				
<b>Hyderabad</b>																											
Gangavaram Port Limited	✓																										
<b>Karnataka State</b>																											
Karwar Port Authority								✓	✓		✓		✓													✓	
<b>Karnataka State</b>																											
New Mangalore Port Trust	✓			✓				✓	✓		✓																
<b>Kolkata</b>																											
Riverine Group	✓	✓		✓				✓														✓					
<b>Kolkata</b>																											
T M International Logistics Limited		✓						✓			✓													✓			
<b>Minapore</b>																											
Haldia Port Authority	✓							✓	✓		✓															✓	
<b>Mumbai</b>																											
Bombay Port Trust	✓			✓							✓																
<b>Mumbai</b>																											
Essar Ports Ltd.	✓	✓	✓	✓	✓	✓	✓	✓		✓	✓	✓	✓	✓	✓	✓	✓	✓	✓							✓	
<b>Mumbai</b>																											
J.M. Baxi & Co	✓			✓	✓			✓			✓			✓									✓	✓			
<b>Mumbai</b>																											
Seacrest Marine Services Pvt. Ltd.	✓			✓				✓																			
<b>Mumbai</b>																											
Skil Infrastructure Ltd	✓																										

# COMMODITIES HANDLED

COMMODITIES	CL	CC	PC	G-A	AF	CM	CLK	IO	BX	AL	FR	G-FGD	AG	SU	SOY	SODA	MIN	CHEM	BIO	R/M	BC	FRS	STL	P&P	MB	OTH	
<b>Mundra</b>																											
Adani Ports & Special Economic Zone Ltd																											
<b>Nagapattinam</b>																											
Nagapattinam Port Authority				✓							✓																
<b>Nungambakkam</b>																											
International Seaports (India) Pvt Ltd	✓																										
<b>Orissa</b>																											
Paradip Port Trust	✓	✓	✓	✓			✓	✓	✓		✓	✓									✓		✓		✓		
<b>Porbander</b>																											
Porbandar Port Authority	✓		✓	✓		✓			✓		✓																
<b>Port Okha</b>																											
Port Okha Port Authority	✓		✓	✓		✓	✓		✓		✓															✓	
<b>Tuticorin</b>																											
Tuticorin Port Trust	✓			✓		✓		✓																			
<b>Visakhapatnam</b>																											
Port of Visakhapatnam	✓							✓																		✓	
<b>INDONESIA</b>																											
<b>Bandar Lampung</b>																											
PT. Bukit Asam (Persero) Tbk	✓																										
<b>Banjarmasin</b>																											
Port of Banjarmasin	✓																										
<b>Bitung</b>																											
Port of Bitung																											
<b>Cilacap</b>																											
Cilacap						✓		✓			✓																✓
<b>Cilegon</b>																											
PT Krakatau Bandar Samudera	✓																										
<b>Irian Jaya</b>																											
Amamapare								✓	✓																		
<b>Jakarta</b>																											
Balikpapan Coal Terminal	✓																										
<b>Jakarta</b>																											
Gebe Island								✓	✓																		
<b>Jakarta</b>																											
North Pulau Laut Coal Terminal	✓																										
<b>Jakarta</b>																											
P T Indominco Mandiri	✓																										
<b>Jakarta</b>																											
PT Indonesia Bulk Terminal	✓	✓																									
<b>Jakarta</b>																											
PT Miang Besar Coal Terminal	✓	✓	✓																								
<b>Jakarta</b>																											
Pt. Pulau Laut																											
<b>Jakarta</b>																											
PT. Terminal Batubara Indah	✓																										
<b>Jakarta</b>																											
Pulau Laut	✓																										
<b>Jakarta</b>																											
Tanjung Priok				✓		✓																					✓
<b>Kijang</b>																											
Port of Kijang									✓																		
<b>Kotabaru</b>																											
PT Indonesia Bulk Terminal	✓	✓																									
<b>Lampung</b>																											
Pelabuhan Panjang	✓			✓																							
<b>Lhokseumawe</b>																											
Port of Lhokseumawe												✓															
<b>Padang</b>																											
Port of Teluk Bayur	✓					✓																					
<b>Padang</b>																											
Teluk Bayur Coal Terminal	✓																										
<b>Palembang</b>																											
Kertapati Coal Terminal	✓																										
<b>Palembang</b>																											
Port Authority Palembang												✓															
<b>Sabang</b>																											
Port of Sabang	✓																										
<b>Surabaya</b>																											
Surabaya Port Authority	✓			✓							✓																
<b>Tanjung Priok</b>																											
Bogasari Flour Mills Terminal				✓																							



COMMODITIES	CL	CC	PC	G-A	AF	CM	CLK	IO	BX	AL	FR	G-FGD	AG	SU	SOY	SODA	MIN	CHEM	BIO	R/M	BC	FRS	STL	P&P	MB	OTH		
<b>IRAN</b>																												
<b>Tehran</b>																												
Bandar Abbas Port Authority				✓				✓			✓																	
<b>Tehran</b>																												
Chah Bandar Port Authority								✓																				
<b>Tehran</b>																												
Khorramshar Port Authority						✓																						
<b>IRELAND</b>																												
<b>Arklow</b>																												
Arklow Port Authority													✓															
<b>Cork</b>																												
Port of Cork Company	✓			✓	✓	✓					✓	✓	✓		✓	✓						✓	✓	✓	✓	✓		
<b>Cork</b>																												
Ringaskiddy Deepwater Terminal				✓																								
<b>Dublin</b>																												
Dublin Port & Docks Board	✓			✓				✓	✓		✓	✓														✓		
<b>Dundalk</b>																												
Dundalk Harbour Commissioners	✓			✓																								
<b>Foynes</b>																												
Shannon Foynes Port Company	✓	✓	✓	✓	✓	✓		✓	✓	✓	✓	✓	✓				✓	✓		✓		✓	✓			✓		
<b>Galway</b>																												
Galway Harbour Company	✓			✓							✓																	
<b>Kilrush</b>																												
Kilrush Port Authority				✓																								
<b>Kinsale</b>																												
Cork County Council				✓	✓						✓																	
<b>Kinsale</b>																												
Henry Good Limited				✓																								
<b>Louth</b>																												
Greenore Port	✓		✓	✓	✓		✓	✓			✓	✓	✓		✓	✓			✓		✓	✓	✓					
<b>New Ross</b>																												
New Ross Port Company	✓		✓	✓	✓	✓	✓	✓			✓											✓	✓	✓		✓		
<b>Tralee</b>																												
Fenit Port Authority	✓																											
<b>Turvey</b>																												
Moneypoint	✓																											
<b>Waterford</b>																												
Port of Waterford Company	✓			✓	✓	✓	✓				✓	✓	✓		✓				✓	✓	✓	✓	✓	✓		✓		
<b>Wicklow</b>																												
Wicklow Port Co																							✓	✓	✓	✓	✓	
<b>ISRAEL</b>																												
<b>Ashdod</b>																												
Ashdod Port Co. Ltd	✓			✓							✓																	
<b>Ashkelon</b>																												
The National Coal Supply Corp'n (N.C.S.C)	✓																											
<b>Eilat</b>																												
Eilat Port Ltd - Israel											✓																	
<b>Hadera</b>																												
Port of Hadera	✓																											
<b>Hadera</b>																												
The National Coal Supply Corp Ltd (NCSC)	✓																											
<b>Haifa</b>																												
Haifa Grain Terminal				✓																								
<b>Haifa</b>																												
Haifa Port Company Ltd	✓			✓																								
<b>Tel Aviv</b>																												
Israel Ports Company																											✓	
<b>ITALY</b>																												
<b>Ancona</b>																												
Ancona Coal Terminal	✓																											
<b>Ancona</b>																												
Ancona Port Authority				✓		✓		✓			✓																✓	
<b>Barlette</b>																												
Barletta Port Authority	✓			✓																							✓	
<b>Cagliari</b>																												
Port of Cagliari	✓			✓																							✓	
<b>Chioggia</b>																												
Chioggia Port Authority																											✓	
<b>Civitavecchia</b>																												
Civitavecchia Port Authority	✓		✓	✓							✓															✓	✓	

# COMMODITIES HANDLED

COMMODITIES	CL	CC	PC	G-A	AF	CM	CLK	IO	BX	AL	FR	G-FGD	AG	SU	SOY	SODA	MIN	CHEM	BIO	R/M	BC	FRS	STL	P&P	MB	OTH	
<b>Crotone</b>																											
Crotone Port Authority				✓																						✓	
<b>Gaeta &amp; Civitavecchia</b>																											
Intergroup S.r.l.	✓		✓	✓		✓	✓	✓	✓	✓	✓	✓	✓	✓		✓	✓	✓			✓	✓	✓	✓	✓	✓	
<b>Gela</b>																											
Gela Port Authority											✓																
<b>Genova</b>																											
Port of Genova				✓																							
<b>Genova</b>																											
Terminal Rinfuse Genova SpA	✓			✓				✓	✓		✓		✓										✓		✓		
<b>La Spezia</b>																											
La Spezia Port Authority	✓			✓							✓																
<b>Livorno</b>																											
Livorno Port Authority	✓			✓		✓		✓	✓	✓	✓				✓		✓	✓				✓		✓			
<b>Manfredonia</b>																											
Manfredonia Port Authority				✓							✓		✓													✓	
<b>Palermo</b>																											
Palermo Port Authority	✓			✓				✓																		✓	
<b>Piazzale Cabato</b>																											
Gaeta Port Authority				✓		✓					✓		✓												✓	✓	
<b>Piombino (LI)</b>																											
Autorità Portuale di Piombino	✓							✓	✓														✓		✓	✓	
<b>Porto Torres</b>																											
Porto Torres Port Authority											✓															✓	
<b>Ravenna</b>																											
Ravenna Port Authority	✓	✓	✓	✓	✓	✓	✓	✓	✓	✓	✓			✓	✓	✓	✓	✓				✓	✓				
<b>Sant'Antioco</b>																											
Sant'Antioco Port Authority	✓																										
<b>Savona</b>																											
Autorità Portuale di Savona				✓																							
<b>Savona</b>																											
Port Authority of Savona	✓		✓	✓	✓	✓	✓	✓	✓	✓	✓				✓	✓		✓			✓	✓	✓	✓	✓	✓	
<b>Savona</b>																											
Terminal Alti Fondali Savona S.r.l.	✓	✓	✓																								
<b>Sicily</b>																											
Siracusa Port Authority				✓																							
<b>Torre Annunziata (NA)</b>																											
SOLACEM Spa				✓	✓	✓				✓	✓			✓	✓						✓	✓	✓	✓	✓	✓	
<b>Trieste</b>																											
Port of Trieste				✓				✓	✓													✓					
<b>Trieste</b>																											
Trieste Port, Pier 7																											
<b>Vado Ligure (SV)</b>																											
Terminal Rinfuse Vado	✓																										
<b>Venezia</b>																											
T.M.B SRL Venezia				✓																							
<b>Venice</b>																											
Port Authority of Venice																							✓				
<b>Venice</b>																											
Port of Venice Marghera	✓			✓																							
<b>IVORY COAST</b>																											
<b>Abidjan</b>																											
Port Autonome d'Abidjan									✓		✓																
<b>Kingston</b>																											
Kingston Port Authority				✓		✓						✓															
<b>Kingston</b>																											
Port Authority of Jamaica																											
<b>Kingston</b>																											
Port Kaiser									✓																		
<b>Kingston</b>																											
Port of Port Rhoades									✓																		
<b>Saint Ann's Bay</b>																											
Ocho Rios Port									✓					✓													
<b>St Catherine</b>																											
Port Esquivel				✓	✓	✓				✓	✓		✓		✓	✓		✓			✓		✓			✓	
<b>JAMAICA</b>																											
<b>St Catherine</b>																											
West Indies Alumina Company				✓	✓	✓				✓	✓		✓		✓	✓		✓					✓			✓	
<b>JAPAN</b>																											
<b>Akigun</b>																											
Port of Mitsukojima																										✓	



COMMODITIES	CL	CC	PC	G-A	AF	CM	CLK	IO	BX	AL	FR	G-FGD	AG	SU	SOY	SODA	MIN	CHEM	BIO	R/M	BC	FRS	STL	P&P	MB	OTH	
<b>Akita City</b>																											
Port of Akita				✓		✓		✓	✓		✓	✓	✓										✓		✓		✓
<b>Anan City</b>																											
Port of Anan												✓															✓
<b>Aomori</b>																											
Port of Aomori																										✓	✓
<b>Aomori</b>																											
Port of Hachinohe	✓			✓		✓		✓															✓				
<b>Chiba City</b>																											
Chiba Port				✓		✓		✓						✓						✓			✓				
<b>Chiba City</b>																											
Kisarazu Port	✓		✓					✓	✓				✓											✓		✓	✓
<b>Chiyoda-ku</b>																											
Idemitsu Bulk Terminal-Chiba	✓																										
<b>Fukuoko City</b>																											
Hakata Port & Harbour Bureau				✓	✓	✓							✓	✓									✓	✓	✓		
<b>Hakodate</b>																											
Hakodate Port and Airport Department	✓			✓	✓	✓	✓				✓	✓	✓	✓					✓			✓	✓	✓		✓	✓
<b>Handa City</b>																											
Port of Kinuura				✓										✓												✓	✓
<b>Hiroshima</b>																											
Fukuyama Port Authority	✓							✓																		✓	✓
<b>Hiroshima</b>																											
Hiroshima Port Authority	✓			✓																							
<b>Hiroshima</b>																											
Kure Port Authority	✓							✓	✓																		
<b>Hiroshima</b>																											
Port of Takehara No 1P/S	✓																										
<b>Ibaraki</b>																											
Hitachi Port Authority	✓																										✓
<b>Iyomishima City</b>																											
Port of Mishima-Kawanoe	✓			✓																							
<b>Kagoshima City</b>																											
Pacific Grain Terminal				✓																							
<b>Kagoshima City</b>																											
Port of Kagoshima				✓																							✓
<b>Kakogawa City</b>																											
Higashi-Harima Port Authority	✓							✓	✓															✓		✓	
<b>Kamisu-City</b>																											
Kanto Grain Terminal Co. Ltd				✓																							
<b>Kanda-Machi</b>																											
Kanda Port						✓																					✓
<b>Kasaoka City</b>																											
Kasaoka Port																								✓		✓	✓
<b>Kawasaki City</b>																											
Port of Kawasaki	✓			✓				✓	✓															✓			✓
<b>Kitakyushu City</b>																											
Kitakyushu Port & Harbour Authority	✓							✓																✓			
<b>Kitakyushu City</b>																											
Port of Hibikinade												✓															
<b>Kitakyushu City</b>																											
Port of Kokura	✓							✓																			
<b>Kitakyushu City</b>																											
Port of Yawata																								✓			✓
<b>Kitakyushu City</b>																											
Yawata Hibikinada	✓					✓																					
<b>Kobe</b>																											
Port Authority of Himeji																											✓
<b>Kobe</b>																											
Port of Kobe	✓	✓	✓	✓	✓	✓	✓	✓	✓	✓	✓	✓	✓	✓	✓	✓	✓	✓	✓	✓	✓	✓	✓	✓	✓	✓	✓
<b>Kochi City</b>																											
Port of Kochi	✓																										✓
<b>Komatsushima City</b>																											
Port of Tokushima Komatsushima						✓																					
<b>Kurashiki City</b>																											
Mizushima Port Authority	✓			✓				✓																		✓	✓
<b>Kushiro City</b>																											
Kushiro Port Authority	✓			✓		✓																	✓				
<b>Maizuru City</b>																											
Maizuru Port Authority																											✓
<b>Marugame City</b>																											
Port of Marugame				✓																							

# COMMODITIES HANDLED

COMMODITIES	CL	CC	PC	G-A	AF	CM	CLK	IO	BX	AL	FR	G-FGD	AG	SU	SOY	SODA	MIN	CHEM	BIO	R/M	BC	FRS	STL	P&P	MB	OTH
<b>Minatoku</b>																										
Niihama Coal Centre	✓																									
<b>Moji-ku Kitakyushu City</b>																										
Moji Port Authority	✓			✓		✓		✓			✓														✓	
<b>Moji-ku Kitakyushu City</b>																										
Port of Tobata	✓							✓	✓																	
<b>Morioka</b>																										
Port of Kamaishi	✓		✓					✓																		
<b>Morioka</b>																										
Port of Ofunato	✓		✓			✓		✓				✓														✓
<b>Mubanti</b>																										
Shukuzu Coal Centre	✓																									
<b>Muroran City</b>																										
Muroran Port Authority	✓							✓	✓														✓			
<b>Nagasaki City</b>																										
Port of Matsushima																										✓
<b>Nagoya</b>																										
Gamagori Port Authority																										✓
<b>Niigata City</b>																										
Port of Niigata	✓																									
<b>Niihama City</b>																										
Port of Niihama	✓								✓																	✓
<b>Oita City</b>																										
Port of Oita	✓							✓																		
<b>Osaka City</b>																										
Port of Osaka	✓		✓	✓		✓		✓																	✓	✓
<b>Otaru City</b>																										
Port of Otaru				✓		✓		✓	✓																	
<b>Sakaide City</b>																										
Sakaide Port Administration	✓		✓	✓					✓																	
<b>Sasebo City</b>																										
Port of Sasebo				✓																						
<b>Schimonoseki City</b>																										
Shimonoseki Port & Harbour Bureau				✓								✓										✓	✓			
<b>Sendai</b>																										
Port of Ishinomaki	✓			✓								✓														
<b>Shibushi-shi</b>																										
Port of Shibushi				✓		✓																				
<b>Shizuoka City</b>																										
Port Authority of Shimize	✓		✓	✓	✓	✓		✓	✓	✓	✓		✓	✓	✓			✓				✓	✓	✓	✓	✓
<b>Shizuoka City</b>																										
Port of Tagonoura				✓																			✓			
<b>Takamtsu City</b>																										
Naoshima Port Authority								✓																		
<b>Tokuyama City</b>																										
Tokuyama Port Authority						✓		✓	✓		✓															
<b>Tokuyama City</b>																										
Tonda Port Authority																										✓
<b>Tokyo</b>																										
Tokyo Metropolitan Government	✓			✓		✓																	✓	✓	✓	✓
<b>Tomakomai City</b>																										
Tomakomai Port Authority	✓			✓		✓			✓		✓															✓
<b>Toyama City</b>																										
Toyama Port Authority						✓																				
<b>Toyama City</b>																										
Toyama-Shinko Public Berths	✓																									
<b>Tsuruga City</b>																										
Tsuruga Port Authority	✓					✓					✓		✓													
<b>Ube City</b>																										
Port of Ube, Okinoyama Coal Terminal	✓																									
<b>Usui City</b>																										
Tsukumi Port Authority	✓					✓																				✓
<b>Wakayama City</b>																										
Smikin Transport Service	✓																									
<b>Wakayama City</b>																										
Wakayama Port Authority	✓							✓																		
<b>Yatsushiro City</b>																										
Yatsushiro Port Office																										✓
<b>Yokohama</b>																										
Port of Yokohama	✓			✓		✓		✓	✓					✓												✓
<b>JERSEY</b>																										
<b>St Helier</b>																										
Induvac						✓																				



COMMODITIES	CL	CC	PC	G-A	AF	CM	CLK	IO	BX	AL	FR	G-FGD	AG	SU	SOY	SODA	MIN	CHEM	BIO	R/M	BC	FRS	STL	P&P	MB	OTH	
<b>JORDAN</b>																											
<b>Aqaba</b>																											
The Ports Corporation Aqaba				✓		✓					✓																
<b>KENYA</b>																											
<b>Mombasa</b>																											
Grain Bulk Handlers Ltd				✓																							
<b>Mombasa</b>																											
Kenya Ports Authority	✓			✓	✓	✓	✓	✓	✓		✓	✓	✓	✓									✓	✓	✓	✓	
<b>Mombasa</b>																											
Port of Mombasa	✓			✓		✓					✓			✓													
<b>KIRIBATI</b>																											
<b>Betio</b>																											
Kiribati Ports Authority											✓																
<b>KUWAIT</b>																											
<b>Safat</b>																											
Shuaiba Port			✓			✓		✓			✓																✓
<b>Safat</b>																											
Shuwaikh Port				✓		✓																					
<b>LATVIA</b>																											
<b>Liepaja</b>																											
Liepaja Port Authority													✓														
<b>Liepaja</b>																											
Liepaja Special Economic Zone Authority SEZ				✓																							
<b>Riga</b>																											
Freeport of Riga Authority	✓			✓							✓			✓								✓			✓		
<b>Riga</b>																											
Riga 1. Saldetava JSC	✓	✓	✓	✓	✓			✓			✓			✓	✓						✓		✓	✓	✓	✓	✓
<b>Riga</b>																											
WT Terminal Ltd											✓		✓			✓						✓	✓	✓	✓	✓	✓
<b>Ventspils</b>																											
AS Ventspils Tirdzniecibas Osta	✓																										
<b>Ventspils</b>																											
Free Port of Ventspils Authority	✓			✓				✓			✓			✓								✓	✓		✓	✓	✓
<b>Ventspils</b>																											
JSC BALTIC COAL TERMINAL	✓																										
<b>Ventspils</b>																											
Kalija Parks											✓																
<b>Ventspils</b>																											
Ventspils Grain Terminal				✓																							
<b>LEBANON</b>																											
<b>Beirut</b>																											
Chekaa Bay						✓																					
<b>Beirut</b>																											
Port Authority of Selaata				✓																							
<b>Tripoli</b>																											
Service d'Exploitation du Port de Tripoli				✓																							
<b>LIBERIA</b>																											
<b>Monrovia</b>																											
Monrovia Port								✓																			
<b>Monrovia</b>																											
National Port Authority																											
<b>Robertfield</b>																											
Buchanan Port Authority								✓																			
<b>LITHUANIA</b>																											
<b>Klaipeda</b>																											
BEGA, Stevedoring Company				✓	✓	✓	✓			✓	✓		✓	✓	✓	✓	✓				✓	✓		✓	✓	✓	✓
<b>Klaipeda</b>																											
Joint-Stock Stevedoring Company				✓																							✓
<b>Klaipeda</b>																											
Klaipeda Stevedoring Company (KLASCO)				✓	✓		✓	✓	✓		✓	✓	✓	✓	✓							✓	✓	✓	✓	✓	✓
<b>Klaipeda</b>																											
State Enterprise Klaipeda State Seaport Authority				✓	✓	✓	✓	✓			✓			✓	✓	✓	✓	✓				✓	✓	✓	✓	✓	✓
<b>Klaipeda</b>																											
Vakaru krova, UAB																							✓				
<b>MADAGASCAR</b>																											
<b>Toamasina</b>																											
Societe d'Exploitation du Port de Toamasina																											

# COMMODITIES HANDLED

COMMODITIES	CL	CC	PC	G-A	AF	CM	CLK	IO	BX	AL	FR	G-FGD	AG	SU	SOY	SODA	MIN	CHEM	BIO	R/M	BC	FRS	STL	P&P	MB	OTH	
<b>MALAYSIA</b>																											
<b>Bintulu</b>																											
Samalaju Industrial Port Sdn. Bhd.											✓																✓
<b>Butterworth</b>																											
Penang Port SDN BHD				✓							✓																
<b>Johor Baharu</b>																											
Bulk & Breakbulk Terminal				✓																							
<b>Johor Baharu</b>																											
Johor Port BERHAD				✓	✓	✓	✓	✓			✓	✓		✓									✓		✓		
<b>Klang</b>																											
Westports Malaysia Sdn Bhd	✓			✓							✓																
<b>Kota Kinabalu</b>																											
Sabah Ports Authority				✓							✓																✓
<b>Kuantan</b>																											
Kuantan Port Authority																											
<b>Kuantan</b>																											
Kuantan Port Consortium Sdn Bhd	✓			✓	✓		✓	✓			✓	✓													✓	✓	
<b>Kuantan</b>																											
Lembaga Pelabuhan Kuantan		✓		✓				✓			✓	✓										✓	✓				
<b>Labuan</b>																											
Labuan Port Authority				✓				✓																			
<b>Malacca</b>																											
Malacca Port Authority				✓																							✓
<b>Miri</b>																											
Miri Port Authority				✓	✓	✓	✓			✓	✓	✓		✓	✓	✓	✓	✓	✓			✓	✓	✓	✓	✓	✓
<b>Penang</b>																											
Penang Port SDN BHD																											
<b>Penang</b>																											
Prai Bulk Cargo Terminal				✓																							
<b>Port Kelang</b>																											
West Fertilizer Terminal Sdn Bhd											✓																
<b>Port Klang</b>																											
Northport (Malaysia) Bhd	✓			✓	✓	✓	✓	✓			✓		✓	✓	✓	✓	✓	✓			✓	✓	✓	✓	✓	✓	✓
<b>Port Klang</b>																											
Port Klang Authority	✓	✓	✓	✓	✓	✓	✓	✓	✓	✓	✓	✓		✓	✓	✓									✓		
<b>Sandakan</b>																											
Sandakan Port Authority																											✓
<b>Seri Manjung</b>																											
Lumut Maritime Terminal Sdn Bhd	✓																										
<b>Sibu</b>																											
Rajang Port Authority	✓																										
<b>Terengganu Darul Iman</b>																											
Kemaman Port Authority																											✓
<b>Utara</b>																											
Kelang Port Management	✓			✓																							
<b>MALTA</b>																											
<b>Marsa</b>																											
Port of Valletta				✓	✓	✓		✓			✓			✓	✓	✓					✓	✓	✓				
<b>Marsa</b>																											
Transport Malta				✓	✓	✓					✓	✓	✓	✓	✓	✓					✓		✓				✓
<b>Paola</b>																											
Kordin Grain Terminal Company Ltd				✓	✓																						
<b>MAURITANIA</b>																											
<b>Nouadhibou</b>																											
Port Autonome de Nouadhibou																											
<b>MAURITIUS</b>																											
<b>Port Louis</b>																											
Mauritius Ports Authority	✓			✓	✓	✓					✓		✓	✓	✓								✓	✓	✓	✓	✓
<b>MEXICO</b>																											
<b>Acapulco</b>																											
Port Authority of Acapulco																											
<b>Altamira</b>																											
Cooper/T. Smith De Mexico SA de CV	✓																										
<b>Altamira</b>																											
Industrial Port of Altamira				✓														✓						✓			
<b>Altamira</b>																											
Terminal Maritima de Altamira, SA de CV				✓														✓									
<b>Chiapas</b>																											
Port Authority of Puerto Madero																											✓
<b>Ensenada</b>																											
Port Authority of Ensenada							✓																	✓			



COMMODITIES	CL	CC	PC	G-A	AF	CM	CLK	IO	BX	AL	FR	G-FGD	AG	SU	SOY	SODA	MIN	CHEM	BIO	R/M	BC	FRS	STL	P&P	MB	OTH	
<b>Garita de Otay</b>																											
Morro Redondo Port Authority																										✓	
<b>Guaymas</b>																										✓	
Port Authority of Guaymas																										✓	
<b>La Paz</b>																											
San Juan de la Costa Port Authority											✓																
<b>Lazaro Cardenas</b>																											
Terminales Portuarias Del Pacifico, S A P I de C V	✓	✓	✓			✓	✓	✓			✓						✓				✓		✓				
<b>Mazatlan</b>																											
Port Authority of Mazatlan				✓																						✓	
<b>Salina Cruz</b>																											
Port Authority of Salina Cruz			✓	✓		✓					✓						✓				✓		✓	✓	✓	✓	
<b>San Carlos</b>																											
San Carlos Port Authority				✓																							
<b>Tampico</b>																											
Port Authority of Tampico	✓			✓		✓						✓															
<b>Topolobampo</b>																											
Topolobampo Port Authority						✓					✓																
<b>Veracruz</b>																											
Port Authority of Veracruz				✓		✓			✓		✓				✓												
<b>MOROCCO</b>																											
<b>Casablanca</b>																											
Office d'Exploitation des Ports																											
<b>Casablanca</b>																											
Port Nador				✓																							
<b>El Jadida</b>																											
Agence Nationale Des Ports	✓			✓		✓					✓																
<b>El Jadida</b>																											
Jorf Lasfar Power Station	✓										✓																
<b>Kenitra</b>																											
Port of Kenitra				✓																							
<b>Tangier</b>																											
Port of Tangier				✓																							
<b>MOZAMBIQUE</b>																											
<b>Beira</b>																											
Cornelder de Moçambique, s.a.r.l																											
<b>Beira</b>																											
Largo dos CFM-C	✓							✓																			
<b>Maputo</b>																											
Grindrod Terminals - Maputo	✓							✓																			
<b>Maputo</b>																											
Maputo Port Development Company SARL	✓		✓	✓		✓	✓	✓		✓	✓	✓		✓	✓	✓	✓				✓	✓	✓	✓	✓	✓	
<b>Maputo</b>																											
Mozambique Ports and Railways - CFM	✓			✓				✓						✓									✓			✓	
<b>Maputo</b>																											
New Coal Terminal Beira SA	✓																										
<b>Maputo</b>																											
Portos e Caminhos De Ferro de Mozambique				✓				✓						✓													
<b>Matola</b>																											
Stema SA				✓	✓											✓											
<b>Nacala</b>																											
Nacala Port Authority				✓							✓																
<b>MYANMAR</b>																											
<b>Yangon</b>																											
Yangon Port Authority	✓			✓																							
<b>NAMIBIA</b>																											
<b>Walvis Bay</b>																											
Grindrod Terminals - Walvis Bay																										✓	
<b>Walvis Bay</b>																											
Namibian Ports Authority	✓			✓				✓	✓								✓								✓	✓	
<b>Walvis Bay</b>																											
Namport																											
<b>NAURU</b>																											
<b>Aiwo</b>																											
Nauru Port Authority											✓																
<b>NETHERLANDS ANTILLES</b>																											
<b>Bonaire</b>																											
Bonaire Pilots				✓																							✓

# COMMODITIES HANDLED

COMMODITIES	CL	CC	PC	G-A	AF	CM	CLK	IO	BX	AL	FR	G-FGD	AG	SU	SOY	SODA	MIN	CHEM	BIO	R/M	BC	FRS	STL	P&P	MB	OTH	
<b>Curacao</b>																											
Curacao Ports Authority																											
<b>NEW CALEDONIA</b>																											
<b>Houailou</b>																											
Societe des Mines du Cap Bocage																										✓	
<b>Noumea</b>																											
Port Authority of New Caledonia	✓			✓				✓				✓														✓	
<b>NEW ZEALAND</b>																											
<b>Auckland</b>																											
NZ Stevedoring Co Ltd																											
<b>Auckland</b>																											
Onehunga Port Authority																										✓	
<b>Auckland</b>																											
Ports of Auckland Limited	✓			✓	✓	✓						✓	✓	✓	✓	✓						✓	✓	✓		✓	
<b>Bluff</b>																											
South Port NZ Ltd	✓	✓	✓	✓	✓	✓				✓	✓												✓			✓	
<b>Lyttelton</b>																											
Lyttelton Coal Terminal	✓																										
<b>Mount Maunganui</b>																											
NZL Group Limited t/a NZ Marshalling & Stevedoring																											
<b>Napier</b>																											
Port of Napier Ltd						✓					✓											✓	✓	✓	✓		
<b>New Plymouth</b>																											
Port Taranaki Limited	✓			✓	✓	✓					✓				✓								✓				
<b>Port Chalmers</b>																											
Port Otago Ltd						✓					✓												✓				
<b>Ruakaka</b>																											
Northport Ltd	✓			✓	✓	✓	✓				✓	✓	✓									✓	✓	✓	✓	✓	
<b>Tauranga</b>																											
C3 Limited (previously Toll Owens Ltd)	✓			✓	✓						✓	✓										✓	✓	✓	✓	✓	
<b>Tauranga</b>																											
Port of Tauranga Ltd	✓	✓		✓	✓	✓	✓				✓	✓		✓	✓	✓		✓				✓	✓	✓	✓	✓	
<b>Timaru</b>																											
PrimePort Timaru				✓	✓	✓					✓			✓								✓	✓				
<b>Wanganui</b>																											
Wanganui Port Authority				✓							✓	✓											✓			✓	
<b>Wellington</b>																											
Port of Wellington				✓							✓	✓															
<b>Westport</b>																											
Westport Harbour	✓					✓	✓				✓	✓										✓				✓	
<b>NICARAGUA</b>																											
<b>Managua</b>																											
Empresa Portuaria Nacional (EPN)																											
<b>Sandino</b>																											
Port Sandino											✓																
<b>NIGERIA</b>																											
<b>Lagos</b>																											
Nigerian Ports Authority	✓			✓							✓															✓	
<b>Port Harcourt</b>																											
Port Harcourt	✓																										
<b>NORWAY</b>																											
<b>Brevik</b>																											
Grenland Port Authority	✓																										
<b>Drummen</b>																											
Port Authority of Drammen				✓																							
<b>Farsund</b>																											
Elkem Aluminium Lista										✓																	
<b>Floro</b>																											
Port Authority of Floro																											
<b>Glomfjord</b>																											
Port Authority of Glomfjord											✓																
<b>Husnes</b>																											
Aluminium Works Terminal										✓																	
<b>Kirkenes</b>																											
Port of Kirkenes								✓																			
<b>Kristiansund</b>																											
Kristiansund and Nordmøre Port Authority																										✓	
<b>Larvik</b>																											
Larvik Port Authority								✓																		✓	



COMMODITIES	CL	CC	PC	G-A	AF	CM	CLK	IO	BX	AL	FR	G-FGD	AG	SU	SOY	SODA	MIN	CHEM	BIO	R/M	BC	FRS	STL	P&P	MB	OTH	
<b>Mo I Rana</b>																											
Mo I Rana Port Authority	✓		✓					✓	✓																	✓	
<b>Mosjoen</b>																											
Mosjoen Port Authority									✓																		
<b>Moss</b>																											
Port Authority of Moss				✓																							
<b>Narvik</b>																											
LKAB								✓									✓										
<b>Narvik</b>																											
Narvik Port Authority								✓																		✓	
<b>Orkanger</b>																											
Port of Orkanger								✓																		✓	
<b>Ovre</b>																											
Aardalstangen			✓							✓																	
<b>Sauda</b>																											
Sauda Port Authority								✓	✓																		
<b>Sentrum</b>																											
Oslo Port Authority				✓		✓					✓			✓			✓					✓					
<b>Stavanger</b>																											
Port Authority of Stavanger				✓																						✓	
<b>Stavanger</b>																											
Stavanger Havneseilo				✓																							
<b>Sundalsora</b>																											
Hydro Aluminium Private Terminal									✓																		
<b>Svolvaer</b>																											
Vagan																										✓	
<b>PAKISTAN</b>																											
<b>Karachi</b>																											
Bulk Trade International																											
<b>Karachi</b>																											
Pak Shaheen Group	✓	✓	✓	✓				✓			✓																
<b>Karachi</b>																											
PIBT Ltd	✓					✓	✓																				
<b>Karachi</b>																											
Port Muhammad Bin Gasim	✓			✓		✓	✓	✓			✓			✓													
<b>PAPUA NEW GUINEA</b>																											
<b>Alotau</b>																											
Alotau Port Authority																											✓
<b>Kavieng</b>																											
Kavieng Port Authority																											✓
<b>Kimbe</b>																											
Kieta Port Authority																											✓
<b>Kimbe</b>																											
Kimbe Port Authority																											✓
<b>Lae</b>																											
Lae Port Authority																											✓
<b>Lae</b>																											
PNG Ports Corporation Limited				✓	✓	✓	✓				✓		✓	✓								✓	✓	✓	✓	✓	✓
<b>Popondetta</b>																											
Oro Bay Port Authority																											✓
<b>Rabaul</b>																											
Rabaul Port Authority																											✓
<b>PERU</b>																											
<b>Arequipa</b>																											
Terminal Internacional del Sur SA																											
<b>Callao</b>																											
Conchan Port Authority							✓																				
<b>Callao</b>																											
ENAPU SA	✓																										
<b>Chancy</b>																											
Chancay Port Authority																											✓
<b>Ilo</b>																											
Agencia Maritima Busonich																											✓
<b>Iquitos</b>																											
Iquitos Port Authority					✓																						
<b>La Caleta</b>																											
Port Authority of Chimbote	✓		✓	✓				✓	✓		✓																✓
<b>La Perla</b>																											
Autoridad Portuaria Nacional																											
<b>Moquegua</b>																											
ILO Port Terminal	✓																										

# COMMODITIES HANDLED

COMMODITIES	CL	CC	PC	G-A	AF	CM	CLK	IO	BX	AL	FR	G-FGD	AG	SU	SOY	SODA	MIN	CHEM	BIO	RM	BC	FRS	STL	P&P	MB	OTH	
<b>Pisco</b>																											
General San Martin Port Authority				✓							✓																
<b>Supe Puerto</b>																											
Supe Port Authority				✓																							
<b>Trujillo</b>																											
ENAPU SA	✓																										
<b>PHILIPPINES</b>																											
<b>Batangas City</b>																											
Batangas Port Authority	✓																									✓	
<b>Cagayan de Oro City</b>																											
Masao Port Authority				✓							✓			✓												✓	
<b>Cagayan de Oro City</b>																											
Philippine Ports Authority				✓							✓			✓									✓			✓	
<b>Cebu City</b>																											
Cebu Port Authority																										✓	
<b>Iligan City</b>																											
Iligan Port Authority																										✓	
<b>Jolo Sulu</b>																											
Jolo Port Authority				✓																							
<b>La Union</b>																											
San Fernando Port Authority																										✓	
<b>Legazpi City</b>																											
Lagazpi Port Management Authority				✓																							
<b>Makati City</b>																											
Mariveles Port-Smithbell & Co				✓																							
<b>Makati City</b>																											
Wilhelmsen-Smith Bell Shipping, Inc.	✓			✓	✓	✓	✓	✓	✓	✓	✓	✓	✓	✓	✓	✓	✓	✓	✓				✓	✓	✓	✓	
<b>Manila</b>																											
Asian Terminals Incorporated				✓																							
<b>Manila</b>																											
Philippine Ports Authority											✓																
<b>Tacloban</b>																											
Philippine Ports Authority				✓	✓						✓			✓	✓								✓	✓	✓	✓	
<b>POLAND</b>																											
<b>Gdansk</b>																											
GBT Sp. z o.o.	✓			✓							✓																
<b>Gdansk</b>																											
Port of Gdansk Authority SA	✓	✓	✓	✓	✓	✓	✓	✓	✓	✓	✓	✓	✓	✓	✓	✓	✓	✓	✓		✓		✓	✓	✓	✓	
<b>Gdansk</b>																											
PPS Port Polnocny Co Ltd	✓																										
<b>Gdynia</b>																											
Baltic Grain Terminal				✓	✓																						
<b>Gdynia</b>																											
Baltic Ports Organization Secretariat																											
<b>Gdynia</b>																											
BTDG - Baltic General Cargo Term'l Gdynia											✓												✓				
<b>Gdynia</b>																											
Maritime Bulk Terminal Gdynia Ltd	✓	✓	✓	✓	✓		✓	✓	✓	✓	✓		✓	✓	✓						✓				✓	✓	
<b>Gdynia</b>																											
Port of Gdynia	✓	✓	✓	✓	✓	✓	✓	✓	✓	✓	✓	✓	✓	✓	✓	✓	✓	✓	✓		✓	✓	✓	✓	✓	✓	
<b>Gdynia</b>																											
Rudoport SA	✓	✓						✓				✓															
<b>Kolobrzeg</b>																											
Port Authority of Kolobrzeg																											
<b>Police</b>																											
Grupa Azoty											✓															✓	
<b>Swinoujscie</b>																											
Port Handlowy Swinoujscie Sp. z o.o.	✓	✓	✓	✓	✓	✓	✓	✓	✓	✓	✓	✓	✓	✓	✓	✓	✓	✓	✓		✓	✓	✓	✓	✓	✓	
<b>Szczecin</b>																											
Andreas sp. z o.o.				✓																							
<b>Szczecin</b>																											
Bulk Cargo - Port Szczecin Sp. z o.o.	✓	✓	✓	✓	✓	✓	✓	✓	✓	✓	✓		✓		✓		✓	✓					✓		✓		
<b>Szczecin</b>																											
Przedsiębiorstwo Usług Portowych				✓																							
<b>Szczecin</b>																											
Szczecin & Swinoujscie Seaports Authority	✓	✓	✓	✓	✓	✓	✓		✓	✓	✓	✓	✓	✓	✓	✓	✓	✓				✓	✓	✓	✓	✓	
<b>PORTUGAL</b>																											
<b>Aveiro</b>																											
Socarpor (Aveiro) SA				✓	✓	✓	✓				✓					✓	✓					✓	✓	✓	✓		
<b>Barreiro</b>																											
Barreiro Terminal - Atlanport	✓							✓			✓						✓						✓	✓	✓	✓	



COMMODITIES	CL	CC	PC	G-A	AF	CM	CLK	IO	BX	AL	FR	G-FGD	AG	SU	SOY	SODA	MIN	CHEM	BIO	R/M	BC	FRS	STL	P&P	MB	OTH	
<b>Doca de Alcântara</b>																											
Lisbon Port Authority	✓			✓		✓		✓	✓		✓																
<b>Funchal</b>																											
Port Authority of Madeira				✓																							
<b>Gafanha da Nazaré</b>																											
APA - Administração do Porto de Aveiro, S.A.				✓		✓					✓											✓				✓	
<b>Leca da Palmeira</b>																											
Port Authority of Leixoes				✓						✓												✓	✓				
<b>Lisbon</b>																											
APL - Administration of Port of Lisbon				✓																							
<b>Lisbon</b>																											
Iberol - Sociedade Iberica de Biocombustiveis				✓											✓												✓
<b>Lisbon</b>																											
Portsines - Terminal Multipurpose de Sines	✓																										
<b>Lisbon</b>																											
Silopor - Empresa de Silos Portuários, S.A				✓																							
<b>Lisbon</b>																											
Silopor - Empresa De Silos Portuários, SA				✓	✓										✓												✓
<b>Lisbon</b>																											
Sovena - Oilseeds Portugal, SA				✓	✓										✓												✓
<b>Lisbon</b>																											
TMPB - Poço Bispo Multipurpose Terminal	✓			✓	✓	✓	✓				✓				✓	✓					✓	✓	✓	✓	✓	✓	✓
<b>Lisbon</b>																											
TPB - SILOPOR SA										✓					✓							✓	✓	✓	✓	✓	✓
<b>Setubal</b>																											
Junta Autonoma Do Porto De Setubal	✓			✓							✓																
<b>Setubal</b>																											
Sadomar																											
<b>Sines</b>																											
Porto de Sines SA	✓																										
<b>Trafaria</b>																											
Trafaria Terminal - Silopor				✓																							
<b>Vila Franca de Xira</b>																											
Alhandra Terminal- Cimpor Industria de Cimentos SA						✓	✓																				✓
<b>PUERTO RICO</b>																											
<b>San Juan</b>																											
Port of Ponce	✓																										
<b>San Juan</b>																											
Puerto Rico Port Authority				✓																							
<b>QATAR</b>																											
<b>Doha</b>																											
Qatar Flour Mills Co				✓																							
<b>Doha</b>																											
Umm Said Ports Authority				✓		✓		✓			✓																✓
<b>REPUBLIC OF CONGO</b>																											
<b>Pointe Noire</b>																											
Port Authority of Pointe Noire	✓							✓																			
<b>REPUBLIC OF GUINEA</b>																											
<b>Conakry</b>																											
Conakry Port Authority				✓				✓	✓																		✓
<b>Conakry</b>																											
Direction du Port de Kamsar									✓																		
<b>Conakry</b>																											
Port Autonome de Conakry				✓				✓	✓																		
<b>REPUBLIC OF YEMEN</b>																											
<b>Hodeidah</b>																											
Hodeidah Port				✓																							
<b>REUNION</b>																											
<b>Cedex</b>																											
Port Réunion																											
<b>Le Port Cedex, Reunion</b>																											
Direction Departementale de L'Equipment																											
<b>ROMANIA</b>																											
<b>Agigea</b>																											
Silotrans SRL				✓																							
<b>Braila</b>																											
Braila Port Authority				✓		✓		✓			✓																✓

# COMMODITIES HANDLED

COMMODITIES	CL	CC	PC	G-A	AF	CM	CLK	IO	BX	AL	FR	G-FGD	AG	SU	SOY	SODA	MIN	CHEM	BIO	R/M	BC	FRS	STL	P&P	MB	OTH	
<b>Constantza</b>																											
Comvex SA	✓	✓	✓				✓	✓	✓		✓						✓									✓	
<b>Constantza</b>																											
SC MINMETAL SA Constanta / Romania	✓			✓				✓	✓						✓								✓				
<b>Constantza</b>																											
SC Silotrans Srl																											
<b>Constantza</b>																											
Constantza Port Administration	✓	✓		✓				✓			✓																
<b>Constantza</b>																											
Sicim SA						✓																					
<b>Sulina</b>																											
Sulina Free Zone Administration											✓															✓	
<b>RUSSIA</b>																											
<b>Arkangelsk</b>																											
Port of Arkangelsk				✓							✓												✓	✓			
<b>Kaliningrad</b>																											
Transmarine																						✓	✓				
<b>Moscow</b>																											
Lavna Seaport				✓																							
<b>Moscow</b>																											
North Western Management Co., Ltd	✓	✓																									
<b>Murmansk</b>																											
Port of Murmansk Authority	✓							✓	✓		✓															✓	
<b>Nakhodka</b>																											
Nakhodka Port Authority	✓			✓		✓		✓	✓		✓														✓	✓	
<b>Nakhodka (Vrangel)</b>																											
Vostochny Port (DJSC)	✓																										
<b>Novorossiysk</b>																											
Novorossiysk Port Authority	✓			✓		✓		✓							✓											✓	
<b>Saint Petersburg</b>																											
Port of Ust-Luga	✓										✓																
<b>Saint Petersburg</b>																											
Seaport of St Petersburg JSC				✓	✓					✓	✓				✓	✓					✓	✓	✓	✓	✓	✓	
<b>Saint Petersburg</b>																											
Ust:Luga Coal Terminal "Rosterminalugol", JSC	✓																										
<b>Taman</b>																											
Management Company EFCO																											
<b>Tuapse</b>																											
Port of Tuapse Authority	✓																										
<b>Ulegorsk</b>																											
Ulegorsk Port Authority																										✓	
<b>Vanino</b>																											
Vanino Commercial Sea Port, PJSC	✓																					✓					
<b>Vanino</b>																											
Vanino Port Authority	✓																										
<b>Vladivostok</b>																											
Aqua-Resources Co.,Ltd	✓																										
<b>Vladivostok</b>																											
Vladivostok Port Authority	✓			✓		✓			✓		✓				✓											✓	
<b>Vyborg</b>																											
Port of Vyborg Authority	✓							✓	✓					✓	✓											✓	
<b>SAUDI ARABIA</b>																											
<b>Dammam</b>																											
Arabian Agricultural Services (ARASCO)				✓																							
<b>Dammam</b>																											
Gulf Agency Company (SA)			✓	✓	✓	✓	✓	✓	✓	✓	✓	✓	✓	✓	✓	✓	✓	✓	✓		✓	✓	✓	✓	✓	✓	
<b>Dammam</b>																											
King Abdul Aziz Port Authority-Dammam				✓		✓		✓	✓		✓																
<b>Jeddah</b>																											
AJWA Port Services Co.			✓	✓	✓	✓	✓				✓	✓	✓		✓	✓	✓	✓			✓	✓	✓	✓	✓	✓	
<b>Jeddah</b>																											
Jeddah Islamic Port				✓	✓	✓	✓				✓			✓	✓			✓			✓	✓	✓	✓	✓	✓	
<b>Jizan</b>																											
Jizan Port Management				✓		✓								✓													
<b>Yanbu</b>																											
Yanbu Commercial Port			✓	✓		✓																					
<b>SENEGAL</b>																											
<b>Dakar</b>																											
Port Autonome de Dakar																											

COMMODITIES	CL	CC	PC	G-A	AF	CM	CLK	IO	BX	AL	FR	G-FGD	AG	SU	SOY	SODA	MIN	CHEM	BIO	R/M	BC	FRS	STL	P&P	MB	OTH		
<b>SEYCHELLES</b>																												
<b>Victoria</b>																												
Seychelles Ports Authority						✓																						
<b>SIERRA LEONE</b>																												
<b>Cline Town</b>																												
Sierra Leone Port Authority				✓					✓																		✓	
<b>Freetown</b>																												
Pepel								✓																				
<b>Freetown</b>																												
Sierra Leone Ports Authority				✓																								
<b>SINGAPORE</b>																												
<b>Jurong</b>																												
Sembawang Terminal																							✓				✓	
<b>Singapore</b>																												
Jaldhi Overseas Pte Ltd																												
<b>Singapore</b>																												
Jurong Port Pte Ltd						✓	✓							✓											✓	✓		
<b>Singapore</b>																												
LD Ports & Logistics	✓							✓																				
<b>Singapore</b>																												
Maritime and Port Authority of Singapore																												
<b>Singapore</b>																												
Offshore Bulk Terminal Pte Ltd	✓							✓																				
<b>Singapore</b>																												
Sin Heng Chan (Singapore) Pte Ltd						✓																						
<b>SLOVENIA</b>																												
<b>Koper</b>																												
Luka Koper d.d., Dry Bulk Cargo Terminal			✓	✓	✓	✓	✓	✓	✓	✓	✓			✓	✓	✓	✓	✓										
<b>SOUTH AFRICA</b>																												
<b>Bishopsgate</b>																												
South African Sugar Association														✓														
<b>Durban</b>																												
Bidfreight Port Operations (Pty) Ltd				✓	✓	✓	✓	✓		✓	✓			✓	✓	✓					✓	✓	✓	✓	✓	✓	✓	✓
<b>Durban</b>																												
Bulk Connections			✓			✓	✓	✓			✓			✓												✓	✓	
<b>Durban</b>																												
Grindrod Terminals	✓	✓						✓			✓																	✓
<b>Durban</b>																												
Grindrod Terminals - Maydon Wharf											✓										✓							
<b>Durban</b>																												
South African Bulk Terminals LTD				✓	✓						✓			✓	✓	✓	✓	✓								✓		
<b>Durban</b>																												
South African Sugar Association (Pty) Ltd														✓														
<b>Durban</b>																												
Transnet Port Terminals	✓			✓				✓					✓		✓										✓		✓	
<b>East London</b>																												
S A Port Ops East London Grain Terminal				✓																								
<b>East London</b>																												
Transnet National Port Authority																												
<b>Johannesburg</b>																												
Anglo Coal	✓																											
<b>Johannesburg</b>																												
National Ports Authority of South Africa (NPASA)				✓		✓							✓											✓			✓	
<b>Port Elizabeth</b>																												
Portnet Port Elizabeth								✓	✓																	✓	✓	
<b>Port Elizabeth</b>																												
Transnet Port Terminals				✓											✓									✓	✓	✓		
<b>Richards Bay</b>																												
Port of Richards Bay	✓						✓		✓		✓											✓	✓	✓	✓			
<b>Richards Bay</b>																												
Richards Bay Coal Terminal	✓																											
<b>Richards Bay</b>																												
Transnet Port Terminals	✓	✓	✓						✓	✓	✓						✓						✓			✓	✓	
<b>Richard's Bay</b>																												
Grindrod Terminals - Richard's Bay	✓	✓					✓						✓					✓				✓				✓	✓	
<b>Saldanha</b>																												
S A Port Ops																												
<b>Saldanha</b>																												
Saldanha Bulk Terminal								✓																				



# COMMODITIES HANDLED

COMMODITIES	CL	CC	PC	G-A	AF	CM	CLK	IO	BX	AL	FR	G-FGD	AG	SU	SOY	SODA	MIN	CHEM	BIO	R/M	BC	FRS	STL	P&P	MB	OTH	
<b>SOUTH KOREA</b>																											
<b>Cheju</b>																											
Cheju Port Authority																											✓
<b>Donghae City</b>																											
Donghae Port Authority	✓					✓			✓			✓															✓
<b>Donghae City</b>																											
Mukho Port Authority	✓					✓																					✓
<b>Gwang Yang-City</b>																											
Posco Terminal Co., Ltd	✓																										
<b>Inchon</b>																											
Korea Silo Company Pier 7				✓																							
<b>Jung-gu</b>																											
Incheon Port Authority	✓			✓																							
<b>Kunsan</b>																											
Changhang Port Authority																											✓
<b>Kunsan</b>																											
Kunsan Port Authority																											✓
<b>Masan-South</b>																											
Masan Port Authority																											✓
<b>Nam Ku</b>																											
Ulsan Port Authority	✓			✓		✓		✓			✓		✓														✓
<b>Pohang</b>																											
Pohang District Maritime & Port Authority	✓							✓																			
<b>Pohang</b>																											
Port of Pohang	✓																										
<b>Ulsan</b>																											
Port of Ulsan Public Piers 1&2	✓			✓		✓		✓			✓		✓														
<b>Yosu</b>																											
Samil Port Authority											✓																
<b>Yosu</b>																											
Yoesu Port Authority	✓			✓							✓																
<b>SPAIN</b>																											
<b>Alcudia</b>																											
Port of Alcudia	✓					✓	✓																				
<b>Algeciras</b>																											
Port Authority of La Bahia de Algeciras	✓					✓																			✓	✓	
<b>Alicante</b>																											
Port of Alicante	✓					✓		✓																			
<b>Almeria</b>																											
Carboneras	✓		✓			✓		✓																			✓
<b>Almeria</b>																											
Port of Almeria	✓																										
<b>Asturias</b>																											
Port Authority of Aviles	✓			✓				✓	✓		✓														✓	✓	
<b>Barcelona</b>																											
Cemex España																											
<b>Barcelona</b>																											
Ergransa				✓																							
<b>Barcelona</b>																											
Ergransa Terminal				✓																							
<b>Barcelona</b>																											
Moyresa Molturación y Refino SA				✓																							
<b>Barcelona</b>																											
Port of Barcelona	✓		✓	✓		✓	✓	✓	✓		✓		✓	✓	✓	✓	✓	✓	✓	✓	✓	✓	✓	✓	✓	✓	✓
<b>Barcelona</b>																											
Portcemen, SA						✓																					
<b>Barcelona</b>																											
Tramer SA											✓																
<b>Bilbao</b>																											
Autoridad Portuaria De Bilbao	✓		✓	✓	✓	✓	✓	✓	✓		✓		✓	✓	✓	✓	✓	✓	✓	✓	✓	✓	✓	✓	✓	✓	✓
<b>Cadiz</b>																											
Cadiz Bay Port Authority	✓			✓		✓	✓				✓		✓	✓													✓
<b>Cartagena</b>																											
Port Authority of Cartagena	✓		✓	✓	✓	✓	✓	✓			✓	✓	✓		✓	✓	✓	✓	✓	✓	✓	✓	✓	✓	✓	✓	✓
<b>Cartagena</b>																											
Port of Aguilas				✓		✓																					
<b>Ferrol</b>																											
Port Authority of Ferrol - San Cibrao	✓					✓	✓	✓	✓	✓		✓					✓					✓	✓	✓	✓	✓	✓
<b>Ferrol</b>																											
Port Authority of Ferrol-San Ciprian	✓			✓							✓												✓			✓	
<b>Formentera</b>																											
Port of La Savina																											

COMMODITIES	CL	CC	PC	G-A	AF	CM	CLK	IO	BX	AL	FR	G-FGD	AG	SU	SOY	SODA	MIN	CHEM	BIO	R/M	BC	FRS	STL	P&P	MB	OTH	
<b>Garrucha</b>																											
Garrucha		✓										✓	✓														
<b>Gijón</b>																											
AUTORIDAD PORTUARIA DE GIJON	✓	✓	✓	✓		✓	✓	✓			✓											✓	✓	✓	✓		
<b>Gijón</b>																											
EBHI - European Bulk Handling Installation	✓	✓	✓					✓									✓										
<b>Huelva</b>																											
Port Authority of Huelva	✓										✓															✓	
<b>Ibiza</b>																											
Port of Ibiza																											
<b>La Coruña</b>																											
Muelle del Centenario	✓																										
<b>La Coruña</b>																											
Port Authority of La Coruña	✓			✓	✓	✓	✓			✓						✓							✓		✓	✓	
<b>La Coruña</b>																											
Terminales Maritimos de Galicia S.L.	✓			✓							✓					✓						✓	✓				
<b>La Coruña</b>																											
Terminales Maritimos de Galicia, S.L.	✓	✓	✓	✓	✓	✓	✓	✓	✓	✓	✓	✓	✓	✓	✓	✓	✓					✓	✓	✓	✓	✓	
<b>Los Barrios</b>																											
Endesa	✓							✓	✓																		
<b>Madrid</b>																											
Ership S.A.U	✓	✓	✓	✓		✓	✓	✓	✓	✓	✓	✓	✓	✓	✓	✓	✓		✓	✓	✓	✓	✓	✓	✓	✓	
<b>Mahon</b>																											
Port of Mahon						✓																					
<b>Malaga</b>																											
Malaga Port Authority	✓	✓		✓		✓	✓				✓						✓					✓				✓	
<b>Marin</b>																											
Ceferino Nogueira SA				✓																							
<b>Melilla</b>																											
Port Authority of Melilla						✓		✓	✓																		
<b>Motril</b>																											
Port of Motril	✓			✓		✓	✓				✓						✓	✓			✓	✓	✓	✓	✓	✓	
<b>Palma</b>																											
Port of Palma				✓		✓					✓															✓	
<b>Pasaia</b>																											
Port Authority of Pasaia	✓		✓			✓		✓		✓	✓												✓	✓		✓	
<b>Pto. Alcudia</b>																											
Transportes Maritimos Alcudia, SA	✓																										
<b>Sagunto</b>																											
Port of Sagunto	✓					✓					✓																
<b>Santa Cruz de Tenerife</b>																											
Port Authority of Tenerife				✓		✓					✓															✓	
<b>Santander</b>																											
Autoridad Portuaria de Santander	✓	✓	✓	✓	✓	✓		✓		✓	✓		✓	✓	✓	✓	✓	✓			✓	✓	✓	✓	✓	✓	
<b>Sevilla</b>																											
Port Authority of Sevilla	✓			✓																							
<b>Tarragona</b>																											
Berge Marítima				✓																							
<b>Tarragona</b>																											
Codemar-Iberbulk				✓																						✓	
<b>Tarragona</b>																											
Euroports Iberica TPS	✓		✓	✓	✓		✓				✓	✓				✓	✓	✓	✓		✓	✓	✓	✓	✓	✓	
<b>Tarragona</b>																											
Port Authority of Tarragona	✓		✓	✓	✓	✓	✓				✓					✓						✓	✓	✓		✓	
<b>Tarragona</b>																											
Silos de Tarragona SA (SITASA)				✓																							
<b>Torre Vieja</b>																											
Torre Vieja Port Authority						✓																				✓	
<b>Valencia</b>																											
Inst. Portuarios de Estudios																											
<b>Valencia</b>																											
Port Authority of Valencia	✓	✓	✓	✓	✓	✓	✓				✓		✓			✓	✓	✓				✓	✓	✓	✓	✓	
<b>Vigo</b>																											
Port Authority of Vigo				✓		✓		✓	✓		✓																
<b>Vilagarcía de Arousa</b>																											
Autoridad Portuaria de Vilagarcía de Arousa				✓	✓	✓					✓		✓					✓			✓	✓	✓	✓	✓	✓	
<b>SRI LANKA</b>																											
<b>Galle</b>																											
Galle Port				✓		✓					✓	✓															
<b>ST PIERRE &amp; MIQUELON</b>																											
<b>Saint-Pierre and Miquelon</b>																											
Saint-Pierre Harbour																										✓	

# COMMODITIES HANDLED

COMMODITIES	CL	CC	PC	G-A	AF	CM	CLK	IO	BX	AL	FR	G-FGD	AG	SU	SOY	SODA	MIN	CHEM	BIO	R/M	BC	FRS	STL	P&P	MB	OTH	
<b>ST VINCENT &amp; THE GRENADINES</b>																											
<b>Kingstown</b>																											
Kingstown				✓																							
<b>SUDAN</b>																											
<b>Port Sudan</b>																											
Sea Ports Corporation	✓	✓	✓	✓	✓			✓	✓		✓		✓	✓	✓		✓	✓			✓	✓	✓	✓	✓	✓	✓
<b>SULTANATE OF OMAN</b>																											
<b>Liwa</b>																											
C. Steinweg Oman LLC																											
<b>Muscat</b>																											
Oman Flour Mills Co SAOG				✓																							
<b>Muscat</b>																											
Port Sultan Gaboos			✓	✓		✓	✓				✓			✓		✓					✓	✓	✓	✓	✓	✓	✓
<b>N. Azaiba</b>																											
Port of Duqm Company SAOC						✓											✓						✓				
<b>SURINAME</b>																											
<b>Paramaribo</b>																											
N.V. Havenbeheer Suriname				✓	✓	✓	✓				✓		✓	✓	✓	✓	✓	✓			✓	✓	✓	✓	✓	✓	✓
<b>SWEDEN</b>																											
<b>Gavle</b>																											
Port of Gavle AB	✓	✓						✓													✓	✓	✓	✓	✓	✓	✓
<b>Gavle</b>																											
Baltic Sea Gateway AB																											
<b>Göteborg</b>																											
Port of Göteborg																							✓				
<b>Halmstad</b>																											
Halmstad Port	✓																					✓	✓				
<b>Helsingborg</b>																											
Helsingborg Coal Terminal	✓																										
<b>Helsingborg</b>																											
Helsingborgs Hamn, Port of Helsingborg				✓				✓			✓																
<b>Helsingborg</b>																											
Lantmännen, Farmers Assoc.				✓																							
<b>Husum</b>																											
Husum Port																											
<b>Kalmar</b>																											
Kalmar Hamn AB (Port of Kalmar)				✓	✓		✓				✓		✓		✓							✓	✓		✓		
<b>Karlshamn</b>																											
Port of Karlshamn				✓																			✓				
<b>Karlstad</b>																											
Vänerhamn AB	✓		✓	✓	✓	✓		✓	✓		✓		✓		✓	✓	✓				✓	✓	✓	✓	✓		
<b>Kristinehamn</b>																											
Vänerhamn AB	✓			✓	✓						✓						✓				✓	✓	✓	✓	✓	✓	✓
<b>Lulea</b>																											
Port of Lulea	✓	✓	✓			✓		✓	✓																		
<b>Lysekil</b>																											
Port of Lysekil				✓																			✓	✓	✓	✓	✓
<b>Malmö</b>																											
Copenhagen Malmö Port AB	✓		✓	✓		✓						✓		✓						✓	✓		✓	✓	✓	✓	✓
<b>Oxelosund</b>																											
Oxelösunds Hamn AB	✓																										
<b>Södertälje</b>																											
Port of Sodertälje																											
<b>Sonderhamn</b>																											
Sonderhamn Port				✓																							
<b>Stockholm</b>																											
Port of Hargshamn								✓	✓														✓				
<b>Uddevalla</b>																											
Uddevalla Port				✓				✓	✓		✓																
<b>Västerås</b>																											
Mälarenhamnar AB	✓	✓	✓	✓	✓	✓		✓		✓	✓		✓				✓	✓			✓	✓	✓	✓	✓	✓	✓
<b>Ystad</b>																											
Port of Ystad	✓			✓							✓											✓	✓				✓
<b>SWITZERLAND</b>																											
<b>Basel</b>																											
Port of Switzerland	✓	✓	✓	✓	✓	✓				✓	✓	✓	✓	✓	✓	✓	✓	✓			✓	✓	✓	✓	✓	✓	✓
<b>Basel</b>																											
Rhenus-Alpina AG				✓																							
<b>Basel</b>																											
Ultra-Brag AG	✓	✓	✓	✓	✓					✓	✓			✓	✓		✓				✓	✓	✓	✓	✓	✓	✓



COMMODITIES	CL	CC	PC	G-A	AF	CM	CLK	IO	BX	AL	FR	G-FGD	AG	SU	SOY	SODA	MIN	CHEM	BIO	R/M	BC	FRS	STL	P&P	MB	OTH	
<b>Birsfelden</b>																											
BIRS Terminal AG	✓	✓						✓					✓												✓		
<b>Lugano</b>																											
Interbulk						✓	✓																				
<b>SYRIA</b>																											
<b>Tartous</b>																											
Tartous Port Authority											✓																
<b>TAIWAN</b>																											
<b>Hualien</b>																											
Haulien Port	✓					✓						✓	✓														✓
<b>Kaohsiung</b>																											
Kaohsiung Harbour Bureau	✓	✓		✓		✓	✓	✓	✓	✓	✓	✓		✓	✓	✓	✓	✓			✓		✓	✓	✓	✓	
<b>Keelung</b>																											
Keelung Port Authority	✓			✓		✓																					
<b>Mai Liao</b>																											
Mai Liao Harbour Administration Corp	✓		✓															✓									✓
<b>Suao Port Building</b>																											
Su-Ao Port Authority	✓					✓																					
<b>Taichung</b>																											
Port of Taichung, Asia Cement Berth																											
<b>Taichung</b>																											
Taichung-Wharf No 1				✓																							
<b>Taipei</b>																											
Eastern Media International Corporation				✓																							
<b>Wuchi</b>																											
Taichung Port Authority	✓			✓		✓							✓													✓	✓
<b>TANZANIA</b>																											
<b>Dar es Salaam</b>																											
Tanzania Harbours Authority				✓																							
<b>Dar es Salaam</b>																											
Tanzania Ports Authority	✓			✓	✓	✓	✓				✓	✓		✓	✓	✓	✓	✓				✓	✓	✓	✓	✓	✓
<b>Kurasini</b>																											
Grindrod Terminals - Dar Es Salaam																		✓									
<b>THAILAND</b>																											
<b>Bangpli</b>																											
S.P. Intermarine Co., Ltd	✓			✓				✓																			
<b>Sattahip</b>																											
Sattahip Port Authority																											✓
<b>Singhanakorn</b>																											
Chaophaya Terminal International Co. Ltd				✓							✓																
<b>THE GAMBIA</b>																											
<b>Banjul</b>																											
The Gambia Ports Authority																											
<b>THE NETHERLANDS</b>																											
<b>Amsterdam</b>																											
Amfert											✓																
<b>Amsterdam</b>																											
B.V. Bouwgrondstoffen AGM													✓														
<b>Amsterdam</b>																											
Civil and Marine Nederland													✓														
<b>Amsterdam</b>																											
Graham - Grondstoffen Exp.													✓														
<b>Amsterdam (Arc Marine)</b>																											
<b>Amsterdam</b>																											
IGMA	✓			✓	✓			✓	✓						✓		✓				✓						
<b>Amsterdam</b>																											
Maja Stuwadoors Rotterdam	✓			✓				✓																			
<b>Amsterdam</b>																											
OBA - Bulk Terminal Amsterdam	✓	✓	✓	✓	✓			✓	✓		✓		✓		✓	✓	✓		✓			✓		✓		✓	
<b>Amsterdam</b>																											
Port of Amsterdam	✓	✓	✓	✓	✓	✓	✓		✓	✓	✓	✓	✓	✓	✓	✓	✓	✓				✓	✓	✓	✓	✓	✓
<b>Amsterdam</b>																											
Rietlanden Terminals BV	✓	✓						✓																			✓
<b>Botlek</b>																											
Borax Rotterdam N.V.																											
<b>Botlek</b>																											
Jewmetaal Stainless Processing																								✓			
<b>Delfzijl</b>																											
Aldel - Aluminium Delfzijl										✓																	

# COMMODITIES HANDLED

COMMODITIES	CL	CC	PC	G-A	AF	CM	CLK	IO	BX	AL	FR	G-FGD	AG	SU	SOY	SODA	MIN	CHEM	BIO	R/M	BC	FRS	STL	P&P	MB	OTH
<b>Delfzijl</b>																										
Groningen Seaports								✓			✓															✓
<b>Dordrecht</b>																										
BV Zeehavenbedrijf Dordrecht (ZHD Stevedoring)	✓	✓	✓	✓	✓	✓	✓	✓	✓	✓	✓	✓	✓	✓		✓	✓					✓	✓	✓	✓	✓
<b>Dordrecht</b>																										
Port Authority of Dordrecht				✓							✓															✓
<b>Farmsum</b>																										
Akzonobel	✓																									✓
<b>Ijmuiden</b>																										
Tata Steel Logistics & Shipping BV	✓							✓	✓															✓		
<b>Koudekerk aan den Rijn</b>																										
ENBO BV						✓																				
<b>Mierlo</b>																										
International Bulk Handling Technology BV	✓		✓					✓			✓		✓	✓												
<b>Moerdijk</b>																										
Combined Cargo Terminals B.V.										✓												✓	✓	✓		✓
<b>Moerdijk</b>																										
Euro-Rijn International B.V.				✓	✓	✓		✓	✓	✓	✓						✓					✓	✓	✓	✓	✓
<b>Rotterdam</b>																										
C. Steinweg-Handelsverm BV																						✓	✓	✓	✓	✓
<b>Rotterdam</b>																										
Ertsoverslagbedrijf Europoort C.V. (EECV)	✓	✓						✓																		
<b>Rotterdam</b>																										
European Bulk Services (EBS) BV	✓	✓	✓	✓	✓	✓	✓	✓	✓	✓	✓		✓	✓	✓		✓								✓	✓
<b>Rotterdam</b>																										
Europees-Massagoed Overslagbedrijf (EMO)	✓	✓						✓																		
<b>Rotterdam</b>																										
Marcor Stevedoring BV Rotterdam	✓	✓	✓	✓	✓		✓	✓	✓	✓	✓	✓	✓	✓	✓	✓	✓						✓	✓	✓	✓
<b>Rotterdam</b>																										
Port of Rotterdam	✓	✓	✓	✓	✓	✓	✓	✓	✓	✓	✓	✓	✓	✓	✓	✓	✓	✓				✓	✓	✓	✓	✓
<b>Rotterdam</b>																										
RHB Stevedoring & Warehousing																						✓	✓	✓	✓	✓
<b>Rotterdam</b>																										
Van Uden Bulk Logistics			✓	✓	✓		✓	✓	✓	✓		✓	✓			✓	✓	✓				✓		✓	✓	✓
<b>Rotterdam</b>																										
Van Uden NedCargo																							✓			
<b>Rotterdam</b>																										
Van Uden Stevedoring	✓			✓	✓		✓	✓	✓		✓	✓					✓					✓		✓	✓	
<b>Rozenburg</b>																										
EP Shipping & Trading BV	✓			✓																						
<b>Sas van Ghent</b>																										
Zuid-Chemie											✓															
<b>Schiedam</b>																										
Nieuwe Waterweg Silo BV	✓		✓	✓	✓	✓	✓	✓	✓		✓	✓		✓	✓								✓	✓	✓	✓
<b>Schiedam</b>																										
Van Mannekus & Co																										✓
<b>Stiens</b>																										
EMG-Silo Groningen				✓																						
<b>Terneuzen</b>																										
Ovet BV - Terneuzen Terminal	✓	✓	✓	✓	✓		✓	✓	✓	✓	✓	✓	✓		✓	✓	✓		✓	✓	✓	✓	✓	✓	✓	✓
<b>Terneuzen</b>																										
Verbrugge Terneuzen Terminals					✓						✓						✓	✓	✓			✓	✓	✓	✓	✓
<b>Terneuzen</b>																										
Zeeland Seaports Port Authority	✓			✓					✓		✓												✓	✓	✓	✓
<b>Vlaardingen</b>																										
Port of Vlaardingen	✓			✓	✓		✓	✓	✓		✓													✓	✓	✓
<b>Vlaardingen</b>																										
Rotterdam Bulk Terminal (R.B.T.) B.V.	✓	✓	✓	✓			✓	✓	✓		✓		✓	✓			✓								✓	✓
<b>Vlissingen</b>																										
Ovet BV - Vlissingen Terminal	✓	✓	✓	✓	✓	✓	✓	✓	✓	✓	✓	✓	✓		✓	✓	✓		✓	✓	✓	✓	✓	✓	✓	✓
<b>Zwijndrecht</b>																										
Agro Delta Group				✓	✓						✓					✓										✓
<b>TOGA</b>																										
<b>Lome</b>																										
Office Togolaise des Phosphates																										
<b>TRINIDAD &amp; TOBAGO</b>																										
<b>Couvra Trinidad</b>																										
Point Lisas Industrial Port Develop't Corp Ltd																							✓	✓		
<b>Port of Spain</b>																										
Chaguaramas Terminals Ltd								✓	✓																	

COMMODITIES	CL	CC	PC	G-A	AF	CM	CLK	IO	BX	AL	FR	G-FGD	AG	SU	SOY	SODA	MIN	CHEM	BIO	R/M	BC	FRS	STL	P&P	MB	OTH	
<b>Port of Spain</b>																											
Cronstadt Island																											✓
<b>Port of Spain</b>																											
Port Authority of Trinidad and Tobago				✓																							
<b>Port of Spain</b>																											
Port of Spain				✓																							
<b>TUNISIA</b>																											
<b>Bizerte</b>																											
Office des Ports Nationaux Tunisiens				✓							✓																
<b>Bizerte</b>																											
Port Authority of Bizerte				✓		✓																					
<b>Port de la Goulette</b>																											
Port Authority of Tunis Goulette				✓				✓			✓																
<b>Sfax</b>																											
Port Authority of Sfax				✓							✓																✓
<b>TURKEY</b>																											
<b>Bursa</b>																											
Gemlik Port											✓																
<b>Eregli</b>																											
Eregli Port Authority	✓							✓	✓																		
<b>Hereke-Izmit</b>																											
NUH Cement Factory of Hereke						✓																					
<b>Istanbul</b>																											
Toros Tarım Sanayi ve Ticaret	✓	✓	✓	✓	✓	✓	✓	✓	✓	✓	✓	✓	✓	✓	✓	✓	✓	✓	✓	✓	✓	✓	✓	✓	✓	✓	✓
A -TOROS Ceyhan Term																											
<b>Izmir</b>																											
Izmir Port				✓	✓	✓	✓	✓	✓			✓		✓	✓						✓	✓	✓	✓	✓	✓	✓
<b>Mersin</b>																											
Famagusta Port Authority				✓		✓						✓															
<b>Sisli</b>																											
Toros Tarım Sanayi ve Ticaret A.	✓																										
<b>Tekirdag</b>																											
Port of Tekirdag				✓																							
<b>Trabzon</b>																											
Trabzon Port				✓				✓	✓																		
<b>UAE</b>																											
<b>Abu Dhabi</b>																											
Abu Dhabi Ports Company, ADPC	✓			✓		✓		✓		✓	✓												✓				
<b>Abu Dhabi</b>																											
Abu Dhabi Seaport Authority				✓							✓																✓
<b>Abu Dhabi</b>																											
E-ships Oldendorff Logistics	✓							✓																			
<b>Abu Dhabi</b>																											
Port Zayed																											
<b>Ajman</b>																											
Emirates Ports Services																											
<b>Dubai</b>																											
Dubai Port World				✓	✓	✓	✓	✓	✓	✓	✓	✓	✓	✓	✓	✓	✓	✓	✓	✓	✓	✓	✓	✓	✓	✓	✓
<b>Dubai,</b>																											
SOHAR Free Zone LLC (JLT Branch)				✓				✓		✓													✓				
<b>Fujairah</b>																											
Port of Fujairah								✓	✓				✓														✓
<b>UK</b>																											
<b>Ayr</b>																											
Associated British Ports (Ayr and Troon)	✓			✓	✓	✓					✓		✓		✓	✓					✓	✓	✓				✓
<b>Ayr</b>																											
Ayr	✓			✓							✓																
<b>Barrow upon Humber</b>																											
New Holland Bulk Services				✓							✓																
<b>Barrow-In-Furness</b>																											
Port of Barrow-in-Furness													✓										✓	✓	✓		✓
<b>Belfast</b>																											
Belfast Harbour Commissioners	✓			✓	✓	✓	✓				✓				✓								✓	✓	✓		
<b>Berwick-Upon-Tweed</b>																											
Berwick Harbour Commission				✓	✓	✓					✓												✓				✓
<b>Blyth</b>																											
Port of Blyth	✓																						✓		✓		
<b>Bootle</b>																											
EON UK Liverpool	✓																										
<b>Boston</b>																											
Lingrain Services Ltd				✓																							



# COMMODITIES HANDLED

COMMODITIES	CL	CC	PC	G-A	AF	CM	CLK	IO	BX	AL	FR	G-FGD	AG	SU	SOY	SODA	MIN	CHEM	BIO	R/M	BC	FRS	STL	P&P	MB	OTH
<b>Bristol</b>																										
The Bristol Port Company	✓			✓	✓						✓	✓	✓		✓							✓	✓		✓	✓
<b>Cardiff</b>																										
ABP South Wales (Ports of Newport,	✓			✓		✓																				
<b>Cardiff</b>																										
Associated British Ports	✓			✓	✓	✓	✓	✓	✓	✓	✓	✓	✓	✓	✓	✓	✓	✓	✓			✓	✓	✓	✓	✓
<b>Coleraine</b>																										
Coleraine Harbour Commissioners	✓																									✓
<b>Dundee</b>																										
Forth Ports PLC - Port of Dundee				✓							✓															
<b>Dundee</b>																										
Grainfax				✓	✓							✓														
<b>Egham</b>																										
Cemex UK						✓																				
<b>Falmouth</b>																										
A & P Falmouth Ltd	✓	✓		✓	✓						✓	✓					✓					✓	✓		✓	✓
<b>Felixstowe</b>																										
Felixstowe Dock & Railway Company																										✓
<b>Fowey</b>																										
Fowey Harbour Commissioners																										✓
<b>Garston</b>																										
ABP - Garston				✓	✓	✓	✓				✓	✓			✓							✓	✓	✓	✓	✓
<b>Glasgow</b>																										
Clyde Port Authority																							✓			
<b>Grangemouth</b>																										
Casper Shipping Ltd																								✓		
<b>Grangemouth</b>																										
Forth Ports Plc				✓																						
<b>Grangemouth</b>																										
Grangemouth	✓									✓		✓				✓	✓	✓				✓	✓	✓	✓	✓
<b>Grangemouth</b>																										
Leith Docks	✓			✓							✓															
<b>Gravesend</b>																										
Port of London Authority	✓			✓																						
<b>Great Yarmouth</b>																										
East Port UK	✓			✓	✓	✓					✓	✓											✓		✓	✓
<b>Grimsby</b>																										
Associated British Ports - Grimsby	✓		✓	✓	✓	✓	✓	✓	✓		✓	✓	✓	✓									✓	✓	✓	✓
<b>Hartlepool</b>																										
Tees and Hartlepool Port Authority	✓		✓	✓				✓	✓		✓	✓														✓
<b>Holywell</b>																										
Mostyn Docks Limited					✓							✓												✓		
<b>Hull</b>																										
ABP - Port of Hull	✓			✓	✓	✓					✓	✓										✓	✓	✓	✓	✓
<b>Hull</b>																										
Frontier Agriculture Ltd				✓																						
<b>Hull</b>																										
Titan Cement UK						✓																				
<b>Immingham</b>																										
Associated British Ports	✓		✓	✓	✓	✓			✓		✓	✓	✓	✓	✓	✓		✓	✓	✓	✓	✓	✓	✓	✓	✓
<b>Immingham</b>																										
Casper Shipping Ltd	✓	✓	✓	✓	✓			✓				✓			✓											✓
<b>Ipswich</b>																										
ABP - Port of Ipswich	✓			✓	✓	✓	✓			✓	✓	✓			✓	✓		✓				✓	✓	✓		✓
<b>Ipswich</b>																										
ABP Port of Lowestoft				✓		✓					✓	✓											✓			
<b>Ipswich</b>																										
Clarksons Port Services				✓	✓															✓			✓			
<b>Ipswich</b>																										
The Grain Terminal (Ipswich) Ltd				✓	✓																					
<b>Isle of Man</b>																										
Port of Ramsey	✓			✓	✓	✓					✓															✓
<b>Kings Lynn</b>																										
King's Lynn Conservancy Board				✓																						
<b>Liverpool</b>																										
Mersey Docks & Harbour Company	✓			✓	✓	✓	✓				✓	✓			✓								✓	✓	✓	✓
<b>Liverpool</b>																										
Royal Seaforth Grain Terminal				✓																						
<b>London</b>																										
MacGuarie Capital (Europe) Limited																										
<b>Londonderry</b>																										
Londonderry Port & Harbour Commissioners	✓			✓		✓					✓															✓

COMMODITIES	CL	CC	PC	G-A	AF	CM	CLK	IO	BX	AL	FR	G-FGD	AG	SU	SOY	SODA	MIN	CHEM	BIO	R/M	BC	FRS	STL	P&P	MB	OTH
<b>Manningtree</b>																										
Mistley Quay & Forwarding				✓				✓	✓		✓															
<b>Merton</b>																										
ABP																										
<b>Methil</b>																										
Port of Burntisland									✓																	
<b>Middlesbrough</b>																										
Casper Shipping Ltd	✓	✓	✓					✓				✓						✓	✓	✓		✓	✓	✓	✓	✓
<b>Middlesbrough</b>																										
Redcar Bulk Terminal Limited	✓	✓	✓					✓				✓									✓				✓	✓
<b>Montrose</b>																										
Montrose Port Authority	✓			✓	✓	✓					✓	✓			✓			✓	✓	✓	✓	✓	✓	✓	✓	✓
<b>Near Hull</b>																										
Hull Agency (Goole)	✓																									
<b>Newport</b>																										
ABP - Port of Newport	✓	✓	✓	✓	✓	✓					✓	✓					✓					✓	✓	✓	✓	✓
<b>Newport</b>																										
Newport Stevedores Ltd	✓		✓			✓																				✓
<b>North Killingholme</b>																										
Humber Sea Terminal																										
<b>Nottingham</b>																										
Hull Bulk Handling Ltd	✓	✓	✓	✓	✓						✓	✓	✓		✓			✓	✓	✓	✓				✓	
<b>Oban</b>																										
Glensanda Harbour													✓													
<b>Padstow</b>																										
Padstow Harbour Commissioners				✓							✓	✓														✓
<b>Penzance</b>																										
Penzance Harbour																										✓
<b>Perth</b>																										
Perth Harbour	✓		✓	✓	✓						✓	✓										✓				✓
<b>Poole</b>																										
Poole Harbour Commissioners				✓																						✓
<b>Port Talbot</b>																										
ABP - Port Talbot	✓																									
<b>Portbury</b>																										
Agricultural Bulk Services				✓																						
<b>Portland</b>																										
Portland Port Ltd				✓							✓	✓											✓	✓		
<b>Rosyth</b>																										
Port of Methil	✓			✓							✓															✓
<b>Runcorn</b>																										
Manchester Ship Canal Company Ltd				✓		✓				✓	✓	✓				✓	✓									✓
<b>Rye</b>																										
Rastrum Ltd				✓	✓								✓									✓	✓	✓		✓
<b>Seaham</b>																										
Seaham Harbour Dock Company	✓			✓							✓	✓														✓
<b>Sharpness</b>																										
Port of Sharpness	✓			✓	✓	✓					✓	✓											✓	✓	✓	✓
<b>Silloth</b>																										
ABP - Port of Silloth				✓		✓	✓				✓	✓											✓		✓	✓
<b>South Shields</b>																										
Port of Tyne	✓	✓	✓	✓	✓	✓	✓	✓	✓	✓	✓	✓	✓	✓	✓	✓	✓					✓	✓	✓	✓	✓
<b>Southampton</b>																										
ABP - Southampton				✓		✓					✓															
<b>Southampton</b>																										
Solent Stevedores Ltd				✓	✓			✓			✓	✓	✓	✓	✓						✓	✓	✓		✓	✓
<b>Southampton</b>																										
Southampton Grain Terminal Ltd				✓																						
<b>Sunderland</b>																										
Port of Sunderland	✓	✓	✓				✓				✓	✓	✓										✓	✓	✓	
<b>Swansea</b>																										
ABP - Port of Swansea	✓					✓						✓														
<b>Teignmouth</b>																										
ABP - Teignmouth				✓																						
<b>Tilbury</b>																										
European Metal Recycling Ltd		✓						✓				✓														✓
<b>Tilbury</b>																										
Port of Tilbury London Limited				✓							✓												✓	✓	✓	
<b>Tilbury</b>																										
Port of Tilbury London Ltd - Grain Terminal				✓	✓						✓			✓												
<b>Tilbury</b>																										
Stema Shipping UK												✓														

# COMMODITIES HANDLED

COMMODITIES	CL	CC	PC	G-A	AF	CM	CLK	IO	BX	AL	FR	G-FGD	AG	SU	SOY	SODA	MIN	CHEM	BIO	R/M	BC	FRS	STL	P&P	MB	OTH	
<b>Warrenpoint</b>																											
Warrenpoint Harbour Authority				✓																			✓	✓			
<b>Whitstable</b>																											
Whitstable Harbour													✓														
<b>Wolverhampton</b>																											
Tarmac Limited													✓														
<b>Workington</b>																											
Port of Workington				✓	✓	✓					✓	✓	✓			✓		✓	✓	✓	✓	✓	✓	✓	✓	✓	✓
<b>UKRAINE</b>																											
<b>Berdiansk</b>																											
Berdiansk Port Authority				✓				✓			✓																
<b>Ilichevsk</b>																											
Port of Ilichevsk Authority								✓																			
<b>Izmail</b>																											
Commercial Sea Port of Izmail	✓			✓																							
<b>Kerch</b>																											
The Kerch Merchant Port																										✓	✓
<b>Kyiv</b>																											
PORTINVEST LLC																											
<b>Mariupol</b>																											
State Enterprise "Mariupol Sea Commercial Port"	✓	✓		✓				✓	✓									✓			✓		✓			✓	
<b>Nikoleav</b>																											
Nikolayev Port Authority				✓				✓																			
<b>Odessa</b>																											
Port of Odessa Authority				✓		✓								✓													
<b>Odessa</b>																											
PortInvest																											
<b>Odessa</b>																											
Transinvestservice (TIS) Ltd	✓	✓		✓				✓			✓							✓									
<b>Odessa</b>																											
Transship LTD	✓			✓				✓			✓																
<b>Port of Kilia</b>																											
Kiliya Transshipment Point				✓																							
<b>Reni</b>																											
Port of Reni	✓	✓	✓	✓	✓	✓	✓	✓	✓	✓	✓	✓	✓	✓	✓	✓	✓	✓	✓			✓	✓	✓	✓	✓	✓
<b>Vikovo</b>																											
Port of Ust-Dunaysk				✓																							
<b>Yalta</b>																											
Yalta Sea Trade Port Authority																											✓
<b>Yuzhny</b>																											
JV Transinvestservice TIS				✓							✓																
<b>Yuzhny</b>																											
Port Yuzhny	✓			✓			✓	✓	✓		✓													✓			
<b>URUGUAY</b>																											
<b>Montevideo</b>																											
Corporación Navios S.A.				✓																							
<b>Montevideo</b>																											
Paysandu Coordinadora de Puertos Uruguay				✓																							
<b>Montevideo</b>																											
T.G.U.S.A Uruguayan Grain Terminals				✓																							
<b>Nueva Palmira</b>																											
Terminal Nueva Palmira				✓																							
<b>Rio Negro</b>																											
Terminal Fray Bentos				✓																							
<b>USA</b>																											
<b>Aberdeen</b>																											
Pasha Stevedoring & Terminals LP				✓	✓											✓							✓		✓		
<b>Aberdeen</b>																											
Port of Grays Harbor				✓	✓				✓			✓											✓	✓	✓		✓
<b>Albany</b>																											
Albany Port District Commission				✓	✓						✓			✓									✓	✓	✓		
<b>Albany</b>																											
Port of Albany				✓																			✓	✓			
<b>Alexandria</b>																											
American Association of Port Authorities (AAPA)																											
<b>Ama</b>																											
ADM Gromark-Destrehan				✓																							
<b>Anacortes</b>																											
Metro Ports			✓									✓						✓									



COMMODITIES	CL	CC	PC	G-A	AF	CM	CLK	IO	BX	AL	FR	G-FGD	AG	SU	SOY	SODA	MIN	CHEM	BIO	R/M	BC	FRS	STL	P&P	MB	OTH
<b>Anacortes</b>																										
Metro Ports			✓																							✓
<b>Anacortes</b>																										
Port of Anacortes			✓															✓					✓	✓		✓
<b>Anchorage</b>																										
North Star Terminal Stevedore Company																							✓			✓
<b>Anchorage</b>																										
Port of Anchorage								✓																		
<b>Arabi</b>																										
Associated Terminals of St Bernard	✓	✓	✓	✓	✓			✓	✓	✓	✓	✓	✓	✓	✓	✓	✓	✓					✓	✓	✓	✓
<b>Argo</b>																										
Kinder Morgan Terminals	✓																									
<b>Baltimore</b>																										
Baltimore Terminal	✓																									
<b>Baltimore</b>																										
CSX - Curtis Bay Coal Piers	✓							✓																		
<b>Baltimore</b>																										
Maryland Port Administration																										
<b>Baltimore</b>																										
Port of Baltimore	✓			✓				✓	✓		✓	✓											✓			
<b>Baltimore</b>																										
Rukert Terminals Corp				✓					✓		✓	✓	✓										✓		✓	✓
<b>Bayonne</b>																										
Duraport Marine & Rail Terminal, LLC													✓													
<b>Beaumont</b>																										
Beaumont Bulk Terminal Inc				✓				✓															✓	✓		
<b>Beaumont</b>																										
Port of Beaumont				✓																			✓	✓		✓
<b>Belle Chasse</b>																										
Plaquemines Port	✓	✓		✓																						✓
<b>Bellingham</b>																										
Port of Bellingham					✓					✓	✓		✓										✓		✓	
<b>Benicia</b>																										
Port of Benicia Authority				✓																						✓
<b>Boston</b>																										
Massport Maritime Department								✓																		
<b>Bridgeport</b>																										
Bridgeport Port Authority													✓													✓
<b>Brownsville</b>																										
Port of Brownsville			✓	✓				✓	✓	✓			✓	✓						✓			✓	✓		✓
<b>Brunswick</b>																										
Marine Port Terminals Inc			✓	✓							✓															✓
<b>Buffalo</b>																										
Port of Buffalo	✓		✓					✓				✓	✓										✓	✓		✓
<b>Burlingame</b>																										
Ports America							✓	✓			✓	✓	✓										✓	✓	✓	✓
<b>Camden</b>																										
Delaware River Port Authority																										
<b>Camden</b>																										
South Jersey Ports Corp				✓																			✓			
<b>Canonsburg</b>																										
CONSOL Energy Inc.	✓																							✓	✓	
<b>Cape Canaveral</b>																										
Port Canaveral					✓	✓					✓	✓	✓					✓				✓	✓	✓	✓	✓
<b>Carteret</b>																										
Kinder Morgan Liquid Terminals, LLC																										
<b>Caruthersville</b>																										
Pemiscot County Port Authority				✓							✓															✓
<b>Catoosa</b>																										
Gavilon Fertilizer, LLC				✓							✓	✓														✓
<b>Catoosa</b>																										
Tulsa Port of Catoosa				✓							✓	✓										✓		✓		✓
<b>Ceredo</b>																										
Kanawha River Terminal Inc	✓																									
<b>Charleston</b>																										
Kinder Morgan Terminals	✓	✓	✓	✓	✓	✓	✓	✓	✓	✓	✓	✓	✓	✓	✓	✓	✓	✓	✓	✓	✓	✓	✓	✓	✓	✓
<b>Charleston</b>																										
Port of Charleston	✓			✓							✓															
<b>Charleston</b>																										
Stevens Shipping & Terminal Co																										
<b>Charlotte</b>																										
CSX World Terminals																										

# COMMODITIES HANDLED

COMMODITIES	CL	CC	PC	G-A	AF	CM	CLK	IO	BX	AL	FR	G-FGD	AG	SU	SOY	SODA	MIN	CHEM	BIO	R/M	BC	FRS	STL	P&P	MB	OTH
<b>Chesapeake</b>																										
Kinder Morgan Elizabeth River Terminals				✓					✓		✓															
<b>Chicago</b>																										
Illinois International Port District	✓	✓	✓	✓	✓	✓	✓	✓	✓	✓	✓	✓	✓	✓	✓	✓	✓	✓	✓		✓	✓	✓	✓	✓	✓
<b>Chicago</b>																										
KCBX Terminals Company	✓	✓	✓					✓																		
<b>Chicago</b>																										
North American Stevedoring Company LLC																						✓	✓			✓
<b>Cleveland</b>																										
Port of Cleveland						✓		✓															✓			✓
<b>Conneaut</b>																										
Pittsburgh & Conneaut Dock Co.	✓	✓	✓					✓			✓	✓	✓					✓							✓	✓
<b>Convent</b>																										
Associated Terminals LLC	✓	✓	✓	✓	✓	✓	✓	✓	✓	✓	✓	✓	✓	✓	✓	✓	✓	✓	✓			✓	✓	✓	✓	✓
<b>Convent</b>																										
IC RailMarine Terminal (ICRMT)	✓	✓	✓					✓			✓		✓					✓					✓			✓
<b>Convent</b>																										
St. James Stevedoring Partners, LLC	✓	✓	✓	✓	✓	✓	✓	✓	✓	✓	✓	✓	✓	✓	✓	✓	✓	✓	✓		✓	✓	✓	✓	✓	✓
<b>Coos Bay</b>																										
Oregon International Port of Coos Bay																							✓			
<b>Cora</b>																										
Kinder Morgan Terminals - Cora						✓																				
<b>Cordova</b>																										
Port of Cordova																										
<b>Corpus Christi</b>																										
Boyd-Campbell Company	✓	✓	✓	✓	✓	✓	✓	✓					✓									✓		✓		✓
<b>Corpus Christi</b>																										
Port Corpus Christi	✓	✓	✓	✓		✓	✓	✓	✓	✓	✓	✓	✓		✓	✓	✓	✓			✓		✓		✓	✓
<b>Corpus Christi</b>																										
Port of Corpus Christi - Bulk Terminal	✓	✓	✓	✓	✓			✓	✓			✓										✓	✓			✓
<b>Corpus Christi</b>																										
Public Elevator				✓																						
<b>Corpus Christi</b>																										
Sherwin Alumina, L.P.									✓	✓																
<b>Darrow</b>																										
Impala Terminals	✓								✓	✓																
<b>Decatur</b>																										
ARTCO	✓		✓	✓					✓	✓	✓															
<b>Decatur</b>																										
Kinder Morgan Terminals - Decatur	✓			✓	✓	✓	✓	✓	✓		✓	✓	✓									✓	✓	✓	✓	✓
<b>Detroit</b>																										
Detroit / Wayne County Port Authority				✓																			✓			✓
<b>Detroit</b>																										
Port of Detroit																							✓			
<b>Duluth</b>																										
AGP Grain Limited				✓																						
<b>Duluth</b>																										
Duluth Seaway Port Authority	✓	✓		✓	✓	✓	✓	✓			✓		✓					✓				✓	✓	✓	✓	✓
<b>Duluth</b>																										
General Mills Elevator A				✓																						
<b>Duluth</b>																										
Krech Ojard & Assoc	✓					✓	✓	✓					✓					✓						✓		
<b>East Liverpool</b>																										
Columbiana County Port Authority												✓										✓	✓			✓
<b>Eastport</b>																										
Eastport Port Authority												✓											✓			
<b>Erie</b>																										
Mount Fort Terminal												✓													✓	✓
<b>Eureka</b>																										
Humboldt Bay Harbour District																										
<b>Evansville</b>																										
Kinder Morgan Terminals - Evansville	✓																									
<b>Everett</b>																										
Port of Everett											✓												✓	✓		✓
<b>Fields Landing</b>																										
Port of Eureka				✓																			✓			
<b>Fort Lauderdale</b>																										
Port Everglades Department of Broward County	✓	✓				✓			✓																✓	✓
<b>Fresno</b>																										
Penny Newman Grain Co				✓																						
<b>Galveston</b>																										
Farmland Elevator G				✓																						

COMMODITIES	CL	CC	PC	G-A	AF	CM	CLK	IO	BX	AL	FR	G-FGD	AG	SU	SOY	SODA	MIN	CHEM	BIO	R/M	BC	FRS	STL	P&P	MB	OTH	
<b>Galveston</b>																											
Metro Ports				✓							✓				✓								✓			✓	
<b>Galveston</b>																											
Port of Galveston				✓										✓									✓	✓			
<b>Georgetown</b>																											
Liberty Terminals, LLC																											
<b>Georgetown</b>																											
Port of Georgetown						✓		✓					✓														
<b>Georgetown</b>																											
Stevedoring Services of America (SSA)	✓			✓							✓											✓		✓			
<b>Georgetown</b>																											
Winyah Stevedoring Inc																											
<b>Georgetown</b>																											
WSI of the Southeast Ilc	✓																										
<b>Glen Carbon</b>																											
Mobilec Grain																											
<b>Green Bay</b>																											
Port of Green Bay	✓				✓	✓																		✓	✓	✓	✓
<b>Gretna</b>																											
Associated Grain Terminals				✓	✓																						✓
<b>Gulfport</b>																											
Mississippi State Port Authority at Gulfport																											
<b>Hilo</b>																											
Hilo Harbour	✓																										
<b>Hilo</b>																											
State of Hawaii, Depart't of Transportation							✓															✓	✓				
<b>Homer</b>																											
City of Homer Port and Harbor																						✓	✓	✓		✓	✓
<b>Honolulu</b>																											
Honolulu Port Authority				✓																							
<b>Houston</b>																											
Cooper/T. Smith Stevedoring																											
<b>Houston</b>																											
Kinder Morgan Terminals	✓			✓	✓	✓	✓	✓	✓		✓	✓	✓										✓	✓	✓	✓	
<b>Houston</b>																											
Port of Houston Authority				✓	✓				✓															✓			
<b>Houston</b>																											
Public Elevator 2				✓																							
<b>Houston</b>																											
Texas Terminals, LP						✓	✓	✓	✓	✓	✓	✓	✓				✓	✓		✓	✓	✓	✓	✓	✓	✓	✓
<b>Houston</b>																											
Tx Tx Corporation	✓																										
<b>Houston</b>																											
United Bulk Terminals USA, Inc.	✓	✓	✓																								
<b>Humble</b>																											
P&S Ports Texas, Inc.				✓																			✓	✓	✓		
<b>Indiana</b>																											
Port of Indiana																											
<b>Indianapolis</b>																											
Burns International Harbour-Port of Indiana	✓	✓		✓							✓													✓			
<b>Jacksonville</b>																											
CSX	✓							✓																			
<b>Jacksonville</b>																											
Jacksonville Electric Authority																											
<b>Jacksonville</b>																											
Jacksonville Port Authority																							✓		✓		
<b>Juneau</b>																											
Port of Juneau																											
<b>Kalama</b>																											
Harvest States Elevator				✓																							
<b>Kalama</b>																											
Peavey Elevator				✓																							
<b>Kenai</b>																											
Port of Kenai																											
<b>Kenova</b>																											
Big Sandy Terminal Inc	✓																										
<b>Kirkland</b>																											
Macquarie Ports Inc																											
<b>Kirtland</b>																											
Pickands Mather Group																											
<b>Kodiak</b>																											
City of Kodiak Harbour Department																											



# COMMODITIES HANDLED

COMMODITIES	CL	CC	PC	G-A	AF	CM	CLK	IO	BX	AL	FR	G-FGD	AG	SU	SOY	SODA	MIN	CHEM	BIO	R/M	BC	FRS	STL	P&P	MB	OTH
<b>La Place</b>																										
Port of South Louisiana	✓	✓	✓	✓	✓	✓	✓	✓	✓	✓	✓		✓	✓	✓	✓	✓	✓				✓		✓		
<b>Lake Charles</b>																										
Lake Charles Harbor & Terminal District			✓	✓					✓														✓			
<b>Lake Charles</b>																										
Port of Lake Charles				✓																						
<b>Lamberts Point</b>																										
Norfolk Southern - Lamberts Point	✓																									
<b>Long Beach</b>																										
Cooper/T. Smith Stevedoring	✓																									
<b>Long Beach</b>																										
MCC-Lucky Cement Terminal						✓																				
<b>Long Beach</b>																										
Metro Ports	✓		✓					✓			✓					✓				✓			✓	✓	✓	
<b>Long Beach</b>																										
Metro Ports	✓		✓														✓	✓								
<b>Long Beach</b>																										
Oxbow Energy Solutions	✓		✓																							
<b>Long Beach</b>																										
Port of Long Beach	✓		✓	✓		✓						✓											✓			
<b>Longview</b>																										
Port of Longview			✓	✓	✓			✓			✓					✓	✓	✓				✓	✓	✓	✓	
<b>Louisville</b>																										
Kinder Morgan Terminals - Louisville	✓																									
<b>Louisville</b>																										
Schaefer-Cooper Warehousing	✓																									
<b>Mandeville</b>																										
Consolidated Terminals & Logistics Co	✓	✓	✓	✓	✓	✓	✓	✓	✓	✓	✓	✓	✓	✓				✓					✓	✓	✓	✓
<b>Mandeville</b>																										
Cooper/Consolidated	✓	✓	✓	✓	✓	✓	✓	✓	✓	✓	✓	✓	✓	✓	✓	✓	✓	✓				✓	✓	✓	✓	✓
<b>Maumee</b>																										
Kuhlman Corporation				✓	✓						✓			✓												
<b>Maumee</b>																										
The Andersons - Maumee Grain Marine				✓	✓						✓					✓										
<b>Maumee</b>																										
The Andersons, Inc				✓	✓											✓										
<b>Metropolis</b>																										
AEP/Cook Coal Terminal	✓																									
<b>Miami</b>																										
Panama Canal Authority (ACP)																										
<b>Miami</b>																										
Port of Miami																										
<b>Milwaukee</b>																										
Continental Grain Elevator				✓																						
<b>Milwaukee</b>																										
Milwaukee Bulk Terminals	✓										✓		✓													
<b>Milwaukee</b>																										
Port of Milwaukee	✓	✓		✓		✓	✓				✓		✓									✓		✓	✓	✓
<b>Mobile</b>																										
Alabama State Port Authority	✓							✓															✓	✓		
<b>Mobile</b>																										
Cooper/T. Smith Stevedoring	✓	✓	✓			✓	✓	✓	✓			✓	✓					✓		✓		✓				
<b>Mobile</b>																										
FGDI LLC - ASPA Pier D Grain Elevator				✓																						
<b>Mobile</b>																										
McDuffie Coal Terminal	✓																									
<b>Mobile</b>																										
Port of Mobile	✓			✓		✓		✓	✓			✓	✓										✓	✓	✓	✓
<b>Mobile</b>																										
Stevedoring Services Services of America																										
<b>Monaca</b>																										
Colona Terminal Services	✓	✓										✓	✓					✓								
<b>Monroe</b>																										
Tower Monroe Port Commision																										
<b>Morehead City</b>																										
North Carolina State Ports Authority/				✓	✓	✓					✓		✓										✓	✓	✓	✓
Morehead City																										
<b>Mount Pleasant</b>																										
Strachan Shipping Co	✓																									✓
<b>Mount Vernon</b>																										
Ports Of Indiana				✓							✓															
<b>Myrtle Grove</b>																										
International Marine Terminals	✓		✓			✓	✓	✓			✓		✓													✓

COMMODITIES	CL	CC	PC	G-A	AF	CM	CLK	IO	BX	AL	FR	G-FGD	AG	SU	SOY	SODA	MIN	CHEM	BIO	R/M	BC	FRS	STL	P&P	MB	OTH
<b>New Haven</b>																										
New Haven	✓											✓														✓
<b>New Haven</b>																										
New Haven Terminal																										✓
<b>New Orleans</b>																										
Port of New Orleans											✓													✓		
<b>Newark</b>																										
Metal Management NE	✓							✓	✓			✓												✓		
<b>Newport News</b>																										
Dominion Terminal Associates LLP	✓	✓	✓																							
<b>Newport News</b>																										
Kinder Morgan -Pier IX Terminal	✓						✓																			
<b>Norfolk</b>																										
Host Terminals	✓	✓	✓	✓	✓				✓	✓	✓	✓	✓	✓	✓	✓		✓			✓	✓	✓	✓	✓	✓
<b>Norfolk</b>																										
Virginia International Terminals Inc				✓																						
<b>Norfolk</b>																										
Virginia Maritime Association	✓																									
<b>Norfolk</b>																										
Virginia Port Authority																										
<b>North Charleston</b>																										
Cooper/T. Smith Stevedoring																										
<b>Oakland</b>																										
Port of Oakland																								✓		
<b>Oakville</b>																										
The Andersons				✓																						
<b>Ogdensburg</b>																										
Ogdensburg Bridge & Port Authority																										
<b>Olympia</b>																										
Port of Olympia																						✓	✓	✓	✓	✓
<b>Omaha</b>																										
Hansen-Mueller Company				✓																						
<b>Oswego</b>																										
Port of Oswego Authority				✓		✓					✓															
<b>Owensboro</b>																										
Kinder Morgan Terminals - Owensboro	✓																									
<b>Paducah</b>																										
FEBCO®				✓		✓			✓		✓															
<b>Pago Pago</b>																										
Port of Pago Pago																										
<b>Palmer</b>																										
Port MacKenzie, Matanuska-Susitna Borough	✓					✓							✓									✓	✓			✓
<b>Palmetto</b>																										
Port Manatee Forestry Terminal Inc																							✓			
<b>Pascagoula</b>																										
Port of Pascagoula				✓						✓	✓		✓										✓	✓	✓	✓
<b>Pensacola</b>																										
Port of Pensacola				✓							✓		✓													✓
<b>Philadelphia</b>																										
Agway				✓																						
<b>Philadelphia</b>																										
Port of Philadelphia & Camden																							✓	✓	✓	
<b>Piti</b>																										
Port Authority of Guam						✓							✓													✓
<b>Point Comfort</b>																										
Port of Point Comfort/Port Lavaca									✓																	
<b>Port Allen</b>																										
Associated Terminals of Baton Rouge/	✓	✓			✓			✓	✓		✓	✓	✓				✓	✓	✓			✓	✓	✓		✓
Port Allen																										
<b>Port Allen</b>																										
Port of Greater Baton Rouge	✓		✓	✓		✓	✓		✓														✓			✓
<b>Port Angeles</b>																										
Port of Port Angeles																							✓		✓	
<b>Port Arthur</b>																										
Pabtex	✓		✓																							
<b>Port Arthur</b>																										
Port of Port Arthur			✓										✓									✓	✓	✓	✓	✓
<b>Port Hueneme</b>																										
Port Hueneme Port Authority				✓																						✓
<b>Port Newark</b>																										
Port Authority of NY & N Jersey	✓			✓																						
<b>Port Royal</b>																										
Port of Port Royal																										✓

# COMMODITIES HANDLED

COMMODITIES	CL	CC	PC	G-A	AF	CM	CLK	IO	BX	AL	FR	G-FGD	AG	SU	SOY	SODA	MIN	CHEM	BIO	R/M	BC	FRS	STL	P&P	MB	OTH
<b>Port Smith</b>																										
Granite State Minerals	✓			✓		✓	✓	✓			✓		✓													✓
<b>Portland</b>																										
Columbia Grain Elevator				✓																						
<b>Portland</b>																										
International Terminals								✓																		
<b>Portland</b>																										
Port of Portland				✓	✓			✓			✓					✓	✓				✓	✓	✓	✓	✓	✓
<b>Portsmouth</b>																										
Sprague Energy	✓	✓	✓			✓	✓	✓	✓			✓	✓								✓	✓	✓	✓	✓	✓
<b>Providence</b>																										
Waterson Terminal Services	✓	✓	✓			✓		✓	✓	✓			✓								✓	✓	✓			✓
<b>Pueblo</b>																										
Association of American Railroads																										
<b>Redwood City</b>																										
Port of Redwood City						✓			✓			✓	✓										✓			✓
<b>Reserve</b>																										
Associated Terminals at Globalplex	✓	✓	✓		✓			✓	✓	✓	✓	✓	✓			✓	✓	✓			✓	✓	✓	✓	✓	✓
<b>Richmond</b>																										
Levin Richmond Terminal Corp'n (LRTC)	✓	✓	✓					✓									✓								✓	✓
<b>Richmond</b>																										
Port of Richmond																										
<b>Roanoke</b>																										
Ashtabula Coal Pier	✓																									
<b>Saint Paul</b>																										
Port of St Paul																										
<b>Salt Lake City</b>																										
Savage Companies	✓																									
<b>San Diego</b>																										
Port of San Diego																								✓		
<b>San Francisco</b>																										
Port of San Francisco											✓		✓								✓	✓	✓	✓	✓	✓
<b>San Pedro</b>																										
Los Angeles Export Terminal		✓																								
<b>San Pedro</b>																										
Los Angeles Harbour Department																										✓
<b>San Pedro</b>																										
Marine Terminals Corporation						✓																	✓	✓	✓	
<b>San Pedro</b>																										
Port of Los Angeles																										
<b>San Pedro</b>																										
World Port LA (Port of Los Angeles)	✓																									
<b>Sandusky</b>																										
CT Stevedoring	✓																									
<b>Sandusky</b>																										
Sandusky Dock Corporation, Pier #3	✓		✓																							
<b>Savannah</b>																										
Georgia Ports Authority USA				✓	✓			✓			✓	✓	✓		✓						✓	✓	✓	✓	✓	✓
<b>Savannah</b>																										
Metro Ports				✓	✓				✓		✓	✓	✓		✓	✓	✓			✓	✓	✓	✓	✓	✓	✓
<b>Seattle</b>																										
Port of Seattle				✓		✓			✓			✓	✓										✓	✓	✓	
<b>Seattle</b>																										
Stevedoring Services of America	✓																						✓	✓		
<b>Seward</b>																										
Aurora Energy Services, LLC	✓																									
<b>Seward</b>																										
Port of Seward																										
<b>Skagway</b>																										
Port of Skagway																										
<b>St Louis</b>																										
Bunge St Louis				✓																						
<b>St Louis</b>																										
Cahokia Marine Services	✓																									
<b>Stamford</b>																										
Oxbow Carbon Minerals		✓	✓																							
<b>Stockton</b>																										
Metropolitan Stevedore Company	✓	✓	✓					✓					✓													✓
<b>Stockton</b>																										
Port of Stockton	✓	✓	✓	✓	✓	✓	✓	✓			✓	✓	✓	✓	✓	✓	✓	✓	✓		✓	✓	✓	✓	✓	✓
<b>Stockton</b>																										
Sunshine Cement, Inc						✓																				



COMMODITIES	CL	CC	PC	G-A	AF	CM	CLK	IO	BX	AL	FR	G-FGD	AG	SU	SOY	SODA	MIN	CHEM	BIO	R/M	BC	FRS	STL	P&P	MB	OTH	
<b>Superior</b>																											
Cenex Harvest States				✓																							
<b>Superior</b>																											
Peavey Company - Connor's Point Elevator				✓																							
<b>Superior</b>																											
Superior Midwest Energy Terminal	✓																										
<b>Tacoma</b>																											
Port of Tacoma				✓								✓											✓				
<b>Tacoma</b>																											
Stevedoring Services of America				✓																							
<b>Tallahassee</b>																											
Florida Ports Council																											
<b>Tampa</b>																											
Kinder Morgan Terminals - Tampaplex Term1	✓																										
<b>Tampa</b>																											
Tampa Bay Stevedores Ltd												✓															
<b>Tampa</b>																											
Tampa Port Authority	✓			✓	✓	✓					✓	✓	✓										✓	✓	✓	✓	✓
<b>Tampa</b>																											
United Maritime Group	✓							✓			✓																
<b>Texas City</b>																											
Port of Texas City				✓	✓						✓																
<b>Theodore</b>																											
Millard Maritime								✓					✓										✓				
<b>Toledo</b>																											
ADM Grain Company Ltd				✓	✓											✓											
<b>Toledo</b>																											
CSX Coal Dock	✓																										
<b>Toledo</b>																											
Midwest Terminals of Toledo Int'l, Inc	✓			✓	✓	✓		✓	✓	✓	✓		✓	✓									✓				
<b>Toledo</b>																											
Toledo-Lucas County Port Authority	✓	✓	✓	✓	✓	✓	✓	✓	✓	✓	✓	✓	✓	✓	✓	✓	✓	✓	✓		✓	✓	✓	✓	✓	✓	✓
<b>Valdez</b>																											
Port of Valdez						✓																	✓				
<b>Vancouver</b>																											
Port of Vancouver, USA				✓		✓			✓		✓						✓						✓	✓	✓	✓	✓
<b>Vancouver</b>																											
United Grain Corp				✓																							
<b>Vancouver</b>																											
Vancouver-United Grain Elevator				✓																							
<b>Wheelerburg</b>																											
Norfolk Southern - Wheelerburg Terminal	✓																										
<b>Whittier</b>																											
Whittier Port Authority Commission																											
<b>Wilmington</b>																											
Metro Ports											✓						✓					✓	✓	✓	✓		✓
<b>Wilmington</b>																											
Metropolitan Stevedore Company	✓	✓	✓					✓					✓			✓	✓										
<b>Wilmington</b>																											
N. Carolina State Ports Authy/Wilmington	✓			✓	✓	✓	✓				✓	✓	✓			✓		✓				✓	✓	✓	✓		✓
<b>Wilmington</b>																											
Pasha Stevedoring & Terminals				✓																			✓	✓	✓		✓
<b>Wilmington</b>																											
Port of Wilmington, Delaware/Diamond State				✓		✓		✓	✓		✓											✓	✓	✓	✓		✓
<b>VENEZUELA</b>																											
<b>Estado</b>																											
Ventterminales											✓																
<b>Guidad Guayana</b>																											
Interalumina																											
<b>Maracaibo</b>																											
BDV - Bulkguasare de Venezuela, SA	✓																										
<b>Maracaibo</b>																											
Carbones del Guasare SA	✓																										
<b>Maracaibo</b>																											
Port Authority of Maracaibo				✓																							
<b>Santa Cruz de Mara</b>																											
Santa Cruz Coal Terminal	✓																										
<b>VIETNAM</b>																											
<b>Ho Chi Min City</b>																											
Ho Chi Minh Port Authority				✓		✓					✓																✓
<b>Ngo Guyen District</b>																											
Haiphong Port Authority	✓			✓	✓	✓	✓	✓	✓	✓	✓		✓	✓	✓	✓	✓					✓	✓	✓	✓	✓	✓

Company	Page	Company	Page
Achenbach GmbH Metalltechnik	2	Maritime Bulk Terminal Gdynia Ltd	157
Agrico Sales, Inc.	4	Martin Engineering	56
Alex Stewart International Corporation Ltd	6	Maschinen und Mühlenbau Erhard Muhr GmbH	57
Associated Terminals	175, Inside Back Cover	MRS Greifer GmbH	58
Bedeschi SpA	8	Nectar Group Ltd	61
Beumer Group GmbH & Co KG	11	Negrini Srl	60
BLUG Credeblug S.L.	10	Nemag BV	62
BossTek	13	Neuro Industrietechnik GmbH	63
Buhler AG, Grain Logistics	14	ORTS GmbH Maschinenfabrik	64
Buttimer Engineering	16	PINTSCH BUBENZER GmbH	67
Cimbria Unigrain A/S	18	Port of Dunkerque	140
Civettini Italo & c sas (CFS Handling)	20	Port of Kokkola Ltd.	138
Cleveland Cascades Ltd	22	RBL-REI France	70
Coaltrans Conferences Ltd	90	REEL Alesa Ltd	72
Conductix-Wampfler	24	RULMECA HOLDING S.P.A.	74
Damen Shipyards Gorinchem	166	SAMSON Materials Handling Ltd (AUMUND Group)	77
DCL, Incorporated	26	SCHADE Lagertechnik (AUMUND Group)	79
Den Bakker Dustcrusting Techn'gy b.v. (dbd global b.v.)	28	SENNEBOGEN Maschinenfabrik GmbH	Front Cover
Dos Santos International, LLC	29	SIG Società Italiana Gomma Spa	81
DSH Systems Ltd.	30	Siwertell AB	82
E-Crane World Wide / E-Crane International USA	33	Standard Industrie	85
ELME Spreader AB	32	Starlinger & Co. Gesellschaft m.b.H.	114
EMS-Tech Inc	34	Stema SA	154
FLSmidth Inc.	36	Stemm Equipos Industriales, S.L.	84
Gambarotta Gschwendt	38, 39	TAIM WESER, S.A.	86
Geometrica Inc	40	Terex Deutschland GmbH	88
Golfetto Sangati s.r.l.	Inside Front Cover, 42	Teufelberger Seil Ges.m.b.H	91
Hapman	44	thyssenkrupp Industrial Solutions AG	92
IBAU HAMBURG	47	TMPB - Poço Bispo Multipurpose Terminal	158
Igus GmbH	48	Van Aalst Bulk Handling BV	94
Konecranes Port Solutions	52	Verstegen Grippers BV	97
Liebherr-MCCtec Rostock GmbH	Back Cover	VIGAN	98
Listenow GmbH & Co.	55	WeatherSolve Structures	101
Mack Manufacturing Inc	54	Wuvio Chemicals International	102

# EXCELLENCE

is **ASSOCIATED** with **US.**



When it comes to the movement of bulk, breakbulk and project cargo along the Lower Mississippi River, turn to Associated Terminals. We have assembled a team of experts and invested in modern facilities, equipment and related assets to best service your cargo shipping needs. Add to that our total commitment to safety and it is easy to see that Associated Terminals is an excellent choice for all of your cargo handling and logistical solutions.

[www.associatedterminals.com](http://www.associatedterminals.com)





Experience the progress.



## **Mobile Harbour Crane**

- Manoeuvrability and versatility – for all areas of application in the harbour
- 360° mobility – absolute outstanding in the MHC market
- Stepless hydrostatic power transmission for smooth and sensitive operation
- Extensive range with load capacities of 42 tonnes to 308 tonnes
- Proven Liebherr quality and full support for our products and services