



# DRY CARGO

*handling directory*



2 0 1 4

*The industry's only complete fully comprehensive listing for:*

■ Bulk Ports, Terminals

■ Equipment Manufacturers

■ Engineering Consultants

■ Inspection Companies

■ FIBC & Big Bag Manufacturers

■ Inland Transportation Operators

# VERSTEGEN



**GRAB**  
**MORE**  
**GRAB**



Verstegen Grippers B.V. • P.O. Box 1014 • 3430 BA Nieuwegein • The Netherlands  
tel: +31-30-6062222 • fax: +31-30-6060657  
email: [info@verstegen.net](mailto:info@verstegen.net) • website: [www.verstegen.net](http://www.verstegen.net)



PLM Cranes B.V. specializes in custom-built bulk handling, dredging and hoisting cranes as well as bucket wheel unloaders, hoppers, conveyors and (modular) barges.

Main: PLM BWU 2500, electric-hydraulic 2,500m<sup>3</sup>/hour bucketwheel unloader

Bottom left: PLM 820, electric 8-tonne bulk handling crane

Bottom right: PLM 3522, diesel-hydraulic 35-tonne bulk handling crane.

PLM Cranes B.V.

Sluisweg 21-25

4794 SW Heijningen

The Netherlands

T: +31 167 52 8510

E: [info@plmcranes.com](mailto:info@plmcranes.com)

W: [www.plmcranes.com](http://www.plmcranes.com)

#### PUBLISHERS

**Jason Chinnock**

[jason@dc-int.com](mailto:jason@dc-int.com)

**Andrew Hucker-Brown**

[andrew@dc-int.com](mailto:andrew@dc-int.com)

#### EDITORIAL

**Louise Dodds-Ely** Editor

[louise@dc-int.com](mailto:louise@dc-int.com)

**Jay Venter** Deputy Editor

[editorial@dc-int.com](mailto:editorial@dc-int.com)

**Samantha Smith** Directories

[directories@dc-int.com](mailto:directories@dc-int.com)

**Stephanie Hodgkins** Office Manager

[accounts@dc-int.com](mailto:accounts@dc-int.com)

#### SALES

**Lourens van Emmenis** Sales Director

[sales@dc-int.com](mailto:sales@dc-int.com)

**Matthew Currin** Senior Sales Executive

[sales2@dc-int.com](mailto:sales2@dc-int.com)

#### CORRESPONDENTS

Brazil **Patrick Knight**

Canada **Ray Dykes**

India **Kunal Bose**

Asia **David Hayes**

Europe **Barry Cross**

Malaysia **Wira Sulaiman**

Philippines **Fred Pundol**

South Africa **Iain McIntosh**

Thailand **David Turner**

UK **Maria Cappuccio**

UK **Michael King**

UK **Richard Scott**

USA **Colby Haines**

USA **Walter Mitchell**

#### ADMINISTRATIVE OFFICE

Business Publishing International

Corporate House, 11 Sinembe Crescent

La Lucia Ridge, South Africa, 4051

Tel: +27 31 583 4360

Fax: +27 31 566 4502

Email: [info@dc-int.com](mailto:info@dc-int.com)

#### HEAD OFFICE

Trade Publishing International Limited

Clover House, 24 Drury Road,

Colchester, Essex CO2 7UX, UK

Tel: +44 (0)1206 562560

Fax: +44 (0)1206 562566

Email: [info@dc-int.com](mailto:info@dc-int.com)

Website: [www.dc-int.com](http://www.dc-int.com)

ISSN 1466-3643

Trade Publishing International Ltd does not guarantee the information contained in Dry Cargo International, nor does it accept responsibility for errors or omissions or their consequences. Opinions expressed herein are not necessarily those of Trade Publishing International Ltd

© Trade Publishing Int'l Ltd 2014



# DRY CARGO

## handling directory

# 2014



## Contents

### BULK HANDLING EQUIPMENT

COMPANY PROFILES	2
TABLE — COMMODITIES HANDLED	108

### INLAND TRANSPORT

BARGE HANDLING COMPANIES	124
RAIL HANDLING COMPANIES	126

### BAGGING

FIBC AND BAG MANUFACTURING COMPANIES	129
--------------------------------------	-----

### PORTS & TERMINALS

PORTS AND TERMINALS WORLDWIDE — BY COUNTRY	133
TABLE — COMMODITIES HANDLED	225

## 4B BRAIME Elevator

### Components

Hunslet Road  
Leeds  
West Yorkshire  
LS10 1JZ  
UK

Contact: Mrs Simone Block  
Job Title: Marketing Manager  
T: + 44 113 246 1800  
F: + 44 113 243 5021  
E: 4b-uk@go4b.com  
W: www.go4b.com

With over 125 years experience, 4B is the world's leading supplier of high quality Components for Bucket Elevators & Conveyors. 4B offers Mechanical Components (Elevator Buckets & Bolts, Belting & Fasteners, Forged Conveyor Chains...) as well as Electronic Components (Level Sensors, Belt Alignment Sensors, Bearing Temperature Sensors, Speed Sensors...).

## A. Friedr Flender AG

Alfred Flender Strasse 77  
Bocholt  
D-46395  
Germany

Contact: Mr Matthias Wenning  
Job Title: Marketing  
T: + 49 2871 922 780 / + 49 2871 920  
F: + 49 2871 921 602  
E: matthias.wenning@flender.com  
W: www.flender.com

Flender is a leading international manufacturer of mechanical and electrical components for power transmission equipment. Its diversified product range covers individual components and also complete drive systems for nearly all industrial applications. The

company's history dates back over 100 years and it is continuously striving to achieve the best solutions for the future.

## A/S Cimbría

Fårtoftvej 22  
Thisted  
7700

Denmark  
Contact: Mr Lars Noergaard  
Job Title: Sales Director  
T: + 45 7242 2420  
F: + 45 7242 2499

E: lno@cimbria.com  
W: www.cimbria.com  
Cimbria is one of the world's leading producers within processing, handling and storage of grain and seed and other bulk products. We offer projecting and process control - as well as the development, manufacture and installation of individual machines.

## AAF Ltd

Bassington Lane  
Cramington  
Northumberland  
NE23 8AF  
UK

Contact: Mr Jeremy Thompson  
Job Title: Air Pollution Control Equipment Manager  
T: + 44 1670 566177  
F: + 44 1670 566312  
E: apc@aaafb.com  
W: www.apcaafgab.com  
Designs and manufactures dust extraction systems - plus aftermarket sales and service for all makes of dust collectors.

## ABB Engineering (Shanghai)

### Ltd.

No.5 Lane 369  
Chuangye Road  
Pudong  
Shanghai  
201319

China  
Contact: Ms Cherie-Sile Hu  
Job Title: Marketing and Communication  
T: + 86 21 2328 8289  
F: + 86 21 2328 8290

E: cherie-sile.hu@cn.abb.com  
W: www.abb.com/cranes  
ABB offers reliable automation solutions and electrical equipment that enable terminals to move, e.g. bulk material fast and cost efficiently. Already hundreds of various types of cranes in bulk and container terminals as well as industrial plants are equipped with our solutions and deliver to the highest productivity requirements every day.

## ABB Switzerland Ltd



Local Business Unit Minerals  
Segelhofstrasse 9P  
Baden 5 Dättwil  
CH

5405  
Switzerland  
Contact: Mr Emmanuel Chabut  
T: + 41 58 586 7133  
F: + 41 58 586 7333  
E: emmanuel.chabut@ch.abb.com

# BULK HANDLING EQUIPMENT COMPANY PROFILES

W: www.abb.com/minerals  
ABB delivers integrated process control, optimization and information systems, drives and power distribution equipment as well as service and support for the complete primary production chain in the mining, mineral processing and cement industry. With its global network, ABB provides local support and engineering facilities that are never far from you.

## Abbey Rollers Limited

Togher Industrial Estate No. 2  
Pouladuff Road  
Cork

Ireland  
Contact: Mrs Martha Murphy  
Job Title: Sales and Marketing  
T: + 353 21 496 2745  
F: + 353 21 431 4898  
E: sales@abbeyrollers.ie  
W: www.abbeyrollers.ie

## AC Robinson & Associates

3rd Floor  
Lakeside Building  
Alexandra Park  
Prescot Road  
St Helens  
WA10 3TT  
UK

Contact: Mr Simon Robinson  
Job Title: Manager  
T: + 44 1744 621 669  
F: + 44 1744 454 040  
E: info@acr.org.uk  
W: www.acr.org.uk/

## Achenbach GmbH Metalltechnik



Lindestrass 10  
Wilnsdorf  
D-57234  
Germany

Contact: Mr Uwe Achenbach  
T: + 49 2737 98 63 0  
F: + 49 2737 98 63 10  
E: u.achenbach@achenbach-siegen.de

W: www.achenbach-siegen.de  
Conveyor covers - Achenbach manufactures hoods made of metal (steel, aluminium, stainless) for covering standard or special belts. Hoods made of hard-PVC and fixings round up the Achenbach range.

## Advance Automated Systems Ltd

12 Enterprise City  
Spennymoor  
Durham  
DL16 6JF  
UK

Contact: Ms Amy Redhead  
Job Title: Sales Admin.  
T: + 44 1388 811 122  
F: + 44 1388 811 133  
E: AmyRedhead@advanceautomation.co.uk  
W: www.advanceautomation.co.uk

## AE AntiEmission GmbH

Nordhang 74  
Gevelsberg  
58285

Germany  
Contact: Dipl.-Ing A Eskandani  
Job Title: President  
T: + 49 2332 66 49 92 0  
F: + 49 2332 66 49 92 5  
E: Info@AntiEmission.de  
W: www.AntiEmission.de

Serving coal and biomass power plants, the construction, demolition and recycling, raw & bulk material and mining industry. Our products and services: Spraying systems, fog cannons, fog cannon pole systems, dust binders, pile/slope/haul road stabilizers, ash treatment products, dust & ash mixers, air cannons, dust management & consultancy.

## AE Automation (M) Sdn bhd

10-12, Jalan Mas 6  
Taman Cheras Mas  
Cheras  
Selangor D.E.  
43200

Malaysia  
Contact: Mr Ken Lim  
Job Title: Managing Director  
T: + 60 7 455 6333  
F: + 60 7 455 6666  
E: ken@aeauto.com.my  
W: www.ae.com.my

Specialized in Bulk material handling system, turnkey solutions in coal mining, power plants, cement plants, fertilizer plants, port projects.

## Aeromaster International Ltd

Fairport House  
28 Charles Street  
Higher Hillgate  
Stockport  
SK1 3JR  
UK

Contact: Mr James Horner  
Job Title: Sales Manager  
T: + 44 161 4774775  
F: + 44 161 4740257  
E: info@aeromaster-int.com

W: www.fairport.co.uk/  
As part of the Fairport Group of Companies including Flomat Bagfilla (FIBC big bag discharging & filling specialists), Fairport NEU Solutions (pneumatic conveying experts) and Fairport Process Equipment, we can offer a variety of materials handling solutions.

## AFM Industries

828 Ritson Road  
Oshawa  
Ontario  
L1H 5L4  
Canada

Contact: Mr Rob Butterworth  
Job Title: President

Perfectly covered  
- with our hoods.

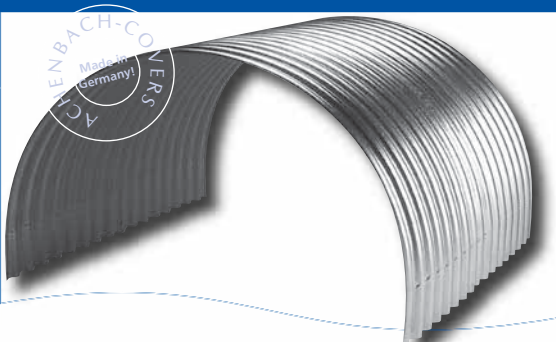

### Achenbach metal hoods for conveyor belts

- The modern classic – in worldwide use
- Steel, aluminium, stainless – the appropriate material at any time
- Four corrugation profiles – suitable and cost-effective

Sale of organit-hard-PVC covers made in EU



Achenbach GmbH Metalltechnik  
Lindestrass 10 · D-57234 Wilnsdorf · Phone + 49 (0) 2737/9863-0  
Fax: + 49 (0) 2737/9863-10 · www.achenbach-siegen.de



Doing it right. On time.



Our speciality is dry cargo. For absolute, hands-on control of every aspect of your ships agency requirements, from berthing, bunkering and vessel husbandry to landside cargo management, container leasing and stevedoring, choose Voigt Shipping's vast experience in dry bulk cargo.

**Trust us to efficiently handle your bulk logistics.**



Durban +27 31 207 1451 | Cape Town +27 21 911 0939 | Saldanha Bay +27 22 714 1908 | Richards Bay +27 35 788 0188 | Maputo + 258 21 22 6600

 **Sturrock Grindrod** | Voigt Shipping  
Maritime | A member of the Sturrock Grindrod Maritime Group

[info@voigtshipping.com](mailto:info@voigtshipping.com)  
[www.sturrockgrindrod.com](http://www.sturrockgrindrod.com)

# ARE YOU READY...

# For Post Panamax?

In 2014 the Panama Canal expansion completes, allowing LARGER vessels through the Canal. Terminals around the world are preparing now for these LARGER vessels.

**Maximum Panamax Ship Size:**

	<b>Current</b>	<b>New</b>
<b>Length</b>	296.5m	366m
<b>Beam</b>	32.3m	49m
<b>Draft</b>	12.6m	15.2m

**Agrico loaders can load any size ship at any loading rate!**



**Agrico shiploaders can take you into the future!**



**Agrico Sales, Inc.**  
**14900 Intracoastal Dr.**  
**New Orleans, Louisiana 70129**  
**Phone 504 436 9400**  
**Email: [briek@agricosales.com](mailto:briek@agricosales.com)**  
**Website: [www.agricosales.com](http://www.agricosales.com)**



T: + 1 905 443 0150  
 F: + 1 905 443 0155  
 E: rbutterworth@afmindustries.com  
 W: www.afmindustries.com  
 Supplier-fabricator of conveyor belting. Textile belting (polyester-nylon-aramid) - Enduraply Textile belting with steelcord breakers - Enduraply-Plus Steelcord belting - Endurasteel Steelcord belting with steelcord breakers - Endurasteel-Plus Corrugated sidewall belting (1.5-16 inches) - Endurawall Extreme high heat belting - Enduratherm Complete installation-field splicing-jointing services.

**AgGrowth International Inc.**  
 1301 Kenaston Blvd  
 Winnipeg  
 MB  
 R3P 2P2  
 Canada  
 Contact: Dr Joerg Zimmermann  
 T: +1 204 489 1855  
 F: + 1 204 488 6929  
 E: joerg.zimmermann@aggrowth.com  
 W: www.aggrowth.com

**Agora Services**  
 Telford Way  
 Kettering  
 Northants  
 NN16 8YZ  
 UK  
 Contact: Mr Shaun Haycock  
 T: + 44 1536 481629  
 F: + 44 1536 410193  
 E: sales@agoraservices.co.uk  
 W: www.agoraservices.co.uk  
 Engineers for powders and granules bulk material handling. Product range - hoppers, feeders, exciters and pneumatic, mechanical and screw conveying systems.

**Agrico Sales, Inc.**



14900 Intracoastal Drive  
 New Orleans  
 Louisiana  
 70129  
 USA  
 Contact: Mr Bob Rieck  
 Job Title: Vice President - Sales  
 T: + 1 504 436 9400  
 F: + 1 504 754 7732  
 E: brieck@agricosales.com  
 W: www.agricosales.com  
 Agrico Sales is an equipment manufacturer and construction company specializing in turnkey design/build projects for dry bulk commodities. Agrico builds: ship and barge loaders, conveyor systems, covered and open storage, rail and truck loading and unloading as well as jobs that include several of these components. Agrico is price competitive on a worldwide basis.

**Agromatic AG**  
 Goldingerstrasse 30  
 Laupen  
 CH-8637  
 Switzerland  
 Contact: Mr Tobias Diener  
 T: + 41 55 256 21 00  
 F: + 41 55 256 21 11  
 E: info@agromatic.com  
 W: www.agromatic.com  
 Specialises in bulk handling systems components, safety devices for mills, silos and storages and feed mill industries especially silo temperature monitoring equipment, level control, speed &



alignment monitoring, automatic sampling, flow control, dampening systems and laboratory devices, metal detectors and separators, magnets.

**AJ Sackett & Sons Company**  
 1701 South Highland Ave  
 Baltimore  
 Maryland  
 21224  
 USA  
 Contact: Mr Larry Taylor  
 T: + 1 410 276 4466  
 F: + 1 410 276 0241  
 E: larryt@ajsackett.com  
 W: www.ajsackett.com

Designers and manufacturers of dry bulk material handling systems, including conveying systems, blending, granulation, bagging and compaction systems.

**AKJ Industries**  
 PO Box 588  
 Pewee Valley  
 Kentucky  
 40056  
 USA  
 Contact: Mr Jack Cranfill  
 Job Title: Vice President  
 T: + 1 502 241 6932  
 F: + 1 502 241 6766  
 E: jackcranfill@yahoo.com

W: www.akjindustries.com  
 Provides dust control, belt de-icing and freeze conditioning chemicals equipment and service to the material handling industries.

**Alcan Alesa Technologies Ltd**  
 150 Rockland Rd  
 Town of Mount Royal  
 Quebec  
 H3P 2V9  
 Canada  
 Contact: Mr Rudy Keller  
 T: + 1 514 937 9105  
 F: + 1 514 937 0473  
 E: rudy.keller@riotinto.com  
 W: www.alcanalesa.com





Seamless integration from mine to market?

Naturally.

Material handling systems are an integral part of a complete material flow and quality management system. While in recent years the main focus was on optimization of single aspects like mine planning or advanced automation solutions, today a seamless integration of all subsystems is key to ensure overall optimization from mine to market. ABB's state-of-the-art stockyard management system integrates process control, Manufacturing Execution Systems (MES) and ERP systems to optimize the degree of material handling efficiency and to secure material supply in the requested quantity and quality. For more information, visit us at [www.abb.com/mining](http://www.abb.com/mining)



ALCAN ALESA is specialized in turnkey projects featuring systems emphasizing low energy consumption, operations efficiency, environmental protection and automation that ensure competitive advantages for the client. Innovative skills and experience in solving client's problems have characterised ALCAN ALESA projects worldwide for nearly 40 years.

### Alex Stewart Agriculture Ltd

21 Sefton Business Park  
Netherton  
Liverpool  
Merseyside  
L30 1RD  
UK  
Contact: Mr Glenn Forbes  
Job Title: Agriculture Manager  
T: + 44 151 525 1488  
F: + 44 151 530 1563  
E: Glenn.forbes@alexstewartagriculture.com  
W: www.alexstewartagriculture.com  
Offers a complete range of agricultural analytical, inspection and certification services for the facilitation of the international trading of soft commodities including raw & refined sugar, oils & fats, bio diesel, cereals, fertilisers

and other food products.

### Alex Stewart International

2b Sefton Business Park  
Netherton  
Liverpool  
Merseyside  
L30 1RD  
UK  
Contact: Mr Graham Stewart  
Job Title: Director  
T: + 44 151 525 1499  
E: graham.stewart@alexstewartinternational.com  
W: www.alexstewartinternational.com  
Alex Stewart International provides global inspection, sampling and laboratory analysis for all bulk commodities including metals, minerals and soft/agri commodities.

### Alfredo Brand P.

Casilla 16871  
Santiago  
Región Metropolitana  
7510147  
Chile  
Contact: Mr Alfredo Brand  
T: + 562238968  
F: + 5623440817  
E: abrandp.gm@gmail.com  
W: www.abrandp.com

### All-Fill International Ltd

5 Gateshead Close  
Sunderland Road  
Sandy  
Beds  
SG19 1RS  
UK  
Contact: Mr Mike Warmington  
Job Title: Sales Director  
T: + 44 1767 691100  
F: + 44 1767 681406  
E: info@allfill.co.uk  
W: www.allfill.co.uk  
Manufacturer of powder filling systems and ancillary equipment.

### Allison Engineering Ltd

Capricorn Centre  
Cranes Farm Road  
Basildon  
Essex  
SS14 3JA  
UK  
Contact: Mr Jeff Harwood  
T: + 44 1268 526161  
F: + 44 1268 533144  
E: jharwood@allison.co.uk  
W: www.allison.co.uk/

### ALS Inspection

Caddick Road  
Knowsley Business Park  
Prescott

Merseyside  
L34 9HP  
UK

Contact: Mr Christopher Walker  
Job Title: Commercial Manager  
T: + 44 151 548 7777  
F: + 44 151 548 0714  
E: info@alexstewart.com  
W: www.alexstewart.com  
Alex Stewart are suppliers of quality commodity inspection and laboratory analysis offering cargo supervision, quality and quantity inspection, weighing, sampling, assaying, testing, verification and certification services for the facilitation of international trade.

### AMECO SA

43, Rue du 21 Novembre  
Illfurth  
F-68720  
France  
Contact: Mr Stephane Killian  
Job Title: CEO  
T: + 33 389 255969  
F: + 33 389 255968  
E: info@ameco-fr.com  
W: www.ameco-fr.com  
Manufactures mechanical loaders/unloaders complete with belt stackers, scraper reclaimers, bucket wheel reclaimers, enclosed storage systems and other storage

systems, automation/computer/electrical and conveyors/components.

### Antar@Pressvess

Stallings House  
Stallings Lane  
Kingswinford  
West Midlands  
DY6 7LG  
UK  
Contact: Mr Roger Bannister  
Job Title: CEO  
T: + 44 1384 400 088  
F: + 44 1384 296 268  
E: roger.bannister@antar-equipment.com  
W: www.pressvess.co.uk

### ANUPAM INDUSTRIES LIMITED

138, G.I.D.C. Vitthal Udyognagar  
Via. Anand  
Gujarat  
388121  
India  
Contact: Mr Mehul Patel  
Job Title: Managing Director  
T: + 91 2692 235210  
F: + 91 2692 236324  
E: sales@anupamgroup.com  
W: http://www.anupamgroup.com/



# HAVE ENGINE - WILL TRAVEL

## Diesel-Hydraulic Grapple Model DHSG

Our new Hydraulic Grapple with its self-contained diesel engine gives you the freedom to use on any crane. It connects easily and is operated by radio remote control to offer you the ultimate in flexibility.

- Engine models up to 150HP
- Air or water cooled engines to match your environment
- Removable bottom hatch for easy engine access and maintenance
- High-strength, wear-resistant alloy steel tines
- 50 Gallon Fuel Tank will run over a continuous 12 Hour Shift
- Environmental food grade hydraulic fluid option



**Available Now for  
Rent or Purchase.**



Log on to [INFO.anvilattachments.com/diesel](http://INFO.anvilattachments.com/diesel) for videos and more information or contact us today at 225-654-8222.



## Anvil Attachments



PO Box 216  
261 Highway 19  
Slaughter  
Louisiana  
70777  
USA

Contact: Mr Shane Toncrey  
Job Title: Marketing Director  
T: + 1 225 654 8223  
F: + 1 225 654 3125  
E: Sales@AnvilAttachments.com  
W: www.AnvilAttachments.com  
Manufacturer of grabs, grapples and clamshell buckets for cable, hydraulic and electro-hydraulic operation. Models for ships-gear, gantry, excavators, crawler cranes and hydraulic equilibrium cranes. Brands include Anvil, Hawco, Pro-line, Owen, Yaun, Williams & Drott. New, used, rentals, rebuilds, repairs, parts and service, since 1969.

## Arlona Engineering

PO Box 41125  
Rossburgh  
Durban  
KZN  
4072  
South Africa

Contact: Mr Steve Christy  
Job Title: Managing Director  
T: + 27 31 205 95 90  
F: + 27 31 205 98 35  
E: steve@arlonaco.za  
W: www.arlonaco.za  
Manufactures a range of bulk handling equipment, including radio remote control grabs and mobile bulk hopper / conveyor systems for bulk carrier unloading.

## ASGCO

Gading Bukit Indah / F16  
Jl. Bukit Gading Raya  
Kelapa Gading  
Jakarta  
14240

Indonesia  
Contact: Mr Ray Nainggolan  
Job Title: Asia Ind. Representative  
T: + 61 417 299 902  
E: ray@asgco.asia  
W: http://www.asgco.com

## ASGCO Manufacturing

301 Gordon Street  
Allentown  
PA  
18102  
USA

Contact: Ms Peggy Anthony  
Job Title: Marketing Manager  
T: + 1 800 344 4000  
F: + 1 610 821 0216  
E: panthony@asgco.com  
W: http://www.asgco.com/

## ATIC Services

91bis, rue du Cherche Midi  
Paris  
75006  
France

Contact: Ms Marie-Pierre Lachaud  
T: + 33 1 536 338 63  
F: + 33 1 536 338 58  
E: info@atics.fr  
W: www.atiscs.fr

## ATIC Services - Asia Pacific

Suite 708/1 Newland Street  
Bondi Junction  
Sydney  
NSW  
2022  
Australia

Contact: Ms Julie Forster  
Job Title: Agency Manager  
T: + 61 289 646 250  
E: atiscs@atics.com.au  
W: www.atiscs.fr

## Atlas Manufacturing Co. Inc

PO Box 1969  
Monticello  
MS 39654  
USA

Contact: Mr Ashley Watson  
Job Title: Sales Manager  
T: + 1 601 587 4511

F: + 1 601 587 5393  
E: ashley@atlasmanufacturing.net  
W: www.atlasmanufacturing.net  
Atlas Manufacturing Company designs and builds high performance industrial clamshell buckets and grapples that meet and exceed strict industry demands. Atlas is comprised of the most experienced staff in the industry, and committed to producing the finest, most reliable products in the business.

## AUMUND Foerdertechnik GmbH



Saalhoffer Strasse 17  
Rheinberg  
D-47495  
Germany

Contact: Mr. Joerg Hoffmann  
Job Title: Managing Director  
T: + 49 2843 720  
F: + 49 2843 60270  
E: info@aumund.de  
W: www.aumund.com

AUMUND Foerdertechnik is active worldwide in the field of bulk materials handling and storage in the cement, lime and gypsum industry, in minerals and mining, in power stations, iron and steel plants, foundries, the chemical industry and bulk terminals.

## Aurecon

PT Aurecon Indonesia  
Alamanda Towers 24th Floor, Unit C-D

Jl.T.B. Simatupang Kav. 23-24,  
Cilandak Barat  
Jakarta 12430  
Indonesia  
Contact: Mr Jeff Tutticci  
Job Title: BD Manager  
T: + 62 21 2965 4000  
F: + 62 21 2965 4001  
E: Jeff.Tutticci@aurecongroup.com

W: http://www.aurecongroup.com  
Multidiscipline Consulting Engineers specialising in the design of infrastructure for efficient and innovative pit to port solutions.

## Aurecon

L10 - 55 Grenfell Street  
Adelaide  
South Australia  
5000  
Australia

Contact: Mr Stephen Symons  
Job Title: Development Manager  
T: + 61 8 8237 9905  
F: + 61 8 8237 9778  
E: SymonsS@ap.aurecongroup.com  
W: www.aurecongroup.com

## Aurecon Hatch

L4, 152 Wharf Street  
Spring Hill  
Brisbane  
Queensland 4000  
Australia

Contact: Mr Graham Moody  
Job Title: Market Leader Coal Transport  
T: + 61 7 3173 8000  
F: + 61 7 3173 8001  
E: moodyg@aureconhatch.com  
W: www.aureconhatch.com

## Ausenco

855 Homer Street  
Vancouver  
British Columbia  
V6B 2W2  
Canada

Contact: Mr Joel A Cawker  
Job Title: VP International, Process Infrastructure  
T: + 1 604 638 4740 (direct)  
F: + 1 604 688 5913  
E: joel.cawker@ausenco.com  
W: www.ausenco.com  
Ausenco Sandwell has planned and engineered port terminals and bulk systems for rates up to 16,000 t/h and vessels up to 500,000 dwt. EPCM services related to terminal design, truck dumping, crushing,





# BEDESCHI

Since 1908...



...taking the best from the past to build the future



## BEDESCHI

Via Prainbole 38 – 35010 Limena PD – Italy  
Tel. +39 049 7663100 Fax +39 049 8848006  
[www.bedeschi.com](http://www.bedeschi.com) [sales@bedeschi.it](mailto:sales@bedeschi.it)

**BEDESCHI AMERICA**

3275 W. Hillbrow Boulevard Suite 312 - Deerfield Beach - FL 33442 USA Tel. +1 954.602.2175 Fax. +1 954.602.5390 [www.bedeschi-america.com](http://www.bedeschi-america.com)

**CPT Team**

Via S. Maria In Campo 1 – 20040 Cavenago di Brianza (MB) – Italy Tel. +39 02 95819803 Fax +39 02 95910846 – [www.cpt.mi.it](http://www.cpt.mi.it)

**BEDESCHI DUBAI**

Level 9 Monarch Office Tower - One Sheikh Zayed Road, PO Box 333840, Dubai - UAE Phone +9 714 3721303 - [bed@dubai@bedeschi.com](mailto:bed@dubai@bedeschi.com)



screening, sampling, rail loadout, rail transportation, shiploaders, shipunloaders, railcar dumpers, conveyors, overland belt conveyors, transfers, storage, stackers, staker/reclaimers and sophisticated simulation modelling are supplemented by the Company's ability to custom design materials handling facilities and equipment.

**AusGroup Limited**

Head Office  
Level 2, 251 St Georges Terrace  
Perth  
WA  
6000  
Australia  
Contact: Laurie Barlow  
Job Title: CEO  
T: + 61 8 6210 4500  
F: + 61 8 6210 4501  
E: info@agc-ausgroup.com  
W: www.agc-ausgroup.com

**Avplast Dis Tic. Ve Paz. Ltd. Sti.**

Egitim Mah. Kasap Ismail Sok.  
Avrasya Is Merkezi No:14 Kat:1  
D:24-  
34722 Hasanpasa / Kadikoy  
Istanbul  
81080  
Turkey  
Contact: Mr Hakan Avci  
T: + 90 216 338 32 31 - 347 38 54  
F: + 90 216 348 88 95  
E: sales@avplast.com.tr  
W: www.avplast.com.tr

**B. A. G. Corp.**

11510 Data Drive  
Dallas  
Texas  
75218  
USA  
Contact: Mr Matthew Simons  
Job Title: Marketing Director  
T: + 1 214 340 7060 ext 832  
F: + 1 214 340 7060  
E: matt@bagcorp.com  
W: www.bagcorp.com  
B.A.G. Corp. manufactures Super Sack® containers, woven polypropylene flexible intermediate bulk containers (FIBCs) for shipping, handling and storing of dry, flowable products. The B.A.G. Corp. family also includes: FIBC Recycling, Inc., reconditioning FIBCs in a closed-loop system, and Winzen Film and Fiber, Inc., manufacturing and distributing film, fiber and webbing.

**Bagfilla SA Pty Ltd**

PO Box 34251  
Jeppestown  
Gauteng  
2043  
South Africa  
Contact: Mr Alan Mason  
T: + 27 11 613 8024  
F: + 27 11 613 1080  
E: info@bucklepack.co.za  
W: www.bucklepack.co.za  
Suppliers of Bag Sewing and Heat sealing machines to close open mouth bags.

**Bayards Aluminium**

**Constructions**  
PO Box 9  
Nieuw-Lekkerland  
ZH  
2957 ZG  
The Netherlands  
Contact: Mr Dick de Kluijver  
Job Title: Commercial Director  
T: + 31 184 683000  
F: + 31 184 684345



E: dick.dekluijver@bayards.nl  
W: www.bayards.nl  
Bulk containers.

**Bedeschi SpA**

Via Praimbole  
38 Limena  
Padova  
35010  
Italy  
Contact: Mr Pietro De Michieli  
Job Title: Sales & Project Director  
T: + 39 049 766 3100  
F: + 39 049 884 8006  
E: sales@bedeschi.it  
W: www.bedeschi.it  
Material handling solutions such as stackers, reclaimers, ship loaders and ship unloaders plus crushing equipment.

**BEHN + BATES Maschinenfabrik GmbH & Co. KG**

Robert-Bosch-Strasse 6  
Munster  
D-48153  
Germany  
Contact: Ms Gabriele Buss  
T: + 49 251 9796 0  
F: + 49 251 9796 260  
E: sales@behnates.com  
W: www.behnates.com  
For more than 75 years we have specialised in the manufacture of packing machines for filling all kind of bulk products, especially food and pet food, into valve and open-mouth bags with filled weights of 1.5 up to 50 kg and big bags of up to 1,800 kg.

**Bekaert NV**

Product Group Steelcord  
Bekaert Street 2  
Zwevegem  
B-8550  
Belgium  
Contact: Mr Hans Desmet  
Job Title: Marketing  
T: + 32 9 3749 148  
F: + 32 9 3749 292

E: hans.desmet@bekaert.com  
W: www.bekaert.com  
Bekaert is a leader in manufacturing of wire and wire products for a wide range of industrial and household applications. Steel cord is the best way to reinforce a tire, a conveyor belt. Bekaert produces conveyor belt cords and woven steel cord fabrics for conveyor belt reinforcement.

**Belt Equipment Supplies Sdn Bhd**

11-0-8  
Jalan 3/109F  
Danau Business Centre  
Taman Danau Desa  
Kuala Lumpur  
58100  
Malaysia  
Contact: Mr K H Low  
Job Title: Managing Director  
T: + 60 3 7984 6099  
F: + 60 3 7984 6097  
E: belt@pc.jaring.my  
W: http://beltequipment.com.my  
Solutions for Bulk Handling, vacuum cleaning and logistic transportation.

**BELTANA Trading EK**

Sorenfeldring 27  
Hamburg  
22359  
Germany  
Contact: Mr Jörg Heyenga  
T: + 49 40 6037456  
F: + 49 40 6037457  
E: info@beltana.de  
W: www.beltana.de  
Specialists in the supply of high-quality fabric and steelcord conveyor belts for handling bulk materials on horizontal, inclined and vertical conveyors. Flame retardant belts for coal mines and power plants. Interesting stocklots of new and second-hand belts.

**Bemo Rail BV**

Debbemeerweg 59  
Warmenhuizen  
1749 DK  
The Netherlands  
Contact: Mr Theo Druif  
T: + 31 226 425 300  
F: + 31 226 421 916  
E: info@bemorail.nl

**Benetech GmbH**

Karl Liebkrecht Str 27  
b. Leipzig  
Deuben  
DE-06682  
Germany  
Contact: Mr Frank Lippert  
Job Title: Managing Director  
T: + 49 34441 445 0  
F: + 49 34441 445 20  
E: benetech@gmx.de

**Benetech, Inc.**

2245 Sequoia Drive  
Suite 300  
Aurora  
Illinois 60506  
USA  
Contact: Mr Christopher F Blazek  
Job Title: Vice President, Marketing  
T: + 1 630 844 1300 x214  
F: + 1 630 844 0064  
E: blazekc@benetechusa.com  
W: www.benetechusa.com  
Benetech offers a range of engineering, equipment, and field services supporting your bulk-material handling and dust control needs. Benetech's equipment or turnkey solutions are geared to reducing risk and operating costs. Our Plant Professionals division provides operations consulting support.

**Bergu International AB**

Nygata 30  
Box 5006  
Helsingborg  
S-250 05  
Sweden  
Contact: Mr Conny Simonsson

T: + 46 42 12 7970  
F: + 46 42 12 8002  
E: bergu@telia.com  
W: www.bergu.com  
Produces components for pneumatic conveying equipment.

**Beumer Group GmbH & Co KG**

Oelder Strasse 40  
Beckum  
North-Rhine Westphalia  
D-59269  
Germany  
Contact: Dipl. Ing. Ulrich Hock  
Job Title: Director Sales  
T: + 49 2521 24 0  
F: + 49 2521 24 280  
E: BEUMER@BEUMER.com  
W: www.beumergroup.com  
The BEUMER group is a leading international manufacturer of intralogistic systems specializing in conveying, loading, palletizing and packaging technology as well as in sorting and distribution systems. Having approx. 750 employees and a turnover of around EUR 150 million, BEUMER has, with subsidiaries and representations, a worldwide presence for various industries.

**BGS Holland**

Hoogeveeneweg 5  
Nieuwerkerk ad IJssel  
2913 LV  
The Netherlands  
Contact: Ms Martina Hermans  
T: + 31 180 317838  
F: + 31 180 315538  
E: info@bgsholland.nl  
W: www.bgsholland.nl  
Produces 'Choke Feed Scavenger' fittings for loadspouts to remove dust while loading bulk materials into ships, trucks or rail cars. Capacities range from 50 to 2000m<sup>3</sup> per hour.

**Binder + Co AG**

Grazer Strasse 19-25  
Gleisdorf  
A-8200

Austria  
 Contact: Ms Almut Schnehen  
 T: + 43 31 12 800 0  
 F: + 43 3 112 800 300  
 E: office@binder-co.at  
 W: www.binder-co.com

## Birus International Pty Ltd

10 Dandenang Street  
 Dandenong  
 Victoria  
 3175  
 Australia  
 Contact: Mr Paul Shultz  
 Job Title: Managing Director  
 T: + 613 9769 2646  
 F: + 613 9769 2535  
 E: sales@birus.com.au  
 W: www.birus.com.au

## BLUG Credeblug S.L.



Juan XXIII - 9  
 Azpeitia  
 Guipuzcoa  
 20730  
 Spain  
 Contact: Mr JR Zubeldia  
 Job Title: Commercial Manager  
 T: + 34 943 810 150  
 F: + 34 943 815 665  
 E: jrzubeldia@blug.es  
 W: www.blug.es  
 BLUG product range fits what the maritime bulk handling sector requires. Our handling solutions can be adapted to any kind of existing harbour crane. BLUG solutions go from automatic grabs, to 4-rope or electro-hydraulic high volume grabs that fit any crane,

material and production requirements.

## BMT De Beer

Guldenwaard 141  
 Rotterdam  
 3078 AJ  
 The Netherlands  
 Contact: Mr Jeroen de Haas  
 Job Title: Managing Director  
 T: + 31 10 479 0311  
 F: + 31 10 479 1466  
 E: surveyors@bmtdebeer.com  
 W: www.bmtdebeer.com  
 BMT De Beer is one of the world's leading independent marine surveying companies, providing a wide portfolio of services in cargo, nautical and technical matters. The company offers a comprehensive array of marine services and brings an unprecedented level of expertise to every aspect of marine surveying.

## Bogaert Transmission (GEHA)

Industriepark  
 Neringstraat 5  
 Londerzeel  
 B-1840  
 Belgium  
 Contact: Mr Luc Vlieminckx  
 T: + 32 52 75 0421  
 F: + 32 52 30 01 98  
 E: info@bogaert-transmission.com  
 W: www.bogaert-transmission.com  
 Supply conveyor-chains and sprockets for the heavy industries eg cement, fertiliser, ore, coal, gypsum etc. Chains with breaking load of 300 tons. Manufacture sprockets to a diameter of 2 metres. Consult for replacement chains for bucket-elevators and en-masse scraperchains etc.

## Bonfanti srl

Highway Briantea 4  
 Ambivere  
 24030  
 Italy  
 Contact: Mr Riccardo Losa  
 T: + 39 035 908 911  
 F: + 39 035 493 7049  
 E: com@bonfanti.it  
 W: www.bonfanti.it

## Bosch Rexroth AG

Zum Eisengießler 1  
 Lohr am Main  
 97816  
 Germany  
 Contact: Mrs Julia-Jacqueline Klein  
 T: + 49 9352 18 4401  
 F: + 49 9352 40 4885  
 E: Julia.Jacqueline.Klein@boschrexroth.de  
 W: www.boschrexroth.com

## Bosch Rexroth B.V.

Kruisbroeksstraat 1  
 Boxtel  
 Noord-Brabant  
 5281 RV  
 The Netherlands  
 Contact: Mr Edwin Doedee  
 Job Title: Sales Manager, Materials Handling & Mining  
 T: + 31 411 65 19 51  
 F: + 31 411 65 14 83  
 E: cylinders@boschrexroth.nl  
 W: www.boschrexroth.nl  
 Has a worldwide responsibility for turnkey projects and the development and production of Hydraulic Cylinders. Core competence is the development of engineered-to-order products, mostly one-off solutions for specific applications.

## Bosch Rexroth Mellansel AB

PRS-MLL  
 Mellansel  
 890 42  
 Sweden  
 Contact: Mr Uno Sundelin  
 Job Title: Business Area Manager  
 T: + 46 660 87000  
 F: + 46 660 87160  
 E: info@hagglunds.se  
 W: www.boschrexroth.com  
 Hägglunds Drives manufactures and markets drive system solutions for applications requiring high torque, low speeds and variable speeds. The drive systems are used in a wide range of industries, such as Mining and materials handling

## Boyne Area Manufacturing (BAM)

1 Altair Drive  
 Boyne City  
 MI  
 49712  
 USA  
 Contact: Mr John Laursen  
 Job Title: Director of Sales & Marketing  
 T: + 1 231 459 4242  
 F: + 1 231 459 4243  
 E: jlaursen@boynearea-mfg.com  
 W: www.boynearea-mfg.com  
 Boyne Area Manufacturing (BAM) began in 2008 with over 40 yrs. in sales, design and engineering experience in bulk material handling. We have built loading equipment for trucks and trailers, railcars, barges and ships, and stockpiling. Our spouts, positioners, gates, wet&dry dust collectors, and air slides are the best value in the industry. Call us!

## Brelko Conveyor Products

PO Box 62392  
 Marshalltown  
 Johannesburg  
 Gauteng  
 2107  
 South Africa  
 Contact: Mr Peter Ellis  
 Job Title: Sales & Marketing Director  
 T: +27 11 013 4000  
 F: +27 11 013 4150  
 E: peter@brelko.com  
 W: www.brelko.com  
 BRELKO develops, produces and markets a range of products for the bulk materials handling industry and provides an installation and maintenance service, including a 24-hour call out service. BRELKO products are intended to assist in the control of spillage, carryback and dust, as well as promoting trouble free flow of material at belt conveyor transfer and load points.

## Bretby Gammatech Ltd.

Unit 4 Station Yard  
 Station Road  
 Melbourne  
 Derbyshire  
 DE73 8HJ  
 UK  
 Contact: Mr Paul Taylor  
 Job Title: Managing Director  
 T: + 44 1332 694594  
 F: + 44 1332 865860  
 E: Paul@BretbyGammatech.com  
 W: www.bretbygammatech.com

## Bridgestone Industrial Limited

Berliner Ring 89  
 Bensheim  
 64625  
 Germany

Contact: Mr John Hanson  
 T: + 49 6251 690 396  
 F: + 49 6251 690 397  
 E: hanson.j@bridgestone-industrial.de  
 W: www.bridgestoneindustrial.com

## Bridon International Ltd

Bally Carr Bank  
 Doncaster  
 South Yorkshire  
 DN4 5JQ  
 UK  
 Contact: Ms Jenny Ferguson  
 Job Title: Marketing Assistant  
 T: + 44 1302 309 265  
 F: + 44 1302 382 263  
 E: fergusonj@bridon.com  
 W: www.bridon.com  
 A world leader in the manufacture of high performance steel wire ropes for the industrial, mining, energy, marine and fishing markets. Bridon's strength and consistently superior quality products provide our customers with reliable and cost effective solutions in addition to the peace of mind of working with the world leader.

## Brock Grain Systems

A Division of CTB, Inc  
 611 N. Higbee Street  
 PO Box 2000  
 Milford  
 Indiana  
 46542-2000  
 USA  
 Contact:  
 Job Title: Managing Director  
 T: + 1 574 658 4191  
 F: + 1 574 658 4133  
 E: brock@ctbinc.com  
 W: www.brockgrain.com

## BRUKS AB

Sjögatan 1L  
 Ömsköldsvik  
 SE-89160  
 Sweden  
 Contact: Mr Patrik Hammar  
 T: + 46 660 29 45 65  
 F: + 46 660 29 45 70  
 E: phr@bruks.com  
 W: http://www.bruks.com/

## BRUKS Klöckner GmbH

Grabenstrasse 1  
 Hirtscheid  
 Nistertal  
 D - 57647  
 Germany  
 Contact: Mr Markus Schwarz  
 T: + 49 26 61 28 167 +49 (0) 26 61 / 280  
 F: + 49 26 61 28 180  
 E: msz@bruks.com  
 W: www.bruks.com

## BRUKS Rockwood Incorporation

5975 Shiloh Road  
 Suite 109  
 Alpharetta  
 GA  
 30005  
 USA  
 Contact: Mr Ken Upchurch  
 Job Title: Vice President of Sales & Marketing  
 T: + 1 770 849 0100 x109  
 E: kuh@bruks.com  
 W: www.bruks.com

## BSG Resources

36 Fricker Road  
 Illovo Boulevard  
 Illovo  
 Johannesburg  
 Gauteng  
 2196  
 South Africa  
 Contact: Mr Frank Eagar

Handling solutions  
 GRABS & TONGS

**BLUG**  
 Credeblug, s.l.

AZPEITIA (SPAIN)  
 Tel.: 0034-943810150  
 Email: info@blug.es  
 www.blug.es



**Strong partner in Grain Management.** One of the big challenges of our age is to supply all the people worldwide with food. Every year, millions of tons of grain are collected, stored, and handled around the globe – and the upward trend is unbroken. Only the most up-to-date plant and equipment can guarantee rapidity and quality while minimizing raw material losses. In order to meet the increasingly stringent challenges, Bühler Grain Logistics provides with its capabilities the best possible solution – for conveying, cleaning, drying, storing, dedusting or loading and unloading the most important commodity on earth.

Bühler AG, Grain Logistics, CH-9240 Uzwil, Switzerland  
T +41 71 955 11 11, F +41 71 955 3949  
grain-logistics@buhlergroup.com, www.buhlergroup.com



Innovations for a better world.

**BUHLER**





**BLL** takes care of handling your bulk materials from production to consumption, including:

- Project feasibility study
- Consulting, design and engineering
- Equipment procurement and supply
- Supervision and technical assistance
- Technology transfer and implementation
- Training, performance monitoring

...and more

**BLL** ... A sea of knowledge and expertise !

[www.bulklogisticlandmark.com](http://www.bulklogisticlandmark.com) • [info@bulklogisticlandmark.com](mailto:info@bulklogisticlandmark.com)

**B**ulk **L**ogistic **L**andmark specializes in:

*Offshore: floating cranes, floating terminal, self-discharging vessels and barges*

*Onshore: cranes, hoppers, grabs, conveyor belts, crushers, stackers, reclaimers, storage facilities, shiploaders*



**B BUTTIMER**  
 Bulk Engineering

Consultancy • Design • Procurement • Project Management



**Experts in the Mechanical Handling of Bulk Materials**

- Bulk Terminal Design & Process Engineering – Grains, Coal, Ore, Biomass & others
- Equipment Specification, Sourcing & Procurement
- Design & Fabrication of Dockside Unloading Hoppers, Shiplading Equipment
- Processing Lines, Storage & Multi-Modal Outloading

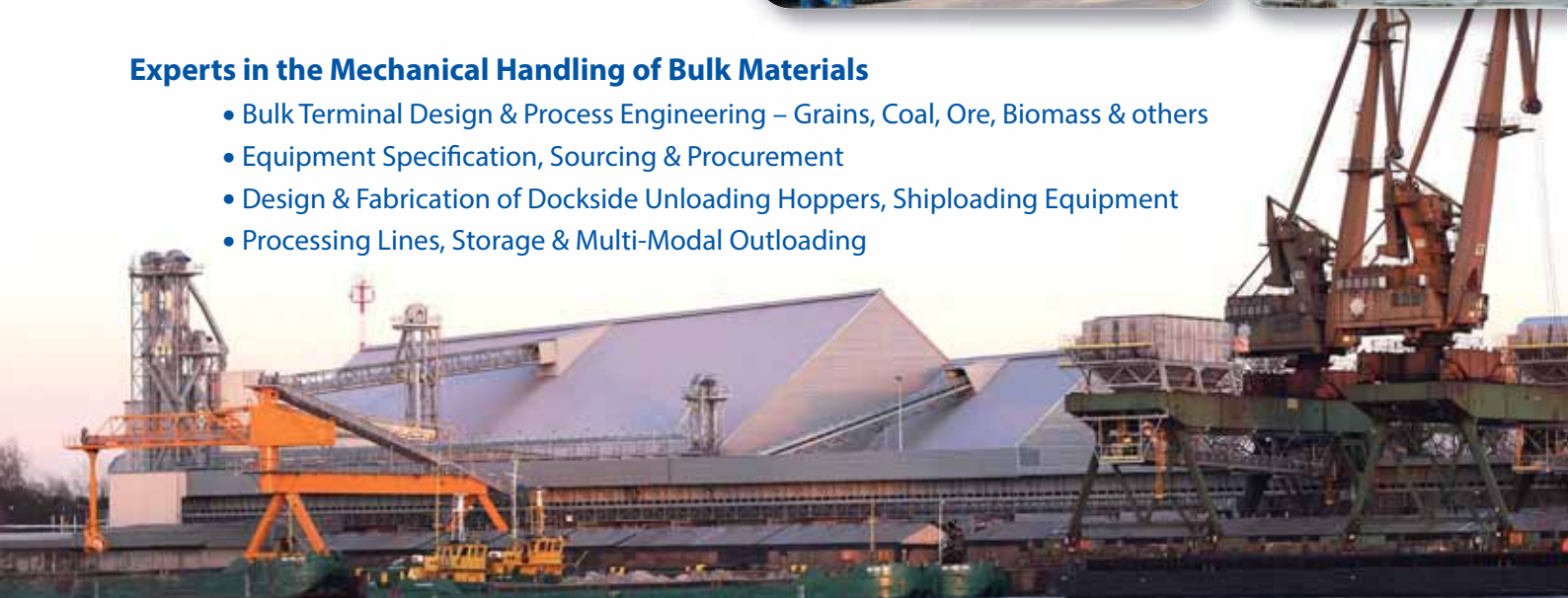



Job Title: New Business Development  
 T: + 27 11 3271 070  
 F: + 27 11 3271 011  
 E: frank@bsgresources.com  
 W: www.bsgresources.com

## Bucket Mart Inc.

PO Box 1240  
 Marion  
 Illinois  
 62959  
 USA  
 Contact: Mr Jack Johnson  
 Job Title: President/CEO  
 T: + 1 813 390 8626  
 F: + 1 813 908 9474  
 E: salesbucketmart@aol.com  
 W: www.bucketmart.net  
 New/Used All sizes/Types/Brands  
 Clamshell Buckets/Grabs, Grapple  
 Buckets/Grabs, HYD  
 Buckets/Grabs, Radio Controlled  
 Buckets/Grabs Buckets/Grabs

## Bühler AG, Grain Logistics



Gupfenstrasse 5  
 Uzwil  
 CH-9230  
 Switzerland  
 Contact: Mr Martin Stöckling  
 Job Title: Head of Market Segment  
 Terminals, GLTE1  
 T: + 41 71 955 3290  
 F: + 41 79 657 8920  
 E: martin.stoekling@buhlergroup.com  
 W: www.buhlergroup.com  
 Customized solutions for grain  
 handling. Bühler Grain Logistics  
 Terminals is the ideal partner when  
 it comes to reliable solutions in the  
 area of grain handling and storage.  
 The company's wide range of  
 offerings includes ship loading and  
 unloading solutions, conveying  
 systems and silos as well as  
 storage equipment.

## BULK JD

Oude Kasseei 16  
 Waregem  
 B-8791  
 Belgium  
 Contact: Mr Xavier Goarnisson  
 Job Title: Senior Sales Engineer  
 T: + 32 479 40 49 75  
 F: + 32 56 75 62 13  
 E: xavier.goarnisson@bulkid.be  
 W: www.bulkid.be

## Bulk Cargo Handling BVBA

Nijverheidskaai 28  
 Bus 9  
 Brussels  
 1080  
 Belgium  
 Contact: Mr Nicola Samyn  
 Job Title: CEO  
 T: + 32 477 44 98 81  
 E: bch.belgium@gmail.com

## Bulk Lift International

1013 Tamarac Drive  
 Carpentersville  
 IL  
 60110  
 USA  
 Contact: Mr Brian Kelly  
 Job Title: National Sales Manager  
 T: + 1 847 428 6059 x 215  
 F: + 1 847 428 7180  
 E: briank@bulklift.com  
 W: www.bulklift.com

## Bulk Logistic Landmark



403 Obaidulla Building  
 Murraqqabad Road  
 Deira  
 Dubai  
 UAE  
 Contact: Mr Sanjeev Mathur  
 Job Title: Country Manager  
 T: + 971 4 224 9510  
 F: + 971 5 541 5085  
 W: www.bulklogisticlandmark.com

## Buttimer Bulk Engineering



Carrigeen Industrial Estate  
 Cahir  
 Co. Tipperary  
 Republic of Ireland  
 Contact: Mr Joseph Cummins  
 Job Title: Business Development  
 T: + 353 52 744 1377  
 E: info@buttimerbulk.com  
 W: www.buttimerbulk.com  
 Buttimer Bulk is a mechanical  
 engineering company, specialised  
 in design and provision of bulk  
 handling systems for EPC projects  
 and similar, internationally. Experts  
 in handling commodities such as  
 coal, iron ore, grains, biomass and  
 others. Services include  
 consultancy, process design,  
 detailed drawing, procurement and  
 project management. Part of  
 Buttimer Group.

## BV Beco

De Limiet 18  
 Vianen  
 Utrecht  
 4131 - NR  
 The Netherlands  
 Contact: Mr Henk van Vuren  
 Job Title: Managing Director  
 T: + 31 347 323 100  
 F: + 31 347 377 780  
 E: h.vanvuren@beco-vianen.nl or  
 d.vanhattem@beco-vianen.com  
 W: www.becograbs.com  
 Beco Grabs is one of the world's  
 leading specialists for grab-  
 equipment and is certified in  
 accordance with ISO 9001:2008.  
 We are able to fulfil the still growing  
 demands for custom made grabs  
 and/or specials as well as in the  
 field of bulk material handling as in  
 the field of dredging.

## ByM Agencia Martima

Coronel Pereira 72  
 OF 1002  
 Las Condes  
 Santiago  
 1002  
 Chile  
 Contact: Mr Anogar Muschen V  
 Job Title: Manager  
 T: + 56 2 365 1197  
 F: + 56 2 366 1267

## C. Christophel GmbH

Taschenmacherstr. 31-33  
 Lübeck  
 SH  
 23556  
 Germany  
 Contact: Mr Matthias Dammer  
 Job Title: Sales  
 T: + 49 43 66 88 48 20  
 F: + 49 43 66 88 88 75  
 E: mail@christophel.com  
 W: www.christophel.com

## Cable Arm Inc

3452 W Jefferson Avenue  
 Trenton  
 Michigan  
 48183 2939  
 USA  
 Contact: Mr Ray Bergeron  
 Job Title: President  
 T: + 1 734 676 6108  
 F: + 1 734 676 1345  
 E: info@cablearm.com  
 W: www.cablearm.com  
 Produces environmental and bulk  
 handling grabs. These are  
 available in double rope design for  
 mobile cranes and in four rope  
 versions for portal dockside cranes  
 and gantries.

## Cachapuz Bilancial Group

Parque Industrial de Sobreposta  
 Apartado 2012  
 Braga  
 Braga  
 4701-952  
 Portugal  
 Contact: Mr Nuno Matos  
 Job Title: International Business  
 Developer  
 T: + 351 253 603 480  
 F: + 351 253 603 485  
 E: info@cachapuz.com  
 W: www.cachapuz.com

## Calim Grab Industry

Piri Reis Cad  
 Çınar San.  
 Sitesi No:46 Maltepe  
 Istanbul  
 81540  
 Turkey  
 Contact: Mr Murat Calim  
 T: + 90 533 226 4923  
 F: + 90 216 399 79 71  
 E: info@calimkepce.com  
 W: www.calimgrabs.com or  
 www.calimkepce.com  
 Calim Grabs in a manufacturer of  
 mechanical, electro-hydraulic and  
 remote controlled grabs. Other:  
 Lifting equipments C Hooks

## Camar Mill Systems Ltd

P.O. Box 419  
 1600 King St N  
 St. Jacobs  
 Ontario  
 N0B 2N0  
 Canada  
 Contact: Mr Rick Weber  
 Job Title: President  
 T: +1 519 664 3709  
 F: +1 519 664 3700  
 E: rick@camar.ca  
 W: www.camar.ca  
 Camar is an engineering leader,  
 providing Total Project Engineering,  
 Project Management and Process  
 Automation. Marine grain terminals,  
 feed mills and related process  
 design and construction, from initial  
 plan development through  
 engineering, construction  
 management and final  
 commissioning.

## Cambelt International Corp

2820 West. 1100 South  
 Salt Lake City  
 Utah  
 84104  
 USA  
 Contact: Mr Dave Hansen  
 Job Title: VP, Sales  
 T: + 1 801 972 5511 ext 205  
 F: + 1 801 972 5522  
 E: info@cambelt.com  
 W: www.cambelt.com  
 Manufacturer of high incline belt  
 conveyor and mechanical bulk  
 materials handling systems. Also  
 produces 'Cambelt' automated

reclaim systems for large volume  
 dome storage systems.

## Capotex

Colombia 1  
 Majadahonda  
 Madrid  
 28220  
 Spain  
 Contact: Mr Compere Benoit-Hervé  
 Job Title: Export Manager  
 T: + 34 91 634 71 92  
 F: + 34 91 636 21 15  
 E: export@capotex.com  
 W: www.capotex.com  
 CAPOTEX is the only company on  
 a world level that exclusively  
 specialises in covering belt  
 conveyors. Our experience  
 enables us to provide the market  
 with a wide series of standard  
 solutions, together with customised  
 designs at very competitive prices.

## Carbonser, S. A. DE C. V.

Guillermo Gonzalez Camarena  
 No. 1200 Piso 7  
 Centro Ciudad Santa Fe  
 DF  
 01210  
 Mexico  
 Contact: Ing. Thomas Cortes  
 Petersen  
 Job Title: Director  
 T: + 52 55 5246 7360  
 F: + 52 55 5246 7391  
 E: tcortes@techint.com.mx  
 W: www.techint.com.mx  
 Techint is the leader of the  
 Consortium Carbonser for  
 executing the BOT contract to  
 handle up to 6 million tons of coal  
 annually. Techint is a leading  
 engineering and construction  
 company operating worldwide. The  
 services provided included the  
 design, construction and operation  
 of the coal terminal for 30 years  
 starting from 1999.

## Cargotec Sweden AB, Marine

### Selfunloaders

PO Box 914  
 Enköping  
 SE-745 25  
 Sweden  
 Contact: Mr Johan Ericson  
 T: + 46 171 232 00  
 F: + 46 171 232 99

E: susales.enk@cargotec.com  
 W: www.cargotec.com

## Carlsen Group

Van Polanenweg 2  
 Krimpen aan de IJssel  
 2921 LT  
 The Netherlands  
 Contact: Mr Bastiaan Snoek  
 Job Title: Area Sales Manager  
 T: + 31 180 440 720  
 E: bs@carlensgroup.com  
 W: www.carlensgroup.com  
 A leading expert in marine, offshore  
 and onshore bulk handling  
 systems. 50 years of design and  
 engineering experience in  
 equipping dry bulk ships, barges,  
 supply vessels, harbor loading and  
 unloading equipment, drilling rigs  
 and floating terminals.

## Carmatec AB

Sporregatan 16  
 Malmö  
 Malmö  
 S-213 77  
 Sweden  
 Contact: Mrs Carina Thern  
 Job Title: Managing Director  
 T: + 46 4014 07 90  
 F: + 46 4014 07 99  
 E: carina.thern@carmatec.se  
 W: www.carmatec.se  
 Our mission is to; - guide and  
 partner you in the self unloading  
 market for cement handling  
 business - develop efficient and  
 practical systems/ways to handle  
 bulk materials - find new solutions  
 for existing equipment - offer  
 advice and service - develop and  
 refine components and solutions for  
 special services and applications.

## Carsurin

Askrindo Building 5th Floor  
 Jl Angkasa Blok B-9 Kav 8  
 Kemayoran  
 Jakarta  
 10610  
 Indonesia  
 Contact: Mr Tomtom Sukanto  
 Job Title: Director Coal & Minerals  
 T: + 62 61 661 8272  
 F: + 62 21 654 0346  
 E: headoffice@carsurin.com  
 W: www.carsurin.com



# Cat® Industrial Solutions

# READY WHEN YOU ARE

# ALL DAY. EVERY DAY.



**Your goal is to move more material in less time with less cost:** When working the port, use our revolutionary Cat® K Series wheel loaders to efficiently handle the dry bulk material between loading areas:

- Work safely with our industrial package that includes cab screen guards, pressurized cab filtration, and a rear view camera.
- Enhance versatility with our large selection of work tools - the Cat quick coupler for instance allows for fast tool changes without leaving the cab.
- Stay up and running with unmatched parts availability and consistent support from your local Cat dealer
- Financing and leasing plans, offered through Cat Financial, help you acquire the assets you need to be successful.

Cat wheel loaders will help you optimize productivity, versatility and safety. To learn more call your local Cat dealer to get a copy of the Cat Dry Bulk Handling Brochure.





**Caterpillar Belgium**

Ave des Etats Unis  
Charleroi  
B6041  
Belgium  
Contact: Mr Philippe Michaux  
Job Title: Marketing  
F: + 32 71 25 29 56  
E: michaux\_philippe@cat.com

**Caterpillar Commercial Northern**

**Europe**

Phoenix Building  
Central Boulevard  
Solihull  
B90 8BG  
UK  
Contact: Mr William Spielmann  
Job Title: Industry Sales  
Representative  
T: + 44 1564 786466  
F: + 44 1564 786451  
E: Spielmann\_William@cat.com  
W: www.cat.com  
With 2011 sales and revenues of \$60.138 billion, Caterpillar is the world's leading manufacturer of construction and mining equipment, diesel and natural gas engines, industrial gas turbines and diesel-electric locomotives. The company also is a leading services provider through Caterpillar Financial Services, Caterpillar Remanufacturing Services and Progress Rail Services.  
http://www.caterpillar.com

**Caterpillar Inc**

100 NE Adams Street  
Peoria  
IL  
616-6335  
USA  
Contact: Mrs Sharon Holling  
Job Title: PR

T: + 1 309 675 8995  
F: + 1 309 675 4757  
E: Holling\_Sharon\_L@Cat.com  
W: www.cat.com  
Caterpillar equipment product line, consisting of more than 300 machines, sets the standard for the construction industry. The company is also the world's largest manufacturer of medium-speed engines and high-speed diesel engines. The parts distribution network features 23 centres in 11 countries and 13 centres in the United States.

**Caterpillar SARL**



Route de Frontenex 76  
Geneva  
1207  
Switzerland  
Contact: Mr Nicolas Gomez  
Job Title: Segment Specialist  
T: + 41 22 849 4085  
F: + 41 22 849 4986  
E: gomez\_nicolas@cat.com  
W: www.cat.com  
With 2012 sales and revenues of \$65.875 billion, Caterpillar is the world's leading manufacturer of construction and mining equipment, diesel and natural gas engines, industrial gas turbines and diesel-electric locomotives. The company also is a leading services provider through Caterpillar Financial Services, Caterpillar Remanufacturing Services and Progress Rail Services.  
Other Equipment: Articulated Trucks, Compact Track Loaders,



Hydraulic Excavators, Mini-Excavators, Skid Steer Loaders, Telehandlers, Track Type Loaders, Track Type Tractors, Wheel Dozers, Wheel Loaders, Wheel Material Handlers. Work Tools. Fleet Management Solutions.

**Cavotec Deutschland GmbH**

Ludwig-Erhard Strasse 1a  
Eschborn  
D-65760  
Germany  
Contact: Dipl.-Ing. Dirk Moll  
Job Title: Managing Director  
T: + 49 6196 50950 12  
F: + 49 6196 50950 22  
E: dirk.moll@cavotec.com  
W: www.cavotec.com

**Cavotec Inc**

124 Hatfield Road  
Statesville  
NC 28625  
USA  
Contact: Mr Erik Wilhelmsen  
Job Title: President  
T: + 1 704 873 3009  
F: + 1 704 873 3093  
E: erik.wilhelmsen@cavotec.com  
W: www.cavotec.com

**Cavotec SA**

Via S. Balestra 27  
Lugano  
CH-6900  
Switzerland  
Contact: Mr Michael Scheepers  
Job Title: Director, Investor  
Relations & PR  
T: + 41 91 911 4010  
F: + 41 91 922 54 00  
E: michael.scheepers@cavotec.com  
W: www.cavotec.com  
Cavotec Group is a global leader in "Connecting mobile equipment".

Products from the Cavotec Group manufacturing units include; EEEx radio remote controls, electrical connectors up to 15kV, flexible cables, cable reels, slipping units. Distribution is supported by 29 Cavotec sales and service companies around the world.

**CDM Systems, Inc**

430 Main Street  
Elk River  
MN  
55330  
USA  
Contact: Mr Steve W Parker  
T: + 1 763 428 9700  
F: + 1 763 428 9701  
E: steve@cdmsys.com  
W: www.cdmsys.com

CDM Systems, Inc. offers a complete line of Mechanical Marine Leg Unloaders with mobile single leg capacities from 150 to 500 TPH (Stationary installations up to 1500 TPH.)

**Cesur Packaging Corporation**

Yakacik Yanyol  
Senem Sokak No:11  
Kartal  
Istanbul  
34876  
Turkey  
Contact: Ms Cengiz Cesur  
Job Title: General Manager  
T: + 90 216 377 2855  
F: + 90 216 377 1189  
E: info@cesurpack.com  
W: www.cesur.com



**The quality of our products is a result of our passion, dedication and hard work.**



**CFS International Engineering Handling S.r.l.**

**Sede Legale e Operativa**

Via Sigalina a Mattina, 12/14  
25018 Montichiari (BS), Italy

Ph. (+39) 030 964199 - Fax: (+39) 030 2072026  
Mobile: (+39) 340 1358822

E-mail: [info@cfshandling.it](mailto:info@cfshandling.it) - [www.cfshandling.it](http://www.cfshandling.it)  
Cod. fiscale/P.IVA: 01481680195 - REA: BS-524039



**CFS Handling srl.**



Head Office  
Via Sigalina a Mattina, 12/14  
Montichiari  
BS  
25018  
Italy  
Contact: Mr Italo Civettini  
Job Title: CEO  
T: + 39 0309 64199  
F: + 39 0302 072026  
E: civettini@cfshandling.it  
W: www.cfshandling.it  
CFS International Engineering Handling srl works in design and manufacturing of equipment for handling across a range of sectors including, coal, cement, steel mills, demolition, ores, urban solid waste, paper etc. The company's product range includes mechanical, hydraulic and electro-hydraulic buckets as well as hydraulic and electro-hydraulic grabs to suit customer's specific needs.

**CH2M Hill**

1100 112th Avenue NE  
Suite 400  
Bellevue  
WA 98004  
USA  
Contact: Mr J Michael Zachary  
Job Title: VP Dir of Ports & Intermodal  
T: + 1 425 453 5000  
F: + 1 425 462 5957  
E: feedback@ch2m.com  
Provides marine terminal engineering and planning as well as economic feasibility studies, environmental planning and construction management for the transportation industry.

**Changsha Kaiyan Instruments Co. Ltd**

172 Kaiyuan Road  
Changsha Economic & Technological Development Zone  
Changsha  
410100  
China  
Contact: Ms Susan Wang  
T: + 86 731 4012074 / + 86-731-84021617  
F: + 86 731 4012074  
E: susanky@chs5e.com  
W: www.ckic.net

**Chief Industries UK Ltd.**

Beckingham Business Park  
Tolleshunt Major  
Maldon  
Essex CM9 8LZ  
UK  
Contact: Mr Geoff Freed  
T: + 44 1621 868944  
F: + 44 1621 868955  
E: info@chief.co.uk  
W: www.chief.co.uk  
Chief Industries is an international company supplying grain storage systems throughout the world. Sizes of individual silo tanks range up to 30,000tons, with multiple silo complex sizes of several hundreds of thousand tons. Conveyors and ancillary equipment range up to 1600tph or more.

**Chief Industries, Inc.**

Chief Agri/Industrial Division  
P.O. Box 848  
Kearney



NE  
68848  
USA  
Contact: Mr Steve Ginter  
T: + 1 308 237 3186  
F: + 1 308 389 7221  
E: steve.ginter@chiefind.com  
W: www.agri.chiefind.com

**China Huadian Engineering Co., Ltd.(CHEC)**

South Gate, No 91  
North Road  
Xi San Huan  
Beijing  
100044  
China  
Contact: Mr Zheng Liu  
Job Title: Director of Int. Mrktg,  
Material Handling Division

T: + 86 139 1039 7372 / + 86 10 51 966647  
F: + 86 10 68 710553  
E: chec@chec.com.cn  
W: www.chec.com.cn  
Material Handling Division (MHD) is a core business unit of CHEC with over 200 qualified employees and over ten years experience. CHEC MHD is continuously expanding the application of bulk materials handling technologies (equipment and systems) for the market. MHD is ready to supply the optimized solution to your bulk materials handling project.

**China Sonangol International (S) Pte Ltd**

9 Temasek Boulevard #42-01  
Suntec Tower 2  
Singapore  
038989  
Singapore  
Contact: Mr Eugene Tan  
T: + 65 6808 1880  
F: + 65 6808 1881  
E: sg@chinasonangol.com  
W: www.chinasonangol.com

**CHL Equipment Ltd (incorp. Verstegen Grabs UK)**

24 Solihull Road  
Shirley  
Solihull  
West Midlands

B90 3HD  
UK  
Contact: Mr John Hinder  
Job Title: General Manager  
T: + 44 121 733 8100  
F: + 44 121 733 2796  
E: sales@chlequipment.com  
W: www.chlequipment.com  
CHL are the U.K. agents for the leading European manufacturers of material handling equipment. Whether your need is for ship unloading, moving concrete products, handling steel coils or scrap metal, we can provide the solution. We supply only the highest quality products to ensure durability, productivity, and economy for the lifetime of the equipment.





**dk**  
**vac-u-vator**<sup>®</sup>

*Barge, Ship & Warehouse Unloading  
at Rates from 100 - 300 MTPH*

[www.christianson.com](http://www.christianson.com)

**Flexible  
solutions  
for material  
handling**



*Christianson Systems offers flexible solutions for a wide range of material handling applications. Manufactured in the United States with state-of-the-art technology backed by over 50 years of experience assure that each*

*machine is built with superior quality, construction and design. Equipment recommendations are based on the customer's product, vessel size, capacity requirements, and power sources.*



**Christianson**

Pneumatic Conveying Equipment

20421 - 15th Street SE, PO Box 138  
Blomkest, Minnesota 56216 U.S.A.

Telephone: +1-320-995-6141

Email: [sales@christianson.com](mailto:sales@christianson.com)



## Christianson Systems Inc.



20421 15th Street Southeast  
Blomkest  
Minnesota 56216  
USA  
Contact: Mr Mike Schow  
Job Title: Sales Manager  
T: + 1 320 995 6141  
F: + 1 320 995 6145  
E: sales@christianson.com  
W: www.christianson.com  
Builds pneumatic grain vacs for bulk grains and feeds. Full service supplier from design and manufacturing to installation and training. Christianson shipunloaders are installed in over 90 countries worldwide.  
Trademarks/Brandnames include SuperTower, SuperPortable, Handlair, Vac-U-Vator, Chem-Vac, Seed Vac, VacBoss, Push Pac, AugerVac, Dunbar Kapple.

## CICSA &amp; MCV s.r.l.

Via dell'Industria, 2  
Beverate di Brivio (LC)  
23883, Italy  
Contact: Mrs Luisa  
T: + 39 0399 2732 12  
F: + 39 0399 2732 20  
E: sales@cicsa.it  
W: www.cicsa-mcv.com

## Cimbria Bulk Equipment



Industrivej 1a  
Herning  
DK- 7400  
Denmark  
Contact: Mr Lars Noergaard  
Job Title: Managing Director  
T: + 45 72 42 24 00  
F: + 45 72 42 24 99  
E: cbe@cimbria.com  
W: www.cimbria.com  
More than 30 years experience within developing and marketing Moduflex loading chutes and Contec screw conveyors for dustfree outloading and conveying of dry bulk material. The product programme covers all branches from agriculture to industry and solutions can be delivered for all applications within road & rail, shiploading & stockpiling.

## Clariant Corporation

101 Christine Drive  
Belen  
NM  
87002  
USA  
Contact: Mr Justin Mueller  
Job Title: Head of Business Group  
CDP Americas  
T: + 1 505 975 1676  
E: desiccants@clariant.com  
W: www.desiccants.clariant.com



## Clarke Chapman Manufacturing Ltd

P O Box 9  
Saltmeadows Road  
Gateshead  
Tyne & Wear  
Newcastle  
NE8 1SW  
UK  
Contact: Mr Nicholas Hancock  
Job Title: General Manager  
T: + 44 191 477 2271  
F: + 44 1225 332529  
E: info@clarkechapman.co.uk  
W: www.clarkechapman.co.uk/

## Claudius Peters Technologies

GmbH  
Schanzenstrasse 40  
Buxtehude  
D-21614

## Germany

Contact: Mr Matthias Raabe  
Job Title: Head of Sales, Projects & Marketing  
T: + 49 4161 706 349  
F: + 49 4161 706 270  
E: mail@bhmclaudiuspeters.com  
W: www.claudiuspeters.com  
Product lines include grinding systems, cement clinker coolers, storage and mixing silos, pneumatic conveying systems, ash removal systems, self-unloading vessels, packing and palletising systems, pulverised coal injection systems for blast furnaces. Building material product lines include natural and by-product gypsum processing systems for plants, wallboard production plaster and ceilingboard plants.

## Claudius Peters Technologies S.A.S

34 Avenue de Suisse  
BP 269  
Illzach  
Cedex  
F-68316  
France  
Contact: Mr Jean Gaffet  
T: + 33 389 313 300  
F: + 33 389 313 339  
E: technologiessa@claudiuspeters.com  
W: www.claudiuspeters.com  
Product lines of stackers/reclaimers, blending beds, grab gantry cranes, shiploaders for bulk, shiploaders for bags, combined bulk/bag shiploaders, pneumatic ship-unloaders

## CIMBRIA MODUFLEX

## DUST FREE LOADING SOLUTIONS

## CLEAN ENVIRONMENT AND WORKING SAFETY IN ONE PRODUCT

CIMBRIA.COM

## CIMBRIA MODUFLEX

loading chutes for loading any dry bulk material into tanker trucks, open trucks, rail wagons, ships and for stock piling. The loading chutes can be supplied both with and without integrated filter and with full ATEX-approval.

## CIMBRIA BULK EQUIPMENT A/S

Drejervej 10 | 7451 Sunds | DENMARK  
Phone: +45 72 42 24 00 | cbe@cimbria.com





#### Motor Driven Reels

- Monospiral and Level-Wind configurations
- Rugged and dependable magnetic coupler for dusty environments



#### Cable Festoon

- Corrosion-resistant, long-life rollers; precision sealed bearings
- Systems customized for the application
- Preassembled option, for easy installation



#### Cable Chain

- Rugged design for demanding environments
- Long operating life
- Custom-configured

## Rugged Energy & Data Transmission Systems

Conductix-Wampfler has one critical mission: To keep your bulk material handling operations running 24 / 7 / 365. You need proven, worry-free energy solutions - and Conductix-Wampfler has them. Our systems provide reliable electric power and water to stacker/reclaimers, barge and ship loaders/unloaders, bulk conveyors, tripper systems, and gantry cranes. Conductix-Wampfler systems are rugged, low maintenance, and time-tested in tough, dusty environments. All products are backed by the largest sales and service network worldwide!

[www.conductix.com](http://www.conductix.com)

**CONDUCTIX**  
wampfler  
DELACHAUX GROUP



**Cleveland Cascades Ltd**

Unit 22 Dukeway  
Teesside Industrial Estate  
Thornaby  
Stockton on Tees  
TS17 9LT  
UK

Contact: Mr Ian Barnard  
Job Title: Managing Director  
T: + 44 1642 753260  
F: + 44 1642 753270  
E: enquiries@clevelandcascades.co.uk  
W: www.clevelandcascades.co.uk  
Has developed a new dustless  
shiploading chute that can operate  
without additional dust extraction  
systems. Suitable for most types of  
bulk material including highly dusty  
products such as cement clinker,  
alumina, phosphate and apatite.

**Clime SA**

c/- Castilla 52-54  
Barcelona 08018  
Spain

Contact: Mr John Climent  
T: + 34 93 307 6362  
F: + 34 93 308 5649  
E: climesa@fibcnet.com  
W: www.fibcnet.com

**Clough Limited**

58 Mounts Bay Road  
Perth  
Western Australia 6000  
Australia

Contact: Mr Max Bergomi  
Job Title: Exec VP - Commissioning  
& Asset Support  
T: + 61 8 9281 9281  
F: + 61 8 9281 9943

E: clough@clough.com.au  
W: www.clough.com.au  
A service provider of Project  
Management, Engineering and  
Construction Contracting services  
in the oil and gas (onshore and  
offshore), petrochemicals, mining  
and minerals processing industries,  
infrastructure (including power and  
harbour works) and manufacturing  
sectors.

**CNBM International Engineering  
Co., Ltd.**

19th Floor, Building 4  
Interwest Business Center  
NO.9 Shouli South Road  
Beijing 100044  
China

Contact: Mr Wang Lin  
Job Title: Bulk Handling Division  
Manager  
T: + 86 10 68796130  
F: + 86 10 68796029  
E: wanglin@cnbmie.com  
W: www.cnbmengineering.com  
CNBM Bulk Handling consists of  
unloading/loading (barge, railway  
car, truck), conveying, storing  
(silo, dome, stacker & reclaimer  
etc.) and optional systems. Both  
pneumatic and mechanical working  
principles are integrated into a  
customer-oriented solution upon  
specific situation. It can help you  
with either your in-plant  
transportation or your terminal  
establishment.

**CNK INTERNATIONAL LIMITED**

No.29 Building  
North Gongren Xincun  
Jinan City, China  
Contact: Mr Kevin

T: + 86 531 6880 0516  
F: + 86 531 6880 0516  
E: sales@cnkcorporation.com  
W: www.cnkcorporation.com

**Coal & Mineral Technologies  
(SABS)**

1 Dr Lategan Road  
Groenkloof  
Pretoria  
Gauteng 0001  
South Africa  
Contact: Mr Heinrich Williams  
Job Title: General Manager  
T: + 27 12 428 6328  
F: + 27 12 428 7795  
E: heinrich.williams@sabs.co.za  
W: www.sabs.co.za

**COBRA Europe SA**

12 rue Henry Guy  
BP 40081  
Luxeuil les Bains Cedex  
70300  
France  
Contact: Mr E Mansour  
Job Title: President  
T: + 33 671 58 72 56  
F: + 33 384 40 44 92  
E: emphone@cobra-cs.com  
W: www.cobra-cs.com

**Coeclerici S.p.A.**

Piazza A. Diaz, 7  
Milan  
20123  
Italy

Contact: Mr Andrea Clavarino  
Job Title: CEO of Coeclerici  
Logistics Spa  
T: + 39 02 6246 9451  
F: + 39 02 6246 9444  
E: newprojects@coeclerici.com  
W: www.coeclerici.com  
One of the best known and most  
reputed companies in the field of  
offshore transloading operations.  
This achievement is based on the  
dedication and commitment of the  
company towards its clients as well  
as being an integral part of their  
production chain with a view to long  
term relationships.

**Cofely Experts BV**

Computerweg 21  
PO Box 34  
Amsterdam 1000 AA  
The Netherlands  
Contact: Ms Urske Kuijpers  
T: + 31 88 484 90 00  
F: + 31 88 484 93 00  
E: urske.kuijpers@cofely-gdfsuez.nl  
W: www.cofely-gdfsuez.nl

**Coles Associates**

PO Box 5096  
Dalkeith  
Western Australia 6009  
Australia  
Contact: Mr Richard Coles  
Job Title: Manager Business  
Development  
T: + 61 8 9389 8484  
F: + 61 8 9386 5700  
E: rcoles@colesassociates.com.au  
W: www.shiploader.com.au

**COMBI LIFT USA INC**

4203 Montrose Boulevard  
Suite 490  
Houston TX 77006  
USA  
Contact: Mr Nicolai Stoltz Nielsen  
Job Title: Vice President  
T: + 1 713 942 8825  
F: + 1 713 942 8850  
E: mail@combi-lift.eu  
W: http://www.combi-lift.eu/

**Comercial Tauro S.A.**

Merced 380 Of. 71  
Santiago  
Metropolitana  
8320310  
Chile  
Contact: Mr Matias Leyton  
Job Title: General Manager  
T: + 56 2 23621177  
F: + 56 2 23621177  
E: mleyton@vibrafloor-latam.com  
W: www.vibrafloor-latam.com

**CONDUCTIX (Delachaux)**

30 Avenue Brillat Savarin  
Belley 01300  
France  
Contact: Mr Rene Ange  
T: + 33 4 79 42 50 00 / 71  
F: + 33 4 79 42 50 05  
E: range@delachaux.fr  
W: www.delachaux.fr

**Conductix -Wampfler Australia**

14 England St  
Dandenong  
VIC  
3175  
Australia  
Contact: Mr Mark Howlett  
Job Title: Managing Director  
T: + 61 3 9706 8844  
F: + 61 3 9794 9298  
E: sales-australia@conductix.com  
W: www.conductix.com  
Previously named Insul-8 & now  
incorporating Wampfler. Designing  
& manufacturing in Australia for  
over 40 years. Products include  
conductor bars, cable festoon  
systems, cable and hose reels, slip  
rings, Kableschlepp energy chain,  
push button pendants, radio  
controls, flexible cable, industrial  
buffers, Kiepe conveyor monitoring  
equipment and UEE high voltage  
couplers.

**Conductix-Wampfler AG**

Rheinstrasse 27 + 33  
Weil am Rhein  
79576  
Germany  
Contact:  
T: + 49 7621 662 0  
F: + 49 7621 662 144  
E: info.de@conductix.com

# Cleveland Cascades Ltd

Setting the industry standard for loading solutions



## World Leader in the design & manufacture of bespoke retractable loading chutes for the handling of dry bulk materials.

- Based in the UK, Cleveland Cascades Ltd has a dedicated team of experts in the design, assembly and commissioning of loading chutes and materials handling equipment.
- With a growing range of bespoke solutions for the handling of difficult dry bulk materials, our product range includes the unique 'cascade' concept, dust-controlled conveyor transfer points and dust-controlled hoppers.
- With over 600 reference installations operating worldwide, with applications in ship, silo, road, rail & tanker loading, the company's key to success is its proven ability to provide a well-engineered solution with professional and committed support.
- Winners of prestigious Queens Awards for Environmental Achievement, Export Achievement, and Enterprise in International Trades.

**Contact Cleveland Cascades Ltd**

Unit 22, Dukeway, Teesside Industrial Estate, Thornaby, Stockton-on-Tees, Cleveland,  
TS17 9LT, United Kingdom Tel: +44 1642 753260 | Fax: +44 1642 753270  
E-mail: enquiries@clevelandcascades.co.uk | Website: www.clevelandcascades.co.uk

W: [www.conductix.com](http://www.conductix.com)  
 Conductix-Wampfler is the world's leading supplier of energy supply and data transmission systems for moving machinery. All typical technologies for the transmission of energy and data are combined under one roof. Festoon systems, conductor rails, cable chains, spring cable reels, motorized cable reels, slip ring assemblies and contactless power transmission systems.

## Conductix-Wampfler Americas

10102 F Street  
 Omaha  
 Nebraska  
 NE 68127  
 USA  
 Contact: Mr Mark Zuroske  
 Job Title: Market Development Manager, Americas  
 T: + 1 402 952 9300 ext 225  
 F: + 1 402 339 9627  
 E: [mark.zuroske@conductix.com](mailto:mark.zuroske@conductix.com)  
 W: [www.conductix.us](http://www.conductix.us)  
 The leading global manufacturer of energy/data transfer systems for bulk material handling and mining equipment at mines, bulk terminals, and bulk storage facilities. Products include motorized cable reels, heavy duty festoon systems, conductor bars, spring reels, radios and pendants.

## Conservatek Industries, Inc.

498 North Loop 336 East  
 Conroe  
 Texas  
 77301  
 USA  
 Contact: Ms Nita Bailey  
 T: + 1 936 539 1747

F: + 1 936 539 5355  
 E: [nbailey@conservatek.com](mailto:nbailey@conservatek.com)  
 W: [www.conservatek.com](http://www.conservatek.com)  
 Conservatek engineers, fabricates and installs clear-span structural aluminum framing systems to which we attach glass, aluminum panels, translucent systems and standard roofing products. All have unique design characteristics that maximize interior and exterior usage of space by eliminating secondary structural support systems. We offer complete installed systems that allow architects unmatched design flexibility while utilizing a low-density aluminum grid framework.

## Continental Construction (Memphis)

5646 Shelby Oaks Drive  
 Memphis  
 Tennessee  
 38134  
 USA  
 Contact: Mr Brian Morphis  
 Job Title: Marketing  
 T: + 1 901 382 4070  
 F: + 1 901 388 2534  
 E: [mail@continentalconst.com](mailto:mail@continentalconst.com)  
 W: [www.continentalconst.com](http://www.continentalconst.com)  
 General Contractor specializing in Heavy Industrial construction. Marine construction, driven pile foundations, and slip form concrete construction are just a few of the services that we offer. We have an impressive array of projects throughout our 30 years of experience.

## Continental Conveyor & Equipment Co Inc

PO Box 400  
 438 Industrial Drive  
 Winfield  
 Alabama  
 35594  
 USA  
 Contact: Mr Mike Roberts  
 Job Title: Group Manager/Engineered Systems  
 T: + 1 205 487 6492  
 F: + 1 205 487 4233  
 E: [info@continentalconveyor.com](mailto:info@continentalconveyor.com)  
 W: [www.continentalconveyor.com](http://www.continentalconveyor.com)  
 The Continental High Angle Conveyor (HAC) employs standard conveyor components and belts to utilise a simple but unique 'sandwich belt' approach to elevating and lowering materials at any angle, up to and including 90 degrees (vertical). The HAC® system can be located on a ship or in a loading area.

## CONTINENTAL MATADOR RUBBER, s.r.o.

Terezie Vansovej 1054  
 Puchov  
 020 01  
 Slovakia  
 Contact: Mr Dusan Michalko  
 Job Title: Marketing Manager  
 T: + 421 42 461 3050  
 F: + 421 42 461 3365  
 E: [dusan.michalko@matador.sk](mailto:dusan.michalko@matador.sk)  
 W: [www.matador.sk](http://www.matador.sk)  
 Producer and supplier of textile and steel cord conveyor belts for the mining and construction industries. Innovative products include the shockbelt with carcass EPP, the firebelt - fireproof conveyor belt and

the thermbelt with cover rubber 'T+' resistance of higher temperatures.

## ContiTech Transportbandsysteme GmbH

Breslauer Strasse 14  
 Northeim  
 D-37154  
 Germany  
 Contact:  
 T: + 49 5551 702 0  
 E: [transportbandsysteme@cbg.contitech.de](mailto:transportbandsysteme@cbg.contitech.de)  
 W: [www.contitech.de/conveyorbelts](http://www.contitech.de/conveyorbelts)  
 As a technology leader, we are the mining industry's development partner and original equipment supplier. Our conveyor belts around the world run reliably and economically, with respect for the environment. As systems supplier, we offer a full range of equipment and comprehensive service, from installation through to start-up.

## Control Systems Technology Pty Ltd

PO Box 329  
 Revesby North  
 Revesby  
 NSW  
 2212  
 Australia  
 Contact: Mr Leonard Ian Burrell  
 T: + 612 8708 0200  
 F: + 612 8708 0280  
 E: [iburrell@controlsystems.com.au](mailto:iburrell@controlsystems.com.au)  
 W: [www.controlsystems.com.au/](http://www.controlsystems.com.au/)  
 Other Equipment: Specialist Ship Loading Belt Scales

## Coperion GmbH



Niederbieger Straße 9  
 Weingarten  
 88250  
 Germany  
 Contact: Mrs Andrea Trautmann  
 Job Title: Marketing Manager  
 T: + 49 751 408 578  
 F: + 49 751 408 99578  
 E: [andrea.trautmann@coperion.com](mailto:andrea.trautmann@coperion.com)  
 W: [www.coperion.com](http://www.coperion.com)  
 Coperion GmbH is the competent partner for all bulk materials handling solutions around and within the smelter. The company offers solutions to the aluminium producing industry that have proven to be extremely efficient and reliable. Coperion has the necessary expertise for every process stage along the entire process chain in manufacturing of primary alumina. In each process step, the challenges demand plenty of experience, specialist competence and flexibility.

## Cornell & Co Inc

PO Box 807  
 Woodbury  
 New Jersey  
 08096  
 USA  
 Contact: Mr B O Donnell  
 Job Title: Equipment Sales  
 T: + 1 856 742 1900  
 F: + 1 856 742 8186  
 E: [bodonnell@cornell-co.com](mailto:bodonnell@cornell-co.com)  
 W: [www.cornellcraneandsteel.com](http://www.cornellcraneandsteel.com)

>compounding & extrusion >materials handling >service

>>Why we enjoy an unloading challenge. Because time is money and this is also very true when it comes to alumina and petcoke unloading. With our Vacuum Ship Unloader VSU, featuring leading-edge technology and our deep process know-how, we can guarantee short ship lay times and ensure gentle and reliable unloading of your product. That's what we mean when we say „confidence through partnership“. >>[www.coperion.com](http://www.coperion.com)



- > For unloading capacities up to 1.000 t/hr
- > Double or single boom technology



**Cotesi SA**

Av. Mosteiro, 486  
Grijó  
4415-493  
Portugal  
Contact: Mr Ricardo Soares  
T: + 351 227 476 500  
F: + 351 227 846 575  
E: ricardo.soares@cotesi.com  
W: www.cotesi.com

**CPS Projects (Pty) Ltd**

PO Box 47261  
Greyville  
Durban KZN  
4023  
South Africa  
Contact: Mr Banz Majola  
Job Title: Managing Director  
T: + 27 31 466 4396  
F: + 27 31 466 4399  
E: banzi@cpsprojects.co.za  
Distributor supplies and services ship loaders and unloaders, stackers/reclaimers and grabs.

**Crippen Manufacturing Company**

400 Woodside Drive  
St Louis  
MI  
48880  
USA  
Contact: Mr Darren Losey  
Job Title: Manufacturing & Production  
T: + 1 989 681 4323  
F: + 1 989 681 3818  
E: info@crippenmfg.com

**CST Covers**

CST Industries  
9701 Renner Boulevard - Suite 150  
Lenexa  
Kansas  
66219  
USA  
Contact: Mr Tony Thill  
Job Title: Corporate Vice President  
T: + 1 913 748 4559  
F: + 1 913 621 2145  
E: tthill@cstindustries.com  
W: www.cstcovers.com  
Producers of corrosion-resistant aluminum dome storage facilities...over 8,000 domes have been completed in spans from 8m to over 135m world wide.

**CST Storage**

9701 Renner Blvd, Suite 150  
Lenexa  
KS  
66110-2907  
USA  
Contact: Mr David Wheat  
Job Title: Director  
T: + 1 913 621 3700  
F: + 1 913 621 2145  
E: sales@cst-storage.com  
W: www.cstindustries.com  
Leading manufacturer of bolted and factory welded silos for dry bulk storage. Each silo, large or small, is individually engineered for its application. Custom engineering enables the selection of drive-through skirts, speciality hoppers, spread legs, passive flow control devices, tanks on load cells, peripheral conveyor supports, internal blending and interior maintenance platforms.

**CTI Group Inc**

Amman Regional Office  
Shmaisani, Layla Al-Akhyalieh  
Street  
Adli Commerical Center, 5th Floor  
P.O.BOX (7676)  
Amman 11118  
Jordan  
Contact: Mr Nidal Mihyar  
Job Title: Senior Vice President  
Commercial  
T: + 962 6 5885 115  
F: + 962 6 5676 939  
E: nmihyar@cti-grp.com  
W: www.cti-grp.com  
Established in 1990, our success has been achieved by hard work, professionalism, integrity, and long-term global partnerships. Current involvement includes: - Cement and Clinker Trading - Product Handling - Land and Sea Transportation - Terminal Construction and Operation (Shore or Floating) - Ship Owning and Ship Operating - Ship Management - Chartering

**CTP Team Srl**

Via Santa Maria in Campo, 1  
Cavenago di Brianza  
Milano 20040  
Italy  
Contact: Mr Antonio Zocche  
Job Title: Sales Director  
T: + 39 04 9766 3100  
F: + 39 04 9884 8006  
E: info@ctp.mi.it  
CTP Team, a Bedeschi Company, is a leading provider of gas cleaning and dedusting equipment and services, including filtration systems, electrostatic precipitators, heat exchangers and conditioning upgrades and turnkey projects.

**Cullen Grummitt & Roe**

126 Wickham Street  
Fortitude Valley  
Queensland  
QLD 4006  
Australia  
Contact: Mr Marco Necchi  
T: + 61 7 3252 8400 / +61 39 533 3208  
F: + 61 7 3252 5775  
E: cgrqld@cgrgroup.com  
W: www.cgrgroup.com  
Established in Brisbane, Australia in 1924 and provides consulting engineering services in the fields of civil and structural engineering, specialising in ports and harbour facilities, cold storage and mining infrastructure.

**Custom Equipment Design, Inc.**

1057 Highway 80 E  
Monroe  
LA  
71203  
USA  
Contact: Mr Fred H Moore  
Job Title: Sales Manager  
T: + 1 318 345 2222  
F: + 1 318 343 0452  
E: fmoore@cedpackaging.com  
W: www.cedpackaging.com  
Manufactures and distributes dry semi bulk packaging systems for bulk bags (FIBC), drums, and big boxes. Associated equipment such as bulk bag (FIBC) Unloaders, Drum Dumpers, Pallet dispensers, conveyors and turntable conveyors are integrated together in systems complete with PLC Controllers or as independent stand alone components.

**Cygnus Instruments Limited**

Cygnus House  
30 Prince of Wales Road  
Dorchester  
Dorset  
DT1 1PW  
UK  
Contact: Mr Graham Haines  
Job Title: Sales Director  
T: + 44 1305 265533  
F: + 44 1305 269960  
E: sales@cygnus-instruments.com  
W: www.cygnus-instruments.com/  
Cygnus Instruments Ltd manufactures an ultrasonic hatch cover leak detector, Cygnus Hatch Sure, for testing weather tightness of cargo hatch covers. The equipment provides a quick and effective method of evaluating hatch seals and aiding the prevention of sea water ingress.

**Dalian Huarui Heavy Industry Group Co. Ltd**

No169 Bayi Road  
Dalian  
Liaoning  
China  
Contact: Mrs Yuli  
T: + 86 411 86852376  
F: + 86 411 86852398  
E: gmgs@dhdicw.com  
W: www.dhdicw.com.cn  
Dalian Huarui Heavy Industry Group Co., Ltd. (DHHI) is the holding subsidiary company of DHI-DCW Group, and the large and key leading enterprise in the heavy industry in China with leading products port machinery, hosting machinery, bulk materials handling machinery.

**Dantherm Filtration Ltd**

Limewood Approach  
Seacroft  
Leeds LS14 1NG  
UK  
Contact: Ms Karolina Szymanska  
T: + 44 113 2739 461  
F: + 44 113 265 0735  
E: kabo@danthermfiltration.com  
W: www.danthermfiltration.co.uk  
Dantherm Filtration designs, manufactures installs and services dust and fume extraction equipment worldwide, with production centres throughout Europe, in USA, Thailand and China. Installations include extraction for dockside hoppers, ship unloaders, conveying storage and outloading facilities. Filters, cyclones, silos, fans, discharge devices. ISO9001:2008, ATEX EN13980:2002.

**David Osborne Engineering Ltd**

The Limes Barn  
Little Everdon  
Daventry  
Northamptonshire  
NN11 3BG  
UK  
Contact: Mr David Osborne  
T: + 44 1327 361010  
F: + 44 7043 075176  
E: david@doeng.co.uk  
W: www.doengineering.co.uk  
David Osborne Engineering Ltd was formerly ThyssenKrupp Materials Handling Ltd. Following a management buyout in 2008 they now represent ThyssenKrupp Fördertechnik for the UK and Ireland markets looking after mining, processing and bulk materials handling plants, systems and equipment as well as spare parts, repairs and refurbishment projects.

**DAWSON**

7DE, Huaran Building  
No. 2 Shandong Rd  
Qingdao  
China  
Contact: Ms Janet  
T: + 86 532 8666 0581  
E: info@dawson-group.com  
W: http://www.dawson-group.com

**DBIS (Software and Automation) Ltd**

9 Station Road  
Adwick-le-Street  
Doncaster  
South Yorkshire  
DN6 7BB  
UK  
Contact: Mr David Trueman  
Job Title: Sales Director  
T: + 44 1302 330 888  
F: + 44 1302 724 731  
E: david.trueman@dbis.biz  
W: www.dbis.biz  
DBIS provide bulk and break bulk terminals with optimal management software solutions.

**DCC Grabs**

Markerkant 14-30  
Almere  
Flevoland  
1314AS  
The Netherlands  
Contact: Mr Rudy van Leeuwen  
Job Title: Director  
T: + 31 73 - 640 41 11  
F: + 31 36 529 85 94  
E: Info@dcc-grabs.nl  
W: www.dcc-grabs.nl  
DCC-Grabs designs, develops and manufactures grabs for the dry bulk cargo-, dredging- and recycling industry. DCC's main objective is to ensure that their grabs underscore added value for the client. Innovative design and product development are guaranteed at DCC-Grabs.

**DCL, Incorporated**

PO Box 125  
Charlevoix  
MI  
49720  
USA  
Contact: Mr Kyle Smith  
T: + 1 231 547 5600 Ext 3124  
F: + 1 231 547 3343  
E: sales@dclinc.com  
W: www.dclinc.com  
DCL provides full dust control loading systems as well as partial components to the bulk material handling industry. Seasoned veterans in Technical Sales, Engineering and Manufacturing give DCL the capabilities of designing custom equipment to meet and understand all field applications. Product lines include Loading Spouts, Dust Collectors, Gates, Valves, and Air Conveyors.

**DCW Group Co**

350 Zhong Nan Road  
Zhongshan District  
Dalian  
116022  
China  
Contact: Mr Lu Kaili  
T: + 86 411 289 3900  
F: + 86 411 289 1756  
E: info@dalian-gov.net  
Manufactures specialist 'Deadfall Discharge' ship loading systems fitted with dust control equipment, plugged spout relief doors and no moving parts.

**De Regt Conveyor Systems**

Ijzendijkseweg 5  
Bievlief  
Zeeland  
4521 GX  
The Netherlands  
Contact: Mr Peter De Regt  
Job Title: Director  
T: + 31 115 481238  
F: + 31 115 481234  
E: peter@deregt.com  
W: www.deregt.com  
De Regt is a company specialized in developing, building and installing conveyor systems and structures needed to achieve a partial or total project.

**Dearborn MidWest Conveyor Co.**

8245 Nieman Road  
Lenexa  
Kansas  
66214  
USA  
Contact: Mr Sudy L Vohra  
Job Title: Executive Vice President & General Manager  
T: + 1 913 261 2406  
F: + 1 913 261 2470  
E: sudyv@dmwcc.com  
W: www.dmwcc.com  
Manufacturer of turnkey Bulk Materials Handling Systems for Terminals, Power Plants, Mines, Cement Plants, Iron Oxide and DRI handling. Latest products include Pipe Conveyors, Curved Conveyors Stackers And Reclaimers including Travelling Rotary Plow Feeders under piles and for Silo Reclaim Systems. Other Equipment includes Trippers, Belt Feeders and Telescopic Chutes. Complete materials handling for Gassification projects.

**Demag Cranes & Components GmbH**

Benefit recipient: Gottwald Port Technology  
Forststrasse 16  
Düsseldorf  
D-40597  
Germany  
Contact: Mr Reiner Derhardt  
Job Title: Project Manager  
T: + 49 2335 92 7442  
F: + 49 2335 92 3812  
E: reiner.derhardt@demagcranes.com  
W: www.demagcranes-ag.com  
Demag Cranes & Components GmbH - a subsidiary of Demag Cranes AG - is a supplier of industrial cranes and crane components for material flow, logistics and industrial drive applications. It also offers spare parts, maintenance and refurbishment services. Represented globally by approxi 5,000 employees in 22 foreign subsidiaries and agencies in 46 countries. With more than 650,000 Demag brand cranes and hoists for industrial applications in operation, the company has the largest installed base worldwide.

**DeMarco Industrial Vacuum Corporation**

PO Box 1138  
Crystal Lake  
IL  
60039-1138  
USA  
Contact: Mr Thomas DeMarco  
Job Title: President  
T: + 1 815 344 2222  
F: + 1 815 344 2223  
E: Sales@DeMarcoVacuums.com  
W: www.DeMarcoVacuums.com



**DOMTEC**<sup>®</sup>  
International

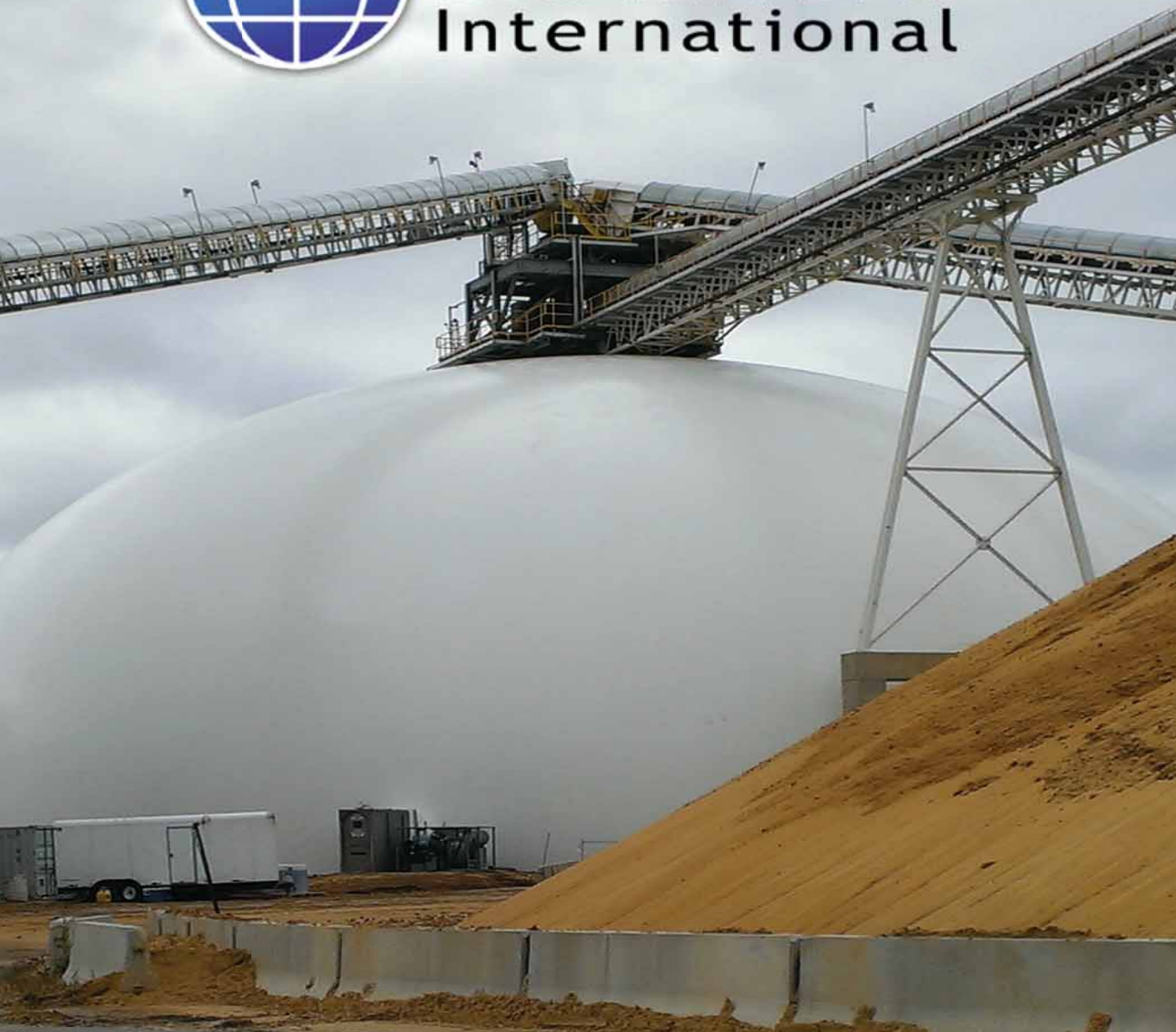

**WORLD-CLASS BULK STORAGE**

**DOMES**





Manufacturers of MAX VAC industrial vacuuming and pneumatic conveying systems for the worldwide bulk handling industry. 5-300 hp.

**DemcoTECH Engineering**

Modderhouse  
 Moddercrest Office Park  
 1 High Street  
 Modderfontein  
 Gauteng  
 1645  
 South Africa  
 Contact: Mr Paul van de Vyver  
 Job Title: General Manager  
 T: + 27 11 608 4355  
 F: + 27 11 608 4251  
 E: info@DemcoTECH.com  
 W: www.demcotech.com  
 DemcoTECH specialises in Bulk Material Handling and Conveyor Design, Niche Process Plants and Engineering Project Management. Servicing the Power Generation, Cement, Mining, Metallurgical, Food, Manufacturing and Port Industries. Providing the full range of services from Conceptual

Design, through Feasibility Studies, Design, Engineering, Procurement, Expediting, Construction, Commissioning and After Sales Support.

**Dinnissen BV**

Horsterweg 66  
 Sevenum  
 NL-5975 NB  
 The Netherlands  
 Contact: Mr Henri A J M Michiels  
 Job Title: Director  
 T: + 31 77 467 35 55  
 F: + 31 77 467 37 85  
 E: powtech@dinnissen.nl  
 W: www.dinnissen.nl  
 Specialising in bulk transfer equipment. Product range includes batch weigh systems for powders, big bag emptying stations, big bag filling lines, powder mixers.

**DMN-WESTINGHOUSE**

Gieterij 3  
 PO Box 6  
 Noordwijkerhout  
 Zuid-Holland

NL-2210 AA  
 The Netherlands  
 Contact: Mrs Tonneke Krempel  
 Job Title: Manager Marketing Services and PR  
 T: + 31 252 361 800  
 F: + 31 252 375 934  
 E: dmn@dmn-nwh.nl  
 W: www.dmnwestinghouse.com  
 Design and manufacture of rotary valves, diverters and other components for the bulk solids handling industry. Besides an extensive range of standard versions, DMN-Westinghouse supply components that are pressure shock resistant to 10 bar, flame proof or ATEX compliant to Directive 94/9/EC.

**Dome Corp of North America**

5450 East Street  
 Saginaw  
 Michigan  
 48601  
 USA  
 Contact: Mr Ross Lane  
 Job Title: President  
 T: + 1 989 777 2050

F: + 1 517 777 3477  
 E: sales@dome-corp-na.com  
 W: www.dome-corp-na.com

**Dome Technology**

3007 East 49th Street North  
 Idaho Falls  
 Idaho  
 83401  
 USA  
 Contact: Mr Lane Roberts  
 Job Title: Sales Manager  
 T: + 1 208 533 6669  
 F: + 1 208 529 0854  
 E: lane@dometech.com  
 W: www.dometech.com  
 Provides a design build solution for all bulk storage products, for both industrial and commercial applications. We design reclaim tunnels, analyze and recommend deep foundation and soil solutions, material handling systems and coordination with the owner's engineers and suppliers. Products commonly stored include fertilizer, cement, clinker, gypsum, fly ash, coal, alumina, grains and mining

ores. Inventors of the insulated thin shell concrete dome.

**DOMTEC International LLC**



4355 N Haroldsen Drive  
 Idaho Falls  
 Idaho  
 83401  
 USA  
 Contact: Mr Mike Hunter  
 Job Title: General Manager  
 T: + 1 208 522 5520  
 F: + 1 208 522 5344  
 E: domtec@domtec.com  
 W: www.domtec.com  
 Design and constructs concrete domes to store a multitude of products. Projects are delivered on time and within budget. Broad experience with a variety of reclaim systems, both mechanical and pneumatic, depending on clients' needs.

# Bulk material handling systems engineered to meet your needs

**EMS-Tech Inc.** has built a global reputation for providing world-class engineering while cooperatively working with owners, consultants and major suppliers. Our team of engineers are experts in the engineering, design, manufacturing and management of custom designed bulk material handling equipment including self-unloading ship systems, shiploaders, stacker-reclaimers and large transshipment systems.



**For the most efficient bulk handling systems.**

[www.ems-techinc.com](http://www.ems-techinc.com)



mobile equipment and bulk material handling systems

**Canada - Head Office**  
Tel: +1 613 966 6611  
Fax: +1 613 966 6710  
Email: [ems-tech@ems-tech.net](mailto:ems-tech@ems-tech.net)

**The Netherlands**  
Tel: +31 251 291 340  
Fax: +31 251 291 344  
Email: [ems-europe@ems-tech.net](mailto:ems-europe@ems-tech.net)

**United States**  
Tel: +1 910 251 0380  
Fax: +1 910 251 0780  
Email: [ems-int@ems-tech.net](mailto:ems-int@ems-tech.net)

**China**  
Tel: +86 510 8270 5245  
Fax: +86 510 8270 5245  
Email: [ems-china@ems-tech.net](mailto:ems-china@ems-tech.net)



## Don Valley Engineering Co Ltd

Sandall Stones Road  
Doncaster  
DN3 1QR  
UK  
Contact: Mr Roger Allen  
Job Title: Managing Director  
T: + 44 1302 881188  
F: + 44 1302 881000  
E: sales@donvalleyeng.com  
W: www.donvalleyeng.com  
Over 60 years of experience in all aspects of engineering, particularly the processing and handling of bulk materials, and the building of specialist screening, centrifuging and malting plant equipment. We are UK and global leaders in our fields, and a preferred supplier to all major producers and users of minerals, iron and steel, coal, sugar, polish and more.

## Donaldson Filtration (GB) Ltd

Humberstone Lane  
Thurmaston  
Leicester  
LE4 8HP  
UK  
Contact: Mr Geoff Hodgson  
Job Title: Territory Manager  
T: + 44 116 269 6161  
F: + 44 116 269 3028  
E: IAF-uk@donaldson.com  
W: www.donaldson.com  
Donaldson is a leading worldwide provider of filtration systems that improve people's lives, enhance our Customers' equipment performance, and protect our environment. We are a technology-driven company committed to satisfying our Customers' needs for filtration solutions through innovative research and development, application expertise, and global presence.

## Donaldson Filtration Deutschland GmbH

Büssingstraße 1  
Haan  
42781  
Germany

Contact: Mrs Susanne Fulko  
Job Title: Marketing Manager  
T: + 49 21 29 569 0  
F: + 49 21 29 569 100  
E: IAF-de@donaldson.com  
W: www.DonaldsonToritDCE.com  
Donaldson is a leading worldwide provider of filtration systems that improve people's lives, enhance our Customers' equipment performance, and protect our environment. We are committed to satisfying our Customers' needs for filtration solutions through innovative research and development, application expertise, and global presence.

## Doosan Benelux SA

Drève Richelle 167  
Waterloo  
B-1410  
Belgium  
Contact: Ms Nancy De Sy  
Job Title: Corporate and Public  
Communication Manager  
T: + 32 2 371 6811  
F: + 32 2 371 6900  
E: nancy.desy@doosan.com  
W: www.bobcat.eu;  
www.doosanequipment.eu  
Skid-steer loaders, compact tracked loaders; wheel loaders; excavators; rigid-frame and rotary telehandlers; attachments.

## Doppelmayr Transport Technology GmbH

Holzriedstrasse 29  
Wolfurt  
6922  
Austria  
Contact: Mrs Stefanie Reis  
T: + 43 5574 604 1206  
F: + 43 5574 604 1209  
E: dti@doppelmayr.com  
W: www.doppelmayr-mts.com  
Doppelmayr Transport Technology solves all transport issues in the field of bulk materials and unit loads with a range of sophisticated material transport systems - from well-proven material ropeways to innovative long-distance conveyor

systems for high capacities.

## Dos Santos International, LLC

531 Roselane Street  
Suite 810  
Marietta  
Georgia  
30060  
USA  
Contact: Mrs Amy D. Duncan  
Job Title: Marketing Manager  
T: + 1 770 423 9895  
F: + 1 866 473 2252  
E: info@dossantosintl.com  
W: www.dossantosintl.com  
Materials handling and engineering specialists specialising in high-angle conveyors. We offer the DSI Snake Sandwich conveyor, the most reliable and economical solution for your high-angle and vertical, high tonnage requirements. Additionally we offer high-tech solutions. Our in-house proprietary software facilitates complete analysis of the most complicated conveying systems.

## Dosco Overseas Engineering Ltd

Ollerton Road  
Tuxford  
Newark  
Nottinghamshire  
NG22 0PQ  
UK  
Contact: Mr Phillip Adrych  
Job Title: Export Sales  
T: + 44 1777 870 621  
F: + 44 1777 871 580  
E: padrych@dosco.co.uk  
W: www.dosco.co.uk  
Manufacturers of an extensive range of pipe conveyors that transport materials in a totally enclosed environment eliminating any spillage and contamination of the surrounding area. Also manufactured are high torque, slow speed, twin roll crushers, incorporating picks or manganese teeth.

## Dosetec Exact Oy

Vaakatie 37  
Nastola  
15560  
Finland  
Contact: Mr Pertti Hännikainen  
T: + 358 3 871540  
F: + 358 3 8715410  
E: pertti.hannikainen@dosetec.fi  
W: www.dosetec.fi  
Dosing systems, sack filling and big bag FIBS filling system for food, chemical and building material industry.

## Doubrava Ges GmbH

Industriestrasse 17-20  
Atnang-Puchheim  
A-4600  
Austria  
Contact: Mr Dietmar Holezius  
T: + 43 7674 6010  
F: + 43 7674 601499  
E: office@doubrava.at  
W: www.doubrava.at  
Specialises in batching, weighing and mixing plants, classifying and dressing plants, plants for ready mixed plaster and concrete; mechanical conveyors and ship-to-shore conveying systems.

## Doyle Manufacturing Co

PO Box 3024  
Quincy  
Illinois  
62305  
USA  
Contact: Mr Monty Doyle  
T: + 1 217 222 1592  
F: + 1 217 223 3655  
E: doyle@doylemfg.com  
W: www.4doyle.com

## Draka Automotive GmbH

Dickestrasse 23  
Wuppertal  
42369  
Germany  
Contact: Mr Heribert Hoepfner  
T: + 49 20 22 960  
F: + 49 20 22 96 20 00  
E: automotive@draka.com

W: www.draka-automotive.com

## DRG Engineering

Srednegavansky 9-31  
Saint-Petersburg  
199226  
Russia  
Contact: Mrs Mescherikova  
Nadezda  
Job Title: Director  
T: + 7 812 740 7426  
F: + 7 812 740 7429  
E: vyukhnoe1@yahoo.com

## Dry Bulk Solutions

Moezel Weg 110  
Harbour 5596  
Europoort - Rotterdam  
Zuid-Holland  
3198 LS  
The Netherlands  
Contact: Mr Randy Groen  
Job Title: Technical & Commercial  
Manager  
T: + 31 181 250 050  
F: + 31 181 261 466  
E: r.groen@elivesto.com  
W: www.drybulksolutions.com  
Dry Bulk Solutions offer products such as steelwires with special grab operation developed end connections. Furthermore we supply the High Performance Unloader, a machine to ease the tremming of rafters and stairs. Main benefit for our customers is cost reductions and safer work conditions!

## DS SM a/s

Sonderjyllands Maskinfabrik  
Vaerksvej 5  
Roedekro  
6230  
Denmark  
Contact: Mr Martin N Nielsen  
Job Title: Project Manager  
T: + 45 74 39 33 33  
F: + 45 74 39 33 39  
E: mani@ds-sm.dk  
W: www.ds-sm.dk  
Manufactures conveyor plants for coal processing, including hoppers.



## DSH Systems Ltd.



PO Box 48052  
Blockhouse Bay  
Auckland  
Auckland  
0644  
New Zealand  
Contact: Mr Ian Walton  
Job Title: CEO  
T: + 64 275 999 592  
F: + 64 9828 8012  
E: [ian@dshsystems.com](mailto:ian@dshsystems.com)  
W: [www.dshsystems.com](http://www.dshsystems.com)  
DSH Systems produce unique loading spouts for dry, granular, free-running goods. Dust is contained within a tight solid column through free air into any target repository. The DSH System requires no utilities, has no internal moving parts and provides Health & Safety, Environmental and commercial benefits.

## Dulevo International S.p.A.

Via Giovannino Guareschi 1  
Fontanellato  
Parma  
43012  
Italy  
Contact: Mr Stefano Battistini  
T: + 39 0521 827733  
E: [info@dulevo.com](mailto:info@dulevo.com)  
W: [www.dulevo.com](http://www.dulevo.com)

## Dunlop Conveyor Belting

Oliemolenstraat 2  
PO Box 14  
Drachten  
9200 AA  
The Netherlands

Contact: Mr Andries Smilda  
Job Title: Sales & Marketing Director  
T: + 31 512 585 446  
F: + 31 512 585 433  
E: [marketing.drachten@dunlopconveyorbelting.com](mailto:marketing.drachten@dunlopconveyorbelting.com)  
W: [www.dunlopconveyorbelting.com](http://www.dunlopconveyorbelting.com)  
Dunlop have both the largest range and biggest stock of cargo handling belts. The range includes belts with outstanding qualities of abrasion, tear and impact resistance. The unique Dunlop EBS closed conveyor belting system allows flexible routing and excellent dust control. Unrivalled technical support, 24 hour helpline + 31 620 498831.

## DURO FELGUERA, S.A.

Centro de Ingenieria,  
Parque Científico y Tecnológico de Gijón  
c/ Ada Byron, 90  
Gijón  
Asturias  
33203  
Spain

Contact: Mr Angel Pelegrí  
Job Title: Sales Director - DF Mining and Handling  
T: + 34 985 199 201  
F: + 34 985 199 059  
E: [dfmh@durofelguera.com](mailto:dfmh@durofelguera.com)  
W: [www.dfdurofelguera.com](http://www.dfdurofelguera.com)  
A one hundred-year-old company specialised in turn-key projects for the bulk handling sector. Its great experience enables the company to develop state of the art designs and achieve high performance as well as run all the projects based on environmentally friendly solutions and competitive costs.

## Dust Control Technology



1607 W. Chanute Rd.  
Peoria  
IL  
61615  
USA  
Contact: Mr Rick Felde  
Job Title: Marketing Manager  
T: + 1 309 693 8600  
F: + 1 309 693 8605  
E: [rickf@dustboss.com](mailto:rickf@dustboss.com)  
W: [www.dustboss.com](http://www.dustboss.com)  
DustBoss® dust suppression equipment combines an oscillating ducted fan with proprietary atomized misting technology to create a powerful, yet customizable dust control tool. DCT delivers superior results by specializing in open-area dust management. Largest model can blanket 280,000 SF (26,000 SM) with millions of droplets optimized for trapping dust particles.

## Dust Solutions Inc.

14300 N.E. 20th Ave.  
D102-185  
Vancouver  
Washington  
98686  
USA  
Contact: Mr David Gilroy  
Job Title: Sales Manager  
T: + 1 360 546 0072  
F: + 1 360 546 0073  
E: [d.gilroy@nodust.com](mailto:d.gilroy@nodust.com)  
W: [www.nodust.com](http://www.nodust.com)  
D.S.I manufactures Dry Fog Dust Suppression Systems. For ship loaders/unloaders, conveyor transfer points, truck & rail dump/fill stations, feeders & crushers.



Modular System, No Chemicals, No Product Wetting, No Freezing. Ideal for Coal, Coke, Copper & Iron Ore, Woodchips, Cement, Clinker. DustTamer™ Wind Fence Systems to protect storage piles/load points.

## E-Crane World Wide



Koekoeklaan 53  
Adegem  
B-9991  
Belgium  
Contact: Mr Bas Tolhuizen  
Job Title: International Sales Manager  
T: + 31 165 320100  
F: + 31 165 320759  
E: [bas.tolhuizen@e-crane.com](mailto:bas.tolhuizen@e-crane.com)  
W: [www.e-crane.com](http://www.e-crane.com)  
E-Crane® Worldwide designs and builds high volume bulk material and scrap handling balance cranes ideal for (un)loading barges and seagoing vessels in the most economical way.

## E-Crane World Wide / E-Crane International USA



1332 Freese Works Place  
Galion  
Ohio  
44833  
USA  
Contact: Mr Mark W Osborne  
Job Title: President  
T: + 1 419 468 0090  
F: + 1 419 468 0074  
E: [mark.osborne@e-crane.com](mailto:mark.osborne@e-crane.com)  
W: [www.e-crane-usa.com](http://www.e-crane-usa.com)  
Hydraulic, balanced, bulk material handling cranes from 5.5 to 43 tons, 19 meters to 45 meters reach. ECI imports, markets and supports the E-Crane in the Americas. ECI offers complete material handling solutions including the E-Crane.

## E-Crane Worldwide-Indusign NV



Koekoeklaan 53  
Adegem B-9991  
Belgium  
Contact: Mr Lieven Bauwens  
Job Title: Managing Director  
T: + 32 9378 0444  
F: + 32 9378 0645  
E: [lieven.bauwens@indusign.be](mailto:lieven.bauwens@indusign.be)  
W: [www.e-crane.com](http://www.e-crane.com)  
E-Crane® Worldwide provides design services as well as complete machine production, erection, support, and training with on-going service for the heavy equipment industry. E-Crane® is a modern, state-of-the-art engineering and heavy equipment construction company, located at Adegem, Belgium. E-Crane® is the world leader for large scrap handling machines with an outreach from 24 to 50 meters

## EGS Eurocargo Services AS

Tongavej 19  
Århus C, DK-8000  
Denmark  
Contact: Mr Peterson  
T: + 45 86 20 82 20  
E: [ecs@eurocargoservices.dk](mailto:ecs@eurocargoservices.dk)  
W: [www.eurocargoservices.dk](http://www.eurocargoservices.dk)

## Edge Innovate



30 Farlow Road  
Newmills  
Dungannon  
Tyrone BT71 4DT  
Northern Ireland  
Contact: Mr Lee Williamson  
Job Title: Sales Manager  
T: + 44 288 774 0525  
F: + 44 288 774 7244  
E: [lee@edgeinnovate.com](mailto:lee@edgeinnovate.com)  
W: [www.edgeinnovate.com](http://www.edgeinnovate.com)  
Edge Innovate are a blue sky thinking, imaginative and creative equipment manufacturing company. With our ethos of "Innovation at Work" EDGE persist in pushing the boundaries of design and manufacturing to produce hard working, quality machinery to fit any materials handling requirement from recycling, material handling to quarrying.

## DSH SYSTEMS – WE CARE ABOUT YOUR AIR!

Solve the world-wide industrial material handling problem – dust fallout while transferring dry, granular goods.  
At the loading point, the DSH System concentrates the discharge of dry goods as a solid column through free air into any target repository including trucks, rail wagons, storage containers, ships and barges, bags or stockpiles.  
The standard DSH Dust Suppression System uses no utilities and has no internal moving parts. PFC (computer controlled) model available.  
Winner (joint) of the Inaugural Innovative Technology Award at BulkEx 2006.  
Winner of the Dust Control Technology "Application or Practice" at BulkEx 2007.  
The DSH System gives you:

- Cleaner, safer working environments
- Dust explosion risk mitigation
- Reduced maintenance, cleaning and dust handling
- Faster, continuous, cleaner loading
- Enables operation in closer proximity to urban areas
- Reduced product shrinkage.
- Reduced environmental agency concerns

Clients include companies handling fertilizers, grains, stock-foods, salt, sugar, sand, etc in Australasia, USA, Canada, South Africa, South America, and France.



ENQUIRIES  
**DSH SYSTEMS LTD**  
E: [info@dshsystems.com](mailto:info@dshsystems.com)  
T: +64 (0) 9 828 8012  
W: [www.dshsystems.com](http://www.dshsystems.com)





**IEFFEL Etablissement SOMDEL**

80 bis rue Jean Jaurès  
 Quievrechain F-59920  
 France  
 Contact: Mr Gérard Pellet  
 Job Title: (see ed notes)  
 T: + 33 32 714 1516  
 F: + 33 32 714 1515  
 E: contact.somdel.eiffel@eiffage.com  
 W: www.eiffel.fr  
 Specialised in the provision of tailor made lifting and handling equipment. The range of products extends from EOT for steel plants, nuclear power plants and gantry cranes to ship loaders, ship unloaders, stackers and reclaimers, conveying systems and turnkey installations.

**Elecon Engineering Company Ltd**

Post Box # 6  
 Anand Sojitra Road  
 Vallabh Vidyanagar  
 Gujarat 388 120  
 India  
 Contact: Mr H S Patel  
 Job Title: General Manager  
 (Projects & Marketing)  
 T: + 91 2692 237016 / 227131  
 F: + 91 2692 236457  
 E: hspatel@mhe.elecon.com  
 W: www.elecon.com  
 Elecon since established in 1951, apart from Power Transmission Products, provides engineered solutions, manufactures and supplies Bulk Material Handling Plants, Stockyard Equipments and Pipe Conveyor for the core sector industries which include power, steel, cement, fertilizer, port mechanisation and open cast mines in India and abroad.

**Elecon Singapore PTE Ltd.**

10, Anson Road  
 #24-03  
 International Plaza  
 Singapore 079903  
 Singapore  
 Contact: Mr Keyur Parikh  
 Job Title: Director - VP  
 T: + 65 6227 8258  
 F: + 65 6227 8942  
 E: keyur@singapore.elecon.com  
 W: www.elecon.com

**Electro-Motive Diesel (EMD)**

9301 West 55th Street  
 La Grange, IL 60525  
 USA  
 Contact: Mr Scott Garmin  
 T: + 1 708 387 3938

F: + 1 708 387 6626  
 E: frank.w.ward@EMDiesels.com  
 W: www.EMDiesels.com

**Elgin Engineering and Construction**

Suite 1800  
 222 South Riverside Plaza  
 Chicago  
 Illinois 60606  
 USA  
 Contact: Mr Bob Williams  
 Job Title: Marketing Director  
 T: + 1 312 236 8100 ext: 340  
 F: + 1 312 726 2872  
 E: soros@elginindustries.com  
 W: www.elginindustries.com  
 Designs, rehabilitates and upgrades port and harbour facilities, bulk and general cargo handling systems and equipment.

**Emaq-Verolme Estaleiros SA**

Rua Quatis 426  
 426 liha do Governador  
 Rio de Janeiro, RJ 21920  
 Brazil  
 Contact: Mr I Fonseca  
 Job Title: Sales Dept

T: + 55 21 392 8029  
 F: + 55 21 396 4126

**EMDE INDUSTRIE-TECHNIK**

PO Box 1339 Koppelheck  
 Nassau-Lahn 56377  
 Germany  
 Contact: Mr Hansjürg Emde  
 Job Title: Managing Director  
 T: + 49 2604 97030  
 F: + 49 2604 970333  
 E: info@emde.de  
 W: www.emde.de  
 Produces a wide range of material handling systems, including control systems, process automation equipment and FIBC emptying and filling equipment.

**EMS-TECH Inc**



699 Dundas Street West  
 Belleville  
 Ontario K8N 4Z2  
 Canada

Contact: Ms Gail Carl  
 Job Title: Executive Assistant,  
 Sales & Marketing  
 T: + 1 613 966 6611  
 F: + 1 613 966 6710  
 E: sales@ems-tech.net  
 W: www.ems-techinc.com  
 A multi-task, multi-discipline company specialising in design and supply of dry bulk material handling equipment, both mobile and stationary; including custom designed conveyors; elevators; receiving hoppers; storage/loadout systems; environmental controls; shiploaders; stackers and reclaimers; self-unloading ships.

**EMS-TECH Inc.**

Robijnstraat 92  
 Alkmaar 1812RB  
 The Netherlands  
 Contact: Mr Luke Huitema  
 T: + 31 251 291 340  
 F: + 31 251 291 344  
 E: europe@ems-tech.net  
 W: www.ems-techinc.com  
 A Multi-task, multi-discipline

company specializing in design and supply of dry bulk material handling equipment, both mobile and stationary; including conveyors, belt elevators, receiving hoppers, storage/loadout systems, environmental controls, shiploaders, stackers and reclaimers, self-unloading ships.

**EMTICI Engineering Co Ltd**

68 Sarat Bose Road  
 Calcutta  
 West Bengal 700025  
 India  
 Contact: Mr D Sen  
 T: + 91 33 24761861  
 F: + 91 33 24761831  
 E: dsen@calemntici.elecon.com  
 W: www.elecon.com

**Enclosed Bulk Systems BV**

Wijkmeer Weg 72  
 Beverwijk  
 1948 NX  
 The Netherlands  
 Contact: Mr Van der Zee  
 T: +31 85 877 4026

**DB-100: WORLD'S LARGEST.  
 SIMPLY THE BEST.**  
 DIRECT DRIVE. LOW MAINTENANCE. MAXIMUM EFFECTIVENESS.



Cover up to 280,000 sq. ft. with a powerful, dust-trapping mist.



WWW.DUSTBOSS.COM

Call for details on our risk-free trial!

+1 309 693-8600 x181 | 800 707-2204 (U.S.)

Agents Welcome!



“E-Crane provided the crane with a custom modified barge and managed the entire project on a turn-key basis. We’re very pleased with the design and operating flexibility of the crane and have ordered a 2<sup>nd</sup> E-Crane for use at IMT.”

Fred Pope, Project Manager, KinderMorgan, USA

**E-CRANE**<sup>®</sup>  
EQUILIBRIUM  
*Worldwide*

[www.e-crane.com](http://www.e-crane.com)



E: info@enclosedbulk.nl  
W: www.enclosedbulk.com

## Enco Engineering Inc

4410 13th Street  
Wyandotte  
MI 48192  
USA  
Contact: Ms Bobbi Lang  
T: + 1 734 407 2400 x 202  
F: + 1 734 676 3436  
E: enco@encoeng.com  
W: www.encoeng.com

Specialises in the custom design of material handling systems to fit the unique characteristics of bulk material handling application. Experienced staff and engineering are dedicated in helping to meet the demands of an increasingly competitive world market.

## Endress + Hauser Inc

2350 Endress Place  
Greenwood  
IN 46143  
USA

Contact: Mr Victor Wolowec  
T: + 1 317 535 1410  
F: + 1 317 353 1481  
E: info@us.endress.com  
W: www.us.endress.com  
Offers process control devices and measurement systems for industrial applications including level, flow, pressure, tank gauging, temperature and liquid analysis.

## Engicon nv

Broelstraat 20  
Harelbeke

B-8530  
Belgium  
Contact: Mr Pieter Van Acker  
Job Title: Sales & Marketing  
Director  
T: + 32 56 73 21 21F: + 32 56 73 40 40

E: sales@geldof.be  
W: www.geldof.be  
Offers complete solutions in bulk handling systems. Product range includes silos with extraction systems, discharge hoppers, pressure vessels and storage tanks, conveyor belts, screw conveyors, chain conveyors, bucket elevators.

## Engineering System Solutions

4943 North 29th East, Suite A  
Idaho Falls  
ID 83401  
USA

Contact: Mr Jason South  
T: +1 208 552 9874  
F: +1 208 552 9302  
E: jason@es2eng.com

## Enso-Gutzeit Oy

Logistic Services  
PO Box 62-63  
Kotka  
48101  
Finland

Contact: Mr. Alexandre Nicolini  
Job Title: Senior VP Sales and Marketing  
T: + 358 2046 112  
F: + 358 2046 254 87  
E: vesa.sarkkinen@storaenso.com  
W: www.storaenso.com/

## Entecon UK Ltd

8 Lawrence Way  
Camberley  
Surrey  
GU15 3DL  
UK  
Contact: Mr Kees Wilschut  
Job Title: Managing Director  
T: + 44 1276 414 540  
F: + 44 1276 414 541  
E: entecon@entecon.co.uk  
W: www.entecon.co.uk

## Enviro Abrasion Resistant Engineers Pvt. Ltd

"ENVIRO HOUSE", Sector-27  
Plot No. F/12  
Near Sambhaji Chowk  
Pradhikaran  
Pune 411044  
India

Contact: Mr Milind Dixit  
T: + 91 20 27641757  
F: + 91 20 27650316  
E: info@enviroabrasion.com  
W: www.enviro-abrasion.com

## EPMC Europe BV

Nieuw Zeelandweg 20  
Amsterdam  
1045 AL  
The Netherlands

Contact: Mr Gerard Nijssen  
Job Title: Senior Sales Manager  
T: + 31 20 6069900  
E: g.nijssen@zpmceurope.com  
W: www.epmceurope.com  
European crane parts agent for ZPMC Shanghai. Service and maintenance harbour cranes.

## EQ Trade

Rijsdijk Equipment Trade BV  
Droogdweg  
Waalhaven Oostzijde 119  
Rotterdam  
BM  
3087  
The Netherlands  
Contact: Mr Kees Keetels  
T: + 31 62182 36 79  
F: + 31 10 487 3477  
E: keetels@eq-trade.com

## EQUIPO LLC

Salahudeen Road  
Dubai  
64624  
UAE  
Contact: Mr Mohamad Yasar Aboobacker  
Job Title: Operations & Sales Manager  
T: + 971 506 408 626  
F: + 971 426 822 17  
E: yasararafat@gmail.com  
W: www.equipo.ae

## Eriez Europe

Bedwas House Industrial Estate  
Bedwas  
Caerphilly  
CF83 8YG  
UK

Contact: Ms Sophie Comelli  
Job Title: Marketing Executive  
T: + 44 29 20 868 501  
F: + 44 29 20 851 314  
E: sophie.comelli@eriezeurope.co.uk  
W: www.eriez.com  
Magnetic separators (dry and wet process) for separation and recovery of ferrous and non-ferrous

metals, metal detectors (underbelt and aperture types as well as vertical feed/pipeline systems), automatic sampling systems for dry bulk materials and slurries, vibratory feeders for light bulk and heavy duty applications.

## ESI Eurosil BV



Newtonstraat 26-28  
Purmerend  
1446 VR  
The Netherlands  
Contact: Mr Jaap P J Ruijgrok  
Job Title: Managing Director  
T: + 31 299 630 730  
F: + 31 229 630 737  
E: esi@eurosilo.com  
W: www.eurosilo.com

Involved in the design, fabrication and installation of storage equipment and bulk materials handling systems, including the 'Eurosil' storage silo fitted with 'core-flow' and 'slotted column' reclaiming systems consisting of a rotating screw conveyor mounted on a central column.

## Eurorec Srl

Via Visano  
78/80 Isorella  
Brescia  
25010  
Italy  
Contact: Mr Ricardo Segala  
Job Title: Sales and Marketing  
T: + 39 030 9958 151

Newtonstraat 26-28  
P.O. Box 1047  
1440 BA Purmerend  
The Netherlands

Tel : +31(0) 299 - 630730  
Fax : +31(0) 299 - 630737  
E-mail : esi@eurosilo.com  
Web : www.eurosilo.com

ESI Eurosil,  
today's expert in  
bulk material storage



One Source



# High capacity unloading leading the way

DOCKSIDER™ pneumatic unloader – the most versatile and most advanced unloader in the world; designed to provide the performance you've come to expect from FLSmidth.

DOCKSIDER unloaders are custom designed to meet your specific terminal application. Exclusively developed for the ship and barge unloading industry, FLSmidth's state-of-the-art technology offers unequalled performance, reliability and durability.

Starting with a range of four basic sizes, FLSmidth can supply the right DOCKSIDER ship unloader for any terminal – whether you're unloading river barges or bulk vessels, and whether you're conveying to an adjacent belt conveyor or through a long pipeline.

Find out more at [www.flsmidth.com](http://www.flsmidth.com)

**FLSMIDTH**



F: + 39 030 995 2223  
E: sales@euromecsrfl.info  
W: www.euromecsrfl.com  
EUROMECS, born from the merger of companies Eurohydromec and Isomec, has years of experience in the material handling field and the production of products such as lifting equipment, electrohydraulic and mechanical grabs and buckets.

### Euro-tech Corporation

195 23rd. Street  
Pittsburgh  
PA  
15215  
USA  
Contact: Mr Richard W. Theobald  
T: + 1 412 782 0600  
F: + 1 412 782 6200  
E: sales@eurotechcorporation.com  
W: www.eurotechcorporation.com

### Euro-Tramco BV

Spacelab 47 D  
Amersfoort  
3824MR  
The Netherlands  
Contact: Mr Hans Plekpenpol  
T: + 31 33 4567033  
F: + 31 33 4558149  
E: hans@tramco-europe.com  
W: www.tramcoinc.com  
Manufactures chain, screw and bucket conveyors and 'Aerobelt' air-supported belt conveyor systems.

### F E Schulte Strathaus GmbH & Co KG

Runtestrasse 42  
Werl  
D-59457  
Germany  
Contact: Mr Andre Hanke  
T: + 49 2922 9775 0  
F: + 49 2922 9775 75  
E: ha@schulte-strathaus.de  
W: www.schulte-strathaus.de

### F L Smidth A/S

Vigerslev Alle 77  
Valby  
DK-2500  
Denmark  
Contact: Mrs Camilla Travis  
T: + 45 3618 1000  
F: + 45 3645 4427  
E: ctr@flsmidth.com  
W: www.flsmidth.com  
FLSmidth offers a portfolio of products and solutions to handle any type of bulk materials. Our full range of materials handling products includes complete crusher installations and silos, stackers/reclaimers and ship unloaders. We supply process design and equipment for all materials handling applications for the cement industry and related industries.

### Failure Control Ltd

Unit 4, Dunchideock Barton  
Biddypark Lane  
Dunchideock  
Exeter  
Devon  
EX2 9UA  
UK  
Contact: Dr Roger King  
Job Title: Managing Director  
T: + 44 1392 832883  
F: + 44 1392 692883  
E: roger.king@failurecontrol.com  
W: www.failurecontrol.com  
Specialist engineers undertaking failure investigations in the marine industries. Expert witness reports and technical assistance to loss adjusters, claims managers and

lawyers.

### Fairport Engineering

Market Place  
Adlington  
Lancashire  
PR7 2QP  
UK  
Contact: Mrs Linda White  
Job Title: Communications Manager  
T: + 44 1257 484000  
F: + 44 1257 483312  
E: info@airport.co.uk  
W: www.fairport.co.uk  
Produces a wide range of vibratory screw and belt conveyors for the food, coal and other industries.

### FAM Canada Inc

Bankers Hall West Tower  
1000, 888-3rd Street, SW  
Calgary  
Alberta  
T2P 5C5  
Canada  
Contact: Mr David Chomik  
T: + 1 403 444-5510  
F: + 1 403 444-6671  
E: melanie.miranda@famcanada.com  
W: www.fam.de/

### FAM Foerderanlagen Magdeburg

Sudenburger Wuhne 47  
Magdeburg  
D-39112  
Germany  
Contact: Mr Ulrich Schneider  
Job Title: Director Sales and Marketing  
T: + 49 391 6380 10 1 01  
F: + 49 391 6380 10 1 99  
E: sales@fam.de  
W: www.fam.de  
FAM Foerderanlagen Magdeburg is an independent company with the head office in Germany, with a long tradition as a manufacturer of materials handling systems.

### Famak SA

Machinery and Equipment  
Company  
Fabryczna Street 5  
Kluczbork  
PL 46-200  
Poland  
Contact: Mr Wojciech Staszak  
Job Title: President and CEO  
T: + 48 77 40 70 100  
F: + 48 77 418 15 45  
E: famak@famak.pl  
W: www.famak.pl  
Manufacturer of grabs & hooks cranes, stackers & reclaimers, portal scraper loaders and belt conveyors systems.

### Fantuzzi Reggiane S.p.a

Via Cisa Ligure 51/A  
Lentigione di Brescello (RE)  
42040  
Italy  
Contact: Mrs Rosanna Gennari  
Job Title: Marketing  
T: + 39 0522 5881  
F: + 39 0522 588243  
E: rgennari@fantuzzi.com  
W: www.fantuzzi.com  
Manufactures a wide range of port loading and unloading equipment, including mobile harbour cranes with maximum lifting capacities of up to 100 tonnes.

### FELD Maschinen-und Industriebau GmbH

Winkelfeld 3  
Oer-Erkenschwick  
D-45739  
Germany  
Contact: Mr Andre Stueckradt  
T: + 49 2368 98890  
F: + 49 2368 9889 27  
E: Andre.Stueckradt@Maschinenbau-Feld.de  
W: www.maschinenbau-feld.de

### FEMADIGIPACK S.r.l

Via San Giovanni Bosco, 60  
Bergamo  
Bergamo  
24126  
Italy  
Contact: Mr Tiengo Giorgio  
Job Title: General Manager  
T: + 39 036 391 0453  
F: + 39 036 390 2466  
E: commerciale@femadigipack.it  
W: www.femagroup.net  
Packing machines for cement and other materials in powder.

### Fenner Dunlop Conveyor Belting Europe

Marfleet  
Hull  
Yorkshire  
HU9 5RA  
UK  
Contact: Mr Jim Jones  
T: + 44 1482 785450  
F: + 44 1482 785438  
E: jim.jones@fennerdunlop.com  
W: www.fennerdunlop.com

### Fenner plc

Hesslewood Country Office Park  
Hessle  
East Yorks  
HU13 0PW  
UK  
Contact: Ms. Michelle Madden  
Job Title: Studio Manager  
T: + 44 1482 626 500 / 523  
F: + 44 1482 626522  
E: eprismuk@fenner.com  
W: www.fennerdunlop.com/

### Fiege Crane Services BV

PO Box 235  
Zaandam  
1500 EE  
The Netherlands  
Contact: Mr Mark Schinkel  
T: + 31 75 6810 413  
F: + 31 75 6315 996  
E: h.vantil@fiege.com  
W: www.kenz-fiege.com  
Merger of Kenz offshore cranes and Fiege harbour cranes.  
Founded in 1836, Fiege designs and manufactures a complete range of bulk handling cranes including the unique and well proven Lemniscate floating grab cranes with capacities from 16-50t, gantry grab unloaders, single- and double boom cranes, kangaroo cranes.

### Flexco

2525 Wisconsin Avenue  
Downers Grove  
IL  
60515-4200  
USA  
Contact: Ms Kelly Clancy  
Job Title: Public Relations Specialist  
T: + 1 630 971 0150  
F: + 1 630 971 1180  
E: kclancy@flexco.com  
W: www.flexco.com  
Flexible Steel Lacing Company

(Flexco), headquartered near Chicago IL/USA, provides the world's belt conveyors with efficient, safe products, services and solutions for mechanical splicing, slippage, belt tracking and cleaning. The company operates subsidiaries in California, Michigan, Mexico, England, Germany, Australia and South Africa. Their products are distributed under the brand names: Flexco Rockline, Mineline and Eliminator.

### Flexco Europe GmbH

Leidringer Strasse 40-42  
Rosenfeld  
D-72348  
Germany  
Contact: Mr Walther Sülze  
Job Title: Managing Director  
T: + 49 7428 94060  
F: + 49 7428 9406260  
E: europe@flexco.com  
W: www.flexco.com  
Mechanical belt fastening systems, installation tools, maintenance tools, ceramic lagging and cleaners.

### Flexicon Corporation

2400 Emrick Blvd  
Bethlehem  
PA  
18020-8006  
USA  
Contact:  
T: + 1 610 814 2400  
F: + 1 610 814 0600  
E: sales@flexicon.com  
W: http://www.flexicon.co.uk/

### Flexicon Europe Ltd

182 John Wilson Business Park  
Harvey Drive  
Whitstable  
Kent  
CT5 3RB  
UK  
Contact:  
T: + 441227 374710  
E: sales@flexicon.co.uk  
W: www.flexicon.co.uk

### Flexoveyor Conveyor

3795 Paris St., Unit D  
Denver  
Colorado  
80239  
USA  
Contact: Mr Bill Priday  
T: + 1 303 375 0200  
F: + 1 303 373 5149  
E: billpriday@conveyind.com  
W: www.flexoveyor.com

### Flomat Bagfilla International Limited

Fairport House  
28 Charles Street  
Higher Hillgate  
Stockport  
Cheshire  
SK1 3JR  
UK  
Contact: Mr Mal Sharpley  
Job Title: Group Sales Director  
T: + 44 161 477 4775  
F: + 44 161 474 0257  
E: msharpley@fpeglobal.co.uk  
W: www.fpeglobal.com  
As part of the FPE Global Group of Companies including Aeromaster (Aero-mechanical conveying specialists), NEU Solutions (Pneumatic conveying experts), Process Equipment and Site Operations, we can offer a variety of materials handling solutions.

### FLSmidth GmbH

Alfred Leiner Strasse 3  
Lanzendorf  
A-2326  
Austria  
Contact: Mr Patrick Schwarz  
T: + 49 6834 470 175  
F: + 43 2235 47568  
E: patrick.schwarz@flsmidth.com  
W: www.flsmidth.com  
Leading Pipe Conveyor Technology - More than 200 Pipe Conveyor installations worldwide.

### FLSmidth Inc.



2040 Avenue C  
Bethlehem  
PA  
18017-2188  
USA  
Contact: Mr David Bergenstock  
Job Title: Sales Manager  
T: + 1 610 264 6988  
F: + 1 610 264 6307  
E: david.bergenstock@flsmidth.com  
W: www.flsmidth.com  
FLSmidth specializes in terminal equipment for dry bulk products, primarily cement. In addition to ship and barge unloading/loading equipment we also specialize in pneumatic reclaim and transfer systems for storage silos and domes.

### FLSmidth Minerals Pvt. Ltd

FLSmidth House  
34 Egatour  
Kelambakkam  
Old Mahabalipuram Road  
Chennai  
Tamil Nadu  
603 103  
India  
Contact: Mr Sivalingam  
Santhakumar  
Job Title: Library  
T: + 91 44 47484795  
F: + 91 44 27470301  
E: indiainfo@flsmidth.com  
W: www.flsmidth.com

### FLSmidth Spokane, Inc.

605 E Holland Ave  
Suite 300  
Spokane  
WA  
99218  
USA  
Contact: Mr Dennis Medina  
Job Title: Sales and Marketing Manager  
T: + 1 509 467 0770  
F: + 1 509 466 0212  
E: Dennis.medina@flsmidth.com  
W: www.flsmidth.com  
Over 50 years in the bulk materials handling industry, providing solutions for some of the world's most complex materials handling problems. Designers of stackers; mobile, fixed and portable conveyors and stackers; and reclaiming systems with capacities from 200-10,000 metric tonnes per hour. Specialists in developing, designing and fabricating materials handling equipment for specific applications.



# One Source

# One Source many solutions

FLSmidth is the leading supplier to the global cement and minerals industries for equipment and services such as:

- Loading and unloading systems for bulk materials, packed goods and bags at inland ports and seaports
- Stackers/Reclaimers including unmanned & optimized operation
- Bucket-wheel boom machines
- Stockyard management systems (SYM™)
- Complete plant electrical, instrumentation & control systems
- KOCH Pipe Conveyor®
- Apron & Belt Feeders
- In-Pit Crushing & Conveying systems
- Silo systems and silo discharging systems
- Complete materials handling systems for the cement, minerals and power industries as well as harbours

**For more information, contact us at  
FLSmidth Material Handling**

Tel: +49 (0) 6834 470-0 • Fax: +49 (0) 6834 470-339  
wadgassen@flsmidth.com

[www.flsmidth.com](http://www.flsmidth.com)



**FLSMIDTH**



**FLSmith Wadgassen GmbH**

Karl-Koch-Strasse 1  
Wadgassen  
Saarländ  
66787

Germany  
Contact: Mr Matthias Schmidt  
Job Title: Sales Director EMENA  
T: + 49 6834 470 0  
F: + 49 6834 470 339  
E: wadgassen@flsmidth.com  
W: www.flsmidth.com  
FLSmith designs, manufactures, and services a broad range of materials handling equipment and systems for various industries, from minerals and cement to pulp and paper. Products include stacker/reclaimer systems, bulk material and bag loading and unloading systems for barges and ships, conveying solutions, including KOCH Pipe Conveyor®, and complete materials handling facilities.

**FMC Corporation**

PO Box 1370  
1 Link Belt Drive  
Tupelo  
MS  
38802  
USA

Contact: Mr Randy Webb  
T: + 1 507 243 3185  
F: + 1 601 869 7402  
W: www.fmc.com

**Fortum Power and Heat OY**

PO Box 1  
Fortum  
00048  
Finland

Contact: Ms Jonn Paakkonen  
Job Title: Marketing Manager  
T: + 358 10 4511  
F: + 358 10 45 24447  
E: communications@fortum.com

**FPS Mustang**

Filtermech Plant Sales Ltd  
Unit 6-2  
Seckar Wood Industrial Park  
Barnsley Road, Newmillerdam  
Wakefield  
WF2 6QW  
UK

Contact: Mr Mick Maxfield  
T: + 44 1924 252252  
F: + 44 1924 252565  
E: sales@fpsmustang.co.uk  
W: www.fpsmustang.co.uk  
Importers and distributors for Mustang Skid Steer Loaders and attachments for the UK and Ireland. Mustang Skid Steer Loaders are manufactured to industrial specifications and are ideal for use in arduous applications such as ship trimming and stevedore work.

**Frigate Technologies Private Limited**

Gr. Floor, No. 9,  
Block 5, Eros Garden  
Charmwood Village  
Surajkund Road  
Faridabad  
Haryana  
121 001  
India

Contact: Mr Ajay Hooda  
Job Title: Director (Marketing)  
T: + 91 129 4116470  
F: + 91 11 66173981  
E: office@frigateline.in  
W: www.frigateline.in

Frigate Technologies is a diversified global conglomerate providing integrated Design, Engineering, Procurement, Construction & Project Management Services in Aviation, Cement, Energy, Marine, Mineral Processing, Steel and other associated downstream sectors.

**Gama Endustri Tesisleri Imalat Ve Montaj AS**

Narcissus Street No: 9, 06 520  
Söğütözü  
Ankara  
06540  
Turkey  
Contact: Mr Mehmet Artun  
Job Title: General Manager  
T: + 90 312 248 42 00  
F: + 90 312 4094360  
E: industry@gama.com.tr  
W: www.gama.com.tr

**Gambarotta Gschwendt**

Viale Verona 200  
Trento  
38123  
Italy

Contact: Mr Luca Mastrococco & Christian Jezek  
Job Title: Sales Managers  
T: + 39 0461 920403  
F: + 39 0461 933391  
E: gambarotta@gambarotta.it  
W: www.gambarotta.it  
Designer and Manufacturer of Bucket Elevators, Apron Feeders, Truck Discharge Feeders, Stockpiles Reclaim Feeders, Steel Pan Conveyors, Chain Conveyors, Screw Conveyors, Bulk Unloader Chutes applicable for Cement, Coal, Mineral, Petrochemical and Power Plants Industries.

**Gantrex Inc.**

2000 Oxford Drive-Suite 400  
Pittsburgh  
PA  
PA 15102  
USA

Contact: Mr Tom Berringer  
Job Title: VP Sales & Marketing  
T: + 1 412 655 1400  
F: + 1 412 655 3814  
E: sales@gantrex.com  
W: www.gantrex.com/  
Gantrex provides solutions for rail mounted material handling systems including crane rail, rail clips and hydraulic bumpers. Call Toll Free at 1-800-242-6873 or visit www.Gantrex.com.

**Ganz Danubius Trading Co Ltd**

PO Box 1138  
Budapest  
H1325  
Hungary

Contact: Mr Karol Bayus  
Job Title: Director  
T: + 36 1 350 5570  
F: + 36 1 329 8041  
E: gdtco@hu.inter.net  
W: www.ganztrading.hu  
Manufactures shiploaders/unloaders, mechanical level luffing slewing harbour portal cranes 16-50 tonnes capacity, floating cranes 16-150 tonnes capacity, barges, river-seagoing vessels, steel construction for special shiploaders and unloaders, stackers/reclaimers, cranes.

**Garwood Consulting Ltd**

Garwood Lodge  
Wentworth  
Ely  
Cambridgeshire

CB6 3QG  
UK

Contact: Mr Barry Woodbine  
T: + 44 780 102 4583  
F: + 44 1353 777315  
E: barry@garwoodconsulting.com

**General Bridge Engineering Ltd**

PO Box 110  
Peterborough  
PE2 7ZZ  
UK

Contact: Mr Jack Wild  
T: + 44 1733 231207  
F: + 44 1733 231207  
E: sales@generalbridge.co.uk  
An engineering design consultancy for the materials handling, recycling and quarry industries. The chief activities are the design of bulk port handling and storage plus individual items designed for the quarry and recycling installations.

**General Kinematics Corp.**

5050 Rickert Rd.  
Crystal Lake  
IL 60014  
USA

Contact: Mr Thomas Musschoot  
T: + 1 815 455 3222  
F: + 1 815 455 2285  
E: tmusschoot@generalkinematics.com  
W: www.generalkinematics.com  
General Kinematics specializes in vibrating and rotary equipment and solutions for bulk processing of material in the foundry, recycling, scrap, mining, minerals, food, chemical, and wood industries. Each piece of GK equipment is custom engineered to your specifications to meet your process objectives.

**Genivar Inc**

1166 Laure Blvd  
Sept-Îles  
Quebec  
G4S 1C4  
Canada

Contact: Mr Denis Blouin  
Job Title: Regional Director  
T: + 1 418 962 2241  
F: + 1 418 962 3641  
E: info@genivar.com  
W: www.genivar.com

**Geométrica de México, S.A. de C.V.**

Puerto Vallarta # 801  
Colonia La Fé  
San Nicolás de los Garza  
N.L.,  
66477  
Mexico

Contact: Mr Cecilio Zalba  
Job Title: Sales Manager  
T: + 52 81 8882 8300  
F: + 52 81 8882 8301  
E: sales.mexico@geometrica.com  
W: www.geometrica.com/bulk-storage  
Specializes in design, manufacture and installation of long span bulk storage enclosures. Structures can be designed in circular, elliptical, longitudinal and free style configurations that can span distances up to 300m, with no intermediate supports. Galvanized steel/aluminum construction is easy to install, lightweight, strong and maintenance free with low fabrication and installation costs.

**Geometrica Inc**

12300 Dundee Court  
Suite 200  
Cypress  
Texas

77429  
USA

Contact: Mr Francisco Castaño  
Job Title: President  
T: + 1 832 220 1200  
F: + 1 832 482 0879

E: sales@geometrica.com  
W: www.geometrica.com  
Specializes in design, manufacture and installation of long span bulk storage enclosures. Structures can be designed in circular, elliptical, longitudinal and free style configurations that can span distances up to 300m, with no intermediate supports. Galvanized steel/aluminum construction is easy to install, lightweight, strong and maintenance free with low fabrication and installation costs.

**Geroldinger GmbH & Co KG**

Au-Strasse 9  
Sigharting  
A-4771  
Austria

Contact: Mr Walter Geroldinger  
Job Title: General Manager  
T: + 43 7766 24370  
F: + 43 7766 243724  
E: office@geroldinger.com  
W: www.geroldinger.com  
Specialises in design and installation of bulk handling systems and processes, including hoppers and storage silos.

**Gertech Handling Systems cc**

PO Box 4014  
Durbanville  
Cape Town  
Western Cape  
7551

South Africa  
Contact: Mr Gerrit De Hoog  
T: + 27 21 914 5333  
F: + 27 21 914 5666  
E: gdh@gertech.co.za  
W: www.gertech.co.za  
Design and manufacturing of handling and storage systems for bulk handling of dry materials. Steel Silos, mechanical conveyors and pneumatic conveying.

**GF MHS Srl**

Via Guido Rossa, 11  
Paderno Dugnano (MI)  
Milan  
20037  
Italy

Contact: Mr Francesco Tummillo  
Job Title: Managing Director  
T: + 39 0 2 91 08 20 02  
F: + 39 0 2 91 84 31 47  
E: info@gfmhs.it  
W: www.gfmhs.it  
.....we are your starting point of your project.

**GGT Goldengrain Trading SA**

Via Capelli 28  
Lugano  
6900  
Switzerland

Contact: Ms Cornelia Riep  
Job Title: Manager  
T: + 41 91 971 40 20  
F: + 41 91 971 40 21  
E: cgriep@ggt.ch

**Golden West Industries**

332 West Railroad Ave  
Price  
UT  
84501  
USA

Contact: Mr Ellis Pierce  
Job Title: Advertising  
T: + 1 435 637 3211  
F: + 1 435 637 6628

E: pwymny@gbis.com  
W: www.goldenwest-industries.com  
Golden West Industries provides dust suppression and freeze control products to the mining and material handling industries.

**Golfetto Sangati S.r.l.**

Via F.lli Bandiera, 3  
Quinto di Treviso tv Italy  
Quinto di Treviso  
TREVISO TV  
31055  
Italy

Contact: Mrs Monica Giantin  
T: + 39 0422 476700  
F: + 39 0422 476800  
E: info@golfettosangati.com  
W: www.golfettosangati.com  
Design, construct and install complete grain terminals for ship loading and unloading. The range of grain terminals covers any possible technology: fixed or mobile, on rails or tyres, for loading and unloading or the combined type in the same structure. Two types of unloaders are produced - pneumatic and mechanical. Special designed unloaders for no-free flowing commodities.

**Goodman Conveyor Company**

U.S. Route 178 South  
PO Box 866  
Belton  
South Carolina  
29627  
USA

Contact: Mr Carter Matthews  
Job Title: VP Sales & Marketing  
T: + 1 864 338 7793 x 102  
F: + 1 864 338 8732  
E: info@goodmanconveyor.com  
W: www.goodmanconveyor.com  
Recognised as a leading designer and manufacturer of high quality bulk conveyor equipment, components and structures, including screw conveyors, multi-flow round bottom drag conveyors and flat bottom en-masse drag conveyors.

**Goodtech Solutions AS**

Bjornslottveien 2  
Porsgrunn  
N-3917  
Norway

Contact: Mr Knut Halvorsen  
Job Title: Commercial Group Manager  
T: + 47 35 93 05 50  
F: + 47 35 93 05 60  
E: knut.halvorsen@goodtech.no  
W: www.portabulk.com or www.goodtech.no  
The company provides specialised technology for filling, handling, storing, tracing and distributing packaged bulk products for customers throughout the world. We supply purpose-designed and cost-effective systems, materials, equipment and software.

**Gordinne & Co NV/SA**

Belgian Ports Operation  
Leegstraat 1  
Zelzate  
B-9060  
Belgium

Contact: Mr Patrick Bosschaert  
Job Title: Operation Manager  
T: + 32 9 342 3333  
F: + 32 9 342 3331  
E: patrick.bosschaert@stewartgroupglobal.com  
W: www.gordinne.be  
Based in Belgium, the Netherlands and Venezuela. Established in 1947 and specialises in the

**HAYER & BOECKER**



THE ENGINEER

# OUR EXPERTISE PACKING AND HANDLING OF BULK MATERIALS



- HANDLING
- PACKING
- LOADING
- SERVICE

HAYER & BOECKER, Germany  
Phone: +49 2522 30-0 · Fax: +49 2522 30-403  
E-mail: [haver@haverboecker.com](mailto:haver@haverboecker.com)

[www.haverboecker.com](http://www.haverboecker.com)

The designation ® indicates a registered trademark of HAYER & BOECKER OHG in Germany. Several indicated designations are registered trademarks also in other countries worldwide. M 939-E4

controlling, sampling and analysing of solid bulk commodities (coal, coak and petroleum coke, ores and minerals), the draft survey of ships and the topographic surveys of stockpiled materials. An ISO 9002 certified company.

### Gottwald Port Technology USA

Demag Cranes and Components Corp  
3502 Riga Blvd., Suite C  
Tampa  
Florida  
FL 33619  
USA  
Contact: Mr Bob Histon  
Job Title: General Manager, North America  
T: + 1 813 490 0990 ext 19  
F: + 1 813 490 0994  
E: [bob.histon@gottwald-us.com](mailto:bob.histon@gottwald-us.com)  
W: [www.gottwald-us.com](http://www.gottwald-us.com)

### GREIF-VELOX

Kronsford Landstraße 177  
Lübeck  
D-23560  
Germany  
Contact: Mr D M Wassenberg  
T: + 49 451 5303 0  
F: + 49 451 5303 233  
E: [dm.wassenberg@greif-velox.de](mailto:dm.wassenberg@greif-velox.de)  
W: [www.greif-velox.de](http://www.greif-velox.de)  
Manufactures special FIBC filling and discharge equipment that allows FIBCs to be transported in interchange racks and unloaded in controlled doses into a production process.

### Greystones Cargo Systems (Pty) Ltd

PO Box 22034  
Glenashley  
Durban  
KZN  
4022  
South Africa  
Contact: Mr Bruce Poucher  
T: + 27 31 274 2600  
F: + 27 31 569 2626  
E: [paul@cargo.greystones.co.za](mailto:paul@cargo.greystones.co.za)  
W: [www.greystones.co.za](http://www.greystones.co.za)

### Gubre Fabrikalari TAS

Kasap Sokak No 22  
Esentepe  
Istanbul  
34394  
Turkey  
Contact: Mr M Kürsat Akin  
Job Title: Trade Manager  
T: + 90 212 3765050  
F: + 90 212 2741201  
E: [kakin@gubretas.com.tr](mailto:kakin@gubretas.com.tr)  
W: [www.gubretas.com.tr](http://www.gubretas.com.tr)  
Producer of NP,NPK and inporter fertilizer .

### Gulsan A.p.

Organize Sanayi Bolgesi 2 Cad. No: 18  
Gaziantep  
27180  
Turkey  
Contact: Ms Gülden Saka  
Job Title: Marketing Manager  
T: + 90 342 337 1180  
F: + 90 342 337 2528  
E: [info@gulsan-group.com](mailto:info@gulsan-group.com)  
W: [www.gulsan-group.com](http://www.gulsan-group.com)

### Guttridge Ltd

Wardentree Park  
Pinchbeck  
Spalding  
Lincolnshire  
PE11 3UU  
UK  
Contact: Mr Peter Lambert  
Job Title: Sales Manager  
T: + 44 1775 765300  
F: + 44 1775 765304  
E: [sales@guttridge.co.uk](mailto:sales@guttridge.co.uk)

W: [www.guttridge.co.uk](http://www.guttridge.co.uk)  
Manufactures a range of bulk conveying and elevating equipment, as well as storage facilities.

### Güven Grab and Machine Ltd. Co

Nazim Hikmet Cad 536. sk. No: 9  
Aske Köyü  
Cayirova  
Kocaeli  
41420  
Turkey  
Contact: Mr Engin Demir  
Job Title: Sales & Export Manager  
T: + 90 262 743 8858  
F: + 90 262 743 1141  
E: [info@guvengrab.com](mailto:info@guvengrab.com)  
W: [www.guvengrab.com](http://www.guvengrab.com)  
Established in 1984, Güven Grab & Machine (Güven Kepçe Makine) has its own manufacturing facilities. Its product range includes radio remote control grabs, electro hydraulic clamshell/orange peel grabs, mechanical clamshell orange peel touch down grabs and mechanical double wired grabs. It has supplied its units to countries around the world.

### H J Wiefferink BV

PO Box 335  
Oldenzaal  
7570 AH  
The Netherlands  
Contact:  
Job Title: Advertising  
T: + 31 5415 71616  
F: + 31 5415 12499  
E: [info@wiefferink.nl](mailto:info@wiefferink.nl)  
W: [www.wiefferink.nl](http://www.wiefferink.nl)

### H Noorman BV

Breedstraat 2  
Vreeland  
3633 AX  
The Netherlands  
Contact: Mr H Noorman  
T: + 31 294 236161  
F: + 31 294 232181  
E: [info@hnoorman.com](mailto:info@hnoorman.com)

### Halcrow

Burderop Park  
Swindon  
Wiltshire  
SN4 0QD  
UK  
Contact: Mr Daniel Cross  
Job Title: Ports Design Engineer  
T: + 44 1793 812 479  
F: + 44 1793 812 089  
E: [crossd@halcrow.com](mailto:crossd@halcrow.com)  
W: [www.halcrow.com](http://www.halcrow.com)

### Hans Turck GmbH & Co. KG

Witzlebenstraße 7  
Mülheim an der Ruhr  
D-45472  
Germany  
Contact: Mr Klaus Albers  
Job Title: PR Manager  
T: + 49 208 495249  
F: + 49 160 93950359  
E: [klaus.albers@turck.com](mailto:klaus.albers@turck.com)  
W: [www.turck.com](http://www.turck.com)

### Hansen Industrial Transmissions NV

Leonardo da Vincilaan 1-3  
Edegem  
Antwerpen  
B-2650  
Belgium  
Contact:  
T: + 32 345 12 11  
F: + 32 345 12 20  
E: [info@hansenindustrialgearboxes.com](mailto:info@hansenindustrialgearboxes.com)  
W: [www.hansenindustrialgearboxes.com](http://www.hansenindustrialgearboxes.com)  
Innovative and durable drives for a wide range of industrial applications



throughout the world, especially in sectors where low noise levels, minimum weight and high reliability are essential (including material, cooling towers, handling, water treatment, etc.).

## Hansen Transmissions Ltd

Nile Street  
Huddersfield  
West Yorkshire  
HD1 3LW  
UK

Contact: Mr Terry Drayton  
T: + 44 1484 431414  
F: + 44 1484 431426  
E: info.uk@hansentransmissions.com  
W: www.hansentransmissions.net  
Gearbox refurbishment 24/7, 365 days a year. Full design, spares and on-site service facilities available. Gear units spanning from 80 Nm to 800 KNm (0.12 KW to 12MW). Hansen Transmissions operate successfully in thousands of diverse industrial installations worldwide, and are available in many configurations and drive packages.

## Hanson Silo Company

11587 County Rd  
8 SE  
Lake Lillian  
MN  
56253  
USA

Contact: Mr Mike Hanson  
Job Title: Director of Business Development  
T: + 1 800 843 7456  
E: hscinfo@hanson-silo.com  
W: www.hanson-silo.com

## Hapman

6002 East N Ave.  
PO Box 2321  
Kalamazoo  
MI  
49048  
USA

Contact: Mr Greg Patterson  
Job Title: Vice President  
T: + 1 269 343 1675  
F: + 1 269 349 2477  
E: greg.patterson@hapman.com  
W: www.hapman.com  
Produces bulk material handling conveyors, bulk bag handling equipment and systems for the handling of materials for the chemical, food, minerals and related industries.

## Hasel Machinery Inc

Cumhuriyet Mh. Nr 15 E5 Karayolu  
Uzeri  
Yakacik Kartal  
Istanbul  
81100  
Turkey  
Contact: Mr Osman Nuri Mete  
Job Title: Manager  
T: + 90 216 452 9787  
F: + 90 216 452 9790  
E: osman.mete@hasel.com  
W: www.hasel.com

## Haskoning India Pvt Ltd

13th Floor, Maitihili's Signet  
Plot - 39/4, Sector 30A  
Vashi

Navi Mumbai  
400 705  
India

Contact: Mr Harel van den Brink  
Job Title: Director of Business - India  
T: + 91 22 4161 5004  
E: harel.van.den.brink@rhdvvhv.com  
W: www.royalhaskoningdhv.com

## Hasler International SA

Z.I. De l'Abbaye  
Pont-Evêque  
38780  
France  
Contact: Mr Michel Jamey  
Job Title: President and Sales Director  
T: + 33 474 161151  
F: + 33 474 161155

E: sales.fr@hasler-int.com  
W: www.hasler-int.com

## HAUGEN System AB

Fersens väg 12  
Malmö  
211 42  
Sweden  
Contact: Mr Karl T. Haugen  
Job Title: Managing Director  
T: + 46 40 30 64 00  
F: + 46 40 30 63 30  
E: karl.haugen@haugensystem.com  
W: www.haugensystem.com  
SPILLAGE MANAGEMENT:  
Spillage in your plant means: - Loss of valuable raw material and finished products. - Internal and external environmental problems. - Increased maintenance cost. - Lower production efficiency. Heavy duty vacuum loaders and stationary vacuum systems can recover spillage, clean your plant and create a better environment.

## HAYER & BOECKER OHG, Machinery Division



PO Box 3320/ Carl-Haver-Platz 3  
Oelde  
59282/ 59302  
Germany  
Contact: Mr Bernhard Pagenkemper  
Job Title: Director Sales  
T: + 49 2522 30 272  
F: + 49 2522 30 627  
E: b.pagenkemper@haverboecker.com  
W: www.haverboecker.com  
HAVER & BOECKER product range: Packing plants for bulk

products in valve bags and open-mouth bags for semi-automatic or fully automatic operation. Capacities 100-5,500 bags/hour, weight range 5-2,000 kg, Form-Fill-Seal bagging systems, big bag weighers and container weighers, complete silo and bag loading plants as well as screening plants for dry and wet products.

## Haver & Boecker Wire Weaving

**Division**  
Ennigerloher Strasse 64  
Oelde  
59302  
Germany  
Contact: Mr N Albertemst  
T: + 49 2522 300  
F: + 49 2522 30404  
E: dw@haverboecker.com  
W: www.weavingideas.com  
State-of-the-art machinery and a team of qualified experts manufacture wire cloth and wire cloth products suitable for all applications. Rolls, pieces, strips, discs, fabricated parts, filters, screen sections, test sieves, test sieve shakers, and photo-optical particle analyser.

## Hebei Xinrong Rubber Products Co., Ltd

Beijing International Marketing Dept  
21st Floor,  
Wanda Plaza  
Shijingshan District,  
Beijing  
100043  
China  
Contact: Ms Roxy Yang  
Job Title: Sales Manager  
T: + 86 10 886 96 189  
F: + 86 10 88 696 185  
W: www.bjxinrongrubber.com

## Heinrich Schwacke GmbH & Co

**KG**  
Hölscherstr. 6a,  
Duisburg  
D-47167  
Germany  
Contact: Mrs Schacke  
T: + 49 203 995 290  
F: + 49 203 586 058  
E: info@schacke.de  
W: www.schwacke.de

## Henry International Diplomatic Marine

27502 Vilna Avenue  
Santa Clarita  
CA  
91351  
USA  
Contact: Mr Jim Hill  
Job Title: International Sales Manager  
T: + 1 713 676 2400  
F: + 1 713 673 5805  
E: jhill@henry.com  
W: www.henry.com  
Products include: RAM-NEK - Premium heavy duty hatch cover tape. GULF-SEAL - Heavy duty hatch cover tape. MARITAPE-60 - Hatch cover tape. MARITAPE-40 - Hatch cover tape. KOAMING-AIDE - Coaming joint sealant. RAM-WRAP - Pipe repair system.

## Hethon Nederland BV

Vlijstraat 47-49  
Doetinchem  
7005BN  
The Netherlands  
Contact: Ms Brenda Hykens  
Job Title: Managing Director  
T: + 31 74 250 0555  
F: + 31 74 250 0595  
E: info@hethon.nl  
W: www.hethon.nl  
Produces pneumatic conveyors, feeders/excistors and control equipment.



## Heyl & Patterson Inc



PO Box 36  
Pittsburgh  
PA  
15230  
USA

Contact: Mr Harry Edelman  
Job Title: Executive Vice President  
T: + 1 412 788 9810  
F: + 1 412 788 9822  
E: info@heylpatterson.com  
W: www.heylpatterson.com  
Produces railcar dumpers, wagon  
tipplers, railcar indexers, train  
positioners, railcar movers, side  
arm chargers, grabs, bucket  
unloaders, barge loaders and  
unloaders and continuous barge  
unloaders.

## Hitachi Construction Machinery (Europe) NV



Siciliëweg 5  
Amsterdam  
1045 AT  
The Netherlands  
Contact: Ms Ghislaine Jonker  
Job Title: Assistant Manager,  
Corporate Communication  
T: + 31 20 44 76 711  
F: + 31 20 33 44 045  
E: marketing@hcm.com  
W: www.hcm.com  
Hitachi Construction Machinery

(Europe) NV 's main products are  
hydraulic excavators, crawler  
cranes, wheel loaders and rigid  
dump trucks. HCME provides a  
product line-up that distinguishes  
itself by its depth and width and  
that has earned an excellent  
reputation for performance,  
reliability and safety.

## Horizon Conveyor Equipment

Unit 1, Hayseeh Road  
Halesowen  
West Midlands  
B63 3PD  
UK  
Contact: Mr Alan Bowler  
Job Title: Managing Director  
T: + 44 121 550 2218  
F: + 44 121 550 2243  
E: info@horizonconveyors.co.uk  
W: www.horizonconveyors.co.uk  
Horizon Conveyor Equipment  
design and manufacture a  
comprehensive range of conveyor  
bulk handling equipment which  
includes: Medium & Heavy-Duty  
Steel & Polymer Idlers, Steel &  
Polymer Conveyor Rollers,  
Primary, Secondary & Plough Belt  
Scrapers, Impact Sections & Skirts,  
Conveyor Covers.

## HOSCH-Fördertechnik Recklinghausen GmbH

Am Stadion 36  
Recklinghausen  
D-45659  
Germany  
Contact: Mr Giancarlo Leombruno  
Job Title: Export Manager  
T: + 49 2361 5898 0

F: + 49 2361 5898 40  
E: sales@hosch.de  
W: www.hosch.de  
Hosch has been manufacturing and  
distributing Sprung Blade Scrapers  
and accessories for high-precision  
belt cleaning for 35 years now. The  
innovative design principle of the C-  
series, which is patented world-  
wide, utilises modular components  
and guarantees total belt cleaning  
efficiency for all types of  
installation.

## HPC Hamburg Port Consulting GmbH

Container Terminal Altenwerder  
Am Ballinkai 1  
Hamburg  
21129  
Germany  
Contact: Mr Klaus Schmöcker  
Job Title: Managing Director  
T: + 49 40 74008 130  
F: + 49 40 74008 133  
E: k.schmoecker@hpc-hamburg.de  
W: www.hpc-hamburg.de  
Offers a comprehensive range of  
services in the fields of port and  
transport management, port  
planning and operation, systems  
engineering, IT-Systems  
development, research and  
development, hydrography and  
training.

## Huadian Heavy Industries Co., Ltd.

12th Floor, China Overseas  
Property Plaza  
Wing East

No.8 Xibinhe Road  
Yongdingmen, Dongcheng District  
Beijing  
China  
Contact: Mr Liu Zheng  
Job Title: Deputy Managing Director  
T: + 86 10 5196 6647  
F: + 86 10 6873 0551  
E: Liuzheng-dlbj@hotmail.com  
W: www.HHI.com.cn

## Hycontrol Limited

Larchwood House  
Orchard Street  
Redditch  
B98 7DP  
UK  
Contact: Mr Nigel Allen  
Job Title: Marketing  
T: + 44 1527 406800  
F: + 44 1527 406810  
E: nallen@hycontrol.com  
W: www.hycontrol.com

## Hyundai Heavy Industries Co

1000 Bangeojinsunhwan-doro  
Dong-Gu  
Ulsan  
682-792  
South Korea  
Contact: Mr J.M. Roh  
Job Title: General Manager  
T: + 82 52 202 2429  
F: + 82 52 202 3315  
E: sbcntr@hhi.co.kr  
W: www.hhi.co.kr/  
Produces a range of cranes and  
bulk-handling equipment, including  
gantry bulk unloaders and rail-  
mounted grab cranes.

## IBAU HAMBURG

Roedingsmarkt 35  
Hamburg  
20459  
Germany  
Contact: Mr Mario Raemmele  
Job Title: Sales Director  
T: + 49 40 361 309 24  
F: + 49 40 369 019 62  
E: mraemmele@ibauhamburg.de  
W: www.ibauhamburg.de  
IBAU HAMBURG operates in the  
field of silo technology for the  
cement, lime and gypsum  
industries as well as for coal-fired  
power plants throughout the world.  
IBAU supplies marine handling  
systems, ranging from shore-based  
terminals to self-unloading cement  
ships and barges, ship unloaders  
and loaders and floating terminals,  
ranging from individual parts to  
entire turn-key plants, including  
design and planning, building, start-  
up and maintenance.

## IBC International Handling AB

Hamn. 1  
Falkenberg  
S-311 32  
Sweden  
Contact: Ms Maria Penca  
Job Title: Marketing Manager  
T: + 46 346 56910  
F: + 46 346 56918  
E: sales@ibc-international.se  
W: www.ibc-international.se  
Supplies complete customised  
material handling systems. Dust-  
free, filling/discharging of big  
bags/small bags and transport of  
powder/granules. We also supply  
lifting equipment, both traditional,

# Engineered for Life

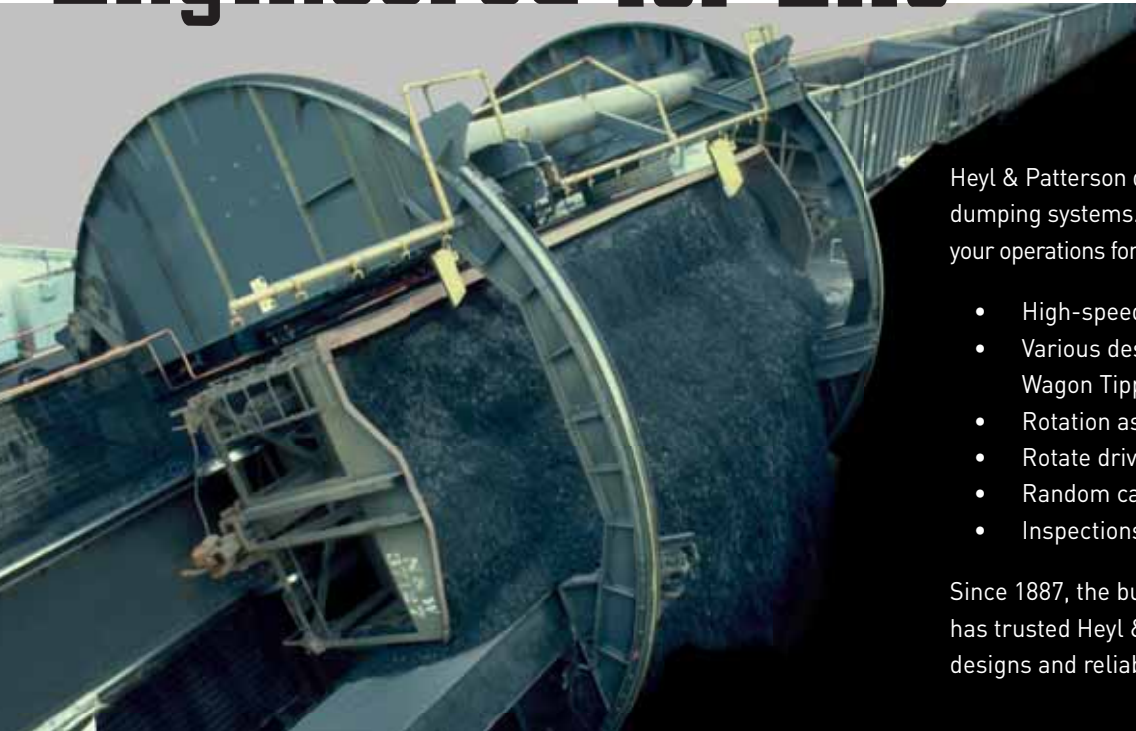

Heyl & Patterson doesn't just engineer railcar  
dumping systems...We become a real partner in  
your operations for the life of your equipment, with:

- High-speed, semi-automatic unloading
- Various designs – Single, Tandem, Rotary, Wagon Tippler, Turnover, C-Shaped
- Rotation as fast as 35 seconds per car
- Rotate drive – Rack & Pinion or Chain
- Random car or unit train applications
- Inspections, upgrades and field service

Since 1887, the bulk materials handling industry  
has trusted Heyl & Patterson for innovative  
designs and reliable equipment.



**HEYL & PATTERSON**  
Trusted Since 1887

412-788-9810  
info@heylpatterson.com  
info.heylpatterson.com/dci



# The technological choice

QUICK  
POWER SWITCH

TRIAS  
HYDRAULICS

ENERGY  
SAVING  
SYSTEM

Hitachi is renowned for the reliability and versatility of its range of construction machinery. The new Zaxis-5 excavator and ZW-5 wheel loader models benefit from technologically advanced features that deliver unrivalled levels of productivity and efficiency. These have a huge impact on profitability by boosting performance and reducing fuel consumption to prove that Hitachi is the technological choice.

**HITACHI**

Reliable solutions

**World's No.1 CSU Supplier**



## Best Solution of Bulk Handling

IHI has supported Bulk Handling in the world over a century and continues to do in next 100 years.



### **IHI Product Line up**

- **Continuous Ship Unloader(CSU)**
- **Bridge Type Ship Unloader**
- **Mobile Multi-Purpose Crane**
- **Stacker**
- **Reclaimer**
- **Stacker-Reclaimer**
- **Conveyor**
- **Ship Loader**

**IHI**

**IHI Transport Machinery Co., Ltd.**

8-1, Akashicho, Chuo-ku, Tokyo 104-0044 JAPAN

Website: <http://www.iuk.co.jp/english/index.html>



customized and with vacuum. We lift everything from big bags to helicopters.

**Igus GmbH**

Spicher Str. 1a  
Köln  
D-51147  
Germany  
Contact: Mr Theo Diehl  
Job Title: Head of Intl. Cranes & Materialhandling  
T: + 49 2203 9649 0  
F: + 49 2203 9649 222  
E: cranes@igus.de  
W: www.igus-cranes.com  
Products include E-ChainSystems - in operation on Bulkhandling Cranes, Ship to Shore Cranes, RTGs, RMGs, Goliath Cranes, Spreaders, Reach Stacker etc. More than 5.000 port equipment applications are running world-wide with igus® E-ChainSystems.

**IHI Transport Machinery Co., Ltd. (IUK)**



8-1 Seiroka Tower  
Akashi Cho  
Chuo-Ku  
Tokyo  
104-0044 MZ  
Japan  
Contact: Mr Shigeyuki Kawashima  
Job Title: Deputy General Manager, Overseas Sales Dept  
T: + 81 3 5550 5375  
F: + 81 3 5550 5366  
E: shigeyuki.kawashima@iuk.co.jp  
W: www.iuk.co.jp



IUK is a leading supplier of material handling equipment and designs, supplies, and gives specialized services of machinery for loading, unloading, transport and storage of a wide range of materials such as containers, coal, iron ore, coke, bauxite, etc.

**IMASA**

Palacio Valdes 1  
Oviedo (Asturias)  
33002  
Spain  
Contact: Mr Amancio Garcia  
T: + 34 985 22 71 78  
F: + 34 985 22 25 98  
E: amancio.garcia@imasa.com  
W: www.imasa.com

**IMGS**

Mazaya Tower AA1,  
Jumeirah Lakes Towers  
Suite 2906

Dubai  
UAE  
Contact: Mr Shahbaz Alikhan  
Job Title: Director  
T: + 97 144 458 335  
F: + 97 144 458 337  
E: shahbaz@imgsa.com  
W: www.imgsa.com  
IMGS provides innovative and economical cargo handling solutions globally. Operating for over 30 years in the most diverse geographic and operational conditions, our teams are experienced and offer customized solutions for all cargo handling issues. With mobile bulk bagging, ship loading/unloading, Ship berthing and expediting we provide our customers with cost-effective handling of various commodities.

**Imperial Technologies, Inc.**

4155 Martindale Rd., NE  
Canton

OH  
44705  
USA  
Contact: Mr Ron Tschantz  
Job Title: VP Gen Sales & Marketing  
T: + 1 330 491 3200  
F: + 1 330 491 3204  
E: rontschantz@imperial-technologies.com  
W: www.imperial-technologies.com  
Has a unique 'Multi-Fold' system that allows belt cover flaps to fold over and enclose the product. This system eliminates spillage and blow-off and can operate at steep angles.

**Impsa - Industrias Metalurgicas Pescarmana**

Carril Rodriguez Pena 2451  
San Francisco del Monte  
Godoy Cruz  
Mendoza  
5501  
Argentina  
Contact: Mr Antonio Urbano  
T: + 54 261 413 1394  
F: + 54 261 413 1335  
E: antonio.urbano@impsa.com  
W: www.impsa.com  
Produces Panamax and post-Panamax ship-to-shore bulk cranes and unloaders.

**Incolab Services BV**

PO Box 1561  
Oud-Beijerland  
BB  
3260  
The Netherlands  
Contact: Mr Leo Van Tour  
Job Title: Managing Director  
T: + 31 1866 10355

F: + 31 1866 10552  
E: leo@incolab.com  
W: www.incolab.com  
Quality and quantity control in major coal ports worldwide.

**Indexator Rotator Systems AB**



Box 11  
Vindeln  
SE-922 21  
Sweden  
Contact: Ms Camilla Waara  
T: + 46 933 149 15  
F: + 46 933 14899  
E: rotator@indexator.se  
W: www.indexator.se  
The wide range of Indexator rotators are suitable for the most demanding materials handling tasks. Our rotators are used worldwide in many industries from forestry to scrap metal, general cargo to materials recycling. The compact, robust and low profile design, combined with the high quality materials used in construction, ensure a long working life.

**Industrial Netting (Pty) Ltd**

PO Box 39624  
Bramley  
Transvaal  
2018  
South Africa  
Contact: Mr Ian Campbell  
Job Title: Managing Director  
T: + 27 11 6084686  
F: + 27 11 6084690  
E: info@industrialnetting.co.za

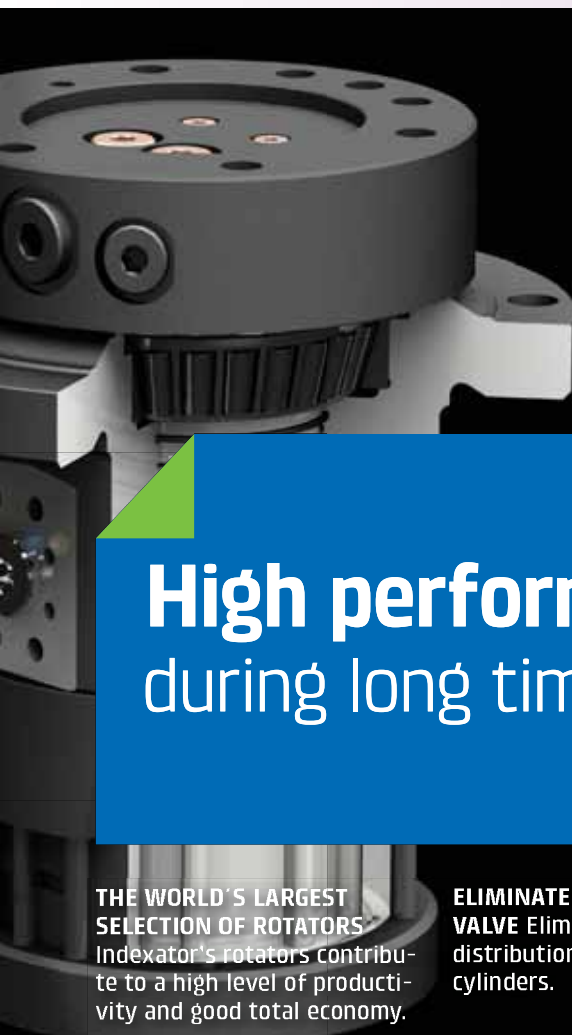

**High performance during long time**



**THE WORLD'S LARGEST SELECTION OF ROTATORS**  
Indexator's rotators contribute to a high level of productivity and good total economy.

**ELIMINATE DISTRIBUTION VALVE**  
Eliminates the need for distribution valve to grapple cylinders.

**COMPLETE SOLUTION** Swivel, bearings and motor packaged in one well protected rotator – the materials and components are carefully selected.

**HIGH TORQUE VANE MOTORS**  
The modular design together with few moving parts make these rotators durable and easy to service. Documented long lifetime.

W: [www.industrialnetting.co.za](http://www.industrialnetting.co.za)

## Industrias Murtra

Jordi Camp 94  
Apartado 278  
Granollers  
Barcelona  
08403  
Spain  
Contact: Mr Xhabby Franco  
Job Title: Sales Manager  
T: + 34 93 846 7200  
F: + 34 93 846 5956  
E: [murtra@murtra.com](mailto:murtra@murtra.com)  
W: [www.murtra.com](http://www.murtra.com)

## Inman SA

Av Hermilo Mena N 10  
San Juan Ixhuatepec  
Edo de Mexico  
54180  
Mexico  
Contact: Mr Oscar Calderon  
T: + 52 55 5718 3036/4536  
F: + 52 55 5718 3432  
E: [inman@inman.com.mx](mailto:inman@inman.com.mx)  
W: [www.inman.com.mx](http://www.inman.com.mx)  
Manufacturer of solid material handling equipment.

## Inspectorate America Corporation

12000 Aerospace Avenue  
Suite 200  
Houston  
Texas  
77034  
USA  
Contact: Mr Patrick Le Mare

Job Title: Metals & Minerals Trade Manager  
T: + 1 713 944 2000 ext. 5219  
E: [client.services@inspectorate.com](mailto:client.services@inspectorate.com)  
W: [www.inspectorate.com](http://www.inspectorate.com)

## Inspectorate International Ltd

2 Perry Road  
Witham  
Essex  
CM8 3TU  
UK  
Contact: Mr Julian Sowry  
Job Title: Sales & Mktg Mngr,  
Steel & Energy Products  
T: + 44 1376 536849  
F: + 44 1376 520819  
E: [client.services@inspectorate.com](mailto:client.services@inspectorate.com)  
W: [www.inspectorate.com](http://www.inspectorate.com)  
Inspectorate, part of the Bureau Veritas Commodities Division, is one of the world's leading independent inspection companies. We provide services for a full range of metals, minerals and solid fuels including draft surveys, weighing and sampling. Analysis & testing is undertaken through our network of key and specialist laboratory facilities, accredited to ISO17025.

## Interjute BV

PO Box 154  
Hulst  
4560 AD  
The Netherlands  
Contact: Mr Ed Wessels  
Job Title: International Sales Manager  
T: + 31 114 311208

F: + 31 114 311512  
E: [ewessels@interjute.nl](mailto:ewessels@interjute.nl)  
W: [www.interjute.com](http://www.interjute.com)  
50 kg. bags and FIBC's for all purposes. Fast deliveries all over the world.

## International Bulk Handling Technology BV

PO Box 47  
Mierlo  
5730 AA  
The Netherlands  
Contact: Mr Johan M.A.M. Brands  
Job Title: Technical Manager  
T: + 31 492 664 885  
F: + 31 492 664 695  
E: [info@ibtbulk.nl](mailto:info@ibtbulk.nl)  
W: [www.ibtbulk.nl](http://www.ibtbulk.nl)  
IBT is specialized in designing and turn-key supply of bulk handling systems like troughed belt conveyors, pipe conveyors and beltwall conveyors. With capacities of product conveyed up to 6000 tph major systems in harbors etc. have been supplied by IBT.

## Interstate Equipment Corporation

929 Park Avenue  
Pittsburgh  
Pennsylvania  
15234  
USA  
Contact: Mr Joe Vogel  
Job Title: Sales Manager  
T: + 1 412 563 5556  
F: + 1 412 563 6741

E: [joevogel@go-iec.com](mailto:joevogel@go-iec.com)

## Intersystems

9575 N 109th Ave  
Omaha  
NE  
68142  
USA  
Contact: Mr Ray Vrtiska  
Job Title: VP Sales, Bulk Material Handling  
T: + 1 402 330 1500  
F: + 1 402 330 3350  
E: [bulkmatt@intersystems.net](mailto:bulkmatt@intersystems.net)  
W: [www.intersystems.net](http://www.intersystems.net)  
Intersystems has expertise in the engineer and manufacture of bulk weighers, bucket elevators, enclosed belt and en-masse conveyors, gravity screeners, automatic samplers and truck probes, micro ingredient systems, bolted bins and distributors.

## Invicta Vibrators

Harlaxton Road  
Grantham  
Lincolnshire  
NG31 7SF  
UK  
Contact: Mr Mike Caldwell  
Job Title: Sales Manager  
T: + 44 1476 566301  
F: + 44 1476 590145  
E: [mike.caldwell@invictavibrators.co.uk](mailto:mike.caldwell@invictavibrators.co.uk)

## iSAM AG Gesellschaft fuer angewandte Kybernetik



Alexanderstrasse 46  
Mülheim an der Ruhr  
45472  
Germany  
Contact: Dr Juergen Hellmich  
Job Title: Chief Executive Officer  
T: + 49 208 49 585 61  
F: + 49 208 49 585 62  
E: [info@isam-ag.de](mailto:info@isam-ag.de)  
W: [www.isam-ag.de](http://www.isam-ag.de)  
iSAM AG delivers the full range of products and services for advanced automation of bulk material handling and port operations. We handle turn-key solutions for new automation projects as well as the upgrading of existing equipment including project management, electrical engineering and commissioning.

## Isomonte SA

Rua Cristiano Franca Teixeira  
Guimaraes  
265 Bairro  
Cinco  
Contagem MG  
Minas Gerais  
CEP 32010-130  
Brazil

# iSAM AG – integrated automation for bulk material handling



**iSAM AG**  
Gesellschaft  
für angewandte  
Kybernetik



- driverless ship unloaders
- driverless ship loaders
- fully automatic train unloading stations
- 3D laser based ship models
- material transport and flow control systems
- SCADA systems for central control rooms
- storage management and logistic systems

we deliver solutions ...





Contact: Mr Jose Rubem Almeida  
T: + 55 31 2128 2600 / 2641  
F: + 55 31 3351 4093  
E: info@isomont.com  
W: www.isomont.com  
Specialises in the design and construction of turnkey systems for materials handling, including shiploaders/unloaders, mechanical grabs, stackers/reclaimers, shield, belt conveyors and steel structures for handling equipment.

**Italgru S.r.l**

Statale Briantea, 4  
Ambivere  
(BG)  
24030  
Italy  
Contact: Mr Fabrizio Bonfanti  
T: + 39 0 35 49 32 411  
F: + 39 35 49 32 409  
E: fabrizio.bonfanti@italgru.it  
W: www.italgru.com

**J & B Grabs b.v.**



PO Box 176  
De Meern  
Utrecht  
3454 ZK  
The Netherlands  
Contact: Mr Edgar Joustra  
Job Title: Director  
T: + 31 3066 21616  
F: + 31 3066 63765  
E: info@jb-grubbers.nl  
W: www.jb-grabs.com  
Designs, engineers and manufactures mechanical and hydraulic grabs for all kinds of bulk material.

**J C Steele & Sons Inc**

710 South Mulberry Street  
Statesville  
NC  
28687  
USA  
Contact: Mr Rick Steele  
Job Title: Marketing Manager  
T: + 1 704 872 3681  
F: + 1 704 878 0789  
E: ricksteele@jcsteele.com  
W: www.jcsteele.com  
Established in 1889, J. C. Steele is the largest producer of heavy clay machinery in the United States. Export sales to many parts of the world make up a large part of total business.

**Jansen & Heuning**

Bulk Handling Systems  
Duinkerkenstraat 11  
Groningen  
9723 BN  
The Netherlands  
Contact:  
T: + 31 50 312 64 48  
F: + 31 50 313 80 18  
E: sales@jh.nl  
W: www.jh.nl

**Jansens & Dieperink BV**

PO Box 436  
Zaandam  
1500 EK  
The Netherlands  
Contact:  
Job Title: Sales Department  
T: + 31 75 616 8555  
F: + 31 75 6168569

E: info@jansensanddieperink.com  
W: www.jansensanddieperink.com  
Engineering, fabrication and assembly of stainless and aluminium silos and gravity blenders. Dry bulk container with aluminium liner.

**Jem International & Express**

**Scale Parts**  
6873 Martindale  
Shawnee  
Kansas  
66218  
USA  
Contact: Mr James Mattson  
T: + 1 913 441 4787 Ext 228  
F: + 1 913 441 1711  
E: info@jemesp.com  
W: www.jemesp.com  
Open-mouth baggings scales.

**Jenike & Johanson Inc.**

400 Business Park Drive  
Tyngsboro  
MA  
01879  
USA  
Contact: Mr Roderick J. Hossfeld  
Job Title: Senior Engineer  
T: + 1 978 649 3300  
F: + 1 978 649 3399  
E: mail10@jenike.com  
W: www.jenike.com  
Our engineering services focus on material flow properties and your operating conditions to assist you in selecting the right process equipment, or troubleshooting existing equipment. For 50 years, we have tested over 8,000 materials and successfully serviced over 3,500 companies.

**Jim Way Enterprise Co Ltd**

No 17 Chang Tai Street  
Lin Hai Industrial Park  
Hsiao Kang Industrial  
Kaohsiung  
81266  
Taiwan  
Contact: Mr Chandler Chang  
Job Title: International Sales Manager  
T: + 886 7 8718126  
F: + 886 7 8718128  
E: jw@roller.com.tw  
W: www.roller.com.tw  
Professional manufacturer established in 1980. Specialize in fabrication of belt conveyor component parts, idler, pulley, belt cleaner, skirting, impact & wear-resistant products. Has passed ISO 9001 certification, and have more than 30 years' experience devoted to operation international business.

**Johannes Hübner Fabrik**

**Elektrischer Maschinen GmbH**  
Siemens Strasse 7  
Giessen  
D-35394  
Germany  
Contact: Mr Philipp Kuebler  
T: + 49 641 79 69 970  
E: philipp.kuebler@huebner-giessen.com  
W: www.huebner-giessen.com

**John R Boone Ltd**

18 Silk Street  
Congleton  
Cheshire  
CW12 4DH  
UK  
Contact: Mr C R Boone  
T: + 44 1260 272894  
F: + 44 1260 281128  
E: sales@jrboone.com

W: www.jrboone.com

**Joy Mining Machinery**

West Quay Road  
Sunderland Enterprise Park East  
Sunderland  
Tyne & Wear  
SR5 2TD  
UK  
Contact: Mr Paul Bancroft  
Job Title: Sales & Marketing Director  
T: + 44 191 516 5353  
F: + 44 191 516 5399  
E: sales@continental-conveyor.co.uk  
W: www.continental-conveyor.co.uk  
Complete conveyor systems for bulk mineral handling at ports, mines, quarries, process plants. Belt conveyor component manufacturer of idlers, rollers, pulleys, drums and structures. Full range of compact conveyor drives from 20kw to 1000kw.

**JSC Tehnoros**

Gzhatskaya st. 21, liter A  
Saint-Petersburg  
195220  
Russia  
Contact: Mr Maxim Akhmetov  
Job Title: Marketing  
T: + 7 812 718 82 28 (429)  
F: + 7 812 718 82 28  
E: akhmetov@tehnoros.ru  
W: www.tehnoros.ru

**Jumbo Shipping**

PO Box 23016  
Rotterdam  
3001 KA  
The Netherlands  
Contact: Ms Dorrie Dijsselbloem  
Job Title: Senior Communications Advisor  
T: + 31 10 7900300  
F: + 31 10 4334624  
E: ddijsselbloem@jumbogroup.nl  
W: www.jumbogroup.nl  
Jumbo is a leading heavy lift shipping company that develops pioneering solutions for ocean transportation. We operate a fleet of 12 specialised heavy lift vessels with a lifting capacity varying from 500t to 1,800t. To cater for ever increasing industry demand two new vessels, with a lifting capacity of 3,000t and built to a Finnish-Swedish ice class 1A, will complement the fleet in 2013.

**Kalenborn Kalprotect GmbH & Co. KG**

Asbacher Str 50  
Vettelschoss  
D-53560  
Germany  
Contact: Mr Michael Rokitta  
Job Title: Managing Director  
T: + 49 26 45 18 196  
F: + 49 26 45 18 180  
E: michael.rokitta@kalenborn.de  
W: www.kalenborn.de  
One of the world's leading manufacturers and suppliers for wear resistant linings. Kalenborn provides tailor-made solutions starting from advice to design and manufacturing through to construction and on-site assembly using a wide range of mineral, ceramic, metallic, plastic or rubber materials. The scope of supply covers pneumatic, hydraulic and mechanical conveying including storage in silos and bunkers.

**Kardesler Grab & Machine**

Sultan Orhan Mah  
Hasköy Sanayi Sitesi 11/B Blok

No:24  
Gebze  
KOCAELI  
41400  
Turkey  
Contact: Mr Huseyin Isikoglu  
Job Title: Export Manager  
T: + 90 262 6445018  
F: + 90 262 6445017  
E: kardesler@kardeslerkepce.com  
W: www.kardeslerkepce.com and www.kardeslergrab.com  
Established in Istanbul/Maltepe in 1985, KARDESLER GRAB AND MACHINE first produced grabs for sand. Now products are produced suitable for the needs of the modern age. The company considers quality service and customer satisfaction vital and happily serves clients both in Turkey and foreign countries. Today, to provide better service, clients are served out of its factory in Kocaeli/Gebze Haskoy.

**KCT Grab Industry**

Agva cad. yeni sanayi sitesi  
No:3-5  
Sile  
Istanbul  
34980  
Turkey  
Contact: Cpt Atilla Kocatas  
Job Title: General Manager  
T: + 90 216 739 59 68  
F: + 90 216 739 59 83  
E: info@kctgrab.com or sales@kctgrab.com  
W: www.kctgrab.com  
We are grab manufacturers, since 1992. - Radio Remote Control Ship Grabs - Electro Hydraulic Grabs \* Clamshell type \* Orange peel type - Electro Hydraulic Water Proof Grabs - Mechanical 2 & 4 rope Grabs - Hydraulic excavators Grabs - Dredging Grabs - Timber Grabs - 2 & 4 rope Roundnose Grabs - Marine Port fender Construction - Port Hopper

**Kinergy Corporation**

7310 Grade Lane  
Louisville  
Kentucky  
40219  
USA  
Contact: Mr Bill Ware  
Job Title: Project Manager  
T: + 1 502 366 5685  
F: + 1 502 366 3701  
E: bware@kinergy.com  
W: www.kinergy.com  
Kinergy Corporation is a vibratory equipment manufacturer, which includes vibrating screens, feeders, conveyors, bin activators, dryers and coolers, railcar densifiers and dischargers, storage pile dischargers.

**King Bag & Manufacturing Co**

1500 Spring Lawn Avenue  
Cincinnati  
OH  
45223  
USA  
Contact: Mr Mike Jennings  
T: + 1 513 541 5440 ext 306  
F: + 1 513 541 6555  
E: mike@kingbag.com  
W: www.kingbag.com

**Kingfisher Industrial Ltd**

Cradley Business Park  
Overend Road  
Cradley Heath  
West Midlands  
B64 7DW  
UK

Contact: Ms Anita Chumber  
Job Title: Sales & Marketing Executive  
T: + 44 1384 410777  
F: + 44 1384 410877  
E: achumber@kingfisher-industrial.co.uk  
W: www.kingfisher-industrial.co.uk  
Kingfisher specialise in manufacturing wear resistant process plant and equipment that are used to convey, store and handle bulk solid material. We offer solution-driven, tailored concepts to counter the detrimental effects of handling and processing abrasive minerals, by employing our extensive expertise in the design, manufacture, wear protection and installation services.

**KINSHOFER GmbH**

Hauptstrasse 76  
Waakirchen  
83666  
Germany  
Contact:  
T: + 49 8021 8899 0  
F: + 49 8021 8899 37  
E: info@kinshofer.com  
W: www.kinshofer.com  
KINSHOFER GmbH is a medium sized company specializing in the development, production and sales of hydraulically operated crane and excavator attachments. Founded in 1971 and based south of Munich's dynamic financial region, today KINSHOFER GmbH is the center of an international group of 11 companies with about 400 employees worldwide.

**KIROW ARDELDT GmbH**

Heegermühler Straße 64  
Eberswalde  
Brandenburg  
16225  
Germany  
Contact: Dr Wolfgang Melzer  
Job Title: Managing Director  
T: + 49 3334 62 2275  
F: + 49 3334 62 2121  
E: Wolfgang.melzer@ardelt.de  
W: www.ardelt.de  
Produces slewing cranes (double jib, single jib, mobile, balancer cranes) for handling containers, general cargo, bulk and scrap.

**Kleemann GmbH**

Hildenbrandstr.18  
Goppingen-Faurndau  
D-73035  
Germany  
Contact: Mr Mark Hezinger  
Job Title: Marketing  
T: + 49 7161 206 0  
F: + 49 7161 206 100  
E: info@kleemann.info  
W: www.kleemann.info

**Knight Energy Services Limited**

Eccleston Grange  
Prescot Road  
St Helens  
Merseyside  
WA10 3BQ  
UK  
Contact: Ms Vallery Head  
Job Title: Marketing  
T: + 44 1744 733757  
F: + 44 1744 27062  
E: val.head@ahkgroup.com  
W: www.ahkgroup.com/

**Kocks Krane International GmbH**

Weserstrasse 64  
Bremen  
D-28757  
Germany



[www.Laidig.com](http://www.Laidig.com)



PIONEERING RECLAIM  
SOLUTIONS FOR 50 YEARS

**LAIDIG'S SUCCESS IS BUILT ON A 50 YEAR HISTORY PIONEERING WORLD CLASS, FULLY-AUTOMATED STORAGE AND RECLAIM SOLUTIONS FOR HARD-TO-HANDLE MATERIALS. A LAIDIG SYSTEM IS MORE THAN WELDED STEEL, IT'S THE PRODUCT OF OUR HIGHLY SKILLED AND DEDICATED TEAM MEMBERS, A COMMITMENT TO LIFETIME SERVICE AND SUPPORT, AND OUR INDUSTRY LEADING GUARANTEE...**

**"IF WE DESIGN, AND INSTALL YOUR STORAGE & RECLAIM SYSTEM, WE GUARANTEE IT WILL WORK."**



#### DOMINATOR™

TRACK DRIVEN RECLAIM SYSTEM FOR  
DOMES & SUPER SILOS. COST EFFECTIVE  
SOLUTION FOR HIGH VOLUME,  
HARD-TO-HANDLE APPLICATIONS.  
UP TO 120'



#### FLUIDIZED SCREW™

HYBRID TECHNOLOGY  
COMBINING AIR SLIDES AND  
MECHANICAL SCREW CONVEYING  
FOR FLUIDIZABLE MATERIALS.  
UP TO 160'



#### X-TRAKTOR™

LAIDIG'S LARGEST AND MOST  
RUGGED RECLAIM SYSTEM  
DESIGNED TO START UNDER A  
FULLY LOADED SILOS OR DOMES.  
UP TO 160'



**TOUGH MACHINES FOR  
TOUGH MATERIALS**



Laidig Systems, Inc. 14535 Dagoon Trail, Mishawaka, IN 46544 USA  
+1 574-256-0204 [sales@laidig.com](mailto:sales@laidig.com)

FIND OUT MORE  
[www.LAIDIG.COM](http://www.LAIDIG.COM)





Contact: Mr Johannes Mosch  
T: + 49 421 6601 311  
F: + 49 421 6601 367  
E: johannes.mosch@kockskrane.de  
W: www.kockskrane.de  
Supplies mechanical ship unloaders with grabs and gantry bulk unloaders. The grab-type ship unloaders incorporate a hopper with a dust chamber and an integral water spraying system.

### Konecranes (France)

47 bis Boulevard de Gravelle  
B.P. 727  
Le Havre  
Cedex  
76060  
France  
Contact: Mr Gerard Lesueur  
T: + 33 2 35 25 95 14  
F: + 33 2 35 25 95 82  
E: gerard.lesueur@konecranes.com  
W: www.konecranes.com

### Konecranes B.V. - The Netherlands

Eikenburglaan 7d  
Rosmalen  
5248 BJ  
The Netherlands  
Contact: Mr A M Versteden  
Job Title: Manager Special Cranes  
T: + 31 735 217 279  
F: + 31 735 217 438  
E: info.nl@konecranes.com

### Konecranes Finland Corporation

PO Box 662  
(Koneenkatu 8)  
Hyvinkää  
FIN-05801  
Finland  
Contact: Mr Kimmo Nyman  
Job Title: General Manager, Bulk Handling Cranes  
T: + 358 20 427 2740  
F: + 358 20 427 2599

E: kimmo.nyman@konecranes.com  
W: www.konecranes.com  
Specialises in the design, manufacture and delivery of large cranes for ports, terminals and shipyards. Konecranes AGD Grab Unloader features simple rope reeving and standard components with less maintenance. Unloading capacities from 1000tph to 4000tph

### Konecranes Hafentechnik GmbH

Mühlenfeld 20  
Langenhagen  
D-30853  
Germany  
Contact: Mr Dirk Groth  
Job Title: Manager Marketing & Sales Support  
T: + 49 511 7704 418  
F: + 49 511 7704 477  
E: info-hafentechnik@konecranes.com  
W: www.konecranes.de  
Services all types of cranes and port handling equipment regardless of manufacturer.

### Kornylak Corporation

400 Heaton Street  
Hamilton  
OH  
45011  
USA  
Contact: Ms Anne G McAdams  
Job Title: Marketing Manager  
T: + 1 513 863 1277 ext35  
F: + 1 513 863 7644  
E: kornylak@kornylak.com  
W: www.kornylak.com  
Produces a variety of freight loading and unloading systems, including roller and conveyor loaders for dry bulk cargoes.

### KPI-JCI and Astec Mobile Screens

700 West 21st Street  
Yankton  
South Dakota  
57078  
USA  
Contact: Mrs Melinda Schweitzer  
Job Title: Marketing Manager  
T: + 1 605 668 2524  
E: melindaschweitzer@kpijci.com  
W: www.kpijci.com  
KPI-JCI and Astec Mobile Screens, Astec companies (NASDAQ: ASTE), is a world-wide leader in manufacturing equipment for the aggregate, construction, paving and recycling industries. As an innovative, high integrity manufacturer, KPI-JCI and Astec Mobile Screens develops quality, state-of-the-art products and has the ability to engineer custom products because of a highly qualified engineering staff. For more information, call (605) 668-2524 or visit the Web site at www.kpijci.com.

### Kramer & Duyvis BV

Mauritsstraat 4  
Zaandam  
1506 TZ  
The Netherlands  
Contact: Mr Rene Blom  
Job Title: Director  
T: + 31 75 612 33 49  
F: + 31 75 612 30 06  
E: info@kramer-duyvis.nl  
W: www.kramer-duyvis.nl  
Over 30 years leading in engineering and manufacturing reliable and economical weighing- and dosing systems for high quality dry bulk materials. For user friendly filling your big-bag, FIBC, tote bin, box or drum. Kramer and Duyvis beltconveyors shall change the

direction of your general cargo.

### Kranunion

Spinnereistraße 13  
Leipzig  
04179  
Germany  
Contact: Ms Gabriela Schilk  
T: + 49 3 41 49 53 212  
F: + 49 3 41 49 53 125  
E: juergen.kuehn@kirow.de  
W: www.kranunion.de

### Kröger Greifertechnik GmbH & Co. KG

Steinheide 1-9  
Sonsbeck  
D-47665  
Germany  
Contact: Dr Philipp Diekmann  
Job Title: Managing Director  
T: + 49 2838 3750  
F: + 49 2838 3729  
E: info@kroeger-greifertechnik.de  
W: www.kroeger-greifertechnik.de  
Manufacturer of grabs. Main products include two rope grabs, four rope grabs, electro-hydraulic grabs and electro hydraulic grabs from 0.5m<sup>3</sup> to 26m<sup>3</sup>.

### K-T Bulk

27920 Osbourn Road  
Bay Village  
Ohio  
44140  
USA  
Contact: Mr Cornel Muhoray  
Job Title: Director  
T: + 1 216 621 9934  
F: + 1 216 835 3981  
E: cmuhoray@ameritech.net

### Lachenmeier Monsun A/S

Grundtvigs Allé 176  
Sønderborg  
6400

Denmark  
Contact: Mr Chrisitan Petersen  
Job Title: Sales Director  
T: + 45 74 42 24 64  
F: + 45 74 43 04 04  
E: mail@lachenmeier-monsun.com  
W: www.lachenmeier-monsun.com  
Designs and supplies complete plants for the handling of grain and feedstuffs. The product programme includes chain conveyors, belt conveyors and bucket elevators for capacities up to 800tph; compressed-air cleaned filters and drying plants for capacities up to 200tph.

### Laidig Systems Inc



14535 Dragon Trail  
Mishawaka  
IN 46544  
USA  
Contact: Mr Mike Schuster  
Job Title: Vice President  
T: + 1 574 256 0204  
F: + 1 574 256 5575  
E: sales@laidig.com  
W: www.laidig.com  
Laidig Systems, Inc. provides custom-engineered bulk storage silos and automated unloading reclaim systems which offer proven performance and reliability. Known throughout the industry for their rugged, high-quality systems, Laidig excels in innovative, effective designs customized to store and reclaim materials with special handling requirements. Materials means, wood chips, sawdust, recycled materials, coal, and other industrial materials.

### Laing O'Rourke

973 Fairfield Road  
Private Bag 3  
Moorooka  
Qld  
4105  
Australia  
Contact: Mr Josh Murray  
T: + 61 7 3308 7619  
F: + 61 7 3892 4371  
E: rlayton@laingorourke.com.au  
W: www.laingorourke.com.au

### Langston Companies Inc

401 East Clay Street  
PO Drawer 350  
Crowley  
LA  
70527-0350  
USA  
Contact: Ms Carla Lomond  
Job Title: Bulk Bag Division Site Manager  
T: + 1 337 783 2010  
F: + 1 337 788 1000  
E: clomond@langstonbag.com  
W: www.langstonbag.com

### Lanier & Associates

4101 Magazine Street  
New Orleans  
Louisiana  
70115  
USA  
Contact: Mr E Sorrell Lanier  
T: + 1 504 895 0368  
F: + 1 504 895 0566  
E: info@lanier-engineers.com  
W: www.lanier-engineers.com  
Consulting and design engineers; construction managers for marine terminals worldwide.

Construction - Earthmoving

Agriculture - Forestry

Mining - Quarrying - Cement

**Material Handling - Utilities**

**Marine - Port Installations**

Water - Chemical - Recycling

Energy - Petrochemical

Plastics - Rubber

Pulp - Paper - Print

Food - Beverage - Tobacco

Industrial Equipment



[www.brevini.com](http://www.brevini.com)

[www.piv-drives.com](http://www.piv-drives.com)

## Solutions for ship unloaders

For many years, PIV Drives and Brevini Riduttori have been industry leaders in power transmission solutions for all kinds of marine, port and material handling applications. PIV and Brevini, both part of Brevini Power Transmission, offer a wide range of products: from standard modular gear reducers to custom solutions for special applications. Our unparalleled quality and reliability are acknowledged worldwide. Through a global sales and service network, we are proud to provide prompt delivery and excellent service.



PIV Drives GmbH - Justus-von-Liebig-Straße 3 - 61352 Bad Homburg - Germany  
Tel. +49 (0)6172-102 0 - Fax +49 (0)6172-102 381 - [info@piv-drives.com](mailto:info@piv-drives.com)



## Larox Flowsys Oy

Marsitie 1  
PO Box 338  
Lappeenranta  
FIN-53101  
Finland  
Contact: Ms Marjatta Kupias  
Job Title: VP, Marketing  
T: + 358 201 113 323  
F: + 358 201 113 300  
E: marjatta.kupias@larox.fi  
W: www.larox.fi  
Pinch valve and hose pump manufacturer providing solutions for abrasive and aggressive applications in various industries all over the world.

## Larsen & Toubro Limited

Monunt Poonamallee Road  
Manapakkam  
PB No.979  
Chennai  
600089  
India  
Contact: Mr Kumar Vikram  
Job Title: ECC Division  
T: + 91 44 2252 6250  
F: + 91 44 22526993  
E: kvikram@intec.com

## Larsen & Toubro Limited

Bldg. 'C'  
Powai Campus  
Gate No. 1  
Saki Vihar Road  
Mumbai  
400072  
India  
Contact: Mr Tapan Sen  
T: + 91 22 67050505 x 3385  
F: + 91 22 67051462  
E: Tapan\_Sen@lntenc.com

## Lassing Dibben Consulting Engineers Ltd

PO Box 472  
149 North Murray Street  
Trenton  
Ontario  
K8V 5R6  
Canada  
Contact: Mr Harold Dibben  
Job Title: Engineering Manager  
T: + 1 613 392 9287  
F: + 1 613 394 4173  
E: info@lassingdibben.com  
W: www.lassingdibben.com  
Lassing Dibben specializes in the field of bulk material handling and extensive experience in this field has given Lassing Dibben the capacity to handle all aspects of system design. The highly qualified engineers and technologists work together to design advanced equipment installations meeting specific customer requirements.

## Lawrence Industries, Inc.

10403 Arbor Trail  
Fort Wayne  
Indiana  
46804  
USA  
Contact: Mr Kerry McAtee  
Job Title: Sales Engineer  
T: + 1 260 432 9693  
F: + 1 260 432 6302  
E: kmatee@lawrenceindustriesnow.com  
W: www.lawrenceindustriesnow.com  
Lawrence Industries, Inc. is a supplier of industrial lining materials that improve bulk material flow in silos, bins, and bunkers. TIVAR 88 is a primary material that is used to eliminate bridging, arching and ratholing. Lawrence Industries designs and fabricates.

## LB Officine Meccaniche S.p.A.

Via Ghiarola Nuova 118/E-F-G  
Fiorano Modenese  
41042  
Italy  
Contact: Mr Erminio Guiducci  
T: + 39 0536 995111  
F: + 39 0536 832812  
E: info@lb-technology.eu  
W: www.lb-technology.eu

## LBU Marine & Cranes

8th floor, Raffles City  
No.268 Xizang Zhong Lu  
Shanghai  
Huangpu District  
200001  
China  
Contact: Ms Cherie Sile Hu  
Job Title: Marketing  
Communications  
T: +86 21 2328 8289  
F: +86 21 2328 8290

## Les Consultants LBCD inc.

40, Rue Ste-Cecile  
Salaberry-de-Valleyfield  
Quebec  
J6T 1L7  
Canada  
Contact: Mr François Giguère  
Job Title: Project Manager  
T: + 1 450 371 5722  
F: + 1 450 371 6955  
E: f.giguere@lbcd.org  
W: www.teknika-hba.com  
Multi-disciplinary engineering consultants with emphasis on potable and waste water treatment and material handling.

## Libran Engineering and Services

C-33, First Floor  
Malviya Nagar  
New Delhi  
110 017  
India  
Contact: Mr Anil Seth  
Job Title: Director  
T: + 91 11 266 71658  
E: libranengineering@gmail.com  
W: www.libranengineering.com

## Librawerk Maschinenfabrik GmbH

Vossenkamp 1  
Braunschweig  
Lower Saxony  
D-38104  
Germany  
Contact: Mr Klein  
T: + 49 531 370980  
F: + 49 531 3709888  
E: info@librawerk.de  
W: www.librawerk.de  
Fully automatic and semi automatic bagging units for open mouth and valve bags for almost all kinds of bulk goods. Big bag filling machines with a weighing range of up to 2,000kg, with capacities from 5 to 60 bags/hour. Fully automatic and semi automatic bagging units for open mouth and valve bags for almost all kinds of bulk goods. Big bag filling machines with a weighing range of up to 2,000kg, with capacities from 5 to 60 bags/hour.

## Liebherr-Hydraulikbagger GmbH

Liebherrstrasse 12  
Kirchdorf  
88457  
Germany  
Contact: Mr Thomas Baeuerle  
T: + 49 7354 80 0  
F: + 49 7354 80 7294  
E: info@lhb.liebherr.com

## Liebherr-Singapore Pte Ltd

No. 8 Pandan Avenue  
Singapore  
609384  
Singapore  
Contact: Mr Yong Soon-Huat  
Job Title: General Manager  
T: + 65 6265 2305 ext 218  
F: + 65 6261 6485  
E: soonhuat.yong@liebherr.com  
W: www.liebherr.com

## Liebherr-Werk Nenzing GmbH



Dr. Hans Liebherr Str. 1  
Nenzing  
A-6710  
Austria  
Contact: Mr Leopold Berthold  
Job Title: Sales Director  
T: + 43 50809 41725  
F: + 43 50809 41447  
E: mobile.harbour.crane@liebherr.com  
W: www.liebherr.com  
The Liebherr-Werk Nenzing GmbH manufactures and markets an extensive range of product lines including ship cranes, offshore cranes, mobile harbour cranes and reachstackers. On the international building machinery market Liebherr is the leading producer of universal duty cycle crawler cranes, lift cranes as well as deep foundation equipment.

## Listenow GmbH & Co.



Dieselstrasse 21  
Rutesheim  
71277  
Germany  
Contact: Mr Carsten Lohr  
T: + 49 7152 50900  
F: + 49 7152 509050  
E: c.lohr@listenow.com  
W: www.listenow.com  
Products manufactured include: - Loading Systems - Loading Hoses (PU-flex, an own brand) - Filters, Positioning Aids (LIS-pos), Folding Steps (LIS-klapp) - Winches

## Lochtec ApS

Bregnerødvej 157Agervang 7  
Kr. Hyllinge  
4070  
Denmark  
Contact: Mr Thomas Locht  
T: + 45 4581 6942  
E: lochtec@lochtec.dk  
W: www.lochtec.dk  
Danish agency representing leading European producers at the Danish marked.

## Logmarin Advisors Srl



Via Iliva, 2/9  
Genova  
16128  
Italy  
Contact: Mr Mario Terenzio  
Job Title: Managing Director  
T: + 39 010 538 5723

E: info@logmarin.net  
W: www.logmarin.net  
Scope of business is to provide an integrated and comprehensive advisory service for marine terminals and associated handling infrastructures both off-shore and on-shore. Logmarin individuals and its associates have pioneered dry-bulk shipping logistics off-shore devising and designing innovative floating terminals, self unloading vessels and floating cranes.

## LogSys NV

Land Van Waaslaan 5  
Haven 1213  
Kallo  
B-9130  
Belgium  
Contact: Ms Sabine Berckmans  
Job Title: Project Manager & Marketing/Sales  
T: + 32 3 755 89 62  
E: sberckmans@logsys.eu  
W: www.logsys.eu  
LogSys has developed LGS.Stevedore, a terminal operating system perfectly suited for dry bulk and multipurpose terminals. Together with other modules for road transport, forwarding, maintenance and repairs, LGS.Stevedore forms the LogSys Global Solution, a full range management system for port logistics.

**LISTENOW**  
VERLADESYSTEME FÜR SCHÜTTGÜTER

**Stop spillage when loading bulk goods!**

Load all your bulk goods efficiently and without harming the environment.  
From **A** for ash to **Z** for zinc.

- ▶ **Tailor-made** Designed to match the product
- ▶ **Effective** Dedusting system
- ▶ **Economic** Robust system design
- ▶ **Flexible** After-sales service
- ▶ **Loading hoses** Made in-house with fast turnarounds

**www.listenow.com**

Listenow GmbH & Co  
Dieselstrasse 21 · D-71277 Rutesheim  
Tel: +49 (0) 71 52 / 50 90 -0 · Fax: -50  
E-Mail: listenow@listenow.com





Hopper cars for ship unloading



## Experience and Know How

Planning,  
manufacturing  
and assembling

Loibl Allen-Sherman-Hoff GmbH  
Arberstr. 40  
D 94315 Straubing Germany  
Phone +49 9421 9256 0  
Fax +49 9421 9256 25

mail@loibl.biz  
www.loibl.biz

Always the right  
solution for  
your material!



Ship loading systems



Conveying systems at the harbor

**Plant  
engineering  
and material  
handling  
technologies**

# Mack

## Manufacturing Grapples & Buckets

### “Quality First”

### Since 1942



[www.mackmfg.com](http://www.mackmfg.com)



7205 Bellingrath Road, P.O. Box 1559, Theodore, Alabama 36590, USA  
Fax: +1-251-653-1365

Email: [sales@mackmfg.com](mailto:sales@mackmfg.com)

Telephone: +1-251-653-9999  
Website: [www.MackMfg.com](http://www.MackMfg.com)



## Loibl Allen-Sherman-Hoff GmbH



Arberstrasse 10  
Straubing  
D-94315  
Germany  
Contact: Mr Jules Fricke  
Job Title: Managing Director  
T: + 49 9421 92560  
F: + 49 9421 925625  
E: jules.fricke@loibl.biz  
W: www.loibl.biz  
For more than 42 years the Plant Engineering and Materials Handling Technology Arthur Loibl GmbH has made conveying and recycling plants for bulk material of all types e.g. ship loading plants; troughed belt, sidewall belt, belt and chain, apron, scraper and troughed chain conveyors; wet slag dischargers, charging boxes; screening and crushing plants.

## Macawber Engineering, Inc

1829 Clydesdale Street  
Maryville  
TN  
37801-3796  
USA  
Contact: Mr John Bell  
Job Title: Process Automation  
T: + 1 800 433 2213  
F: + 1 865 984 5286  
E: macawber@macawber.com  
W: www.macawberengineering.com  
Specializing in low-velocity, dense-phase pneumatic conveying solutions and installations worldwide for over 30 years.

## MacGREGOR Group AB

PO Box 4114  
Gothenburg  
40040  
Sweden  
Contact: Mr Hans Ohlsson  
Job Title: Sales Manager

T: + 46 318 50900  
F: + 46 318 50901  
E: hans.ohlsson@macgregor-group.com  
W: www.macgregor-group.com

## MacGregor SWE AB

Sjögatan 4G  
Örnköldsvik  
SE-891 85  
Sweden  
Contact: Mr Anders Berencsy  
Job Title: Sales Manager  
T: + 46 660 294000  
F: + 46 660 12455  
E: Anders.Berencsy@cargotec.com  
W: www.macgregor-group.com

## Machinefabriek Stramproy SA

Industrieweg 20  
Stramproy  
AP  
6039  
The Netherlands  
Contact: Mr Roel Lebens  
T: + 31 495 56 1532  
F: + 31 495 56 2942  
E: r.lebens@stramproy.nl  
Suppliers of silos.

## Mack Manufacturing Inc



PO Box 1559  
7205 Bellingrath Road  
Theodore  
Alabama  
36582  
USA  
Contact: Mr Matthew A. Davidson  
Job Title: Vice President - Marketing  
T: +1 251 653 9999  
F: +1 251 653 1365  
E: sales@MackMfg.com  
W: www.mackmfg.com

Manufacturing all sizes and styles of grapples and clamshell buckets. Specializing in customized electro-hydraulic, diesel powered, and remote controlled crane attachments.

## Mactenn Systems Ltd.

One Bull Lane  
Acton  
Sudbury  
Suffolk  
CO10 0BD  
UK  
Contact: Mr Lee Suckling  
Job Title: Director, Sales & Application Engineering  
T: + 44 1787 882 422  
F: + 44 1787 882 433  
E: sales@mactenn.com  
W: www.mactenn.com  
Mactenn Systems designs and manufactures dense phase pneumatic conveying systems. As a company we have over 35 years of experience with the conveying of a wide range of bulk materials within our specialist areas of: The Power, Minerals, Chemicals, Food, Biomass, Metals and Plastics industries.

## Mahr GmbH Anlagentechnik für Schuttgüter

Rheingaustrasse 100  
Wiesbaden D-65203  
Germany  
Contact: Herr Dipl.-Ing. Dieter Bee  
Job Title: Marketing Manager  
T: + 49 611 967 64 0  
F: + 49 611 967 64 19  
E: Mahr.Anlagentechnik@t-online.de  
W: www.mahr-gmbh.de

## Manitowoc Engineering

500 South 15 Street  
Manitowoc  
WI 54220  
USA

Contact:  
T: + 1 920 683 6510  
F: + 1 920 683 6277  
E: tcioni@manitowoccranes.com  
W: www.manitowoccranes.com  
Manufacturer of lattice-boom cranes and attachments with lifting capacities from 73 to 1300 tonnes and excavator capacities from 9 to 22.6 tonnes.

## Mantsinen Group Ltd Oy



Valikankaantie 3  
Ylmyly  
FIN-80400  
Finland  
Contact: Ms Mia Mantsinen  
Job Title: Sales and Marketing Director  
T: + 358 20 755 1230  
F: + 358 13 252 5555  
E: mia.mantsinen@mantsinen.com  
W: www.mantsinen.com  
Mantsinen is a forerunner of material handling and logistics in ports, terminals and industry. Mantsinen material handling machines can be tailored to best suit each application. Mantsinen HybriLift® energy saving system and wide range of attachments makes the cranes economical, efficient and universal tools for stevedoring companies and harbour operators.

## Maquinas Condor SA

Av Dos Estados 1383  
Porte Alegre  
RS  
90200-001  
Brazil  
Contact: Mr Carlos Roberto Fritsch  
Job Title: Director  
T: + 55 51 2104 3388

F: + 55 51 2104 3345  
E: condor@maquinascondor.com.br  
W: www.maquinascondor.com.br  
Founded 1959. Engineers and manufactures complete systems for solid bulk materials handling ports and terminals. Equipment range includes pneumatic grain unloading, continuous shiploading, bulk stacking, reclaiming, belt conveyor, bucket elevator and mechanical conveyor. Operating from barges up to capesize ships, to 3000 tph. Shipunloaders and shiploaders operating successfully in ports around the world.

## Marine Inspection and Logistics

408 Richmond Avenue  
Point Pleasant Beach  
New Jersey  
08742  
USA  
Contact: Ms Marylon Cresitelli  
Job Title: inspection Adviser  
T: + 1 732 899 0500  
F: + 1 732 899 0518  
E: mpl@midship.com  
W: www.midship.com

## Marsden Weighing Machine Group Ltd

Anvil House  
Tuns Lane  
Henley-on-Thames  
Oxfordshire  
RG9 1SA  
UK  
Contact: Ms Sally Toher  
Job Title: Marketing Manager  
T: + 44 845 130 7330  
F: + 44 845 130 7440  
E: sallytoher@marsdengroup.demon.co.uk  
W: www.marsden-weighing.co.uk



## Martin Engineering



One Martin Place  
Neponset  
Illinois  
IL 61345  
USA

Contact: Mr Rick Felde  
T: + 1 309 852 2384  
F: + 1 800 814 1553

E: rickf@martin-eng.com  
W: www.martin-eng.com

Martin Engineering makes bulk material handling cleaner, safer and more productive, improving belt conveyors by suppressing dust and spillage, removing carryback and controlling belt tracking. Specialists

in belt cleaners, air cannons, engineered vibration, transfer point technologies, dust management, belt alignment, silo cleaning..

### Martin Engineering c/o GSFA Consulting

115 Etna Road, Suite E  
Lebanon  
NH  
03766  
USA

Contact: Ms Bonnie Govin  
Job Title: Research Analyst  
T: + 1 603 443 9600  
F: + 1 603 443 9911  
E: bgobin@gsfa-consulting.com

### Martin Engineering GmbH

In der Rehbach 14  
Walluf  
D-65396  
Germany

Contact: Mr Michael Hengl  
Job Title: General Manager

T: + 49 6123 978 20  
F: + 49 6123 755 33  
E: info@martin-eng.de  
W: www.martin-eng.de

Equipment for Bulk Material Handling. We make your bulk material handling cleaner, safer and more productive.

### Martin Engineering South Africa

PO Box 12696  
Leraatsfontein  
1038

South Africa  
Contact: Mr Hannes Kotze  
Job Title: Managing Director  
T: + 27 13 656 5135  
F: + 27 13 656 5129

E: hannesk@martin-eng.co.za  
W: www.martin-eng.co.za

Installation & Maintenance of belt cleaners, sealing systems, impact support, belt tracking, air-cannons, screen vibrators, silo cleaning, service contracts, Martin Engineering Service Group - MESH

S Class air supported conveyors, Inertial Flow chutes.

## Maschinen und Mühlenbau Erhard Muhr GmbH



Grafenstraße 27  
Brannenburg  
D-83098

Germany  
Contact: Mr Roland Muhr  
Job Title: Managing Director  
T: + 49 8034 9072 26  
F: + 49 8034 9072 526

E: info@muhr.com  
W: www.muhr.com

MUHR offers a wide range of high quality Bulk Loading Systems (for open and closed, dust-free loading), Loading Spout Positioners, Pneumatically Docking Devices and even Railcar Dumping Systems for economical unloading of trains with open railcars.

## MASS Ltd

Suite 9-10

Compass Point Business Centre  
Southwell Business Park  
Portland  
Dorset  
DT5 2NA  
UK

Contact: Mr David Stevens  
Job Title: CEO  
T: + 44 23 9378 4751

E: david@massitduk.com  
W: www.

marineautosecuritysolutions.com/  
Our product "Guardian" is specific to protecting ships from piracy in the various HRA's of the world.

## Matcon

Matcon House  
London Road  
Morton in Marsh  
Gloucestershire  
GL56 0BJ  
UK

Contact: Mr Simon Gibson  
T: + 44 1608 651666  
F: + 44 1608 651635

E: s.gibson@matcon.co.uk  
W: www.matcon-cone.com

Specialises in powder handling and processing systems for the chemical industry. Manufactures metal powder silos and IBCs.

## MATEC massagoed techniek BV

PO Box 707  
Amersfoort  
3800 AS

The Netherlands

Contact: Mr Marc Fischer  
T: + 31 33 475 2653  
F: + 31 33 472 9724  
E: info@matec.nl  
W: www.matec.nl

An independent distributor. Offers a wide range of bulk handling equipment and components. Bulk-bag handling, tubular chain conveyors, vibrating feeders, sieves, rotary valves, also for high temperature.

## Material Handling Asia

2/70 Tossapoi Land 4 Floor  
14 Bangna-Trad road  
Bangkok  
Bangna  
10260  
Thailand

Contact: Miss Witchanee Namthip  
T: + 66 027443180  
F: + 66 027443177  
E: witchanee@ata-services.com  
W: www.j-tecasia.com/

## Mentor Dynamics

170 Penrod Court  
Glen Burnie  
Maryland  
21061  
USA

Contact: Mr Don Watts  
Job Title: President  
T: + 1 410 760 6349  
F: + 1 410 760 8284

E: don.watts@MentorDynamics.com  
W: www.mentordynamics.com  
Company designs, fabricates, and installs high performance polymer liners for ships, barges and docking facilities.

## Merius Oy

BOX 17 / Satamatie 330  
Kokkola  
67101

Finland  
Contact: Mr Hannu Sarja  
Job Title: Managing Director  
T: + 358 6822 4882

# You CAN control dust & spillage.

© 2013 Martin Engineering Company. For additional information visit [www.martin-eng.com](http://www.martin-eng.com)

Modular Skirtboard

Trac-mounted components

Proper belt support

Effective edge-sealing system

Start with a good foundation: EVO® Transfer Point System

Proper Belt Support: EVO® Combination Cradle



Center rolls reduce friction and require less conveyor drive horsepower than bars. For more info scan code or visit [bit.ly/1dTdyL](http://bit.ly/1dTdyL)

- **Easy to install**  
Wing supports adjust to match any standard trough angle.
- **Easy to maintain**  
Simple bar replacement. Just 2 bolts to remove.
- **Easy to adjust**  
Slots in wing supports allow five degrees of wear adjustment on outer bars.



A Global Company



call 800.544.2947  
visit [martin-eng.com](http://martin-eng.com)  
email [info@martin-eng.com](mailto:info@martin-eng.com)



F: + 358 6822 4883  
 E: hannu.sarja@merius.fi  
 W: www.merius.fi  
 Merius Oy is a mechanical design & engineering company from Kokkola, Finland. We provide conceptual & detailed design, cost calculation and project management services. Our field of expertise consists from logistics planning for industry and ports to steel structure, plant and product design. Our clients are from various fields of industry.

**Merrick Industries**

10 Arthur Drive  
 Lynn Haven  
 FL  
 32444  
 USA  
 Contact: Mr Ron Selbe  
 Job Title: Sales Manager  
 T: + 1 850 265 3611  
 F: + 1 850 265 9768  
 E: info@merrick-inc.com  
 W: www.merrick-inc.com  
 Merrick Industries is the leader in continuous weighing and feeding solutions since 1908. Merrick designs, manufactures, and supports all of our products at our Lynn Haven, Florida, plant for the Cement, Mining, Lime, Gypsum, Steel, and Aggregates industries. Products include belt conveyor scales, weighbelt feeders, impact flowmeters and apron feeders.

**Metso Minerals Industries, Inc.**



Bulk Materials Handling  
 4000 Town Center Boulevard  
 Suite 400  
 Canonsburg  
 PA  
 15317  
 USA  
 Contact: Mr Tom Lippencott  
 Job Title: VP Mining Capital Sales,  
 USA & Canada  
 T: + 1 412 269 5137  
 F: + 1 412 269 5212  
 E: Tom.Lippencott@metso.com  
 W: www.metso.com  
 Manufacturer of large-scale equipment and systems for the handling of minerals and bulk materials in the mining, power, shipping and heavy industrial markets. Along with its products, the company provides field service and replacement parts. Metso Mining & Construction.

**MH Automation International Ltd**

13 Swift Business Centre  
 East Moors  
 Keen Road  
 Cardiff  
 CF24 5JR  
 UK  
 Contact: Mr Robin Evans  
 Job Title: Managing Director  
 T: + 44 2920 253300  
 F: + 44 2920 253303

E: mail@mhai.co.uk  
 W: www.mhai.co.uk

**Midwest Industrial Supply Inc**

PO Box 8431  
 Canton  
 Ohio  
 OH 44711  
 USA  
 Contact: Ms Beth Stewart  
 Job Title: Marketing  
 T: + 1 330 456 3121  
 F: + 1 330 456 3247  
 E: julie.mamula@midwestind.com  
 W: www.midwestind.com  
 A complete line of dust control, erosion control, soil stabilization, lubrication, anti-icing and de-icing products that are developed by their staff of chemists, manufactured in its plants across the US and backed by a complete range of services, equipment, expertise and technical support.

**Midwest International Standard Products, Inc.**

105 Stover Road/ PO Box 438  
 Charlevoix  
 MI  
 49720  
 USA  
 Contact: Mr Walter Pair  
 Job Title: Director of Operations  
 T: + 1 231 547 4000  
 F: + 1 231 547 9453  
 E: sales@midwestinternational.com  
 W: www.midwestmagic.com  
 Founded in 1967. Focuses on dust free loading and stockpiling of dry bulk products. The pre-engineered product line has throughput

capacities to 1400 STPH and useful vertical travels to 45 feet. The engineered systems product line has capacities to 6000 STPH and vertical travels to 100 feet. The dust free shiploading systems are used by governments and industries in over 50 countries.

**Mitchell Consulting Group, Inc**

Green Spring Station  
 PO Box 1116  
 Brooklandville  
 MD  
 21022-1116  
 USA  
 Contact: Mr Walter Mitchell  
 T: + 1 410 828 9371  
 F: + 1 410 828 9372  
 E: mitgroup@verizon.net  
 W: www.mitchellonline.org  
 Mitchell Consulting conducts rigorous research, analysis and advisory into strategic and economic issues relating to marine transportation of all seaborne commodities. Since 1995, our clientele has benefited from keen insight into the markets surrounding local, regional and global seaborne transport of liquids and dry bulk commodities.

**Mitsubishi Heavy Industries**

Steel Structure Systems  
 International Ops Dept.  
 5-1 Marunouchi  
 2-Chome  
 Chiyoda-ku  
 Tokyo  
 100-8315  
 Japan

Contact: Mr Naochika Nanba  
 Job Title: Managing Director  
 T: + 81 3 3212 3111  
 F: + 81 3 3212 9823  
 E: naochika-nanba@hq.mh.co.jp  
 W: www.mhi.co.jp  
 Produces mechanical and pneumatic ship loaders and unloaders, ship-mounted equipment, conveyors and reclaimers, weighing systems and automation equipment.

**Mitsubishi Nagasaki Machinery**

1-2-1 Fukahorimachi  
 Nagasaki  
 Japan  
 Contact: Mr Kazuhiro Aritsuka  
 Job Title: Export Department  
 T: + 81 958 71 6106  
 F: + 81 958 71 3576  
 E: aritsuka@mmm.co.jp  
 W: www.mnm.co.jp

**Mitsui Engineering & Shipbuilding Co**

6-4 Tsukiji  
 5-Chome  
 Chou-ku  
 Tokyo 104  
 Japan  
 Contact: Mr Nakajo  
 Job Title: General Manager  
 T: + 81 3 3544 3398  
 F: + 81 3 3544 3031  
 E: shipsale@mes.co.jp  
 W: www.mes.co.jp

Loaders

Railcar dumpers

www.muhr.com



**Flexicient.**

More flexible. More efficient.

Muhr bulk loading systems  
 MVS | MBG | MBO

The flexible and world-wide largest product range. Closed, open, combined. Of course dust-free. With individual adaptation modules. More efficiency due to a reduction of operating costs by up to 50 %.

Muhr railcar dumpers  
 L-Tec | L-high Tec

Dumps up to ten railcars at the same time without a height limit. Space-saving due to the unique Muhr compact design. More flexible and more efficient.

For more information  
 please call now:  
 +49 (0)8034 9072-0

Muhr GmbH  
 Grafenstraße 27  
 83098 Brannenburg/Germany

info@muhr.com  
 www.muhr.com

**4E** Experienced. Esprit.  
 Efficient. Exact.  
 The Muhr 4E Concept.



Technology  
that translates  
to success.



## Rely on our equipment. Rely on our track record.

Metso railcar dumpers and positioners

For more than a century, Metso railcar dumpers have set the standard for fast, dependable train turnaround. Our custom-designed rotary railcar dumpers – available in single, tandem and triple – service trains of any length or style and handle any bulk material. These systems are engineered to last, and when used with Metso railcar positioners, your operations can be even more effective: Move individual cuts of one to 10 cars or unit trains with more than 200 railcars, and do it all with just one operator.







**Mitsui Miike Machinery Co., Ltd.**

Nihonbashi-Muromachi 2-1-1  
Chuo-ku  
Tokyo  
103-0022  
Japan  
Contact: Mr Hachiro Naito  
Job Title: General Manager,  
Material Handling Machinery  
T: + 81 3 3270 2001  
F: + 81 3 3245 0203  
E: soumu@mitsuimiike.co.jp  
W: www.mitsuimiike.co.jp

**Mitsui Zosen Europe Limited**

Level 16, City Tower  
40 Basinghall Street,  
London  
EC2V 5DE  
UK  
Contact: Mr M Higashino  
T: + 44 20 7256 7171  
F: + 44-20 7256 7272  
E: info@dg.mitsui.com  
W: www.mes.co.jp/english/

**Moffatt & Nichol**

Fifth Floor  
35 Great St Helen's  
London  
EC3A 6HB  
UK  
Contact: Mrs Eva Serrao  
Job Title: Office Manager  
T: + 44 203 2061062  
F: + 44 203 2061061  
E: eserrao@moffattnichol.com  
W: www.moffattnichol.com

**Mogensen Sizers**

Haraxton Road  
Grantham  
Lincolnshire  
NG31 7FF  
UK  
Contact: Mr James Hornsey  
Job Title: Sales Manager  
T: + 44 1476 566301  
F: + 44 1476 590145  
E: james.hornsey@mogensen.co.uk  
W: www.mogensen.co.uk

**Mole-Master Services Corporation™**

27815 State Route 7  
Marietta  
Ohio  
45750  
USA  
Contact: Mr David Laing  
Job Title: General Manager  
T: + 1 740 374 6726  
F: + 1 740 374 5908  
E: contactus@molemaster.com  
W: www.molemaster.com  
Silo, Bin, Bunker, Transport and  
Process Vessel clearing, cleanout,  
cleaning and unclogging services or  
equipment. Mole-Master™ has over  
two decades of experience solving  
material build up problems in over  
33 countries. Safely return any  
storage vessel to original capacity  
fast!

**Möllers Maschinenfabrik GmbH**

Sudhoferweg 93-97  
Beckum  
D 59269  
Germany  
Contact: Mrs Nadine Kipphardt  
Job Title: Head of Marketing  
T: + 49 2521 88 152  
F: + 49 2521 88 100  
E: info@moellers.de  
W: www.moellers.de  
Möllers is a worldwide leading  
manufacturer of machines and  
plants for the automatic filling of  
bulk materials, palletizing and  
loading of bags and other lots as  
well as for the packaging of pallets  
and other dispatch units in shrink  
and stretch films.

**Motherwell Automation**

10 Sangiorgio Court  
Osborne Park  
West Perth  
WA 6017  
Australia  
Contact: Mr Chris Watson  
Job Title: Marketing Manager  
T: + 61 8 9212 4444  
F: + 61 8 9212 4479  
E: townsend@motherwell.net.au  
W: www.motherwell.net.au  
Specialises in industrial control and

automation equipment, including  
PLCs, MMIs and computers.  
Recent contracts have included  
automation of grain terminals.

**Motridal SpA**

Via Pietro Bubba 17  
Piacenza  
Piacenza 29122  
Italy  
Contact: Mr Giampietro Calvi

Job Title: Sales Manager  
T: + 39 0523 59 66 11  
F: + 39 0523 59 01 28  
E: motridal@motridal.com  
W: www.motridal.com  
Specialist, with over 50 years  
experience, in heavy duty, high  
capacity machines, intended for  
operating under severe condition in  
cement factory, harbour terminal,  
steel works, power plant, aluminium  
smelter. Product line includes  
screw, chain, belt and pipe  
conveyors, bucket elevators,  
stackers. Worldwide operation.

**MRS Greifer GmbH**



Talweg 15-17  
Helmstadt-Bargen  
D-74921  
Germany  
Contact: Mrs Karin Greulich  
Job Title: Export Manager  
T: + 49 7263 912 915  
F: + 49 7263 912 912  
E: export@mrs-greifer.de  
W: www.mrs-greifer.de  
Approaching more than 40 years  
experience in producing all types of  
grabs. The company's product  
range extends from mechanical  
grabs, also radio-controlled, to  
hydraulic and electro-hydraulic  
grabs. MRS has an excellent after-  
sales and repair service, provide  
spare parts from stock and supply  
parts for a long period after  
delivery.

**Mühlen Sohn GmbH & Co. KG**

P.O. Box 1165  
Blaustein  
D-89130  
Germany  
Contact: Mrs Karin Albrecht  
Job Title: Sales Manager Fluitex  
T: + 49 7304 801 33  
F: + 49 7304 801 23  
E: albrecht.karin@muehlen-sohn.de  
W: www.muehlen-sohn.de  
Mühlen Sohn GmbH & Co. KG is  
one of the leading suppliers of  
fluidising fabrics and looks back to  
a success story since 1880 which  
means more than 130 years of  
weaving experience. Fluitex® air  
slide fabrics for pneumatic loading  
and unloading systems, airslides for  
pneumatic conveying, storage and  
homogenising silos, discharging  
cones, fly ash handling systems.

**Muller Beltex BV**

Ambachtsweg 28A  
Pijnacker  
2641 KS  
The Netherlands  
Contact: Mr Frits Muller  
T: + 31 15369 5444  
F: + 31 15369 7864  
E: info@mullerbeltex.com  
W: www.mullerbeltex.com  
Produces conveyors and conveyor  
components, including elevator  
belting.

**MUT - Maschinen-**

**Umwelttechnik Transportanlagen**

Schiessstattgasse 49  
Stockerau  
2000  
Austria  
Contact: Mr Alfred Schuch  
T: + 43 22 66 6030

**ROPE GRABS**  
**MOTOR GRABS**  
**HYDRAULIC GRABS**

**in all executions for each handling**

The perfect grabs with unbeatable handling.  
The most economic solution in grab construction.

**MRS Greifer GmbH**  
Talweg 15-17 · 74921 Helmstadt/Germany  
Tel. +49-72 63-91 29-0 · Fax +49-72 63-91 29 12  
email: info@mrs-greifer.de · www.mrs-greifer.de



F: + 43 22 66 603202  
 E: office@m-u-t.at  
 W: www.m-u-t.at  
 Plans, designs and manufactures complete bulk handling plants, including conveyor bridges, troughed chain conveyors and screw conveyors. Manufactures belt- and chain bucket elevators, belt conveyors, trough chain conveyors, bin emptying equipment, rotary feeders, drag chain conveyors, coal feeders and wetslag extractors.

**National Bulk Equipment Inc**  
 12838 Stainless Drive  
 Holland  
 Michigan  
 49424  
 USA  
 Contact: Mr Dave Denhof  
 Job Title: Marketing Manager  
 T: + 1 616 399 2220  
 F: + 1 616 399 7360  
 E: sales@nbe-inc.com  
 W: National Bulk Equipment Inc

**NAVCO (National Air Vibrator Co)**  
 PO Box 40563  
 Houston  
 TX  
 77240-0563

USA  
 Contact: Mr Ann Hutchinson  
 T: + 1 832 467 3636  
 F: + 1 832 467 3800  
 E: ben@navco.us  
 W: www.navco.us

**Nectar Group Ltd**  
 No 1 Ashton Gate  
 Ashton Road  
 Harold Hill  
 Romford  
 Essex RM3 8UF  
 UK  
 Contact: Mr Chris Leonard  
 Job Title: Commercial Manager  
 T: + 44 1708 386 555  
 F: + 44 1708 386 665  
 E: nectar.uk@nectargroup.net  
 W: www.nectargroup.net  
 Nectar Group is involved in handling and bagging of bulk commodities such as wheat, rice, sugar and fertilizers in ports and at inland locations. The Group's main activity includes positioning of its own mobile bagging equipment for handling one-off discharge and bagging contracts, Period Leases or Sales of bagging equipment. Nectar also provides lightening, expediting as well as bulk terminal management and consultancy services.

**Negrini Srl**  
  
 via E. Torricelli n.4  
 Castelfranco Emilia  
 Modena  
 41013  
 Italy  
 Contact: Negrini Massimo  
 T: + 39 059 923110  
 F: + 39 059 920378  
 E: info@negrini.org  
 W: www.negrini.org  
 Negrini company, established in 1967, specializes in engineering and manufacturing a comprehensive range of grabs and buckets for rope machines and crawler mounted cranes. Professionalism and versatility towards different customer demands: this is the business philosophy of Negrini srl.

**Nemag BV**  
  
 Deltastraat 15  
 PO Box 110  
 Zierikzee  
 4300 AC  
 The Netherlands  
 Contact: Mr Riny Stoutjesdijk

Job Title: Sales Manager  
 T: + 31 111 418 900  
 F: + 31 111 416 154  
 E: sales@nemag.com  
 W: www.nemag.com  
 NEMAG specializes in high performance four rope grabs for medium and large scale bulk handling, "lowest handling costs per tonne material transferred" are the key words in NEMAG's philosophy. Also: NEMAG Quick Release Links and Rope Pear Sockets for fast and safe connection of a grab to a crane.

**NEO CORP BRASIL**  
 Avenida Bento Munhoz da Rocha Neto, N°:1777  
 Jardim Samambaia  
 Paranaguá-PR  
 83212-000  
 Brazil  
 Contact: Mr Christopher Paolo  
 T: + 55 41 3122 5771  
 E: christopher@neocorpbr.com.br  
 W: http://neocorpbr.com.br

**NERAK GmbH Fördertechnik**  
 Brigitta 5  
 Hambühren  
 D-29313  
 Germany  
 Contact: Mr Edgar Bleeker

Job Title: Marketing  
 T: + 49 50 84 944 0  
 F: + 49 50 84 944 222  
 E: bleeker@nerak.de  
 W: www.nerak.com

**Neuero Corporation**  
 1201 W Hawthorne Lane  
 West Chicago  
 IL  
 60185-1894  
 USA  
 Contact: Mr Jack Fox  
 Job Title: Sales  
 T: + 1 630 231 9020  
 F: + 1 630 231 6120  
 E: neuero@neuero.com  
 W: www.neuero.com  
 A full service supplier taking projects from the concept stage into design and engineering, manufacturing, on site erection, commissioning, after sales service and maintenance programmes. Mechanical systems with capacities in excess of 3,000 mtph and pneumatic systems with capacities of 1.000 mtph.



# efficient

loading and unloading bulk goods as fast as possible,  
at the lowest possible price per ton of cargo



We produce a full range of four rope grabs for medium and large lifting capacities, an assortment of Quick Release Links and Rope Pear Sockets. Without exception, these are top-quality, excellent performing products for the lowest costs per ton of cargo handled.

**nemag**  handles your bulk

P.O. Box 110 | NL-4300 AC Zierikzee | The Netherlands  
Phone: +31 (0) 111 418 900 | Fax: +31 (0) 111 416 154 | E-mail: [grab@nemag.com](mailto:grab@nemag.com)

[www.nemag.com](http://www.nemag.com)



[www.negrini.org](http://www.negrini.org)

## Neuero Industrietechnik GmbH

### NEUERO

Neuerostrasse 1  
Melle  
D-49324  
Germany  
Contact: Eng Andreas Haeuser  
Job Title: Sales & Project Manager  
T: + 49 5422 9503 26  
F: + 49 5422 9503 50  
E: ha@neuero.de  
W: www.neuero.com  
NEUERO designs and manufactures pneumatic and mechanical ship/barge unloaders and ship/barge loaders, mobile pneumatic conveyors. Capacity range of 30t/h to 2.000t/h. Products: mainly grain, meals, biomass, alumina pet coke, fly ash and others.

## Nilfisk-CFM SpA

Via Porrettana 1991  
Zocca  
Modena  
41059  
Italy  
Contact: Dr Leonardo Bianco  
Job Title: Marketing Manager  
T: + 39 059 973 00 31  
F: + 39 059 973 00 99  
E: info@nilfisk-cfm.com  
W: http://www.cfm.it/  
Leader in the production of industrial vacuums, centralized vacuum systems, high power vacuums and pneumatic conveyors for powders and granules.

## NILOS GmbH & Co KG

Reisholzstrasse 15  
PO Box 970  
Hilden 40709  
Germany  
Contact: Mr Jens Hamacher  
Job Title: Export Manager  
T: + 49 2103 9510  
F: + 49 2103 951 209  
E: jens.hamacher@nilos.de  
W: www.nilos.com

## NKM Noell Special Cranes GmbH

### NKMNOELL SPECIAL CRANES

Postbus 638  
Hoofddorp  
2130AP  
The Netherlands  
Contact: Mr Enno Kramer  
Job Title: Director Product Unit  
Offshore Cranes  
T: + 31 20 655 0030  
F: + 31 20 655 0040  
E: enno.kramer@nkmnoell.com  
W: www.nkmnoellspecialcranes.com

## NM Heilig BV

Newtonstraat 17  
Heerhugowaard  
1704 SB  
The Netherlands  
Contact: Mr Peter Fontein  
T: + 31 72 571 6688  
F: + 31 72 571 6020  
E: info@heiligbv.com  
W: www.heiligbv.com  
For more than 30 years N.M. Heilig B.V. have specialised in designing, developing, producing and installing bulk-handling and recycling installations worldwide. Our key values are quality, durability and service.

## Noell Crane Systems (China) Ltd

China Merchants  
Zhangzhou Development Zone  
Fujian  
363105  
China  
Contact:  
T: + 86 596 6851 888  
F: + 86 596 6851 889  
E: xia.info@terexnoell.com  
W: www.noellchina.com

## Nordströms Konstruktionsbyrå

Storgatan 58  
Umeå  
SE-903 30

Sweden  
Contact: Mr Peter Vedin  
Job Title: Marketing  
T: + 46 90 1136 4500  
F: + 46 90 1330 69  
E: arletun@nordstroems.se  
W: www.nordstroems.se  
Dry bulk vehicle loading spouts.

## Nordstrong Equipment Ltd

400 Ambassador Drive  
Mississauga  
Ontario  
L5T 2J3  
Canada  
Contact: Mr Bill Van Duyen  
Job Title: Sales Manager  
T: + 1 289 562 6402  
F: + 1 289 562 6445  
E: wmvanduy@nordstrongequipment.com  
W: www.nordstrongequipment.com  
Designs and manufactures bulk material handling equipment and systems, including belt conveyors, screw conveyors, drag conveyors, bucket elevators and pipe conveyors.

## North American Crushing & Screening, LLC

322 Lafayette Street  
New Orleans  
Louisiana  
LA 70130  
USA  
Contact: Mr Gilbert Wright  
T: + 1 504 866 0014  
F: + 1 504 866 0016  
E: gwright@nacsllc.com  
W: www.nacsllc.com  
Based in New Orleans, North American Crushing & Screening, LLC (NACS) conducts specialized services for various parties involved with the trading, transportation and handling of commodities. NACS provides portable processing alternatives for bulk cargo. NACS also recycles C&D materials (Asphalt & Concrete) for the construction industry.

## Northern Conveyors

8 Einstein Drive  
Golden Grove  
SA 5125  
Australia  
Contact: Mr Colin Northey  
Job Title: Engineering Manager  
T: + 61 8 8289 1600  
F: + 61 8 8251 4944  
E: enquiries@northernconveyors.com.au  
W: www.northernconveyors.com.au  
Northern Conveyors is a South Australian materials handling company, specialising in design, manufacture and distribution of conveyor products & equipment, including belt & roller conveyors, and all conveyor spares, including rollers, conveyor belts, drives and belt scrapers. Other conveyor services include conveyor design assistance, on-site trouble-shooting and custom conveyor manufacturing.

## NSL ENGINEERING PTE LTD

25 Rawson Street  
Haberfield  
Sydney  
NSW  
2045  
Australia  
Contact: Mr Cameron Hay  
Job Title: Sales & Marketing Manager  
T: + 61 297 972054  
F: + 65 626 11300  
E: cameron@ramspreaders.com  
W: http://www.ramspreaders.com/

## O B Wiik AS

Industriveien 13  
Skedsmokorset  
2020  
Norway  
Contact: Mr Ole Gregersen  
Job Title: Export Director  
T: + 47 64 83 55 00  
F: + 47 64 83 55 01  
E: ole.gregersen@obwiik.no  
W: www.obwiik.no  
O. B. Wiik is a supplier of

relocatable warehouses / Mobile Storage tents. Durable PVC coated fabric covers on clear span steel or aluminium frames 9 – 100 meter. WiikHalls are installed in more than 100 countries.

## Oceanport Shiploaders Ltd

11 Cygnet Crescent  
Dalkeith  
6009  
Australia  
Contact: Mr Stewart Graham  
Job Title: Managing Director  
T: + 61 8 9389 6490  
E: sg@grahamgroup.net.au

## OdT S.r.l.

Via Principe Tommaso, 35  
Torino  
10125  
Italy  
Contact: Ms Nadia Crivellari  
T: + 39 0522 683899  
F: + 39 011 658 936  
E: nadia@verdispa.com  
W: www.odtsrl.com

## OMIC Perth

3/22 Rosco Turn  
Rockingham  
Western Australia  
6168  
Australia  
Contact: Mr Takuyu Ajiro  
T: + 61 8 9592 2281  
E: uyukuta@hotmail.com

## Onestone Consulting Group GmbH

Alte Trift 19  
Buxtehude  
D-216 14  
Germany  
Contact: Dr Ing. Joachim Harder  
Job Title: Management Consultant  
T: + 49 4161 5568 17  
F: + 49 4161 5568 27  
E: consult@onestone.de  
W: www.onestone.de  
Product, market and strategy consulting.

## OP system ab

V Storgatan 26  
OSBY  
SKÅNE  
S-28331  
Sweden  
Contact: Mr Anders Edbro  
Job Title: Key Account Manager  
T: +46 70600093  
F: + 46706117930  
E: anders.edbro@opsystem.se  
W: www.opsystem.se

## Orthos Projects Ltd.

Fernie Road  
Market Harborough  
Leicestershire  
LE16 7PH  
UK  
Contact: Mr Nick Hall  
Job Title: Director  
T: + 44 1858 462806  
F: + 44 1858 464403  
E: nick.hall@orthosprojects.com  
W: www.eandservices.com;  
www.orthosprojects.com  
Since 1977 Orthos Projects have designed, manufactured and installed bulk solids raw materials handling plant to the highest specification. Best qualified to serve the Port, Bulk Handling, Quarry, Foundry, Recycling and related industries, Special purpose machine design, conveyor systems to ISO 9001 (2008).







Multiport M600  
600 t/h capacity  
15 ton payload  
30 m boom

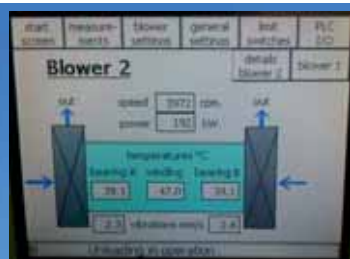

## Turbo Power

Pneumatic Ship Unloader Technical (R)evolution

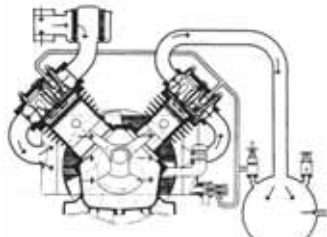

Piston Compressor (<1800)



Roots Blower (1900)



Fan with Air Flow Regulator (1960)



Fan with frequency inverter and automatic belt tension (2000)



TURBO POWER single stage (2009)

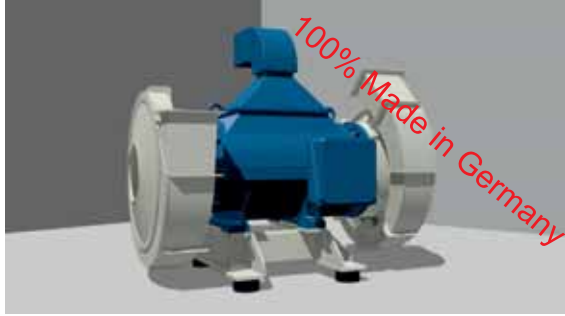

TURBO POWER double stage (2011)

### MULTIPOINT SHIPUNLOADERS ADVANTAGE

- RELIABLE
- LOWEST POWER CONSUMPTION
- EFFICIENT
- 100% BLOWER DIRECT DRIVE - No V-Belts, No cardan joints, No bearing blocks...

With TURBO POWER Direct Drive (single or double) on the motor shaft. With temperature and vibration bearing monitoring control (upper right picture).





[www.orts-grabs.de](http://www.orts-grabs.de)

Orts GmbH Maschinenfabrik • Schwartauer Str. 99  
23611 Seretz • Germany

Tel: +49 451 398 850 • Fax: +49 451 392 374  
Email: [sigvard.orts-jun@orts-gmbh.de](mailto:sigvard.orts-jun@orts-gmbh.de)



**ORTS** GmbH



**ORTS GmbH Maschinenfabrik**



Schwartauer Strasse 99  
Sereetz  
D-23611  
Germany  
Contact: Herr Sigvard Orts  
T: + 49 451 398850  
F: + 49 451 392374  
E: sigvard.orts-jun@orts-gmbh.de  
W: www.orts-greifer.de  
Mechanical single- rope, 2- rope and 4-rope grabs, electro- hydraulic grabs, radio controlled diesel- hydraulic grabs. Belonging crane equipment. All clamshell designs and sizes. TAILOR made!  
Constructed and manufactured in Germany. 40 years of experience.

**PAGE MACRAE ENGINEERING**

61 Aerodrome Road  
Mount Maunganui  
Bay of Plenty  
3116  
New Zealand  
Contact: Mr Bruce Ennis  
Job Title: Cargo Handling  
Equipment Manager  
T: + 64 7 575 5079 Ext 810  
F: + 64 7 574 8594  
E: brucee@page-macrae.co.nz  
W: www.page-macrae.co.nz  
Bulk cargo operators require equipment, solutions and expertise to help reduce dust emissions at discharge, whilst maintaining maximum unloading productivity. Page Macrae provides that technology and expertise. 50 years of experience of designing and manufacturing cargo handling equipment make Page Macrae a leader - offering a combination of loading and unloading solutions

that will protect the environment without compromising bulk discharge productivity.

**PAM Poul Andersen Maskinfabrik A/S**

Vejlevangen 5  
Kerteminde  
DK - 5300  
Denmark  
Contact: Mr Erik Andersen  
Job Title: Director  
T: + 45 65 32 12 41  
F: + 45 65 32 43 53  
E: pam@pam.dk  
W: www.pam.dk  
Produces 'PAM' suction/blowing mobile pneumatic units for loading and unloading of grain and other free-flowing granular materials. Produces diesel and electrically driven units with capacities of 20 to 150 tph.

**Parker Plant Ltd**

Viaduct Works  
Canon Street  
Leicester  
Leicestershire  
LE4 6GH  
UK  
Contact: Mr Richard Fothergill  
Job Title: Marketing Manager  
T: + 44 116 266 5999  
F: + 44 116 261 0812  
E: sales@parkerplant.com  
W: www.parkerplant.com

**Paul Hedfeld GmbH**

Hundeicker Strasse 20  
Gevelsberg  
58285  
Germany  
Contact: Mr Burkhard Hedfeld  
T: + 49 2332 6371  
F: + 49 2332 61167  
E: hedfeld@hedfeld.com  
W: www.hedfeld.com  
Manufacturer of elevator buckets and screw flights.

**Pavan Group Srl**

Via Monte Grappa, 8  
Galliera Veneta (PD)

35015  
Italy  
Contact: Ms Monica Giantin  
T: + 39 049 942 3111  
F: + 39 049 942 3303  
E: marketing02@pavan.com  
W: www.pavan.com  
Specialized leaders with 60 years experience in the design and engineering of technologies for the food industry. We provide industrial solutions for - machines and manufacturing lines for the production of pasta - cereal milling plants - rice milling plants - animal feed milling plants - mechanical and pneumatic ship unloaders, ship loaders, grain handling and storage

**PEBCO®**

PO Box 7506  
225 North 4th Street (42001)  
Paducah  
KY  
42002-7506  
USA  
Contact: Mr David Finke  
Job Title: Sales and Marketing  
T: + 1 270 442 1996  
F: + 1 270 442 5214  
E: sales@pebco.com  
W: www.pebco.com  
PEBCO® is acknowledged throughout the world in the field of moving, controlling and loading dry bulk materials. PEBCO's resources and responsibilities include customized gates, valves, mass flow feeders, dustless loading spouts, telescopic chutes, and truck, ship and railcar loadouts. (Owner of North American Patent for Cleveland Cascade® Chute.)

**PEMA Verpackung**

Carl Zeiss Strasse 10  
Syke  
28857  
Germany  
Contact: Mr Raake  
T: + 49 42 42 53 93 0  
F: + 49 42 425 02 09  
E: raake@pema-verpackung.de

**Peterson Agricare & Bulk Logistics BV**

Boompjes 270  
Rotterdam  
3011 XZ  
The Netherlands  
Contact: Mr Arno Maehlmann  
T: + 31 10 282 3333  
F: + 31 10 282 3282  
E: info@peterson.nl  
W: www.peterson.nl  
Specialists in supply chain services for all kinds of bulk materials and offers: inspection, gauging barges, draft surveys, bunker surveys, on/off hire surveys, stockpile control, sampling, preparation, analyses, testing and verification, bias testing of mechanical samplers and management of JIT supplies

**Pfister Waagen Bilanciai GmbH**

Linker Kreuthweg 9  
Affing-Mühlhausen  
D-86444  
Germany  
Contact: Ms Susanne Geller-Dürr  
Job Title: Marketing and Sales  
Manager  
T: + 49 82 07 9 58 99 28  
F: + 49 82 07 9 58 99 29  
E: marketing@pfisterwaagen.de  
W: www.pfisterwaagen.de  
Suppliers of innovative, high quality, fully electronic weighing systems, incorporated in data networks, capturing and processing weighing data in cost-efficient control systems. Truck weighbridges, railway scales, platform scales, weighing indicators, weighing data software, load cells and load cell units.

**PHB Weserhütte, S.A.**

Parque Científico y Tecnológico de Gijón  
C/Luis Moya Blanco 82  
Gijón  
Asturias  
33203  
Spain  
Contact: Dr Jose Ramón Prado  
Job Title: Technical Commercial

Director  
T: + 34 985 13 41 71  
F: + 34 985 13 42 22  
E: joseramon.prado@pwh.es  
W: www.pwh.es  
Engineering Company an EPC Contractor with more than 60 years of experience in material handling installations. In the last 5 years has developed more than 50 projects around the World in countries such as México, USA, Spain, India, Morocco, Libya, Dominican Republic, Brasil, Turkey.

**Phelps Industries**

PO Box 1093  
Little Rock  
Arkansas  
72203  
USA  
Contact: Mr John Phelps  
Job Title: Sales  
T: + 1 501 375 1141  
F: + 1 501 375 6568  
E: jpsales@phelpsindustries.com

**Phenix Rousies Industries**

Rue de Maubeuge  
Rousies  
59131  
France  
Contact: Mr Frederic Lepretre  
Job Title: Export Sales Manager  
T: + 33 03 27 69 42 42  
F: + 33 3 27 64 95 85  
E: lepretre.export@silos-phenix.com  
W: www.silos-phenix.com  
Produces dust controlling covers for belt conveyors and steel storage silos ranging from 25m3 to 9610m3. Each silo is fitted with an integrated gantry and an aeration system.

**PHOENIX Conveyor Belt Systems GmbH**

Hannoversche Strasse 88  
Hamburg  
21079  
Germany  
Contact: Mr Bernd Kuesel  
T: + 49 40 7667 2205  
F: + 49 40 7667 2773  
E: info@phoenix-cbs.com  
W: www.phoenix-conveyor-belts.com  
PHOENIX serves the worldwide bulk handling industry with textile and steel cord conveyor belts. Technological masterpieces in combination with 110 years of experience in conveyor belt production make PHOENIX conveyor belts the first choice for highest reliability and performance.

**PINTSCH BUBENZER GmbH**

Friedrichshüttenstraße 1  
Kirchen-Wehbach  
RLP  
57548  
Germany  
Contact: Mr Arno Weil  
Job Title: Director of Sales  
T: + 49 27 41 9488480  
F: + 49 27 41 948844  
E: arno.weil@pintschbubenzler.de  
W: www.pintschbubenzler.de  
PINTSCH BUBENZER is focused on the design, production and service of high quality braking systems for both static and dynamic applications which involve the precise control of small to very large amounts of kinetic energy. The challenge is to control that energy in the most efficient, cost-effective way.





PLM 520 – PLM 825

- Shipboard cranes
- Mobile cranes
- Harbour cranes
- Trolley cranes
- Bucket wheel unloaders
- Pontoons
  
- Dredging
- Bulk handling
- Hoisting
- Pile-driving.
  
- Diesel-Hydraulic
- Electric-Hydraulic
- Electric
- Capacity up to 4000 ton/hour



PLM BWU2500

**PLM Cranes B.V.**  
**Sluisweg 21-25**  
**4794 SW Heijningen**  
**The Netherlands**

**T: +31 (0)167 – 528 510**  
**F: +31 (0)167 – 524 444**  
**E: [info@plmcranes.com](mailto:info@plmcranes.com)**  
**W: [www.plmcranes.com](http://www.plmcranes.com)**



PLM T450

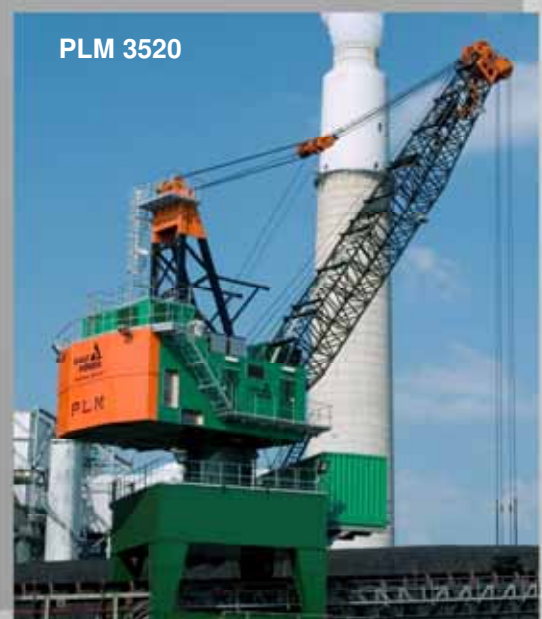

PLM 3520



## Pirs SAS



ZI St Hermentaire  
309, Avenue de l'Europe  
Draguignan  
Var  
83300  
France  
Contact: Mr Fikri El Mourabet  
Job Title: International Sales  
Manager  
T: + 33 4 98 10 6767  
F: + 33 4 98 10 6768  
E: info@domepirs.com  
W: www.domepirs.com  
Storage solutions for dry bulk  
commodities.

## PIV Drives GmbH - a Brevini Power Transmission Co.



Justus-von-Liebig-Straße 3  
Bad Homburg  
D-61352  
Germany  
Contact: Mr Bernard Rensinghoff  
Job Title: Marketing Manager  
T: + 49 6172 102 648  
F: + 49 6172 102 380  
E: bernard.rensinghoff@brevini.com  
W: www.piv-drives.com or  
www.brevini.com  
PIV Drives, a company of Brevini  
Power Transmission, has over 80

years experience in providing  
quality power transmission  
solutions for every industry sector.  
PIV Drives developed modular  
concepts for its comprehensive  
product range, providing the  
flexibility to deliver high-quality  
optimised solutions, both standard  
and bespoke, quickly and at  
competitive cost.

## Plantragg Developments

4 Wold View  
Caistor  
Lincoln  
Lincolnshire  
LN7 6UU  
UK  
Contact: Mr Bob Harrison  
Job Title: Director  
T: + 44 1472 852 498 or + 44 7973  
832 741  
F: + 44 1472 852 498  
E: ptag.dev@talktalk.net  
W: www.plantragg.co.uk  
Manufacturers and suppliers of  
patented 'Vibrorig' vibratory  
equipment used to free 'hung' cargo  
from ships frames or ribs. The  
Company has been supplying this  
market for twenty years and has a  
number of satisfied 'repeat' clients  
who now have reduced their ship  
turnround time.

## Plastruct-Polyzone

4305 Springcreek Road  
Vineland  
Ontario  
LOR 2C0  
Canada  
Contact: Mr Nick Koppelaar  
Job Title: CEO  
T: + 1 905 563 4000  
F: + 1 905 563 0228  
E: nick@polyzone.com

W: www.polyzone.com  
Designer, manufacturer and  
professional installer of lining  
systems for the toughest bulk  
material flow issues for hoppers,  
bins, conveying, classifiers chutes,  
fluidizing beds. Specialists in  
providing flow, abrasion, impact and  
corrosion solutions for bulk solids.

## PLM Cranes B.V.



Sluisweg 21-25  
Heijningen  
4794 SW  
The Netherlands  
Contact: Mr Pieter Pulleman  
Job Title: Managing Director  
T: + 31 167 528510  
F: + 31 167 524444  
E: info@plmcranes.com  
W: www.plmcranes.com  
We build hydraulic and electric  
cranes from 50 to 2000 tm with a  
transhipment capacity up to approx.  
2000 ton/hour. We are specialized  
in shipboard cranes, mobile cranes  
and harbour cranes for dredging,  
transhipping, hoisting and pile-  
driving.

## Polymer Industries - Ultrapoly

**Division**  
2404 Center Street  
Tacoma  
WA  
98409-7638  
USA  
Contact: Mr Bryan Olin  
T: + 1 253 272 1217  
F: + 1 253 272 1457  
E: bryan.olin@polymerindustries.com  
W: www.polymerindustries.com

Tough, self-lubricating Ultra Poly  
Ultra High Molecular Weight  
polyethylene provides durable  
protection for metal surfaces and  
eliminates noise associated with  
metal-on-metal contact. And its  
slick, nonstick properties assure  
unimpeded flow of materials, even  
under wet, sticky or freezing  
conditions.

## Port Contractors

529 Terminal Ave  
New Castle  
DE  
19720  
USA  
Contact: Mr Anthony Develli  
Job Title: VP Commercial  
T: + 1 704 756 6793  
E: tdevelli@portcontractors.com  
W: www.portcontractors.com

## Portasilo Ltd

New Lane  
Huntington  
York  
YO3 9PR  
UK  
Contact: Mr Steve Stannard  
Job Title: Proposals Manager  
T: + 44 1904 624 872  
F: + 44 1904 611 760  
E: bulk@portasilo.co.uk  
W: www.portasilo.co.uk  
The Bulk Handling Division  
manufactures a range of silo  
discharge products, including  
'Rotoflo', 'VibroFlo', 'Osciflo' and  
'Augerflo' discharge valves as  
'SiloFlo' aeration devices

## Portpack UK Limited

Unit A2/G11 Enterprise Business  
Park  
Wigwam Lane

Hucknall  
Nottinghamshire  
NG15 7SZ  
UK  
Contact: Ms Sharon Henson  
Job Title: General Manager  
T: + 44 1159 680130  
F: + 44 1159 641926  
E: portpack@portpack.biz  
W: www.portpack.biz

## Port-Trade ApS



Karetmagervej 9  
Fredericia  
DK 7000  
Denmark  
Contact: Mr Peter J Muller  
Job Title: Sales Manager  
T: + 45 7628 0102  
F: + 45 7628 0103  
E: peter.muller@port-trade.com  
W: www.port-trade.com  
Port-Trade is a Danish company  
with more than twenty years of  
experience with cargo handling  
systems, including mobile harbour  
cranes, container spreaders, bulk  
handling grabs, and loading  
equipment. Port-Trade provides  
analyses of customer requirements  
and proposes and delivers  
complete equipment solutions.

## Powerscreen International

200 Coalisland Road  
Dungannon  
Co Tyrone  
BT71 4DR  
UK  
Contact: Mrs Michelle Killen  
Job Title: Marketing  
T: + 44 288 77 18500  
F: + 44 288 77 47231

# Our Experience – Your Advantage



Umeå Hamn



Grenaa Havn



Norske Skog



Port of Kokkola

Your Partner in Scandinavia



Also for used equipment

www.port-trade.com Tel.: +45 7628 0102

PIRS SAS, the leading European builder of reinforced concrete domes, launches new website so check it out :

[www.domepirs.com](http://www.domepirs.com)



This is a unique portal dedicated to information on **Agridome®** and **Domeconcept®** technologies. The new site sets out to highlight and reflect PIRS expertise in two markets : **Industrial bulk Storage** and **Architectural facility**.

Looking for a solution for industrial bulk storage or an architecture facility, feel free to contact our sales team at [info@domepirs.com](mailto:info@domepirs.com).

PIRS SAS IN FIGURES :

- **30 years of experience** in dome building
- **150 domes built** worldwide
- **1,600,000t** of dry bulk product stored
- **260,000 m²** of inflated domes

Follow us to discover our new corporate videos and all our latest news !



facebook



Dailymotion



E: sales@powerscreen.com  
W: www.powerscreen.com

### Powertex Inc

1 Lincoln Boulevard  
New York  
New York  
12979  
USA  
Contact: Mr George Bombardier  
Job Title: Vice President Sales and Marketing  
T: + 1 518 297 4000  
F: + 1 518 297 2634 / 2242  
E: georgebombardier@powertex.com  
W: www.powertex.com  
Manufacturer: Seabulk liners for 20' and 40' ocean containers, using woven, virgin grade PE film, and foil for moisture sensitive products, aeration and fluidizing liners for stubborn flowing products. Manufacturing facilities in U.S., China and India.

### Precia-Molen Nederland BV

Franse Akker 1  
Breda  
4824 AL  
The Netherlands  
Contact: Mr Frédéric Felten  
Job Title: Export Manager  
T: + 31 76 524 2510  
F: + 31 76 522 8039  
E: frederic.felten@preciamolen.nl  
W: www.preciamolen.nl  
Has provided weighing solutions to industry for more than 147 years. World wide reputation for quality and reliability. After-sales service and preventative maintenance programmes ensure customers have complete confidence in the accuracy and reliability of installations.

### Precia-Molen UK Ltd

Walkers Road  
North Moons Moat  
Redditch  
Worcs  
B98 9HE  
UK  
Contact: Mr John Swinburne  
Job Title: Managing Director  
T: + 44 1527 590 300  
E: john.swinburne@preciamolen.co.uk

### Premier Tech Chronos B.V.

Meerheide 40  
Eersel  
5521 DZ  
The Netherlands  
Contact: Mr Ingo Jonas  
Job Title: Managing Director  
T: + 31 497 51 49 88  
F: + 31 497 51 49 53  
E: info-eu@ptchronos.com  
W: www.ptchronos.com  
Chronos BTH supply bulk weighers and controllers for intake / outloading free-flowing bulk materials. Complementing these is a range of material handling, bagging and palletising systems, and the Containerpak™ mobile bagging unit. Chronos BTH incorporates Richard Simon, BTH, Verville and Premier Tech Systems for European spares, refurbishments, service, installation / commissioning.

### Premier Tech Chronos GmbH

Löhestrasse 18  
Hennef  
53773  
Germany  
Contact: Mr Ingo Jonas  
Job Title: Managing Director  
T: + 49 2242 9335 0



F: + 49 2242 9335 186  
E: info-eu@ptchronos.com  
W: www.ptchronos.com  
Chronos BTH supply bulk weighers and controllers for intake / outloading free-flowing bulk materials. Complementing these is a range of material handling, bagging and palletising systems, and the Containerpak mobile bagging unit. Chronos BTH incorporates Richard

Simon, BTH, Verville and Premier Tech Systems for European spares, refurbishments, service, installation / commissioning.

### Premier Tech Chronos Ltd

Unit 1, Centurion Business Centre  
Blenheim Industrial Estate  
Nottingham  
Notts

NG6 8WN  
UK  
Contact: Mr Mike Simmonds  
Job Title: Sales Director  
T: + 44 115 935 1351  
F: + 44 115 960 6941  
E: info-eu@ptchronos.com  
W: www.ptchronos.com  
Chronos BTH supply bulk weighers and controllers for intake / outloading free-flowing bulk

materials. Complementing these is a range of material handling, bagging and palletising systems, and the Containerpak mobile bagging unit. Chronos BTH incorporates Richard Simon, BTH, Verville and Premier Tech Systems for European spares, refurbishments, service, installation / commissioning.

# Join the revolution!

in containerised bulk handling  
with **RAM Revolver®**

**Low Cost**  
**Fast to Market**  
**Dust Free**



**RAM UK +44 1695 556355**

Email us at: [sales.uk@ramspreaders.com](mailto:sales.uk@ramspreaders.com)

[www.ramspreaders.com](http://www.ramspreaders.com)

**RAM**  
**SPREADERS**



© Joffrey Capone Photographie

**“A MAN WHO STOPS ADVERTISING  
TO SAVE MONEY IS LIKE A MAN WHO  
STOPS A CLOCK TO SAVE TIME”**

**- Henry Ford**

To find out how you can benefit from advertising in the world's only monthly dry  
bulk publication contact Jason Chinnock or Andrew Hucker-Brown on:  
Tel: +44 (0)1206 562560 Fax: +44 (0)1206 562566 Email: [info@dc-int.com](mailto:info@dc-int.com)

**DCI** **DRY CARGO**  
*international*



**Primasonics International Limited**

North Lakes Business Park  
Flusco  
Penrith  
Cumbria  
CA11 0JG  
UK  
Contact: Mr Donald Cameron  
Job Title: Managing Director  
T: + 44 17684 80372  
F: + 44 17684 80374  
E: sound@primasonics.com  
W: www.primasonics.com;  
www.quattrosonics.com  
Acoustic cleaners and silo cleaning systems.

**Procon Engineering Limited**

Vestry Estate  
Otford Road  
Sevenoaks  
Kent  
TN14 5EL  
UK  
Contact: Mr Joe Naylor  
Job Title: Sales Manager -  
Beltweighers  
T: + 44 1732 781 300  
F: + 44 1732 781 311  
E: joe.naylor@proconeng.com  
W: www.proconeng.com

**PSTek LLC**

Thorwesten Vent GmbH  
2409 Traci Drive  
Pittsburgh  
PA  
15237  
USA  
Contact: Mr Scott Larkin  
T: + 1 412 366 6303  
F: + 1 412 366 6303  
E: ScotLarkin@aol.com  
W: www.thorwesten.com  
PSTek is the exclusive US and Canadian sales representative and aftermarket service provider for Thorwesten Vent of Beckum, Germany.

**PT Bajra Mandalasakti**

Graha Mobilis, 2nd Floor  
Jl. Buncit Raya No. 139  
Jakarta  
Selatan  
12075  
Indonesia  
Contact:  
T: + 62 21 799 1323  
F: + 62 21 799 1308  
E: enquiries@ptbms.net  
W: www.ptbms.net

**PT Bukaka Teknik Utama**

Jl. Raya Bekasi Narogong Km  
19,5 Cileungsi Bogor  
Jakarta  
16820  
Indonesia  
Contact: Mr Achmad Kalla  
Job Title: Director  
T: + 62 21 823 1146  
F: + 62 21 823 2323  
E: bdv@bukaka.com  
W: www.bukaka.com

**PT Jakarta Prima Cranes**

Wisma JPC  
Jl. Mampang Prapatan Raya No. 20  
Jakarta  
12760  
Indonesia  
Contact:  
Job Title: Marketing Manager  
T: + 6221 799 2772  
F: + 6221 799 2442  
E: edy-sianturi@jpc.co.id  
W: www.jpc.co.id

**PT Pamapersada Nusantara**

Jln. Rawagelam I No. 9  
Kawasan Industri Pulogadung  
Jakarta  
13930  
Indonesia  
Contact: Mr. Sudiarso Praseto  
Job Title: President Director  
T: + 62 21 460 2015 Ext 211  
F: + 62 21 460 1916  
E: busdev@pamapersada.com  
W: www.pamapersada.com

**PT SpanSet Indonesia**

Jl. Yos Sudarso Kav. 48 No. B9  
Jakarta Utara  
Jakarta  
14350  
Indonesia  
Contact: Mr Mario Harben  
Job Title: Business Development  
Manager  
T: + 62 21 650 9556  
F: + 62 21 650 9566  
E: sales@spanset.co.id  
W: www.spanset.co.id

**PT Thiess Contractors Indonesia**

Ratu Prabu 2 Ratu Prabu 2  
Jl. TB. Simatupang Kav. 18  
Jakarta  
12560  
Indonesia  
Contact: Mr. Matahara  
Job Title: Business Development  
Manager  
T: + 62 21 2754 9999  
F: + 62 21 2754 9800  
E: thiess@thiess.co.id  
W: www.thiess.co.id

**PT. Bando Indonesia**

Wisma Hayam Wuruk, 6th floor,  
Suite 600  
Jln. Hayam Wuruk No. 8  
Jakarta  
10120  
Indonesia  
Contact: Mr Wahyono Wardiman  
Job Title: Conveyor Belt Division  
T: + 62 21 3517590  
F: + 62 21 3517591  
E: conveyor.div@bandoindonesia.com  
W: www.bandoindonesia.com  
PT. Bando, established in 1987, is one of the leading automotive and industrial power transmission belt manufacturers in Indonesia. It has one main plant located in Tangerang and its marketing office located in Central Jakarta.

**Quadrant Engineering Plastics**

**Products**  
2120 Fairmont Avenue  
Reading  
PA  
19612  
USA  
Contact: Mr Brad Siebt  
T: + 1 260 479 4283  
F: + 1 260 478 1074  
E: bradley.seibt@qplas.com  
W: www.systemtivar.com  
For more than 30 years Quadrant's SystemTIVAR Engineering Group has been providing flow, abrasion, impact and corrosion solutions in the field of bulk material handling using TIVAR 88 to line a wide array of process equipment including ship holds, bins, bunkers, silos, chutes, railcars, off-road trucks, on-road trucks, etc.

**Quadrant PHS**

Woodhouse Road  
Tadmorden  
Lancs  
OL14 5TP  
UK  
Contact: Mr Dave Liveoy  
Job Title: Logistics Department  
T: + 44 1706 811 000  
F: + 44 1706 817 571  
E: dave.liveoy@qplas.com  
W: www.polyhisolidur.com

**Quality Handling Systems Pty Ltd**

6 Metters Place  
Wetherill Park  
Sydney  
NSW  
2164  
Australia  
Contact: Mr Peter Taylor  
Job Title: Project Manager  
T: + 61 2 9756 1921  
F: + 61 2 9756 4212  
E: ptaylor@qhs.com.au  
W: www.qhs.com.au  
Quality Handling Systems Pty Ltd (QHS) is an Australian company specialising in the design and manufacture of sampling systems for bulk materials. QHS have experience with sampling a wide range of materials using the various international standards.

**Qube Ports & Bulk**

Level 22  
44 Market Street  
Sydney  
NSW  
2000  
Australia  
Contact: Mr Paul White  
T: + 61 2 9005 1100  
F: + 61 2 9005 1101  
E: paul.white@qube.com.au  
W: www.qube.com.au/ports-and-bulk

**R & S S.r.L.**

Via del Cmapo Sportiuo 40  
Mezzana  
48123  
Italy  
Contact: Ms Sara Mandarini  
Job Title: Head of Advertising  
T: + 39 0535618 205  
F: + 39 0544411 099  
E: sara.mandarini@wamgroup.com  
W: www.roncuzzi.com  
A great piece of italian history and tradition combined with the most accurate and innovative engineering in bulk handling and movimentation.

**RAM Spreaders**



6 Selby Place  
Stanley  
Skelmersdale  
Lancashire  
WN8 8EF  
UK  
Contact: Mr Patrick Draper  
Job Title: PR & Communication  
T: + 44 1695 556355  
F: + 44 1695 556356  
E: p.draper@ramspreaders.com  
W: www.ramspreaders.com/  
RAM Spreaders, one of the leading manufacturers and suppliers of container handling equipment for over 40 years have developed their environmental friendly RAM Revolver® for dust free containerized bulk handling solutions in association with specialist container suppliers.

**RAP Conveyors Ltd**

Conveyor House  
Turner Crescent  
Loomer Road Industrial Estate  
Chesterton  
Newcastle  
Staffordshire ST7 7LU  
UK  
Contact: Mr David Southern  
Job Title: Managing Director  
T: + 44 1782 566440  
F: + 44 1782 566835  
E: info@rapconveyors.co.uk  
W: www.rapconveyors.co.uk  
Supplies a wide range of conveyor belting, including the complete range of 'Starflex', 'Betahete', 'Starhete', 'Deltahete' and 'FRCDM' oil-resistant and chevron belting from Fenner Dunlop Belting.

**Rapat Asia**

Clark, Philippines  
Angeles  
Pamapaga 061  
Philippines  
Contact: Mr Craig Stall  
Job Title: General Manager  
T: + 1 2182514261  
F: + 1 2184833344  
E: cstall@rapat.com  
W: www.rapat.com

**Rapat Corporation**

919 O'Donnell Street  
Hawley  
MN 56549-4310  
USA  
Contact: Mr Ron Werner  
Job Title: General Manager  
T: + 1 218 483 3344  
F: + 1 218 483 3535  
E: info@rapat.com  
W: http://www.rapat.com/

**Rapidpack Corporation**

PO Box 38356  
Suite 2907, Dubai  
UAE  
Contact: Mr Peter Ascot  
Job Title: Sales Manager  
T: + 97 144 458 335  
F: + 97 144 458 337  
E: peter@rapidpack.ca  
W: www.rapidpack.ca  
Rapidpack designs, engineers and manufactures mobile bulk bagging machines, grabs, ship loaders and ancillary equipment for cargo handling in port and/or inland departments. Our clients include leading trading houses and shipping companies around the world.







[www.rblrei-france.com](http://www.rblrei-france.com)

## BULK UNDER CONTROL



Overland Conveyor



Hopper

Stacker



Loader / Unloader

Process



### CONTACT US /

Z.A Les Landes  
BP 50159 49481 S' Sylvain d'Anjou  
Tél : + 33 (0)2 41 21 19 40  
Fax : + 33 (0)2 41 21 19 59

### HEAD OFFICE /

11, Boulevard Brune  
75682 PARIS Cedex 14  
Tél : + 33 (0)1 53 90 22 40  
Fax : + 33 (0)1 53 90 22 24

[contact@rblrei-france.com](mailto:contact@rblrei-france.com)



**RBL-REI France**



11 Boulevard Brune  
Paris  
Cedex 14  
75682  
France  
Contact: Mr Sébastien Bouhours  
Job Title: Technical Sales Representative  
T: + 33 2 41 21 19 40  
F: + 33 2 41 21 19 59  
E: s.bouhours@rblrei-france.com  
W: www.rblrei-france.com  
A merger between two French companies specialised in bulk handling equipment. RBL - a leader in handling equipment. REI - known worldwide for its expertise in long-distance and curved conveyors. REI is also specialised in conveyors fitted with belt storage for tunnel excavation.

**RC Inspection B.V**



**RC INSPECTION**

Gustoweg 66  
Rotterdam  
NL 3029  
The Netherlands  
Contact: Mr Kees  
Maarschalkeweerd  
T: + 31 10 4250240  
F: + 31 6 20741355



E: kees.maarschalkeweerd@rc-inspection.com  
W: www.rc-inspection.com/  
An independent, privately owned inspection company operating in the field of dry bulk commodities, metals and marine survey related services. Main operational centers in Rotterdam, Johannesburg and Hong Kong, with office and field staff operating in more than 40 countries. We provide an independent, fast and reliable service with a direct people to people approach.

**RDS Technology**

Cirencester Road  
Minchinhampton  
Stroud  
Gloucestershire GL6 9BH  
UK  
Contact: Mr Mark Evans  
Job Title: Business Development Manager

T: + 44 1453 733300  
F: + 44 1453 733311  
E: info@rdstec.com  
W: www.rdstec.com  
RDS Technology specialises in the design and manufacture of a wide range of on-board weighing systems to suit any application, from Wheeled Loader to Telehandler. Products include the new LOADMASTER a100 for use in the most difficult conditions and terrains and the WEIGHLOG a10 for compact loaders.

**REMA TIP TOP GmbH**

Business Unit Industrie  
Gruber St. 63  
Poing  
Bavaria  
D-85586  
Germany  
Contact: Mr Andreas Munder  
T: + 49 8121 707 245  
F: + 49 8121 707 222

E: info@tiptop.de  
W: www.rema-tiptop.com  
REMA TIP TOP Industrie claims to be the world leader in high-quality conveyor maintenance, wear protection and corrosion protection. With a worldwide service network of more than 190 partners and 15 subsidiaries very close relationships can be maintained with customers.

**Renby Ltd**

Tarvin Mill  
Barrow Lane  
Tarvin  
Chester CH3 8JF  
UK  
Contact: Mr Robin Travis  
T: + 44 1829 741009  
F: + 44 1829 740 574  
E: info@renby.co.uk  
W: www.renby.co.uk  
Specialist in dust contained and dust tight conveying in particular a

range of dust tight conveyors. Also the home of MicronFog(TM) fogging systems for dust suppression, odour control and humidification. UK and Ireland agents for Schrage Rohrkettensystem GmbH, (tube chain conveyors); Spiro BV (Static moving floors).

**Rexnord Industries Inc**

4800 W. Mitchell St  
Milwaukee  
WI  
53214  
USA  
Contact: Mr Ken Piper  
T: + 1 414 643 2365  
F: + 1 414 643 3725  
E: ken.piper@rexnord.com  
W: www.rexnord.com

**YOUR GLOBAL INSPECTION PARTNER**

**Metals | Minerals  
Ores | Ferrous Scrap  
Non Ferrous Scrap  
Coal | Coke  
Pet Coke | Anthracite  
Maritime Services**

**RC Inspection**  
Gustoweg 66  
3029 AS Rotterdam  
The Netherlands  
+31 (0)10 425 02 40  
info@rc-inspection.com  
www.rc-inspection.com



## RHC Heavy Handling Machinery Limited



Am Taennele 6  
Senden-Aufheim  
Bayern  
D-89250  
Germany  
Contact: Mr Rolf Hofmann  
Job Title: CEO  
T: + 49 7307 237 15  
F: + 49 7307 253 39  
E: info@rhcheavymachinery.com  
W: <http://rhcheavymachinery.com/>  
RHC is a company registered in Germany and Hong Kong. It also

has offices in Shanghai/China and Incheon/Korea. Main customers are metallurgy, shipbuilding and ports. Core business is focused on material handling systems such as cranes, mobile carriers, ship loading and unloading systems, etc.

## RHC Heavy Machinery Ltd

China Office Shanghai  
Lane 1288, Room 2004  
Man Ma You Road  
Pudong, Shanghai  
China  
Contact: Mr Rolf Hofmann  
T: + 852 8199 7916  
F: + 852 822 62666  
E: info@rhcheavymachinery.com  
W: <http://rhcheavymachinery.com/>

## Risun Technologies

357 West 6160 South  
Murray  
Utah 84107  
USA  
Contact: Mr Bill Whitney  
Job Title: Vice President, Business Development  
T: + 1 801 305 4241  
F: + 1 801 281 8787  
E: andyw@risuntech.com  
W: [www.risuntech.com](http://www.risuntech.com)  
Risun Technologies is a multi-discipline engineering firm specializing in material handling, terminal design and broad scope projects requiring innovative concepts to solve difficult problems. Specialty areas include silo design, monolithic dome storage with automated reclaim systems and

control packages with system integration for projects using several different equipment vendors.

## River Consulting

445 Hutchinson Ave  
Suite 740  
Columbus  
OH  
43235  
USA  
Contact: Ms Cari Kessler  
Job Title: Marketing Assistant  
T: + 1 614 890 3456  
F: + 1 614 890 1883  
E: ksmith@riverconsulting.com  
W: [www.riverconsulting.com](http://www.riverconsulting.com)  
River Consulting is a leading Mid-Major A/E to Global energy, food, process and industrial clients. We deliver multidiscipline engineering and project management solutions for challenges of every size, including major capital investments as well as facility and process expansions. We combine the capability of a full-service firm with the responsiveness and flexibility of a specialty engineering practice.

## Robson Handling Technology

Geo. Robson & Co. (conveyors) Ltd.  
Coleford Road  
Sheffield  
S9 5PA  
UK  
Contact: Mr John Skidmore  
Job Title: Sales Manager  
T: + 44 114 244 4221  
F: + 44 114 243 3066  
E: skidmorej@robson.co.uk  
W: [www.robson.co.uk](http://www.robson.co.uk)  
Geo Robson & Co Limited is a family company for over three generations. The company has built an enviable reputation for over 100 years for the design, manufacture, installation and commissioning of robust, reliable, Bulk Material Handling Conveyor systems. Producing a vast range of products to suit many industries. Able to produce bespoke designs for every application.

## RockTree Logistics Pte. Ltd.

3 Church Street  
#24-01/02  
Samsung Hub  
Singapore  
049483  
Singapore  
Contact: Mr Daniele Pratalongo  
T: + 65 6622 65 10  
F: + 65 6622 65 11  
E: info@rocktree.sg  
W: [www.rocktree.sg](http://www.rocktree.sg)  
RockTree Logistics Pte. Ltd. Designs customised logistics that manage the complete transshipment aspect of your supply chain for all dry bulk commodities. Our goal is to get your dry bulk moving on schedule, saving you time and money in the process.

## RJS Siloclean International Ltd

Crowcroft Road Industrial Estate  
Nedging with Naughton  
Ipswich  
Suffolk IP7 7HR  
UK  
Contact: Mr Jason Johnson  
Job Title: Marketing  
T: + 44 1449 740 051  
F: + 44 5600 767 753  
E: info@rjssiloclean.co.uk  
W: [www.rjssiloclean.co.uk](http://www.rjssiloclean.co.uk)

## RKR Gebläse und Verdichter GmbH

Braasstr. 16  
Rinteln  
31737  
Germany  
Contact: Mr Lothar Stoll  
T: + 49 57 51 40 04 0  
F: + 49 57 51 40 04 30  
E: info@rkr.de  
W: [www.rkr.de](http://www.rkr.de)  
RKR Gebläse und Verdichter GmbH is your expert partner for anything associated with blowers and compressors for oil-free air supply. A highly qualified team of engineers and technicians plans, designs, installs and tests customized compressed solutions.

## Roberts & Schaefer Company

222 South Riverside Plaza  
Chicago  
Illinois  
60606-3986  
USA  
Contact: Mr Ike Miller  
Job Title: Business Development Mgr  
T: + 1 312 236 7292  
F: + 1 312 726 2872  
E: rs@elginindustries.com  
W: [www.r-s.com](http://www.r-s.com)  
We are a full service engineering & construction company specializing in designing & erecting bulk material handling systems.

## Ronin GMS

No 1 Nobel Avenue  
Modderfontein  
Johannesburg  
Gauteng  
1645  
South Africa  
Contact: Mr Ferdinand Meyer  
Job Title: Sales and Marketing Manager  
T: + 27 11 608 3666  
F: + 27 11 608 4679  
E: ferdi@roningms.com  
W: [www.roningms.com](http://www.roningms.com)  
Ronin GMS supplies grain management system solutions, analytical grading equipment and grain handling services to the Southern African Grain Handling and Storage Industry. This includes: - real time, independent inventory measurement and management systems - transactional software packages - identity tracking solutions - in bin temperature control, management and aeration - Near Infra Red Transmittance devices for measuring protein - Image Analysers for measuring specks and ash content - service & support for analytical instrumentation - Silo Auditing service.



Material Handling systems for Ports:  
Shiploader and Ship-unloaders  
Gantry and Level Luffing Cranes  
Mobile Material Handlers  
Stacker and Reclaimer  
Conveyor Systems



**RHC Heavy Machinery Ltd.**



**Royal Bodewes**

Werfkade 22  
Hoogezand  
9601 LG  
The Netherlands  
Contact:  
T: + 31 598 39 31 31  
E: info@bodewesshipyards.nl  
W: www.royalbodewes.com

**Royal Haskoning DHV**



George Hintzenweg 85  
Rotterdam  
3068 AX  
The Netherlands  
Contact: Ms Berte Simons  
Job Title: Director Advisory Group  
T: + 31 10 2865 398  
F: + 31 10 443 3688  
E: info@rotterdam.royalhaskoning.com  
W: www.royalhaskoning.com  
Royal Haskoning harbours the knowledge and practical experience that is indispensable in the development of modern ports and (un)loading, transport and storage systems. Our services cover all stages of project development and we are dedicated to finding solutions aimed at improving and optimising our clients' business activities in the field of dry bulk handling, processing and storage.



**RTA ALESA Ltd.**

**RTA Alesa**

Max Hogger-Strasse 6  
Zurich  
CH - 8048  
Switzerland  
Contact: Mr Hanspeter Stahl  
T: + 41 44 435 33 33  
F: + 41 44 435 33 66  
E: hanspeter.stahl@riotinto.com  
W: www.rtaalesa.com  
Specialized in supplying complete material handling systems including pneumatic unloaders and dense phase conveyors for alumina, cement, chemicals, powders, grain, petroleum coke, rock phosphate and granular materials.

**Rubb Buildings Ltd**

Dukesway  
Team Valley Trading Estate  
Gateshead  
Tyne & Wear  
NE11 0QE  
UK  
Contact: Mr Ian Hindmoor  
Job Title: Sales Manager  
T: + 44 191 482 2211  
F: + 44 191 482 2516  
E: info@rubb.co.uk  
W: www.rubb.co.uk  
Builds warehouses, stores and workshops for the storage and handling of bulk cargo.

**Rud Kettenfabrik**

Aalen Underkochen  
D-73428  
Germany  
Contact: Ms Marina Grupp  
Job Title: Marketing & PR  
T: + 49 7361 504 1463  
F: + 49 7361 504 1288  
E: marina.grupp@rud.com  
W: www.RUD.de

**RULMECA HOLDING S.P.A.**

Via A Toscanini 1  
Almé  
Bergamo  
24011  
Italy  
Contact: Mr Carsten Spanggaard  
Job Title: Group Sales Director  
T: + 39 035 430 0111  
F: + 39 035 545 700  
E: rulmece@rulmece.it  
W: www.rulmece.com  
Steel rollers, heavy-duty rollers, medium- and light- duty rollers, anticorrosion rollers for salty and chemically aggressive environments; troughing and self aligning sets manufactured according to all major international standards; garland systems with 2, 3, 4, 5 rollers employed in conveyors loading areas; idler pulleys and drums, with or without bearings for all belt widths.

**SABS - Mining & Minerals**

PO Box 413  
Richards Bay  
KwaZulu Natal  
3900  
South Africa  
Contact: Ms Audrey Ndlovu  
Job Title: Operations Manager  
T: + 27 35 797 7209  
F: + 27 35 797 7212  
E: ndlovua@sabs.co.za  
Provides a holistic range of sampling, analytical and product certification services to the solid-fuel and mineral industries. In addition to its core values of Accredited Quality (ISO 17025), integrity, accuracy and speed, also offered is a very competitive pricing structure resulting in product samples for analysis being received from around the world.

**Saiag Industria SpA**

Strade Brandizzo 130  
Volpiano  
I-10088  
Italy  
Contact: Mr Moro Marco  
Job Title: Sales Manager  
T: + 39 0 11 9822111  
F: + 39 0 11 9822301  
E: mmoro@comital.com  
W: www.saiag.it

**Salzgitter Maschinenbau AG/PEINER SMAG Lifting Technologies GmbH**

Windmühlenbergstrasse 20-22  
Salzgitter  
D-38259  
Germany  
Contact: Mr Arnulf Köhnmann  
T: + 49 5341 302 613  
F: + 49 5341 302 424 or 606  
E: arnulf.koehnmann@peiner-smag.com  
W: www.peiner-smag.de  
Manufacturer and supplier of a complete range of grabs, i.e., (electro-hydraulic) motor grabs, single-rope grabs, two- and four-rope grabs, hydraulic grabs as well

as rotators (slewing units) and special grabs for all kinds of bulk materials for various applications and purposes.

**Sammi**

Via Tuderte, 388  
Narni Scalo  
Terni  
05036  
Italy  
Contact: Mr Daniele Bellezza  
Job Title: Engineer  
T: + 39 0744 733832  
F: + 39 335 5313331  
E: daniele.bellezza@sammi.it  
W: www.sammi.it  
Making plant and machinery for the bulk handling industry for over 35 years, from designing to material selection, from assembly and implementation to maintenance and after-sales technical assistance. Sammi directly controls the entire business cycle and is strongly oriented towards product development and design. Our team of designers ensures continual technical innovation - a distinguishing feature of the Company.



# Talk to the Royal HaskoningDHV Dry Bulk Port & Terminal Professionals

**STUDIES**

- Master planning
- Feasibility
- Infrastructure
- Logistics
- Environmental Impact
- Due Diligence

**PROJECT SERVICES**

- Study, Design and Engineering
- Supplier and Equipment selection
- Tendering and Contracting
- Project and Contract Management
- Construction Management
- Commissioning

**OUR PROFESSIONALS**

- Dry Bulk Handling Experts
- Port Planners
- Environmental Experts
- Marine Experts
- Civil, Mechanical and Electrical Engineers

Johan Pruisken – Director Advisory Group  
johan.pruisken@rhdhv.com  
+31 62906586 / +31 102865445

royalhaskoningdhv.com

# RTA Alesa

## The market's choice



Sustaining efficiency with RTA Alesa reliable and environmental friendly transport systems to handle your dry bulk cargo.

RTA Alesa, your materials handling partner.  
[www.rta-alesa.com](http://www.rta-alesa.com)

### Switzerland

T +41 (0) 44 435 33 33  
F +41 (0) 44 435 33 66

### France

T +33 (4) 42 65 21 48  
F +33 (4) 42 51 48 33

### Canada

T +1 (514) 937 91 05  
F +1 (514) 937 04 73

### Australia

T +61 (3) 97 69 26 46  
F +61 (3) 97 69 25 35

# Rio Tinto Alcan





**Sampling Associates International**

PO Box 338  
Newport News  
Virginia  
23607-0338  
USA  
Contact: Mr Paul Reagan  
Job Title: President  
T: + 1 757 928 0484 ext 100  
F: + 1 757 928 0482  
E: preagan@samplingassociates.com  
W: www.samplingassociates.com

**SAMSON Materials Handling Ltd**



Gemini House  
Cambridgeshire Business Park  
1 Bartholomew's Walk  
Ely, Cambridgeshire  
CB7 4EA  
UK  
Contact: Mr Andy Blythe  
Job Title: Managing Director  
T: + 44 1353 665001  
F: + 44 1353 666734  
E: sales@samson-mh.com  
W: www.samson-mh.com  
The equipment portfolio includes an extensive range of Mobile Stackers (Stormajor®) and Shiploaders, Link

Conveyors, Eco Hoppers plus the Samson® Material Feeders for bulk materials reception. The SAMSON mobile concept offers an economical alternative to conventional fixed installations and represents a unique approach to the bulk cargo handling in ports and terminals requiring a high degree of mobility and flexibility.

**Samson Materials Handling Ltd**

Unit 3B, 30F, 148 Electric Road  
Hong Kong  
Hong Kong  
Contact: Mr Timothy Burden  
Job Title: Area Sales Manager  
T: +85291528863  
F: +85236954311  
E: tim.burden@samson-mh.com

**Sandvik Mining**

Sandviken  
SE-81181  
Sweden  
Contact: Mr Göran Carlbaum  
Job Title: Sales Support Manager  
T: + 46 26 262000  
F: + 46 26 260230  
E: info.smc@sandvik.com  
W: mining.sandvik.com  
Sandvik Mining and Construction is one of the leading suppliers of drilling, crushing and turn-key bulk

material handling equipment using continuous material handling technologies (bucket wheel, scraper, conveyor,...) to stack, load/reclaim and haul bulk material. Integrated solutions and products are designed to specific customer requirements and engineering, project management and operation services are offered worldwide.

**Sandvik Mining**

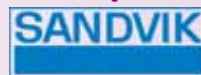

Materials Handling GmbH & Co KG  
Vordernberger Strasse 12  
Leoben  
A-8700  
Austria  
Contact: Mr Stefan Dötsch  
Job Title: Marketing Communications Manager - Mining Systems  
T: + 43 3842 2077 835  
F: + 43 3842 2077 201  
E: stefan.doetsch@sandvik.com  
W: www.sandvik.mining.com  
A company within the business area Sandvik Mining of the Sandvik Group and a leading global supplier in continuous mining and bulk materials handling in stockyards and ports, offering a wide range of

equipment for mechanical excavation, crushing and conveying. Other equipment includes: Bucket wheel excavators, Beltwagons, Spreaders, Fully- and semi-mobile crushing plants, Stationary crushing plants, Transport crawlers.

**Sandvik Mining and Construction (China) Co., Ltd.**

No.986, Baota Rd  
Jiading District  
Shanghai  
201821  
China  
Contact: Mr Zhang Jianyuan  
Job Title: Vice President, Surface Mining  
T: + 86 21 6916 6050  
F: + 86 21 6916 6025  
E: jianyuan.zhang@sandvik.com  
W: www.sandvik.com

**SANWA COMMERCIAL CO., LTD.**

13-20 Irieoka - cho, Shimizu - ku,  
Shizuoka -city  
Shizuoka  
424-0839  
Japan  
Contact: Mr Masao Butsi  
Job Title: President  
T: + 81 543536 121

F: + 81 54352 6390  
E: sccsanwa@blue.ocn.ne.jp  
W: http://www.scc-sanwa.jp

**Sartorius Mechatronics T&H GmbH**

Meiendorfer Strasse 205  
Hamburg  
D-22145  
Germany  
Contact: Mr Johannes Kratz  
Job Title: Marketing Manager  
T: + 49 40 67960303  
F: + 49 40 67960383  
E: info.mechatronics@sartorius.com  
W: www.sartorius.com  
Designs weighing and batching equipment for grain handling.

**SCAFCO Corporation**

PO Box 11215  
6200 East Main  
Spokane  
Washington  
99211-1215  
USA  
Contact: Mr Bruce Katahira  
T: + 1 509 3439000  
F: + 1 509 535 9130  
E: mail@scafc.com  
W: www.scafc.com





## Scantech International



PO Box 1485  
Springwood  
Queensland  
4127  
Australia  
Contact: Mr Henry Kurth  
T: + 61 7 3710 8406  
F: + 61 7 3710 8499  
E: sales@scantech.com.au  
W: www.scantech.com.au  
World leader in process control solutions for conveyed bulk materials. On-belt analysers with proven technologies. Reliable, accurate and dependable ash, moisture and elemental measurement minute by minute. Control quality through blending or monitor specification compliance. Over 1,000 installations.

## SCHADE Lagertechnik GmbH



Dorstener Strasse 360  
Herne D-44653  
Germany  
Contact: Mr Karl-Heinz Fiegenbaum  
Job Title: Managing Director

T: + 49 2325 58740  
F: + 49 2325 587474  
E: sales@schade-lagertechnik.com  
W: www.schade-lagertechnik.com  
SCHADE Lagertechnik GmbH is a leading supplier for stockyard technology including longitudinal and circular stockyards, blending beds, tripper cars, bridge- and portal-type stackers and reclaimers as well as wagon unloading systems. Founded in 1879, the company has been part of the AUMUND Group since 2001.

## Schenck Process Africa (Pty) Limited

1 Crusher Road  
Crown Ext. 3  
Johannesburg  
Gauteng  
2092  
South Africa  
Contact: Mr Thabo Khumalo  
T: + 27 11 837 9656  
F: + 27 11 837 7458  
E: tkhumalo@schcnkprocess.co.za  
W: www.schenckprocess.co.za  
Supplies a wide variety of bulk materials weighing equipment, including static controllers and loadcells as well as belt weighers and flow meters.

## Schenck Process GmbH

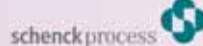

Pallaswiesenstr 100  
Darmstadt  
Hessen  
D-64293  
Germany  
Contact: Ms Heike Trautmann  
Job Title: Marketing Communication Manager  
T: + 49 61 51 1531 2987  
F: + 49 61 51 1531 66  
E: info@schcnkprocess.com  
W: www.schenckprocess.com

Whether you are planning processing plants, feeding bulk solids, controlling material flow, recording commodity flow, weighing goods or automating manufacturing and transportation operations - Schenck Process is your reliable partner.

## Schenck Process UK Limited

Carolina Court  
Lakeside  
Doncaster  
South Yorkshire  
DN4 5RA  
UK  
Contact: Mr Paul Markwell  
Job Title: Marketing Manager  
T: + 44 1302 321 313  
F: + 44 1302 554 400  
E: enquiries@schcnkprocess.co.uk

W: www.schenckprocess.co.uk  
Schenck Process is the global market leader of solutions in measuring and process technologies in industrial weighing, feeding, measuring, conveying, filtration and automation. Schenck Process develops, manufactures and markets a full range of solutions, products and turnkey systems on the basis of combining process engineering expertise, reliable components and field-proven technology.

## Schenck Process UK Ltd T/A Redler

Redler House  
Dudbridge  
Stroud  
Gloucestershire  
GL5 3EY  
UK  
Contact: Mr Andrew Workman  
Job Title: Director - Bulk Materials Handling  
T: + 44 1453 761 784  
F: + 44 1453 763 582  
E: sales@redler.com  
W: www.redler.com  
Leading supplier of plant for handling dry bulk materials. Extensive knowledge of many technologies involved in different materials handling installations enables the offering of complete system solutions. The resources

are in place from a single machine through to the supply of a major port and terminal project.

## Schouten Commodities BV

Burgstraat 12 4283 GG Giessen  
4284 GG  
The Netherlands  
Contact: Mr Marius van Doorn  
Job Title: Commercial Manager  
T: +31 183-446451  
E: info@schoutenproducts.com  
W: www.schoutenproducts.com

## Scorpio Engineering Pvt. Ltd

Scorpio House  
132 Wheeler Road  
Cox Town  
Bangalore  
560 005  
India  
Contact: Mr Jacob P.  
Job Title: VP - Marketing & Application  
T: + 91 99801 625 39  
F: + 91 80 2548119  
E: jacob@scorpioengg.com  
W: www.scorpioengg.com  
Scorpio is a turnkey engineering and manufacturing company in bulk materials handling concentration on ports and port handling systems for dry bulk cargo. A 50000 sqft manufacturing facility on a 5 acre plot augments our core engineering and design capabilities.





Circular Stockyard with Cantilever Reclaimer, coal

## Stockyard Solutions



Bridge-type Reclaimer, wood pellets



Combined Stacker / Reclaimer, sulphur prills

**Proven Technology, Quality,  
Strength and Reliability for**

- Stacking
- Storing
- Blending
- Reclaiming

**of a wide range of bulk materials  
in all kinds of industries worldwide**

**SCHADE**  
AUMUNDGROUP





# HOW WE OPTIMIZE YOUR MATERIALS HANDLING PROCESS? **THIS WAY!**

Operations everywhere rely on bulk materials handling systems for continuous performance. Sandvik has steadily developed into a technological frontrunner and leading global supplier of some of the world's most impressive machines for stockyards and other operations.

Rely on Sandvik to make your mining business more efficient and more competitive.

Join the movement towards **The Future of Mining.**  
It's This Way: [mining.sandvik.com](http://mining.sandvik.com)





Experienced service and start up engineers can get projects running in quick time. A strong design team underscores our technology orientation. At Scorpio, we sell technology.

## Sea Spec International

5 Manor Green  
Nth Frodingham  
Driffield  
East Yorkshire  
YO25 8JH  
UK  
Contact: Mr Mike L Coles  
Job Title: Company Proprietor  
T: + 44 1262 488 500  
F: + 44 1262 481200  
E: mikecoles@seaspec.eclipse.co.uk

## Sea Transport Corporation

PO Box 1043  
Southport  
QLD  
4215  
Australia  
Contact: Mr Ross Ballantyne  
T: + 61 7 5529 5777  
F: + 61 7 5529 5177  
E: ross@seatransport.com  
W: www.seatransport.com

## Seabulk Inc



Suite 150  
10271 Shellbridge Way  
Richmond  
British Columbia  
V6X 2W8  
Canada  
Contact: Mr Sidney Sridhar  
Job Title: President  
T: + 1 604 273 1378  
F: + 1 604 273 1358  
E: sbs@seabulk.com  
W: www.seabulk.com  
Design and build contractors for  
bulk materials handling ports

involving shiploading/unloading and storage systems. Seabulk provides integrated shipping solutions from 'mine to mill' for dry bulk and liquid bulk cargo. Developed World's largest gravity reclaim ore transshipper. Also involved in design/construction of civil and marine structures.

## S-E-G Instrument AB

Box 111 43  
Bromma  
S-161 11  
Sweden  
Contact: Ms Eva Söderholm  
Job Title: Assistant  
T: + 46 8 764 74 00  
F: + 46 8 764 75 00  
E: inform@s-e-g.com  
W: www.s-e-g.com

Producer of belt scales, massflow meters and other industrial weighing equipment.

## Selpeco Resources Inc.

14150 NE 20th Street  
F1, PMB342  
Bellevue  
WA  
98007  
USA  
Contact: Mr S E (Steve) Laccinole  
Job Title: President  
T: + 1 425 952 4463  
F: + 1 425 822 1235  
E: selpeco@selpeco.com  
W: www.selpeco.com  
A bulk solids handling engineering and program management consultant serving the cement, pulp and paper, energy, mining and port





# Online Analysis

## Mineral Analysis

Elemental and Moisture content of

- Copper
- Iron Ore
- Manganese
- Zinc
- Nickel
- Phosphate

**Coal Analysis: Moisture, Ash, Sulfur, Calorific value**



Real time analysis for the:

- Mine
- Concentrator
- Sinter Plant
- Port
- Power Station



*On belt Real Time Analysers:*

- Over 1,000 installations worldwide
- Superior technologies
- Remote access, low maintenance and local support
- Safe and reliable
- 30 years of proven performance
- More than 100 African applications



**Scantech**

Tel Aus: +61 737 108 406  
 Tel RSA: +27 832 559 792  
[www.scantech.com.au](http://www.scantech.com.au)  
[sales@scantech.com.au](mailto:sales@scantech.com.au)



*Measure, Control, Improve... Minute by Minute*







industries. Selpeco has a partner company, Braco Consultants, in Brazil and a strategic alliance with FLSmidth/Koch/MVT in the U.S. and western hemisphere. Primary service is program management of complex material handling projects, from planning through commissioning.

#### Sempertrans France Belting Technology SAS

Sempertrans Marketing  
10 rue des charretiers  
Argenteuil Cedex  
95104  
France  
Contact: Ms. Catherine Flichy  
T: + 33 1 30 25 72 00  
F: + 33 2 39 80 46 16  
E: contact@sempertrans-france.com

W: www.sempetrans.com  
SEMPERTRANS has been developing, manufacturing and installing conveyor belts for more than 50 years. Its knowhow, its experience and the quality of its products make SEMPERTRANS one of the world's leading companies in its field.

#### SENNEBOGEN Maschinenfabrik GmbH

Hebbelstrasse 30  
Straubing  
D-94315  
Germany  
Contact: Mr Bernhard Kraus  
T: + 49 9421 540143  
F: + 49 9421 43882  
E: marketing@sennebogen.de  
W: www.sennebogen.com

Sennebogen offers a wide range of all kinds of materials handling machines, HD rope excavators/cranes, crawler cranes, telescopic cranes and base carriers.

#### Sensor Technology Ltd

Apollo Park  
Ironstone Lane  
Wroxton  
Banbury  
Oxon  
OX15 6AY  
UK  
Contact: Mr Mark Ingham  
Job Title: Sales Manager  
T: + 44 1869 238400  
F: + 44 1869 238401  
E: info@sensors.co.uk  
W: www.sensors.co.uk  
Suppliers of TORQSENSE &

LOADSENSE sensors and transducers, TorqSense, the world's first low cost non-contact rotary torque transducers and LoadSense wireless load transducers.

#### Sentry® Equipment Corp

966 Blue Ribbon Circle North  
Oconomowoc  
Wisconsin  
53066  
USA  
Contact: Ms Doris Hoeft  
Job Title: Marketing Director  
T: + 1 262 567 7256 x 157  
F: + 1 262 567 4523  
E: dorish@sentry-equip.com  
W: www.sentry-equip.com  
Supplier of manual and automatic samplers for bulk solids, powders, slurries, liquids and gases.

#### Servo Berkel Prior

Jan Evertsenlaan 4  
Katwijk  
2224 SV  
The Netherlands  
Contact: Mr Erwin van Diest  
Job Title: Managing Director  
T: + 31 71 4030101  
F: + 31 71 4032317  
E: info@servoberkelprior.eu  
W: www.servoberkelprio.eu  
Offers bunker weighers and duplex weighers for in/outtake and bulkloading; automatic net weighers; special weighing equipment; conversion sets for all conventional weighers.

## Small differences count. And now they come in large too.



### **Schenck Process crane scales – high precision as standard. Even at 480 t.**

Our crane scales for power-driven winches and hoists are always high precision and satisfy the important EN 14492 and VDI 3570 standards „Overload protection for cranes“. We provide complete solutions for weighing technology, overload measurements and accessories.

And if you need it, we can comply with up to Category 3, Performance Level d, according to EN ISO 13849.

we make processes work



**SESCOTRANS (SAE)**

1 c EL Shahid sayed Zakarya st.  
Cairo  
11361  
Egypt  
Contact: Mr Ahmed Hassan  
Job Title: VP & CEO  
T: + 2 222679115  
F: + 2 222679449  
E: ahmed@sescotrans.net  
W: www.sescotrans.com

**SEW-EURODRIVE GmbH & Co KG**

P O Box 3023  
Bruchsal  
D-76652  
Germany  
Contact: Mr Manfred Müller  
T: + 49 7251 75 0  
F: + 49 7251 75 1970  
E: sew@sew-eurodrive.de  
W: www.sew-eurodrive.com

**SGH Equipment Limited**

Estates House  
Alvaston Business Park  
Middlewich Road  
Nantwich  
Cheshire  
CW5 6PF  
UK  
Contact: Mr Stuart Henderson  
Job Title: Director  
T: + 44 1270 619 721  
F: + 44 1270 619 742  
E: sales@sghequipment.co.uk  
W: www.sghequipment.co.uk  
Equipment for conveying and handling Powders and Granular materials. EQUIPMENT: Storage Silos & Vessels, Silo Safety Systems, Discharge & Flow Aids, Valves & Actuators, Conveyors & Feeders, Dust Filters & Collectors,

Mixers & Blenders, FIBC / Big Bag - PORTABULK® Representatives – UK SERVICES: Fabrication, Mechanical, Electrical \*Design, Manufacture, Installation & Commissioning \*Control & Instrumentation \*Dust & Odour Suppression

**SGS**

Suite 210B  
1919 S. Highland Ave  
Lombard  
Illinois  
60148  
USA  
Contact: Ms MaryLynn Dobush  
T: + 1 630 953 9300  
F: + 1 630 953 9306  
E: info@sgs.com  
W: www.sgs.com

**SGS (Nederland) BV**

Malledijk 18  
Spijkenisse  
AE  
3200  
The Netherlands  
Contact: Mr Rolf Wilting  
T: + 31 181 69 3260  
F: + 31 181 69 3581  
E: rolf.wilting@sgs.com  
W: www.sgs.nl

**SGS Australia Pty Ltd**

Unit 16  
33 Maddox Street  
Alexandria  
NSW  
2015  
Australia  
Contact: Mr Stephen Hemsworth  
Job Title: National Business Manager  
T: + 61 2 8594 0400



F: + 61 2 8594 0419  
E: stephen.hemsworth@sgs.com  
W: www.au.sgs.com  
SGS is the world's leading inspection, verification, testing and certification company. SGS also designs and supplies mechanical

sampling systems for a wide range of bulk materials. SGS has more than 30 years' experience in this field with equipment in operation throughout the world.

**SGS Austria Control-Co GmbH**

Diefenbachgasse 35  
Vienna  
A 1150  
Austria  
Contact: Ms Susann Beyer

**WE MANUFACTURE IN ITALY TO SUPPLY ALL AROUND THE WORLD**

**ITALIAN TECHNOLOGY**

**CONVEYOR & ELEVATOR BELTS  
STEEL CORD & TEXTILE**

ISO 9001



21055 Gorla Minore (Italy)  
Phone +39 0331 36.51.35  
Fax +39 0331 36.52.15

Via Colombo, 144  
www.sig.it  
E-Mail: sig@sig.it



Cape Size Transshipper, Goa, India



Turnkey Contract at the Port of Quebec



**SEABULK INC.** 

Tel: (604) 273-1378  
Fax: (604) 273-1358

Suite 150 - 10271 Shellbridge Way  
Richmond, B.C. V6X 2W8 Canada

[www.seabulk.com](http://www.seabulk.com)  
[sbs@seabulk.com](mailto:sbs@seabulk.com)



T: + 43 1 512 25 67152 137  
 F: + 43 1 512 25 679  
 E: sgs\_austria@sgs.com  
 W: www.at.sgs.com

## SGS Minerals Services

185 Concession Street  
 PO Box 4300  
 Lakefield  
 ON  
 K0L 2H0  
 Canada  
 Contact: Ms Jean Richardson  
 Job Title: Global Director Marketing  
 T: + 1 705 652 2000  
 F: + 1 705 652 6365  
 E: minerals@sgs.com  
 W: www.sgs.com/coal  
 SGS works hand-in-hand with your operations to provide cost-effective solutions to minimize operational and financial risk. Our global technical leadership and industrial expertise provides an unrivalled global benchmark of experience and value to help you control your coal operations..

## SGS Minerals Services

1 Place Des Alps  
 PO Box 2152  
 Geneva  
 CH 1211  
 Switzerland  
 Contact: Mr Richard Lihou  
 T: + 41 22 739 9111  
 F: + 41 22 739 9815  
 E: richard.lihou@sgs.com  
 W: www.sgs.com  
 The SGS Group is the global leader and innovator in verification, inspection, testing and certification services. Founded in 1878, SGS is recognised as the global benchmark for the highest standards of expertise and integrity. With over 30,000 employees, the

Company operates a network of offices and laboratories in over 140 countries around the world.

## Shanghai Global Machinery Co., Ltd (SGMC)

No.1449 Baishi Road  
 Qingpu District  
 Shanghai  
 201711  
 China  
 Contact: Mr Luo Tao  
 T: + 86 21 398 21126  
 F: + 86 21 398 21130  
 E: luo@sgmc.com.cn  
 W: www.sgmcgrab.com  
 Shanghai Global Machinery Co., Ltd (SGMC) is a famous manufacturer specializing in producing grab series products. SGMC grabs are widely applied to shipping, port, power station, steel plant, refuse incineration plant, railway, cement, chemical engineering, paper marking, dredging, salvaging, etc.

## Shanghai Janus Grab Co., Ltd.

Room 518-519  
 VMO 37#  
 2049 Pujin Road  
 Shanghai  
 Shanghai  
 201114  
 China  
 Contact: Mr Pracky Jia  
 Job Title: Marketing Manager  
 T: + 86 21 6885 5558  
 F: + 86 21 6885 5559  
 E: janus@janusgrab.com  
 W: http://www.janusgrab.com/

## Shanghai Qifan Co., Ltd.

25F, Baoding Mansion  
 Xujiahui Road

Shanghai  
 200025  
 China  
 Contact: Mr Eric Liu  
 T: + 86 21 51029257  
 F: + 86 21 51062358  
 E: ericshyp@163.com  
 W: http://www.qifanco.com/

## Shanghai Yo-Pi Port Machinery Co. LTD

Room 603, No 3 Lane 298  
 East Wenshui Road  
 Shanghai  
 PR  
 China  
 Contact: Miss Avril  
 T: + 86 21 552 28716  
 F: + 86 21 5522 8739  
 E: grab@shyp-pm.com  
 W: www.shyp-pm.com/

## Shanghai Zhenhua Port Machinery Co (ZPMC) Ltd

3470 Pudong Nan Lu  
 Shanghai  
 PR  
 200125  
 China  
 Contact: Mr Chen Kai  
 Job Title: General Manager  
 T: + 86 21 5839 6666  
 F: + 86 21 5839 9555  
 E: mail@zpmc.com  
 W: www.zpmc.com  
 Shanghai Zhenhua Port Machinery Co Ltd (ZPMC) is a world-famous manufacturer of cranes and large steel structures. Its main products include quayside container cranes, rubber-tyred gantry cranes (RTGs), bulk-material ship loaders and unloaders, bucket wheel stackers and reclaimers, portal cranes, floating cranes, engineering vessels

and large steel bridge structures.

## Shanthi International

21, Center Point  
 Indira Gandhi Road  
 Jamnagar  
 Gujarat  
 361008  
 India  
 Contact: Mr Sanjay Masuria  
 Job Title: Director - Marketing - International  
 T: + 91 288 255 6671 / +91 288 2555 867  
 F: + 91 288 255 4254  
 E: sanjay@servoday.in  
 W: www.servodaygrabs.com  
 Manufacturer & Exporter of Radio Remote Control Grabs, capacity from 6CBM to 22 CBM, with the Unique features of Grabs operation counting, with Weight calculation, online Grab monitoring systems etc.

## Shaw Almex Canada

PO Box 430  
 Parry Sound  
 Ontario  
 P2A 2X4  
 Canada  
 Contact: Ms Pamela Mc George  
 Job Title: Sales Manager  
 T: + 1 705 746 5884 / +1 9053317177  
 F: + 1 705 746 9484  
 E: Pamela\_mcgeorge@almex.com  
 W: www.almex.com

## Shepherd Construction

Frederick House  
 Fulford Road  
 York  
 UK  
 Contact: Mr Mike Armstrong  
 Job Title: Project Director  
 T: + 44 1904 634 431

E: marmstrong@shepherd-construction.co.uk  
 W: http://www.shepherd-construction.co.uk/

## SIBRE - Siegerland Bremsen GmbH



Siegerland Bremsen

Auf der Stücke 1-5  
 Haiger  
 Hessen  
 D-35708  
 Germany  
 Contact: Mr Lutz Kramaschki  
 Job Title: Corporate Communication  
 T: + 49 2773 9400 0  
 F: + 49 2773 9400 20  
 E: info@sibre.de  
 W: www.sibre.de  
 Since 1958 SIBRE-Siegerland Bremsen GmbH is a manufacturer of industrial brakes systems (drum-, disc-, caliper- and storm brakes) and drive components (e.g. drum couplings) and offers an optimum combination of innovative high quality products, easy usage and minimized life-cycle costs by employing latest manufacturing and quality assurance technologies.

## SIDERAR / TERNIUM

Centro de Informacion  
 Ave. Cordoba 320, Piso 4  
 Ciudad Autonoma de Buenos Aires  
 Buenos Aires  
 C1054AAP  
 Argentina  
 Contact: Mr Ariel Fabrè

If it depends on ...

- superior operational up-time
- low maintenance
- high wear resistance

... trust in SIBRE brake solutions - well-proven in heavy duty operations such as in mining belt conveyors.



Siegerland Bremsen

Industrial Brake Systems  
 Drive Components  
 Made by SIBRE



Job Title: Engineer  
 T: + 54 11 4018 6538  
 F: + 54 11 4018 1005  
 E: BAIIFA@techint.net  
 W: www.siderar.com

### Siebtechnik GmbH

Platanenallee 46  
 Mülheim an der Ruhr D-45478  
 Germany  
 Contact: Mr G Liefke  
 T: + 49 208 580 100  
 F: + 49 208 580 1300  
 E: sales@siebtechnik.com  
 W: www.siebtechnik.com

### Siemens AG

Frauenauracherstrasse 80  
 Erlangen 91050  
 Germany  
 Contact: Mr Hans Hertogh  
 Job Title: Marketing Manager  
 T: + 31 70 33 33 066  
 F: + 31 70 33 33 534  
 E: cranes.i@siemens.com  
 W: www.siemens.com/cranes  
 Safety, reliability and performance of Siemens' cranes drive & control systems is widely recognized.

During the last 10 years over 3000 harbour cranes are equipped with Siemens. Simocrane crane-control & -automation technology combined with Siemens' extensive cranes know-how ensure maximum safety, reliability, efficiency and productivity of your crane.

### Siemens AG

Universitätsallee 16  
 Bremen 28359  
 Germany  
 Contact: Mr Hans-Peter Techau  
 Job Title: Sales Manager  
 T: + 49 421 364 2452  
 F: + 49 421 364 2828  
 E: hans-peter.techau@siemens.com

### Siemens Nederland NV

PO Box 16068  
 The Hague 2500 BB  
 The Netherlands  
 Contact: Mr Hans Hertogh  
 T: + 31 70 33 33 066  
 F: + 31 70 333 3534  
 E: hans.hertogh@siemens.com  
 W: www.siemens.com

### SIG Società Italiana Gomma Spa



Via Colombo 144  
 Gorla Minore  
 Varese 21055  
 Italy  
 Contact: Mr Gerardo Frizzati  
 T: + 39 0331 365135  
 F: + 39 0331 365215  
 E: sig@sig.it  
 W: www.sig.it

The Italian leading producer of rubber conveyor, elevator and tubular belts with textile and steel cord carcass. Primary markets are mines, power stations, iron and steel industries, cement factories and all bulk material handling plants as harbour terminal, grain silos, waste processings.

### Silvan Dis Ve IC Ticaret AS

Akasyali Sok  
 Konak Apt.

5/8-9 Suadiye  
 Istanbul  
 Turkey  
 Contact: Mr Tarik Gursal  
 T: + 90 216 380 36 18  
 F: + 90 216 416 91 59  
 E: info@silvanticaret.com  
 W: www.silvanticaret.com

### Sime Industrie

20, allée des érables  
 Gunnarstorp  
 B P 40004  
 Roissy  
 CDG Cedex  
 F-95911  
 France  
 Contact:  
 Job Title: Marketing Manager  
 T: + 33 1 49 90 32 20  
 F: + 33 1 49 89 06 38  
 E: sales@stromagfrance.com

### Simplicity Projects Pvt Ltd

17 Community Centre  
 Maya Puri, Phase 1  
 New Delhi  
 110064  
 India  
 Contact: Mr R K Makhija

Job Title: President  
 T: + 91 11 2811 5093  
 F: + 91 11 2811 6744  
 E: sppl@simplicityprojects.com  
 W: www.simplicityprojects.com

### Siwertell - a Cargotec brand

## Siwertell

PO Box 566  
 Gunnarstorp  
 Bjuv  
 SE-267 25  
 Sweden  
 Contact: Ms Emily Cueva  
 Job Title: Communications Manager  
 T: + 46 42 858 00  
 F: + 46 42 858 99  
 E: blksales@cargotec.com  
 W: www.siwertell.com  
 Siwertell dry bulk handling solutions are designed with a totally enclosed conveying line, reducing dust emission to a minimum and eliminating spillage completely and providing environmentally friendly operation.



***Siwertell***

This demonstrates how much spillage you get with a Siwertell ship unloader.

[www.siwertell.com](http://www.siwertell.com)  
Siwertell is a Cargotec brand



## SMB International GmbH



Friedrich List Str 3-7  
Quickborn  
25451  
Germany  
Contact: Mr Andreas Heckel  
Job Title: Managing Director  
T: + 49 41 06 12388 0  
F: + 49 41 06 12388 19  
E: heckel@smb-group.de  
W: www.smb-shiploading.com  
SMB specializes in 1. Shiploaders for various bulk and bag materials such as fertilizers, sulphur, grains and cement. 2. Reclaimers 3. Conveying systems 4. Bucket Elevators 5. Warehousing systems for pallets 6. Automatic palletizers.

## Smiley Monroe Ltd

23 Ferguson Drive  
Knockmore Hill Industrial Park  
Lisburn  
Co. Antrim  
Northern Ireland  
BT28 2EX  
UK  
Contact: Mr Tim Monroe  
Job Title: Marketing Manager  
T: + 44 28 9267 3777  
F: + 44 28 9266 3666  
E: sales@smileymonroe.com  
W: www.smileymonroe.com  
A leading United Kingdom manufacturer of moulded rubber and PU products, spillage control systems, belt alignment equipment and belt scrapers. The portfolio includes modular products such as impact bars, skid bars and skirt boards for ease of installation and replacement, together with encapsulation systems for conveyors and for screens and feeders.

## SMM-UM Sociedade de Montagens Metalomecânicas SA

Quinta da Fonte  
Edifício D. João I  
Paço de Arcos  
2770-203  
Portugal  
Contact: Ms Ines Goncalves  
T: + 351 21 4697600 / 607  
F: + 351 21 4697612  
E: ines.goncalves@smm.com.pt  
W: www.smm.com.pt  
Maintenance and Revamping of Lifting and Handling Equipments

## Sobemai by IRI nv

Bogaardestraat 168M  
Maldegem  
Oost-Vlaanderen  
B-9990  
Belgium  
Contact: Mr Kilian de Lille  
Job Title: Sales Dept  
T: + 32 50 711801  
F: + 32 50 710402  
E: sales@sobemai.com  
W: www.sobemai.com  
Manufacturer of equilibrated cranes, capable of lifting up to 200 ton. Capacities up to 5000 ton per hour. PLC controlled. For container handling, bulk, scrap and general cargo. Pedestal-, pontoon-, track- or bogie mounted.

## Societe de Tolerie Industrielle Francaise

Artisanal Zone de la Lande

Street Savennieres  
St Georges Sur Loire  
ZI 49170  
France  
Contact: Mr Manuel Burgos  
T: + 33 2 41 72 16 82  
F: + 33 2 41 39 32 12  
E: m.burgos@stifnet.com

## Solimar Pneumatics

8001 Ranchers Road NE  
Minneapolis  
Minnesota  
MN 55432-3103  
USA  
Contact: Mr Jeff Lucke  
Job Title: Director of Sales  
T: + 1 763 574 1820  
F: + 1 763 574 1822  
E: jeff@solimarpne.com  
W: www.solimarpneumatics.com  
Solimar Pneumatics is a leading designer and supplier of aeration systems and engineered components for the dry bulk material handling industry. Solimar is backed by over 40 years of experience specializing in aeration devices and discharge aids that assist the pneumatic flow of dry products like cement and flour.

## Solitec Engineering Ltd

Unit 8  
Gilchrist Thomas Industrial Estate  
Blaenavon  
Gwent  
NP4 9RL  
UK  
Contact: Mr David Woodland  
Job Title: General Manager  
T: + 44 1495 790623  
F: + 44 1495 790666  
E: sales@solitec.co.uk  
W: www.solitec.co.uk

## Sotecma Inc Process Engineers

3126 Bernard-Pilon  
Suite 200  
Saint-Mathieu-de-Beloeil  
Quebec  
J3G 4S5  
Canada  
Contact: Ms Odette Lecompte  
Job Title: Administrative Assistant

T: + 1 450 464 4426  
F: + 1 450 464 4534  
E: olecompte@sotecma.com  
W: www.sotecma.com

## Specialised Handling & Eng (Pty) Ltd

PO Box 125  
Featherbrooke Estate  
Mogale  
Gauteng  
1746  
South Africa  
Contact: Mr Derek Albertson  
Job Title: Managing Director  
T: + 27 11 662 1649  
F: + 27 11 662 1049  
E: she@she.co.za  
Specialised Handling are specialists in rail wagon unloading stations and bulk materials handling machinery and systems. Their equipment range includes tipplers, wagon positioning and hauling machinery, wagon unloaders, tilters, wagon movement control devices, stackers, reclaimers, shiploaders, and steep angle conveyors.

## Specimas

Via Galvani Nr 1  
Nova Milanese  
Milan  
20054  
Italy  
Contact: Mr Ottonel Popesco  
T: + 39 036 24 55 101  
F: + 39 036 24 12 33  
E: ottonel.popesco@cavotec.com

## Spencer

One Humber Quays  
Wellington Street West  
Hull  
HU1 2BN  
UK  
Contact: Mr Joe Booth  
Job Title: Business Developer  
T: + 44 113 815 0015  
E: engineering@cspencertd.co.uk  
W: thespengergroup.co.uk

## Spiroflow Ltd

Lincoln Way  
Clitheroe  
Lancashire  
BB7 1QG  
UK  
Contact: Mr Ben Ayrton  
Job Title: Marketing Manager  
T: + 44 1200 422525  
F: + 44 1200 429165  
E: sales@spiroflow.com  
W: www.spiroflow.com  
Spiroflow is a leading designer and manufacturer of Bulk Bag (FIBC) Fillers and Dischargers. Their comprehensive range covers the simple filling and emptying of dust-free materials right through to the 'total containment' of hazardous chemicals.

## STAG AG

Industriestrasse 11  
Maienfeld  
7304  
Switzerland  
Contact: Mr Walter Furgler  
Job Title: Sales/Marketing  
T: + 41 81 303 5800/45  
F: + 41 81 303 5899  
E: office@stag.net  
W: www.stag.net  
STAG bulk material technology for mechanical and pneumatic conveying technology as well as ensilage technology. We are also the ideal partner as a general company for complex assignments for nearly all bulk materials in plant construction.

## Standard Industrie (Airchoc)

139 - 141 Rue du Luxembourg  
Roubaix  
59100  
France  
Contact: Mr Paul Brunbrouck  
Job Title: Sales Manager  
T: + 33 320 283 232  
F: + 33 320 685 1162  
E: market@standard-industrie.com  
W: www.standard-industrie.com  
- Silos and hoppers declogging and cleaning: AIRCHOC-GIRONET - Optimization of conveyor belts

(LIFTUBE) and belt cleaners -  
Vacuum cleaning equipment

## Starlinger & Co. GmbH



## Starlinger

Sonnenuhrgasse 4  
Vienna  
A-1060  
Austria  
Contact: Mr Alfred Rußwurm  
Job Title: Marketing Manager  
T: + 43 1 599 55 0  
F: + 43 1 599 55 180  
E: office@starlinger.com  
W: www.starlinger.com  
Starlinger is the world's leading producer of machinery for woven plastic sack production (coated or uncoated sacks, Leno, valve sacks, AD\*STAR® block bottom valve sacks and FIBCs). The product range also includes plastics recycling machines, PET bottle recycling and PET solid staling lines.

## Stas BV

Kathodeweg 4  
Horn  
1627 LK  
The Netherlands  
Contact: Mr Rob ver Doren  
Job Title: Managing Director  
T: + 31 229 282 940  
F: + 31 229 233 177  
E: info@stasgroup.eu  
W: www.stas-nl.com  
Stas is a manufacturer (production) of transport rollers, drive and tension drums and import bearings and bearing blocks.





# Material Handling Company



MADE IN  
GERMANY

## Complete Solutions

Loading systems  
Level measuring instruments  
Palletizers  
Warehouse systems  
Filling systems  
Conveyor systems  
Shiploader

**SMB** | Group  
best solution



SMB International GmbH  
Friedrich-List-Str. 3-7 · D-25451 Quickborn  
Phone +49 (0)4106/123 88-0  
info@smb-group.de · www.smb-group.de



# Bulk Material handled by Experts

Tenova TAKRAF is a key supplier of individual machines and integrated systems for handling bulk materials in mine stockyards, ports, power stations and metallurgical plants. Each project is approached from the end-user's viewpoint in order to deliver optimized solutions that meet and exceed requirements and expectations.

Complex material handling operations starting from train unloading via stockyard handling and blending to ship loading are handled on the basis of extensive experience and know-how in bulk handling. Stackers, Reclaimers, Stacker/Reclaimers, Scrapers, Ship Loaders and Ship Unloaders are reliably in operation all over the world.



Total technology solutions for mining, bulk materials handling and minerals beneficiation.

## **TAKRAF GmbH**

Torgauer Straße 336  
04347 Leipzig  
Germany  
Phone +49 341 2423 500  
Fax +49 341 2423 510  
takraf.sales@tenova.com  
www.takraf.com  
www.tenova.com



  
**tenova**  
TAKRAF

TENOVA is a worldwide supplier of advanced technologies, products and engineering services for the iron & steel and mining industries.



**Stevenel Oy**



Juhlatalonkatu 6 C 45  
Tampere  
FIN - 33100  
Finland  
Contact: Mr Heikki Hyysalo  
Job Title: Managing Director  
T: + 358 40 5037 616  
F: + 358 3 261 9773  
E: stevenel@stevenel.com  
W: www.stevenel.com  
Stevenel Ltd offers automated and semi-automated cargo handling attachments for fully hydraulic cranes at ports and terminals. We offer lift frames for pulp, sawn timber, steel products, paper reels, big bags, pallet cargo etc....

**Stewart Inspection and Analysis (Pty) Ltd**

PO Box 267  
Brakpan  
1541  
South Africa  
Contact: Mrs Carol Le Cordeur  
T: + 27 11 740 0621  
F: + 27 11 740 0626  
E: clecordeur@stewartgroupglobal.com  
W: www.stewartgroupglobal.com

**Stock Equipment Company**

16490 Chillicothe Road  
Chagrin Falls  
Ohio  
44023-4398

USA  
Contact: Mr Simon Shipp  
Job Title: Business Development  
T: + 1 800 289 7326 ext: 217  
F: + 1 440 543 5944  
E: simon.shipp@stockequipment.com  
W: www.stockequipment.com

**Stackpile Surveying and Protection BVBA**

Bankwegelhof 93C  
Beveren-Waas  
9120  
Belgium  
Contact: Mr Joeri Verbraeken  
T: + 31 180 556561  
F: + 31 180 556289  
E: joeri.verbraeken@ssp-belgium.com

**Stokman BV**

Brasem 18  
Raamsdonksveer  
AB  
4941 SE  
The Netherlands  
Contact: Mr Jan Stokman  
Job Title: General Manager  
T: + 31 162 516040  
F: + 31 162 517590  
E: stokmanbv@stokmanbv.com  
W: www.stokmanbv.com  
Produces, installs and repairs heavy duty bulk handling systems including ship-mounted equipment for self-unloaders.

**Stora Enso**

PO Box 309  
Helsinki  
FI-00101  
Finland  
Contact: Mr Lauri Peltola



Job Title: Head of Group Communications  
T: + 358 2046 21380  
F: + 358 2046 21267  
E: lauri.peltola@storaenso.com  
W: www.storaenso.com

**Strudes Inc**

1440 Sainte Catherine St  
Suite 905  
Montreal  
Quebec  
Canada  
Contact: Mr Henry Nowodworski  
Job Title: President  
T: + 1 514 731 6951 x 123  
F: + 1 514 737 4146  
E: nowodworski@strudes.ca  
W: www.strudes.ca

Strudes Inc. is an Engineering Consulting Company, specializing in design for heavy industry in general and Cement Industry in particular. For markets and more information: www.strudes.ca.

**Sub Con Ltd**

20 Shamrock Road  
Erin  
Ontario  
NOB ITO  
Canada  
Contact: Mr Don Johnstone  
T: + 1 519 833 0054  
F: + 1 519 833 9344  
E: don@bulk-store.ca

**Sucofindo**

Laboratory Strategic Business Unit  
Graha Sucofindo 2nd Floor  
Jl Raya Pasar Minggu Kav.34  
Jakarta  
12780  
Indonesia  
Contact: Mr Diding Sudira  
Job Title: Manager  
T: + 62 21 798 6567  
F: + 62 21 798 6878  
E: diding@sucofindo.co.id  
W: www.sucofindo.co.id

**Sunitomo Heavy Industries**

Material Handling Systems Co., Ltd.  
ThinkPark Tower  
1-1 Osaki 2-chome



Enhance Your Port operations with fully/semi-automated attachments!

Stevenel for

- pulp units
- sawn timber, plywood, chipboard
- paper reels, big bags
- steel bars
- dry bulk, etc....

Head Office:

Stevenel Oy, Juhlatalonkatu 6 C 45  
FIN-33100 Tampere, Finland  
Tel. +358 40 5037 616  
Fax +358 3 2225 339  
stevenel@stevenel.com

www.stevenel.com



LOAD, UNLOAD AND  
STOCKPILE  
SHIP, BARGE  
AND RAIL



HIGHEST CAPACITIES ON THE PLANET



INSTANT PORTABLE TRUCK UNLOADING



NEW!  
SIGNIFICANTLY REDUCE VESSEL LOAD TIME

## GO ANYWHERE. DO ANYTHING.

- Highly mobile conveyor designs.
- Functional machines for multiple applications.
- Robust designs withstand demanding work.
- Custom engineered to accommodate job site.

 superiorindustries

 @superiorind

**SUPERIOR**<sup>®</sup>

[www.superior-ind.com](http://www.superior-ind.com)



Shinagawa-ku  
Tokyo  
141-6025  
Japan  
Contact: Mr Akihide Ito  
Job Title: Acting General Manager,  
International Sales  
T: + 81 3 6737 2643  
F: + 81 3 6866 5181  
E: Akh\_itou@shi.co.jp  
W: www.shi.co.jp  
Product range covers not only bulk  
handling but also cranes of all  
types. A leader in the field of  
continuous ship unloading with a  
long track record and experience  
with various materials, especially  
iron ore.

**Suomen Viljava Oy**

Kielotie 5 B  
Vantaa  
01300  
Finland  
Contact: Mr Hannu Korttesmaa  
Job Title: Marketing Manager  
T: + 358 10 3464 204  
F: + 358 01 3464 200  
E: hannu.korttesmaa@suomenviljava.fi  
W: www.suomenviljava.fi  
Suomen Viljava Ltd is Finland's  
biggest grain handling and storage  
company. We have stores at 21  
locations in south and middle  
Finland. The total storage capacity  
is 1.4 million tonnes. Our services  
comply with ISO 9001 and GTP  
standards.

**Supercargo, Lda**

Rua Alfredo Cunha, 107  
Monte de Caparica  
2825-056 Caparica  
Portugal  
Contact: Mr Artur Rocha

Job Title: Director  
T: + 351 212 946 220  
F: + 351 212 946 228  
E: mail@supercargo.pt  
W: www.supercargo.pt  
Superintendents for loading /  
unloading Packing and stowage  
inspection, report of findings  
Damages surveys, loss prevention  
and evaluation Draft survey and  
complete survey on vessels (Gafsa  
and Fosfa members and ISO  
9001:2008 Approved)

**Superior Industries, Inc.**



315 East State Highway 28  
PO Box 684  
Morris  
Minnesota  
56267  
USA  
Contact: Mr Corey Poppe  
Job Title: Marketing Manager  
T: + 1 320 589 2406  
F: + 1 320 585 5644  
E: info@superior-ind.com  
W: www.superior-ind.com  
Superior Industries has a reputation  
of engineering and manufacturing  
groundbreaking, bulk material  
handling conveyors and cutting-  
edge components including  
stacking, transfer and feed  
conveyors; portable ship loading  
and unloading conveyors; and  
conveyor idlers, pulleys, belt  
scrapers, sealing systems, impact  
beds and guarding.



**Svendborg Brakes A/S**

Jernbanevej 9  
Vejrstrup  
5882  
Denmark  
Contact: Ms Yvonne Küttemann  
Job Title: Marketing Manager  
T: + 45 63 255 255  
F: + 45 62 281 058  
E: sb@svendborg-brakes.com  
W: www.svendborg-brakes.com  
Svendborg Brakes creates high  
growth for both customers and  
ourselves by innovating, testing and  
delivering world class braking  
solutions. We are value driven and  
customer focused, and we  
continuously strive for superior and

unmatched quality in design,  
products, testing, certification and  
services. This makes us Global  
Leading Experts and the preferred  
and trusted provider in the field of  
intelligent braking solutions.

**Swire CTM Bulk Logistics**



C Transport Maritime SAM  
Gildo Pastor Centre  
7 Rue du Gabian  
Monaco  
MC 98000  
Monaco  
Contact: Captain Giorgio Vallega

Job Title: Operation/Commercial  
Manager  
T: + 377 9798 5981  
F: + 377 9798 2306  
E: gvallega@ctmmc.com  
W: www.swirectmbl.com  
Sums up the experience, know-how  
and networks of it's parent  
companies in the dry bulk and  
logistics field, providing a full range  
of integrated services from the  
supplier to the end users, including  
specialised barge services,  
transshipment, river, coastal and  
ocean transportation by means of  
conventional bulkcarriers or self-  
unloading vessels and barge.



**SWIRE CTM BULK LOGISTICS**

**Together Bridging the Gap  
between Supplier and Industry**

**Mission:**

To provide reliable customised and cost-effective dry-bulk  
seaborne supply chain services aimed at bridging the gap between  
Supplier and Industry

**Services:**

- River and coastal specialized feeders
- Self-unloading vessels and barges
- Floating Cranes
- Floating Terminals
- Ship to Ship, Barge to Ship and Ship to Barge operations
- Integrated seaborne logistics "dry-bulk door to door"



Monaco: Ph. +377 9798 5900  
Singapore: Ph. +65 6603 9400  
www.swirectmbl.com  
contacts: bulklogistics@swirectmbl.com

*your partner for progress*

# Mobile Coal Handling Systems



**HATCH TO HATCH IN LESS THAN 2 MINUTES**



**MOBILE SHIPLOADING**  
**MOBILE SHIP UNLOADING**  
**STOCKYARD STACKERS**  
**STOCKYARD RECLAIMERS**  
**RAIL WAGON LOADING/ UNLOADING**



**SEE US AT:**

<b>Coaltrans USA</b>	2014 6TH - 7TH FEBRUARY
<b>Coaltrans COA</b>	6TH - 7TH MARCH
<b>Coaltrans SOUTHERN AFRICA</b>	12TH - 13TH MAY

**THE POWER TO MOVE MATERIALS™**

ISO 9001:2008 Registered firm | [info@telestack.com](mailto:info@telestack.com) | [www.telestack.com](http://www.telestack.com)

**DEALERS WANTED GLOBALLY**



Telestack mobile radial telescopic shiploader with freefall chute loading vessel at 500tph.



**Sympatec**

System-Partikel-Technik  
Am Pulverhaus 1  
Clausthal-Zellerfeld  
D-38678  
Germany  
Contact: Dr Stephan Röttele  
Job Title: Managing Director  
T: + 49 5323 717 0  
F: + 49 5323 717 229  
E: sales@sympatec.com  
W: www.sympatec.com/

**Synergy Engineering Ltd**

135 Glacier Street  
Coquitlam  
BC  
V3K 5Z1  
Canada  
Contact: Mr Richard Neuman  
Job Title: President  
T: + 1 604 472 2800  
F: + 1 604 464 9399  
E: office@synergy-eng.com  
W: http://www.synergy-eng.com

**TAIM WESER, S.A.**

Carretera de Castellón, km 6,3  
Poligono Industrial La Cartuja  
Zaragoza  
50013  
Spain  
Contact: Mr Luis Monge  
T: + 34 976 50 00 06  
F: + 34 976 50 00 28  
E: info@taimweser.com  
W: www.taimweser.com  
TAIM WESER is a World leading company within the fields of bulk materials handling, lifting equipment, waste treatment plants and renewable energy, with more than 100 years of experience and committed to innovation and technology.

**TAKRAF GmbH**



Torgauer Str. 336  
Leipzig  
D-04347  
Germany  
Contact: Mr Thomas Eckel  
Job Title: Director Sales  
T: + 49 341 2423 605  
F: + 49 341 2423 610  
E: takraf.sales@tenova.com  
W: www.takraf.com  
With more than a century of experience and tradition in the field of bulk materials handling, the company is proud of its worldwide standing. Services offered: planning, design, fabrication, erection and after sales service of machines, systems and complete plants.

**TAKRAF India Pvt. Ltd.**

94/3, TTK Road  
Alwarpet  
Chennai  
600 018  
India  
Contact: Ms Jayanthi Kandhasami  
Job Title: Marketing Executive - Mining & Minerals  
T: + 91 44 33430519 / 33430100  
F: + 91 44 24996451  
E: jayanthi@tenova.com  
W: www.takraf.co.in  
TAKRAF India Pvt. Ltd., a wholly owned subsidiary within Tenova Mining & Minerals Division, a world leader in the mining and bulk handling equipment. TAKRAF as a competent, experienced, capable

and reliable partner for our customers offers system solutions within the core areas open-cast mining and bulk material handling technology.

**TAURUS EMERGÉ**

Rubber Industrial VII  
Kerpes ut 17  
Budapest  
1965  
Hungary  
Contact: Mr Viktor Vajda  
T: + 36 62 566 700  
F: + 36 1113 2912  
E: marketing@taumrg.hu  
W: www.taumrg.hu

**TBMA Europe BV**

Delfweg 18  
Noordwijkerhout  
NL-2211 VM  
The Netherlands  
Contact: Mr E A J Houben  
Job Title: Managing Director  
T: + 31 252 37 50 68  
F: + 31 252 37 54 36  
E: info@tbma.com  
W: www.tbma.com/engels/  
TBMA manufacture and supply a wide range of FIBC Filling- and FIBC Discharging machines. We are specialists in filling-off fine, aerated powders ensuring volume reduction and a stable FIBC. Our range of automatic bag emptying machines can handle up to 1,500 bags/hour.

**Tebodin Consultants & Engineers**

Postbus 433  
Deventer 7400 AK  
The Netherlands  
Contact: Mr Bert Frowijn

Job Title: Branch Director  
T: + 31 570 63 8900  
F: + 31 570 63 6350  
E: b.frowijn@tebodincce.nl  
W: www.tebodincce.nl

**Tebodin Consultants & Engineers**

P.O. Box 16029  
The Hague  
2500 BA  
The Netherlands  
Contact: Mr R J Smits van Oyen  
Job Title: Manager Logistics, Asset Management & Maintenance  
T: + 31 70 348 0249  
F: + 31 70 348 0591  
E: info@tebodin.com  
W: www.tebodin.com  
An independent multi-disciplinary engineering and consulting firm, employing some 3,500 employees, located at 40 offices in 26 countries in Europe, the Middle East and Asia. Possessing an extensive international knowledge and experience in providing engineering consultancy services in the field of ports and terminals. Services range from preliminary studies for port development to the detailed design and construction supervision of terminals.

**techNaero aps**

Finlandsgade 29  
Haslev  
DK-4690  
Denmark  
Contact: Mr Anders Larsen  
Job Title: CEO  
T: + 45 56314925  
F: + 45 56314555  
E: sales@techNaero.dk  
W: www.techNaero.dk  
We are selling, planning, producing

and commissioning filtration systems for the world market. We have supplied filtration systems to customers in Scandinavia, Russia, Ukraine and Georgia. Huge filter systems shipped in ordinary containers to very competitive prices, worldwide. Standard control system able to communicate directly with the control room.

**Telestack Limited**



Omagh  
County Tyrone  
BT79 0NZ  
Northern Ireland  
Contact: Mrs Samantha Thompson  
Job Title: Marketing Co-Ordinator  
T: + 44 28 82 25 11 00  
F: + 44 28 82 25 22 11  
E: salesenquiries@telestack.com  
W: www.telestack.com  
Specialist manufacturers of Mobile bulk material handling systems for the Ports/Inland terminals, Mines, Quarries, Steel Mills, Cement Plants and Powerstation industries globally. The mobile range of equipment offers unrivalled flexibility for the operator, reducing costs in Cap Ex Investment compared to fixed installations, fuel and labour. We have supplied and support some of the world largest blue chip companies.

# EFFICIENT BULK HANDLING

## Reliable and Economical

Terex is a world leader in equipment and solutions for ports and terminals, offering a variety of bulk-handling options. The range of Terex® Fuchs material handling machines is the ideal choice for bulk handling alongside vessels up to coaster size and in smaller terminals.

### What it means for you:

- ▶ Large working radius up to 23 m for efficient handling
- ▶ Fast work cycles provide efficient handling capacity
- ▶ Energy efficient drives for low operating costs
- ▶ Undercarriage and drive options tailored to your needs

[www.terex-fuchs.com](http://www.terex-fuchs.com)



Safe access to operator cabin.



 **TEREX®** | **FUCHS**

**WORKS FOR YOU.™**



## Tema BV

PO Box 3220  
Rijswijk  
GE  
2280  
The Netherlands  
Contact: Mr M P van Delden  
T: + 31 70 390 6555  
F: + 31 70 399 3390  
E: mp.vandelden@tema.nl  
W: www.tema.nl

## TEMA Systems Inc.

7806 Redsky Drive  
Cincinnati  
Ohio  
45249  
USA  
Contact: Mr Mike Mullins  
T: + 1 513 489 7811  
F: + 1 513 489 4817  
E: sales@tema.net  
W: www.tema.net

## TENOVA S.p.A - Tenova Takraf

**Italy**  
Via Albareto, 31  
Genova  
16153  
Italy  
Contact: Mr Pietro Bibolini  
Job Title: Commercial Director  
T: + 39 010 605 4634  
F: + 39 010 605 4710  
E: pietero.bibolini@it.tenovagroup.com  
W: www.tenovagroup.com  
Key supplier of equipment and systems for open pit mining, bulk and specialized materials handling, milling and crushing, and air pollution control to the global mining and mineral processing industries, and general industry. A comprehensive after sales service is provided.

## Tenova TAKRAF Africa

58 Emerald Parkway Road  
Greenstone Hill Ext. 21  
Johannesburg  
2047  
South Africa  
Contact: Mr Peter Cheshire or Ms Kay Subramoney  
T: + 27 11 201 2300  
F: + 27 11 455 4547  
E: TMM@za.tenovagroup.com  
W: www.tenovagroup.com  
GLOBAL LEADERS IN BULK MATERIALS HANDLING Tenova is a worldwide supplier of advanced technologies, products and engineering services for the iron & steel and mining industries, providing innovative, integrated solutions for complete process areas.

## Terex Cranes c/o Terex Demag GmbH

Dinglerstr. 24  
Zweibrücken  
66482  
Germany  
Contact:  
Job Title: Global Marketing  
T: + 49 6332 83 0  
F: + 49 6332 83 1602  
E: Info.portequipment@terex.com  
W: www.terexcranes.com  
Terex Cranes is the only construction equipment manufacturer to provide you with a full line of cranes and port equipment. Our offering ranges from Reachstackers to Straddle Carriers or Ship to Shore cranes and from compact City Cranes to the biggest crawler crane ever built.

## Terex Fuchs GmbH

  
Industrie str. 3  
Bad Schönborn  
76669  
Germany  
Contact: Mr Thomas Berners  
T: + 49 725 384 136  
E: thomas.berners@terex.com  
W: www.terex-fuchs.de  
Established in 1888, Terex Fuchs is a specialist technology provider and global player for loading machines and handling units.

## Terex Port Solutions

Gottwald Port Technology GmbH  
Forststrasse 16  
Düsseldorf  
D-40597  
Germany  
Contact: Mr Giuseppe Di Lisa  
Job Title: Vice President Sales & Service  
T: + 49 211 7102 3771  
F: + 49 211 7102 3651  
E: tps.info@terex.com  
W: www.terexportsolutions.com  
By opting for Terex Port Solutions you can benefit from tailor-made handling solutions for professional bulk handling. Depending on equipment, bulk material and conditions, handling capacities of up to 1,850 tph can be achieved. The broad range of products available is supported by innovative software solutions, dedicated planning and consultancy and backed up by a worldwide service network.

## Teta Mühendislik A. .

Çankırı Yolu 7.km Aselsan Karşısı  
Akyurt  
Ankara  
06950  
Turkey  
Contact: Mr Talat Isik  
Job Title: General Manager  
T: + 90 312 8475361  
F: + 90 312 8475399  
E: teta@tetamuh.com.tr  
W: www.tetamuh.com.tr  
Engineering, manufacturing and supply of grain storage systems, bagging machines and bulk weighers.

## Thames Side Sensors Ltd

Unit 10 io Trade Centre  
Deacon Way  
Reading  
Berkshire  
RG30 6AZ  
UK  
Contact: Mrs Maureen Forrester  
Job Title: Marketing Manager  
T: + 44 1189 411387  
F: + 44 1189 458225  
E: mforrester@thames-side.co.uk  
W: www.thames-side.com  
Thames Side Sensors are the UK Market Leaders in load cells and mounting assemblies for Process Weighing, with an un-rivalled reputation for service, flexibility and quality. With over 30 years experience we believe that no-one can match our extensive range and innovative products.

## The ACT Group

14644 El Molino Street  
Fontana  
CA  
92335  
USA  
Contact: Mr Edward Sunseri

T: + 1 909 350 4703  
F: + 1 909 350 4982  
E: esunseri@groupactinc.com  
W: www.groupact.com  
Specialists in the process, containment and control of dust for all bulk materials. The Group offers full design and engineering, procurement, installation and fabrication and after market service and repair for conveyors, crushers, screens, dust collectors and dust suppression systems.

## The BRUKS Group

PO Box 46  
Vastergatan  
Arbrå  
Gävleborg County  
SE-82010  
Sweden  
Contact: Mr Lars Lindvall  
Job Title: Sales Manager  
T: + 46 278 642547  
F: + 46 278 642520  
E: ll@bruks.com  
W: www.bruks.com

## The China Navigation Co. Pte. Ltd

300 Beach road #27-01  
The Concourse  
Singapore  
199555  
Singapore  
Contact: Mr Richard Sell  
Job Title: Commercial Manager  
T: + 65 6603 9429  
E: Richard.Sell@chinanav.com  
W: www.chinanav.com

## The Grab Specialist b.v.

Draaibrugweg 1  
Almere  
1332AA  
The Netherlands  
Contact: Mr Emiel Bleyenbergh  
Job Title: Director  
T: + 31 365 32 88 22  
F: + 31 365 49 99 22  
E: info@tgs-grabs.nl  
W: www.tgs-grabs.nl  
TGS manufactures all types of grabs for sale and rental; we have a stock of approx.60 pc.in all sizes. Also repairs can be done for other grabs. TGS is also certified as ISO 9001.

## The Raring Corporation

12007 NE 95th St  
Vancouver  
WA  
98682  
USA  
Contact: Mr David L Raring  
Job Title: President  
T: + 1 360 892 1659  
F: + 1 360 892 1624  
E: draring@raringcorp.com  
W: www.raringcorp.com

## Thermo Fisher Scientific

501 - 90th Avenue NW  
Minneapolis  
MN  
55433  
USA  
Contact: Ms Paula Frisk  
Job Title: Product Manager/Marketing  
T: + 1 800 445 3503  
F: + 1 763 783 2525  
E: Sales.bulk.us@thermofisher.com  
W: www.thermoscientific.com/  
bulkweighing  
A leading manufacturer of weighing and monitoring products for the bulk material handling and processing industries, the Thermo Scientific product portfolio includes







# THIELE®



## THIELE CHAIN QUEEN CLASSIC EVERYTHING GOES WITH THIELE CHAIN

### Your experienced partner in chain technology

THIELE - More than 75 years experience in the engineering and manufacturing of conveyor chain systems such as round link chains, bucket elevator chains, bushed conveyor chains, forged conveyor chains and cardan chains, including all attachments.

Main industries (among others):



Cement Industry



Iron & Steel Industry



Coal-Fired Power Plants

Products:



Bucket Elevator Chains



Bushed Conveyor Chains



Round Link Chains



Sprockets



Forged Link Chains





belt scales, conveyor protection switches, continuous and point level measurement, sampling equipment and tramp metal detectors. Contact us today to improve your process, productivity and profitability.

**Thiele GmbH & Co KG**



Werkstrasse 3  
Iserlohn  
D- 58640  
Germany  
Contact: Mr Maik Koerner  
Job Title: Sales Manager -  
Conveyor Chains  
T: + 49 2371 947 319  
F: + 49 2371 947 241  
E: m.koerner@thiele.de  
W: www.thiele.de  
More than 60 years experience in the engineering and manufacturing of conveyor chain systems such as round steel chains, bushed conveyor chains, forged conveyor chains and cardan chains, including all attachments.

**ThyssenKrupp Canada**

1177-11th Avenue SW  
Suite 500  
Calgary  
Alberta  
2TR 1K9  
Canada  
Contact: Mr Steve Harrington  
Job Title: Vice President Marketing  
T: + 1 403 209 4431  
F: + 1 403 245 5625  
E: infocanada@thyssenkrupp.com  
W: www.krupp.ca

Krupp Canada, located in Calgary, Alberta, has been involved for many years in the design and supply of turnkey, environmentally sensitive mining and material handling projects. The product line of equipment includes: conveying systems, crushing systems, stackers, ship loaders and unloaders, storage and reclamation design and supply.

**ThyssenKrupp Materials Handling**

71 Nanyuki Road  
Sunninghill  
Johannesburg  
Gauteng  
2191  
South Africa  
Contact: Mr Klaus Peter Müller  
Job Title: Managing Director  
T: + 27 11 236 1243  
F: + 27 11 236 1235  
E: info.tkmh@thyssenkrupp.com  
W: www.thyssenkrupp-materialshandling.co.za  
Leading OEM of bulk materials handling equipment in Southern Africa. The product range: Stockyard equipment, Port handling equipment, Train/transport systems, Conveyors, Waste disposal solutions, Mining and processing equipment. ThyssenKrupp Materials Handling has a service and spares department that fully supports all of its machines in the field.

**ThyssenKrupp Resource Technologies GmbH**

Business Unit Materials Handling  
Ernst-Heckel-Strasse 1

St Ingbert-Rohrbach  
Saarland  
D-66386  
Germany  
Contact:  
T: + 49 6894 599 0  
F: + 49 6894 599 468  
E: Info-mh@thyssenkrupp.com  
W: www.thyssenkrupp-resource-technologies.com  
More than 100 years of experience in the design, engineering, supply, erection, supervision of erection and commissioning of material handling equipment and systems for the fertilizer and cement industry, for ports as well as complete coal handling plants for power stations.

**ThyssenKrupp Robins, Inc.**

7730 E. Belleview Ave  
Suite #404  
Greenwood Village  
Colorado  
80111-5820  
USA  
Contact: Mr Bill Halley  
Job Title: Mechanical Engineer  
T: + 1 303 770 0808  
F: + 1 303 770 4522  
E: bill.halley@thyssenkrupp.com  
W: www.krupprobins.com  
ThyssenKrupp Robins, located in Denver, Colorado, has been involved for many years in the design and supply of turnkey, environmentally sensitive mining and material handling projects. The product line of equipment includes: conveying systems, crushing systems, stackers, ship loaders and unloaders, storage and reclamation design and supply.





# Ideal Solutions for Port Facilities

- Equipment for solid bulk material handling
- Designed to meet customer's needs
- High quality, excellent durability

- Reliability and short term delivery
- Shiploader retrofit and upgrading
- Dust aspiration systems



**Sugar 3,000 t/h**



**Iron Ore - 4,000 t/h**



**Grain 1,500 t/h**



**Grain/Ore 1,000 t/h wood chips**



**Grain - 1,500 t/h**



**Grain - 2,500 t/h / wood chips**



**Kaolin 1,100 t/h**



**Grain - 1,500 t/h each tower**



**Dust trap - Upgrading**



**Tideworks Technology - Europe**

Maaswijkweg 7  
Spijkenisse  
3203 LG  
The Netherlands  
Contact: Mr Rik Verspeek  
Job Title: Business Manager  
T: + 31 181 668668  
F: + 31 181 668660  
E: info@tideworks.com  
W: www.tideworks.com

**Timars Svets & Smide AB**

Industrivagen 12  
Falkenberg  
S-311 33  
Sweden  
Contact: Mr Peter Stenbeck  
T: + 46 346 82100  
F: + 46 346 82800  
E: info@timars.se  
W: www.timars.se  
Specialising in container and bulk cargo handling equipment.  
Products include bulk material measuring scales, loading bellows, discharge cones and 'Empty Boy' bulk material emptiers.

**TMEIC**

1325 Electric Road  
Roanoke  
Virginia  
24018  
USA  
Contact: Mr Don Samsa  
Job Title: Marketing  
T: + 1 540 283 2000  
F: + 1 540 283 2001  
E: don.samsa@tmeic-ge.com  
W: www.tmeic.com  
TMEIC is the leading company

supplying variable frequency drives, motors and controls for container cranes, in particular for the automation of rail mounted gantry cranes. Equipment manufacture is in Japan.

**TMSA Tecnologia em Movimentação S/A**



Bernardino Silveira Pastoriza, 710  
Bairro Sarandi  
Porto Alegre  
RS  
91160-310  
Brazil  
Contact: Mr Mathias Elter  
Job Title: CEO  
T: + 55 51 2131 3318  
F: + 55 51 2131 3330  
E: mathias.elter@tmsa.ind.br  
W: www.tmsa.ind.br  
TMSA is the leader in South America supplying grain/meal loading terminals, with references in coal, fertilizer, wood, sugar, iron, ore, coal, alumina, kaolin and other heavy duty commodities up to 4,000tph; conveying equipments for minerals up to 20,000tph 3,100Km, coal up to 2,400tph pipe conveyor 6,800Km.

**Tobu Jukogyo Co**

4-12-20, Kitazakae  
Urayasu City  
Chiba Pre  
279  
Japan

Contact: Mr M Yoshida  
Job Title: Director  
T: + 81 473 525311  
F: + 81 473 525316  
E: info@tobugrab.com  
W: www.tobugrab.com

**Top Lift Int**

21 Teal Ave  
Stormy Creek  
Ontario  
L8E 2P1  
Canada  
Contact: Mr Joel Paikin  
Job Title: Sales Director  
T: + 1 905 662 4137 ext 14  
F: + 1 905 662 8058  
E: jpaikin@toplift.com

**Tramco Europe Limited**

Mandham Business Park  
Hull Road  
Hull  
HU12 8DZ  
UK  
Contact: Mr Dave Fanthorpe  
Job Title: General Manager  
T: + 44 1482 782 666/ + 44 7813 800251  
F: + 44 1482 793 920  
E: David@tramcoeuropa.com  
W: www.tramcoinc.com  
Tramco Europe Ltd Design and manufacture chain and belt conveyors that deliver! Our products are all ATEX approved, robust, reliable and designed to handle severe processing applications. Our variety of designs allows flexibility to specify the size of conveyor for your capacity, at the best value.





The World's Most Complete Line of Chain & Enclosed Belt Conveyors



**TRAMROLL™**

Enclosed belt conveyor with innovative features such as; self-reloading and self-cleaning tail section, and multiple inlets. The heaviest-duty design in the industry.



**JETBELT™**

An efficient system requiring less horsepower than other systems. Used for dry bulk handling requirements in a variety of products.



**MODEL RB**

Designed for self-cleaning and quiet operation with a u-shaped trough for handling soft stock or materials that are easily crumbled or broken.

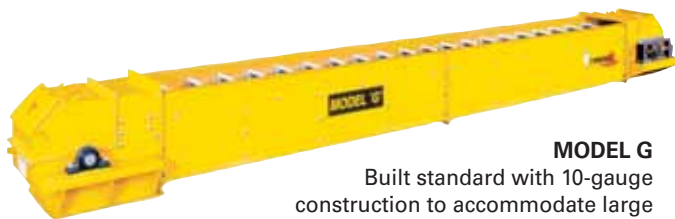

**MODEL G**

Built standard with 10-gauge construction to accommodate large capacities of free-flowing materials. Provides years of trouble-free service under extreme applications.

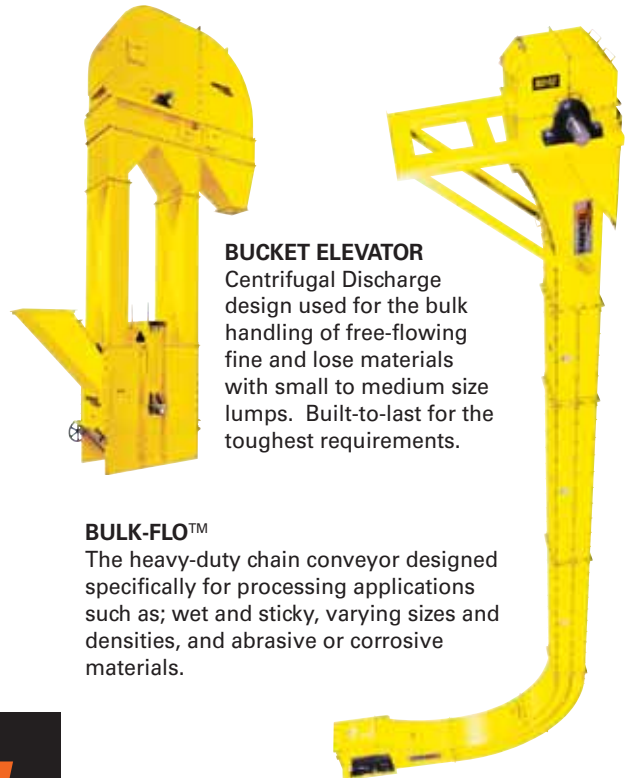

**BUCKET ELEVATOR**

Centrifugal Discharge design used for the bulk handling of free-flowing fine and loose materials with small to medium size lumps. Built-to-last for the toughest requirements.

**BULK-FLO™**

The heavy-duty chain conveyor designed specifically for processing applications such as; wet and sticky, varying sizes and densities, and abrasive or corrosive materials.

**TRAMCO**

Tramco, Inc.  
1020 E. 19th St.  
Wichita, KS 67214 USA

1.316.264.4604  
tramcoinc.com

UK +44 (0) 1482 782666  
Euro-Tramco BV +31 33 4567033

**AGI**

AG GROWTH INTERNATIONAL



## Tramco, Inc



1020 East 19th Street  
Wichita  
KS  
67214

USA

Contact: Mr Steve Cloud

Job Title: President

T: + 1 316 264 4604

F: + 1 316 264 7965

E: sales@tramcoinc.com

W: www.tramcoinc.com

TRAMCO has been involved in the design, application, engineering and manufacture of the worlds most complete line of chain conveyors, enclosed belt conveyors, specially

designed conveyors and conveyor conversions since 1967. The combination of design, engineering, proper component selection, manufacturing, and after-sales service makes TRAMCO the source for consulting and supply in bulk material handling situations.

## Trans Elektro

Spuiweg 8a

Waalwijk N-Br

5145NE

The Netherlands

Contact: Mr Ronald van Egeraat

Job Title: Business Development

T: + 31 416 34 00 16

F: + 31 416 56 07 90

E: egeraat@transelektro.nl

W: www.transelektro.com

## Transas Marine

Datavagen 37

Askim

Gothenburg

42632

Sweden

Contact: Ms Lidia Selivanova

T: + 46 31 769 56 00

F: + 46 31 69 41 84

E: info@transas.com

W: www.transas.com

Transas is a world-leading developer and supplier of a wide range of software and integrated solutions for the transportation industry. The company's range of high-technology products includes onboard navigation systems, a broad range of maritime simulators, vessel traffic solutions.

## Trans-Global Solutions, Inc.

5255 N Twin City Hwy

Nederland

TX

77627

USA

Contact: Mr William Scott

Job Title: Vice President

T: + 1 409 727 4801

F: + 1 409 729 1132

E: wfscott@tgsgroup.com

W: www.tgsgroup.com

## Translift Port Equipment

### Services Inc

Building 3

SRF Area

Subic Bay

Zambales

Freeport Zone 2222

Philippines

Contact: Mr John Wellington

Job Title: Managing Director

T: + 63 47 252 6332/4/5

F: + 63 47 252 6336

E: translift@transliftsubic.com

## Transystems Corporation

101 West Main Street, Suite 900

Norfolk

Virginia

VA 23510

USA

Contact: Mr Brian Larson

Job Title: Chairman

T: + 1 757 627 1112

F: + 1 757 672 1113

E: brgarcia@transystems.com

W: www.transystems.com

TranSystems Corporation





Rail Mounted Ship Unloader



Jetty Mounted Ship Unloader



Industry



Convey Units

## PNEUMATIC BULK HANDLING EQUIPMENT

Design, engineering and production of **PNEUMATIC** bulk handling equipment for dusty abrasive products. Ship unloaders and ship loaders; conveying units and storage solutions for cement and fly-ash. Our machines transport products such as;

- ▼ Cement
- ▼ Fly ash
- ▼ Alumina
- ▼ Granulated slag
- ▼ China clay

Worldwide service  
and spare parts deliveries

## VAN AALST BULK HANDLING BV

(International Trade Center) - Engelandlaan 56 - 2391 PN Hazerswoude-Dorp  
The Netherlands

### HEAD OFFICE

tel: +31 172 213 341  
fax: +31 172 232 804  
e-mail: [info@vanaalstbulkhandling.com](mailto:info@vanaalstbulkhandling.com)



specializes in condition assessments, maintenance and design of maritime facilities including container terminals, intermodal rail facilities, passenger and cruise terminals, break-bulk and neo bulk terminals and mixed-used developments. TranSystems is recognized in the United States and internationally for their innovative and cost-effective solutions for the maritime industry.

## TRF Limited (TaTa)

11 Station Road  
Burma Mines  
Jamshedpur  
Jharkhand  
831 007  
India  
Contact: Mr Rajen Sahay  
Job Title: Head of Corporate Communications  
T: + 91 657 3046 407  
E: rajen.sahay@trf.co.in  
W: www.trfltd.com / www.tata.com/trf  
An engineering company with expertise in the field of bulk material handling and processing. Its products include ship loaders handling iron ore and other bulk products.

## Triodetic

10 Didak St  
Arnprior  
Ontario K7S 0C3  
Canada  
Contact: Mrs Sue Staniszewski  
Job Title: Sales Manager  
T: + 1 613 623 3434  
F: + 1 613 622 4003  
E: info@triodetic.com  
W: www.triodetic.com  
Designs, manufactures and constructs stockpile enclosures and roofs for tanks and storage/treatment facilities. Roofing consists of a network of connected steel or aluminium tubes as a space frame or single layer shell in any required geometric configuration. The product is pre-engineered and comes to site with protective coatings appropriate to the service life requirements.

## Triple Point Technology

22 Frith Street  
Mayfield West  
NSW  
2304  
Australia  
Contact: Mr Steve Maxwell  
Job Title: G Vice President, Mining, APAC Sales  
T: + 61 2 4908 2222  
F: + 61 2 4968 2043  
E: info@tpt.com  
W: www.tpt.com  
Triple Point Technology® is the leading global provider of cloud and on-premise Commodity Management software. Triple Point's QMASTOR solutions manage the tonnage, quality and value of coal and mineral supply chains from "pit" to the point of export, import, or consumption.

## TS Systems BV

PO Box 206  
De Giessen 19  
Dronten  
8253 PR  
The Netherlands  
Contact: Mr Peter Slotje  
T: + 31 321 33 90 91  
F: + 31 321 33 99 88  
E: info@tssystem.nl  
W: www.tssystem.nl  
European distributor of steel and stainless steel FLOVEYOR Aero-mechanical conveying systems capable of moving up to 50 tonnes per hour.

## ts-systemfilter gmbh

Gänsacker 9  
Ahorn-Berolzheim  
74744  
Germany  
Contact: Mr H Straub  
T: + 49 6296 880  
F: + 49 6296 8855  
E: info@ts-systemfilter.de  
W: www.ts-systemfilter.de  
Produces filter units with dust separation equipment.

## Tsubaki Kabelschlepp GmbH

Daimlerstr. 2  
Wenden-Gerlingen  
D-57482  
Germany  
Contact: Mr Frank Springer  
T: + 49 2762 4003 0  
F: + 49 2762 4003 220  
E: info@kabelschlepp.de  
W: www.kabelschlepp.de  
Plastic and Steel Cable Carrier Systems, LIFE-LINE Cables.

## Tsubakimoto Bulk Systems Corporation

4-1  
Terauchi 2-Chome  
Toyonaka  
Osaka  
561-0872  
Japan  
Contact: Mr Y Horii  
Job Title: Manager, Overseas Operations  
T: + 81 6 6862 2329  
F: + 81 6 6862 8516  
E: sales@tsubaki-bulk.com  
W: http://tsubakimoto.com/tbs/  
Produces bulk handling systems equipment, bucket, flow and pan conveyors.

## Tsuji Heavy Industries (Jiangsu)

Co Ltd  
Du Jing Gang, Da Xin Zhen, Zhang  
Jia Gang  
Along Yang tze river, Economy & Development Zone  
Zhang Jia Gang  
215636  
China  
Contact: Mr Yang Yen Yoong  
Job Title: Dy. General Manager (Marketing & Sales)  
T: + 86 512 58713111  
F: + 81 0512 5873170  
E: yang@tsuji-hi.com.cn  
W: www.tsuji-hi.com.cn

## TTS HuaHai Ships Equipment

18th Floor  
3255 Zhou Jia Zui Road  
Shanghai  
200093  
China

Contact: Mr Lian Zhou Yang  
Job Title: Business Development Manager  
T: + 86 21 6539 8257  
F: + 86 21 6539 7400  
E: info@tts-huahai.com

## TTS Marine AS

Barstøveien 26  
Kristiansand  
4606  
Norway  
Contact: Mr. Peter Klasson  
Job Title: Communications & Marketing Coordinator  
T: + 47 55 94 74 08  
F: + 47 55 94 74 01  
E: info@tts-marine.no  
W: www.ttsgroup.com

## TTS Marine GmbH

Gutenberg Str. 1  
Bad Schwartau  
SH  
23611  
Germany  
Contact: Mr Torsten Paas  
Job Title: General Manger Cargo Cranes  
T: + 49 4514 501 115  
F: + 49 4514 501 390  
E: t.paas@tts-marine.de  
W: www.ttsgroup.com

## TTX Corporation

101 N Wacker Drive  
Chicago  
Illinois  
60606  
USA  
Contact: Mr Peter Wolff  
Job Title: Director - Market Development  
T: + 1 312 984 3722  
F: + 1 312 984 2682  
E: marketing@ttx.com

## Tufbag

PO Box 155  
Mandini  
KwaZulu Natal  
4490  
South Africa  
Contact: Mr Russell Titmas  
Job Title: National Sales Manager  
T: + 27 32 459 5050  
F: + 27 32 459 2581  
E: russell.titmas@tufbag.com  
W: http://tufbag.com  
Produce woven polypropylene FIBC's and small WPP open mouth and valved sacks, including the Adstar® product with block bottom and valves. Our Polypropylene sacks and bags are currently used for the packaging of commodities such as cement, sugar, rice, wheat, maize flour, salt, fertilisers, animal feeds and cotton seeds.

## Turck B.V.

Ruiterlaan 7  
Zwolle  
8019 BN  
The Netherlands  
Contact: Mr Frank de Jong  
T: + 31 38 4227750  
F: + 31 38 4227451  
E: frank.dejong@turck.com  
W: www.turck.nl  
Turck is a leading manufacturer in industrial automation. With an enormously versatile range of more than 13,000 sensor, fieldbus, interface and connectivity products, Turck offers highly efficient product solutions for factory and process automation.

## Ulrich Brehme GmbH

Otto-Hahn-Str. 1  
Hattorf am Harz  
37197  
Germany  
Contact: Mr Bodo Altgeld-Wichmann  
Job Title: Marketing Manager  
T: + 49 5584 94210 0  
F: + 49 5584 94210 99  
E: info@brehme-ubo.com  
W: www.brehme-ubo.com  
For more than 50 years Ulrich Brehme GmbH have been manufacturers of bulk materials equipment and components for all industries.

## United DC

8947 Market Street  
Houston  
TX 77029  
USA  
Contact: Mr Ben Levine  
Job Title: President  
T: + 1 713 671 8200  
F: + 1 713 671 8224

## V D D B (Pty) Ltd

PO Box 16985  
Lytelton  
Gauteng  
0140  
South Africa  
Contact: Mr Leonard van der Dussen  
T: + 27 12 664 2300  
F: + 27 12 644 2902  
E: admin@vddb.co.za  
W: www.vddb.co.za  
Engineering and design of optimised air-supported belt conveyors.

## Van Aalst Bulk Handling BV



Engellandlaan 56  
Hazerswoude Dorp  
2391 PN  
The Netherlands  
Contact: Mr Dick Borst  
Job Title: Sales/Marketing Manager  
T: + 31 172 213 341  
F: + 31 172 232 804  
E: hvest@vanaalstbulkhandling.com  
W: www.vanaalstbulkhandling.com  
BULK CEMENT HANDLING:  
Supply of pneumatic bulk handling equipment, ship loaders, ship unloaders, storage and reclaim installations for cement, fly ash and other dusty abrasive materials. Spare parts delivery, maintenance engineers and operators world wide.

## Van Aalst Marine & Offshore B.V.

Baanhoekweg 16  
Dordrecht  
3313 LA  
The Netherlands  
Contact: Ing. Wijnand van Aalst  
Job Title: Managing Director  
T: + 31 78 622 1304  
F: + 31 78 622 9490  
E: nfo@vanaalstbulkhandling.com  
W: www.vanaalstbulkhandling.com  
Specialist in pneumatic bulk handling equipment for loading, unloading, conveying and storing of powders and dusty or abrasive materials such as cement, fly ash, alumina, etc. A service oriented and flexible organisation with offices all over the world.





**Modular Reclaiming System**  
**THE UNIVERSAL SOLUTION**

# LEADING THE WAY

A collage of five images arranged in a circular pattern. Top-left: A pile of straw or biomass. Top-right: A power plant with two large white domes. Center: A circular diagram with a grid of colored squares (purple, green, yellow, red, blue) radiating from a central white dot. Bottom-left: A pile of wood pellets. Bottom-right: A close-up of a metal floor with a grid of rectangular panels and screws.

**Automatic operation**  
**100% clearance**  
**High reclaim rate**  
**No routine maintenance**  
**Low energy consumption**  
**No vibration or stress transfer to structure**  
**No dust nor product degradation**  
**Inbuilt redundancy**  
**No wearing parts**

Over 20 years of research, development and successful projects  
[www.vibrafloor.com](http://www.vibrafloor.com)





**Van Beek bv**

PO Box 168  
 Drunen  
 5150 AD  
 The Netherlands  
 Contact: Mr Peter Paul Rutten  
 T: + 31 416 375 225  
 F: + 31 416 378 350  
 E: info@van-beek.nl  
 W: www.van-beek.nl

The bulk car loader, Dino®, is used to load a wide range of bulk goods with divergent specific properties - either packaged in loose bags or big bags. Its capacity of 40 - 80 cubic metres per hour makes it possible to load a silo in an hour.

**Van Tongeren Kennemer BV**

Gooiland 8  
 Beverdijk  
 1948 RC  
 The Netherlands  
 Contact: Mr Bert Korbeek  
 T: + 31 251 229 160  
 F: + 31 251 212 382  
 E: email@tongerenkennemer.nl  
 W: www.tongerenkennemer.nl

**Veenstra Machinefabriek B.V.**

De Holwert 10  
 KC Coevorden  
 7741  
 The Netherlands  
 Contact: Mr Paul Kuiper  
 T: + 31 524 599 333  
 F: + 31 524 599 330  
 E: mach@veenstra-coevorden.nl  
 W: www.veenstra-coevorden.nl

**VEN SA**

19 Chemin du Blanc Caillou  
 Braine-L'Alleud  
 B-1420  
 Belgium  
 Contact: Mr Roderick Norman  
 T: + 32 2 384 20 27  
 F: + 32 2 385 15 88  
 E: ven@skynet.be

**Ventomatic SPA**

Via G. Marconi, 20  
 Valbrembo  
 24030  
 Italy  
 Contact: Mrs Nicolette Cattaneo  
 Job Title: Marketing Manager  
 T: + 39 035 468 311  
 F: + 39 035 528 027/ + 39 35 4608 38

E: vento@ventomatic.it  
 W: www.ventomatic.it

**Ventyx**

193 Turbot Street  
 Brisbane  
 Queensland  
 4000  
 Australia  
 Contact: Mr Greg Clark  
 Job Title: CEO  
 T: + 61 7 3303 3333  
 F: + 61 7 3303 3232  
 E: info@mincom.com  
 W: www.ventyx.com

**Verachtert Nederland B.V.**

De Bloemendaal 8  
 Hertogenbosch  
 North Brabant  
 5221  
 The Netherlands  
 Contact: Mr Daniël de Kruijff  
 T: + 31 73 640 41 35  
 F: + 31 73 641 97 40  
 E: daniel.de.kruijff@veraned.nl  
 W: www.veraned.nl/en

**Verstegen Grippers BV**



PO Box 1014  
 Nieuwegein  
 3430 BA  
 The Netherlands  
 Contact: Mr Eric Visser  
 Job Title: Managing Director  
 T: + 31 3060 62222  
 F: + 31 3060 60657  
 E: info@verstegen.net  
 W: www.verstegen.net  
 Specialists in developing, designing and manufacturing all kinds of grabs. A leading grab manufacturer with extensive experience whose grabs are in operation all over the world. More than 10,000 grabs have been manufactured for all kinds of materials and applications and delivered to 80 countries worldwide.

**Vibco Inc**

PO Box 8  
 Stilson Rd  
 Wyoming  
 RI

02898  
 USA  
 Contact: Mr Carl Wadensten  
 T: + 1 401 539 2392 x130  
 F: + 1 401 539 2584  
 E: vibrators@vibco.com

**Vibrafloor**  
*VibraFLOOR*

Les Pièces Bourgeoises  
 Givry  
 71640  
 France  
 Contact: Mr Jean-Claude Poncet  
 Job Title: President  
 T: + 33 3 85 44 06 78  
 F: + 33 3 85 44 06 79  
 E: jc.poncet@vibrafloor.com  
 W: www.vibrafloor.com  
 VIBRAFLOOR, the modular vibrating floor, is used in various bulk industries, inside silos, ships and railway cars as a versatile reclaiming using powered gravity.

Reliable **handling solutions**  
for dry **agribulk cargoes**

Pneumatic or Mechanical Ship Loaders & Unloaders  
Port Equipment-Turnkey Projects



*Most efficient hold cleaning*



*Mechanical CSU = up to 1,500 tons/hour*



**Vigan**



Rue de L'Industrie 16  
Nivelles  
B-1400  
Belgium  
Contact: Mr Nicolas Dechamps  
Job Title: Managing Director  
T: + 32 67 89 50 41  
F: + 32 67 89 50 60  
E: info@vigan.com  
W: www.vigan.com  
VIGAN ENGINEERING designs and manufactures bulk materials handling systems for agribulk cargo (mainly cereals), some chemicals, woodpellets... VIGAN expertise covers complete turnkey solutions - from project engineering to commissioning- for port terminals, including ship unloading & loading, storage facilities and bagging operations. Complete information and references on <http://www.vigan.com>

**Vollert Anlagenbau GmbH**

Stadtseestr. 12  
Weinsberg  
74189  
Germany  
Contact: Mr Juergen Schiemer  
Job Title: Vice President  
T: + 49 7134 52 232  
F: + 49 7134 52 222  
E: juergen.schiemer@vollert.de  
W: www.vollert.com  
For over 80 years Vollert is worldwide acting as competent engineers and supplier of shunting

equipment. For each shunting problem Vollert provides robust, low-maintenance and individual system solutions capable of being automated and above all at very reasonable prices. Vollert provides the perfect solution for moving wagons.

**Volvo (VCM Belgium NV)**

Woluwelaan 9  
Vilvoorde  
1800  
Belgium  
Contact: Mr Bill Law  
Job Title: Director of External Communications  
T: + 32 2 254 1411  
F: + 32 2 520 261  
E: bill.law@volvo.com  
W: www.volvo.com  
Volvo CE develops, manufactures and markets equipment for construction and related industries. Its products include a range of wheel loaders, motor graders, articulated haulers, excavators and compact equipment. Volvo CE is part of the Volvo Group, the world's largest manufacturer of diesel engines in the 9 to 18 litre category.

**Vossloh Kiepe GmbH**



Kiepe-Platz 1  
Düsseldorf  
D-40599

Germany  
Contact: Mr Manfred Grünwald  
Job Title: Head of Sales Industrial Components  
T: + 49 211 7497 270  
F: + 49 211 7497 420  
E: m.gruenwald@kiepe-elektrik.com  
W: www.kiepe-elektrik.com  
VOSSLOH KIEPE is a leading supplier of pull wire switches, belt drift switches and speed monitoring devices for the control of belt conveyors. The trade mark KIEPE is worldwide a synonym for proven products of highest quality.

**VSR Industrietechnik GmbH**

Am Alten Schacht 6  
Duisburg  
D-47198  
Germany  
Contact: Mr Wolfgang Schlabach  
Job Title: Export Manager  
T: + 49 20 66 99 66 40  
F: + 49 20 66 99 66 62  
E: info@vsr-industrietechnik.de  
W: www.vsr-industrietechnik.de  
VSR Blaster products have been proving themselves in the bulk handling business for more than 35 years and are recognised for their extensive expertise, high effectiveness and dependability. The conveyor belt solutions found in the Dustex, Vibrex, Carex and Linex systems improve the conveying quality and are environmentally friendly.

**Webster Griffin Ltd**

Brooklands Park  
Farnham Road  
Crowborough  
East Sussex

TN6 2JD  
UK  
Contact: Ms Jo Smith  
T: + 44 1892 664250  
F: + 44 1892 664340  
E: info@webstergiffin.com  
W: www.webstergiffin.com  
Webster Griffin are a leading supplier of modular bagging machinery. We manufacture modular and mobile bagging systems ideal for high speed 'on-the-spot' dock side filling of fertilizer, grain, sand, sugar, rice into small bags and sacks.

**Wieland Lufttechnik GmbH**

Wetterkreuz 12  
Erlangen  
91058  
Germany  
Contact: Mr Gerhard Borrmann  
Job Title: Export Manager  
T: + 49 9131 60 67 0  
F: + 49 9131 60 67 97  
E: info@wieland-luft.de  
W: www.wieland-luft.de  
One of the leading manufacturers of industrial vacuum cleaning and material handling systems. Portable - stationary - truck or trailer mounted vacuum cleaning systems.

**Windmüller & Hölischer KG**

Münsterstr. 50  
Lengerich  
D-49525  
Germany  
Contact: Mrs Elisabeth Braumann  
Job Title: Public Relations  
T: + 49 5481 14 2929  
F: + 49 5481 14 3355  
E: elisabeth.braumann@wuh-group.de

W: www.wuh-group.com/  
Windmüller & Hölischer - one of the leading machine manufacturers in the world for the flexible packaging industry and the global leader in bag making and bagging equipment.

**Wirtech AG**

Zelgstrasse 86  
Uetendorf  
CH-3661  
Switzerland  
Contact: Mr K Buehler  
Job Title: Marketing  
T: + 41 33 346 5050  
F: + 41 33 346 5059  
E: info@wirtech.ch  
W: www.wirtech.ch

**Worley Parsons Canada (Westmar)**

400-233 West First Street  
North Vancouver  
BC  
V7M 1B3  
Canada  
Contact: Mr Richard Malinek  
T: + 1 604 985 6488 ext 5218  
F: + 1 604 985 2581  
E: info@westmar.com  
W: www.westmar.com  
Multi-disciplinary consulting firm with design expertise in the maritime, civil, structural, mechanical and environmental fields associated with bulk materials handling, utilising state-of-the-art computer simulation for the planning and optimisation of bulk terminals and transportation systems.

**KIEPE – Keep a good thing going**

**Vossloh Kiepe GmbH**

P.O.B. 16 02 51  
D-40565 Düsseldorf (Germany)  
Phone +49 (0) 2 11 74 97-2 80  
Fax +49 (0) 2 11 74 97-4 20  
info@kiepe-elektrik.com  
www.kiepe-elektrik.com

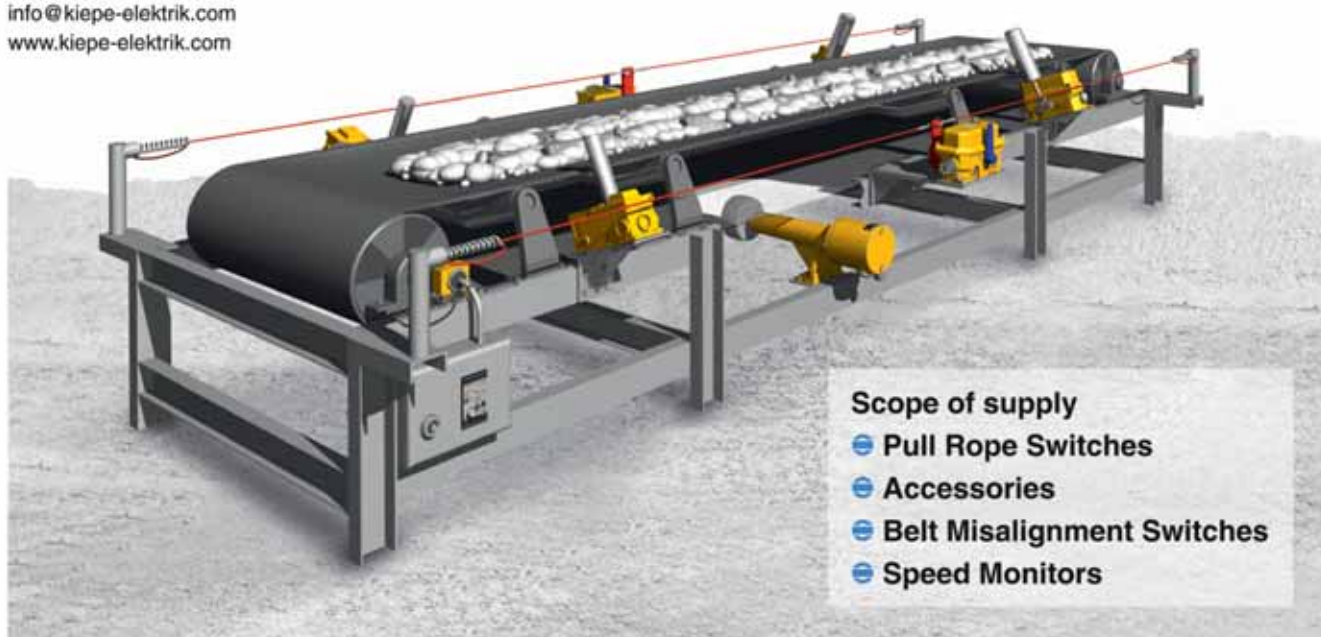

**Scope of supply**

- Pull Rope Switches
- Accessories
- Belt Misalignment Switches
- Speed Monitors

## WorleyParsons

2645 Skymark Avenue  
Mississauga  
ON  
L4W 4H2  
Canada  
Contact: Mr Jeremy Okolisan  
Job Title: Director, Business  
Development  
T: + 1 905 614 1778 ext 2871  
F: + 1 905 614 1780  
E: jeremy.okolisan@  
worleyparsons.com  
W: www.worleyparsons.com  
Additional services include: Ports &  
Marine Terminal Planning,  
Transportation Studies and Supply  
Chain Logistics, Marine Structure  
Design (inshore and offshore),  
Coastal Processes, Cold Weather  
(Arctic) Engineering including Ice  
Management, Site Development  
and Civil Infrastructure, Terminal

Waste Water Treatment &  
Management, Environmental  
Assessment and Management,  
Contaminated Sites and Waste  
Management, Condition Inspections  
and Asset Management

## Wuvio Chemicals

Honderdland 239  
Maasdijk  
Westland  
2676 LV  
The Netherlands  
Contact: Mr Micha De Jong  
Job Title: General Manager  
T: + 31 1745 200 01  
F: + 31 1745 200 03  
E: info@wuvio.com  
W: www.wuvio.com

## Yernaux-Pasage

Zone Industrielle Beraugard PB  
552  
Brive Cedex  
19107  
France  
Contact: Mr Willy Banc  
Job Title: Marketing Department  
T: + 33 475 66 4600  
F: + 33 555 860 563  
E: willy.banc@preclamolen.fr

## Yokohama Rubber Co

MB Overseas Sales Dept  
6-1-11 Shimbashi Minato-Ku  
Tokyo 105-8656  
Japan  
Contact: Mr Funakoshi  
Job Title: Marketing  
T: + 81 3 5400 4816  
F: + 81 3 5400 4830  
E: yinfo@mta.yrc.co.jp

## Young Industries Inc

PO Box 30  
16 Painter Street  
Muncy  
PA  
17756  
USA  
Contact: Mr William Mahoney  
T: + 1 570 546 3165  
F: + 1 570 546 1888  
E: mktinfo@younginds.com  
W: www.younginds.com  
Manufacturer of dilute and dense  
phase pneumatic conveying and  
bulk materials processing systems  
and equipment.

## Zakkentrale B.V.

3100 AJ Schiedam  
Cairostraat 50  
Rotterdam  
3047 BC

The Netherlands  
Contact: Mr Harm Peters  
Job Title: Managing Director  
T: + 31 10 462 3511  
F: + 31 10 462 6939  
E: exim@zakkentrale.nl  
W: www.zakkentrale.nl  
Trading and production of Flexible  
packaging material made out of  
woven polypropylene or  
polyethylene film. 25/50 kg bags,  
FIBC's (big bags), containerliners,  
handling and storage systems. The  
company is ISO certified and our  
production facilities are working  
according to the highest norms  
(ISO, HACCP, AIB, certified).





# BULK HANDLING EQUIPMENT COMPANIES — ALPHABETICAL LISTING

**Key:**

- SL = Shiploaders
- CR = Cranes
- GL/U = Grab Loaders/Unloaders
- MCSU = Mechanical CSUs
- PSU = Pneumatic ship unloaders
- BL/U = Barge loaders/unloaders
- GR = Grabs
- MCN = Mechanical conveyors
- PCN = Pneumatic conveyors
- ST/R = Stackers & reclaimers
- MHE = Mobile harbour equipment
- HP = Hoppers
- CR/S = Crushing & Screening
- WGH = Weighing
- SM/I = Sampling & inspection
- DC = Dust control/suppression
- DV/C = Drives & controls
- STG = Storage systems
- RL/T = Rail & truck handling
- SU = Self unloading shipping equipment
- ENG = Engineering consultants
- BAG = Bag handling
- OTH = Other equipment



	SL	CR	GL/U	MCSU	PSU	BL/U	GR	MCN	PCN	ST/R	MHE	HP	CR/S	WGH	SM/I	DC	DV/C	STG	RL/T	SU	ENG	BAG	OTH
4B BRAIME Elevator Components				✓				✓								✓	✓						✓
A. Friedr Flender AG																	✓	✓					
A/S Cimbria	✓					✓		✓			✓	✓		✓		✓	✓	✓	✓		✓		✓
AAF Ltd																✓							
ABB Engineering (Shanghai) Ltd.	✓	✓	✓							✓							✓		✓				
ABB Switzerland Ltd																	✓						✓
Abbey Rollers Limited								✓															
AC Robinson & Associates																						✓	
Achenbach GmbH Metalltechnik								✓	✓														
Advance Automated Systems Ltd																							
AE AntiEmission GmbH																	✓					✓	✓
AE Automation (M) Sdn bhd	✓							✓		✓		✓	✓	✓	✓	✓	✓	✓		✓	✓		✓
Aeromaster International Ltd								✓	✓			✓										✓	✓
AFM Industries	✓									✓													
AgGrowth International Inc.																							
Agora Services								✓	✓			✓											
Agrico Sales, Inc.	✓					✓		✓		✓									✓	✓			✓
Agromatic AG														✓	✓	✓	✓						✓
AJ Sackett & Sons Company	✓							✓				✓								✓			
AKJ Industries																	✓						✓
Alcan Alesa Technologies Ltd	✓				✓	✓		✓	✓			✓		✓				✓	✓		✓	✓	
Alex Stewart Agriculture Ltd														✓	✓								
Alex Stewart International															✓								
Alfredo Brand P.																							
All-Fill International Ltd																						✓	✓
Allison Engineering Ltd																							
ALS Inspection														✓	✓								
AMECO SA	✓				✓	✓		✓		✓													
Antar@Pressvess																		✓					
ANUPAM INDUSTRIES LIMITED	✓	✓																					
Anvil Attachments								✓															
Arlona Engineering								✓															
ASGCO																							
ASGCO Manufacturing																							
ATIC Services																✓							
ATIC Services - Asia Pacific																✓							
Atlas Manufacturing Co. Inc				✓	✓		✓																
AUMUND Foerdertechnik GmbH					✓			✓		✓	✓	✓						✓					
Aurecon	✓																						
Aurecon Hatch	✓			✓				✓		✓			✓			✓	✓		✓		✓		
Ausenco	✓			✓	✓	✓		✓		✓		✓	✓	✓	✓	✓	✓	✓	✓	✓	✓		✓
AusGroup Limited																							
Avplast Dis Tic. Ve Paz. Ltd. Sti.																							✓

# BULK HANDLING EQUIPMENT

	SL	CR	GL/U	MCSU	PSU	BL/U	GR	MEN	PCN	ST/R	MHE	HP	CR/S	WGH	SM/I	DC	DV/C	STG	RL/T	SU	ENG	BAG	OTH	
B. A. G. Corp.																								✓
Bagfilla SA Pty Ltd																								✓
Bayards Aluminium Constructions																			✓					✓
Bedeschi SpA	✓					✓			✓			✓	✓				✓		✓					
BEHN + BATES Maschinenfabrik GmbH & Co. KG																								✓
Bekaert NV									✓	✓														
Belt Equipment Supplies Sdn Bhd									✓	✓			✓							✓				✓
BELTANA Trading EK									✓	✓														
Bemo Rail BV																				✓				
Benetech GmbH																		✓						
Benetech, Inc.									✓	✓								✓		✓			✓	
Bergu International AB																								✓
Beumer Group GmbH & Co KG	✓				✓				✓	✓														✓
BGS Holland	✓																	✓						
Binder + Co AG					✓																			
Birrus International Pty Ltd						✓			✓	✓														
BLUG Credeblug S.L.	✓		✓	✓		✓	✓				✓						✓			✓				✓
BMT De Beer	✓	✓																				✓		✓
Bogaert Transmission (GEHA)									✓															✓
Bonfanti srl		✓												✓				✓						
Bosch Rexroth AG																								
Bosch Rexroth B.V.	✓		✓	✓		✓			✓		✓		✓							✓	✓			
Bosch Rexroth Mellansel AB																								
Boyne Area Manufacturing (BAM)	✓			✓		✓			✓	✓		✓					✓	✓	✓	✓		✓	✓	✓
Brelko Conveyor Products									✓	✓								✓						✓
Bretby Gammatech Ltd.																								✓
Bridgestone Industrial Limited	✓								✓															
Bridon International Ltd		✓																						✓
Brock Grain Systems																								
BRUKS AB	✓			✓					✓				✓							✓				
BRUKS Klöckner GmbH																								
BRUKS Rockwood Incorporation	✓								✓				✓											
BSG Resources													✓											
Bucket Mart Inc.	✓	✓	✓	✓	✓	✓	✓				✓													
Bühler AG, Grain Logistics	✓			✓	✓	✓			✓			✓		✓	✓	✓	✓	✓	✓	✓		✓		
BULK .ID																								
Bulk Cargo Handling BVBA	✓					✓																		
Bulk Lift International	✓																							✓
Bulk Logistic Landmark																								
Buttimer Bulk Engineering	✓		✓			✓		✓	✓	✓	✓	✓	✓	✓	✓	✓	✓	✓	✓	✓	✓	✓		
BV Beco							✓																	
ByM Agencia Martima																								✓
C. Christophel GmbH													✓											
Cable Arm Inc							✓																	
Cachapuz Bilanciai Group														✓										
Calim Grab Industry	✓		✓			✓						✓												✓
Camar Mill Systems Ltd																							✓	
Cambelt International Corp								✓		✓														
Capotex								✓																
Carbonser, S. A. DE C. V.								✓										✓						
Cargotec Sweden AB, Marine Selfloaders					✓																	✓		
Carlsen Group	✓			✓	✓	✓		✓	✓			✓									✓	✓		
Carmatec AB	✓			✓	✓	✓		✓	✓			✓									✓	✓		
Carsurin																	✓							
Caterpillar Belgium																								
Caterpillar Commercial Northern Europe																								✓
Caterpillar Inc			✓			✓	✓																	✓
Caterpillar SARL	✓											✓												✓
Cavotec Deutschland GmbH	✓	✓								✓	✓	✓	✓									✓	✓	✓
Cavotec Inc																								
Cavotec SA																								✓
CDM Systems, Inc	✓			✓		✓			✓															
Cesur Packaging Corporation									✓															
CFS Handling srl.			✓																					
CH2M Hill																								✓
Changsha Kaiyan Instruments Co. Ltd																								
Chief Industries UK Ltd.									✓															✓
Chief Industries, Inc.																								
China Huadian Engineering Co., Ltd.(CHEC)	✓		✓	✓		✓		✓				✓						✓	✓	✓		✓		✓
China Sonangol International (S) Pte Ltd																								✓
CHL Equipment Ltd (incorp. Verstegen Grabs UK)							✓																	
Christianson Systems Inc.					✓	✓			✓		✓													
CICSA & MCV s.r.l.								✓																



	SL	CR	GL/U	MCSU	PSU	BL/U	GR	MCN	PCN	ST/R	MHE	HP	CR/S	WGH	SM/I	DC	DV/C	STG	RL/T	SU	ENG	BAG	OTH
Cimbria Bulk Equipment						✓		✓									✓		✓				
Clariant Corporation																							✓
Clarke Chapman Manufacturing																							
Claudius Peters Technologies GmbH			✓	✓	✓	✓			✓														
Claudius Peters Technologies S.A.S			✓	✓	✓	✓		✓	✓	✓													
Cleveland Cascades Ltd	✓					✓											✓						
Clime SA																							✓
Clough Limited	✓																					✓	
CNBM International Engineering Co., Ltd.	✓	✓	✓	✓	✓	✓	✓	✓	✓	✓	✓	✓	✓	✓			✓	✓	✓	✓	✓	✓	✓
CNK INTERNATIONAL LIMITED																							
Coal & Mineral Technologies (SABS)															✓								
COBRA Europe SA								✓															
Coeclerici S.p.A.																							✓
Cofely Experts BV	✓	✓			✓						✓												
Coles Associates																							
COMBI LIFT USA INC																							✓
Comercial Tauro S.A.																							
CONDUCTIX (Delachaux)			✓		✓													✓					
Conductix-Wampfler Australia			✓																				
Conductix-Wampfler AG																		✓					✓
Conductix-Wampfler Americas	✓	✓	✓	✓	✓	✓		✓	✓	✓	✓	✓					✓	✓		✓	✓	✓	✓
Conservatek Industries, Inc.																			✓				
Continental Construction (Memphis)																							✓
Continental Conveyor & Equipment Co Inc	✓							✓															
CONTINENTAL MATADOR RUBBER, s.r.o.									✓														
ContiTech Transportbandsysteme GmbH									✓														
Control Systems Technology Pty Ltd															✓								✓
Coperion GmbH					✓			✓	✓										✓	✓		✓	
Cornell & Co Inc																							✓
Cotesi SA																							✓
CPS Projects (Pty) Ltd	✓		✓	✓	✓		✓			✓													
Crippen Manufacturing Company																							✓
CST Covers																				✓			
CST Storage												✓							✓				
CTI Group Inc	✓			✓		✓	✓	✓	✓			✓		✓			✓	✓	✓			✓	✓
CTP Team Srl																	✓						
Cullen Grummitt & Roe																						✓	
Custom Equipment Design, Inc.								✓				✓										✓	✓
Cygnus Instruments Limited																							✓
Dalian Huarui Heavy Industry Group Co. Ltd	✓	✓			✓					✓													
Dantherm Filtration Ltd																		✓					
David Osborne Engineering Ltd	✓	✓	✓	✓		✓		✓		✓			✓						✓	✓		✓	✓
DAWSON																							
DBIS (Software & Automation) Ltd														✓				✓	✓			✓	
DCC Grabs				✓			✓				✓												
DCL, Incorporated	✓					✓												✓		✓			
DCW Group Co				✓	✓	✓				✓	✓												
De Regt Conveyor Systems								✓															
Dearborn MidWest Conveyor Co.	✓					✓		✓		✓	✓	✓	✓	✓	✓	✓	✓	✓	✓	✓	✓	✓	✓
Demag Cranes & Components GmbH		✓									✓												
DeMarco Industrial Vacuum Corporation	✓			✓	✓	✓			✓	✓		✓											
DemcoTECH Engineering								✓		✓													
Dinnissen BV									✓					✓	✓								✓
DMN-WESTINGHOUSE								✓	✓									✓					✓
Dome Corp of North America										✓								✓					
Dome Technology																			✓				✓
DOMTEC International LLC																			✓				✓
Don Valley Engineering Co Ltd								✓		✓		✓	✓					✓	✓			✓	✓
Donaldson Filtration (GB) Ltd																		✓					
Donaldson Filtration Deutschland GmbH																		✓					
Doosan Benelux SA					✓		✓			✓	✓												✓
Doppelmayr Transport Technology GmbH									✓														
Dos Santos International, LLC	✓					✓		✓	✓			✓										✓	
Dosco Overseas Engineering Ltd								✓	✓					✓									
Dosetec Exact Oy																							✓
Doubrava Ges GmbH					✓	✓		✓											✓				

INTRODUCING THE GLOBAL LEADER IN COVER SOLUTIONS.

# CST COVERS

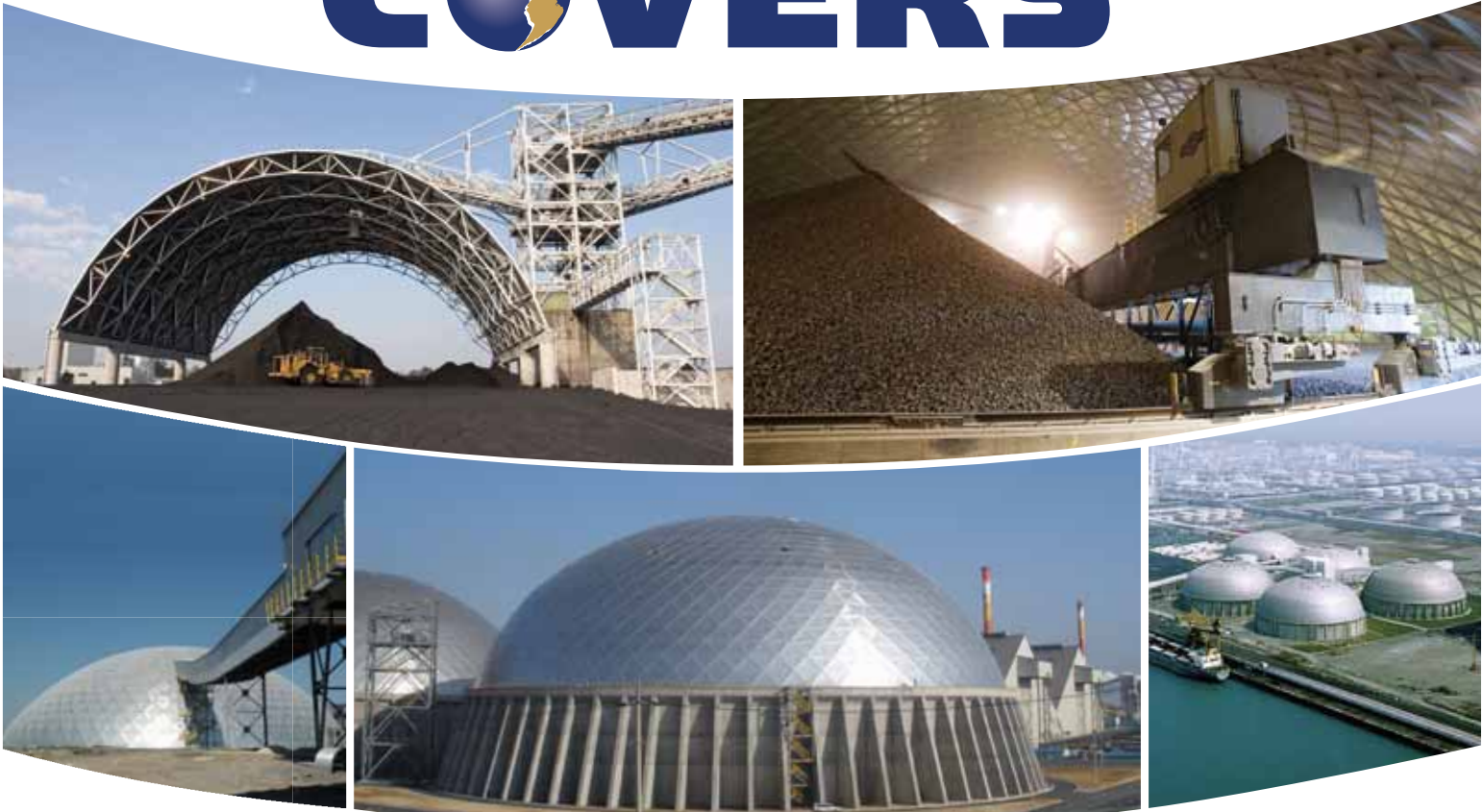

**TEMCOR** **CONSERVATEK®**

**SINCE 1964 • OVER 16,000 INSTALLED • OVER 90 COUNTRIES**

### **Dry Bulk Storage Solutions**

- All-aluminum clear-span structures
- High strength-to-weight ratio
- Maintenance free – never rusts, rots, chips or solar degrades
- Economical installation – light weight translates to faster erection times and reduced erection costs
- Project support around the world

[www.cstcovers.com](http://www.cstcovers.com)

CST Covers | 498 N Loop 336 E | Conroe, TX 77301 USA | p: 936-539-1747 | f: 936-539-5355



	SL	CR	GL/U	MCSU	PSU	BL/U	GR	MCN	PCN	ST/R	MHE	HP	CR/S	WGH	SM/I	DC	DV/C	STG	RL/T	SU	ENG	BAG	OTH		
Doyle Manufacturing Co																								✓	
Draka Automotive GmbH																									✓
DRC Engineering																									✓
Dry Bulk Solutions			✓				✓				✓										✓	✓			✓
DS SM a/s	✓					✓		✓		✓	✓	✓	✓	✓					✓						✓
DSH Systems Ltd.	✓					✓		✓		✓	✓	✓	✓	✓			✓			✓	✓				✓
Dulevo International S.p.A.																									✓
Dunlop Conveyor Belting			✓					✓		✓				✓			✓			✓					✓
DURO FELGUERA, S.A.	✓	✓	✓			✓		✓		✓	✓	✓	✓	✓			✓		✓	✓			✓		✓
Dust Control Technology																		✓							✓
Dust Solutions Inc.																	✓								✓
E-Crane World Wide		✓	✓			✓	✓				✓	✓								✓					✓
E-Crane World Wide /																									✓
E-Crane International USA		✓	✓			✓						✓													✓
E-Crane Worldwide-Indusign NV	✓	✓	✓			✓	✓				✓	✓													✓
ECS Eurocargo Services AS														✓	✓										✓
Edge	✓					✓		✓	✓	✓	✓		✓												✓
EIFFEL Etablissement SOMDEL	✓	✓		✓		✓		✓	✓	✓		✓	✓				✓		✓						✓
Elecon Engineering Company Ltd	✓	✓						✓	✓	✓		✓	✓	✓			✓		✓						✓
Elecon Singapore PTE Ltd.	✓							✓	✓	✓		✓	✓				✓		✓						✓
Electro-Motive Diesel (EMD) Inc																	✓		✓						✓
Elgin Engineering & Construction			✓			✓														✓					✓
Emaq-Verolme Estaleiros SA																									✓
EMDE INDUSTRIE-TECHNIK								✓						✓	✓		✓								✓
EMS-TECH Inc	✓			✓		✓		✓		✓	✓	✓					✓		✓		✓	✓			✓
EMS-TECH Inc.	✓					✓		✓	✓	✓		✓					✓	✓	✓		✓	✓			✓
EMTICI Engineering Co Ltd								✓			✓														✓
Enclosed Bulk Systems BV																									✓
Enco Engineering Inc	✓			✓		✓		✓				✓					✓		✓		✓	✓			✓
Endress + Hauser Inc														✓	✓		✓								✓
Engicon nv	✓			✓				✓		✓		✓													✓
Engineering System Solutions																									✓
Enso-Gutzeit Oy																									✓
Entecon UK Ltd								✓																	✓
Enviro Abrasion Resistant Engineers Pvt. Ltd								✓																	✓

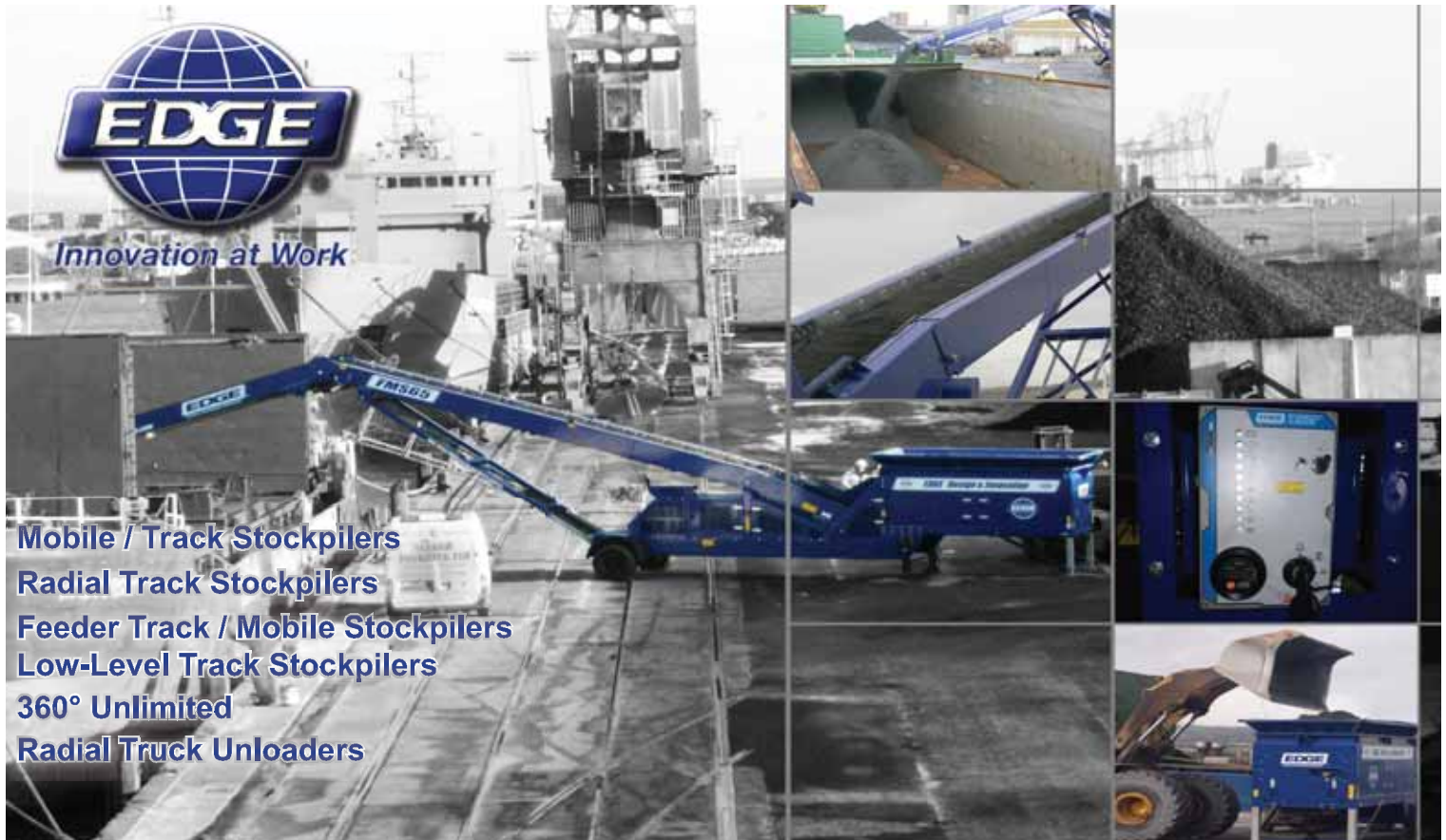

**Mobile / Track Stockpilers**  
**Radial Track Stockpilers**  
**Feeder Track / Mobile Stockpilers**  
**Low-Level Track Stockpilers**  
**360° Unlimited**  
**Radial Truck Unloaders**

**Edge Innovate N.I LTD.**  
 30 Farlough Road  
 Dungannon  
 BT71 4DT  
 +44 (0)28 87 740525

You Tube     
[www.edgeinnovate.com](http://www.edgeinnovate.com)  
[info@edgeinnovate.com](mailto:info@edgeinnovate.com)

*“Equipment built to work as hard as you do”*

# BULK HANDLING EQUIPMENT

	SL	CR	GL/U	MCSU	PSU	BL/U	GR	MCN	PCN	ST/R	MHE	HP	CR/S	WGH	SM/I	DC	DV/C	STG	RL/T	SU	ENG	BAG	OTH		
EPMC Europe BV	✓	✓	✓	✓		✓	✓	✓		✓					✓	✓			✓						
EQ Trade																									
EQUIPO LLC							✓																		
Eriez Europe													✓		✓										✓
ESI Eurosilo BV								✓										✓				✓			
Euromec Srl							✓				✓														
Euro-tech Corporation							✓																		
Euro-Tramco BV				✓				✓																	
F E Schulte Strathaus GmbH & Co KG								✓								✓								✓	
F L Smidth A/S	✓			✓	✓	✓		✓	✓	✓			✓		✓			✓					✓		✓
Failure Control Ltd																						✓			
Fairport Engineering								✓					✓				✓	✓							
FAM Canada Inc								✓																	
FAM Foerderanlagen Magdeburg	✓		✓	✓		✓		✓		✓		✓	✓	✓		✓		✓	✓			✓	✓	✓	✓
Famak SA	✓		✓					✓		✓									✓						✓
Fantuzzi Reggiane S.p.a	✓		✓			✓		✓		✓	✓							✓							✓
FELD Maschinen-und Industriebau GmbH																									
FEMADIGIPACK S.r.l	✓	✓	✓			✓	✓																✓		✓
Fenner Dunlop Conveyor Belting Europe								✓																	
Fenner plc								✓																	
Figee Crane Services BV	✓	✓	✓			✓	✓											✓							✓
Flexco								✓									✓	✓							✓
Flexco Europe GmbH																									✓
Flexicon Corporation																									
Flexicon Europe Ltd																									
Flexoveyor Conveyor								✓																	
Flomat Bagfilla International Limited								✓	✓	✓	✓	✓		✓		✓		✓					✓		✓
FLSmidth GmbH								✓																	
FLSmidth Inc.	✓			✓	✓	✓			✓										✓			✓			
FLSmidth Minerals Pvt. Ltd	✓																								
FLSmidth Spokane, Inc.								✓	✓	✓		✓													
FLSmidth Wadgassen GmbH	✓		✓	✓		✓		✓		✓			✓						✓				✓		✓
FMC Corporation								✓																	
Fortum Power and Heat OY																									✓
FPS Mustang																									✓
Frigate Technologies Private Limited				✓	✓	✓		✓	✓	✓		✓	✓	✓				✓			✓		✓		✓
Gama Endustri Tesisleri Imalat Ve Montaj AS	✓																								





	SL	CR	GL/U	MCSU	PSU	BL/U	GR	MCN	PCN	ST/R	MHE	HP	CR/S	WGH	SM/I	DC	DV/C	STG	RL/T	SU	ENG	BAG	OTH	
Gambarotta Gschwendt	✓							✓															✓	
Gantrex Inc.	✓	✓				✓				✓		✓												
Ganz Danubius Trading Co Ltd	✓		✓	✓	✓		✓																	
Garwood Consulting Ltd	✓		✓	✓		✓		✓		✓		✓				✓	✓		✓	✓	✓	✓		
General Bridge Engineering Ltd						✓		✓		✓		✓	✓					✓	✓					
General Kinematics Corp.								✓	✓															
Genivar Inc																							✓	
Geométrica de México, S.A. de C.V.																✓			✓					
Geometrica Inc																✓			✓					
Geroldinger GmbH & Co KG									✓	✓		✓							✓					
Gertech Handling Systems cc								✓	✓			✓				✓			✓				✓	
GF MHS Srl	✓							✓	✓	✓	✓	✓	✓	✓	✓	✓			✓	✓		✓	✓	✓
GGT Goldengrain Trading SA															✓									
Golden West Industries																✓								
Golfetto Sangati S.r.l.				✓	✓			✓	✓		✓	✓							✓					
Goodman Conveyor Company								✓																
Goodtech Solutions AS								✓	✓		✓	✓		✓		✓			✓	✓		✓	✓	✓
Gordinne & Co NV/SA															✓									
Gottwald Port Technology USA	✓	✓																						
GREIF-VELOX																							✓	✓
Greystones Cargo Systems (Pty) Ltd	✓			✓	✓			✓									✓						✓	
Gubre Fabrikalari TAS	✓	✓						✓			✓	✓											✓	
Gulsan A.p.																							✓	
Guttridge Ltd								✓				✓				✓			✓				✓	
Guven Grab and Machine Ltd. Co							✓																	
H J Wiefferink BV					✓														✓					
H Noorman BV																								✓
Halcrow																						✓		
Hans Turck GmbH & Co. KG																	✓							
Hansen Industrial Transmissions NV																	✓							
Hansen Transmissions Ltd																	✓							
Hanson Silo Company																			✓					
Hapman								✓	✓		✓												✓	
Hasel Machinery Inc																	✓							
Haskoning India Pvt Ltd																								
Hasler International SA												✓		✓			✓							
HAUGEN System AB											✓					✓								✓
HAVER & BOECKER OHG, Machinery Division													✓	✓	✓		✓		✓		✓	✓	✓	✓
Haver & Boecker Wire Weaving Division													✓		✓		✓						✓	
Hebei Xinrong Rubber Products Co., Ltd								✓																
Heinrich Schwacke GmbH & Co KG		✓																						
Henry International Diplomatic Marine																								✓
Hethon Nederland BV									✓			✓		✓	✓									
Heyl & Patterson Inc			✓	✓		✓	✓			✓										✓				
Hitachi Construction Machinery (Europe) NV		✓																						✓
Horizon Conveyor Equipment								✓																
HOSCH-Fördertechnik Recklinghausen GmbH								✓																✓
HPC Hamburg Port Consulting GmbH																							✓	
Huadian Heavy Industries Co., Ltd.																								
Hycontrol Limited															✓									
Hyundai Heavy Industries Co	✓	✓	✓	✓	✓			✓		✓														
IBAU HAMBURG	✓			✓		✓		✓	✓		✓	✓	✓						✓	✓	✓	✓	✓	✓
IBC International Handling AB									✓			✓	✓	✓								✓	✓	✓
Igus GmbH		✓																✓						
IHI Transport Machinery Co., Ltd. (IUK)	✓	✓	✓	✓	✓	✓		✓	✓	✓	✓								✓			✓		
IMASA																								
IMGS	✓							✓	✓	✓		✓											✓	✓
Imperial Technologies, Inc.						✓		✓		✓		✓	✓	✓										
Impsa - Industrias Metalurgicas Pescarmana			✓															✓						
Incolab Services BV														✓	✓									
Indexator Rotator Systems AB																								✓
Industrial Netting (Pty) Ltd																							✓	
Industrias Murtra																							✓	
Inman SA				✓	✓			✓		✓							✓				✓			
Inspectorate America Corporation															✓									

# BULK HANDLING EQUIPMENT

	SL	CR	GL/U	MCSU	PSU	BL/U	GR	MEN	PCN	ST/R	MHE	HP	CR/S	WGH	SM/I	DC	DV/C	STG	RL/T	SU	ENG	BAG	OTH	
Inspectorate International Ltd																								
Interjute BV																								
International Bulk Handling Technology BV																								
Interstate Equipment Corporation																								
Intersystems																								
Invicta Vibrators																								
iSAM AG Gesellschaft fuer angewandte Kybernetik																								
Isomonte SA																								
Italgru S.r.l																								
J & B Grabs b.v.																								
J C Steele & Sons Inc																								
Jansen & Heuning																								
Jansens & Dieperink BV																								
Jem International & Express Scale Parts																								
Jenike & Johanson Inc.																								
Jim Way Enterprise Co Ltd																								
Johannes Hübner Fabrik Elektrischer Maschinen GmbH																								
John R Boone Ltd																								
Joy Mining Machinery																								
JSC Tehnoros																								
Jumbo Shipping																								
Kalenborn Kalprotect GmbH & Co. KG																								
Kardesler Grab & Machine																								
KCT Grab Industry																								
Kinergy Corporation																								
King Bag & Manufacturing Co																								
Kingfisher Industrial Ltd																								
KINSHOFER GmbH																								
KIROW ARDELTA GmbH																								
Kleemann GmbH																								
Knight Energy Services Limited																								
Kocks Krane International GmbH																								
Konecranes (France)																								
Konecranes B.V. - The Netherlands																								
Konecranes Finland Corporation																								
Konecranes Hafentechnik GmbH																								
Kornylak Corporation																								
KPI-JCI and Astec Mobile Screens																								
Kramer & Duyvis BV																								
Kranunion																								
Kröger Greifertechnik GmbH & Co. KG																								
K-T Bulk																								
Lachenmeier Monsun A/S																								
Laidig Systems Inc																								
Laing O'Rourke																								
Langston Companies Inc																								
Lanier & Associates																								
Larox Flowsys Oy																								
Larsen & Toubro Limited																								
Larsen & Toubro Limited																								
Lassing Dibben Consulting Engineers Ltd																								
Lawrence Industries, Inc.																								
LB Officine Meccaniche S.p.A.																								
LBU Marine & Cranes																								
Les Consultants LBCD inc.																								
Libran Engineering and Services																								
Librawerk Maschinenfabrik GmbH																								
Liebherr-Hydraulikbagger GmbH																								
Liebherr-Singapore Pte Ltd																								
Liebherr-Werk Nenzing GmbH																								
Listenow GmbH & Co.																								
Lochtec ApS																								
Logmarin Advisors Srl																								
LogSys NV																								
Loibl Allen-Sherman-Hoff GmbH																								
Macawber Engineering, Inc																								
MacGREGOR Group AB																								
MacGregor SWE AB																								
MacGregor SWE AB																								
Machiniefabriek Stramproy SA																								
Mack Manufacturing Inc																								
Mactenn Systems Ltd.																								



# LIFT YOUR PROFITS WITH THE FLOATING POWER OF NKMNOELL

Winner of the IJB Innovative Technology Award

OPERATIONAL HIGHLIGHTS:  
CAPACITY UP TO 2,000 TONS PER HOUR  
OPTIMAL MOBILITY  
LOW FUEL CONSUMPTION  
LOW EMISSIONS  
LOW COST PER TON

Tranship more tons an hour of any bulk commodity, at lower costs per ton, anywhere in a port area, even with low waters or no quay facilities, from ship-to-ship, ship-to-shore, and even on open sea with full work comfort and safety...

Discover the power behind economic bulk transhipment and lift your profit with NKMNoell's new generation Floating Grab Cranes...



Contact us for custom new build or retrofit, refurbishment and full upgrade of existing cranes. Our wide experience with harbour cranes means we always have the best solutions.

**NKMNOELL**  
SPECIAL CRANES

NKM Noell Special Cranes GmbH  
Kruisweg 643, 2132 NC Hoofddorp, Netherlands  
Tel: +31 20 655 0030 • Fax: +31 20 655 0040  
info@nkmnoell.com • www.nkmnoell.com

**MANTSINEN  
CLAMSHELL BUCKETS**

Purpose-built for heavy duty  
hydraulic cranes

Capacity range  
from 1,5 to 14 m<sup>3</sup>

**MANTSINEN 70**

up to 500 t/h

**MANTSINEN 90**

up to 600 t/h

**MANTSINEN 120**

up to 800 t/h

**MANTSINEN 160**

up to 1000 t/h

**MANTSINEN 200**

up to 1200 t/h

**MANTSINEN HybriLift®**

Increases Energy Efficiency  
by up to

**35%**

MANTSINEN HybriLift® lifts your efficiency to next level with hydraulic precision

**OUR HYBRID EVOLUTION IN ACTION**



**More load, less energy**

[www.mantsinen.com](http://www.mantsinen.com)



	SL	CR	GL/U	MCSU	PSU	BL/U	GR	MCN	PCN	ST/R	MHE	HP	CR/S	WGH	SM/I	DC	DV/C	STG	RL/T	SU	ENG	BAG	OTH
Mahr GmbH Anlagentechnik für Schüttgüter				✓												✓		✓					
Manitowoc Engineering		✓	✓								✓												
Mantsinen Group Ltd Oy	✓	✓	✓			✓	✓				✓								✓			✓	✓
Maquinas Condor SA	✓				✓	✓		✓	✓	✓	✓			✓								✓	✓
Marine Inspection and Logistics Group Ltd															✓								
Martin Engineering								✓								✓			✓			✓	✓
Martin Engineering c/o GSFA Consulting																							
Martin Engineering GmbH	✓							✓	✓							✓						✓	
Martin Engineering South Africa								✓								✓							✓
Maschinen und Mühlenbau Erhard Muhr GmbH	✓																		✓				
MASS Ltd																							✓
Matcon																			✓				
MATEC massagoed techniek BV	✓			✓		✓		✓	✓		✓	✓	✓					✓			✓	✓	✓
Material Handling Asia								✓															
Mentor Dynamics																							✓
Merius Oy																						✓	✓
Merrick Industries														✓									
Metso Minerals Industries, Inc.	✓	✓	✓	✓		✓	✓	✓		✓			✓	✓					✓				
MH Automation International Ltd		✓																					
Midwest Industrial Supply Inc																	✓						
Midwest International Standard Products, Inc.	✓					✓										✓			✓				
Mitchell Consulting Group, Inc	✓		✓	✓		✓															✓	✓	
Mitsubishi Heavy Industries	✓		✓	✓	✓			✓		✓	✓												
Mitsubishi Nagasaki Machinery								✓															
Mitsui Engineering & Shipbuilding Co			✓	✓	✓						✓										✓		
Mitsui Miike Machinery Co., Ltd.	✓				✓				✓	✓											✓		
Mitsui Zosen Europe Limited																							✓
Moffatt & Nichol																						✓	
Mogensen Sizers								✓															✓
Mole•Master Services Corporation™												✓							✓				✓
Möllers Maschinenfabrik GmbH								✓	✓					✓				✓	✓		✓	✓	✓
Motherwell Automation																	✓					✓	✓
Motridal SpA	✓			✓		✓		✓		✓									✓				
MRS Greifer GmbH			✓				✓																
Mühlen Sohn GmbH & Co. KG					✓	✓			✓										✓	✓	✓		
Müller Beltex BV								✓									✓						
MUT - Maschinen-Umwelttechnik Transportanlagen								✓		✓													
National Bulk Equipment Inc																							
NAVCO (National Air Vibrator Co)																							
Nectar Group Ltd							✓		✓		✓	✓		✓								✓	✓
Negrini Srl							✓																
Nemag BV		✓	✓				✓				✓												✓
NEO CORP BRASIL																							
NERAK GmbH Fördertechnik								✓	✓														
Neuero Corporation	✓		✓	✓	✓	✓		✓	✓	✓	✓										✓		✓
Neuero Industrietchnik GmbH	✓			✓	✓			✓			✓												
Niifisk-CFM SpA									✓														✓
NILOS GmbH & Co KG								✓					✓									✓	✓
NKM Noell Special Cranes GmbH	✓	✓	✓								✓	✓		✓			✓	✓			✓		✓
NM Heilig BV						✓		✓		✓	✓	✓	✓										
Noell Crane Systems (China) Ltd		✓																					
Nordströms Konstruktionsbyrå	✓				✓												✓						✓
Nordstrong Equipment Ltd	✓							✓		✓	✓									✓			
North American Crushing & Screening, LLC													✓										
Northern Conveyors								✓															
NSL ENGINEERING PTE LTD																							
O B Wiik AS																			✓				
Oceanport Shiploaders Ltd	✓																						
OdT S.r.l.								✓															
OMIC Perth															✓								
Onestone Consulting Group GmbH																						✓	
OP system ab																							
Orthos Projects Ltd.				✓				✓			✓	✓	✓	✓		✓	✓				✓		
ORTS GmbH Maschinenfabrik							✓																
PAGE MACRAE ENGINEERING			✓				✓				✓	✓					✓						✓
PAM Poul Andersen Maskinfabrik A/S					✓				✓		✓												
Parker Plant Ltd	✓							✓	✓				✓				✓						
Paul Hedfeld GmbH								✓															

# BULK HANDLING EQUIPMENT

	SL	CR	GL/U	MCSU	PSU	BL/U	GR	MEN	PCN	ST/R	MHE	HP	CR/S	WGH	SM/I	DC	DV/C	STG	RL/T	SU	ENG	BAG	OTH
Pavan Group Srl	✓			✓	✓											✓							
PEBCO®	✓					✓		✓			✓					✓			✓				✓
PEMA Verpackung																						✓	
Peterson Agricare & Bulk Logistics BV															✓								
Pfister Waagen Bilanciai GmbH														✓									
PHB Weserhütte, S.A.	✓	✓	✓			✓	✓	✓		✓	✓	✓	✓	✓	✓	✓	✓	✓	✓		✓	✓	
Phelps Industries																						✓	✓
Phenix Rousies Industries																✓			✓				
PHOENIX Conveyor Belt Systems GmbH									✓														
PINTSCH BUBENZER GmbH		✓	✓	✓	✓			✓		✓			✓							✓			
Pirs SAS																				✓			
PIV Drives GmbH - a Brevini																		✓					
Power Transmission Co.																		✓					
Plantragg Developments																							✓
Plastruct-Polyzone												✓									✓		✓
PLM Cranes B.V.		✓	✓			✓	✓														✓		
Polymer Industries - Ultrapol Division																							✓
Port Contractors																							
Portasilo Ltd																				✓			
Portpack UK Limited																							
Port-Trade ApS	✓	✓					✓			✓	✓									✓			
Powerscreen International																							
Powertex Inc																							✓
Precia-Molen Nederland BV												✓		✓								✓	
Precia-Molen UK Ltd														✓									✓
Premier Tech Chronos B.V.								✓			✓	✓										✓	✓
Premier Tech Chronos GmbH								✓			✓	✓										✓	✓
Premier Tech Chronos Ltd								✓			✓	✓										✓	✓
Primasonics International Limited												✓								✓			✓
Procon Engineering Limited																							
PSTek LLC																							✓
PT Bajra Mandalasakti																						✓	
PT Bukaka Teknik Utama		✓																					
PT Jakarta Prima Cranes	✓	✓				✓		✓		✓		✓	✓	✓	✓	✓	✓				✓		
PT Pamapersada Nusantara						✓		✓		✓		✓	✓	✓	✓	✓	✓			✓			✓
PT SpanSet Indonesia																							✓
PT Thiess Contractors Indonesia																							
PT. Bando Indonesia								✓															
Quadrant Engineering																							
Plastics Products												✓								✓	✓		✓
Quadrant PHS				✓																			
Quality Handling Systems Pty Ltd																✓							
Qube Ports & Bulk																							
R & S S.r.L.	✓		✓	✓	✓	✓	✓	✓	✓	✓	✓	✓	✓	✓	✓	✓	✓	✓	✓	✓	✓	✓	✓
RAM Spreaders	✓					✓																	
RAP Conveyors Ltd						✓		✓															
Rapat Asia																							
Rapat Corporation								✓															
Rapidpack Corporation	✓						✓					✓										✓	✓
RBL-REI France						✓				✓	✓	✓								✓	✓		
RC Inspection B.V																✓							
RDS Technology																✓							
REMA TIP TOP GmbH								✓	✓				✓										
Renby Ltd								✓															✓
Rexnord Industries Inc								✓		✓													
RHC Heavy Handling Machinery Limited																							
RHC Heavy Machinery Ltd	✓			✓			✓	✓				✓											
Risun Technologies	✓			✓		✓		✓		✓		✓							✓	✓		✓	✓
River Consulting																						✓	
RJS Siloclean International Ltd																							
RKR Gebläse & Verdichter GmbH																							✓
Roberts & Schaefer Company	✓	✓	✓	✓		✓	✓	✓		✓	✓	✓	✓	✓	✓	✓	✓	✓	✓	✓	✓	✓	✓
Robson Handling Technology								✓															✓
RockTree Logistics Pte. Ltd.																						✓	✓
Ronin GMS																							✓
Royal Bodewes																							
Royal Haskoning DHV	✓	✓	✓	✓	✓	✓	✓	✓	✓	✓	✓	✓	✓	✓	✓	✓	✓	✓	✓	✓	✓	✓	✓
RTA ALESA Ltd.	✓			✓	✓			✓	✓													✓	
Rubb Buildings Ltd																							
Rud Kettenfabrik								✓															✓
RULMECA HOLDING S.P.A.																							✓
SABS - Mining & Minerals																							
Saiag Industria SpA																✓							
Salzgitter Maschinenbau AG/ PEINER SMAG Lifting Technologies GmbH							✓																



	SL	CR	GL/U	MCSU	PSU	BL/U	GR	MCN	PCN	ST/R	MHE	HP	CR/S	WGH	SM/I	DC	DV/C	STG	RL/T	SU	ENG	BAG	OTH	
Sammi	✓					✓		✓		✓	✓	✓	✓	✓	✓	✓	✓				✓	✓	✓	
Sampling Associates International															✓		✓	✓						
Samson Materials Handling Ltd						✓																		
SAMSON Materials Handling Ltd	✓					✓		✓		✓	✓							✓	✓					✓
Sandvik Mining	✓					✓		✓		✓		✓	✓				✓	✓						✓
Sandvik Mining	✓		✓					✓		✓		✓	✓	✓					✓					✓
Sandvik Mining and Construction (China) Co., Ltd.																								
SANWA COMMERCIAL CO., LTD.							✓																	
Sartorius Mechatronics T&H GmbH														✓										
SCAFCO Corporation																								✓
Scantech International															✓									
Schade Lagertechnik GmbH								✓		✓									✓	✓				
Schenck Process Africa (Pty) Ltd														✓	✓									
Schenck Process GmbH		✓									✓		✓	✓			✓							
Schenck Process UK Limited	✓							✓	✓				✓	✓			✓			✓				✓
Schenck Process UK Ltd																								
T/A Redler	✓							✓		✓	✓	✓		✓					✓					✓
Schouten Commodities BV																								✓
Scorpio Engineering Pvt. Ltd	✓				✓	✓		✓	✓	✓	✓	✓		✓			✓	✓	✓	✓		✓	✓	
Sea Spec International															✓									
Sea Transport Corporation																								✓
Seabulk Inc	✓			✓	✓			✓		✓											✓	✓		
S-E-G Instrument AB														✓										
Selpeco Resources Inc.	✓			✓	✓	✓		✓	✓	✓	✓	✓	✓				✓	✓		✓				✓
Sempertrans France Belting Technology SAS								✓																
SENNEBOGEN Maschinenfabrik GmbH	✓		✓			✓	✓				✓													✓
Sensor Technology Ltd														✓			✓							
Sentry® Equipment Corp															✓									
Servo Berkel Prior														✓										
SESCOTRANS (SAE)	✓			✓																				
SEW-EURODRIVE GmbH & Co KG																	✓							
SGH Equipment Limited								✓																✓
SGS															✓									
SGS (Nederland) BV															✓									
SGS Australia Pty Ltd															✓									
SGS Austria Controll-Co GmbH															✓									
SGS Minerals Services															✓									
SGS Minerals Services														✓	✓		✓						✓	
Shanghai Global Machinery. Co., Ltd (SGMC)								✓																
Shanghai Janus Grab Co., Ltd.																								
Shanghai Qifan Co., Ltd.	✓							✓																
Shanghai Yo-Pi Port Machinery		✓						✓			✓													
Shanghai Zhenhua Port Machinery Co (ZPMC) Ltd	✓		✓	✓																✓	✓			
Shanthi International								✓																
Shaw Almex Canada								✓																
Shepherd Construction																			✓					
SIBRE - Siegerland Bremsen GmbH																		✓						✓
SIDERAR / TERNIUM																								
Siebtechnik GmbH													✓		✓									✓
Siemens AG	✓	✓	✓			✓				✓								✓		✓		✓		✓
Siemens AG																		✓						
Siemens Nederland NV																		✓						
SIG Società Italiana Gomma Spa								✓																
Silvan Dis Ve IC Ticaret AS																								✓
Sime Industrie																								✓
Simplicity Projects Pvt Ltd				✓																				
Siwertell – a Cargotec brand	✓			✓	✓	✓		✓	✓	✓	✓								✓					✓
SMB International GmbH	✓			✓		✓		✓		✓										✓				✓
Smiley Monroe Ltd								✓					✓											
SMM-UM Sociedade de																								
Montagens Metalomecanicas SA	✓	✓	✓	✓			✓	✓			✓	✓						✓	✓					✓
Sobemai by IRI nv	✓		✓			✓	✓																	
Societe de Tolerie Industrielle Francaise									✓									✓						
Solimar Pneumatics																				✓				
Solitec Engineering Ltd								✓				✓												
Sotecma Inc Process Engineers																				✓		✓		
Specialised Handling & Eng (Pty) Ltd	✓							✓		✓	✓								✓	✓		✓	✓	
Specimas																								✓
Spencer																								
Spiroflow Ltd								✓	✓															✓
STAG AG								✓	✓											✓				
Standard Industrie (Airhoc)								✓				✓						✓		✓				✓

	SL	CR	GL/U	MCSU	PSU	BL/U	GR	MEN	PCN	ST/R	MHE	HP	CR/S	WGH	SM/I	DC	DV/C	STG	RL/T	SU	ENG	BAG	OTH	
Stockpile Surveying and Protection BVBA																								
Stokman BV								✓				✓			✓						✓			
Stora Enso																								✓
Strudes Inc																						✓		
Sub Con Ltd																								
Sucofindo																								
Sumitomo Heavy Industries	✓	✓	✓	✓		✓		✓		✓	✓								✓					
Suomen Viljava Oy																			✓					
Supercargo, Lda																✓								
Superior Industries, Inc.	✓					✓		✓		✓	✓	✓		✓					✓	✓		✓		✓
Svensborg Brakes A/S	✓					✓		✓	✓	✓	✓	✓		✓				✓						✓
Swire CTM Bulk Logistics	✓	✓	✓			✓	✓	✓			✓	✓									✓			
Sympatec																								
Synergy Engineering Ltd																								
TAIM WESER, S.A.	✓	✓	✓			✓		✓		✓														
TAKRAF GmbH	✓					✓							✓											
TAKRAF India Pvt. Ltd.	✓		✓	✓		✓				✓	✓	✓	✓						✓					
TAURUS EMERGÉ																								✓
TBMA Europe BV									✓					✓	✓							✓	✓	✓
Tebodin Consultants & Engineers	✓				✓	✓	✓	✓				✓	✓	✓	✓	✓	✓	✓	✓	✓		✓	✓	✓
techNaero aps									✓								✓	✓						
Telestack Limited	✓		✓			✓		✓			✓	✓						✓	✓					
Tema BV													✓		✓									
TEMA Systems Inc.													✓		✓									
TENOVA S.p.A - Tenova																								
Takraf Italy	✓		✓	✓		✓		✓		✓		✓							✓	✓		✓	✓	✓
Tenova TAKRAF Africa								✓	✓	✓			✓				✓		✓	✓		✓	✓	✓
Terex Cranes c/o Terex																								
Demag GmbH		✓									✓													
Terex Fuchs GmbH			✓				✓													✓				
Terex Port Solutions		✓									✓	✓												
Teta Mühendislik A. .				✓	✓			✓						✓					✓					
Thames Side Sensors Ltd												✓		✓									✓	
The ACT Group								✓	✓	✓		✓	✓					✓	✓					
The BRUKS Group																								
The China Navigation Co. Pte. Ltd				✓		✓																		
The Grab Specialist b.v.							✓																	
The Raring Corporation																		✓						
Thermo Fisher Scientific								✓	✓					✓	✓		✓							✓
Thiele GmbH & Co KG								✓																✓
ThyssenKrupp Canada	✓							✓					✓											✓
ThyssenKrupp Materials Handling	✓	✓	✓	✓		✓		✓		✓	✓	✓	✓	✓	✓				✓	✓				✓
ThyssenKrupp Resource																								
Technologies GmbH	✓		✓	✓		✓		✓		✓								✓	✓	✓	✓	✓		✓
ThyssenKrupp Robins, Inc.	✓							✓		✓			✓									✓		✓
Tideworks Technology - Europe																			✓					
Timars Svets & Smeide AB														✓	✓	✓	✓						✓	
TMEIC																								
TMSA Tecnologia em Movimentação S/A	✓	✓	✓	✓	✓	✓	✓	✓	✓	✓	✓	✓	✓	✓	✓	✓	✓		✓					✓
Tobu Jukogyo Co							✓																	
Top Lift Int																								
Tranco Europe Limited								✓																
Tranco, Inc						✓		✓																✓
Trans Elektro																								
Transas Marine																								✓
Trans-Global Solutions, Inc.								✓																
Translift Port Equipment Services Inc																								
Transystems Corporation																								
TRF Limited (TaTa)				✓	✓			✓		✓														✓
Triodetic																			✓			✓		✓
Triple Point Technology																		✓		✓				✓
TS Systems BV								✓	✓			✓	✓	✓					✓	✓			✓	✓
ts-systemfilter gmbh																			✓					
Tsubaki Kabelschlepp GmbH	✓	✓																						
Tsubakimoto Bulk Systems Corporation								✓																
Tsuji Heavy Industries (Jiangsu) Co Ltd			✓																			✓		
TTS HuaHai Ships Equipment																								✓
TTS Marine AS	✓	✓					✓	✓			✓			✓							✓	✓		✓
TTS Marine GmbH																								
TTX Corporation																				✓				
Tufbag																								✓
Turck B.V.																✓	✓							✓
Ulrich Brehme GmbH	✓							✓	✓									✓	✓					✓



	SL	CR	GL/U	MCSU	PSU	BL/U	GR	MCN	PCN	ST/R	MHE	HP	CR/S	WGH	SM/I	DC	DV/C	STG	RL/T	SU	ENG	BAG	OTH	
United DC																							✓	
V D D B (Pty) Ltd																								
Van Aalst Bulk Handling BV	✓				✓	✓			✓		✓	✓				✓		✓	✓	✓				
Van Aalst Marine & Offshore B.V.				✓															✓					
Van Beek bv																							✓	
Van Tongeren Kennemer BV								✓																
Veenstra Machinefabriek B.V.	✓															✓								
VEN SA																							✓	
Ventomatic SPA																							✓	
Ventyx																							✓	
Verachtert Nederland B.V.																								
Verstegen Grijpers BV							✓																	
Vibco Inc								✓																
Vibrafloor				✓		✓				✓										✓				
Vigan	✓			✓	✓	✓		✓	✓		✓	✓		✓				✓						
Vollert Anlagenbau GmbH																							✓	
Volvo (VCM Belgium NV)																							✓	
Vossloh Kiepe GmbH																	✓						✓	
VSR Industrietechnik GmbH																✓							✓	
Webster Griffin Ltd								✓															✓	
Wieland Lufttechnik GmbH									✓							✓			✓				✓	
Windmüller & Hölscher KG																							✓	
Wirtech AG								✓																
Worley Parsons Canada (Westmar)																							✓	
WorleyParsons	✓	✓	✓	✓	✓	✓	✓	✓	✓	✓	✓	✓	✓			✓	✓	✓	✓	✓	✓	✓	✓	
Wuvio Chemicals																	✓							
Yernaux-Pasage														✓										
Yokohama Rubber Co								✓																
Young Industries Inc									✓															
Zakkencentrale B.V.																		✓						



## INLAND TRANSPORT

### BARGE COMPANIES

#### BELGIUM

##### Bulk Cargo Handling BVBA

Nijverheidskaai 28  
Bus 9  
Brussels  
1080  
Belgium  
Contact: Mr Nicola Samyn  
T: + 32 477 44 98 81  
E: bch.belgium@gmail.com

#### CANADA

##### Dismar

2615, Notre-Dame Centre  
C.P. 35  
Trois-Rivières  
Quebec  
G9A 5E3  
Canada  
Contact: Mr Eric Verville  
T: + 1 819 374 6203  
F: + 1 819 372 9276  
E: e.verville@elevtr.qc.ca  
W: www.dismar.qc.ca

##### Groupe Desgagnes Inc.

21, Rue du Marche-Champlain  
Quebec  
Quebec  
G1K 8Z8  
Canada  
Contact: Ms Suzanne Lafleche  
T: + 1 418 692 1000  
F: + 1 418 692 6044  
E: info@desgagnes.com  
W: www.desgagnes.com

##### Groupe Somavrac

3450 Boul. Gene H. Kruger  
C.P. 294  
Trois-Rivières  
Quebec  
G9A5G1  
Canada  
Contact: Mr Eric Boisvert  
T: + 1 819 379 3311  
F: + 1 819 379 5584  
E: info@grpml.com  
W: www.grpml.com

##### McKeil Marine Limited

208 Hillyard Street  
Hamilton  
Ontario  
L8L 6B6  
Canada  
Contact: Mr Brent Kinnaird  
T: + 1 905 528 4141 ext 298  
F: + 1 905 528 6144  
E: bkinnaird@mckeil.com  
W: www.mckeil.com  
Barges up to 11,000 mts available  
for transhipment within the  
US/Canada East Coast and St.  
Lawrence River, Arctic and Gulf of  
Mexico.

##### Seabulk Inc

Suite 150  
10271 Shellbridge Way  
Richmond  
British Columbia  
V6X 2W8



Canada  
Contact: Mr Sidney Sridhar  
T: + 1 604 273 1378  
F: + 1 604 273 1358  
E: sbs@seabulk.com  
W: www.seabulk.com  
Seabulk Systems Inc. is involved  
with 'Design and Build' projects in  
the marine bulk transportation  
industry. Ports, self-unloaders,  
transshippers developed by  
Seabulk have improved bulk  
transportation logistics significantly.

#### EGYPT

##### Egyptian International Shipping Co

PO Box 110  
Orman  
Giza  
Egypt  
Contact: Mr Mohamad Hashish  
T: + 20 2 37481565  
F: + 20 2 37481116  
E: mhashish@eisgroup.com.eg

#### FINLAND

##### ESL Shipping

Lintulahdenkuja 10  
Helsinki  
FIN-00580  
Finland  
Contact: Mr Tom Blomberg  
T: + 358 9 5211  
F: + 358 9 521 9999  
E: tom.blomberg@eslshipping.com  
W: www.eslshipping.fi

#### GERMANY

##### HTAG Häfen und Transport AG

Neumarkt 7-11  
Duisburg  
47119  
Germany  
Contact: Mr Joachim Holstein  
T: + 49 203 47989 128  
F: + 49 203 47989 191  
E: joachim.holstein@htag-  
duisburg.de  
W: www.htag-duisburg.de  
Shipping / Chartering, Ports / Cargo  
Handling, Contract Logistics,  
Forwarding, Bunkering, Ocean  
Shipping Agency. Branches in  
Rotterdam (NL), Thionville (F),  
Berlin, Emden, Ginsheim-  
Gustavsborg, Mannheim,  
Karlsruhe.

##### Oldendorff Carriers GmbH & Co.

KG  
Willy-Brandt-Allee 6  
Lubeck  
Schleswig Holstein  
D-23554  
Germany  
Contact: Mr Henning Oldendorff  
T: + 49 451 15000  
F: + 49 451 73522  
E: henning@oldendorff.com  
W: www.oldendorff.com

#### INDIA

##### J.M. Baxi & Co

Sapt Building  
2nd Floor

18 J.N. Heredia Marg  
Ballard Estate  
Mumbai  
400 001  
India  
Contact: Mr John C. Alexander  
T: + 91 22 2270 3779 / 82  
F: + 91 22 2210 3629  
E: jca@jmbaxi.com  
W: www.jmbaxi.com

##### United Shippers Ltd

2nd Floor United India Building  
Sir P M Road  
Fort  
Mumbai  
400 001  
India  
Contact: Mr sajay gwe  
T: + 91 22 6665 8300 67568400  
F: + 91 22 6665 391  
E: inquiry@unitedshippers.com  
W: www.unitedshippers.com

#### INDONESIA

##### PT. ANUGRAH LAUTAN LUAS

Jalan Arga Gede Blok D-1 No. 3  
Lantai 2b Komplek Abp  
Kotasari, Kec  
Gerogol  
Cilegon  
Banten 42436  
Indonesia  
Contact: Mr Erlangga Pratama  
Imran  
T: + 62 254 572101  
F: + 62 254 341040  
E: anugrah@all4logistics.biz  
W: www.anugrahlautanluas.com/

#### ITALY

##### Vitelli srl

Via del Campone 72/74  
Porto Santo Stefano  
Italy  
Contact: Mr Sergio Vitelli  
T: + 39 0564 814436  
F: + 39 0564 816676  
E: commerciale@vitellisrl.it  
W: www.vitellisrl.it

#### THE

#### NETHERLANDS

##### DAP Barging BV

Wilhelmskade 15 a  
Rotterdam  
3016 DK  
The Netherlands  
Contact: Mr Dirk A van der Plas  
T: + 31 10 282 7788  
F: + 31 10 282 7655  
E: dirk@dap-barging.nl  
W: www.dap-barging.nl/

##### Eurobulk Transport

Amstelwijckweg 15  
Dordrecht  
3316 BB  
The Netherlands  
Contact: Mr Zeeg Brasser  
T: + 31 786552400  
E: info@eurobulk.nl  
W: www.eurobulk.nl



**Euro-Rijn International BV**

Plaza 6  
Moerdijk  
4782 SK  
The Netherlands  
Contact: Mr van Tooren  
T: + 31168393220  
F: + 31168393260  
E: d.kuijpers@eurorijn.com

**Interriijn BV**

Kantoorgebouw Westgate  
Scheepmakerij 130  
Zwijndrecht  
3331 MA  
The Netherlands  
Contact: Ms Ellen Straver  
T: + 31 078 625 9399  
F: + 31 078 619 0775  
E: interriijn@interriijn.com  
W: www.interriijn.nl/

LBH Marketing Services BV  
Rijsdijk 13  
Rhoon  
3161 HK  
The Netherlands  
Contact: Mr Anton Wintermans  
T: + 31 10 506 5000  
F: + 31 10 506 5035  
E: anton@lbhneland.com  
W: www.lbh-group.com

**UK****Ashmead Maritime**

The Old Barns  
The Ham  
Coaley  
GL11 5AS  
UK  
Contact: Mr Peter Ashmead  
T: + 44 1453 860044  
F: + 44 1453 860045  
E: ashmead@aship.co.uk  
W: www.aship.co.uk

**J P Knight Group**

The Admiral's Offices  
Chatham Historic Dockyard  
Chatham  
Kent  
ME4 4TZ  
UK  
Contact: Mr Richard Knight  
T: + 44 1634 826633

F: + 44 1634 829093  
E: navigators@jpknight.com  
W: www.jpknight.com  
Berthing a 100,000 tonne tanker in Scotland's Cromarty Firth, salvaging a chemical carrier in mid-Atlantic or pushing thousands of tonnes of ore down a South American river, JP Knight has the specialist knowledge, experience and capability to meet the need

**UKRAINE****Transship LTD**

Marazlievskaya Str, 8  
Odessa  
65014  
Ukraine  
Contact: Ms Alice Zuikova  
T: + 380 482 333 332  
E: secret@transship.com.ua  
W: www.transship.com.ua

**USA****AEP River Operations**

16150 Main Circle Drive  
Suite 400  
Chesterfield  
MO 63017  
USA  
Contact: Mr Mark Stoppel  
T: +1 636 530 2121  
F: +1 636 530 4121  
E: mastoppel@aepriverops.com  
W: www.aepriverops.com  
AEP River Operations offers unparalleled barge transportation service. AEP River Operations, the second-largest barge company, offers an updated fleet with new boats and barges and best-in-class operations. We shipped 68MM tons of dry commodities along the

**American Commercial Barge Line**

PO Box 610  
Jeffersonville  
IN 47131-0610  
USA  
Contact: Mr David D. Jahnke  
T: + 1 812 2880169

E: david.jahnke@acbl.net

**ARTCO**

4666 Faries Parkway  
Decatur  
IL  
62526  
USA  
Contact: Mr Kevin Van Meter  
T: + 1 217 424 5556  
F: + 1 217 451 4122  
E: kevin.vanmeter@adm.com  
W: www.admworld.com

**Canal Barge Company, Inc**

835 Union Street  
New Orleans  
LA 70112-1469  
USA  
Contact: Mr Larry Barbish  
T: + 1 504 584 1535  
F: + 1 504 584 1505  
E: lbarbish@canalbarge.com  
W: www.canalbarge.com

**Cooper/T. Smith Stevedoring**

One Canal Place  
365 Canal Street  
Suite 1450  
New Orleans  
LA  
70130  
USA  
Contact: Mr Eric Hansen  
T: + 1 504 569 2160  
F: + 1 504 569 2188  
E: eric.hansen@coopertsmith.com  
W: www.coopertsmith.com  
Cooper/Consolidated does midstream transfers of all types of bulk cargoes and Breakbulk cargoes as well. Anchorages, buoy systems, and barge fleetings are located at 2 locations, Mile 134 and 171, Lower MS River.

**Forest Lines Inc**

PO Box 53425  
New Orleans  
LA 70153-3425  
USA  
Contact: Mr Joseph E Zehner  
T: + 1 504 529 1300  
F: + 1 504 593 6401  
W: www.forest-lines.com

**Ingram Barge Co**

4400 Harding Road  
Nashville  
TN  
37205-229  
USA  
Contact: Mr Daniel T. Martin  
T: + 1 615 298 8373  
F: + 1 615 695 3373  
E: dan.martin@ingrambarge.com  
W: www.ingrambarge.com  
Ingram Barge Company is the leading carrier on America's inland waterways, with a fleet of more than 150 towboats and approximately 5,000 barges that transport coal, aggregates, grain, fertilizer, ores, alloys, steel products and chemicals. For more info

**National Waterways Conference, Inc.**

1100 North Glebe Road  
Suite 1010  
Arlington  
VA  
22201  
USA  
Contact: Ms Carole Wright  
T: + 1 703 224 8007  
F: + 1 866 371 1390  
E: carole@waterways.org  
W: www.waterways.org  
Promotes a better understanding of the public value of the American waterways system and to document the importance of far-sighted navigation and water resources policies to a sound economy, industrial and agricultural productivity, regional development,

**Krech Ojard & Assoc**

227 W 1st St  
Suite 200  
Duluth  
Minnesota  
55082  
USA  
Contact: Mr Kevin Ehrenreich  
T: +1 218 727 3282  
F: +1 218 727 1216  
E: kevin.ehrenreich@krechojard.com  
W: www.krechojard.com

**LoneStar Transportation Inc**

3934 Sandshell Drive  
Fort Worth  
Texas  
76137  
USA  
Contact: Mr David Ferebee  
T: + 1 817 306 1000  
F: + 1 817 230 0240  
E: david.ferebee@lstinc.com

**McDonough Marine Service**

1750 Clearview Parkway  
Metairie  
LA 70001-2470  
USA  
Contact: Mr Pat Stant  
T: + 1 504 780 8100  
F: + 1 504 780 8200  
E: pstant@marmac.net

**MBLX Inc**

One Canal Place  
Suite 2100  
New Orleans  
LA 70130  
USA  
Contact: Mr David P Schulingkamp  
T: + 1 504 581 2033  
F: + 1 504 581 2035  
E: david.schulingkamp@mblox.com  
W: http://mbloxresources.com/

**Pere Marquette Shipping Company**

701 Maritime Drive  
PO Box 708  
Ludington  
MI  
49431  
USA  
Contact: Mr Chuck Leonard  
T: + 1 231 845 7846  
F: + 1 231 843 4558  
E: cleonard@pmship.com  
W: www.pmship.com

**Riverway Co.**

8400 Normandale Lake Boulevard  
Suite 920  
Bloomington  
MN 55437  
USA  
Contact: Mr Terry R Becker  
T: + 1 952-921-3994  
E: tbecker@riverway.com  
W: www.riverway.com

**Saint Lawrence Seaway Development Corporation**

U.S Department of Transportation  
1200 New Jersey Avenue SE  
Suite W32-300  
Washington  
DC  
20590  
USA  
Contact: Ms Rebecca Spruill  
T: + 1 202 366 0091  
F: + 1 202 366 7147  
E: rebecca.spruill@dot.gov  
W: www.greatlakes-seaway.com

**UAE****IMGS**

Mazaya Business Avenue  
Suite 2906  
Dubai  
UAE  
Contact: Mr Shahbaz Ali Khan  
T: + 97 144 458 335  
F: + 97 144 458 337  
E: shahbaz@imgsga.com  
W: www.imgsga.com



## INLAND TRANSPORT

### RAIL COMPANIES

#### AUSTRALIA

##### Asciano Limited

Level 6  
15 Blue Street  
North Sydney  
NSW 2060  
Australia  
Contact: Mr Murray Vitlich  
T: + 61 2 8484 8012  
F: + 61 2 8484 8154  
E: info@asciano.com.au  
W: www.asciano.com.au

##### Trans Coal Pty Ltd

Level 11, 225 Wickham Terrace  
Brisbane  
QLD  
4000  
Australia  
Contact: Ms Faith Dempsey  
T: +61 7 3831 8431  
F: +61 7 3831 8432  
E: fdempsey@transcoal.com.au  
W: www.transcoal.com.au

#### CANADA

##### Canadian National Railway

Public Affairs & Advtg Dept.  
2nd Floor 935  
LA Gauchetiere West  
Montreal  
Canada  
Contact: Ms Chantale Despres  
T: + 1 514 399 8753  
F: + 1 514 399 5344  
E: chantale.despres@cn.ca

##### CN Railway

250050 Lantz Way  
2nd Floor  
Rocky View County  
AB T1Z 0A8  
Canada  
Contact: Gurpreet (G K) Khaira  
T: + 1 403 798 2138  
F: + 1 403 798 2105  
E: Gurpreet.khaira@cn.ca  
W: www.cn.ca

##### Genivar Inc

1166 Laure Blvd  
Sept-Îles  
Quebec  
G4S 1C4  
Canada  
Contact: Mr Denis Blouin  
T: + 1 418 962 2241  
F: + 1 418 962 3641  
E: info@genivar.com  
W: www.genivar.com

#### GERMANY

##### Deutsche Bahn Gruppe

DB Cargo AG  
Königsstrasse 67-69  
Duisburg  
D-47051  
Germany  
Contact: Mr Hendrec Fiege  
T: + 49 6131 159

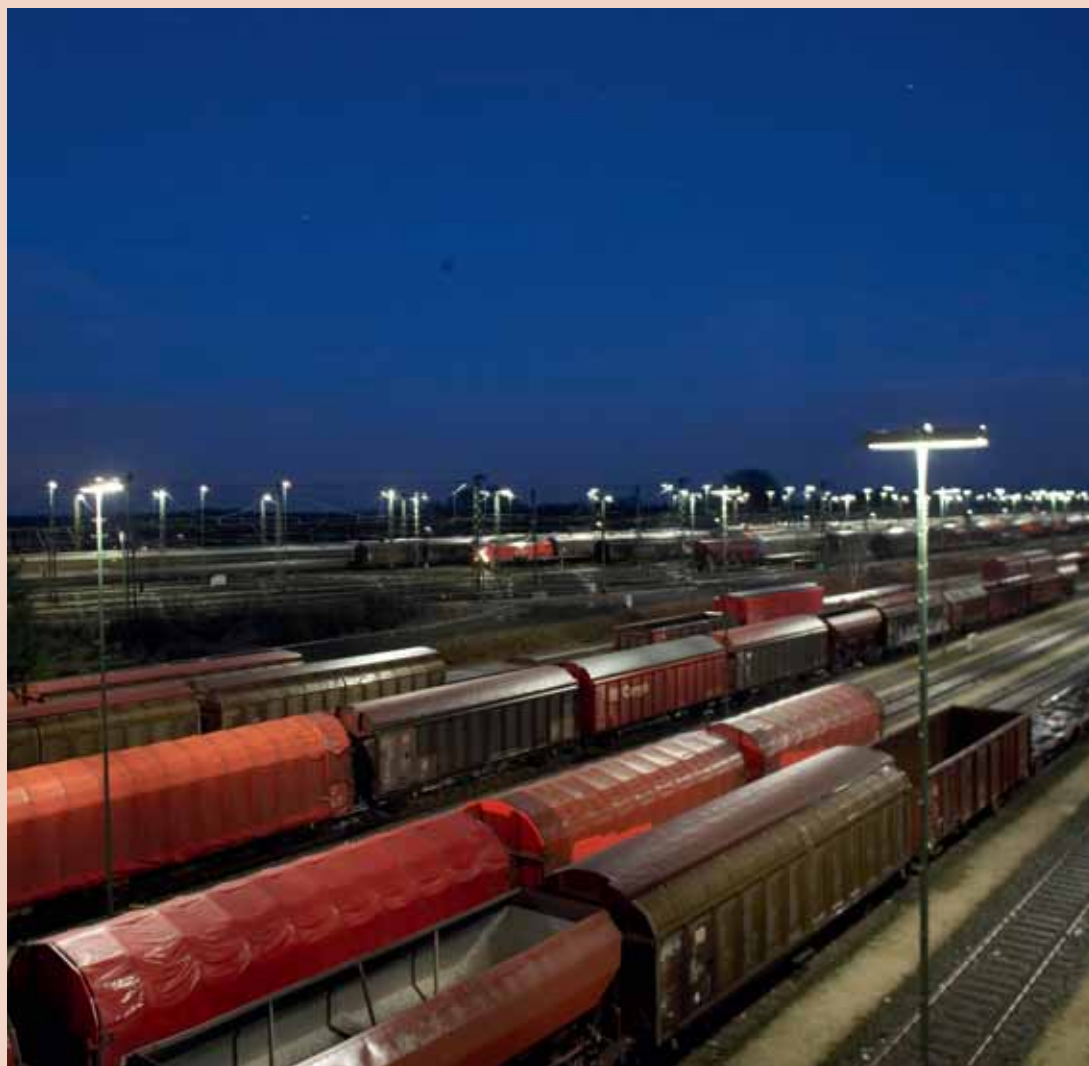

F: + 49 6131 1565975  
E: info@dbschenker.eu  
W: www.dbschenker.de/

##### INFORM GmbH

Pascalstr. 23  
Aachen  
52076  
Germany  
Contact: Mr Udo Niessen  
T: + 49 2408 9456 44  
F: + 49 2408 9456 45  
E: info@inform-software.com

#### INDIA

##### Subarnarekha Port Private Ltd

New No.84, Old No.50  
"Dakshin", 1st Ave, Indranagar  
Adyar  
Chennai  
600020  
India  
Contact: Mr Ramani Ramaswamy  
T: + 914424431900  
F: + 914442607368 - Ext 18  
E: subarnarekha.port@gmail.com  
W: www.creativeports.com

#### MEXICO

##### Servicios Especiales Portuarios

S.A. de C.V.  
Bustamante 173-1  
Fracc Los Pinos  
Veracruz  
C.P. 91870

Mexico  
Contact: Mr Andrew Gillespie  
T: + 52 229 934 3718  
F: + 52 229 178 2329  
E: direccion@sepsaver.com  
W: www.sepsaver.com  
One scale for rail and one scale for trucks into our facility. 4.5 Ha for mineral break bulk cargo stowage.

#### SOUTH

#### AFRICA

##### Transnet Freight Rail

Head Office  
Inyanda House  
13 Girtton Road  
Parktown  
Johannesburg  
Gauteng province  
2193  
South Africa  
Contact: Mr Siyabonga Gama  
T: + 27 11 584 0509/10  
F: + 27 11 774 9978  
E: siyabonga.gama@transnet.net  
W: www.spoornet.co.za

#### THE NETHERLANDS

##### Keyrail

Develsingel 11  
Zwijndrecht

3333 LD  
The Netherlands  
Contact: Mrs Ezra Drost  
T: + 31 78 6777530  
E: e.drost@keyrail.nl

##### Oxbow Coal B.V.

P.O. Box 51060  
Rotterdam  
3007 GB  
The Netherlands  
Contact: Mr Ewoud Colenbrander  
T: +31104419200  
F: +31104360692  
E: Ewoud.Colenbrander@oxbow.com  
W: www.oxbow.com

##### Veolia Cargo Nederland

Albert Plesmanweg 101 c  
Waalhaven  
Rotterdam  
NL - 3088 GC  
The Netherlands  
Contact: Mr Allan Gibson  
T: + 31 10707 0500  
W: www.veoliacargo.com

#### UK

##### DB Schenker

Lakeside Business Park  
Carolina Way  
Doncaster  
South Yorkshire  
DN4 5PN  
UK  
Contact: Mr Graham Meiklejohn  
T: +44 8701405000

E: graham.meiklejohn@dbschenker.com

##### Don Valley Engineering Co Ltd

Sandall Stones Road  
Doncaster  
DN3 1QR  
UK  
Contact: Mr Roger Allen  
T: + 44 1302 881188  
F: + 44 1302 881000  
E: sales@donvalleyeng.com  
W: www.donvalleyeng.com

##### Freightliner Heavy Haul

3rd Floor  
The Podium  
1 Eversholt Street  
London  
NW1 2FL  
UK  
Contact: Ms Monica Callus  
T: + 44 207 2003900  
F: + 44 207 2003975  
E: callusm@freightliner.co.uk  
W: www.freightliner.co.uk  
Heavy Haul is a leading player in the coal, aggregates and cement sectors. Also operating trains in the waste, petroleum and minerals markets, the company has carried out infrastructure work for Network Rail since its inception in 1999.

##### Freightliner Heavy Haul

Aire Valley Depot  
Stranglands Lane  
Ferrybridge  
West Yorks



WF11 8RA  
UK  
Contact: Mr Martin Wilks  
T: + 44 1977 466805  
F: + 44 1977 466804  
E: wilksm@freightliner.co.uk  
W: www.freightliner.co.uk  
Freightliner Heavy Haul operates bespoke rail haulage services in the coal, aggregates, cement, waste and minerals markets, establishing an unparalleled reputation for service reliability.

#### GB Railfreight (FirstGBRf)

15-25 Artillery Lane  
London  
E1 7HA  
UK  
Contact: Mr Ashley Stower  
T: + 44 20 7904 3393  
F: + 44 20 7983 5170  
E: gbrfinfo@gbraillfreight.com  
W: www.gbraillfreight.com  
GB Railfreight is the United Kingdom's newest freight train operator. The company was created following research that identified the need for further competition in the railfreight market.

#### VTG Rail UK Ltd.

Sir Stanley Clarke House  
7 Ridgeway  
Quinton Business Park  
Birmingham  
B32 1AF  
UK  
Contact: Mr Ian Shaw  
T: + 44 121 421 9180  
F: + 44 121 421 9184  
E: ian.shaw@vtg.com  
W: www.vtg.com

## USA

#### BULK-FLOW

9503 Willowlake Dr  
Houston  
TX  
77064  
USA  
Contact: Mr Pablo Llopez  
T: + 1 713 589 4580  
E: pllopez@bulk-flow.com  
W: www.bulk-flow.com/

#### Burlington Northern Railroad

3701 East Itasca Street  
Superior  
Wisconsin  
54880  
USA  
Contact: Mr Roxanne Butler  
T: + 1 817-867-6671  
F: + 1 817-352-7925  
E: Roxanne.Butler@bnsf.com

#### CN Railway

17641 S. Ashland Avenue  
Homewood  
Illinois  
60430  
USA  
Contact: Mr Tommy Browning  
T: + 1 708 332 3803  
F: + 1 708 332 3673  
E: tommy.browning@cn.ca  
W: www.cn.ca

#### CSX Transportation

CSX- Chesapeake Bay Piers  
1910 Benhill Avenue  
Baltimore  
Maryland  
21226  
USA  
Contact: Mr Craig Blinke  
T: + 1 410 355 6302  
F: + 1 410 355 2088

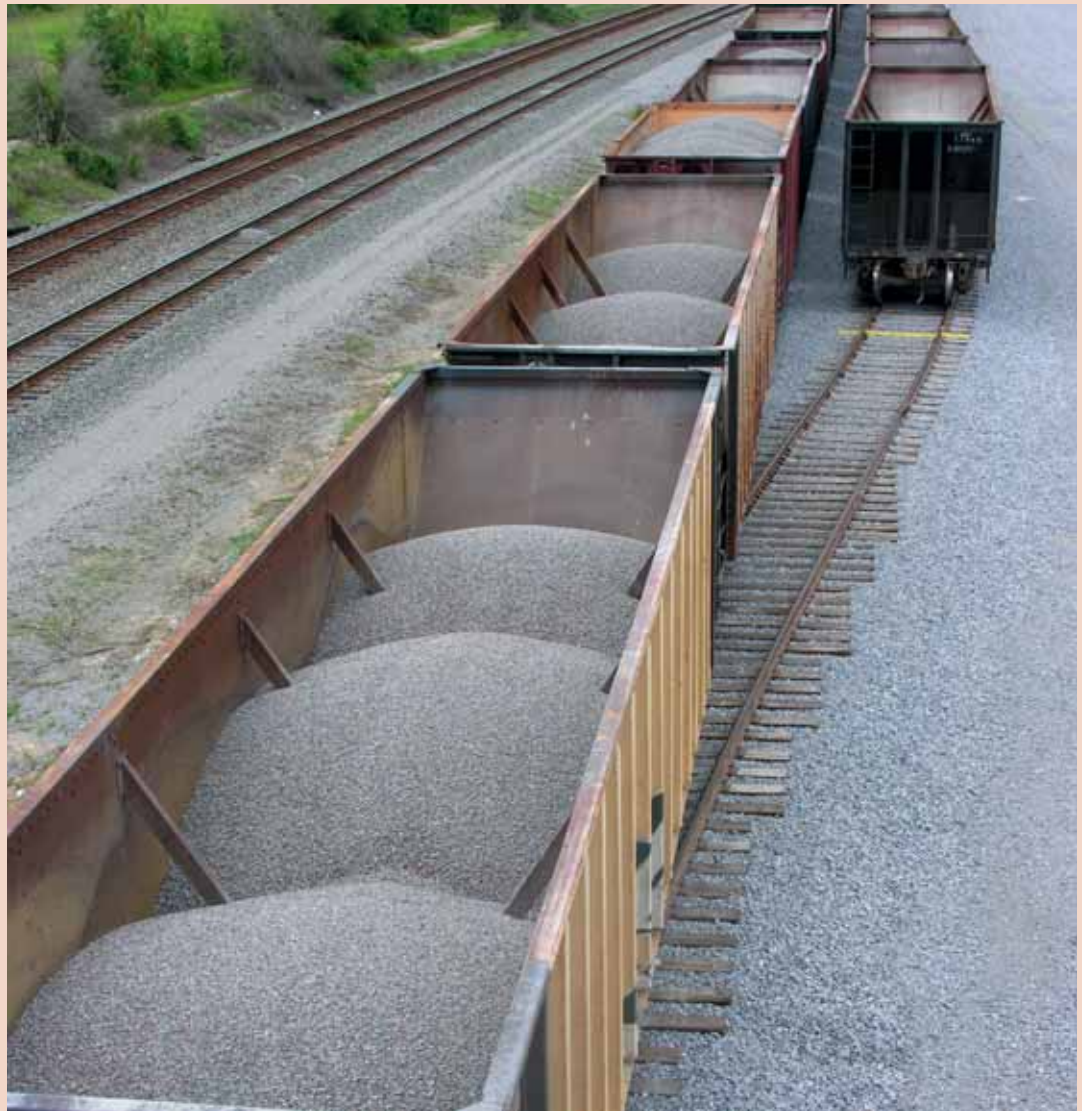

E: Craig\_Blinke@csx.com

#### Duraport Marine & Rail Terminal, LLC

PO Box 1009  
Bayonne  
New Jersey  
07002  
USA  
Contact: Mr Vincent Alessi  
T: + 1 201 437 0703  
F: + 1 201 437 0158  
E: vincealessi@aol.com

#### Ecofab Maintenance USA Inc.

1645 Lonsdale Avenue  
North Vancouver  
B.C.  
V7M 2J5  
USA  
Contact: Mr Doug Bock  
T: + 1 604 903 2000  
F: + 1 604 903 2025  
E: dbock@ecofab.com

#### Electro-Motive Diesel (EMD) Inc

9301 West 55th Street  
La Grange  
IL  
60525  
USA  
Contact: Mr Scott Garmin  
T: + 1 708 387 3938  
F: + 1 708 387 6626  
E: frank.w.ward@EMDiesels.com  
W: www.EMDiesels.com

#### Kansas City Southern

427 West 12th Street  
Kansas City  
MI  
64105  
USA  
Contact: Mr Rich Weigel  
T: + 1 816-983-1303  
F: + 1 800-243-8624  
E: rweigel@kcsouthern.com  
W: www.kcsi.com

#### Kinder Morgan Terminals

3500 N. Causeway Blvd  
Suite 210  
Metairie  
LA  
70002  
USA  
Contact: Mr John Vaughn  
T: + 1 504 620 4639  
F: + 1 504 620 4698  
E: john\_vaughn@kindermorgan.com

#### Lakes Logistics LLC

15361 Highland Place  
Minnetonka  
Minnesota  
55345  
USA  
Contact: Mr Don Divine  
T: 1-612-850-4484  
E: don@lakeslogistics.com  
W: www.LakesLogistics.com

#### Norfolk Southern Coal Business Group

110 Franklin Road  
S.E., Roanoke  
VA  
24042-0026  
USA  
Contact: Mr Daniel D Smith  
T: + 1 757 629 2813  
E: Danny.Smith@nscorp.com

#### Port of New Orleans

1350 Port of New Orleans Place  
New Orleans  
LA  
70130  
USA  
Contact: Ms Janine Mansour  
T: + 1 504 528 3533  
E: info@portno.com  
W: www.portno.com

#### Savage

Old River Operations  
16800 Greenspoint Park Drive  
Suite 120N  
Houston  
Texas  
77060  
USA  
Contact: Mr Joshua Knichel  
T: + 1 281 673 1098  
F: + 1 281 673 1086  
E: Joshknichel@savageservices.com  
W: www.savageservices.com/

#### TBS Shipping Services

612 Grassy Sprain  
Yonkers  
New York  
10710  
USA  
Contact: Mr Gregg McNelis  
T: + 1 914 961 1000  
F: + 1 914 961 2286  
E: TBSRates@nyc.tbsship.com  
W: www.tbssgroup.com/

#### Union Pacific Railroad Co

1416 Dodle Street  
Dodge room 400  
Omaha  
NE  
68179  
USA  
Contact: Mr Mark Davis  
T: + 1 402 5445459  
F: + 1 402501 0011  
E: mwDavis@up.com

#### Utah Railway Corporation

4692 North 300 West  
Suite 220  
Provo  
Utah  
UT 84604  
USA  
Contact: Mr James M Davis  
T: +1 801 221 7460  
F: +1 801 221 7462  
E: jdavis@gwrr.com  
W: www.gwrr.com



## CONVERSION LINE ad\*starKON SX+

The new generation high-speed valve bottomer!



Performance excellence achieved through outstanding production speed combined with well-proven efficiency and unmatched flexibility, giving converters a technological head start in block bottom sack conversion.



Starlinger Head Office:  
Sonnenuhrgasse 4, 1060 Vienna, Austria  
T: + 43 1 59955, F: -25, office@starlinger.com,  
www.starlinger.com  
A member of Starlinger Group





# FIBC & BAG MANUFACTURING COMPANIES

## AUSTRALIA

### Bulk Handling Australia Pty Ltd

45 Centre Way  
Croydon South  
Victoria  
3136  
Australia  
Contact: Mr Paul Gonzales  
Job Title: Products Manager IBC's  
T: + 61 3 9761 4433  
F: + 61 3 9761 4558  
E: pgonzales@bha.com.au  
W: www.bha.com.au

## AUSTRIA

### Mondi Industrial Bags GmbH

Kelsenstrasse 7  
Vienna  
A-1030  
Austria  
Contact: Ms Christina Fadler  
Job Title: Marketing  
Communications Manager  
T: + 43 1 79013 4917  
F: + 43 1 79013 964  
E: info.bags@mondigroup.com  
W: www.mondigroup.com/  
Mondi Industrial Bags offers the full range of industrial paper bags. With 36 operations in 28 countries we can serve our clients in the cement & building materials, chemicals, food & feed & seed industries wherever they need us

### Starlinger & Co. GmbH

Sonnenuhrgasse 4  
Vienna  
A-1060  
Austria  
Contact: Mr Alfred Rußwurm  
Job Title: Marketing Manager  
T: + 43 1 599 55 0  
F: + 43 1 599 55 180  
E: office@starlinger.com  
W: www.starlinger.com  
Starlinger is the world's leading producer of machinery for woven plastic sack production (coated or uncoated sacks, Leno, valve sacks, AD\*STAR® block bottom valve sacks and FIBCs). The product range also includes plastics recycling machines, PET bottle r

## BELGIUM

### Bekintex NV

Industriepark Kwatrecht -  
Neerhonderd 16  
Wetteren  
9230  
Belgium  
Contact: Ms Ilse Veldeman  
Job Title: Marketing Assisant  
T: + 32 9 365 7111  
F: + 32 9 365 7117  
E: ilse.veldeman@bekaert.com  
W: www.bekaert.com

## BRAZIL

### NEO CORP BRASIL

Avenida Bento Munhoz da Rocha Neto, N°: 1777  
Jardim Samambaia  
Paranaguá-PR  
83212-000  
Brazil  
Contact: Mr Christopher Paolo  
Job Title:  
T: + 55 41 3122 5771  
E: christopher@neocorpbr.com.br  
W: http://neocorpbr.com.br

## BULGARIA

### Assenova Krepost

2 Ivan Vazov Str  
Blagoevgrad  
4230  
Bulgaria  
Contact: Mrs Armaudo  
Job Title:  
T: + 359 331 223 95  
F: + 359 331 263 75  
E: admin@ceebd.co.uk

## CANADA

### Syn-Tex Bag

211 Hutchings Street  
Winnipeg  
Manitoba  
R2X 2R4  
Canada  
Contact: Mr Garry Smith  
Job Title: General Manager  
T: + 1 204 632 5667 ext. 213  
F: + 1 204 633 4125  
E: gsmith@syntexbag.com  
W: www.syntexbag.com

## CHINA

### Changzhou Quick Way FIBC Ltd

Flat C, 12/F.  
18 Cao Xi Bei Road  
Shanghai  
200030  
China  
Contact: Mr Kim Bi  
Job Title: Sales Manager  
T: + 86 21 5489 2602  
E: sale@czquickway.com  
W: www.czquickway.com

## CZECH

## REPUBLIC

### LANEX Packaging s.r.o.

Hlucinska 93  
Bolatice  
747 23  
Czech Republic  
Contact: Mr Martin Postuka  
Job Title: Sales Manager  
T: + 420 553 751 325  
F: + 420 724 654 151  
E: martin.postulka@lanex.cz  
W: www.lanex.cz  
Production, development and sale



of flexible containers designed for packaging, handling and transport of particularly bulk and free-flowing products. Efforts on specialization, alcove markets, flexibility, prompt deliveries to measure, in due time and t

## DENMARK

### Anders Bendt A/S

Dalagarde  
Aarhus C  
DK 8000  
Denmark  
Contact: Mrs Tine Bendt  
Job Title: Managing Director  
T: + 45 86 19 0500  
F: + 45 86 19 0577  
E: dry-bag@desiccant.com  
W: www.desiccant.com

## GERMANY

### EFIBCA

Kaiser-Friedrich-Promenade 43  
Bad Homburg  
61348  
Germany  
Contact: Ms Kerstin Meggert  
Job Title: FIBCA Secretariat  
T: + 49 61 7292 6665  
F: + 49 61 7292 6670  
E: k.meggert@kunststoffverpackungen.de  
W: www.efibca.com  
European Association of FIBC manufacturers, distributors and suppliers to the manufacturers.

### EMDE INDUSTRIE-TECHNIK

PO Box 1339 Koppelheck  
Nassau-Lahn  
56377  
Germany  
Contact: Mr Hansjürg Emde  
Job Title: Managing Director  
T: + 49 2604 97030  
F: + 49 2604 970333  
E: info@emde.de  
W: www.emde.de

### GREIF-VELOX

Kronsfordter Landstraße 177  
Lübeck  
D-23560  
Germany  
Contact: Mr Poppe  
Job Title:

T: + 49 451 530 30  
F: + 49 451 530 233  
E: logdos@logdos.de  
W: www.greif-velox.de

### PEMA Verpackung

Carl Zeiss Strasse 10  
Syke  
28857  
Germany  
Contact: Mr Raake  
Job Title:  
T: + 49 42 42 53 93 0  
F: + 49 42 42 53 93 0  
E: raake@pema-verpackung.de

### Schleswiger Tauwerfwerkfabrik

Oellerking GmbH & Co KG  
Margarethenwallstr. 7  
Schleswig  
D-24837  
Germany  
Contact: Mr Johannes Jensen  
Job Title: Sales Manager  
T: + 49 4621 3809 40  
F: + 49 4621 3809 99  
E: j.jensen@oellerking.com  
W: http://www.oellerking.com  
Liner bags, thermo liner and Sweatkings for standard container.

## INDIA

### Taurian Exim Pvt. Ltd

199 / 201 Gold Coin Bldg  
2nd Floor Sheikh Memon Street  
Zhaveri Bazaar  
Mumbai  
Maharashtra  
400 002  
India  
Contact: Mr Sachin Bajja  
Job Title: Managing Director  
T: + 91 22 234 53430  
F: + 91 22 234 53589  
E: taurian@vsnl.com

## IRELAND

### Synthetic Packaging

Clara  
County Offaly  
Ireland  
Contact: Mr Aiden Devery  
Job Title: Managing Director  
T: + 353 579 331 282  
F: + 353 579 331 224  
E: aiden.devery@syntheticpackaging.com

W: www.syntheticpackaging.com

## ITALY

### FEMADIGIPACK s.r.l

Via Romano, 9  
Cortenuova  
Bergamo  
24050  
Italy  
Contact: Mr Marco Belotti  
Job Title: Project Engineer  
T: + 39 0363 911 396  
F: + 39 0363 902 466  
E: info@femadigipack.it  
W: www.femagroup.net

### Sa Te In

Castell'Arquato (PC) 29014  
Strada Castellana  
KM 7  
Italy  
Contact: Mr Giuseppe Massouda  
Job Title: Sales Director  
T: + 39 0525 804133  
F: +39 0523 804338  
E: giuseppe.massouda@italitex.com  
W: www.satein.com

### Saccheria F.Lli Franceschetti

Spa  
Via Stazione Vecchia 80  
Provaglio d'Iseo  
Brescia  
25050  
Italy  
Contact: Mr Maurizio Bonardi  
Job Title: Commercial Dept  
T: + 39 030 982 3841  
F: + 39 030 983 9039  
E: comag@saccheriafranceschetti.it  
W: www.saccheriafranceschetti.it

## JAPAN

### Taiyo Kogyo Corporation

2-33-16 Ikejiri  
Setagaya-ku  
Tokyo  
154-0001  
Japan  
Contact: Mr Daiki Shirai  
Job Title: Assistant Manager  
T: + 81 3 3714 3311  
F: + 81 3 3791 5558  
E: sd003275@mb.taiyokogyo.co.jp  
W: www.taiyokogyo.com/taicon  
Taiyo Kogyo offers a wide variety of FIBCs ranging from single/multi-rip

# dry bulk EUROPE 2014

## Exhibition & Conference

**21-23 September 2014**  
**Passenger Terminal Amsterdam,**  
**Amsterdam, The Netherlands**

A global meeting place for shipowners, operators, charterers, agents, exporters, importers, traders, ports, terminals, logistics providers and bulk materials handling suppliers.



**Dry Bulk Europe 2014 is the premier event for your industry and your opportunity to:**

1. Meet delegates, exhibitors, sponsors and speakers from the global dry bulk market
2. Discover the latest bulk handling products, innovations and solutions
3. Listen to expert views from shippers, logistics providers, industry consultants, ports and terminals
4. Present your products and services through sponsorship and exhibiting

**FREE ATTENDANCE**

To maximize the value of the event for all attendees, attendance to the event is entirely free of charge.

**[www.drycargoevents.com](http://www.drycargoevents.com)**



PP woven FIBCs to repairable heavy-duty FIBCs made of PVC and other tarpaulins.

**LUXEMBOURG**

**SOLEM S.A.**

13, Fausermillen  
Mertert  
6689  
Luxembourg  
Contact: Mr Bernd Beeking  
Job Title: General Manager  
T: + 352 75 07 91 25  
F: + 352 74 96 46  
E: bernd.beeking@solem.lu  
W: www.solem.lu  
Single use and reusable containers manufactured to specification for individual requirements with various top and bottom shapes, filling and discharging devices and variety of closures. Safety factor (SF): 5 (disposable) or 6 (reusable); safe working loa

**NEW**

**ZEALAND**

**Donaghys**

16 Sheffield Crescent  
Harewood  
Christchurch  
New Zealand  
Contact: Mr H N F Ross  
Job Title:  
T: + 64 3 983 4100  
F: + 64 3 983 4191  
E: enquiries@donaghys.co.nz  
W: www.donaghys.com/

**NORWAY**

**Goodtech Solutions AS**

Bjoernsletteveien 2  
Porsgrunn  
N-3917  
Norway  
Contact: Mr Knut Halvorsen  
Job Title: Group Commercial Manager  
T: + 47 35 93 05 50  
F: + 47 35 93 05 60  
E: knut.halvorsen@goodtech.no  
W: www.portabulk.com or www.goodtech.no  
Based on PORTABULK® technology and in close cooperation with its international marketing and manufacturing network, Goodtech Solutions delivers superior, cost-effective materials handling technology, products, systems and services in selected markets.

**PORTUGAL**

**Cotesi SA**

Av. Mosteiro, 486  
Grijó  
4415-493  
Portugal  
Contact: Mr Ricardo Soares  
Job Title:  
T: + 351 227 476 500  
F: + 351 227 646 575  
E: ricardo.soares@cotesi.com  
W: www.cotesi.com  
Manufacturer of Big Bags, small bags and PP woven fabrics since 1967. Production facilities in Europe and Asia. Logistic and sales network covering all over continental Europe and the UK.

**RUSSIA**

**Nekrasovsky**

Dmitrov District  
Moscow Region  
141760  
Russia  
Contact:  
Job Title:  
T: + 7095 578 6452  
F: + 7095 578 4698

**Plastcon**

Neftyanaya doroga, 1 A  
St Petersburg  
193060  
Russia  
Contact: Ms Anna Starikova  
Job Title:  
T: + 7 812 766 5905  
F: + 7 812 766 0370  
E: starikova@plastcon.ru

**SINGAPORE**

**Interbulk Enterprise**

12 Mariam Walk  
Singapore  
507172  
Singapore  
Contact: Mr Michael Lian Soon  
Leong  
Job Title:  
T: + 65 654 66335 / 4688  
F: + 65 654 50985  
E: liancom@singnet.com.sg

**Ssangleong Bulkhandling Pte Ltd**

72 Tuas South Street 5  
Singapore  
637807  
Singapore  
Contact: Mr Soon Beng Lien  
Job Title: Managing Director  
T: + 65 6265 7377  
F: + 65 6264 7377  
E: veron.lien@ssangleong.com  
W: www.ssangleong.com  
Since 1981, Ssangleong has evolved from a small Bulk Bag trading firm to a full-fledged company, manufacturing and exporting a wide range of industrial packaging products. Bulk Bags, PP Woven Bags, Flexibags, IBC Tanks, rework and repacking are some of

**SOUTH**

**AFRICA**

**Industrial Netting (Pty) Ltd**

PO Box 39624  
Bramley  
Gauteng  
2018  
South Africa  
Contact: Mr Ian Campbell  
Job Title: Managing Director  
T: + 27 11 6084686  
F: + 27 11 6084690  
E: info@industrialnetting.co.za  
W: www.industrialnetting.co.za

**Tufbag**

PO Box 155  
Mandini  
KwaZulu Natal  
4490  
South Africa  
Contact: Mr Russell Timmas  
Job Title: National Sales Manager  
T: + 27 32 459 5050  
F: + 27 32 459 2581  
E: russell.timmas@tufbag.com  
W: http://tufbag.com

Manufacturers of: Flexible Intermediate Bulk Containers (FIBC), Heavy duty/limited trip and single trip (Bulk bags). •Woven •Woven polypropylene sacks and bags both laminated and unlaminated all of which can be fitted with normal or shaped liners with

**SPAIN**

**Beniplast/Benitex**

Avda Vicente Boluda Polop  
S/N 46830  
Beniganim  
Valencia  
46830  
Spain  
Contact: Mr Vicente Cuquerella  
Job Title: Managing Director  
T: + 34 96 391 6906  
F: + 34 96 392 1638  
E: valencia.btx@benitex.com  
W: www.benitex.com

**Clime SA**

c/ Castilla 52-54  
Barcelona  
08018  
Spain  
Contact: Mr John Climent  
Job Title:  
T: + 34 93 307 6362  
F: + 34 93 308 5649  
E: climesa@fibcnet.com  
W: www.fibcnet.com

**Condepols S.A.**

Avda. Iberoamérica, 35  
Alcalá La Real  
Jaén  
23680  
Spain  
Contact: Mr Ignacio Baillo  
Job Title: Commercial Director  
T: + 34 91 337 7048 / +34 953 59 81 00  
E: ignacio.i.baillo@derprosa.com  
W: www.condepols.es

**Industrias Murtra**

Jordi Camp 94  
Apartado 278  
Granollers  
Barcelona  
08403  
Spain  
Contact: Mr Xhabby Franco  
Job Title: Sales Manager  
T: + 34 93 846 7200  
F: + 34 93 846 5956  
E: murtra@murtra.com  
W: www.murtra.com

**Propitex SA**

Poligono Industrial s/n  
Aoiz  
Navarra  
31430  
Spain  
Contact: Mrs Monica Fuentes  
Job Title: Commercial Manager  
T: + 34 948 334 115  
F: + 34 948 334 116  
E: commercial@propitex.com  
W: www.propitex.com

**Rodenas & Rivera S.A.**

PO Box 252  
Albacete  
02080  
Spain  
Contact: Ms Maria Galan  
Job Title: Marketing  
T: + 34 967510270  
F: + 34 967511098  
E: rodenasyrivera@rodenasrivera.com  
W: www.rodenasrivera.com

**SWEDEN**

**Bergu International AB**

Nygata 30  
Box 5006  
Helsingborg  
S-250 05  
Sweden  
Contact: Mr Conny Simonsson  
Job Title:  
T: + 46 42 12 7970  
F: + 46 42 12 8002  
E: bergu@telia.com  
W: www.bergu.com  
Designs, manufactures, assembles and develops products for pneumatic conveying and bag emptying in order to meet the requirements of todays market.

**THE**

**NETHERLANDS**

**Chronos BTH B V**

Meerheide 40  
Eersel  
5521 DZ  
The Netherlands  
Contact: Mr Ingo Jonas  
Job Title: Managing Director  
T: + 31 497 51 49 88  
F: + 31 497 51 49 53  
E: info@chronosbth.com  
W: www.chronosbth.com

**Greif Flexibles Benelux B.V.**

Jupiterweg 1  
Harbournumber M-389  
Moerdijk  
4761 RW  
The Netherlands  
Contact: Mr Peter Natelar  
Job Title:  
T: + 31 168 35 99 99  
F: + 31 168 35 99 88  
E: Flexibles.benelux@greif.com  
W: www.greif.com  
Greif's Flexible Products & Services business provides FIBCs, shipping sacks, container liners and other flexible industrial packaging for chemicals, pharmaceuticals, foodstuffs and many other sectors. We also offer a full portfolio of geotextiles, agricu

**Interbulk BV**

Nieuwe Haven 125  
Zierikzee  
4301 DL  
The Netherlands  
Contact:  
Job Title:  
T: + 31 111 45 1100  
F: + 31 111 45 1010  
E: info@interbulk.nl  
W: www.interbulk.nl

**Interjute BV**

PO Box 154  
Hulst  
4560 AD  
The Netherlands  
Contact: Mr Ed Wessels  
Job Title: International Sales Manager  
T: + 31 114 311208  
F: + 31 114 311512  
E: ewessels@interjute.nl  
W: www.interjute.com  
INTERJUTE is one of Europe's major suppliers of polypropylene sacks and big bags for the packaging of fertilizer, chemicals, animal feed, malt, flour, sugar and many other products.

**Jansen & Heuning**

Bulk Handling Systems  
Duinkerkenstraat 11  
Groningen  
9723 BN  
The Netherlands  
Contact:  
Job Title:  
T: + 31 50 312 64 48  
F: + 31 50 313 80 18  
E: sales@jh.nl  
W: www.jh.nl

**Lankhorst Indutech BV**

Prinsengracht 2  
Sneek  
8607 AD  
The Netherlands  
Contact: Mr W Stroed  
Job Title: Managing Director  
T: + 31 515 487 654  
F: + 31 515 422 681  
E: info@lankhorst-touwfabrieken.nl  
W: www.lankhorst-indutech.nl

**LC Packaging International**

Hoogeveenweg 150  
Nieuwerkerk a/d IJssel  
2913 LV  
The Netherlands  
Contact: Mr Krijn Degenkamp  
Job Title: Marketing Manager  
T: + 31 180 39 38 17  
F: + 31 618 52 99 81  
E: Info@lcpackaging.com  
W: www.lcpackaging.com  
LC Packaging is a family business that has been active in the packaging industry for four generations. It all started in the jute bag business in 1923, since then LC Packaging has expanded its services considerably, evolving from a packaging and packaging

**Zakkencentrale B.V.**

3100 AJ Schiedam  
Cairostraat 50  
Rotterdam  
3047 BC  
The Netherlands  
Contact: Mr Harm Peters  
Job Title: Managing Director  
T: + 31 10 462 3511  
F: + 31 10 462 6939  
E: exim@zakkencentrale.nl  
W: www.zakkencentrale.nl

**TURKEY**

**Avplast Dis Tic. Ve Paz. Ltd. Sti.**

Egitim Mah. Kasap Ismail Sok.  
Avrasya Is Merkezi No: 14 Kat: 1 D:  
24-  
34722 Hasanpasa / Kadikoy  
Istanbul  
81080  
Turkey  
Contact: Mr Hakan Avci  
Job Title:  
T: + 90 216 338 32 31 - 347 38 54  
F: + 90 216 348 88 95  
E: sales@avplast.com.tr  
W: www.avplast.com.tr

**Cesur Packaging Corporation**

Yakacak Yanyol  
Senem Sokak No: 11  
Kartal  
Istanbul  
34876  
Turkey  
Contact: Mr Cihan Cesur  
Job Title: Sales & Marketing Director  
T: + 90 216 377 28 55  
F: + 90 216 377 11 90  
E: info@cesur.com  
W: www.cesur.com

## Greif Flexibles Turkey

Fabrika Sokak No.2/8  
Samandira  
Istanbul  
34885  
Turkey  
Contact: Mr Can Sezer  
Job Title: Business Development  
Director, EMEA  
T: + 90 216 564 0600  
F: + 90 216 311 5013  
E: mail@unsa-tr.com  
W: www.unsa-tr.com

## Gulsan A.p.

Organize Sanayi Bolgesi 2 Cad.  
No: 18  
Gaziantep  
27180  
Turkey  
Contact: Ms Gulden Saka  
Job Title: Marketing Manager  
T: + 90 342 337 1180  
F: + 90 342 337 2528  
E: info@gulsan-group.com  
W: www.gulsan-group.com

## Isbir Sentetik Dokuma San .A.S.

Izmir Yolu  
Cayirhisar Mevkii  
Balikesir  
10034  
Turkey  
Contact: Mr Tanin Guven  
Job Title: Marketing  
Manager/Sales Director  
T: + 90 266 283 0000  
F: + 90 266 283 0001  
E: taninguven@isbirsentetik.com  
W: www.isbirsentetik.com  
One of the world's largest  
manufacturers of Big Bags (FIBCs)  
, PP woven bags, container liners ,  
geosynthetics and FIBC  
components , with a global sales  
network.

## Tetsa A.S.

Koseilyas Yoyu Yolu 2. km  
Degirmenali Mevkii  
Tekirdag  
59000  
Turkey  
Contact: Mr Ekrem Edip  
Job Title:  
T: + 90 282 293 2222  
F: + 90 282 293 2228  
E: bilg@tetsa.com.tr  
W: www.tetsa.com.tr

## UK

## Bulkbag Containers Ltd

Old Glamis Factory  
Old Glamis Road  
Dundee  
DD3 8JB  
UK  
Contact: Mr Hamish Milne  
Job Title: Director  
T: + 44 1382 823824  
F: + 44 1382 823825  
E: sales@bulkbag.co.uk  
W: www.bulkbag.co.uk  
We are heavy industrial sewing  
specialists who have over 20 years  
experience in the manufacture and  
development of Flexible  
Intermediate Bulk Containers  
(FIBCs). We can supply whatever  
size and style of bag you require.

## David Osborne Engineering Ltd

Nene House, Drayton Way  
Drayton Fields  
Daventry  
Northamptonshire  
NN11 8EA  
UK  
Contact: Mr David Osborne

Job Title:  
T: + 44 1327 301199  
F: + 44 1327 300681  
E: david@doeng.co.uk  
W: www.doengineering.co.uk

## Flexicon Europe Ltd

182 John Wilson Business Park  
Harvey Drive  
Whitstable  
Kent  
CT5 3RB  
UK  
Contact:  
Job Title:  
T: + 441227 374710  
E: sales@flexicon.co.uk  
W: www.flexicon.co.uk

## Industrial Bulk Containers

Newton Business Park  
Talbot Road  
Hyde  
Cheshire  
SK14 4UQ  
UK  
Contact: Ms Judith Kelly  
Job Title:  
T: + 44 161 367 8695  
F: + 44 161 367 8685  
E: industrialbulkcontainers@  
btconnect.com

## Miller Weblift Ltd

Marling Mills  
Nelson Street  
Leek  
Staffordshire  
ST13 6BB  
UK  
Contact: Mr Andrew Clement  
Job Title: General Manager  
T: + 44 1538 384108  
F: + 44 1538 387350  
E: sales@millerweblift.com  
W: www.millerweblift.com

## Mulox Ltd

Unit 2, High Carr Business Park  
Off Millennium Way  
Newcastle  
Stoke-on-Trent  
Staffordshire  
ST5 7XE  
UK  
Contact: Mr Andrew Reardon  
Job Title: Operations Director  
T: + 44 1782 565 659  
F: + 44 1782 562 252  
E: andrew.reardon@mulox.co.uk  
W: www.mulox.com  
Manufacturer of FIBCs mainly for  
the pharmaceutical, chemical and  
food industries. Specialists in high  
containment systems

## Structure-Flex Ltd

Peacock Way  
Melton Constable  
Norfolk  
NR24 2A3  
UK  
Contact: Mr Paul Reeve  
Job Title:  
T: + 44 1263 863124  
F: + 44 1263 863110  
E: sales@structure-flex.co.uk  
W: www.structure-flex.co.uk

## USA

## B. A. G. Corp.

11510 Data Drive  
Dallas  
Texas  
75218  
USA  
Contact: Mr Matthew Simons  
Job Title: Marketing Director  
T: + 1 214 340 7060 ext 832

F: + 1 214 340 7060  
E: matt@bagcorp.com  
W: www.bagcorp.com

## Bulk Lift International

1013 Tamarac Drive  
Carpentersville  
IL  
60110  
USA  
Contact: Mr Brian Kelly  
Job Title: National Sales Manager  
T: + 1 847 428 6059 x 215  
F: + 1 847 428 7180  
E: brian@bulklift.com  
W: www.bulklift.com

## Bulk Sak International, Inc

103 Industrial Drive  
Malvern  
Arkansas  
72104  
USA  
Contact: Mr Grant Patterson  
Job Title: President  
T: + 1 501 332 8745  
F: + 1 501 332 8438  
E: gpatterson@bulksak.com  
W: www.bulksak.com  
Full Scale FIBC Manufacture in the  
US and China. U Paneled,  
Circular, Baffled, UN, Type D and  
Type C available. Specializing in  
Food and Pharma Grade Bags.

## BULK-FLOW

9503 Willowlake Dr  
Houston  
TX  
77064  
USA  
Contact: Mr Pablo Llopez  
Job Title: Vice President  
T: + 1 713 589 4580  
E: plopez@bulk-flow.com  
W: www.bulk-flow.com/

## CorrPak Bulk Packaging Systems, LLC

506 North 31st Street  
Suite 4  
Monroe  
LA  
71201  
USA  
Contact: Mr Andy Mintz  
Job Title: President  
T: + 1 318 699 0108  
F: + 1 318 699 0501  
E: amintz@corrpkbps.com  
W: www.corrpkbps.com  
Specialists in intermodal sea bulk  
container liners for dry or flowing  
bulk products. With over 30 years  
experience in the manufacturing of  
industrial packaging products, we  
offer bulk bags (FIBC'S) and  
Woven PP Bags!!!!

## FlexCon & Systems

50 Market Street  
#1A, Suite 331  
South Portland  
Maine 04106  
Lafayette  
LA  
70506  
USA  
Contact: Mr Steve Herd  
Job Title: Manager  
T: + 1 207 767 5387  
E: info@flexcon.com  
W: www.flex-con.com

## Flexicon Corporation

2400 Emrick Blvd  
Bethlehem  
PA  
18020-8006  
USA



Contact:  
Job Title:  
T: + 1 610 814 2400  
F: + 1 610 814 0600  
E: sales@flexicon.com  
W: http://www.flexicon.co.uk/

## Intertape Polymer

3647 Cortez Road West  
Bradenton  
FL  
34210  
USA  
Contact: Mrs Cindy Wong  
Job Title: Sales & Marketing  
T: + 1 941 727 5788 x 7594  
F: + 1 941 727 5293  
E: info@itape.com  
W: www.intertapepolymer.com

## King Bag & Manufacturing Co

1500 Spring Lawn Avenue  
Cincinnati  
OH  
45223  
USA  
Contact: Mr Ron Kirsch Sr  
Job Title: President  
T: + 1 513 541 5440  
F: + 1 513 541 6555  
E: ronsr@kingbag.com  
W: www.kingbag.com

## Langston Companies Inc

2500 South K Street  
Tulare  
CA 93274  
USA  
Contact: Mr Cariton Truhett  
Job Title: Managing Director  
T: + 1 559 688 3839  
F: + 1 559 688 1876

## Langston Companies Inc.

PO Box 60  
Memphis  
Tennessee  
38101-0060  
USA  
Contact: Mr Bob Langston  
Job Title: President  
T: + 1 901 774 4440  
F: + 1 901 942 5402  
E: blangston@langstonbag.com  
W: www.langstonbag.com

## Powertex Inc

1 Lincoln Boulevard  
New York  
New York  
12979  
USA  
Contact: Mr George Bombardier  
Job Title: Vice President Sales and  
Marketing  
T: + 1 518 297 4000  
F: + 1 518 297 2634 / 2242  
E: georgebombardier@powertex.com  
W: www.powertex.com  
Powertex is a manufacturer of  
Liners for 20', 30' and 40' ocean  
containers, with plants in the US,  
China and India. They produce  
using PE film FDA approved,  
antistatic, woven and foil and have  
the capability to customize  
according to customer needs. They

## Semi-Bulk Systems Inc

159 Cassens court  
Fenton  
MO 63026  
USA  
Contact: Mr Bentley  
Job Title:  
T: + 1 636 343 4500 x 112  
F: + 1 636 343 2822  
E: rbentley@semi-bulk.com  
W: www.semi-bulk.com



PORTS & TERMINALS



ALBANIA

Durres

**Port Authority of Durres**  
Lagja No.1 Rruga Tregtare  
Durres  
Albania  
Contact: Partizan Osmani  
Job Title: Marketing  
F: + 355 52 23115  
E: apd@san.com.al  
W: http://www.apdurrres.com/al/

ALGERIA

Algiers

**Entreprise Portuaire d'Alger**  
2 Rue d'Angkor  
PO Box 259  
Algiers  
Algeria  
Job Title: Port Director  
T: +213 21 42 36 14 / 16 / 18 / 23 / 42  
F: + 213 21 42 36 06  
E: epal@portalger.com.dz  
W: www.portalger.com.dz

Annaba

**Entreprise Portuaire de Annaba**  
Môle Cigogne  
Quai Nord  
PO Box 1232  
Annaba  
23000  
Algeria  
Contact: Mr D Salhi  
Job Title: President Director  
General  
T: + 213 38 86 31 31/43  
F: + 213 38 86 54 15  
E: epan@annaba-port.com

W: www.annaba-port.com  
North East of Algeria  
Grain silo: Two (02)  
loading/offloading grain unloader with a total capacity of 100&400tph, Vigan grain unloader capacity 250tph  
Phosphates: 03 unloader of 1000tph -1200tph  
Coke-Iron: 04 unloader of 800-1000tph  
05 Electry quay crane 25t  
02 Electry quay crane 40t  
UAN-Phosphoric Acid - Urée en vrac : unloader 320tph  
Berth12 :Grain Depth: 9.80m, Length: 155ml  
Berth11: Raw sugar-vegetable oil Depth: 9.50m, Length:145ml  
Berth13 Coal - Iron ore Depth: 13m, Length: 320ml  
Berth14-15 Steel products Depth: 9.75m, Length:630ml  
Berth 16-17 et 19 : Phosphates Depth: 9.45m to 11m, Length:130-220ml  
Berth 18 UAN-Fuel-Tar-Ammonia Depth:11m, Length:125ml  
163,000sqm  
50,000sqm

Bejaia

**Entreprise Portuaire de Bejaia**  
13 Avenue of the Amrani Brothers  
Bejaia  
06000  
Algeria  
Contact: Mr Achour Djelloul  
Job Title: Port Chairman General Manager  
T: + 213 34 21 18 07  
F: + 213 34 20 14 88  
E: portbj@portdebejaia.cz

W: www.portdebejaia.dz  
The North East of Algeria at 260 KM. East of Algiers and 460km West of Annaba  
- grain vacu-vators (3x 250 tons per hour)  
- 2 cranes (1x 63 tons and 1x 80 tons) equipped with 10 t grabs for grain handling.  
- 2 cranes (2x 10t)  
- 3 new cranes (3x 64t) equipped with 12 m3 grabs for grain handling  
4 berths specialized for cargo bulk handling. Max length 210m. Max draft 10.5m

Beni Saf

**Entreprise Portuaire de Beni Saf**  
Route du Port  
Beni Saf  
Algeria  
T: + 213 43 225 468  
E: ypa@y.net.ye

Ghazaouet

**Port Authority of Ghazaouet**  
PO Box 217  
Ghazaouet  
13400  
Algeria  
Contact: Mr K Mehabi  
Job Title: Manager  
T: + 213 43 323353  
F: + 213 43 323255  
E: contact@portdeghazaouet.com  
W: www.portdeghazaouet.com

Mostaganem

**Entreprise Portuaire de Mostaganem**  
PO Box 131  
Mostaganem  
27000  
Algeria  
Contact: Mr Mohamed Bouabida  
Job Title: Port Director  
T: + 213 45 21 14 11  
F: + 213 45 33-01-15  
E: epm@port-mostaganem.dz  
W: http://www.port-mostaganem.dz/

Skikda

**Entreprise Portuaire de Skikda**  
Avenue Rezki Rahal  
PO Box 65  
Skikda  
21000  
Algeria  
Job Title: Port Director  
T: + 213 38 75 68 50 / 75 22 54  
F: + 213 38 75 20 15  
E: epskikda@skikda-port.com  
W: www.skikda-port.com

ANGOLA

Lobito

**Porto do Lobito E.P**  
Largo Restoration 4  
Customs Building  
Lobito  
Benguela  
16  
Angola  
Contact: Mr José Carlos Gomes  
Job Title: Manager Director  
T: +244 272 224 686  
F: +244 272 224 971  
E: ops.lob@orey.co.ao  
W: www.portdolobito.com  
100,000 sqm  
25,853sqm  
Silos with 20,000t capacity

Luanda

**Cabinda Gulf Oil Company Limited**  
PO Box 2950  
Luanda  
Uige

Angola  
Contact: Mr Alan Kleier  
Job Title: Managing Director  
T: + 244 222 692 600  
F: + 244 222 394 348  
E: questoes@chevron.com  
W: www.chevroninangola.com

Luanda

**Porto de Luanda**  
Administracao do Porto de Luanda  
Largo 4 de Fevereiro  
Luanda  
1229  
Angola  
T: + 244 2 335 975  
F: + 244 2 840 535  
E: portoluanda@snet.co.ao  
W: www.otal.com/angola

ARGENTINA

Bahia Blanca

**Bahia Blanca Port**  
Avenida Dr Mario M Guido  
8103 Ingeniero White  
Bahia Blanca  
Argentina  
Contact: Mr V Morán  
Job Title: General Manager  
T: + 54 291 457 3213  
F: + 54 291 457 3214  
E: secretaria@puertobahia blanca.com.ar  
W: www.puertobahia blanca.com

Bahia Blanca

**Glencore/Toepfer Grain Elevator**  
Ingeniero White Port Area  
Bahia Blanca  
Argentina  
Contact: Mr Dario de Luca  
T: + 54 291 72332  
F: + 54 291 72360  
E: dario.de.luca@glencore.com

Bahia Blanca

**Oleaginoso Moreno Hermanos SA**  
Berths 2 and 3  
Puerto Galvan Port area  
Bahia Blanca  
8103  
Argentina  
T: + 54 291 457 3333  
E: jrjuz@omhsa.com.ar

Bahia Blanca

**Puerto De Bahia Blanca**  
Consorcio De Gestion Del Puerto De Quequen  
Puertos De Ing White Y Galvan  
Av Dr Mario Guido Ing White  
Bahia Blanca  
Argentina  
Contact: Mr Luis Alejandro Arecco  
Job Title: President  
T: + 54 291 457 3213  
F: + 54 291 457 3214  
W: www.puertobahia blanca.com

Bahia Blanca

**Terminal Bahia Blanca, Piers 5/6, 7/8 and 9**  
Ingeniero White Port Area  
Bahia Blanca  
Buenos Aires  
8103  
Argentina  
Contact: Mr Horacio Moretti  
Job Title: Manager  
T: + 54 91 457 3035  
F: + 54 91 457 1728  
E: horacio.moretti@bunge.com  
Is located in Ingeniero White Port, Bahia Blanca City, Buenos Aires Province, Argentine Republic.  
TBB covers a total area of 136,890 sqm.  
The total storage capacity is about

197,000 tons(wheat base) distributed among 500 silos. The maximum discharging diary capacity is about 500 trucks and 200 wagons.

Barranqueras

**Puerto de Barranqueras**  
Intervencion Provincial Puerto Barranqueras  
Av Rio Parana s/n  
Barranqueras  
Chaco  
3503  
Argentina  
Contact: Mr Daniel Ruben Gaborov  
T: + 54 3722 480216  
E: puertobqras@arnet.com.ar  
W: www.consejopuertoario.com.ar

Barranqueras

**Puerto de Barranqueras**  
Av. Rio Parana s/n  
Barranqueras 3503  
Argentina  
Contact: Mr Brandt  
T: + 54 3722 480216  
F: + 54 3722 480216  
E: puertobqras@infovia.com.ar  
W: www.advance.com.ar

Buenos Aires

**ACA Berth - San Lorenzo Port**  
Asociacion de Cooperatives Argentinas Coop.(ACA)  
940 Madero Avenue  
6th Floor  
Buenos Aires  
C1106ACW  
Argentina  
Contact: Mr Nestor E. Salaberry  
Job Title: Export Manager  
T: + 54 11 4310 1300 ext. 1168/1170  
F: + 54 11 4313 1349  
E: Salaberry@acacoop.com.ar  
W: www.acacoop.com.ar  
KM 446,2 of Parana River – Santa Fe Province - Argentina  
273mt load; draught 40feet alongside berth at datum but according to Parana River limitation.  
240,000mt dry grains. 11,000mt vegetable oils + 70,000mt dry fertilizers + 30,000mt liquid fertilizers.  
Import: dry and liquid fertilizers.  
Export: grains and oilseeds  
ACA is a cooperative that also provides throughput to other Argentine exporters.

Buenos Aires

**ACA Berth Nbr 3 - Quequen Port**  
Asociacion de Cooperatives Argentinas Coop.(ACA)  
940 Madero Avenue  
6th Floor  
Buenos Aires  
C1106ACW  
Argentina  
Contact: Mr Nestor E. Salaberry  
Job Title: Export Manager  
T: + 54 11 4313 1300 ext.1168/1170  
F: + 54 11 4313 1349  
E: Salaberry@acacoop.com.ar  
W: www.acacoop.com.ar  
Left hand margin at the mouth of the Quequen River, Buenos Aires, Argentina  
230mt load; draught 39 feet alongside at datum but according to Necochea Port restrictions  
180,000mt dry grains. 10,5000mt vegetable oils. 20,000mt dry fertilizers.  
Import: Dry fertilizers  
Export: Grains and vegetable oils  
ACA is a cooperative that also provides throughput to other Argentine exporters.

## Buenos Aires

**Del Bene SA**  
Piedras  
77-90 Piso  
Buenos Aires  
1070  
Argentina  
Contact: Snr Ferruccio Del Bene  
T: + 54 11 4342 5211  
F: + 54 11 4343 5352  
E: latinamerica@savinodelbene.com

## Buenos Aires

**Quebracho Elevator**  
Avenida Leandro N Alem 928  
Buenos Aires  
1001  
Argentina  
Contact: Mr Luis Anunciata  
T: + 54 11 4476 29049  
F: + 54 11 4476 29057

## Buenos Aires

**SA Berth**  
AV Paseo Colon 505  
Fourth Floor (CP1063)  
Buenos Aires  
Argentina  
Contact: Mr Sergio Suarez  
T: + 54 11 4342 1727  
F: + 54 11 4346 8001  
E: institucionales@puertobuenosaires.gov.ar

## Buenos Aires

**Terminal 4**  
Av. Edison y Prefectura Naval  
Puerto Nuevo  
Capital Federal  
Buenos Aires  
C1104BCA  
Argentina  
Contact: Mr Juan Corujo  
Job Title: Terminal Manager  
T: + 54 11 45 900 900 Ext. 8120  
F: + 54 11 45 900 991  
E: bueaapmtmg@apmtterminales.com  
W: www.apmtterminales.com

## Buenos Aires

**Terminal Buenos Aires SA**  
Av. Edison y Calle Prefectura Naval  
Argentina  
Dársena D Sud 2da.  
Puerto Nuevo  
Buenos Aires  
1104  
Argentina  
Contact: Lic. Nicolas C Caporale  
Job Title: Gerente de Planta  
T: + 54 11 4311 3598  
F: + 54 11 4312 8031  
E: ncaporale@terbasa.com.ar

## Buenos Aires

**Terminal EMCYM**  
Dársena C Norte 3ra. Sección  
Puerto Nuevo  
Buenos Aires  
1104  
Argentina  
T: + 54 11 4313 0332  
F: + 54 11 4313 0347  
E: maritima@basal.com  
W: www.basal.com

## Buenos Aires

**Terminals Rio de la Plata**  
Avda R.S. Castillo y Comodoro Py  
Buenos Aires  
C1104BEN  
Argentina  
T: + 54 11 4319 9500  
F: + 54 11 4315 2700  
E: info@trp.com.ar  
W: www.trp.com.ar

## Buenos Aires

**TPA Terminales Portuarias**  
Argentinas

Avenida Ramon Castillo 8  
Av de los Inmigrantes y Av. Edison  
Acceso Maipu - Zona Puerto  
Buenos Aires  
1104  
Argentina  
Contact: Mr M Barea  
T: +54 11 4342 1727  
F: +54 11 4342 6836  
W: www.puertobuenosaires.gov.ar

## Diamante

**Port of Diamante**  
Puerto Nuevo  
3105  
Diamante  
Entre Rios Province  
Argentina  
Contact: Mr Gheradi  
T: + 54 343 498 1424  
F: + 54 343 498 1424  
E: eaptdote@infoshopdte.com.ar

## Ensenada

**La Plata Port Administration**  
St. G. Gaggino y Ortiz de Rosas  
Ensenada  
Buenos Aires Province  
Argentina  
Job Title: Port Director  
T: + 54 221 460 0233  
F: + 54 21 601014  
E: cgplp@ba.net

## Puerto General San Martin

**Terminal 6 S.A.**  
Hipolito Yrigoyen y Costa del  
Parana  
Puerto General San Martin  
Puerto General San Martin  
Provincia de Santa Fe  
CP 2202  
Argentina  
Contact: Mr Pablo Ferrés Sayago  
Job Title: General Manager  
T: + 54 3476 438066  
F: + 54 3476 438046  
E: avaldez@terminal6.com.ar  
W: www.terminal6.com.ar

## Quequen

**Consorcio de Gestion del Puerto de Quequen**  
Avda. Juan de Garay 850  
Quequen  
Buenos Aires  
7631  
Argentina  
Contact: Mr Jose Luiz  
Job Title: President  
T: + 54 2262 450006  
F: + 54 2262 450006  
E: secretaria@puertoquequen.com  
W: www.puertoquequen.com  
South East of the Province of  
Buenos Aires on the Atlantic Coast.

## Quequen

**Puerto Quequen**  
Avenue Juan de Garay 850  
Quequen  
Buenos Aires  
B7631XAF  
Argentina  
Contact: Mr Jose Alfredo Bisciotti  
Job Title: President  
T: + 54 2262 450 006  
F: + 54 2262 450 006  
E: info@puertoquequen.com  
W: www.puertoquequen.com

## Rosario

**Neptun SA - Operadores Maritimos**  
Terminal 1 s/no  
(Puerto Rosario)  
Rosario  
Sante Fe  
2000  
Argentina  
Contact: Mr Alejandro Jose Peirone

Job Title: Administrative Manager  
T: + 54 57 1221 9406  
F: + 54 341 4808304  
E: info@neptunlog.com  
W: www.neptunlog.com

## Rosario

**Puerto Rosario**  
Ente Administrator Puerto Rosario  
Av Belgrano 341  
Rosario  
PICA de Santa Fe  
Argentina  
Contact: Mr Carlos Bermudez  
T: + 54 341 448 7105  
F: + 54 341 448 5010  
E: webcpgq@puertoquequen.com  
W: www.enapro.com.ar

## Rosario

**Puerto Rosario**  
Cordoba 1464 4 Piso de C  
Rosario  
PICA de Santa Fe  
2000  
Argentina  
Contact: Mr Marcelo J Suarez  
Job Title: Vice President  
T: + 54 341 4487105  
F: + 54 341 4485010

## San Lorenzo

**Port of San Lorenzo**  
ACA Berth  
Avenida San Martin 2898  
San Lorenzo  
2200  
Argentina  
Contact: Mr Ing Raul Frugoli  
T: + 54 476 22225  
F: + 54 476 22225  
E: info@terminal6.com.ar

## San Lorenzo

**Vicentin Elevator**  
Km 441  
San Lorenzo  
Argentina  
Contact: Mr Jorge Forbitti  
T: + 54 3 476 424 899  
F: + 54 3 476 425 977  
E: consultas@vicentin.com.ar  
W: www.vicentin.com.ar

## San Pedro

**Puerto de San Pedro**  
Administracion Portuaria  
Bonaerense  
Ruta 191 Km. 0  
San Pedro  
San Pedro  
2930  
Argentina  
Contact: Mr Miguel Hogo Gremo  
T: + 54 3329 425378  
F: + 54 3329 425279  
W: www.consejoportuario.com.ar

## San Pedro

**Terminal Puerto San Pedro S.A.**  
Av. San Martin 2500  
San Pedro  
Argentina  
Contact: Mr A Franco  
Job Title: Port Director  
T: + 54 3329 420999  
F: + 54 3329 425279  
E: info@tsp.com.ar  
W: www.tsp.com.ar

## Santa Fe

**Administration Puerto Santa Fe**  
Cabecera Darsena 1  
3000  
Santa Fe  
Argentina  
Contact: Mr Montero  
Job Title: Port Director  
T: + 54 342 455 8400  
F: + 54 342 455 8392

E: info@puertosfe.com.ar  
W: www.puertosfe.com.ar

## Villa Constitucion

**Villa Constitucion Port Authority**  
Villa Constitucion  
Santa Fe  
Argentina  
Contact: Mr Martin Mansino  
T: + 54 3400 475012  
F: + 54 400 74404  
E: eapvo@cablenet.com.ar

## Zarate

**Zarate Port SA**  
Avda. Pagola 2007  
Zarate  
B2800DDO  
Argentina  
Contact: Mr Juan Gargantini  
Job Title: General Manager  
T: +54 3487 423010  
F: +54 3487 423212  
E: juangargantini@zport.com.ar  
W: www.zport.com.ar

## ARUBA

### Oranjestad

**Port of Oranjestad**  
Aruba Ports Authority N.V.  
Port Administration Building  
L.G. Smith Blvd. # 23  
Oranjestad  
Aruba  
Contact: Mr Alfonso J Boekhoudt  
Job Title: Managing Director  
T: + 297 582 6633  
F: + 297 583 2896  
E: Alfonso.Boekhoudt@arubaports.com  
W: www.arubaports.com

### San Nicolas

**San Nicolas Bay Port**  
Coastal Aruba Refining Co NV  
PO Box 2150  
San Nicolas  
Aruba  
Contact: Mr Jack Marshall  
Job Title: Manager  
T: + 297 589 4500  
F: + 297 589 8000  
E: psn@intercom.com.ar  
W: www.consejoportuario.com.ar

## AUSTRALIA

### Adelaide

**ABB Grain**  
Southern Australia  
124-130 South Terrace  
Adelaide  
5000  
Australia  
T: + 61 8 8211 7588  
F: + 61 8 8124 0142  
E: abb@abb.com.au

### Adelaide

**Flinders Ports Pty Ltd**  
296 St Vincent Street  
Port Adelaide  
Adelaide  
South Australia  
5015  
Australia  
Contact: Mr Wayne Parham  
Job Title: Marketing Manager  
T: + 61 8 8447 0611  
F: + 61 8 8447 0606  
E: flindersports@flindersports.com.au  
W: www.flindersports.com

### Adelaide

**Flinders Ports Pty. Ltd**  
296 St. Vincent Street  
PO Box 19

Adelaide  
S.A.  
5015  
Australia  
Contact: Mr Carl Kavina  
Job Title: General Manager -  
Marine Operations  
T: + 61 8 8447 0611  
F: + 61 8 8447 0606  
E: flindersports@flindersports.com.au  
W: www.flindersports.com.au  
Gulf of St Vincent, South Australia  
Crane 1 (spreader 46t, hook 60t),  
Crane 2 (36t spreader, hook 46t)  
Crane 4 (spreader 40t, hook N/A)  
Crane 5 (spreader 65t, Hook 75t),  
Viterra Grain Loader - 2,000tph  
Inner Harbour, berth 27 two  
travelling loading booms with  
spouts, 1450tph max for wheat,  
berth 29 mobile snake sandwich  
conveyor max 1000 tph, H berth  
fixed loader with luffing & slewing  
boom, Osborne & Outer Harbor,  
berth 8

### Adelaide

**Port Giles Grain Terminal**  
Grain House  
124-130 South Terrace  
Adelaide  
5001  
Australia  
T: + 61 8 8211 7199  
F: + 61 8 8231 1249  
E: viterra.aus@viterra.com  
W: www.abb.com.au

### Adelaide

**Port Pirie Grain Terminal Berth 2**  
Grain House  
123-130 South Terrace  
Adelaide  
SA  
5001  
Australia  
T: + 61 8 8632 1455  
F: + 61 8 8632 5918  
E: flindersports@flindersports.com.au

### Adelaide

**SACBH Ardrossan Grain Terminal**  
Grain House  
123-130 South Terrace  
Adelaide  
5001  
Australia  
T: + 61 8 8211 8087  
F: + 61 8 8211 8087  
E: viterra.aus@viterra.com  
W: www.abb.com.au

### Adelaide

**Thevenard Grain Terminal**  
Grain House  
123-130 South Terrace  
Adelaide  
SA  
5001  
Australia  
T: + 61 8 8211 8087  
F: + 61 8 8211 8087  
E: flindersports@flindersports.com.au

### Adelaide

**Walleroo Grain Terminal Berth 2**  
Grain House  
123-130 South Terrace  
Adelaide  
SA 5001  
Australia  
T: + 61 8 8211 8087  
F: + 61 8 8211 8087  
E: flindersports@flindersports.com.au  
W: www.flindersports.com.au

### Albany

**Port of Albany**  
85 Brunswick Road  
PO Box 175



Albany  
WA  
6330  
Australia  
Contact: Captain Steve Young  
Job Title: Harbour Master  
T: + 61 8 9892 9000  
F: + 61 8 9841 7566  
E: apa@albanyport.com.au  
W: www.albanyport.com.au

**Brisbane**

**Cape Flattery**  
Ports Corporation of Queensland  
PO Box 409  
Brisbane  
QLD 4001  
Australia  
Contact: Mr Tycho Buningh  
Job Title: Commercial Manager  
T: + 61 7 3244 7088  
F: + 61 7 3224 7234  
E: tbuningh@nqbp.com.au  
W: www.pcq.com.au  
Over 200 kms North of Cairns, on the east coast of the Cape York Peninsula, Australia  
On shore Silica Sand handling and stock pile facilities and a single trestle jetty and conveyor running from the mine to an off-shore berth and ship loader  
There is also a general purpose wharf where two line boats are moored (they assist in ship berthing). No tugs are required at the port.

**Brisbane**

**North Queensland Bulk Ports Corporation Limited**  
GPO Box 409  
Brisbane  
Queensland  
4001  
Australia  
Contact: Mr Brad Fish  
Job Title: CEO  
T: + 61 7 3011 7900  
F: + 61 7 3011 7997  
E: info@nqbp.com.au  
W: www.nqbp.com.au  
Port Authority for Weipa, Abbot Point, Mackay, Hay Point & Maryborough; northwest coast and east coast of Queensland.  
Total throughput 2011-2012 approx. 124 million tonnes.  
See port handbooks.  
The sea port facilities managed by NQBP are vital to the export and import performance of Queensland and Australia. NQBP ports handle bulk shipments of coal, bauxite, sand, sugar, grain, petroleum and general cargo.

**Brisbane**

**Port Weipa**  
Ports Corporation of Queensland  
PO Box 409  
Brisbane QLD 4001  
Australia  
Contact: Mr Brad Fish  
Job Title: CEO  
T: + 61 7 3224 1088  
F: + 61 7 3224 7234  
E: info@pcq.com.au  
W: www.pcq.com.au  
Located on the North-West coast of the Cape York Peninsula - Australia  
Total Bauxite export 2004/05: 15,519,910 tonnes  
Contact the Regional Harbour Master for current data. Phone (07) 4052 7412  
Other port facilities include general purpose and fuel wharves and tugs operated by Weifa Tug Service.  
Pilotage service provided by Maritime Safety Queensland.

**Brisbane**

**Queensland Bulk Handling Coal Export Terminal**  
3 Bulk Terminals Drive  
Port of Brisbane  
Brisbane  
Queensland  
4178  
Australia  
Job Title: Terminal Manager  
T: + 61 7 3895 6500  
F: + 61 7 3895 1170  
E: qbhlogistics@qbh.com.au  
W: www.qbh.com.au  
Port of Brisbane, Queensland, Australia

**Bunbury**

**Bunbury Port Authority**  
PO Box 4  
54 Casuarina Drive  
Bunbury  
WA 6231  
Australia  
Contact: Mr Kevin Schellack  
Job Title: Chief Executive Officer  
T: + 61 8 9729 6500  
F: + 61 8 9721 8253  
E: byport@bypport.com.au  
W: www.bypport.com.au  
170kms from Perth and some 15kms from the Kemerton Industrial Park.  
Three bulk shiploaders (2 privately owned & operated). In addition the Port has two mobile hoppers for the discharge of bulk cargo and a mobile harbour crane. Loading capacities of the shiploaders range from 1,000tph to approximately 2,000tph.  
Seven berths - serviced by deep water of up to 12.2m and uses a dynamic underkeel clearance to allow maximum freight to be carried by vessels.  
Over 500 hectares of land suitable for Port related industry, much of which has direct access to berths and/or shiplading facilities.  
Provides a number of storage facilities ranging in size from 10,000sqm to 4,000sqm.  
The Authority has in place state of the art infrastructure, deep water and excellent transport corridors for the efficient and competitive exchange of goods between sea and land.

**Burnie**

**Tasmanian Ports**  
PO Box 216  
Burnie  
Tasmania 7320  
Australia  
Contact: Captain Trevor Bozoky  
Job Title: Harbour Master & Deputy CEO  
T: + 61 3 6434 7300  
F: + 61 3 6434 7373  
E: secretary@tasports.com.au  
W: www.burnieport.com

**Cairns**

**Ports North**  
PO Box 594  
Cairns  
QLD 4870  
Australia  
Contact: Mr Chris Boland  
Job Title: Chief Executive Officer  
T: + 61 7 4052 3842  
F: + 61 7 4052 3853  
E: chris.boland@portsnorth.com.au  
W: www.portsnorth.com.au  
Far North East Coast of Australia in the State of Queensland.  
Bulk discharges via hopper to truck on general cargo wharf.  
N/A

**Carrington**

**GrainCorp Operations Ltd**  
Denison Street  
(PO Box 64)  
Carrington  
NSW  
2294  
Australia  
Contact: Mr Mark Jelbart  
T: + 61 2 4224 6400  
F: + 61 2 4224 6466  
E: mjelbart@graincorp.com.au  
W: www.graincorp.com.au

**Carrington**

**Newcastle Agri Terminal**  
Lvl 1 92 Hill Street  
Carrington  
New South Wales  
2294  
Australia  
Contact: Mr Jock Carter  
Job Title: Executive Director  
T: + 61 4 2728 3999  
E: jcarter@naterminal.com.au

**Carrington**

**Port Waratah Coal Services Limited (PWCS)**  
PO Box 57  
Carrington  
New South Wales  
2294  
Australia  
Contact: Mr Hennie du Plooy  
Job Title: Chief Executive Officer  
T: + 61 2 4907 2000  
F: + 61 2 4907 3000  
E: contact\_us@pwcs.com.au  
W: www.pwcs.com.au  
Newcastle, NSW, Australia  
Two coal export facilities with a combined throughput capacity of 145 million tpa.  
5 berths, each approximately 300m in length.  
N/A  
N/A  
Port Waratah Coal Services Limited (PWCS), located in the Port of Newcastle, NSW, Australia, operates the world's largest and most efficient coal handling facility.

**Dampier**

**Dampier Port Authority**  
PO Box 285  
Dampier  
WA 6713  
Australia  
Contact: Mr C Norman  
Job Title: General Manager  
T: + 61 91 596555  
F: + 61 91 596557  
E: info@dpa.wa.gov.au  
W: www.dpa.wa.gov.au

**Darwin**

**Darwin Port Corporation**  
GPO Box 390  
Darwin  
NT  
0801  
Australia  
Contact: Mr Robert Ritchie  
Job Title: Chief Executive Officer  
T: + 61 8 8922 0644  
F: + 61 8 8922 0666  
E: darwinport.dpa@nt.gov.au  
W: www.darwinport.nt.gov.au

**Darwin**

**P&O Automotive and General Stevedoring**  
PMB 23  
Berrimah  
Darwin  
Northern Territory  
0828  
Australia  
Contact: Mr Michael Van Brederode

Job Title: Regional Manager  
T: + 61 8 8922 2300  
F: + 61 8 8941 0604  
E: craig.doudle@poags.com.au  
W: www.poags.com.au  
Top of Australia, Northern Territory  
Heavy machinery and Portainer and mobile cranes  
Dry Bulk - discharge grabs and hoppers and bulk ship loader for loading  
Liquid bulk - discharging and loading equipment available  
As requested  
As requested

**East Davenport**

**P & O Automotive & General Stevedoring**  
Berth No 1, Spirit of Tasmania Terminal  
The Esplanade  
East Davenport  
Tasmania  
7310  
Australia  
Job Title: Operations Manager  
T: + 61 3 6427 0138  
F: + 61 3 6427 8466

**East Perth**

**James Point Pty Ltd (JPPL)**  
Level 2, 6 Bennett Street  
East Perth  
Western Australia  
6004  
Australia  
Contact: Dr Chris Whitaker  
Job Title: Chairman  
T: + 61 408 428 079  
F: + 61 8 9202 1607  
E: chris.whitaker@jamespoint.com.au  
W: www.jamespoint.com.au

**Esperance**

**Esperance Ports - Sean & Land**  
Corner of Bower Avenue & The Esplanade  
PO Box 35  
Esperance  
WA  
6450  
Australia  
Job Title: General Manager of Commercial  
T: + 61 8 9072 3333  
F: + 61 8 9071 1312  
E: esppa@esperanceport.com.au  
W: www.esperanceport.com.au  
Located on the Southern Ocean Coastline of Western Australia, approximately 720kms South East of the State Capital Perth.  
(Storage Capacity)  
Iron Ore: 900,000 Tonnes  
Nickel: 500,000 Tonnes  
Containers: 15,000 -20,000  
Fertiliser: 100,000 Tonnes  
Sulphur: 20,000 Tonnes  
Grain: 250,000 Tonnes  
Cape Size Berth capable of loading 3,000tph  
Approx. 89,000sqm  
Approx. 128,000sqm

**Fremantle**

**Fremantle Ports**  
PO Box 95  
Fremantle  
WA  
6959  
Australia  
Contact: Mr Chris Leatt-Hayton  
Job Title: CEO  
T: + 61 8 9430 3555  
F: + 61 8 9336 1391  
E: mail@fremantleports.com.au  
W: www.fremantleports.com.au

**Geelong**

**Geelong Port**  
PO Box 344  
Geelong  
Victoria  
3220  
Australia  
Contact: Mr Ken Stanley  
Job Title: Operations Manager  
T: + 61 3 52470200  
F: + 61 3 52721560  
E: k.stanley@patrick.com.au  
W: www.geelongport.com.au  
Southern Australia on Port Phillip Bay.  
Two level luffing cranes at Lascelles Wharf - Grabs up to 3,000 tonnes per shift and hooks 27.5 tonnes at 28m radius.  
Dry Bulk Loader at Corio Quay - 1,000 tph capacity  
Corio Quay North No 1 & No 2 berths  
Length 375m, Draught 10.4m  
Lascelles Wharf No 1 Berth  
Length 185m, Draught 11.7 m  
Lascelles Wharf Nos 2 & 3 Berths  
Length 436m, Draught 11.7m  
20,000sqm  
15,500sqm

**Geraldton**

**Geraldton Port Authority**  
289 Marine Terrace  
PO Box 1856  
Geraldton  
WA 6531  
Australia  
Contact: Capt Martin North  
Job Title: Harbour Master  
T: + 61 8 9964 0547  
F: + 61 8 9964 0555  
E: martin.north@gpa.wa.gov.au  
W: www.gpa.wa.gov.au  
North West Coast of Australia. Approximately 200nm North of Fremantle.

**Gladstone**

**Barney Point Coal Terminal**  
Central Queensland Ports Authority  
PO Box 259  
Gladstone  
Queensland  
QLD 4680  
Australia  
Contact: Mr Peter O'Sullivan  
T: + 61 74 976 1471  
F: + 61 74 972 3045  
E: osullivanp@cqpa.com.au  
W: www.gpa.org.au

**Gladstone**

**Central Queensland Ports Authority**  
PO Box 259  
Gladstone  
Queensland  
4680  
Australia  
Contact: Mr Leo Zussino  
Job Title: CEO  
T: + 61 749 761 333  
F: + 61 749 723 045  
E: zussinol@cqpa.com.au  
W: www.cqpa.com.au

**Gladstone**

**Gladstone Ports Corporation**  
PO Box 259  
Gladstone  
Queensland  
4680  
Australia  
Contact: Mr Ian Drury  
Job Title: Port Planning and Development GM  
T: + 61 7 4976 1333  
F: + 61 7 4972 2419  
E: druryi@gpocl.com.au  
W: www.gpocl.com.au

## Gladstone

**Gladstone Ports Corporation**  
Central Queensland Ports Authority  
PO Box 259  
Gladstone  
Queensland  
QLD 4680  
Australia  
Contact: Mr Leo Zussino  
Job Title: Chief Executive Office  
T: + 61 7 4976 1333  
F: + 61 7 4972 3045  
E: illingdo@gpca.com.au  
W: www.gpa.org.au

## Gladstone

**Grainco Queensland Gladstone Terminal Berth 2**  
Gladstone Port Authority  
19 Yarroon Street  
PO Box 259  
Gladstone  
Queensland 4680  
Australia  
Contact: Mr Leo Zussino  
Job Title: Chief Executive Officer  
T: + 61 7 4976 1333  
F: + 61 7 4972 3045  
E: info@gpa.org.au  
W: www.gpa.org.au

## Hastings

**Port of Hastings Authority**  
PO Box 129  
Hastings  
VIC 3915  
Australia  
Contact: Mr Richard Cox  
Job Title: Harbour Master  
T: + 61 3 5979 5500  
F: + 61 3 5979 5555  
E: enquiries@portofhastings.vic.gov.au  
W: www.tollports.com.au

## Kooragang Island

**Newcastle Coal Infrastructure Group**  
Locked Bag 6003  
Hunter Region Mail Centre  
Kooragang Island  
NSW 2310  
Australia  
Contact: Mr Paul Beale  
Job Title: General Manager  
T: + 61 2 4920 3900  
E: enquiries@ncig.com.au  
W: www.ncig.com.au

## Mackay

**Dalrymple Bay Coal Terminal (DBCT)**  
Martin Armstrong Drive  
Hay Point  
Mackay  
QLD  
4740  
Australia  
Contact: Mr Gavin Springorum  
Job Title: Media & Corporate  
T: + 61 7 4943 5645  
F: + 61 7 4943 8466  
E: andrew.garratt@dbct.com.au  
W: www.dbct.com.au  
Hay Point Mackay Queensland  
Australia  
Total Coal export 2004/05:  
50,248,059.  
2x stackers: 5,500 - 6,000tph  
1x reclaimers: 3,300 - 4,200tph  
5x stacker reclaimers: 3,300 - 5,800tph  
3x shiploaders: 7,200 - 7,950 tph  
Berth 1: 662m (combined with B2), 17.9mLAT (depth)  
Berth 2: 662m (combined with B1), 18.4mLAT (depth)  
Berth 3: 250m, 18.8LAT (depth) up to 1.4Mmt  
n/a  
n/a

## Melbourne

**P & O Ports - Geelong**  
P O Box 4732  
Melbourne  
VIC  
3001  
Australia  
Contact: Mr Jonathan La Forge  
Job Title: Manager  
T: + 61 3 9396 6430  
F: + 61 3 9396 6444  
E: jonathan.laforge@poports.com.au  
W: www.poports.com.au/

## Melbourne

**Port of Melbourne Corporation**  
GPO Box 261  
Melbourne  
VIC  
3001  
Australia  
Contact: Mr Stephen Bradford  
Job Title: Chief Executive Officer  
T: + 61 39 683 1386  
F: + 61 39 683 1385  
E: info@portofmelbourne.com.au  
W: www.portofmelbourne.com.au

## Newcastle

**Newcastle Port Corporation**  
6 Newcomen Street  
(PO Box 663)  
Newcastle  
New South Wales  
2300  
Australia  
Contact: Ms Tegan Betts  
Job Title: Marketing Manager  
T: + 61 2 4985 8222  
F: + 61 2 4926 4596  
E: business@newportcorp.com.au  
W: www.newportcorp.com.au  
East Coast of Australia 70 nautical miles north of Sydney.  
Variety of ship handling facilities including pneumatic grabs, ships grabs, berth gantry grabs, pipelines, belt loaders and ships cranes.  
19 operational berths. 11 berths dedicated to general cargo, bulk, break bulk and project cargoes. 8 berths dedicated to coal.  
Large range of opportunities available  
Range of facilities available  
One of our core objectives is to facilitate trade growth and to ensure the best use of port facilities and infrastructure. Contact Business Development for more information on our capabilities.

## North Mackay

**Hay Point Coal Terminal (HPCT)**  
PO Box 3340  
North Mackay  
Queensland  
4740  
Australia  
Contact: Mr Peter Hanrahan  
Job Title: General Manager  
T: + 61 7 4943 5201  
F: + 61 7 4956 3421  
E: peter.f.hanrahan@bhpbilliton.com  
W: www.bhpbilliton.com  
Port Authority: Ports Corporation Queensland Limited.

## North Sydney

**Patrick Stevedores Operations Pty Limited**  
Level 6  
15 Blue Street  
North Sydney  
NSW  
2060  
Australia  
Contact: Mr John Horan  
Job Title: General Manager  
Contracts & Marketing  
T: + 61 2 8484 8110

F: + 61 2 8484 8176  
E: j.horan@patrick.com.au  
W: www.patrick.com.au  
Pan Australia  
Scope of business; container terminal operators, automotive and general stevedores, automotive PDI and distribution services, logistics providers and rail operator.

## Perth

**CBH Albany Grain Terminal**  
GPO Box L886  
Perth  
WA  
6842  
Australia  
Contact: Mr Will Piercy  
Job Title: Terminal Manager  
T: + 61 8 9845 5555  
F: + 61 8 9841 8499  
E: info@cbh.com.au  
W: www.cbh.com.au

## Perth

**CBH Esperance Grain Terminal**  
GPO Box L886  
Perth  
WA  
6842  
Australia  
Contact: Mr Michael Colgan  
Job Title: Terminal Manager  
T: + 61 8 9071 2302  
F: + 61 8 9071 4040  
E: info@cbh.com.au  
W: www.cbh.com.au

## Perth

**CBH Geraldton Grain Terminal**  
GPO Box L886  
Perth  
WA  
6842  
Australia  
Contact: Mr Eric Cooper  
Job Title: Terminal Manager  
T: + 61 8 9921 9499  
F: + 61 8 9921 7463  
E: info@cbh.com.au  
W: www.cbh.com.au

## Perth

**CBH Kwinana Grain Terminal**  
GPO Box L886  
Perth  
WA  
6842  
Australia  
Contact: Mr Justin Bayles  
Job Title: Terminal Manager  
T: + 61 8 9591 5100  
F: + 61 8 9527 7938  
E: info@cbh.com.au  
W: www.cbh.com.au

## Pinekenba

**Grainco Queensland Pinekenba Terminal**  
31 Soutter Street  
Pinekenba  
Queensland  
4008  
Australia  
T: + 61 7 638 2440  
F: + 61 7 638 2440  
E: enquiries@graincorp.com.au

## Port Adelaide

**Flinders Ports - Port Pirie**  
PO Box 19  
Port Adelaide  
SA 5015  
Australia  
Contact: Mr Shane Nielsen  
Job Title: Operations Manager  
T: + 61 8 8632 1455  
F: + 61 8 8447 0606  
E: flindersports@flindersports.com.au  
W: www.flindersports.com.au  
Spencer Gulf, South Australia

Latitude 33 degrees - 10 minutes south  
Longitude 138 degrees - 02 minutes east  
One ship unloader - 29 tonnes, five slewing booms with spouts, gantry loader  
Berth 6, Zinc concentrates

## Port Hedland

**Port Hedland Port Authority**  
PO Box 2  
Port Hedland  
WA 6721  
Australia  
Contact: Ms Paige Carroll  
Job Title: Executive Secretary  
T: + 61 8 9173 0011  
F: + 61 8 9173 0060  
E: paige.carroll@phpa.com.au  
W: www.phpa.com.au

## Port Kembla

**Port Kembla Port Corporation**  
PO Box 89  
Port Kembla  
New South Wales  
2505  
Australia  
Contact: Mr Ray Smith  
Job Title: Manager Business Development  
T: + 61 2 4275 0113  
F: + 61 2 4274 0643  
E: rxs@portkembla.com.au  
W: www.portkembla.com.au  
Port Kembla is located 80km south of Sydney on the East Coast of Australia.  
Berth 202: One 17 tonne luffing crane; one 500tph shiploader.  
Berth 109: Two 30 tonne luffing cranes  
No. 2 Discharge Berth: Two 15 tonne travelling transporter grab cranes-gross loading rate 500tph and one 35 tonne travelling transporter grab crane-gross rate 1,000tph.  
Berth 102: Two gantry shiploaders-nominal loading rate 6,600tph  
Berth 101: One gantry shiploader-nominal loading rate 1m200tph hour.  
Outer Harbour:  
Berths 202,204 - 300m, 10.40m  
Berths 203,205 - 300m 9.40m  
Inner Harbour:  
Berth 113 - 192m, 11.0m  
Berth 109 - 220m, 12.20m  
Berth 112 - 278m, 12.80m  
Berth 111 - 310m, 15.75m  
Berths 105,106 - 510m, 16.00m  
Berth 107 - 290m, 12.3m  
Berth 104 - 200m, 12.3m  
Berth 104 (air draught 17m) - 233m, 15.10m  
Berth 102 (air draught 22.4m) - 300m, 16.25m  
Berth 101 (air draught 17.4m) - 215m, 11.60m  
80 hectares  
20,000sqm  
The Port is a major trade centre for coal, steel and grain. The Port is now the facility for all imported vehicles for NSW.

## Port Lincoln

**Flinders Ports P/L**  
PO Box 354  
Port Lincoln  
SA 5606  
Australia  
Contact: Captain Robert Cobban MNI  
Job Title: Port Pilot  
T: + 61 886 823633 / 868 23723  
F: + 61 886 826725  
E: captrobcobb@ozemail.com.au  
W: www.flindersports.com.au  
South Australia - Spencer Gulf

Two with Depth 15 metres

## Port of Brisbane

**Port of Brisbane Pty Ltd**  
Locked Bag 1818  
Port of Brisbane  
Queensland  
4178  
Australia  
Contact: Trade Services Team  
T: + 61 7 3258 4888  
F: + 61 7 3258 4703  
E: info@portbris.com.au  
W: www.portbris.com.au  
Australia, East Coast, Queensland, Brisbane  
Fisherman Islands Grain; grain loading - up to 2,200tph, woodchips loading - 1,000tph, sugar loading - 800tph, cottonseed loading - 600tph.  
Fisherman Islands Coal: coal loading - up to 3,000tph, received by rail - 2,500tph & cement clinker - receive hopper or self-unloading ships up to 2,000tph.  
Clinker Wharf: cement clinker - receive hopper with travelling grab crane bucket, discharge up to 400tph.  
Incitec Pivot North: bulk cargoes - loaded into three 50t hoppers using ship or mobile cranes.  
Pinkenba Bulk Terminal: Mobile gantry loader, load up to 1,200tph. Two import hoppers each 300tph. Direct to truck, silo, shed.  
Incitec Pivot South: bulk dry cargoes - fixed gantry ship loader, load 200tph.  
Sugar Terminal: sugar - mobile gantry loader, load 1,500tph.  
Fisherman Islands Grain: length 285m, draught 13m  
Fisherman Islands Coal: length 317m, draught 13.5m  
General Purpose: length 213m, draught 11.5m  
Cement Australia: length 220m, draught 9.7m  
Incitec Pivot North: length 210m, draught 10m  
Pinkenba Bulk Terminal: length 360m, draught 10.4m  
Fisherman Islands Coal - stockpile storage 900,000t  
Fisherman Islands Grain Pads - 100,000t  
Pinkenba Bulk Terminal - open area 25,000t  
Fisherman Islands Grain: silo storage 60,000t, sugar/cottonseed shed 40,000t  
Clinker Wharf: storage sheds 30,000t, 82,000t, 5,000t.  
Incitec Pivot North: storage 50,000t.  
Pinkenba Bulk Terminal: 80,000t, silo 62,000t, open area 25,000t  
Fisherman Islands Grain: wharf use - grain, woodchips, sugar, cottonseed exports.  
Fisherman Islands Coal/Clinker wharf: wharf use - steaming coal exports. Used to discharge - bulk clinker, gypsum, slag imports.

## Portland

**Port of Portland Pty Ltd**  
PO Box 292  
23-25 Kunara Crescent  
Portland  
VIC 3305  
Australia  
Contact: Mr Malcolm Geier  
Job Title: Business Development Manager  
T: + 61 355 250900  
F: + 61 355 217488  
E: info@portofportland.com.au  
W: www.portofportland.com.au  
Southwest Victoria, Australia.  
Refer to www.portofportland.com.au



**Portland**

**Vicgrain Portland Terminal**  
Harbour Rd  
Portland  
Victoria  
Australia  
Contact: Ms Kate Phillips  
Job Title: Marketing Services  
T: + 61 8 8762 4873  
E: graincorpools@graincorp.com.au  
W: www.graincorp.com.au

**Seventeen Mile Rocks**

**Mitchell Ports**  
112 Bluestone Circuit  
Seventeen Mile Rocks  
Queensland  
4073  
Australia  
Contact: Mr Robert Thatcher  
T: + 61 7 3722 7277  
F: + 61 7 3722 7256  
E: r.thatcher@mitchellgroup.net  
W: www.mitchellgroup.net/

**Sydney**

**Patrick the Australian Stevedore**  
Level 8  
309 Kent Street  
Sydney  
2000  
Australia  
Contact: Mr A Perkins  
Job Title: NSW Manager  
T: + 61 2 9256 6700  
F: + 61 2 9299 2020  
E: info@patrick.com.au  
W: www.patrick.com.au

**Tasmania**

**Tasmanian Ports Corporation (Tasports)**  
GPO Box 202  
Tasmania  
7001  
Australia  
Contact: Mr Charles Scarafiotti  
Job Title: Executive Manager - Marketing  
T: + 61 3 6222 6067  
E: charles.scarafiotti@tasports.com.au  
W: www.tasports.com.au

**Thevenard**

**Thevenard Port**  
Ports Corp South Australia  
Thevenard Road  
Thevenard  
SA  
5690  
Australia  
Contact: Mr Peter Codrington  
Job Title: Operations Manager  
T: + 61 8 8625 2617  
F: + 61 8 8625 3100  
E: flindersports@flindersports.com.au  
Far north-west coast of the Eyre Peninsula  
Latitude 32 degrees - 09 minutes south  
Longitude 133 degrees - 39 minutes east  
Thevenard jetty, serving both sides.  
Travelling gantry loader with retractable boom and spout attached. Gross loading rates – wheat 550/750tph, barley 550 tph, oats 500 tph, gypsum 1050 tph. Privately owned Vitierra, Thevenard jetty, serving both sides. Travelling gantry loader with retractable boom and spout attached.  
Thevenard is 793km west of Adelaide and 3km from the centre of Ceduna.

**Toowoomba**

**Grainco Queensland Fisherman Island Terminal**  
PO Box 136  
Toowoomba  
Queensland 4350  
Australia  
Contact: Mr Leon MaGuire  
Job Title: General Manager  
T: + 61 7 4632 9122  
F: + 61 7 389 51034  
E: enquiries@graincorp.com.au

**Townsville**

**Port of Townsville Limited**  
PO Box 1031  
Townsville  
Queensland  
4810  
Australia  
Contact: Mr Barry Holden  
Job Title: CEO  
T: + 61 7 4781 1512  
F: + 61 7 4781 1525  
E: info@townsville-port.com.au  
W: www.townsville-port.com.au  
(19 deg. 5'30"S, 146 deg. 52"E)  
Port of Townsville is a breakwater harbour situated on the Queensland coast in Cleveland Bay.  
Individual stevedoring companies have an extensive range of mobile cargo handling equipment including forklifts, tractors, trailers (container), loaders and earth-moving equipment.  
Berth 1 is a dedicated bulk liquids wharf used exclusively by tankers for bulk oil, gas and sulphuric acid discharge and by all types of vessels for bunkering.  
Berth 2 is used for unloading nickel ore, two gantry cranes can be equipped to unload ore from the vessel into hoppers to feed a conveyor system, which carries the ore into the load out site. The berth is leased to Xstrata who have licensed its use to Queensland Nickel.  
Berth 3 is leased to Xstrata, and is operated and controlled by Northern Stevedoring Services Pty Ltd. Typical cargoes handled over this wharf include: lead ingots, refined copper, nickel and zinc. Also used for containerised cargo, fertiliser imports and live cattle exports.  
Berth 4 has a priority berthing arrangement with Cement Australia handling bulk cement imported from Gladstone. The berth also handles molasses, mineral products, and general cargo. The molasses pipeline to this berth is capable of loading up to 400tph.  
Berth 7 is leased to Xstrata and supports a bulk shiploader for mineral concentrates and ores at the rate of 1,000tph, and fertiliser at 1,200tph. Mineral concentrates mined in northwest Queensland are exported over this wharf.  
Berth 8 is a general purpose berth handling molasses, fertiliser, refined mineral products, sulphur and general cargo.  
Berth 9 has a priority berthing arrangement with Queensland Sugar, and is Australia's largest point of export of sugar. A bulk shiploader delivers sugar to carriers at the rate of 2,000tph. The berth is equipped with bulk molasses and bunker pipelines.  
Berth 10 is a general purpose berth and is to be extended to accommodate cruise and military vessels.  
Berth 11 is known as the Outer Berth Mineral Concentrates

Loading Facility. Lead and zinc concentrates are placed onto a conveyor system by front-end loader and transported to the 1,350tphour shiploader. The facility is owned by BHP Billiton Cannington.  
Open storage space for Crude Load, Refined Copper, Zinc and other cargoes.  
Raw Sugar: Two storage sheds of 285,000t total capacity, located adjacent to Berth 9.  
A third storage shed of 420,000t storage capacity opened for business in late 2003.  
Molasses: Four bulk storage tanks of 60,000t total capacity located adjacent to Berth 4.  
Caustic Soda: One 5,000t storage tank, located adjacent to No. 4 wharf.  
Concentrates: 170,000t covered storage area, located adjacent to No. 7 wharf (MIM).  
40,000t covered storage area located in the Northern Balloon Loop (BHP).  
Cement: One 30,000t bulk cement storage silo, located in the Eastern Port Development Area.  
Chemicals: Two sulphuric acid storage tanks of 17,000t total capacity (1x5,000, 1x12,000t capacity), located in the Eastern Port Development Area.  
Fertilizer: One 90,000t covered storage shed, located in the Eastern Port Development Area.  
Sulphur: One 10,000t covered storage shed, located in the Eastern Port Development Area.  
Port of Townsville is a gateway to global trade and investment and the nexus of Australia's booming North Queensland region.  
Port of Townsville Limited is a statutory Government owned corporation.

**Walsh Bay**

**Sydney Ports Corporation**  
Level 4, 20 Windmill Street  
Walsh Bay  
NSW 2000  
Australia  
Contact: Mr Philip Holliday  
Job Title: Business Development  
T: + 61 2 9296 4999  
F: + 61 2 9296 4742  
E: enquiries@sydports.com.au  
W: www.sydneyports.com.au

**West Perth**

**Co-Operative Bulk Handling Ltd**  
Gayfer House  
30 Delhi Street  
West Perth  
WA  
6005  
Australia  
Contact: Ms Nikki Wilson-Smith  
Job Title: Marketing - Media  
T: + 61 8 9237 9600  
F: + 61 8 9322 3942  
E: info@cbh.com.au  
W: www.cbh.com.au

**Wollongong**

**Port Kembla Coal Terminal Limited**  
Port Kembla Road  
Wollongong  
New South Wales  
NSW 2520  
Australia  
Contact: Mr Peter Green  
Job Title: General Manager  
T: + 61 2 4228 0288  
F: + 61 2 4228 7605  
E: peter.green@pkct.com.au  
W: www.pkct.com.au

Located in the southern major port of New South Wales in Australia. (72 k south of Sydney)  
COAL FACILITY Rail dump station, road dump station, receival conveyors capacity 4400tph, 3 Stackers, stockyard, 2 Reclaimers, shiploading conveyors capacity 6600tph, 2 Shiploaders  
BULK PRODUCTS FACILITY road dump station, screening plant ,conveyor system 1000tph, 1shiploader, unload conveyor for self discharging ships  
Coal Berth length 250m, 16.25m alongside  
Bulk Products berth 215m, 11.6m depth alongside  
Approach channel 15.25m plus tide  
Coal stockyard 850,000sqm  
Bulk Products stockyard 250,000sqm  
None  
Port Kembla Coal Terminal serves the Southern and Western coalfields of New South Wales Australia and has an annual capacity modelled at some 18 million tonnes.

**Wollongong**

**Port Kembla Grain Terminal - GrainCorp Operations Limited**  
PO Box 1029  
Wollongong  
NSW  
2500  
Australia  
Contact: Mr Mark Jelbart  
Job Title: Manager  
T: + 61 4 224 6400  
F: + 61 4 224 6466  
E: mjelbart@graincorp.com.au  
W: www.graincorp.com.au

**Wyndham**

**CGL Wyndham Port**  
PO Box 186  
1 Wharf Road  
Wyndham  
Western Australia  
WA 6740  
Australia  
Contact: Mr Steve Forrest  
Job Title: Wharf Manager  
T: + 61 891 611 203  
F: + 61 891 611 244  
E: ordport@wn.com.au  
Far North, Kimberley Region, Western Australia  
Contact us for more information.

**Wynnum Central**

**Patrick Stevedores**  
PO Box 734  
Wynnum Central  
QLD 4178  
Australia  
Contact: Mr Matt Hollamby  
Job Title: Queensland Manager  
T: + 61 7 3893 8555  
F: + 61 7 3895 1534  
E: m.hollamby@patrick.com.au  
W: http://www.patrick.com.au

**BAHAMAS**

**Freeport**

**Grand Bahama Port Authority**  
PO Box 42666  
Freeport  
33114  
Bahamas  
Contact: Mr Felix N Stubbs  
Job Title: Chairman  
T: + 1242 352-6611  
F: + 1242 352-6184  
E: fstubbs@gbpa.com  
W: www.gbpa.com

**BAHRAIN**

**Manama**

**Mina Salman Port Authority**  
Customs and Ports Authority  
PO Box 15  
Manama  
Bahrain  
Contact: Mr J S Kendrick  
T: + 973 1772 5555  
F: + 973 1772 5534  
W: www.bahrainport.gov.com

**BANGLADESH**

**Chittagong**

**Chittagong Port Authority**  
PO Box 2013  
Bandar Bhaban  
Chittagong  
4100  
Bangladesh  
Contact: Mr Zulfrigar Ali  
Job Title: Commodore  
T: + 880 31 7419 8090  
F: + 880 31 710593  
E: cmancpa@globalctg.net  
W: www.cpabd.com



**BARBADOS**

**Bridgetown**

**Barbados Port Authority**  
University Row  
Princess Alice Highway  
Bridgetown  
Barbados  
Contact: Mr Richard Alleyne  
Job Title: Harbour Master  
T: + 1 246 430 4700  
F: + 1 246 429 5348  
E: administrator@barbadosport.com  
W: www.barbadosport.com

**BELGIUM**

**Antwerpen**

**Alfaport Antwerpen**  
Brouwersvliet 33  
Post Bus 8  
Antwerpen  
B-2000  
Belgium  
Contact: Mr Rudi de Meyer  
Job Title: Managing Director  
T: + 32 3 206 7381  
F: + 32 3 231 6728  
E: info@alfaportantwerpen.be  
W: www.alfaportantwerpen.be



DUNKIRK



GDANSK



GHENT



ANTWERP

**DRY BULK**

**FRUIT & FOOD**

**LIQUID PRODUCTS**

**BREAK BULK, CONTAINERS & RORO**

**LOGISTICS & WAREHOUSING**

**FREIGHT FORWARDING & CUSTOMS BROKERAGE SERVICES**

**SHIPPING & AGENCIES**

**SERVICES**

BELGIUM FRANCE GERMANY IVORY COAST NETHERLANDS POLAND SENEGAL SOUTH AFRICA

## CONTACT

TEL. +32 9 255.02.11

EMAIL [info@sea-invest.be](mailto:info@sea-invest.be)

[WWW.SEA-INVEST.COM](http://WWW.SEA-INVEST.COM)

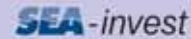

**Antwerpen****Antwerp Bulk Terminal (ABT)**

Haven 750, Delwaidedok  
Nieuwe Westweg 14  
Antwerpen  
B-2040  
Belgium  
Contact: Mr Michel Moons  
Job Title: Manager ABT  
T: + 32 9 255 02 51  
F: + 32 9 259 08 94  
E: michel.moons@sea-invest.be  
W: www.sea-invest.com

Port of Antwerp  
2 x 50t gantry  
1x 25t gantry  
3 x 40t mobile  
1 x 50t mobile  
2 x 40t mobile  
Antwerp: Delwaidedok, Leopolddok,  
Amerikadok, 6de Havendok  
110 ha  
130,000sqm

**Antwerpen****Antwerp Port Authority**

Havenhuis  
Entrepotkaai 1  
Antwerpen  
2000  
Belgium  
Contact: Mr Xavier van Rollegem  
Job Title: Business Development  
Manager  
T: + 32 3 205 2051  
F: + 32 3 205 2269  
E: xavier.vanrollegem@  
haven.antwerpen.be  
W: www.portofantwerp.com  
Antwerp is located in Northwest  
Europe. It is the second largest city  
in Belgium.  
146 Electric shore cranes (from 2-5t  
lift to 51-100t), 37 ship loading  
installations, 3 floating cranes and  
derricks, 9 gantries for bulk goods  
(5t, 35t, 50t), 14 grain elevators. 78  
mobile cranes.  
The major bulk terminals have a  
total quay length of 3.8 km, of  
which 1,800 m cape size and 2.2  
km panamax. In case of  
simultaneous arrivals it is possible  
to divert capesize or panamax  
vessels to different terminals in  
order to avoid delays.  
4,800,000 sqm  
We have specialised terminals for  
all kind of goods.

**Antwerpen****Boortmalt Group**

Zantvoort 2  
Haven 350  
Antwerpen  
B-2030  
Belgium  
Contact: Mr Yvan Schaeppman  
Job Title: CEO  
T: + 32 3 545 0411  
F: + 32 3 542 0582  
E: info@boortmalt.com  
W: www.boortmalt.com

**Antwerpen****Euroports Belgium NV**

Atlantic House - 3rd floor  
Noorderlaan 147  
Antwerpen  
2030  
Belgium  
Contact: Mr Wim Leuyckx  
Job Title: Commercial Director  
T: + 32 3 204 9300  
F: + 32 3 204 93 01  
E: info@euroports.com  
W: www.manuportgroup.com

**Antwerpen****Noord Natie Terminal**

Haven 227 - 243  
Blauwe Weg 44  
Antwerpen  
2030  
Belgium  
Contact: Ms M Teeuwens  
Job Title: Commercial Manager  
T: +32 3 543 99 00  
F: + 32 3233 39 38  
E: teeuwens.m@noordnatie.be  
W: www.noordnatie.be

**Antwerpen****SCR - Sibelco**

Quellinstraat 49  
Antwerpen  
BE - 2018  
Belgium  
Contact: Ms. Laurence Boens  
T: + 32 3 2236658  
E: info@sibelco.com  
W: www.sibelco.be

**Brugge****Firma Germain D'Hoore -**

**Ostende**  
Vaardijkstraat 76  
Brugge  
8200  
Belgium  
Contact: Mr H D'Hoore  
Job Title: Managing Director  
T: + 32 50 384 506  
F: + 32 50 384 851

**Gent****Arcelor Steel Belgium NV**

Arcelor Gent  
John Kennedylaan 51  
Gent  
9042  
Belgium  
Contact: Mr Koen De Coster  
Job Title: Maintenance manager  
railway and locomotives  
T: + 32 9347 2670  
F: + 32 9347 4916  
E: info.sidmar@arcelormittal.com  
W: www.sidmar.be

**Gent****Ensagent NV**

Skaldenstraat 1  
Gent  
9042  
Belgium  
Contact: Mr. Tom Zirrick  
Job Title: Planning Manager  
T: + 32 9 255 02 11  
F: + 32 9 259 08 93  
E: info@sea-invest.be  
W: http://www.sea-invest.com/

**Gent****Euro-Silo NV**

Zeehaven-Oost  
Alphonse Sifferdok  
J F Kennedylaan 19  
Gent  
B9000  
Belgium  
Contact: Mr Daniel Matthys  
Job Title: Managing Director  
T: + 32 9 345 96 11  
F: + 32 9 251 6074  
E: daniel.matthys@eurosilos.com  
W: www.euro-silo.com

**Gent****Ghent Coal Terminal NV - GCT**

Skaldenstraat 1  
Gent  
9042  
Belgium  
Contact: Mr Bart Laureys  
T: + 32 9 255 02 11  
F: + 32 9 259 08 94  
E: Bart.Laureys@sea-invest.be

W: www.sea-invest.com  
Alongside the sea canal in the Port  
of Ghent at berth 2320.  
2\*25 metric tons cranes + 1 ship's  
belt loader.  
Draught 12.5m (FW)  
About 70,000 m2  
About 40,000 m2  
GCT is the biggest solid fuel  
terminal in Belgium with open air  
and covered storage facilities,  
equipped with several screening,  
crushing, blending and drying  
installations.

**Gent****Ghent Port Company amp**

John Kennedylaan 32  
Gent  
B-9042  
Belgium  
Contact: Mr Johan Bresseleers  
Job Title: Directorate General  
T: + 32 9 251 0550  
F: + 32 9 251 5406  
E: Johan.deraeve@havengent.be  
W: www.portofghent.be  
West Europe  
No own port cranes - cranes belong  
to private port companies  
Ghent is a modern and versatile  
medium-sized port situated in the  
centre of the Hamburg/Le Havre  
range, having an average water-  
borne cargo traffic of some 48  
million tons, 27.3 of which are  
transported overseas and 20.7  
million tons by inland waterway.

**Gent****Ghent Transport & Storage**

Henri Farmanstraat 41  
Middendok-Noordkaai 0610-0620  
Gent  
9000  
Belgium  
Contact: Mr Yves Bienfet  
Job Title: General Manager/Director  
T: + 32 9 250 5658  
F: + 32 9 251 10 52  
E: y.bienfet@gtsgent.be  
W: www.gtsgent.be  
Middendok terminals 0600-0620  
Kluizendok terminals 7110 -7140  
2 cranes : Liebherr, Sennebogen  
full panamax  
Water Depth: 13m  
Quay length: 8m  
Middendok terminal quay 0600-  
0620: 300m  
Kluizendok terminals quay 7110-  
7140: 500m quays  
20,000sqm  
67,000sqm

**Gent****Manuport NV**

178 Port Arthurlaan  
Gent  
9000  
Belgium  
Contact: Mr Bins  
T: + 32 32049 318  
F: + 32 9 218 2508  
E: info@manuport-logistics.be

**Gent****Mekol**

Henri Farmanstraat 47  
Gent  
East Flanders  
9000  
Belgium  
Contact: Mr Edvin Gogol  
Job Title: Director  
T: + 32 9 251 08 12  
F: + 32 9 251 76 41  
E: edvin.gogol@rwe.commekol@rheinbr  
aun-mekol@rheinbraun-benelux.be

**Gent****Reyniers Havenbedrijf NV**

Stapelplein 38  
Gent  
9000  
Belgium  
Contact: Ms Jo van der Hertzen  
Job Title: Marketing &  
Communications  
T: + 32 32 04 95 00  
F: + 32 32 04 93 01  
E: j.vanderherten@euroports.com  
W: www.manuportgroup.com

**Gent****Stukwerkers Havenbedrijf NV**

Port Arthurlaan 40  
Gent  
B - 9000  
Belgium  
Contact: Mr Johan De Raeve  
Job Title: Managing Director  
T: + 32 9 251 25 45  
F: + 32 9 251 61 81  
E: johan.deraeve@stukwerkers.com  
W: www.stukwerkers.com  
Port of Ghent/Belgium  
2 mobile harbour cranes of 100  
tonnes capacity  
2 mobile harbour cranes of 63  
tonnes capacity  
1 mobile crane of 25 tonnes  
capacity  
Sifferdock 830 - 840  
Sifferdock 1,000  
Puurs  
Grootdok 290 - 360  
Total quay length 3.5 km  
150,000sqm  
140,000sqm

**Kallo****Belgian Scrap Terminal NV**

Land van Waaslaan 1123  
Kallo  
Belgium  
Contact: Ms Sofie Van Peteghem  
T: +32 3575 0575  
F: +32 3575 1370  
E: info@belgianscrap.com  
W: www.belgianscrapterminal.com/

**Kallo****Metal Terminals International (MTI)**

Land van Waaslaan  
Kaai 1207  
Kallo  
B-9130  
Belgium  
Contact: Mr Fritz Lippens  
Job Title: General Manager  
T: + 32 3570 9670  
F: + 32 3570 9671  
E: mti@gearbulk.com  
W: www.mtiterminals.com  
Port of Antwerp - Left Bank  
4 x mobile crane 100 mt SWL  
2km berth. Draught 12.5m  
250,000sqm  
56,000sqm  
LME-accredited. Forwarding &  
distribution services.

**Liege****Liege Port Authority**

Quai de Maestricht 14  
Liege 4000  
Belgium  
Contact: Mr Emile-Louis Bertrand  
Job Title: Managing Director  
T: + 32 42 32 97 97  
F: + 32 4 223 11 09  
E: portdeliege@skynet.be  
W: www.portdeliege.be  
Accessible via river Scheldt and  
Albert Canal (only at 14h  
navigation from Port of Antwerp)  
102 cranes, max. 50t  
26km  
366 hectares  
150,000sqm

**Liege****Terval S.A.**

Ile Monsin, Route 10  
Liege  
B-4020  
Belgium  
Contact: Mr Dirk Schmidt-Holzmann  
Job Title: Administrator  
T: + 32 4256 9340  
F: + 32 4264 0835  
E: dsh@terval.com  
W: www.terval.com

**Oostende****Ter Polder**

Zwaaidok 2  
Oostende  
B-8400  
Belgium  
Contact: Mr Steven Verhelst  
Job Title: Shipping Manager  
T: + 32 59 331 133  
F: + 32 59 331 433  
E: steven.verhelst@verhelst.be  
W: www.verhelstlogistics.be  
Ostend, Belgium  
Cranes up to 250t  
Length 120m/ Draught 6.8m  
30,500sqm  
38,000sqm

**Puurs****SMEG Belgium NV**

Schoonmansveld 12  
Puurs  
2870  
Belgium  
Contact: Mrs Ann Smedt  
Job Title: Marketing  
T: +32 03 860 96 96  
F: + 32 03 886 0666  
E: ann.de.smedt@smeg.be  
W: www.smeg.com

**Roeselare****Van Eeckhout**

**Vervoermaatschappij**  
Trakelweg 60  
Roeselare  
8800  
Belgium  
Contact: Mr Francis Eeckhout  
Job Title: Port Director  
T: + 32 51 207313  
F: + 32 51 241310  
E: francis@vwmcm.be

**Seraing****CTB Logistics SA**

Rue du Pont du Val  
Seraing  
B-4100  
Belgium  
Contact: Mrs Muriel Baugnee  
Job Title: Marketing  
T: + 32 4240 7802 / +32 424 7814  
F: + 32 4337 1008  
E: muriel.baugnee@euroports.com  
W: www.ctblogistics.com  
Belgium - Liepe, Charleroi  
9 cranes  
200,000sqm  
95,000sqm

**Zeebrugge****Devreese & Simon NV**

Lanceloot Blondellaan 1  
Zeebrugge  
8380  
Belgium  
Job Title: General Manager  
T: + 32 50 54 40 04  
F: + 32 50 54 43 21

**Zeebrugge****Zeebrugse Behandelings**

**Maatschappij**  
Skaldenstraat 1  
Zeebrugge  
Gent

9042  
Belgium  
Contact: Mr Philippe Van de Vyvere  
Job Title: Manager  
T: + 32 50 544 095  
F: + 32 50 546 601

## BENIN

**Cotonou**  
**Port Autonome de Cotonou**  
PO Box 927  
Cotonou  
Benin  
Contact: Ms Issa Badarou  
Job Title: General Manager  
T: + 229 21 312890 / 21 31 52 80  
F: + 229 312891  
E: pac@leland.bj  
W: www.portdecotonou.com

## BERMUDA

**Hamilton**  
**Department Marine & Port Services**  
PO Box HM 180  
Hamilton  
HM AX  
Bermuda  
Contact: Mr David Simmons  
Job Title: Harbour Master  
T: + 1 441 295 6575  
F: + 1 441 295 5523  
E: dcsimmons@gov.bm

## BRAZIL

**Anchieta**  
**Port Authority of Ponta Uba**  
Rodovia do Sol s/n  
Anchieta  
ES 29230-000  
Brazil  
Contact: Mr E Drummond  
Job Title: Manager  
T: + 55 27 3361 9000  
F: + 55 27 3361 9474  
E: portodeubu@samarco.com.br  
W: www.portodeubu.com.br

**Angra dos Reis**  
**Port of Angra dos Reis**  
Avenida dos Reis Magos, s/n  
Angra dos Reis  
Rio de Janeiro  
RJ 23900-000  
Brazil  
Contact: Mr Fernando Mauricio de Lima Cavalcanti  
Job Title: Manager  
T: + 55 24 2365 0273  
F: + 55 24 2365 0273  
W: www.portosrio.gov.br

**Aracruz**  
**Portocel-Terminal Especializado de Barra do Riacho**  
Caminho da Barra do Riacho S/N  
Aracruz  
Barra do Riacho  
29197-900  
Brazil  
Contact: Mrs Patricia Dutra Lascoque  
Job Title: Director  
T: + 55 27 3270 4444  
F: + 55 27 3270 4433  
E: msc@portocel.com.br  
W: www.portocel.com.br  
Barra do Riacho, North Coast of Espírito Santo state.  
Max draught 11.90m (With tide 1.60m high)  
Max length: 213.99m  
Max beam: 35m  
Max 50,000 dwt  
- Armazém 1 = 13.500 m2 - 51.485 T

- Armazém 2 = 12.096 m2 - 45.153 T  
- Armazém 3 = 14.352 m2 - 55.072 T  
- Armazém 6 = 16.848 m2 - 71.842 T  
Portocel is the only port in Brazil which is specialized in the handling of forest products (woodpulp and logs). It belongs to two of the biggest woodpulp producers in Brazil, Aracruz (51%) and Cenibra (49%).

**Baia de Aratu**  
**Port of Aratu**  
ADB Nordeste Terminal  
Companhia das Docas do Estado da Bahia (CODEBA)  
Via Matoim, s/n  
Baia de Aratu  
CEP 43.800-000  
Brazil  
Contact: Dr Osvaldo C Magalhaes  
T: + 55 71 602 5711  
F: + 55 71 602 5705  
E: portoaratu@codeba.com.br  
W: www.codeba.com.br

**Belem**  
**Port Authority of Para**  
Avenida Presidente Vargas  
41-2 Andar  
Belem  
CEP  
66010-000  
Brazil  
Contact: Mr Carlos Acatauassu Nunes  
Job Title: Director-President  
T: + 55 91 3182 9000  
F: + 55 91 241 1741  
E: nunes@cdp.com.br  
W: www.cdp.com.br

**Belem**  
**Port of Belem**  
Companhia Docas do Para -  
Autoridade Portuaria  
Endereco Av. Marechal Hermes s/n  
Cais do Porto  
Belem  
Para  
CEP 66010-000  
Brazil  
T: + 55 91 3216 2129  
F: + 55 91 3216 2130  
W: www.cdp.com.br

**Fortaleza**  
**Port of Fortaleza**  
Praça Amigos da Marinha  
Espanhada do Mucuripe  
Fortaleza  
CE  
60 000  
Brazil  
Contact: Mr Livio Silva de France  
Job Title: Director  
T: + 55 85 263 2267  
F: + 55 85 266 5241  
E: docasdoceara@docasdoceara.com.br  
W: www.docasdoceara.com.br

**Ilheus**  
**Port of Ilheus**  
Companhia das Docas do Estado da Bahia (CODEBA)  
Rua Rotary, s/n  
Cidade Nova  
Ilheus  
Bahia  
CEP 45.650-000  
Brazil  
Contact: Mr Ronaldo Lavinha  
Job Title: Port Manager  
T: + 55 73 231-1200  
F: + 55 73 231-3318  
E: portoilheus@codeba.com.br  
W: www.codeba.com.br

**Imbituba**  
**Imbituba Port Authority**  
Av Getulio Vargas  
No 100  
Imbituba  
Santa Catarina  
88780-000  
Brazil  
Contact: Mr G B da Costa Pereira  
Job Title: Port Manager  
T: + 55 48 3255 0080  
F: + 55 48 3255 0701  
E: docas@cdiport.com.br  
W: www.cdiport.com.br

**Itaguaí**  
**CSN - Terminal de Carvão e Minério TECAR**  
Estrada da Ilha da Madeira  
s/no, Porto de Itaguaí  
Ilha de Madeira  
Itaguaí  
Rio de Janeiro  
23826-600  
Brazil  
Contact: Mr Guilherme Moretzsohn Andrade  
Job Title: Tecar Operations Manager  
T: + 55 21 2688 9338  
F: + 55 21 2688 9209  
E: guilherme.moretzsohn@csn.com.br  
W: www.csn.com.br/tecar

**Jaragua**  
**Port of Maceio**  
Rua Sa de Albuquerque  
Jaragua  
Maceio  
Alagoa 57000  
Brazil  
Contact: Mr Dominico Silva  
Job Title: Administrator  
T: + 55 82 231 1999/1790  
F: + 55 82 231 2975  
E: dominico@portodemaceio.com.br  
W: www.portodemaceio.com.br

**Manaus**  
**Port of Manaus**  
Rua Marques de Santa Cruz,  
Centro  
Manaus  
Amazonas  
AM 69005 050  
Brazil  
Contact: Mr Nelson Pedro de Aguiar Falcao  
Job Title: Port Administrator  
T: + 55 92 2123 4350  
F: + 55 92 2123 4360  
E: alecom@portodemanaua.com.br  
W: www.portodemanaua.com.br

**Município de Oriximiná**  
**Trombetas Port**  
Mineração Rio de Norte -  
Porto Trombetas  
Município de Oriximiná  
Pará State 68275-000  
Brazil  
Contact: Mr Ricardo Sarmento  
Job Title: Port Manager  
T: + 55 93 549 7029  
F: + 55 93 549 1482  
E: ricardos@mrn.com.br  
W: www.mrn.com.br  
Lat. 01°27'36"S / Long. 56°22'47"W  
Situated on the right bank of Trombetas River, state of Para, north region of Brazil.  
One Shiploader  
Capacity - 6,000tph  
One Pier - 101m length  
Draught - 38 feet maximum  
36,000sqm  
8,000sqm  
Due to restrictions for navigation on Trombetas River bends, the vessels are limited for Panamax Size up to 260m LOA.

**Natal**  
**Natal Port Authority**  
Avenida Hildebrando de Goes  
Ribeira  
Natal  
Rio Grande do Norte  
CEP 59000  
Brazil  
Contact: Mr Ivan Reis de Lima  
Job Title: Administrator  
T: + 55 84 211 5311  
F: + 55 84 221 6072  
E: codmkt@zaz.com.br  
W: www.codern.com.br

**Niteroi**  
**Port of Noiteroi**  
Avenida Feliciano Sodre 215  
Niteroi  
RJ  
24030  
Brazil  
Contact: Mr Antonio Manne  
Job Title: Manager  
T: + 55 21 718 3182  
E: gemit@portosrio.gov.br  
W: www.portosrio.gov.br/niteroi/Nitpor.htm

**Para State**  
**Port Authority of Vila Do Conde**  
Companhia Docas do Port Vila do Conde  
Para State  
Brazil  
Contact: Mr Carlos Edir  
Job Title: Port Supervisor  
T: + 55 91 3754 1027  
F: + 55 91 3754 1026  
E: edir@cdp.com.br

**Paranagua**  
**Paranagua Port Authority**  
Rua Antonio Pereira, 161  
Paranagua  
PR  
83221-030  
Brazil  
T: + 55 14 1420 1100  
F: + 55 14 1422 5324  
E: portos@pr.gov.br  
W: www.portosdoparana.pr.gov.br

**Paranagua**  
**PFT-Paranaguá Forestry Terminals**  
Rua Professor Cleto, 1372  
Leblon  
Paranagua  
Parana  
83203-070  
Brazil  
Contact: Mr Fernando Drevnovicz  
T: + 55 41 3420 1900  
F: + 55 41 3420 1903  
E: pftcom@pft-terminals.com.br  
W: www.gearbulk.com

**Paranagua**  
**Port Silo/Socopar Berths 1/2; Gansol Berth 3**  
Administracao dos Ports de Paranagua e Antonnia (Port Authority)  
Centro Administrativa Taguare  
Paranagua  
Brazil  
Contact: Mr Osiris Stenghel Guimares  
Job Title: Port Superintendent  
T: + 55 41 420 1100  
F: + 55 41 422 5324  
E: portos@pr.gov.br  
W: www.portodeparanagua.pr.gov.br

**Pelotas**  
**Port of Pelotas**  
Rua Conde de Porto Algre 1  
Pelotas  
RS 96010-290

Brazil  
Contact: Mr Jose Fernando Marques Ripoll  
Job Title: Harbour Manager  
T: + 55 53 278 7263  
F: + 55 53 278 7333  
E: portopel@sph.rs.gov.br  
W: www.portopelotas.rs.gov.br/

**Porto Alegre**  
**Port of Porto Alegre**  
Administracao do Porto de Porto Alegre  
Av Maua 1050 Centro  
Porto Alegre  
RS 90010-110  
Brazil  
Contact: Mr Paulo Elizeu Ody  
Job Title: Port Administrator  
T: + 55 51 3211 5022  
F: + 55 51 3211 5033

**Recife**  
**Port of Recife**  
Praça Comunidade Luso Brasileira no 70  
Bairro do Recife  
Recife  
PE 50030-280  
Brazil  
Contact: Mr Luiz Roberto Trindade Lobato  
Job Title: Port Director  
T: + 55 81 3419 1900  
F: + 55 81 3224 2848  
E: portodorecife@portodorecife.pe.gov.br  
W: www.portodorecife.pe.gov.br

**Rio de Janeiro**  
**Cia Docas Do Rio de Janeiro**  
Porto do Rio de Janeiro  
Av Rodrigues Alves No 20-40  
Rio de Janeiro  
CEP  
20 080 000  
Brazil  
Contact: Mr Adacio CP Carvalho  
Job Title: Port Manager  
T: + 55 21 2219-8617 /00  
F: + 55 21 2219-8618  
E: asscom@portosrio.gov.br

**Rio de Janeiro**  
**Companhia Portuaria Baia de Sepetiba**  
Rua Rodrigo Silver 26  
S2 201 Duplex Parte  
Rio de Janeiro  
CEP 2001  
Brazil  
Contact: Mr Gustavo L'Huiller  
T: + 55 21 2688 1424  
F: + 55 21 2688 1287

**Rio de Janeiro**  
**Petroleo Brasileiro SA-Petrobras**  
Avenida Republica do Chile  
65 Centro  
Rio de Janeiro  
RJ 20035  
Brazil  
Contact: Mr Luis Fernando Maya  
Job Title: Marketing Department  
T: + 55 21 3224 1510  
F: + 55 21 2262 3678  
W: www.petrobras.com.br

**Rio de Janeiro**  
**Port of Forno**  
Rua Santa Cruz No 100  
Arriai do Cabo  
Rio de Janeiro  
28930-000  
Brazil  
Contact: Mr Marcos Nau  
Job Title: Manager  
T: + 55 21 246 221185  
F: + 55 21 246 221185  
E: portodoforno@mar.com.br



**Rio de Janeiro**

**Rio de Janeiro Port Authority**  
Rua Acre 21  
Rio de Janeiro  
20081  
Brazil  
Contact: Mr A R Menezes  
Job Title: President  
T: + 55 21 2219 9542  
E: suprio@portosrio.gov.br  
W: www.portosrio.gov.br

**Rio Grande**

**Bianchini Terminal**  
Grain Terminal  
Avenida Almirante Maximian da  
Fonseca  
Sector 6 Industrial District  
Rio Grande  
RS  
96204-040  
Brazil  
Contact: Mr Carlos (CB) Bacchieri  
Job Title: Terminal Manager  
T: + 55 53 2126 6000  
F: + 55 53 2126 6011  
E: cb@bianchini-rg.com.br  
W: www.bianchinisa.com.br

**Rio Grande**

**Port of Rio Grande**  
Avenida Honrio Bicalho s/n  
Edifício Deprec  
Rio Grande  
RS 96200  
Brazil  
Contact: Mr Newton Kuintas  
T: + 55 53 3231 1366  
E: nquintas@portoriogrande.com.br  
W: www.portoriogrande.com.br

**Salvador**

**Port Authority of Salvador**  
Companhia das Docas do Estado da Bahia  
Av. da Franca, 155 I, Comercio  
Salvador  
Bahia  
CEP 40.010-000  
Brazil  
Job Title: Port Director  
T: + 55 71 320 1299  
F: + 55 71 320 1268  
E: portosalvador@codeba.com.br  
W: www.codebra.com.br

**Santos**

**Companhia Docas do Estado de São Paulo - CODESP**  
Avenida Conselheiro Rodrigues  
Alves, s/nº - Macuco  
Santos  
São Paulo  
CEP 11015-900  
Brazil  
Contact: Mr José Di Bella Filho  
Job Title: Director-President  
T: + 55 13 3222 5485  
F: + 55 13 3222 3068  
E: di\_bella@uol.com.br  
W: www.portodesantos.com.br  
Southeast coast of Brazil in the  
State of São Paulo  
The Santos Port static capacity is  
110 million tonnes. For dry bulk  
operation state of art equipment is  
available to handle products in  
export and import hands. The total  
static capacity for dry bulk  
operation in the Organized Port is  
43,9 million tonnes.  
58 berths including 14 specialized  
berths for dry bulk.  
500,000sqm  
1,000,000sqm  
The port operated in 2006 a total of  
US\$ (FOB) 60,6 billion in cargo  
value.



**Santos**

**Port of Santos**  
Companhia Docas do Estado de  
Sao Paulo  
Avenida Rodrigues Alves s/n  
Santos  
Sao Paulo  
11015-900  
Brazil  
Contact: Mr Sergio Aquino  
Job Title: Port Operator  
T: + 55 133 202 6565  
F: + 55 133 233 3080  
E: seaport@santos.sp.gov.br  
W: www.portodesantos.com

**Santos**

**Tropical Agencia Marítima Ltda.**  
4th floor  
Rua do Comercio, 55  
Santos  
Sao Paulo  
11010-141  
Brazil  
Contact: Mr Francisco Garcia  
Job Title: CEO  
T: + 55 13 3213 8842  
F: + 55 13 3219 2550  
E: tropical@tropmar.com.br  
W: www.tropmar.com.br  
Santos - South East Brazil  
14 Grabs - from 4 to 15 m3  
capacity  
2 Mobile hoppers of 35 m3  
capacity  
800 m2  
Mobile operation with grabs and  
hoppers attending most Brazilian  
ports.

**Sao Francisco do Sul**

**Sao Francisco do Sul Port  
Authority**  
Ave Eugenio  
Leite  
Ribeiro  
Sao Francisco do Sul  
782  
Brazil  
Contact: Mr Ulisses Tavares Lopes  
Job Title: Commercial Manager  
T: + 55 47 34 71 12 00  
F: + 55 47 34 71 12 11  
E: porto@apsfs.sc.gov.br  
W: www.apsfs.sc.gov.br

**Sao Luis**

**Port of Ponta da Madeira**  
Avenida dos Portugueses s/n  
Praia do Boqueirao  
Sao Luis  
Maranhao  
65085 580  
Brazil

Contact: Mr Alvaro de Oliveira Jnr  
Job Title: Port Superintendent  
T: + 55 98 218 4263  
F: + 55 98 218 4019

**Sao Paulo**

**Coinbra - Grain**  
Avenida Brigadeiro Faria Lima,  
1355  
14º Andar  
Pinheiros CEP  
Sao Paulo  
01451 903  
Brazil  
Contact: Ms. Marcia Amorim  
Job Title: Marketing  
T: + 55 11 3039 6700  
F: + 55 11 3814 3235  
W: www.louisdreyfus.com

**Vitoria**

**Capuaba Quay Grain  
Terminal/Port of Vitoria**  
Ave Getulio Vargas 556  
Centro  
Vitoria  
ES 29020  
Brazil  
Contact: Mr Dirceu Cardoso  
Job Title: Port Director  
T: + 55 27 221 311  
F: + 55 27 227 360  
E: falaporto@codesa.gov.br  
W: www.portodevitoria.com.br

**Vitoria**

**Port Authority of Espirito Santo**  
Avenida Getulio Vargas No 556  
Vitoria  
Espirito Santo  
29000  
Brazil  
Contact: Mr Jose Luiz Canjelo de  
Franca  
Job Title: Marketing  
T: + 55 27 2132 7342  
F: + 55 27 3132 7343  
E: comark@codesa.gov.br  
W: www.portodevitoria.com.br

**Vitoria**

**Tubarao Port Authority**  
c/o Companhia Vale do Rio Doce  
Porto de Tubarao  
Vitoria  
Espirito Santo  
Brazil  
Job Title: Port Manager  
T: + 55 273 35 5624  
F: + 55 273 35 5293  
E: info@cprd.com.br  
W: www.cprd.com.br

**BULGARIA**

**Bourgas**

**Bulk Terminal 2A**  
Port of Bourgas JSC  
1 Al. Battenberg Str.  
Bourgas  
8000  
Bulgaria  
Contact: Mr Dimitar Terziev  
Job Title: Manager  
T: + 359 56 822 400  
F: + 359 56 822 156  
E: headoffice@port-burgas.com  
W: www.port-burgas.com

**Bourgas**

**Port of Bourgas JSC**  
1, Prince Alexander Battenberg  
Street  
Bourgas  
8000  
Bulgaria  
Contact: Mr Stoycho Dimov  
Job Title: Chief FR, Marketing, QA  
Dpt  
T: + 359 56 822 345  
F: + 359 56 822 156  
E: st\_dimov@port-burgas.com  
W: www.port-burgas.com  
South East of Bulgaria on Black  
Sea Coast  
Bulk Cargoes terminal / capacity -  
6 million tons.  
Stwertell Screw Unloader - 1  
Cheretti Tanfani Grab Gantry  
unloader - 1  
Forklift Trucks - 3  
Front Loaders - 10  
Telescopic Hold Cleaners - 2  
Conveyor Belts - 9  
Bulk Reclaimers - 3  
Bulk Stackers - 2  
Bulk Wagon Loading Station - 1  
Truck Scales - 2

Terminal 2A  
Grab Gantry Unloaders, 1,200 t/h  
each - 2  
Conveyor Belts - 14  
Grab Gantry Unloaders - 1,200 t/h  
each - 2  
Small Size Front Loaders (hold  
work) - 4  
Wagon Weighing Bridge - 1  
Wagon Loading Station - 2 lines per  
600 t/hour - 1  
Stacker/Reclaimer - 1  
Stackers - 2  
Reclaimer - 1  
Capacity 6 million tons  
Mooring Berths 4  
Total Wharf Length 817 m  
Allowable Draught 15.50 m

Open Storage 108,000 sqm  
Total area 268,000 sqm  
268,000sqm  
160,000sqm

**CAMBODIA**

**Sihanoukville**

**Sihanoukville Autonomous Port  
(PAS)**  
Vithei Phe  
Sihanoukville  
Preah Sihanouk Province  
Cambodia  
Contact: Mr Lou Kim Chhun  
Job Title: Director General  
T: + 855 34 933 416 / 34 933 511  
F: + 855 34 933 693 / 34 933 739  
E: admin@pas.gov.kh  
W: www.pas.gov.kh

**CAMEROON**

**Douala**

**Cameroon National Ports  
Authority**  
PO Box 4002  
Maritime Affairs Centre  
Douala  
Cameroon  
Contact: Mr Tchouta Moussa  
Job Title: General Manager  
T: + 237 342 0133  
F: + 237 426797  
E: onpc@camnet.cm

**Douala**

**Delmas Cameroon (CMA-CGM  
Group)**  
Cameroon National Ports Authority  
5 Boulevard Leclerc  
Douala  
BP 4020  
Cameroon  
Contact: Mr Markous Mono Mboum  
Job Title: General Port Manager  
T: +237 33 42 49 65  
F: + 237 3343 1300 / 2 8836  
E: dlo.cfandeu@african-agency.com  
W: www.otal.com/cameroon/index.htm

**CANADA**

**Becancour**

**Becancour Waterfront Industrial  
Park**  
1000 Boulevard Arthur-Sicard  
Industrial Park & Port  
Becancour  
Quebec  
G9H 2Z8  
Canada  
Contact: Ms Manon Blais  
Job Title: Harbour Master  
T: + 1 819 294 6656  
F: + 1 819 294 9020  
E: blais@spipb.com  
W: www.spipb.com  
South shore of the St. Lawrence  
River, halfway between Montreal  
and Quebec.  
Railway/ Scales/ Ro-Ro Ramp.  
Depth = 35ft.  
Berth 1 = 244m, Berth 2 = 150m,  
Berth 3 = 219m, Berth 4 = 214m,  
Berth 5 = 292m.  
100,000sqm  
Year-round access.  
Near Highways 30, 55, 40, 20.  
Connected to the North American  
road network.

## Belledune

### Port of Belledune



112 Shannon Drive  
Belledune  
New Brunswick  
E8G 2W2  
Canada  
Contact: Ms Jenna MacDonald  
Job Title: Director of Marketing  
T: + 1 506 522 1204  
F: + 1 506 522 0803  
E: macdonald@portofbelledune.ca  
W: www.portofbelledune.ca  
NE Coast of New Brunswick on  
Chaleur Bay  
Mobile/Fixed Covered Conveyors &  
Hoppers +/- 1,200 to 1,800tph.; Rail  
Mounted Ship Load/Unloaders +/-  
1,200 to 1,800tph; Mobile Cranes  
+/- 50t to +/-165t; Front End  
Loaders & Forklifts (cap. varied).  
Term. # 1 = 155m X 15m X 10.4 m;  
Term. # 2 = 307m X 28m X 14.4m;  
Term. # 3 = 455m X 15m X 9.9m  
(West) to 11.2m (East); Term. # 4  
Combination Ro-Ro/Barge; Ro-Ro  
Wharf = 184m X 31m X 9.0m; Ro-  
Ro Ramp = 19.2 m X 27.18 m;  
Barge Wharf = 122m X 31m X  
7.0m;  
+/- 6,000,000sqm  
+/- 15,000sqm

## Burlington

### Lloyd's Register

3050 Harvester Road  
Suite 208  
Burlington  
Ontario  
L7N 3J1  
Canada  
Contact: Mr Lori Malone  
Job Title: Marketing  
T: + 1 281 675 3100  
E: barry.shepherd@lr.org

## Churchill

### Hudson Bay Port Terminal

PO Box 217  
Churchill  
Churchill  
Manitoba  
ROB OEO  
Canada  
Contact: Captain Irvin Sawatzky  
Job Title: Director, Marine Ops  
T: + 1 204 675 8823 ext. 206  
F: + 1 204 675 2550  
E: i.sawatzky@omnitrix.com

## Contrecoeur

### Logistec

1920 Marie Victorin  
Contrecoeur  
Quebec  
JOL 1C0  
Canada  
Contact: Mr Philippe Desgagnés  
Job Title: Director of Operations  
T: + 1 450 587 2073  
F: + 1 450 587 8570

E: pdesgagn@logistec.com  
W: www.logistec.com  
St Laurence River, East of Montreal  
Two gantry crane 34 MT  
Two berth  
45,000sqm  
3,500sqm

## Contrecoeur

### Terminal Maritime Contrecoeur Inc

1920 Marie Victorin  
Contrecoeur  
Quebec  
JOL 1C0  
Canada  
Contact: Mr Norman Desjardins  
Job Title: General Manager  
T: + 1 450 587 2073  
F: + 1 450 587 8570  
E: ndesjard@logistec.com  
W: www.logistec.com  
St. Lawrence River, Quebec,  
Canada  
2 gantry cranes  
228.9m

## Corner Brook

### Corner Brook Port Corporation

R.A. Pollett Building  
61 Riverside Drive  
Corner Brook  
Newfoundland  
A2H 6T2  
Canada  
Contact: Ms Jacqueline Chow  
Job Title: Port Manager & CEO  
T: + 1 709 634 6600  
F: + 1 709 634 6620  
E: info@cornerbrookport.com  
W: www.cornerbrookport.com/

## Dartmouth

### Port Authority of Georgetown

Transport Canada  
PO Box 1013  
Dartmouth  
Nova Scotia  
B2Y 4K2  
Canada  
Contact: Mr W Chiasson  
Job Title: Harbour Manager  
T: + 1 902 426 2588  
F: + 1 902 426 6334  
E: DSchronce@SCSPA.com

## Delta

### Westshore Terminals

1 Roberts Bank  
Delta  
British Columbia  
V4M 4G5  
Canada  
Contact: Mr Denis Horgan  
Job Title: Vice President and  
General Manager  
T: + 1 604 946 3400  
F: + 1 604 946 1388  
E: horgan@westshore.com  
W: www.westshore.com  
30 km south of Vancouver, BC,  
Canada  
4 Stackers/Reclaimers, 2 rotary  
railcar dumpers, 2 berths - rated

capacity 29 million tpa  
2.0 million mt  
None  
Currently North America's busiest  
coal export terminal. In the process  
of replacing the single rotary  
dumper with a double rotary and  
adding 3 new train indexers.  
Capacity will be 33 million tonnes  
upon completion in late 2012.

## Goderich

### Southpier Terminals Limited

230 Harbour Street  
Goderich  
Ontario  
N7A 3Y5  
Canada  
Contact: Mr Calvin Kerr  
Job Title: Manager  
T: + 1 519 524 7367  
F: + 1 519 524 7995  
E: ckerr@southpier.ca

## Guelph

### Parrish & Heimbecker

Suite 205  
150 Research Lane  
Guelph  
Ontario  
N1G 4T2  
Canada  
Contact: Mr Matt Gardner  
Job Title: Operations Mgr Eastern  
Canada  
T: + 1 519 780 4954  
E: mgardner@  
parrishandheimbecker.com  
W: www.parheim.mb.ca  
Great Lakes  
1,000mtp handling  
4 full berths at seaway depth  
2ha  
50,000mt grain capacity

## Halifax

### Halifax Grain Elevator Ltd

951 South Bland Street  
Halifax  
Nova Scotia  
B3H 4S6  
Canada  
Contact: Mr Robert L White  
Job Title: Operations Manager  
T: + 1 902 421 1714 x 15  
F: + 1 902 420 0343  
E: rwhite@halifaxgrain.com

## Halifax

### Halifax Port Corporation

PO Box 336  
Halifax  
Nova Scotia  
B3L 1K4  
Canada  
Contact: Mr George Malec  
Job Title: Vice President - Business  
Development & Operations  
T: + 1 902 426 2620  
E: ccarter@portofhalifax.ca  
W: www.portofhalifax.ca

## Hamilton

### Hamilton Port Authority

605 James Street North  
Hamilton  
Ontario  
L8L 1K1  
Canada  
Contact: Mr Ian Hamilton  
Job Title: VP, Business  
Development  
T: + 1 905 525 4330  
F: + 1 905 528 6554  
E: ihamilton@hamiltonport.ca  
W: www.hamiltonport.ca  
Western End of Lake Ontario  
43 17' North 79 50' West  
Hamilton is the largest Canadian  
Great Lakes Port serving the  
Southern Ontario region and  
surrounding area.

## Hamilton

### Richardson International Ltd

155 Eastport Blvd  
Hamilton  
Ontario  
L8H 7S3  
Canada  
Contact: Mr Riley Verhelst  
Job Title: Director of Operations  
T: + 1 905 314 7650  
F: + 1 905 545 8913  
E: Riley.Verhelst@richardson.ca  
W: www.richardson.ca  
Pier 25 N Hamilton, Ontario,  
Canada

## La Baie

### Alcan Primary Metal Group

262 1st Street  
La Baie  
Quebec  
G7B 3R1  
Canada  
Contact: Mr Louis Bruneau  
Job Title: Port Agent  
T: + 1 418 544 9674  
F: + 1 418 544 9622  
E: PA.agency@alcan.com

## Milford

### National Gypsum Co Ltd

PO Box 57  
Milford  
Nova Scotia  
BON 1Y0  
Canada  
Job Title: Terminal Operator  
T: + 1 902 883 2224  
F: + 1 902 758 3955  
E: info@ngcl.com  
W: www.nationalgypsum.com

## Montreal

### Federal Marine Terminals

Suite 3500  
1000 de la Gauchetiere Street West  
Montreal  
Quebec  
H3B 4W5  
Canada  
Contact: Mr Mike Kirkpatrick  
Job Title: Vice President Sales &  
Marketing

T: + 1 905 528 8741  
F: + 1 905 528 9332  
E: mkirkpatrick@fedmar.com  
W: www.fmtcargoc.com

## Montreal

### Les Silos Port-Cartier

360 rue St-Jacques  
Montreal  
Quebec  
H2Y 1P5  
Canada  
Contact: Mr Richard Bridgeman  
T: + 1 514 844 9391  
F: + 1 514 844 0588

## Montreal

### Logistec Corporation

360 St Jacques  
Suite 15000  
Montreal  
Quebec  
H2Y 1P5  
Canada  
Contact: Mr George di Sante  
T: + 1 514 844 9381  
F: + 1 514 842 1262  
E: gdisante@logistec.com  
W: www.logistec.com  
Logistec Stevedoring Inc. is one of the  
largest cargo handling companies in  
Eastern Canada and has a network of  
strategically located facilities across  
Eastern Canada, the Great Lakes,  
and the United States East Coast.  
For more detailed information on each  
of the individual sites, please visit our  
web site at www.logistec.com.

## Montreal

### Montreal Port Authority (Grain Terminal)

Port of Montreal Building  
2100 Pierre-Dupuy Ave, Wing 1  
Montreal  
Quebec  
H3C 3R5  
Canada  
Contact: Mr Réal Bélanger  
Job Title: Director, Growth and  
Development, Grain & Bulk  
T: + 1 514 283 1313  
F: + 1 514 283 1858  
E: belangerr@port-montreal.com  
W: www.port-montreal.com  
Section #54 at The Montreal Port  
Authority  
Unloading: 3,000 tph / Loading:  
5,500 tph  
Length: 395m / Depth: 11.3m /  
Beam: 36m  
262,000mt  
Operation: Year-round.  
We have 2 Rotary Screen Cleaner  
for a capacity of 24,000bph.

## Montreal

### Port of Montreal Authority

Port of Montreal Building  
2100 Pierre-Dupuy Avenue, Wing 1  
Montreal  
Quebec  
H3C 3R5  
Canada

PORT OF DE  
BELLEDUNE

# Explore the World through us...

[www.portofbelledune.ca](http://www.portofbelledune.ca)

112 promenade Shannon Drive |  
Belledune NB | E8G 2W2 | Canada

T. +1.506.522.1200 F. +1.506.522.0803





Contact: Mr Tony Boemi  
 Job Title: Director, Growth & Development, Grain & Bulk  
 T: + 1 514 283 1313  
 F: + 1 514 283 0829  
 E: belangerr@port-montreal.com  
 W: www.port-montreal.com  
 Canadian East Coast  
 See website:  
 www.port-montreal.com  
 One of the fastest and most efficient grain-handling facilities in Canada, the Port of Montreal grain terminal is geared primarily to international markets. Open year-round and featuring a total storage capacity of 260,000 tonnes, the terminal is multifunctional.

**Montreal**

**Strudes Inc**  
 1440 Sainte Catherine St  
 Suite 905  
 Montreal  
 Quebec  
 Canada  
 Contact: Mr Henry Nowodworski  
 Job Title: President  
 T: + 1 514 731 6951 x 123  
 F: + 1 514 737 4146  
 E: nowodworski@strudes.ca  
 W: www.strudes.ca

**North Vancouver**

**Kinder Morgan Canada Terminals Limited Partnership**  
 1995 West First Street  
 North Vancouver  
 BC  
 V7P 1A8  
 Canada  
 Contact: Mr Tim Ayling  
 Job Title: Director of Marketing and Sales  
 T: + 1 604 904 7206  
 F: + 1 604 982 7113  
 E: Tim\_Ayling@kindermorgan.com  
 W: www.kindermorgan.com  
 West coast of British Columbia, Canada on the Pacific Ocean  
 5 Panamax berths with draught of about 11m or more.  
 190,000 MT for sulphur  
 35,000sqm for pulp  
 30,000 MT for agri bulk  
 500,000 MT for mineral concentrates  
 1 million gallons for liquids  
 Very modern, multi-product terminal. 5 berths, 111-acre site.

**North Vancouver**

**Neptune Bulk Terminals (Canada) Ltd**  
 PO Box 86367  
 North Vancouver  
 BC  
 V71 4K6  
 Canada  
 Contact: Mr Tony Nardi  
 Job Title: VP Marketing & Transportation  
 T: + 1 604 985 7461  
 F: + 1 604 985 8941  
 E: tnardi@nbtcl.bc.ca  
 W: www.neptuneterminals.com  
 In Vancouver's inner harbour  
 Dry Bulk: 4 continuous loop tracks  
 Two, three-car dumpers for covered-bottom hopper cars  
 Semi-automated rail car opening system  
 Up to 124 cars per train  
 World's largest portal reclaimers for fertilizers (rated up to 3,000tph continuous operation, twin rakes)  
 Fragile product handling (agricultural products)  
 Coal: Continuous loop-track system  
 Fully enclosed rotary dumper  
 Up to 124 rail cars per train  
 Rail mounted Stacker/Reclaimer:

3,600tph  
 600,000 tonnes open storage  
 Berth 1 (Coal): Dock face: 230m (753 ft.), plus bollards & dolphins  
 Draught alongside: 15.2m (50 ft.) at zero tide  
 Vessel capacity: 180,000 dwt (Capesize)  
 Will load up to 194,000 dwt (on request)  
 Historical maximum cargo load: 173,000 tonnes  
 2 Quadrant shiploaders: 2,700tph each  
 Air draught: 19m  
 Berth 2 (Dry Bulk): Dock face: 230m (753 ft.), plus bollards & floating dolphins  
 Draught alongside: 13.7m (45 ft.)  
 Vessel capacity: 80,000dwt (Panamax)  
 Air draught: 19m  
 Chokefeeder hatch loading system  
 2 Quadrant shiploaders: 2,200tph each  
 Cascade spouts for dust control and to minimize product degradation  
 Berth 3 (Dry Bulk): Dock face: 250m between bollards  
 Draft alongside: 13.0m (43 ft.)  
 Vessel capacity: 65,000dwt  
 Air draft: 17.7m  
 Krupp linear travelling shiploader (dry bulk)  
 Loading rates: 2,500tph-potash; 1,200tph-agricultural  
 Strongco tube conveyor  
 2 Inbound hoppers: 1,800tph receiving capacity  
 Choke feeder hatch loading system  
 200,000 tonnes for potash. 4,000 tonnes for alfalfa. Potential for 33,000 tonnes bin agricultural storage (on customer contractual demand)

**North Vancouver**

**Richardson International Ltd**  
 375 Low Level Road  
 North Vancouver  
 BC  
 V7L 1A7  
 Canada  
 Contact: Mr Phillip Hulina  
 Job Title: Director of Operations  
 T: + 1 604 987 8855  
 F: + 1 604 987 9532  
 E: phil.hulina@pgtl.ca  
 W: www.richardson.ca

**Nova Scotia**

**Port of Hantsport**  
 Transport Canada  
 PO Box 208  
 Nova Scotia  
 B0P 1P0  
 Canada  
 Contact: Ms Jeff Lawrence  
 Job Title: Chief Administrative Officer  
 T: + 1 902 684 3210  
 F: + 1 902 426 3904  
 E: Jeff@hantsportnovascotia.com  
 W: www.hantsportnovascotia.com

**Oshawa**

**Oshawa Harbour Commission**  
 1050 Farewell Street  
 Oshawa  
 Ontario  
 L1H 6N6  
 Canada  
 Contact: Ms Donna Taylor  
 T: + 1 905 576 0400  
 F: + 1 905 576 5701  
 E: portoshawa@bellnet.ca  
 W: www.oshawaportauthority.com

**Ottawa**

**Portha Inc**  
 25 Noel Street

Ottawa  
 ON  
 K1M 2A4  
 Canada  
 Contact: Mr Raymond Gaudreault  
 T: + 1 613 833 0981  
 F: + 1 613 833 0982  
 E: rgaudreault@portha.ca

**Ottawa**

**Transport Canada**  
 Surface Infrastructure Programs (AHSB)  
 330 Sparks Road  
 Place de Ville - Tower C 18th Floor  
 Ottawa  
 Ontario  
 K1A 0N5  
 Canada  
 Job Title: Operations Officer  
 T: + 1 613 990 2309  
 F: + 1 613 998 8620  
 E: webfeedback@tc.gc.ca

**Owen Sound**

**Great Lakes Elevator**  
 1499 First Avenue West  
 Owen Sound  
 Ontario  
 N4K 5P1  
 Canada  
 Contact: Mr Gary Shipley  
 Job Title: Operations Manager  
 T: + 1 519 376 2754 x 3  
 F: + 1 519 376 8292  
 E: info@greatlakeslevator.com  
 W: http://greatlakeslevator.com/

**Parrsboro**

**Port Authority of Parrsboro**  
 PO Box 680  
 Parrsboro  
 Nova Scotia  
 B0M 1S0  
 Canada  
 Contact: Mr C G Wood  
 Job Title: Harbour Master  
 T: + 1 902 254 2513  
 F: + 1 902 254 3260  
 E: town@town.parrsboro.ns.ca  
 W: www.town.parrsboro.ns.ca

**Port Cartier**

**Les Silos Port Cartier**  
 CP 400  
 188 Portage des Mousses  
 Port Cartier  
 Quebec  
 G5B 2G9  
 Canada  
 Contact: Mr Allen Tupper  
 T: + 1 418 766 2515  
 F: + 1 418 766 4136  
 E: allen.tupper@ldcommodities.com  
 North shore of St Lawrence - Gulf of St Lawrence  
 6 loading spits. 2,800tph average  
 1470' of bearth for load/unload  
 280,000t

**Port Colborne**

**Port Colborne Grain Terminal**  
 PO Box 129  
 Port Colborne  
 Ontario  
 L3K 5V8  
 Canada  
 Contact: Mr Joe Lannan  
 Job Title: Manager  
 T: + 1 905 834 3644  
 F: + 1 905 834 7816  
 E: jlannan@goderichelevators.com  
 West side at the mouth of welland canal  
 2 loading spouts (1200tph), self unloading hopper (600tph)  
 700 ft dock wall  
 76,000 mt of storage space

**Prescott**

**Port of Prescott**  
 Ports Canada  
 PO Box 520  
 River Road East  
 Prescott  
 Ontario  
 KOE 1T0  
 Canada  
 Contact: Mr Robert Hennessy  
 Job Title: General Manager  
 T: + 1 613 925 4228  
 F: + 1 613 925 5022  
 E: info@portofprescott.com  
 W: www.portofprescott.com

**Prince Rupert**

**Prince Rupert Port Authority**  
 200-215 Cow Bay Road  
 Prince Rupert  
 British Columbia  
 V8J 1A2  
 Canada  
 Contact: Mr Maynard Angus  
 T: + 1 250 627 8899  
 F: + 1 250 627 8980  
 E: mangus@rupertport.com  
 W: www.rupertport.com

**Prince Rupert**

**Prince Rupert, Ridley Island Grain Elevator**  
 PO Box 877  
 Prince Rupert  
 British Columbia  
 V8J 3Y1  
 Canada  
 Contact: Mr Jeff Burghardt  
 T: + 1 250 627 8777  
 F: + 1 250 627 8541  
 E: edouglas@prgrain.bc.ca

**Prince Rupert**

**Ridley Terminals Inc**  
 2110 Ridley Island  
 PO Bag 8000  
 Prince Rupert  
 BC  
 V8J 4H3  
 Canada  
 Contact: Mr Dennis Blake  
 Job Title: Senior Manager  
 T: + 1 250 624 9511  
 F: + 1 250 624 2389  
 E: dblade@rti.ca  
 W: www.rti.ca  
 North West coast of British Columbia, 500 miles north of Vancouver.  
 12 million tonne dry bulk capacity  
 250,000dwt capable, 22 metre draught  
 1.5 million tonnes  
 None  
 Two 20,000t liquid storage tanks and partially completed liquid unloading facilities also on site.

**Quebec City**

**Bunge of Canada Elevator**  
 300 Dalhousie Street  
 PO Box 2537  
 Station Terminus  
 Quebec City  
 Quebec  
 G1K 7R3  
 Canada  
 Contact: Mr Steve Cantin  
 T: + 1 418 692 0217  
 F: + 1 418 692 0182  
 E: steve.cantin@bunge.com

**Quebec City**

**Quebec Port Authority**  
 150 Dalhousie St  
 PO Box 80  
 Station Haute-Ville  
 Quebec City  
 Quebec  
 G1R 4M8  
 Canada

Contact: Mr Patrick Robitaille  
 Job Title: Director - Marketing  
 T: + 1 418 648 3640 x1108  
 F: + 1 418 648 4160  
 E: patrick.robitaille@portquebec.ca  
 W: www.portquebec.ca  
 1300 km from the Atlantic Ocean on the St.Lawrence River

**Quebec City**

**Sillery Distribution Center Inc.**  
 1111 Champlain Boulevard  
 Quebec City  
 Quebec  
 G1K 0A2  
 Canada  
 Contact: Mr Stephen Leonard  
 Job Title: General Manager  
 T: + 1 418 687 7504  
 F: + 1 418 687 0169  
 E: stephen.leonard@cds-sillery.ca  
 W: www.cargill.ca

**Quebec City**

**St Lawrence Stevedoring**  
 Div of Quebec Stevedoring Company Ltd  
 961 Boulevard Champlain  
 Quebec City  
 Quebec  
 G1K 4J9  
 Canada  
 Contact: Mr Geoff Lemont  
 Job Title: Vice-President  
 T: + 1 418 522 4701  
 F: + 1 418 522 9770  
 E: glemont@qsl.com  
 W: www.qsl.com  
 On St Lawrence River  
 Latitude 46° 50' 00" N  
 Longitude 71° 12' 00" W  
 Pneumatic unloader  
 5 portal cranes. Ship loader - up to 150,000 tpd  
 Berths 250 to 325m each  
 Depth - 12.5 to 15.5m  
 300,000sqm  
 17,000sqm

**Regina**

**Viterra Inc**  
 2625 Victoria Avenue  
 Regina  
 Saskatchewan  
 S4T 7T9  
 Canada  
 Contact: Mr Bob Miller  
 Job Title: Senior Vice-President, Grain, North America  
 T: + 1 866 569 4411  
 F: + 1 306 569 4715  
 E: investor@swp.com  
 W: www.viterra.ca  
 (1) Canadian West Coast/North Vancouver, British Columbia; and (2) Canadian Great Lakes, St. Lawrence Seaway, Thunder Bay, Ontario and (3) Montreal (leased)  
 Two ship berths at each location  
 Storage Capacity: (1) 237,240mt capacity (2) 362,650mt capacity (3) 262,000mt capacity  
 -Both Vancouver, BC and Thunder Bay, ON bulk grain terminals are serviced by Canadian National Railway.  
 -Montreal facility is leased

**Saint John**

**Saint John Port Authority**  
 111 Water Street  
 Saint John  
 New Brunswick  
 E2L 0B1  
 Canada  
 Contact: Ms Britney Kitchen  
 Job Title: Cargo Development and Marketing Specialist  
 T: + 1 506 636 4869  
 F: + 1 506 636 4443  
 E: sblanchard@sjport.com  
 W: www.sjport.com



On the Bay of Fundy east coast of Canada.  
 110 km from the border with USA,  
 771km from Montreal and 1,318 km from Toronto by rail.  
 Two 45-tonne Portainer Cranes at Rodney Container Terminal.  
 Barrack Point Potash Terminal has quadrant loader with a loading capacity of 2,700tph  
 Two 45-tonne Gantry Cranes at Rodney Container Terminal.  
 Navy Island Terminal is equipped for Starboard quarter ramps and stern ramps. Specialized equipment to handle Forest Products.  
 Rodney Terminal:  
 Slip berth Length 291 m, depth 12.2 m  
 Marginal berth Length 369 m, depth 12.2 m  
 American Iron and Metal Terminal  
 Berth Length 202 m, depth 12.2 m  
 Navy Island Terminal:  
 1A & 1B Length 378m, depth 10.4m  
 2B Length 190m, depth 10.4m  
 3A & 3B Length 313m, depth 10.4m  
 Long Wharf Terminal:  
 Berth length 285 m, depth 10.7m  
 Lower Cove Terminal:  
 Berth length 225 m, depth 10.7 m  
 Barrack Potash Terminal  
 Berth length 290 m, depth 13 m  
 164 acres  
 82,000sqm



# SPEARHEAD

## A FORERUNNER ON THE TIDES OF CHANGE

Being North America's largest iron ore port is much more than just a rank—it's a responsibility. And we take it on with pride and determination: pride that relies on the reputations of our clients and partners, without whom we wouldn't exist, and determination that pushes us to achieve the highest levels of certification—in other words, to be and remain up to the challenge.

24/7 FULL SERVICE | + 1 418 968-1231 | PORTSI.COM



Saint John is an ice-free, deep-water port with modern specialized facilities. On dock rail available with competing lines, and direct highway access from each terminal.

### Salaberry-de-Valleyfield

#### Valport Maritime Services Inc.

950 Boul. Gerard- Cadieux,  
 Salaberry-de-Valleyfield  
 Quebec  
 J6T 6L4  
 Canada

Contact: Mr J. Frank Dunn

Job Title: President

T: + 1 450 377 6686

F: + 1 450 377 2521

E: frank@valport.ca

W: www.valport.ca/

70 km west of Montreal, in the St Lawrence Seaway.

Crane, Conveyors.

Shiploading up to 1,000tph

Berth 1107, 1,105 metres of docks

115,000 sf

145,000 sf

The only independent municipal port in Canada.

Can accommodate up to 4 Seaway suitable cargo vessels at any one time. Ro/Ro ramp.

### Saskatoon

#### Canpotex Limited

PO Box 1600

Saskatoon

SK

S7K 3R7

Canada

Contact: Mr Scott Rudderham

Job Title: Senior Vice President, Operations

T: + 1 306 931-2200

F: + 1 306 653-5505

E: corporate@canpotex.com

### Sept-Îles

#### Iron Ore Company of Canada

PO Box 910

Sept-Îles

Quebec

G4R 4L2

Canada

Contact: Mr Jilles B

Job Title: Coordinator

T: + 1 418 968 7540

F: + 1 418 968 7113

E: Harold.Hogan@ironore.ca

W: www.ironore.ca

### Sept-Îles

#### Portier Express Inc

315 Ave Otis



Sept-Iles  
Quebec  
G4R 1K9  
Canada  
Contact: Mr Denis Gagnon  
Job Title: General Manager  
T: + 1 418 962 3073  
F: + 1 418 962 3067  
E: dgagnon@porlier.com  
W: www.porlier.com

**Sept-Iles**  
**Sept-Iles Port Authority**



1 Quai Mgr- Blanche  
Sept-Iles  
Quebec  
G4R 5P3  
Canada  
Contact: Ms Patsy Keays  
Job Title: Director of Corporate Affairs  
T: + 1 418 961 1235  
F: + 1 418 962 4445  
E: pkeays@portsi.com  
W: www.portsi.com  
Sept-Iles is located on the north shore of the St-Lawrence River 287 NM east of Quebec City, Canada.  
- mobile dry bulk conveyors (600 - 1000 Mtp, depending on cargo)  
- stacker  
- 4 ship loaders (5 000 Mtp capacity)  
- 2 hangars  
- Railcar ferry dock with mobile ramp  
Berth No 2 dock, Length 488m, Depth 18m (owned by Iron Ore

Company of Canada/Rio Tinto)  
Berth No 4 & 5 dock, Length 487m, Depth 11m (owned by Iron Ore Company of Canada/Rio Tinto)  
Berth No 7 dock, Length 183m, Depth 8.5m  
Berth No 8 dock, Length 98m, Depth 12m  
Berth No 14 & 15 dock, Length 244m, Depth 8m  
Berth No 30 & 31 dock, Length 631.5m, Depth 16m (No 30), 12m (No 31)  
Berth 40 dock, Length 260m, Depth 14m  
Berth 41 dock, Length 200m, Depth 8.5m or 11m (with fenders) 208,241sqm 15,200sqm  
Other commodities handled: Coke breeze, fuel, bunker, limestone, bentonite, alumina, aluminium

**Sept-Iles**

**Tessier Ltd**  
265, rue des Pionniers  
Sept-Iles  
Quebec Province  
G4R 4K2  
Canada  
Contact: Mrs Oddepe  
Job Title: Managing Director  
T: + 1 418 962 3639  
F: + 1 418 968 6910  
E: info@tessier.desgagnes.com  
W: http://www.tessiertee.com/

**Sept-Iles**

**Wabush Mines**  
1505 Point Noire  
Sept-Iles  
Quebec Province  
G4R 4L4  
Canada  
Contact: Mr Daniel Lebert  
Job Title: General Manager  
T: + 1 418 962 5131  
F: + 1 418 962 0209

**Sorel-Tracy**

**Richardson International (Quebec)**  
10 Rue de la Reine  
Sorel-Tracy  
Quebec  
J3P 4R2  
Canada  
Contact: Mr Serge Laperriere  
Job Title: Director of Operations  
T: + 1 450 743 3893 ext. 22  
F: + 1 450 743 7566  
E: serge.laperriere@rji.ca  
W: www.richardson.ca

**Squamish**

**Squamish Terminals Ltd**  
PO Box 1520  
37500 Third Avenue  
Squamish  
British Columbia  
V8B 0B1  
Canada  
Contact: Mrs Kim Stegeman-Lowe  
Job Title: Manager, Marketing & Administration  
T: + 1 604 892 3511  
F: + 1 604 892 5623  
E: info@sqterminals.com  
W: http://www.sqterminals.com/  
32 nautical miles north of the Port of Vancouver, British Columbia, Canada - at the north end of the Howe Sound  
Break Bulk Facility  
2 Berths, which handle common size Panamax vessels  
Break Bulk Facility  
50,000sqm  
47,000sqm  
Squamish Terminals is a public terminal, open to all major break-bulk shipping lines providing its customers with access to markets world-wide and is capable of handling a wide variety of cargoes.

**St Catherines**

**The St Lawrence Seaway Management Corporation**  
508 Glendale Avenue  
St Catherines  
Ontario  
L2R 6V8  
Canada  
Contact: Mr Bruce Hodgson  
Job Title: Director, Market Development  
T: + 1 905 641 1932  
F: + 1 905 641 2018  
E: bhodgson@seaway.ca  
St. Lawrence Seaway Great Lakes Servicing 41 ports the Gateway to the North American Heartland.

**St Johns**

**Port of Stephenville**  
Transport Canada  
Harbours & Ports Directorate  
PO Box 1300  
St Johns  
Newfoundland  
A1C 6H8  
Canada  
Contact: Mr Wayne Hamilton  
T: + 1 709 772 6197  
F: + 1 709 772 5127  
E: portharmonauth@nf.aibn.com  
W: www.portharmonauthority.ca

**St Johns**

**Ports & Harbours**  
Transport Canada  
Harbours and Ports Directorate  
PO Box 1300  
St Johns  
Newfoundland  
Canada  
Contact: Ms Candice Keats  
Job Title: Operations Manager  
T: + 1 709 772 5199  
F: + 1 709 772 5127  
E: keatsc@tc.gc.ca

**Sydney**

**Sydney Ports**  
Tourism Cape Breton  
Marine and Development  
PO Box 1448  
Sydney  
Nova Scotia  
B1P 6R7  
Canada  
Contact: Mr Donald Rowe  
Job Title: General Manager  
T: + 1 902 564 8452  
F: + 1 902 564 0911  
E: don@sydneyport.ca

**Thunder Bay**

**Mission Terminal**  
Thunder Bay  
Ontario  
Canada  
Contact: Mr Paul Kennedy  
T: + 1 807 623 8868  
F: + 1 807 623 8823  
E: pkennedy@missionterminal.ca

**Thunder Bay**

**Richardson International Ltd**  
PO Box 10339  
Thunder Bay  
Ontario  
P7B 6T8  
Canada  
Contact: Mr Gerry Heinrichs  
Job Title: Regional Manager  
T: + 1 807 343 5571  
F: + 1 807 345 0522  
E: gerry.heinrichs@rji.ca  
W: www.rji.ca



# CANADA'S GATEWAY TO THE WEST



[www.portofthunderbay.ca](http://www.portofthunderbay.ca)

The Port of Thunder Bay is a well-established gateway for wind turbines and oversized project cargo destined for Western Canada.

Grain, coal and potash exist as backhaul cargoes for European, African and Latin American destinations.

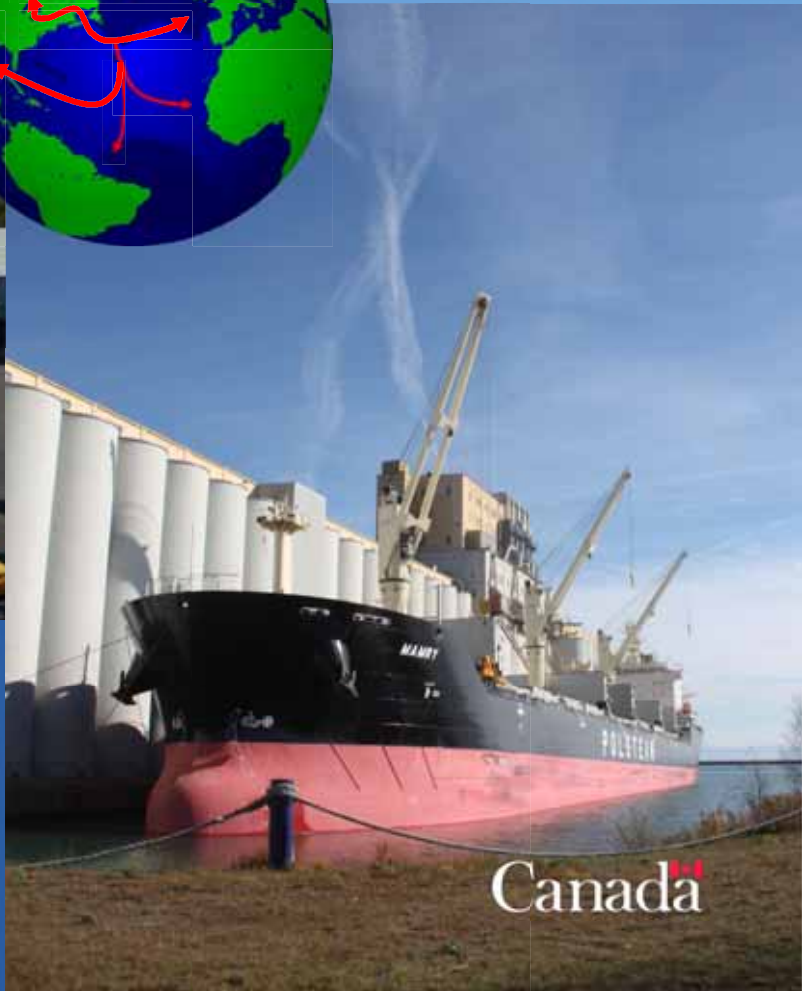
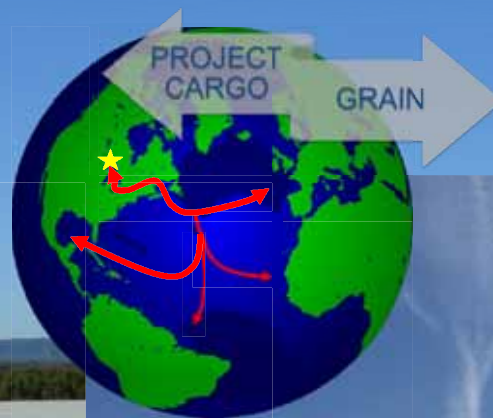

Thunder Bay Port Authority  
100 Main Street  
Thunder Bay, ON P7B 6R9  
T (807) 345-6400  
F (807) 345-9058

Canada



**Thunder Bay**

**Thunder Bay Port Authority**



100 Main Street  
Thunder Bay  
Ontario  
P7B 6R9  
Canada  
Contact: Mr Tim Henty  
Job Title: CEO  
T: + 1 807 346 7387  
F: + 1 807 345 9058  
E: tbport@tbaytel.net  
W: www.portofthunderbay.ca  
Mid-Canada - Lake Superior on Great Lakes St. Lawrence Seaway Grain handled through eight grain terminals. Other bulk commodities handled through two bulk terminals. See port website for details.

**Thunder Bay**

**Thunder Bay Terminals Ltd**

McKellar Island  
PO Box 1800  
Station 'F'  
Thunder Bay  
Ontario  
P7C 5J7  
Canada  
Contact: Mr John Kepes  
T: + 1 807 625 7800  
F: + 1 807 623 5749  
E: j\_kepes@tbaytel.net  
W: www.portauthority.thunder-bay.on.ca  
On Lake Superior

**Thunder Bay**

**Valley Camp Terminal, Inc.**

174 Darrel Ave  
Thunder Bay  
Ontario  
P7J 1K4  
Canada  
Contact: Mr Robert Van Patten  
T: + 1 618 655 1201  
F: + 1 618 656 1363  
E: rmvanpatten@aol.com  
W: www.namillyard.com  
Northwest Ontario on Lake Superior  
Shiploader at 4000 tph  
30 foot draught- accommodate 1100 foot boat  
2,000,000 tonnes  
40,000 tonnes  
On CN Rail

**Thunder Bay**

**Western Grain By-Products**

Thunder Bay  
Ontario  
Canada  
Contact: Mr Maurice Mailhot  
T: + 1 807 6238500  
F: + 1 807 622 0482  
E: wstgrain@tbaytel.net

**Toronto**

**Toronto Port Authority**

60 Harbour Street  
Toronto  
Ontario  
M5J 1B7  
Canada  
Contact: Mr Alain Lefebvre  
Job Title: Manager Trade Developments  
T: + 1 416 462 0263  
F: + 1 416 462 1612  
E: alefebvr@logistec.com  
W: www.torontoport.com  
43 deg 40' north, 79 Deg 25' west on the North shore of Lake Ontario  
8 docks at Seaway depth up to 300 MT capacity cranes  
8 bulk docks  
50,632sqm  
19,821sqm

This major inland port has 2720m of dock wall at Seaway depth specializing in general, bulk, and project cargo. 40 acres of container storage, 62 plug-ins for reefers. Container packing/ unpacking Special lifting equipment for all types of cargo.24/7 security and ISPS certified

**Trois-Rivières**

**Groupe Somavrac**  
3450 Boul. Gene H. Kruger  
C.P. 294  
Trois-Rivières  
Quebec  
G9A5G1  
Canada  
Contact: Mr Eric Boisvert  
Job Title: Vice President  
T: + 1 819 379 3311  
F: + 1 819 378 5584  
E: info@grpml.com  
W: www.grpml.com

**Trois-Rivières**

**Port of Trois Rivières**  
1545 rue du Fleuve  
Room 300  
Trois-Rivières  
Quebec  
G9A 6K4  
Canada  
Contact: Mr Gaétan Boivin  
Job Title: President & CEO  
T: + 1 819 378 2887  
F: + 1 819 378 2487  
E: adm\_gen@porttr.com  
W: www.porttr.com

**Trois-Rivières**

**Somavrac Inc.**  
3450 gene-h-kruger  
Trois-Rivières  
Québec  
G9A5G1  
Canada  
Contact: Mr Nicholas Tremblay  
Job Title: Maritime Foreman  
T: + 1 819 379 9639  
F: + 1 818 379 3311  
E: Ntremblay@somavrac.com  
W: http://www.prommel.com/en/companies/somavrac/default.asp

**Trois-Rivières**

**Three Rivers Elevators**  
PO Box 35  
Trois-Rivières  
Quebec  
G9A 5E3  
Canada  
Contact: Mr Gilles Morin  
Job Title: General Manager  
T: + 1 819 374 6203  
F: + 1 819 374 6392  
E: g.morin@gls.qc.ca

**Valleyfield**

**Valport Maritime Services Inc**  
Port de Valleyfield  
Boul. Cadieux  
Valleyfield  
Quebec  
J6T 6L4  
Canada  
Contact: Mr Frank Dunn  
Job Title: Partner  
T: + 1 450 377 6686  
F: + 1 450 337 2521  
E: frank@valport.ca  
W: www.valport.ca  
Valleyfield, Quebec, Canada near Montreal (50 km)  
see www.valport.ca

**Vancouver**

**Cascadia Terminal**  
3333 New Brighton Road  
Vancouver  
BC

V5K 5JK  
Canada  
Contact: Mr John Dewar  
Job Title: Director  
T: + 1 604 293 6207  
F: + 1 604 293 6214  
E: jdewar@cascadiaterminal.com  
W: www.viterra.ca  
South Shore of Burrard Inlet,  
Vancouver, BC  
Max 120,000dwt  
282,830t

**Vancouver**

**Port of Vancouver**  
100 The Pointe  
999 Canada Place  
Vancouver  
BC  
V6C 3T4  
Canada  
Contact: Ms Katherine Bamford  
Job Title: Business Communications Advisor  
T: + 1 604 665 9065  
F: + 1 866 284 4271  
E: katherine.bamford@portmetrovancover.com  
W: www.portvancouver.com  
West coast of Canada, located in Burrard Inlet in Vancouver and at Roberts Bank in Delta.  
25 major marine cargo terminals  
More than 60 berths  
Please see  
www.portvancouver.com for details per terminal  
Please see  
www.portvancouver.com for details per terminal  
The Port of Vancouver is Canada's largest deep-sea port and is the number one foreign export tonnage port in North America.

**Victoria**

**Little Narrows Gypsum Company Ltd**  
RR 1 Little Narrows  
Victoria  
Nova Scotia  
BOE 1T0  
Canada  
Contact: Mr Mike Bishop  
T: + 1 902 756 2081  
F: + 1 902 756 2493  
E: awbishop@usg.com

**Ville de La Baie**

**Rio Tinto Alcan Port Alfred**  
262 1st Street  
Ville de La Baie  
Quebec  
G7B 3R1  
Canada  
Contact: Mr Eric Favre  
Job Title: Director Operations  
T: + 1 418 544 9615  
F: + 1 418 544 9622  
E: eric.favre@riotinto.com  
W: www.riotintoalcan.com  
North East of Canada  
4 unloaders, 1,000tph each  
385m, 12m draught  
120KT  
400KT

**WaWa**

**Michipicoten Harbour**  
c/o Landfill Mining of Canada Ltd  
WaWa  
Ontario  
POS 1K0  
Canada  
Contact: Mr Mike Mezzonello  
Job Title: Dock Superintendent  
T: + 1 705 856 0606  
F: + 1 705 856 9783  
E: info@superioraggregates.com  
W: www.superioraggregates.com

**West Vancouver**

**Canpotex Terminals Limited**  
1111-100 Park Royal  
West Vancouver  
BC  
V7T 1A2  
Canada  
Contact: Ms Jennifer Siemens  
Job Title: Manager, Corporate Communications  
T: + 1 306 931 2200  
F: + 1 306 653 5505  
E: jennifer.siemens@canpotex.com  
W: www.canpotex.com

**Windsor**

**ADM Agri-Industries Company/ Windsor Grain Terminal Ltd.**  
5550/5600 Maplewood Drive  
Windsor  
Ontario  
N9C 4G9  
Canada  
Contact: Mr Brian Brohman  
Job Title: Plant Manager  
T: + 1 519 972 8100  
F: + 1 519 972 2355  
E: b\_brohman@admworld.com  
South side of the Detroit River between Lake St. Clair and Lake Erie  
1000' dock X 30' foot draught  
110,000 tonnes

**Windsor**

**Port of Windsor**  
Windsor Port Authority  
502 Westcourt Place  
251 Goyeau  
Windsor  
Ontario  
N9A 6V2  
Canada  
Contact: Mr Peter Berry  
Job Title: Harbour Master  
T: + 1 519 258 5741  
F: + 1 519 258 5905  
E: pberry@portwindsor.com  
W: www.portwindsor.com

**Winnipeg**

**Richardson International Ltd**  
Corporate Head Office  
2800 - One Lombard Place  
Winnipeg  
MB  
R3B 0X8  
Canada  
Contact: Mr Riley Verhelst  
Job Title: Plant Manager  
T: + 1 204 934 5961  
F: + 1 204 942 4161  
E: corporateaffairs@rji.ca  
W: www.rji.ca

**Winnipeg**

**Viterra**  
CanWest Global Place  
201 Portage Ave  
Winnipeg  
MB  
R3C 3A7  
Canada  
Contact: Mr Walter Fox  
Job Title: VP Terminals  
T: + 1 207 944 5488  
F: + 1 207 944 5476  
E: info@viterra.ca  
W: www.viterra.ca

**CANARY**

**ISLANDS**

**Santa Cruz**

**Junta del Puerto de Sto Cruz**  
Av Francisco Larroche 49  
Santa Cruz  
Tenerife

38071  
Canary Islands  
Contact: Mr Miguel Pinter  
T: + 34 922 605 426  
E: web@puertosdetenerife.org

**CAPE VERDE**

**Praia**

**Capitania dos Portos de Sotavento**  
PO Box 38  
Praia  
Cape Verde  
Contact: Mr Albertino Graca  
Job Title: Port Director  
T: + 238 612382  
F: + 238 616133  
E: Portodesotavento@enapor.cv

**CHILE**

**Antofagasta**

**Caleta Coloso**  
Ultramar Agencia Maritima  
Copia PO 574  
Casilla 1210  
Antofagasta  
Chile  
Contact: Mr Alberto Varas  
Job Title: Director  
T: + 56 55 201793  
F: + 56 55 227341

**CHILE**

**Arica**

**Puerto Arica**  
Maximo Lira 389  
Arica  
Arica  
1000002  
Chile  
Contact: Mr Mario Moya  
Montenegro  
T: + 56 58 202080  
F: + 56 58 202090  
E: mmoya@puertoarica.cl  
W: www.puertoarica.cl

**Castilla**

**Tocopilla**  
c/o Servicios Integrales de Transitos y Transferencias  
Arturo Prat No 1060  
Castilla  
Tocopilla  
2098  
Chile  
Contact: Mr D Daniel Zarzosa  
Job Title: Captain Port Authority  
T: + 56 55 813 279  
E: cptocopilla@directemar.cl

**Concepcion**

**Neuling Graneles SA**  
San Martin  
553 Oficina  
Concepcion 805  
Chile  
Contact: Mr Sergio Ulloa  
Job Title: General Manager  
T: + 56 41 2254 205  
E: sergio.ulloa@neulingsa.cl  
South America, Chile, Bahía de Concepcion  
20 trucks for bulk transportation  
1 belt conveyors 40 meters  
6 grabs (8 cub meters, each one)  
15,000 sqm  
5,200 sqm  
We are a stevedors company in ports of Bahía de Concepcion, Chile  
These ports are : San Vicente, Coronel, Lirquen.

**Iquique**

**Empresa Portuaria Iquique**  
Avenida Jorge Barrera #62  
Iquique  
Chile  
Contact: Mr Alvaro Espinosa  
T: + 56 57 400100  
F: + 56 57 413 176  
E: epi@epi.cl  
W: www.epi.cl/z

**La Serena**

**Port Authority of Guayacan**  
Compania Minera del Pacifico S.A.  
Pedro Pablo Munoz 675  
La Serena  
Guayacan  
Chile  
Contact: Mr Eduardo Bauer  
Job Title: Port Manager  
T: + 56 51 208025  
F: + 56 51 208140

**Lirquen**

**Port of Lirquen SA**  
Recinto Muelle s/n Lirquen  
Casilla no 937  
Correo Concepcion  
Lirquen  
Chile  
Contact: Mr Jorge Baksai Marquez  
Job Title: Terminal Manager  
T: + 56 41 451037  
F: + 56 41 451030  
E: plirquen@puerto.cl

**Mejillones**

**Puerto Angamos**  
Avenida Longitudinal  
Mejillones  
Antofagasta  
Chile  
Contact: Mr Pablo Ortega Van Giel  
Job Title: Commercial department  
T: + 56 55 883622  
E: portega@puertoangamos.cl  
W: http://www.puertoangamos.cl

**Mejillones**

**Puerto de Mejillones S.A**  
Casilla 108  
Avenida Costanera Norte 2800  
Mejillones  
Antofagasta  
1310000  
Chile  
Contact: Mr Francisco Wegertseider  
Job Title: Head of Sales  
T: + 56 55 883632 / +56 55 883600  
E: fwegertseider@puertomejillones.cl  
W: www.puertomejillones.cl  
Bay of Mejillones, North of Chile  
Two Berths:  
Berth N°1: Two level Luffing cranes, nominal capacity 1,200tph, conventional conveyor belt. One Shiploader, nominal capacity 1,500tph, pipe conveyor belt.  
Berth N°2: Unloading/Loading sulfuric acid, nominal capacity 500tph.  
Berth N°1:  
Length (LOA): 230 m  
Beam: 34 m  
DWT: 85,344 tonnes  
Berth N°2:  
Length (LOA): 230 m  
Beam: 34 m  
DWT: 80,000 tonnes  
5,000sqm  
Zinc and Lead concentrates  
Stockpile: 6,274sqm  
Sulfuric Acid Terminal Tanks: 35,000sqm  
Puerto de Mejillones inland facilities includes one stockpile 50.000 tonnes capacity, one spot uncovered area for 30.000 tonnes and 200.000 tonnes sulfuric acid storage capacity in 10 tanks.

**Mejillones**

**Terminal Graneles del Norte S.A.**  
Calle Puerto Uno N°7100  
Barrio Industrial  
Mejillones  
Antofagasta  
Chile  
Contact: Mr Boris Behrens S.  
Job Title: Terminal Manager  
T: + 56 055 883761  
E: bbehrens@puertotgn.cl  
W: www.puertotgn.cl  
Mejillones, North of Chile,  
Antofagasta Region, Pacific coast  
Two Liebherr cranes model CBG 35/32, three discharge hoppers, 1300 mts of pipe conveyor system. 25.5 tons Smag Grabs.  
Wharf Platform of 138 mts length x 16 mts width. Max. Draft 14.4 mts, max LOA 250 mts.  
250,000 m2 (25 Há)  
N/A

**Puerto Natales**

**Port of Puerto Natales**  
Empresa Portuaria De Chile  
Pedromot 325  
Puerto Natales  
Chile  
Contact: Mr Miguel Chaves  
Job Title: Managing Director  
T: + 56 61 411 570  
F: + 56 61 411 409

**Quintero**

**Port Authority of Quintero**  
Gobernacion Maritima de Valparaiso  
Avenida 21 Mayos/n  
Quintero  
Chile  
Contact: Mr L Fernandez  
Job Title: General Manager  
T: + 56 3293 0366  
E: cpquintero@directemar.cl

**San Antonio**

**Puerto Panul S.A.**  
Antonio Nunez de Fonseca No. 440  
Torre Bioceanica Piso 6 Of. 606  
San Antonio  
Barros Luco  
1613  
Chile  
Contact: Mr Carlos Valenzuela S  
T: + 56-35-355900  
F: + 56-35-355919  
E: puertopanulsa@puertopanul.cl  
W: www.sanantonioport.cc.cl/  
html/sist\_portuario/panul.php

**Santiago**

**E.CL S.A.**  
Av El Bosque Norte 500 of 902  
Las Condes  
Santiago  
Metropolitana  
7550092  
Chile  
Contact: Mr Emilio Bouchon  
Job Title: Gerente de Puerto  
T: + 56 23533210  
F: + 56 23533208  
E: emilio.bouchon@e-cl.cl  
W: http://www.e-cl.cl

**Santiago**

**Portuaria Puchoo SA**  
Av Bdo. O'Higgins 949 Of.1206  
Casilla  
Santiago  
2511  
Chile  
Contact: Mr Jamie Barahona V  
T: + 56 2 699 0330

**Tocopilla**

**Central Termoelectrica Tocopilla**  
Avda Dr Leonardo Guzman 0780

Tocopilla  
Casilla 1999  
Chile  
Contact: Mr Andres Tornquist  
Fernandes  
T: + 56 55 813279  
F: + 56 55 813279

**Valparaiso**

**Saam**  
Blanco 895  
Valparaiso  
Valparaiso  
Chile  
Contact: Mr Manuel Inostroza  
Job Title: Bulk Manager  
T: + 56 32 2201 229  
F: + 56 32 2201 481  
E: servicioalcliente@saamsa.com  
W: www.saamsa.com

**Valparaiso**

**Valparaiso Port Authority**  
Pier No 6-10  
Errazuriz 25  
Valparaiso  
Chile  
Contact: Mr Gonzalo Davagnino Vergara  
Job Title: Commercial Manager  
T: + 56 3244 8727  
F: + 56 3222 4190  
E: info@portvalparaiso.cl  
W: www.portvalparaiso.cl

**CHINA**

**Anqing**

**Anqing Port Authority**  
Administration Office  
7 Yanjiang Zhong Road  
Anqing  
Anhui  
246030  
China  
Job Title: Port Master  
T: + 86 556 521 7018  
F: + 86 556 554 2843

**Beihai**

**Behai Harbour Administration**  
Administration Office  
75 Haijiao Road  
Beihai  
Guangxi  
536000  
China  
Contact: Mr Yue Zhiwei  
Job Title: Port Manager  
T: + 86 779 303 3481  
F: + 86 779 303 6387

**Chiwan**

**Chiwan Harbour Container Office Building**  
11th Floor Marine Building  
Chiwan  
Shenzhen  
518 068  
China  
Contact: Mr Du Xiaokun  
Job Title: Commercial Department  
T: + 86 755 2669 4228  
F: + 86 755 2669 4297  
E: wuzm@cwct.com  
W: www.cwct.com

**Chongquin**

**Chongquin Port Authority**  
3 Chaoqian Road  
Yuzhong District  
Chongquin  
Sichuan Province  
400011  
China  
T: + 86 23 6310 0374  
F: + 86 23 6310 0612  
W: www.cqg.com.cn

**Dalian**

**Dalian Bay Coal Terminal**  
1 Gangwan Street  
Zhongshan District  
Dalian  
Liaoning Province  
116004  
China  
Contact: Mr Zang Feng Chiang  
T: + 86 411 8263 7873  
F: + 86 411 8280 7148  
W: www.chinaports.com.cn/dalian.htm

**Dalian**

**Dalian Port Authority**  
1 Gangwan Street  
Zhongshan District  
Dalian  
116001  
China  
Contact: Mr Hong Sun  
Job Title: Deputy Director of Marketing  
T: + 86 411 8263 7873  
F: + 86 411 280 7148  
E: info@portdalian.com  
W: www.portdalian.com

**Dalian**

**DCW Group Co**  
350 Zhong Nan Road  
Zhongshan District  
Dalian  
116022  
China  
Contact: Mr Lu Kaili  
T: + 86 411 289 3900  
F: + 86 411 289 1756  
E: info@dalian-gov.net

**Dalian**

**Ganjingzi Coal Terminal**  
1 Gangwan Street  
Zhongshan District  
Dalian  
116004  
China  
Contact: Mr Zang Feng Qiang  
T: + 86 411 8263 7873  
F: + 86 411 8280 7148

**Dongfang County**

**Basuo Port Corporation**  
Basuo  
Dongfang County  
Hainan  
China  
Contact: Mr Zhao Huang Yong  
Job Title: General Manager  
T: + 86 8003 522 512  
F: + 86 8003 521 054

**Fangcheng**

**Fangcheng Harbour Administration**  
Port Administration Office  
22 Youyi Road  
Fangcheng  
Guangxi Province  
China  
Contact: Mr Ye Shixiang  
Job Title: Director General  
T: + 86 770 289 8141  
F: + 86 770 282 2663  
W: www.infomarine.gr/china/fangcheng

**Fujian Province**

**Dongshan Port Authority**  
Port Administration Office  
Shipping Building Dongshan Port,  
Fujian Province  
363401  
China  
Job Title: Port Master  
T: + 86 596 562 2374  
F: + 86 596 202 8622

**Fuzhou**

**Fuzhou Port**  
79 Chieh Fang Road West  
Fuzhou  
Fujian  
China  
Contact: Mr C Xiguan  
Job Title: Deputy Director  
T: + 86 591 559 934  
F: + 86 591 839 87696

**Guangzhou**

**Xinggong No1**  
30 Yangjiang No1 Road  
Guangzhou  
Guangzhou Province  
510000  
China  
Contact: Mr Leung  
T: + 86 20 227 9412  
F: + 86 20 227 8303

**Haikou**

**Haikou Port Authority**  
Hainan Port Affairs  
Hsui ying Wharf  
Haikou  
China  
Job Title: Port Master  
T: + 86 898 866 6830  
F: + 86 898 866 2180  
E: bgs@shjq.com.cn

**Hong Kong**

**China Cement Co (HK) Ltd**  
General Office  
7 Lung Yiu Street  
Tap Shek Kok  
Tuen Mun NT  
Hong Kong  
China  
Contact: Mr Li Ka-Shing  
Job Title: Chairman of the Board  
T: + 852 2122 3133  
F: + 852 2411 3421  
E: chairoff@ckh.com.hk

**Hong Kong**

**CLP Power HK Limited**  
Castle Peak Power Station  
Tuen Mun  
Hong Kong  
China  
Contact: Mr Andrew C W Brandler  
Job Title: CEO  
T: + 852 2678 8111  
F: + 852 2760 4448  
E: csd@clp.com.hk  
W: www.clp.com.hk/Pages/home.aspx

**Hong Kong**

**The Hongkong Electric Company Ltd**  
44 Kennedy Road  
Hong Kong  
China  
Contact: Mr Francis C. Y. Cheng  
Job Title: General Manager (Generation)  
T: + 852 2982 6201  
F: + 852 2982 1654  
E: mail@hkelectric.com  
W: www.hkelectric.com  
Lamma Island, Hong Kong  
Five ship unloaders (2 of them are grab type with a capacity of 1,000tph each and 3 are continuous type with a capacity of 1,500tph each).  
One Stacker with a capacity of 3,000tph. One Stacker/Reclaimer with a stacking and reclaiming capacity of 3,000tph and 2,000tph respectively.  
Two berths (each 290m in length) capable of handling two coal vessels (max dwt 100,000MT) simultaneously.  
63,000sqm  
4,300sqm  
Facilities for the handling of



limestone and gypsum are available at the East Heavy Unloading Area of the power station. The wharf is capable of unloading limestone barges up to 6,000 MT dwt with a screw-type unloader of 350tph capacity.

**Hualien**

**Hualien Harbour Bureau**  
No.66 Hai-Ann Road  
Hualien  
Taiwan  
97059  
China  
Contact: Mr Chung-Hsiung Wang  
Job Title: Director  
T: + 886 38 325 131  
F: + 886 38 333 757  
E: dttd100@mail.hlhb.gov.tw  
W: www.hlhb.gov.tw

**Jiangsu**

**Port of Lianyungang**  
Jiangsu Lianyungang Port Authority  
99 Zhongshan Rd  
Lianyungang  
Jiangsu  
222046  
China  
T: + 86 518 238 2501  
F: + 86 518 238 2906  
E: info@lygport.com.cn  
W: www.lygport.com.cn

**Jinzhou**

**Jinzhou Port Authority**  
Port Administration Office  
11-2 Zhongyand Street  
1 Jingang Street  
Jinzhou  
Liaoning  
121007  
China  
Job Title: Port Manager  
T: + 86 416 312 7123  
F: + 86 416 312 2419  
E: msc@jinzhouport.com  
W: www.jinzhouport.com

**Lianyungang**

**Lianyungang Port Authority**  
99 Zhongshan Road  
Lianyungang  
Jiangsu  
222046  
China  
Contact: Mr Chen Gang  
Job Title: Assistant Economist  
T: + 86 518 238 2502  
F: + 86 518 233 2419  
E: wangmx@lyg.gov.cn  
W: www.lyg.gov.cn

**Longkou City**

**Longkou Port Authority**  
Longkou Port Administration B  
24 Huanhai Road  
Longkou City  
Shandong Province  
265700  
China  
Contact: Mr Wang Shu-Bo  
T: + 86 535 884 2091  
F: + 86 535 884 1137

**Nanjing**

**Nanjing Port Authority**  
19 Jianbian Road  
Xia Guan District  
Nanjing  
210011  
China  
Contact: Mr Wu Deming  
T: + 86 25 5858 2721  
F: + 86 25 5882 3898

**Nantong**

**Nantong Port Authority**  
12 Qingnian Road (W)

Nantong  
Jiangsu Province  
226006  
China  
Contact: Mr Shi Boxiang  
Job Title: Port Director  
T: + 86 8 513 831 7591  
E: ntpa@public.nt.js.cn  
W: www.ntport.com.cn

**Ningbo**

**Ningbo Port Authority**  
496 Yanjiangdong Road E  
Zhenhai District  
Ningbo  
Zhejiang Province  
315200  
China  
Contact: Mr Linghong Li  
T: + 86 574 769 5142  
F: + 86 574 2769 5233  
E: npa\_office@nbport.com.cn  
W: www.nbport.com.cn/wps/portal

**Pinghu**

**Zhapu Port Authority**  
Huhang Road  
Zhapu  
Pinghu  
Zhejiang  
314201  
China  
Job Title: Port Director  
T: + 86 573 552 2035  
F: + 86 573 552 2035

**Putian**

**Port of Xiuyu**  
Rm422-425, Pacific Centre  
Licheng Boulevard  
Putian  
Fujian  
China  
Contact: Zhang Jingsong  
Job Title: General Manager  
T: + 86 594 2696 290  
F: + 86 594 2696 690  
E: penavico@penavicomzw.com  
South of China on the South Coast  
Shore crane (2\*18T 2\*10T 2\*40T  
2\*16T 2\*25T) & conveyor  
25° 13'0N 118° 59'0E(APPROX)  
138,000 m2  
120,000 m2

**Qingdao**

**Port of Qingdao**  
Gang Qing Road 6  
Qingdao  
Shandong Province  
266011  
China  
Contact: Mr Chang Dechuan  
Job Title: President  
T: + 86 532 298 2011  
F: + 86 532 282 2878  
E: president@qdport.com  
W: www.qdport.com/en

**Qingdao**

**Port of Qingdao Coal Terminal**  
Gang Qing Road 6  
Qingdao  
Shandong Province  
266011  
China  
Contact: Mr Chang Dechuan  
Job Title: President  
T: + 86 532 298 2011  
F: + 86 532 292 2878  
E: kefu@qdport.com  
W: www.qdport.com/en

**Qingdao**

**Xigang Company**  
65 Chongmngdao West Rd.  
Huangdao District  
Qingdao  
Shandong  
266500  
China

T: + 86 532 8298 8085  
F: + 86 532 8298 8085  
E: bgs.xg@qdport.com  
W: www.qdport.com/info/  
gkgk/gsgk\_gs\_xg/en/

**Qinhuangdao**

**Qinhuangdao Port Authority**  
35 Haibin Road  
Qinhuangdao  
Hebei  
066002  
China  
Contact: Mr Huang Jianhua  
Job Title: Chairman of the Board  
T: + 86 335 309 3222  
F: + 86 335 341 5467

**Rizhao City**

**Rizhao Port Authority**  
Huanghai Road 1  
Rizhao City  
Shandong Province  
276826  
China  
Contact: Mr Wang Yan  
Job Title: Office Director  
T: + 86 633 838 2900  
F: + 86 633 838 2282  
E: info@mail.rzport.com  
W: www.rzport.com

**Sanya**

**Sanya Port**  
Sanya Port Administration  
Jiangang Road  
Sanya  
Hainan Province  
572100  
China  
Job Title: Port Director  
T: + 86 899 827 4031  
F: + 86 899 827 4153

**Shanghai**

**Ming Sheng Stevedores No 3/4 Terminals**  
No 3 Ming Sheng Rd  
Pudong New District  
Shanghai  
200135  
China  
Contact: Mr Lin Huizheng  
T: + 86 21 588 536 75  
F: + 86 21 588 534 71  
E: minsheng.port@online.sh.cn

**Shanghai**

**Shanghai International Port Group (SIPG)**  
13 Zhongshan Dong Yi Lu  
Shanghai  
200002  
China  
Contact: Mr. Steven  
Job Title: Port Director  
T: + 86 21 329 0660  
F: + 86 21 329 0202  
E: contact@portshanghai.com.cn  
W: www.portshanghai.com.cn

**Shanghai**

**Shanghai Port Luojing Bulk Terminals**  
8 Shi Gang Road  
Baoshan District  
Shanghai  
China  
Contact: Mr Shao Xue Kang  
Job Title: Managing Director  
T: + 86 21 6323 1871  
F: + 86 21 6323 0184

**Shantou**

**Shantou Port**  
Shantou Port Affairs Bureau  
1 Shang Ping Road  
Shantou  
Guangdong  
515011

China  
Contact: Mr Shen Jingchang  
T: + 886 754 893 2345  
F: + 86 754 885 0425

**Shenzhen**

**Chiwan Port Authority**  
c/o China Ocean Shipping Agency  
Gangwan Yi Road, Shekou  
Shenzhen  
Guangdong  
518067  
China  
Contact: Mr Du Xiaokun  
T: + 86 755 2669 4888  
F: + 86 755 2669 4297

**Shenzhen**

**Shekou Port Service Co Ltd**  
Gang Wan Yi Lu  
Shekou Industrial Zone  
Shekou  
Shenzhen  
Guangdong Province  
518067  
China  
Contact: Mr J Gao  
T: + 86 755 699 1135  
F: + 86 755 688 5859

**Shenzhen**

**Shenzhen Haixin Harbour Development Co Ltd**  
Mawan Port  
Nanshan District  
Shenzhen  
Guangdong  
518052  
China  
Contact: Mr Zhou Zhong  
Job Title: Port Manager  
T: + 86 755 669 3755  
F: + 86 755 667 9353

**Shenzhen**

**Shenzhen Yantian Port**  
Yantian Port Group Co  
7/F Shatuoqiao Office Building  
Shenzhen  
518090  
China  
Contact: Mr Ding Tong Liu  
Job Title: Administrator  
T: + 86 755 8379 7111  
F: + 86 755 8379 7138

**Shijiazhuang**

**Hebei Port Group Co, Inc**  
35 Yuhudong Road  
Shijiazhuang  
Hebei  
050019  
China  
Contact: Mr Edward Wong  
Job Title: Chief, Public Relations  
T: + 86 311 8780 0528/+ 86 335 309 4924  
F: + 86 311 8790 0111  
E: wangcong@portqhd.com  
W: www.porthabei.com

**Taizhou City**

**Port of Haimen**  
Port Administration Office  
Jiaojiang District  
Taizhou City  
Zhejiang Province  
318000  
China  
Contact: Mr Ji Jie Chao  
Job Title: Port Director  
T: + 86 576 822 4571  
F: + 86 576 888 1169

**Tanggu**

**Tianjin Port Authority**  
2 Xingang Road  
Gate 35  
Tanggu  
Tianjin

300456  
China  
Contact: Mr Lin Chen  
Job Title: Division Chief  
T: + 86 22 2570 5239  
F: + 86 22 2570 9747

**Tanggu**

**Tianjin Xingang Sinor Terminal Co Ltd**  
No 1 Road East Xingang  
Tanggu  
Tianjin  
300456  
China  
Contact: Mr Svein Weie  
Job Title: General Manager  
T: + 86 22 2570 6666  
F: + 86 22 2570 6969  
E: sw@gearbulk.com  
W: www.gearbulk.com

**Tangshan**

**Jintang Port**  
Harbour Administration Office  
Haigang  
Development Zone  
Tangshan  
Hebei  
063600  
China  
T: + 86 315 291 4059  
F: + 86 315 291 4287

**Wenzhou**

**Wenzhou Port**  
Wenzhou Port Affairs Bureau  
7th and 8th Floor  
Jiangrun Mansion  
Jiangbin Road  
Wenzhou  
Zhejiang Province  
325000  
China  
Job Title: Port Director  
T: + 86-577-88192999  
F: + 86-577-88186775  
E: office@wzport.com

**Wuhu**

**Wuhu Port Authority**  
Port Administration Office  
32 Jiang'an Rd  
Wuhu  
Anhui Province  
241000  
China  
Job Title: Port Master  
T: + 86 553 383 9153  
F: + 86 553 381 1064

**Xiamen**

**Xiamen Harbour Authority**  
127 Dongdu Road  
Xiamen  
Fujian Province  
361012  
China  
Contact: Mr Huang He Rong  
Job Title: Manager  
T: + 86 592 561 4889  
F: + 86 592 561 2682  
E: xpgco@public.xm.fj.cn  
W: www.portxiamen.com.cn

**Yantai**

**Yantai Port Authority**  
Yantai Port Group Limited  
155 Beima Road  
Yantai  
Shandong Province  
264000  
China  
Contact: Mr Liu Zhen Hu  
Job Title: General Manager  
T: + 86 535 674 2134  
F: + 86 535 624 1892  
E: ytport@yantaiport.com.cn  
W: www.yantaiport.com.cn

## Yingkou

**Port of Yingkou**  
Yingkou Harbour Administration  
1 Xingang Road  
Bayuquan District  
Yingkou  
Liaoning  
115007  
China  
Job Title: Port Director  
T: + 86 417 625 1778  
F: + 86 417 625 1523

## Zhanjiang

**Zhanjiang Port Authority**  
Gangqu Road  
Zhanjiang  
Jiangsu Province  
215633  
China  
Contact: Mr Zhen Riqiang  
Job Title: Managing Director  
T: + 86 759 2250102  
F: + 86 759 2280814  
E: zjport@163.net  
W: www.zjport.com

## Zhanjiang

**Zhanjiang Port Authority**  
Port Administration Office  
1 You Yi Rd, Xiashan  
Zhanjiang  
Guangdong  
524027  
China  
Contact: Mr Lijang da Tong  
Job Title: Managing Director  
T: + 86 759 225 5516  
F: + 86 759 228 0814

## Zhenjiang

**Zhenjiang Port Authority**  
Administration Office  
19 Changjiang Road  
Zhenjiang  
Jiangsu Province  
212001  
China  
Contact: Mr Xia Mao Xiang  
Job Title: Harbour Master  
T: + 86 511 527 4892  
F: + 86 511 257 7837  
E: zjport@163.net

## Zhoushan

**Zhoushan Port Administrative Bureau**  
1 Ding Harbor Terminal  
Zhoushan  
Zhejiang  
China  
Contact: Mr Sheng Liding  
Job Title: Director  
T: + 86 580 206 7164  
E: zsgwj@sina.com  
W: www.zsport.com.cn/english

## Zhoushan

**Zhoushan Port Haitong Transshipment & Storage Co Ltd**  
Loatangshan Port Area  
Dinghai  
Zhoushan  
316043  
China  
Contact: Ms Li Yading  
Job Title: General Manager  
T: + 86 580 801 0202  
E: zsport@zhoushan.gov.cn  
W: www.zsport.com.cn

## COLOMBIA

### Barranquilla

**Carbones del Correo LLC**  
Cra 54 # 72-80  
Barranquilla  
Colombia  
Contact: Mr Ricardo Acosta

T: + 57 53 50 6802  
F: + 57 53 50 2111  
E: ricardo.acosta@cerrejoncoal.com  
W: www.cerrejon.com  
North coast of Colombia  
28 Mtpa

### Barranquilla

**Cementos del Caribe**  
Via 40 Las Flores  
Barranquilla  
Colombia  
Contact: Mr Enrique Esparragoza  
Job Title: Shipping Manager  
T: + 57 5 361 9389  
E: eesparagoza@argos.com.co

### Barranquilla

**Compas SA**  
Via 40 Las Flores  
Former Cementos Argos SA  
Barranquilla  
Atlantico  
575  
Colombia  
Contact: Mr Uriel Duarte  
Job Title: Terminal Director  
T: + 575 3619 233  
F: + 575 3619 222  
E: uduarte@compas.com.co  
W: www.compas.com.co  
North East coast of Colombia  
Movable shiploader & 900tph  
250m piled platform  
85,000sqm  
6,000sqm  
Presently building a second  
berthing position to accommodate  
an additional large vessel.

### Barranquilla

**Port of Puerto Bolivar**  
International Colombia Resources  
Corporation  
Apartado Aero 52499  
Barranquilla  
Colombia  
Contact: Capt Steve C Catton  
Job Title: Port Superintendent  
T: + 57 53 799545  
F: + 57 53 502121  
E: oprbv@navescolombia.com  
W: www.navescolombia.com/  
ports/pbolivar.htm

### Barranquilla

**Sociedad Portuaria Del Norte**  
Calle 2  
No. 41N - 28  
Barrio Villanueva  
Barranquilla  
Atlantico  
Colombia  
Contact: Mr Carlos Rosado  
Job Title: General Manager  
T: + 575 344 57 37  
F: + 575 344 6814  
E: crosado@spdelnorte.com  
W: www.spdelnorte.com

### Barranquilla

**Sociedad Portuaria Regional de Barranquilla SA**  
Carrera 38  
Callea 1a Orilla del Rio  
Terminal Maritimo y Fluvial de Barranquilla  
Barranquilla  
Colombia  
Contact: Mr Pablo Riveira  
Job Title: Operations Manager  
T: + 575 37 16200  
F: + 575 37 16310  
E: priveira@sprb.com.co  
W: www.sprb.com.co

### Barranquilla

**Tolu**  
c/o Tolcementos  
Carrera 58 Nos 75-78  
Barranquilla

Colombia  
Contact: Mr Enrique Olarte  
T: + 57 58 451 288  
F: + 57 58 454 548  
W: www.navescolombia.com/  
ports/tolu.htm  
Max LOA 200m, Max Draft alongside  
34ft, Max Beam 30m

### Bogota

**Puertos de Colombia**  
Carrera 10a No 15-22  
Piso 10  
Bogota  
Colombia

### Bogota

**Santa Marta Coal Terminal**  
Carbanandes  
Transv 19 No 122-42  
Bogota  
Colombia  
Contact: Mr Jairo Caicedo  
T: + 57 1 248 7034  
F: + 57 3 310 2544330  
E: jairoca@cc-net.net

### Buenaventura

**Sociedad Portuaria Regional de Buenaventura S.A**  
Avenida Portuaria  
Edificio Administracion  
Buenaventura  
Colombia  
Contact: Ms Matilde Correa  
T: + 57 2 691 4348  
F: + 57 2 691 43 52  
E: matildec@sprbun.com  
W: www.sprbun.com

### Santa Marta

**Port of Santa Marta**  
Carrera 1 No. 10 A - 12  
Santa Marta  
Magdalena  
AA655  
Colombia  
Contact: Mr Rodolfo Schmulson  
Job Title: Commercial Director  
T: + 57 5 4217970 ext 103  
F: + 57 5 4212161  
E: comercial@spsm.com.co  
W: www.spsm.com.co  
Located at the northwest end of  
Santa Marta-Colombia.  
Shore crane: 104 tons  
Mobile crane: 50 tons  
Reach Stacker: 45 tons  
Low Boy: 70 tons  
Forklift: 2,5; 3,0; 5,5; 7,0; 15,0 tons  
Electric Forklift: 2,4 y 3,8 tons  
Pallet Jack: 2,0 y 2,72 tons  
Trucks: 35 tons  
2 STS CRANES: 100 tons each  
4 RTG'S: 50 tons each  
Pneumatic unloading system  
(VIGAN): 600 ton/h  
Berth # 4: Longitud 240 Mts,  
Calado 46'  
Berth # 5: Longitud 94 Mts,  
Calado 25'  
Berth # 6: Longitud 150 Mts,  
Calado 60'  
Berth #7: Longitud 156 Mts,  
Calado 55'  
35,000sqm  
4 warehouses: 6.400 m2  
5 automated grain warehouses with  
storing capacity: 31.500 tons  
Metallic Storage Silo facility: 69.000  
tons

The Port serves Colombian foreign  
commerce on a 24-hour daily basis  
all year round. It further provides  
the benefits of a safe storage within  
its yards and warehouses.  
Plan of Expansion designed  
towards the specialization of the  
Container, Grain, General Cargo  
and Coal Sub Terminals.

## Santa Marta

**Puerto Prodeco**  
Centro Comercial Prado Plaza  
Cra 4 Cl26A Esq 3er  
Santa Marta  
Colombia  
Contact: Mr Andrew Lyons  
T: + 57 5 4 21 4400  
F: + 57 5 4 21 4698

## Sociedad Portuaria Santa Marta

**CTS de Colombia**  
Cra. La. #10A-12  
Muelle 6  
Sociedad Portuaria Santa Marta  
Colombia  
Contact: Mr Scott Harcourt  
Job Title: Project Manager  
T: + 57 54 211 754  
F: + 57 54 233 369  
E: scott.harcourt@coopertsmith.com

## CROATIA

### Ploce

**Port of Ploce Authority**  
Trg Kralju Tomoslava 21  
Ploce  
20340  
Croatia  
Contact: Captain Ivan Maric  
Job Title: Assistant to Executive  
Director  
T: + 385 20 414 541  
F: + 385 20 670 271  
E: pfo-mario@port-authority-ploce.hr  
W: www.port-authority-ploce.hr

### Rijeka

**LUKA Rijeka d.d.**  
Riva 1  
Rijeka  
Hrvatska  
51000  
Croatia  
Contact: Ms Tatjana Krilić  
Job Title: President  
T: + 385 51 496 000  
E: marketing@lukarijeka.hr  
W: www.lukarijeka.hr

### Rijeka

**Terminal Bakar**  
LUKA Rijeka dd  
Riva 1  
Rijeka  
51000  
Croatia  
Contact: Mr Alen Sikic  
Job Title: Terminal Manager  
T: + 385 51 496 000 / 4969 40  
F: + 385 51 332 203  
E: info@lukarijeka.hr  
W: www.lukarijeka.hr

### Zadar

**Zadar Port Authority**  
Lucka Kapetanija  
Liburnska Obala 8  
Zadar  
57000  
Croatia  
Contact: Mr Milivoj Maric  
Job Title: Harbour Master  
T: + 385 23 254 888  
F: + 385 23 254 876  
E: lucka-uprava-zadar@zd.t-com.hr

## CUBA

### Antilla

**Antilla Port Authority**  
Avenida 28 de Enero No 65  
Apartado No 33  
Antilla  
Province de Holgium  
Cuba  
Contact: Mr Ramon Pavon

Job Title: Harbour Master  
T: + 53 24 88248  
F: + 53 24 88437  
E: cantilla@enet.cu

### Antilla

**Nicaró**  
c/o Agencia de Antilla  
Avenida 28 de Enero No 65  
Apartado No 33  
Antilla  
Prov de Holguin  
Cuba  
Job Title: Port Manager  
T: + 53 24 88248  
F: + 53 24 88127

### Antilla

**Port of Felton**  
c/o Agencia de Antilla  
Avenida 28 de Enero No 65  
Apartado No 33  
Provenida de Antilla  
Antilla  
Cuba  
Contact: Mr Ramon Pavon  
Job Title: Port Manager  
T: + 53 24 88248/88225  
F: + 53 248 8437

### Cardenas

**Port of Cardenas**  
c/o Agencia Cardenas  
Calle 2 entre Cespedes y Ave 2da  
Apartado No 2847  
Cardenas  
Prov de Mantanzas  
Cuba

### Cienfuegos

**Port of Cienfuegos**  
c/o Agencia Cienfuegos  
PO Box 420  
Avenida 50  
Cienfuegos  
No 2712  
Cuba  
Contact: Mr M Roderiquez  
Job Title: Port Manager  
T: + 53 432 27455  
F: + 53 432 8466

### Havana

**Port Authority of Havana**  
Ministry of Transport  
c/o Agencia Havana  
Lampilla No2  
Havana  
Cuba  
Contact: Mr Miguel Izquierdo  
Job Title: Port Captain  
T: + 53 7 61 6706

### Mariel

**Port of Mariel**  
c/o Agencia Mariel  
Avenida 65 No 12411 124-126  
Apartado No 5  
Mariel  
Cuba  
Contact: Mr Manuel Ares  
Job Title: Director  
T: + 53 92305  
F: + 53 639 2510

### Matanzas

**Port Authority of Matanzas**  
c/o Agencia Matanzas  
Milanes No 28002  
Apartado No 245  
Matanzas  
Cuba  
Contact: Mr Orestes Bravo  
Job Title: Manager  
T: + 53 52 3804  
F: + 53 52 3804



**Puerto Tarafa Nuevitas**

**Port of Nuevitas**  
 Agencia Nuevitas  
 PO Box 350  
 Puerto Tarafa Nuevitas  
 Province de Camaguey  
 Cuba  
 Contact: Mr D Jose  
 Job Title: Manuel Torres  
 T: + 53 322 4646  
 F: + 53 322 4646

**Santiago de Cuba**

**Port of Santiago de Cuba**  
 Avenida Jesus Menendez No 658  
 Apartado No 522  
 Santiago de Cuba  
 Prov de Oriente  
 Cuba  
 Contact: Mr Ruben Callard  
 Job Title: Port Master  
 T: + 53 2262 8543  
 F: + 53 2268 6274

**CURACAO**

**Willemstad**

**Curacao Ports Authority**  
 Harbour Office  
 Werf de Wilde z/n  
 Willemstad  
 Curacao  
 Contact: Mr Dimitri Cloose  
 Job Title: Commercial & Marketing Manager  
 T: + 599 9 434 5922  
 F: + 599 9 461 3907  
 E: D.Cloose@curports.com  
 W: www.curports.com  
 uth Coast of Curacao at the Port of Willemstad or Fuikbay  
 3 multi-purpose cargo quays at Brionwharves at the Port of Willemstad, length: 305m, draught: 10.2m, plus platform for RO/RO  
 2 berths at Fuikbay, length: 109.7m, draught 7.3m, conveyer & loading tower with 8.53 fixed arm (150 tph)  
 Multi-purpose cargo (Willemstad), phosphate and limestone shipment, cement storage silos, 5,500 Tonnes (Fuikbay)

**CYPRUS**

**Nicosia**

**Cyprus Port Authority**  
 PO Box 2007  
 Nicosia  
 1516  
 Cyprus  
 Contact: Mr Y Kokkinos  
 Job Title: General Manager  
 T: + 357 2 450100  
 F: + 357 2 365420  
 E: cpa@cytanet.com.cy  
 W: kypros.org/CPA/

**Nicosia**

**Lemesos Port c/o Cyprus Port Authority**  
 PO Box 22007  
 Nicosia  
 1516  
 Cyprus  
 Contact: Captain George Poulos  
 Job Title: Port Manager  
 T: + 357 258 19200  
 F: + 357 255 66374  
 E: cpa@cpa.gov.cy  
 W: www.cpa.gov.cy  
 Latitude E 34 40° N  
 Longitude E 33 02° E  
 Conveyor belt, grabs, pneumatic machinery-vacuum  
 10.40-12m depth  
 Silo 70,000 ton capacity approximate

**Nicosia**

**Port of Vassiliko c/o Cyprus Ports Authority**  
 23 Crete Street,  
 Nicosia  
 1516  
 Cyprus  
 Contact: Captain G. Mousoulotis  
 Job Title: Operations Manager  
 T: + 357 248 15 225  
 F: + 357 246 35 630  
 E: gmousoulotis@cpa.gov.cy  
 W: www.cpa.gov.cy  
 Latitude 34° 43' .0 N  
 Longitude 033° 19' .0 E  
 Grabs & mobile shore cranes  
 9m depth, max draught 8.5m  
 20,000sqm  
 Private Port :  
 Operated by Vassiliko Cement Works Co.

**Nicosia**

**Vassiliko Cement Works Ltd**  
 PO Box 22281  
 Nicosia  
 1519  
 Cyprus  
 Contact: Mr Georgios Stavrou  
 Job Title: Technical Manager  
 T: + 357 24 845 504  
 F: + 357 24 332651  
 E: g.stavrou@vassiliko.com  
 W: www.vassiliko.com

**Nicosia**

**Vassiliko Port**  
 PO Box 22281  
 Nicosia  
 1519  
 Cyprus  
 Contact: Mr Marios Averkiou  
 Job Title: General Manager  
 T: + 357 24845305  
 F: + 357 24845413  
 E: m.averkiou@vassiliko.com

**DENMARK**

**Aabenraa**

**Aabenraa Havn Port Authority**  
 Aabenraa Port  
 Mellemvej 25  
 Aabenraa  
 DK 6200  
 Denmark  
 Contact: Mr Henrich  
 Job Title: Port Manager  
 T: + 45 74 62 25 14  
 F: + 45 74 62 31 43  
 E: port@aabenraakom.dk  
 W: www.aabenraaport.dk

**Aabenraa**

**Ensted Transit Harbour I/S**  
 Flensborgvej 185  
 Aabenraa  
 Sydjylland  
 DK-6200  
 Denmark  
 Contact: Mr Chresten Nissen  
 Job Title: Harbour Master  
 T: + 45 99 55 6689  
 F: + 45 74 62 0500  
 E: chmi@dongenergy.dk  
 W: www.dongenergy.dk  
 Port of Ensted is located at Aabenraa Inlet, 55°01,5'N 9°26,5'E - nautical map no. 159.  
 1 CSU & 1 GUL - 2,000 mtph  
 Import quay = 350m. Export quay = 325m.  
 115,000 m2  
 Ensted Transit Harbour is the largest transshipment terminal for coal in Northern Europe.

**Aalborg**

**Aalborg Bulk Terminal**  
 Østhaven  
 Aalborg  
 DK-9000  
 Denmark  
 Contact: Mr Lars Andersen  
 T: + 45 982 577 00  
 E: inter@mail.tele.dk  
 35,000 t  
 7,500sqm

**Aalborg**

**Aalborg Portland**  
 Rordalsvej 44  
 PO Box 165  
 Aalborg  
 DK 9100  
 Denmark  
 Contact: Mr Morten Knudsen  
 T: + 45 99 33 77 41  
 F: + 45 99 33 77 21  
 E: mk@aalborg-portland.dk  
 W: www.aalborg-portland.dk

**Aalborg**

**Port of Aalborg**  
 PO Box 8530  
 Langerak 19  
 Aalborg  
 9220  
 Denmark  
 Contact: Mr. Jasper  
 T: + 45 9930 1500  
 F: + 45 9930 1515  
 E: info@aalborghavn.dk  
 W: www.aalborghavn.dk  
 Denmark  
 3 mobile harbour cranes  
 Capacity about 200tph each  
 More berths. Up to 400m draught: Max: 9.30m  
 approx. 5,000sqm  
 approx. 4,000sqm

**Aarhus**

**Cargo Service A/S**  
 Oceanvej 13  
 Aarhus  
 DK 8000  
 Denmark  
 Contact: Mr Lars Krabbe  
 Job Title: Managing Director  
 T: + 45 8730 8000  
 F: + 45 8730 8101  
 E: info@cargoservice.dk  
 W: www.cargoservice.dk  
 Central Denmark  
 400,000sqm  
 17,000sqm

**Aarhus**

**Port of Aarhus**  
 PO Box 130  
 Mindet 2  
 Aarhus  
 DK - 8100  
 Denmark  
 Contact: Mr Bjarne Mathiesen  
 Job Title: Port Director  
 T: + 45 89 36 82 02  
 F: + 45 86 12 76 62  
 E: bm@port.aarhus.dk  
 W: www.aarushavn.dk

**Bandholm**

**Port of Bandholm**  
 c/o Knuthenborg Godskontor  
 Birketvej 1  
 Havnepladsen 6  
 Bandholm  
 4941  
 Denmark  
 Contact: Mr N A Hovmand  
 Job Title: Port Manager  
 T: + 45 54 76 36 11  
 F: + 45 53 88 80 11  
 E: alfr@hovmand.dk  
 W: www.hovmand.dk

**Charlottenlund**

**Copenhagen Merchants**  
 Lindegaardsvej 17  
 Charlottenlund  
 DK 2920  
 Denmark  
 Contact: Mr Simon Rodian  
 Christensen  
 T: + 45 3996 5308  
 F: + 45 3963 1057  
 E: src@copmer.dk  
 W: www.copmer.com  
 Kalundborg Bulk Terminal I/S:  
 Kalundborg, Denmark (North West of Zealand)  
 Fredericia Bulk Terminal I/S:  
 Fredericia, Denmark.  
 Aalborg Bulk Terminal: Aalborg, Denmark..  
 Grenaa Bulk Terminal, Grenaa, Denmark  
 Gdansk Bulk Terminal, Gdansk, Poland  
 CM Terminal, Banie, Poland  
 Danstore, Liepaja, Latvia  
 Kalundborg: 600-900 tph  
 Fredericia: 300-600 tph  
 Aalborg: 300-400 tph  
 Grenaa: 300-400 tph  
 Gdansk: 400 tph  
 Banie: 200 tph  
 Danstore: 1,000 tph  
 Kalundborg: 230 mt, 11.6 m draught (brackish)  
 Fredericia: 400m, 13.5 m draught  
 Aalborg: 400m, 9.5 m draught  
 Grenaa: 400m, 11.0 m draught  
 Gdansk: 150m, 7.6m draught  
 Liepaja: 450m, 10.0m draught  
 Kalundborg: 1,400 sqm  
 Capacity about 200tph each  
 More berths. Up to 400m draught: Max: 9.30m  
 approx. 5,000sqm  
 approx. 4,000sqm

**Esbjerg**

**Port of Esbjerg**  
 Hulvejen 1  
 Esbjerg  
 DK-6700  
 Denmark  
 Contact: Mr Sorens Stougaard  
 T: + 45 75 13 4144  
 F: + 45 75 13 4050  
 E: adm@portesbjerg.dk  
 W: www.port-of-esbjerg.dk

**Fredericia**

**Associated Danish Ports A/S**  
**Port of Fredericia**  
 Vesthavnsvej 33  
 Fredericia  
 DK-7000  
 Denmark  
 Contact: Mr Ole Haugsted  
 Jørgensen  
 Job Title: Sales & Marketing Manager  
 T: + 45 79 21 50 35  
 F: + 45 79 21 50 05  
 E: ohj@adp-as.dk  
 W: www.adp-as.com  
 Located at the Great Belt at the entrance to the Baltic Sea.  
 10 cranes (3 mobile). Capacity 500 - 600 tph/crane depending upon commodity.  
 Several bulk berths - water depths down to 15m, ice-free  
 20,000sqm  
 Specialized in direct discharge into trucks. Short distance to motorway system.

**Fredericia**

**DLA Agro**  
 Centerhavnsvej 13  
 Fredericia  
 DK-7000  
 Denmark  
 Contact: Ms Heidi  
 T: + 45 7921 2133  
 F: +45 79 21 21 79  
 E: jhl@dlaagro.com  
 W: www.dla.dk

**Fredericia**

**Fredericia Bulk Terminal c/o Fredericia Shipping**  
 Moellebugtvej 5  
 Fredericia  
 DK-7000  
 Denmark  
 Contact: Mr Johnny B. Nielsen  
 Job Title: Commercial Terminal Manager  
 T: + 45 76 20 20 20  
 F: + 45 76 20 20 25  
 E: bulk@fredericiashipping.dk  
 W: www.fredericiashipping.dk  
 Denmark, East coast of Jylland  
 Cranes/Conveyor - 600 tph load  
 Up to 14m draught - 350 m length  
 10,000sqm  
 12,000sqm

**Copenhagen**

**Copenhagen Malmo Port AB**  
 Containervej 9  
 PO Box 900  
 Copenhagen  
 DK-2100  
 Denmark  
 Contact: Mr Soren Balken  
 Job Title: Marketing Coordinator  
 T: + 45 3546 1112  
 F: + 45 3546 1164  
 E: soren.balken@cmport.com  
 W: www.cmport.com  
 Copenhagen Malmo Port is located in the Øresundregion with terminals in both Denmark and Sweden  
 CMP: 3 stationary cranes 20 tons  
 1 mobilecrane 64 tons, capacity  
 12,000 tonnes of coal a day

**Grenaa**

**Grenaa Bulk Terminal**  
Neptunvej 8  
Grenaa  
Denmark  
Contact: Mr Klaus Andersen  
T: + 45 76 20 20 02  
E: bulk@fredericiashipping.dk

**Grenaa**

**Port of Grenaa Ltd.**  
Grenaa Harbour  
Nordhavnsvej 1  
Grenaa  
8500  
Denmark  
Contact: Mr Henning Laursen  
Job Title: Manager  
T: + 45 87 58 76 00  
F: + 45 86 32 43 71  
E: info@port-of-grenaa.com  
W: www.port-of-grenaa.com

**Haderslev**

**Port of Haderslev**  
PO Box 11  
Havnekontar  
Honnoerkajen 3  
Haderslev  
6100  
Denmark  
Contact: Mr J C Hansen  
Job Title: Harbour Master  
T: + 45 7452 2404  
F: + 45 7452 5639  
E: jchansen@vip.cybercity.dk

**Horsens**

**Port Authority Horsens**  
Ove Jensens Alle 35  
Horsens  
8700  
Denmark  
Contact: Mr Peter Larsens  
Job Title: Port Manager  
T: + 45 75 62 10 14/14 33  
F: + 45 75 62 14 57  
E: pchl@horsens.dk  
W: www.horsenshavn.dk

**Kalundborg**

**Asnaes Power Station**  
Asnaes Port Authority  
Asnaesvej 16  
Kalundborg  
4400  
Denmark  
Contact: Mr Arne Krogh  
Job Title: Manager  
T: + 45 59 55 0600  
F: +45 9955 0699  
E: ark@e2.dk  
W: www.e2.dk

**Kalundborg**

**Kalundborg Bulk Terminal**  
Schultz Shipping A/S  
Vestre Havneplads 2  
Kalundborg  
DK-4400  
Denmark  
Contact: Mr Simon Rodian  
Christensen  
T: + 45 3996 5300  
F: + 45 3963 1057  
E: src@copmer.dk  
W: www.schultzshipping.com or  
www.copmer.dk

**Kalundborg**

**Kalundborg Port Authority**  
Baltic Plads 2  
Kalundborg  
4400  
Denmark  
Contact: Mr Bent Rasmusen  
Job Title: Port Director  
T: + 45 5953 4000  
F: + 45 5953 4003  
E: info@portofkalundborg.dk

W: www.portofkalundborg.dk  
At the head of a sheltered inlet in Kalundborg Fjord, on the W coast of Sjælland, at the Great Belt 2 gantry rocker cranes (on rail) each 300 ts/hour  
1 mob. harbourcrane 300 ts/hour  
1 mobile crane 200 ts/hour  
Suothharbour (12+13) 445 mtrs - draught 11,60 mtrs.  
Eastharbour (05+06) 320 mtrs - draught 9,60 mtrs.  
Eastharbour (09) 230 mtrs / - draught 7,50 mtrs  
Eastharbour (09) 245 mtrs / - draught 7,50 mtrs.  
Vestharbour (01) 250 mtrs - draught 5,30 mtrs  
46.500 sqm  
Cap. covered Grain Storage: 177.000 tons

**Kolding**

**Kolding Port Authority**  
Jens Holmsvej 1  
Kolding  
6000  
Denmark  
Contact: Mr Claus Holm  
Christensen  
Job Title: Harbour Master  
T: + 45 75 50 20 66  
F: + 45 75 50 20 58  
E: koldingport@kolding.dk  
W: www.koldinghavn.dk  
East Coast Jutland, Denmark  
2.4 km Quay, waterdepth 7m  
1 crane - max capacity 100ts  
6 mobile cranes, including three hydraulic  
60,000sqm  
40,000sqm  
Ships, cranes and open space operated by Port authority.  
Warehouses by commercial warehouse owners.

**Korsoer**

**Port of Korsøer**  
Amerikakajen 1  
Korsøer  
DK-4220  
Denmark  
Contact: Mr Jesper Kokholm  
Job Title: Harbour Master  
T: + 45 5837 0085  
F: + 45 5835 2598  
E: info@portofkorsøer.com  
W: www.portofkorsøer.com

**Naestved**

**Naestved Port**  
Toldbodgade 4  
Naestved  
4700  
Denmark  
Contact: Mr Jesper Pieteron  
Job Title: Harbour Master  
T: + 45 55 78 51 82 / +45 55 98 5200  
5598 5200  
F: + 45 55 72 51 83  
E: port@naestvedport.dk  
W: www.naestvedport.dk

**Nakskov**

**Nakskov Port**  
Havnegade 2  
Nakskov  
4900  
Denmark  
Contact: Mr Hans Borchensen  
Job Title: Harbour Master  
T: + 45 54 67 73 30  
F: + 45 54 92 51 13  
E: havne@lolland.dk  
W: www.nakskovhavn.dk

**Nykøbing Falster**

**Guldborgsund Havne**  
Port Office  
Fejøgade 2

Nykøbing Falster  
4800  
Denmark  
Contact: Laila Nielsen  
Job Title: Harbour Manager  
T: + 45 54 85 05 63  
F: + 45 54 82 05 64  
E: lel@guldborgsund.dk  
W: www.guldborgsundhavne.dk  
Isle of Falster  
Ports of Guldborgsund content:  
Port of Nykøbing Falster (Comm. Port)  
Port of Orehoved (Comm. Port)  
Port of Stubbekøbing (Comm. And)  
Port of Gedser (fishing port)

**Odense**

**Port of Odense**  
Londogade 1  
Odense  
5000  
Denmark  
Contact: Mr Finn Vinther  
Job Title: Harbour Master  
T: + 45 66 12 07 92  
F: + 45 65 91 47 74  
E: info@odensehaven.dk  
W: www.odensehavn.dk

**Randers**

**Randers Port**  
Kulholmsvej 1  
Randers  
8900  
Denmark  
Contact: Mr John Morgen  
Job Title: Harbour Director  
T: + 45 86 42 10 57  
F: + 45 86 40 71 81  
E: john.morgen@randers.dk  
W: www.randershavn.dk  
Close to the Eastcoast of Jutland, with access to the sea Kattegat  
One rail situated coal crane.  
Several mobile cranes of up to 140 t. Molasses pipe line connections of 6" and 8".  
Maximum size of vessel: LOA 145 m ; Breadth 19 m  
Several areas available for storage of cargo. Temporarily storage on keyside also possible.

**Rodby**

**Rodby Port Authority**  
c/o Scandlines  
Ostre Kaj 3  
Rodby  
4970  
Denmark  
Contact: Mr Torben Christensen  
Job Title: Port Captain  
T: + 45 54 605722  
F: + 45 54 605722  
E: torben.christensen@scandlines.dk

**Roenne**

**BAF (Bornholms Andels Foderstofforretning)**  
Port of Rønne  
Roenne  
Denmark  
Contact: Mr Cladio Pelsen  
Job Title: + 45 33 68 44 00  
T: + 45 5694 3000  
F: + 45 5694 3009  
E: info@baf.dk  
W: www.baf.dk

**Roenne**

**Port of Roenne Ltd.**  
Munch Petersens Vej 2  
PO Box 47  
Roenne  
3700  
Denmark  
Contact: Mr Hans Kumler  
Job Title: Port Director  
T: + 45 56 95 06 78  
F: + 45 56 95 06 31

E: hk@roennehavn.dk  
W: www.roennehavn.dk  
The Baltic  
2 Demac Cranes - Mc 300  
1 Liebherr 954 B  
Other commodities: Broken stone products.

**Roenne**

**Roenne Port Authority**  
Munch Peterson's Way no. 2  
Roenne  
3700  
Denmark  
Contact: Mr Hans Kumler  
Job Title: Harbour Master  
T: + 45 56950678  
F: + 45 56950631  
E: hk@roennehavn.dk

**Skaelskor**

**Skaelskor Port Authority**  
Skaelskor Havnekortoret  
Naestvedvej 15  
Skaelskor 4230  
Denmark  
Contact: Mr Jacob Lund  
T: + 45 58 19 80 17  
F: + 45 53 59 03 57  
E: skaelskor-havn@skaelskor.dk

**Skaelskor**

**Stignaesvaerkets Port Authority**  
S K Energi  
Sjællandske Kraftvaerker  
Stignaesvaerker  
Skaelskor  
4230  
Denmark  
Contact: Mr John Slangerup  
Slangerup  
Slangerup  
Job Title: Port Manager  
T: + 45 58 16 40 00  
F: + 45 58 16 40 40  
E: sla@e2.dk

**Skoodstrup**

**Studstrup Port Authority**  
Elsam t-Strudstrupvaerker  
Skoodstrup  
8541  
Denmark  
Contact: Mr Paul Rokkaer  
T: + 45 87 49 17 00  
F: + 45 87 49 17 73  
E: pro@elsam.com

**Vordingborg**

**Vordingborg Port Authority**  
Harbour Office  
Valdemarsgade 43  
Vordingborg  
Sjælland 4760  
Denmark  
Contact: Mr Claus Christensen  
Job Title: Harbour Master  
T: + 45 55 362461  
F: + 45 55 362500  
E: clch@vordingborg.dk  
W: www.vordingborg-shipping.com

**DOMINICAN**

**REPUBLIC**

**Santa Domingo**

**Port of Santo Domingo**  
c/o Maritima Dominicana SA  
PO Box 1301  
Carretera Sanchez KM  
Santa Domingo  
12 1/2  
Dominican Republic  
Job Title: Harbour Master  
T: + 1809 593 5904  
F: + 1809 592 0910  
E: mail@fschad.com

**Santo Domingo**

**Agencias Navieras B&R, S.A.S**  
Av. Abraham Lincoln No. 504, Torre B&R  
Santo Domingo  
Distrito Nacional  
Dominican Republic  
Contact: Mr Jeff Rannik  
Job Title: President - CEO  
T: + 1 809 793 7000  
F: + 1 809 562 3383  
E: chartering@navierasbr.com, ops@navierasbr.com  
W: www.navierasbr.com  
Dominican Republic (Caribbean)  
According to Owners' request.  
According to Owners' request.  
According to Owners' request.  
Agencias Navieras B&R is the oldest ship agency and stevedoring company of our country with lengthy experience handling bulk carriers and multiple commodities across all Dominican ports.

**Santo Domingo**

**Cabo Rojo Port Authority**  
Maritima Dominicana SA  
PO Box 1301  
Santo Domingo  
Dominican Republic  
Job Title: Port Master  
T: + 1 809 537 0055  
F: + 1 809 537 1706  
E: sugerencia@apordom.gov.do  
W: www.apordom.gov.do

**Santo Domingo**

**Maritima Dominicana SA**  
PO Box 1301  
Carretera Sanchez Km 12 1/2  
Santo Domingo  
Dominican Republic  
Contact: Mr Karsten Windeler  
Job Title: President  
T: + 1 809 539 6000  
F: + 1 809 539 7200  
E: info@mardom.com  
W: www.mardom.com  
Rio Haina, south coast of the Dominican Republic.  
Grabs of up to 12 cu yds capacity, hoppers and payloaders.  
Several berths with up to 10m draught.

**ECUADOR**

**Guayaquil**

**Port Authority of Guayaquil**  
PO Box 5739  
Puerto Maritimo  
Guayaquil  
Guayas Province  
Ecuador  
Contact: Mr Luz Rendón  
Job Title: Secretary  
T: + 593 4 268 7930  
F: + 593 4 2687931  
E: irendon@jantaylor.com  
W: www.puertodeguayaquil.com

**EGYPT**

**Alexandria**

**Alexandria Port Authority**  
106 El-Horreyya Avenue  
Alexandria  
Egypt  
Contact: Mr Mohamad Sammy  
Job Title: General Manager  
T: + 203 4843532 / 4 / 8 / 487 4321  
22 23  
F: + 20 3 48 69177  
E: agency@imsalex.com  
W: www.apa.gov.eg



**Alexandria**

**Kamaria Grain Terminal**  
106 EL Horreya Street  
Alexandria  
Egypt  
Contact: Admiral Ahmed Hamiea  
Job Title: General Manager  
T: + 20 3 483 1640  
F: + 20 3 48 07245

**Cairo**

**Abu Zenima Port Authority**  
Sinai Manganese Co SAE  
Head Office  
1 Kasr El Nil Street  
Cairo  
Egypt  
Contact: Mr Hassan Eid  
Job Title: Chairman  
T: + 20 2 574 1096  
F: + 20 2 574 0142  
E: info@smc.eg.com

**Cairo**

**El Sokhna Port Development Company**  
10 Abo-Gaafar Al-Nahaas St  
Al-Nozha St., Ard El Golf  
Heliopolis  
Cairo  
Egypt  
Contact: Captain Ossama Al-Sharif  
T: + 20 2 37103222/ 3710320  
F: + 20 2 3331117/3321120  
E: redseaut@idjcl.gov.eg

**Cairo**

**El Wadi Holdings**  
Mohandseen  
Cairo  
Mohandseen  
00202  
Egypt  
Contact: Mr Tony Freiji  
Job Title: Vice President  
T: + 202 330 43 837  
F: + 202 3344 71 36  
E: amira\_hussien@medsofts.net  
W: www.wadigroup.com

**Cairo**

**Medsofts**  
40, 206St. Degla  
Cairo  
Maadi  
00202  
Egypt  
Contact: Mr Tarek Tawfik  
Job Title: General Manager  
T: + 202 27 05 89 13  
F: + 202 27 54 40 54  
E: lawfik@medsofts.net  
W: www.medsofts.net

**Cairo**

**Sinai Manganese Co S A E**  
1 Kasr El Nil Street  
Cairo  
Egypt  
Contact: Mr Sinai Manganese  
Job Title: Managing Director  
T: + 20 2 574 1096  
F: + 20 2 574 0142  
E: info@smc.eg.com

**Damietta**

**Damietta Port Authority**  
PO Box 13  
Damietta  
345511  
Egypt  
Contact: Mr Ossoma Kamel  
Job Title: Chairman  
T: + 20 57 325940  
F: + 20 57 325930  
E: contactus@dam-port.com  
W: www.dam-port.com

**Damietta**

**Mina Damyat Terminal**  
PO Box 13  
Damietta  
345511  
Egypt  
Contact: Mr Ibrahim Shafik  
Job Title: General Manager  
T: + 20 57 325 940  
F: + 20 57 325 930

**Hamrawein**

**Hamrawein Port Authority**  
4, Ptolemy Street  
Bab Sharky  
Hamrawein  
Alexandria  
21514  
Egypt  
T: +20 65 342 0124  
F: +20 65 342 0124  
E: contact@mts.gov.eg  
W: http://www.mts.gov.eg

**Ismailia**

**Port Authority of Safaga**  
c/o The Suez Canal Authority  
Ismailia  
Egypt  
Contact: Com Serrag Emaria  
Job Title: Port Manager  
T: + 20 065 45 1222  
F: + 20 062 33 1126  
E: info@pan-marine.net  
W: www.mts.gov.eg

**Ismailia**

**Suez Canal Authority**  
Depart. Of Planning, Research & Studies  
Information Centre - Library  
Ismailia  
41515  
Egypt  
Contact: Ms Dina Emaria  
Job Title: Librarian  
T: + 20 064 3910000  
F: + 20 064 3914784  
E: euscaeg@yahoo.com

**Port Said**

**Port Said Port Authority**  
Intersection of Mostafa Kamel and Azmy Street  
Railway Square  
Port Said  
Egypt  
Contact: Adm M Maged Hamza  
Job Title: Chairman  
T: + 20 66 3348270  
F: + 20 66 3348262  
E: info@psdports.org  
W: www.psdports.org

**Port Tewfik**

**Red Sea Port Authority**  
PO Box 1  
Port Tewfik  
Suez  
Egypt  
Contact: Vice Adm Thanaa Ahmed Kamel  
Job Title: Chairman  
T: + 20 62 220740  
F: + 20 62 226761  
E: mmt@idjcl.net.eg  
W: www.mts.gov.eg

**Safaga**

**Safaga Grain Berth No1**  
Ports and Lights Administration  
Safaga  
Egypt  
Contact: Cdr Serrag Emaria  
Job Title: Harbour Master  
T: + 20 65 45 12222  
F: + 20 62 33 1126  
E: info@ramseystours.com  
W: http://safagaport.com

**EL SALVADOR**

**Acajutla**

**Port of Acajutla**  
CEPA  
Zona Industrial  
Acajutla  
El Salvador  
Contact: Mr Francisco Portillo  
Job Title: Engineer  
T: + 503 452 3145  
F: + 503 452 3145  
E: webmaster@cepa.gov.sv  
W: www.puertoacajutla.gov.sv

**ERITREA**

**Assab**

**Assab Port Administration**  
PO Box 58  
Assab  
Eritrea  
Contact: Mr Mohammed Said Jassir  
Job Title: Port Manager  
T: + 291 11 552 431  
F: + 291 13 552 157  
E: contact@ecss-online.com

**ESTONIA**

**Tallinn**

**AS Baltic Chemical Terminal**  
Narva mnt. 7d  
Tallinn  
Harjumaa  
10117  
Estonia  
Contact: Ms Julia Smirnova  
T: + 372 66 46 507  
F: + 372 62 61 100  
E: j.smirnova@bct.ee  
W: www.bct.ee  
Sillamae, East of Estonia  
Output of over 1 million tons of ammonia and 1 million tons of UAN  
For liquid commodities - up to 13m at the deepest berths  
120,000 m3  
AS BCT (Baltic Chemical Terminal) is a modern and high-tech terminal for handling liquid fertilizers to Europe and throughout the world.

**Tallinn**

**AS Coal Terminal**  
4a, Joe Street  
Tallinn  
10151  
Estonia  
Contact: Ms Nadia Manzhos  
Job Title: Office Manager  
T: + 372 626 36 52  
F: + 372 630 36 53  
E: info@coalterminal.ee  
W: www.coalterminal.ee  
Located in the eastern part of the largest port in Estonia, Muuga, which almost never freezes; it is situated within 210km from the Russian border.  
Equipment: 2 stackers, 2 retrievers, 2 vessel loaders, a carriage dumper  
Capacity 5 000 000 tn per year  
Berth 31: length 210m, depth 11m;  
Berth 33: length 198 m, depth 11m;  
Berth 32: length 365m, depth 17.5m  
45,000sqm

**Tallinn**

**PETROMAKS SPEDIITORI AS**  
Nolva 9A  
Tallinn  
10416  
Estonia  
Contact: Mrs Kadi Neemelaid  
Job Title: Economic Expert  
T: + 372 650 7702  
F: + 372 650 7700  
E: kadi@pmg.ee  
W: www.petromaks.com

**Tallinn**

**AS DBT (Dry Bulk Terminal)**  
13 Korma Street  
Haabneeme alevik, Viimsi vald,  
Harjumaa  
Tallinn  
74115  
Estonia  
Contact: Mrs Viktoria Jurjeva  
Job Title: Head of External

Relations & Commercial Department  
T: + 372 66 46 509 / + 372 6 319 389  
F: + 372 6 319 189  
E: vika@dbtmuuga.ee  
W: www.dbtmuuga.ee  
Muuga Harbour  
1 gantry crane and 1 shiploader  
1 berth 288 m long and 14,5 m deep  
14,800 sqm  
Storage capacity 192 000 tons  
Storage in a Customs Free Zone in 1 arched type warehouse and 8 domes, transport logistics, forwarding services, blending and bagging facility, container-stuffing (big-bags or bulk) services.

**Tallinn**

**AS MGT Muuga Grain Terminal**  
57 Maardu Street  
Tallinn  
74115  
Estonia  
Contact: Capt. Artur Kivistik  
Job Title: Port Director  
T: + 372 6319 521  
F: + 372 6319 544  
E: mgt@mgt.ee  
W: www.mgt.ee  
Estonia, Baltic Sea  
4 unloaders - 2500 mt/h  
1 loader - 1200 mt/h  
2 berths, length- 300m each, depth- 17,4 m  
silo - 300 000 mt  
import capacity - 5 mln.mt/ year  
export capacity - 3 mln.mt/ year  
grain laboratory  
railcar/truck loading/unloading certificate ISO 9001:2000

**Tallinn**

**KS Stevedoring**  
Paljassaare Harbour  
Paljassaare tee 28E,  
Tallinn  
10313  
Estonia  
Contact: Mr Mati Roosioja  
Job Title: Executive Director  
T: + 372 6100 999  
E: mati.roosioja@stevedore.ee  
W: www.stevedore.ee

**Tallinn**

**Muuga (Novotallinsi)**  
Maardu tee 57  
Tallinn Eesti Vabariik  
Tallinn  
EE 0030  
Estonia  
Contact: Mr Anatoliy Kanaev  
Job Title: Port Director  
T: + 372 6 319 205  
F: + 372 2 234 313  
E: tk@tk.ee

**Tallinn**

**PETROMAKS SPEDIITORI AS**  
Nolva 9A  
Tallinn  
10416  
Estonia  
Contact: Mrs Kadi Neemelaid  
Job Title: Economic Expert  
T: + 372 650 7702  
F: + 372 650 7700  
E: kadi@pmg.ee  
W: www.petromaks.com

**Tallinn**

**Port of Tallinn**  
Sadama 25  
Tallinn  
15051  
Estonia  
Contact: Mr Margus Sitsi  
Job Title: Business Manager  
(General cargo, dry bulk, Ro-Ro)

T: + 372 631 8 467  
E: m.sitsi@ts.ee  
W: www.portof tallinn.com  
South Coast of the Finnish Gulf in the Baltic Sea  
Dedicated coal, grain & fertilizers terminals in Muuga Harb our. Scrap metal, gravel, peat, wood pellets and other dry cargo handled in Paldiski South Harbour.  
Services provided by terminal operators - list available at www.portof tallinn.com/terminal-operators  
Up to 20 berths for different bulk cargo. Max draught ca 17 m; max length of the vessel - 300m  
1,137,000 sqm  
160,000 sqm / 6,900 sqm reefer warehouse  
Port of Tallinn - large vessels, high loading/unloading speed and free terminals capacity - efficient corridor for cargo transportation between east and west.

**Viimsi Vald**

**AS Stivis**  
1 Koorma Street  
Viimsi Vald  
74115  
Estonia  
T: + 372 600 3872  
F: + 372 600 3873  
E: stivis@stivis.ee  
W: www.stivis.ee

**FIJI**

**Suva**

**Ports Authority of Fiji**  
PO Box 780  
Suva  
Viti Levu  
Fiji  
Contact: Mr Ben Naidu  
Job Title: Chairman  
T: + 679 331 2700  
F: + 679 330 0064  
W: www.fijiports.com.fj

**FINLAND**

**Hamina**

**Port of Hamina Ltd**  
PO Box 14  
Hamina  
49401  
Finland  
Contact: Mr Esa Eerikainen  
Job Title: Port Manager  
T: + 358 5 225 5400  
F: + 358 5 749 5419  
E: esa.eerikainen@portofhamina.fi  
W: www.portofhamina.fi

**Kokkola**

**Oy M Rauanheimo Ab**  
PO Box 254  
Kokkola  
FIN - 67101  
Finland  
Contact: Mr Joakim Laxaback  
Job Title: Managing Director  
T: + 358 50 387 3303  
F: + 358 20 777 1320  
E: joakim.laxaback@rauanheimo.com  
W: www.rauanheimo.com

**Kokkola**

**Port of Kokkola**  
Satamatatu 53  
Kokkola  
67900  
Finland  
Contact: Mr Torbjörn Witting  
Job Title: Port Director  
T: + 358 68 2424 00  
E: torbjorn.witting@kokkola.fi

# Major bulk port in Finland

## Port of Pori

*The port of all size vessels*

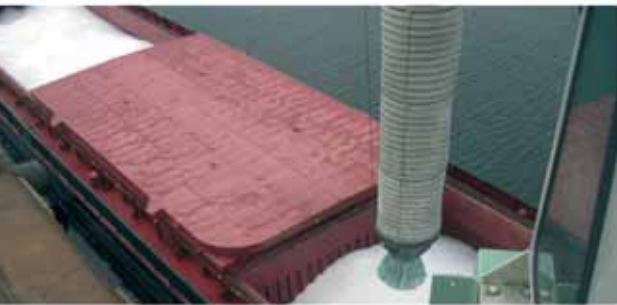

## The strengths of the Port of Pori

- Dust minimized loading and unloading systems in use
- Suitable for large volumes
- Deep fairway (15.3m) and the best ice conditions in Finland
- Uncongested hinterland connections
- Room to expand, free areas available for dry and liquid bulk
- Located far from dense housing areas
- Environmental and work safety as top priorities

### Reachability (by truck)

- Within 3 hrs. of Pori
- Within 6 hrs. of Pori

### New 12m quay!

For more info go to:  
[www.portofpori.fi/en](http://www.portofpori.fi/en)



Port of Pori | Merisatamantie 4, FI-28880 PORI, FINLAND  
Tel: + 358 (0)2 621 2600 | Fax: + 358 (0)2 634 9498  
[info.port@pori.fi](mailto:info.port@pori.fi) | [www.portofpori.fi/en](http://www.portofpori.fi/en)





W: www.port.of.kokkola.fi  
The Port of Kokkola is the largest of the four major ports located along the coast of Ostrobothnia, Finland. Conveyor systems from railway wagons into the warehouses and from the warehouse with loading conveyor systems into the vessel's hold.

Multipurpose 40 ton cranes on rails. 13m draught in the Deep Port, allowing Panamax class vessels of up to 80,000 DWT  
Warehouses and terminals: A total of 70,000 sqm of covered warehouse space

### Kotka

**Port Of Kotka Ltd**  
PO Box 196

Kotka  
48101  
Finland  
Contact: Mrs Nanna Sirola  
Job Title: Marketing Manager  
T: + 358 20790 8800  
F: + 358 20 790 8891  
E: nanna.sirola@portofkotka.fi  
W: www.portofkotka.fi

### Kotka

**Steveco Oy**  
PO Box 44

Kotka  
48101  
Finland  
Contact: Mr Tapio Mattila  
Job Title: Director of Marketing and Development  
T: + 358 5 232 3502  
F: + 358 5 232 3392  
E: tapio.mattila@steveco.fi  
W: www.steveco.fi  
South East of Finland on the south coast  
4 multi-purpose cranes, 1 shiploader  
Length 600m, depth 13.5 - 15.3m  
20,000sqm  
30,000sqm  
Steveco offers handling and warehousing services for dry bulk such as fertilisers and paper fillers. In the future Steveco will concentrate on project cargoes.

### Kotka

**UPM Logistics**  
Kirkkokatu 1

PO Box 224  
Kotka  
48101  
Finland  
Contact: Mr Jukka Holsa  
Job Title: Director, Maritime and Port Network  
T: + 358 2041 55920  
F: + 358 2041 5190  
E: jukka.holsa@upm.com  
W: www.upmseaways.com  
255m with roro ramp, draught 7.3m  
12,000sqm

### Loviisa

**Port of Loviisa**

Loviisa  
Valko  
FI-07910  
Finland  
Contact: Mr Aki Marjasvaara  
Job Title: Port Director / Harbour Office  
T: + 358 19 555 1  
E: aki.marjasvaara@loviisa.fi  
W: www.loviisa.fi

### Naantali

**Port of Naantali**  
Satomatie 13  
Naantali  
21100

Finland  
Contact: Mr Yrjo Vainiala  
Job Title: Port Director  
T: + 358 2 437 5511  
F: + 358 2 435 1727  
E: yrjo.vainiala@naantali.fi  
W: www.naantali.fi

### Naantali

**Port of Oikiluoto**

PL 41  
Naantali  
21101  
Finland  
Contact: Mr Jussi Malkia  
T: + 358 400 785 489  
F: + 358 5 531 320  
E: jussi.malkia@meriaura.fi  
W: www.meriaura.fi/  
PrivatePortOfOikiluoto.html

### Oulu

**Herman Andersson Oy**  
PO Box 37

Oulu  
90401  
Finland  
Contact: Mr Jari Ramtamaula  
Job Title: Managing Director  
T: + 358 8 315 0100  
F: + 358 8 371743  
E: info@hermanandersson.fi  
W: www.hermanandersson.fi

### Oulu

**Oulu Stevedoring Oy**

PO Box 16  
Oulu  
90400  
Finland  
Contact: Mr Kari Himanen  
Job Title: Port Director  
T: + 358 8 5584 2750  
F: + 358 8 5584 2799  
E: kari.himanen@ouka.fi

### Oulu

**Port of Oulu**

PO Box 23  
Oulu  
90015 Oulun Kaupunki  
Finland  
Contact: Mr Kari Himanen  
Job Title: Port Director  
T: (Director) + 358 44 703 2750 / 3  
F: + 358 8 5584 2799  
E: kari.himanen@ouka.fi  
W: www.ouluport.com

### Pori

**Port of Pori**



Porin Satama  
Merisatamantie 13  
Pori  
28880  
Finland  
Contact: Mr Jaakko Nirhamo  
Job Title: Port Director  
T: + 358 2 621 2601  
F: + 358 2 621 2630  
E: jaakko.nirhamo@pori.fi  
W: www.pori.fi/port  
Port of Pori is centrally located on the west coast of Finland with fast access to the hinterlands.  
- 13x Cranes, 1x Loader, 1x Stackers.  
Lifting capacity 6-200 t  
Max draught 10m-15.3m.  
Quay length 2,700m  
110,500sqm

### Raah

**Port of Raah**

Lapaluodontie 342  
Raah  
92180  
Finland  
Contact: Mr Karo Hikkonen  
T: + 358 08 439 3930  
F: + 358 82 22 37 155  
E: karo.hikkonen@raah.fi

### Rauma

**Euroports Rauma (previously OY Rauma Stevedoring)**

Hakunintie 23  
PO Box 68  
Rauma  
FIN-26101  
Finland  
Contact: Mr Juha Vannio  
Job Title: Sales and Marketing Manager  
T: + 358 2 83 121  
F: + 358 2 8312 444  
E: juha.vannio@euroports.fi  
W: www.euroports.com  
West Coast of Finland  
Lifting capacity with shore cranes 200 ton  
abt 240,000sqm, 30,000sqm heated storages  
Break bulk, heavy lifts and project shipments.

### Rauma

**Port of Rauma Authority**

Hakunintie 19  
Rauma  
26100  
Finland  
Contact: Mr Hannu Asumalahti  
Job Title: Port Director  
T: + 358 2 834 4712  
F: + 358 2 822 6369  
E: harbour.office@portofrauma.com  
W: www.portofrauma.com

### Turku

**Port of Turku Authority**

Juhana Herttuan puistikatu 21  
Turku  
FIN-20100  
Finland  
Contact: Mr Kari Riutta  
Job Title: Harbour Master  
T: + 358 2 2674 123  
F: + 358 2 2674 125  
E: kari.riutta@turku.fi  
W: www.portofurku.fi  
South West Finland  
Shore cranes and grabs available.  
New mobile crane with 20 tons capacity.  
Depth 6.5m to 8.0m  
Grain silo available  
Port of Turku is mainly a passenger and ro-ro port but small amounts of bulk are handled such as grain and soya.

### Vaasa

**Port of Vaasa**

PO Box 2  
Vaasa  
65101  
Finland  
Contact: Mr Lars Holmqvist  
Job Title: Port Director  
T: + 358 6325 4500 / +358 400 680 199  
F: + 358 6 325 4514  
E: lars.holmqvist@vaasa.fi  
W: www.vaasa.fi/port  
West coast of Finland  
100,000 sqm approx.  
30,000 sqm

### Vantaa

**Suomen Viljava Oy**  
Kielotie 5 B  
Vantaa

01300  
Finland  
Contact: Mr Hannu Korteesmaa  
Job Title: Marketing Manager  
T: + 358 10 3464 204  
F: + 358 01 3464 200  
E: hannu.korteesmaa@suomenviljava.fi  
W: www.suomenviljava.fi  
16 inland grain storages in Finland  
5 port terminals for grain in Finland  
At port terminals capacity 250-500tph  
Oat fibre (betaglucane) factory in Kokemäki, Finland (business to business product).

## FRANCE

### Bassens

**CIMALIT**

Zone Portuaire  
Quai Alfred de Vial  
Bassens  
33530  
France  
Contact: Mr Christina Moracchini  
Job Title: Managing Director  
T: + 33 5 57 77 56 56  
F: + 33 5 57 77 56 50  
E: cimalit@wanadoo.fr  
W: www.cimalit.com

### Bassens

**Gemadocks**

Supporting and auxiliary transport  
Zi Bellerive Avenue des Moines  
Bassens  
33530  
France  
Contact: Mr Franck Humbert  
Job Title: Director  
T: + 33 5 56 31 50 34  
F: + 33 5 56 74 71 10

### Bassens

**Sea-invest Bordeaux**

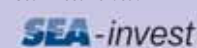

Rue Richelieu 1  
Bassens  
33530  
France  
Contact: Mr Franck Humbert  
T: + 33 557 77 49 51  
F: + 33 557 77 82 11  
E: franck.humbert@sea-invest-france.com  
W: www.sea-invest.be

### Bassens

**Ste Aquitaine du Silo de Bordeaux-Bassens**

10 Quai Alfred de Vial  
Bassens  
33530  
France  
Contact: Mr Yannick M Collet  
Job Title: General Manager  
T: + 33 556 33 47 00  
F: + 33 556 06 22 76

### Blainville Sur Orne

**SOGEMAR**

Zi Caen Canal  
Blainville Sur Orne  
14550  
France  
Contact: Mr Douglas Draper  
Job Title: Agency/Stevedoring  
T: + 33 231 35 65 68  
F: + 33 231 720 520  
E: d.draper@sogemar-caen.com  
W: www.sogemar-caen.com/

### Blaye

**Blaye Grain Terminal**

Silo Portaire  
BP 15  
Blaye 33390

France  
Contact: Mr Rabu  
T: + 33 557 42 0307  
F: + 33 557 42 3918

### Bordeaux

**Bordeaux Port Authority**

Palais de la Bourse  
3, Place Gabriel  
Bordeaux  
Cedex 33075  
France  
Contact: Mrs Laurence Bouchardie  
Job Title: Commercial & Communications Manager  
T: + 33 5 56 90 59 93  
F: + 33 5 56 90 58 78  
E: l-bouchardie@bordeaux-port.fr  
W: www.bordeaux-port.fr  
South West of France, on the Atlantic seaboard  
4 Cranes of 34 tons - 700 tph each one  
Bulks berthes at Bassens (44m) are operated by Sea-Invest Bordeaux  
Company/mail: trambod@sea-invest-france.com and Baluerie Company  
www.balguerie.com  
90 000 sqm

### Bordeaux

**SAIPOP**

Port of Bordeaux  
Bordeaux  
France  
Contact: Mr Asneres  
Job Title: Director  
T: + 33 5 57 80 87 50  
F: + 33 5 57 80 87 69  
E: sofiproteol@prolea.com

### Bordeaux

**SEMABLA**

Port of Bordeaux  
Bordeaux  
France  
Contact: Mr Jean-François Rabu  
T: + 33 5 57 42 74 91  
F: + 33 5 57 42 39 18  
E: jf.rabu@sodistock.fr

### Bordeaux

**SPBL**

Port of Bordeaux  
Bordeaux  
France  
Contact: Mr Th. Audiger  
T: + 33 5 57 77 84 50  
F: + 33 5 57 77 84 51

### Boucau

**Maisica**

Quai du Base  
Port de Bayonne  
Boucau  
64340  
France  
Contact: Mr Michel Prileno Izac  
Job Title: Director  
T: + 33 5 59 64 6342  
F: + 33 5 59 64 5718  
E: contact@maisica.com  
W: www.ports-basques.com/ports/bayonne

### Brest

**CCI - Chambre de Commerce et d'Industrie**

Quai 6th Sud, Zone Industrielle  
Portuaire  
BP 126  
Brest 29200  
France  
Contact: Mr Bon  
Job Title: Operations Manager  
T: + 33 02 98 00 38 00  
F: + 33 02 98 00 39 02  
E: info@cci-brest.fr  
W: www.cci-brest.fr

# DUNKERQUE

## THE FRENCH PORT FOR DRY BULK

Accessible to ships with draughts of 14.20 metres via the De Gaulle Lock, the Central Port is the location for many industries. It includes the grain and multibulk terminals, as well as the raw materials reception facility for the ArcelorMittal steel works.



 **DUNKERQUE**  
PORT

 /dunkerqueport

[www.dunkerque-port.fr](http://www.dunkerque-port.fr)

 /dunkerqueport



**Brest**

**Port of Brest - CCI**  
 1, avenue de Kiel  
 Brest  
 Brittany F-29200  
 France  
 Contact: Mr Gilles Fourré  
 Job Title: Port Manager  
 T: + 33 298 46 23 80  
 F: + 33 298 43 24 56  
 E: info@brest.port.fr  
 W: www.brest.port.fr  
 48° 23' 8" N, 4° 28' 8" W, Head of Europe  
 9 cranes  
 3 conveyors belts (1 000 tons / hour)  
 4 berths, 175m, 110m, 230m, 300m, draft from -6 m to -12m  
 70 000 sqm  
 160 000 tons  
 Rail connection, linkspan  
 5 mobiles cranes

**Brest**

**Port of Brest - CCI**  
 1 Avenue de Kiel  
 Brest 29200  
 France  
 Contact: Mr Jean Hattenville  
 Job Title: Sales Executive  
 T: + 33 2 98 46 87 46  
 F: + 33 2 98 43 24 56  
 E: jch@cci-brest.fr  
 W: www.brest.port.fr  
 A deep-water port on the leading edge of Europe

**Brest**

**Port of Brest Dry Bulk Terminal**  
 Avenue de KIEL  
 Brest 29200  
 France  
 Contact: Mr Jean-Christophe Hattenville  
 T: + 33 298 46 23 80  
 F: + 33 298 43 24 56  
 E: jean-christophe.hattenville@port.cci-brest.fr  
 W: www.brest.port.fr  
 48° 23' 8" N, 4° 28' 8" W  
 Brest is located in the heart of the Atlantic Arc. The port is a gateway to France, Europe and a connection to ongoing worldwide sailings.  
 9 cranes  
 3 conveyors belts (1 000 tons/hour each)  
 2 mobile cranes  
 Loading/unloading rail/road station (9 000 tons/day)  
 4 berths from 175m to 300m length  
 Draft from 6m to 12m  
 160 000 tons (7 warehouses + 8 vertical silos)  
 The terminal is enclosed, guarded 24/24h and controlled by video-surveillance; ISPS approved; ISO 9001-2000.  
 2004 Figures  
 Agro bulks : 644 000 tons  
 Oils / Molasses : 146 400 tons  
 Clinkers/cement : 130 652 tons  
 Sand/aggregates : 120 409 tons  
 Steel products/metal scraps : 78 817 tons  
 Other : 37 000 tons

**Calais**

**Port of Calais**  
 Chambre Du Commerce  
 24 Blvd. Des Allies  
 Calais  
 Cedex 62104  
 France  
 Contact: Mr Patrick Fourgeaud  
 Job Title: General Manager  
 T: + 33 321 460 000  
 F: + 33 321 460 099  
 E: patrickfourgeaud@calais.cci.fr  
 W: www.calais-port.com/

**Cedex 1**

**Atlantic Port La Rochelle**  
 17001 La Rochelle  
 Cedex 1  
 BP 70394  
 France  
 Contact: Ms Patricia Hagerly  
 Job Title: Marketing & Sales  
 T: + 33 5 46 00 7492  
 F: + 33 5 46 43 19 28  
 E: p.hagerly@alrochelle.port.fr  
 W: www.larochelle.port.fr

**Cherbourg-Octeville**

**Port de Cherbourg**  
 Port de Cherbourg SAS  
 Quai de Normandie  
 BP 50231  
 Cherbourg-Octeville  
 Cedex  
 50102  
 France  
 Contact: Mr Thierry Lenepveu  
 Job Title: Development Manager  
 T: + 33 2 33 236453  
 F: + 33 2 33 236455  
 E: tlenepveu@portdecherbourg.fr  
 W: www.port-cherbourg.com

**Dieppe**

**Dieppe Port**  
 Capitainerie, Quai de la Cale  
 No 1  
 Dieppe  
 Seine Maritime  
 76203  
 France  
 Contact: Mr Thierry Brocquet  
 Job Title: Harbour Master  
 T: + 33 235 841 055  
 F: + 33 235 06 12 56  
 E: marc1.david@equipement.gouv.fr  
 W: www.portdedieppe.fr  
 South of England, close to Newhaven  
 4 cranes on rails with each 2 wagons of 2.2 tons capacity,  
 1 crane on rails with 2 trolleys of 2.5 tons capacity each,  
 3 railed hoisting cranes of 8 tons capacity at 25m (6 tons capacity at 32m, 3 tons capacity at 40m),  
 1 mobile crane of 40 tons capacity at 24m (30 tons capacity at 30m)  
 1 mobile crane of 63 tons capacity at 20m (38.7 tons capacity at 30m, 27.2 tons capacity at 38m)- (april 2008)  
 Quay of Norway, 700m long, berthing on 678m Quay of India, 150m long, berthing on 135m Quay of Morocco, 675m long, berthing on 555m  
 Open quay surface of 10000m2 at Quebec quay  
 Open quay surface of 18000m2 at Paris dock (Marocco & Norway quays)  
 More than 20000m2 shed storage in Paris dock  
 8000m2 refrigerated shed at Marocco quay  
 Maximum vessels' dimensions  
 160m LOA, 24m breadth, 9m draught  
 Vessels' inbound/outbound traffic taking place from 2h before to 1h after high tide  
 Contact with "Dieppe port" on VHF channel 12.

**Dieppe**

4 cranes on rails with each 2 wagons of 2.2 tons capacity,  
 1 crane on rails with 2 trolleys of 2.5 tons capacity each,  
 3 railed hoisting cranes of 8 tons capacity at 25m (6 tons capacity at 32m, 3 tons capacity at 40m),  
 1 mobile crane of 40 tons capacity at 24m (30 tons capacity at 30m)  
 1 mobile crane of 63 tons capacity at 20m (38.7 tons capacity at 30m, 27.2 tons capacity at 38m)- (april 2008)  
 Quay of Norway, 700m long, berthing on 678m Quay of India, 150m long, berthing on 135m Quay of Morocco, 675m long, berthing on 555m  
 Open quay surface of 10000m2 at Quebec quay  
 Open quay surface of 18000m2 at Paris dock (Marocco & Norway quays)  
 More than 20000m2 shed storage in Paris dock  
 8000m2 refrigerated shed at Marocco quay  
 Maximum vessels' dimensions  
 160m LOA, 24m breadth, 9m draught  
 Vessels' inbound/outbound traffic taking place from 2h before to 1h after high tide  
 Contact with "Dieppe port" on VHF channel 12.

**Dunkerque**

**Port of Dunkerque**  
  
 Terre Plein Guillan  
 BP 6534  
 Dunkerque  
 Cedex 1  
 59386  
 France  
 Contact: Mrs Marie-Elizabeth Bogucki  
 Job Title: Communication & Relations Publiques  
 T: + 33 3 28 28 79 11  
 F: + 33 3 28 28 79 17  
 E: mebogucki@portdedunkerque.fr  
 W: www.portdedunkerque.fr

T: + 33 3 28 28 79 11  
 F: + 33 3 28 28 79 17  
 E: mebogucki@portdedunkerque.fr  
 W: www.portdedunkerque.fr

**Dunkerque**

**Sea-Bulk Terminal**  
 Route du Quai à Pondéreux Ouest  
 Loon-Plage  
 Dunkerque  
 59279  
 France  
 Contact: Mr Philippe Bertonèche  
 Job Title: Terminal Manager  
 T: + 33 328 28 79 40  
 F: + 33 328 28 79 15  
 E: philippe.bertoneche@sea-invest-france.com  
 W: www.sea-invest.be

**Dunkerque**

**SGD - Silo a Grain Dunkerque**  
 Route du Fosse Defensif  
 Port Est  
 Dunkerque  
 59140  
 France  
 Contact: Mr Olivier Albrecht  
 Job Title: Commercial Director  
 T: + 33 3 28 24 90 10  
 F: + 33 3 28 24 90 15  
 E: olivieralbrecht.dmt@orange.fr

**Dunkerque**

**Silonor**  
 Quai Cerealiere- Port Est  
 Dunkerque  
 59140  
 France  
 Contact: Mr Olivier Albrecht  
 Job Title: Commercial Director  
 T: + 33 3 28 24 90 10  
 F: + 33 3 28 24 90 15  
 E: olivieralbrecht.dmt@orange.fr

**Fecamp**

**Fecamp Port Authority**  
 16 Grand Quai  
 PO Box 167  
 Fecamp  
 76400  
 France  
 Contact: Mr Y Morel  
 Job Title: Harbour Master  
 T: + 33 235 28 23 76  
 F: + 33 235 28 75 86  
 E: info@fecamp.cci.fr  
 W: www.fecamp.cci.fr

**La Rochelle**

**Port Atlantique La Rochelle**  
 BP 70394  
 La Rochelle  
 Cedex 1  
 France  
 Contact: Dominique Marquis  
 Job Title: Director of Communication  
 T: + 33 54600 5360  
 F: + 33 54600 56 22  
 E: d.marquis@larochelle.port.fr  
 W: www.larochelle.port.fr

**La Rochelle-Pallice**

**Silo de la Rochelle Pallice**  
 (SICA Manutention Portuer)  
 69 Rue Montcaim  
 La Rochelle-Pallice  
 17000  
 France  
 Contact: Mr Jean-Pierre Esterez  
 Job Title: Director  
 T: + 33 546 43 9922  
 F: + 33 546 43 2494  
 E: jp.esterez@sica-atlantique.com

**Le Havre**

**Coal Terminal**  
 Port of Le Havre Authority  
 Terre Plein de la Barre

PO Box 1413  
 Le Havre  
 Cedex  
 76067  
 France  
 Contact: Mr Eric Esneu  
 Job Title: Bulk Traffic Manager  
 T: + 33 2 32 74 76 05  
 F: + 33 2 32 74 76 09  
 E: eric.esneu@havre-port.fr  
 W: www.havre-port.net  
 North West of France (Normandy) on the North Coast  
 2 Grab unloaders- Discharging rate: 25,000tpd  
 Max ships draught: 17m  
 2 storage areas : 40,000sqm + 60,000sqm  
 Reloading facilities: max ships draught 6m

**Le Havre**

**Le Havre Multi-Bulk Terminal**  
 BP 1142  
 CIPHA Centre of Commerce Intl  
 quai George V  
 Le Havre  
 76063  
 France  
 Contact: Ms Miugendit  
 T: + 33 232 74 24 80  
 F: + 33 235 21 38 15  
 E: lechevallier@shgt.fr  
 W: www.cipha.com  
 East Channel France Seine mouth  
 2x 30t gantry cranes  
 1 berth: draught 17.5m  
 300,000sqm  
 12,000sqm  
 Screening crushing facility

**Le Havre**

**Port of Le Havre Authority**  
 PO Box 1413  
 Terre Plein de la Barre  
 Le Havre  
 Cedex  
 76067  
 France  
 Contact: Mr Laurent Castaing  
 Job Title: Port Manager  
 T: + 33 232 74 74 00  
 F: + 33 232 74 74 29  
 E: internetpah@havre-port.fr  
 W: www.havre-port.fr  
 Located at the crossroads of major communication highways, at the heart of the west seaboard of the European continent, Le Havre is the first port of call for large transoceanic mother-ships. The Port of Le Havre provides the shortest transport times for commercial exchanges with all the other continents.  
 Multibulks Centre: can operate direct transhipment from ships to barges and coasters.  
 Ore Centre ("Terminal MC-6"): sorting station dispatches products to storage yards, loading berths and loading tower for freight cars and trucks.  
 Agribusiness Centre Grain terminal: Mechanised machines for unloading freight cars and lorries at Hermann du Pasquier quay.  
 Gantry crane (1,800 tph) for loading large grain carriers at Joannes Couvert quay.  
 Agribusiness Centre Sugar terminal: Lorry and freightcar reception facilities and sacking station. Gantry crane for loading bulk sugar on specialised BIBO ships.  
 Multibulks Centre: Main berth - unloading ships up to 180,000 dwt, loading 35,000/50,000dwt.  
 Additional berth loading of 5,000dwt pusher trains of barges or coasters up to 8,000dwt.  
 Ore Centre ("Terminal MC-6"):

Length 300m, 180,000 DWT. Main berth and loading berth for river barge convoys and coasters.  
 Agribusiness Centre: Bellot dock 30,000 DWT. Tidal dock can accommodate the largest grain carriers.  
 Multibulks Centre: private storage yard of 2 million tonnes.  
 Ore Centre ("Terminal MC-6"): public yard of 530,000 tonnes, private yard of 250,000 tonnes.  
 Agribusiness Centre Grain terminal: 80,000 tonnes grain silo.  
 Agribusiness Centre Sugar terminal: 45,000 tonnes sugar silos operated by SHGT ("Societe Havraise de Gestion et de transport").  
 The Multibulks Centre has the necessary technical means for screening, grinding, mixing, long-term storage and re-forwarding onto complete trains, trucks and barges.

Length 300m, 180,000 DWT. Main berth and loading berth for river barge convoys and coasters.  
 Agribusiness Centre: Bellot dock 30,000 DWT. Tidal dock can accommodate the largest grain carriers.  
 Multibulks Centre: private storage yard of 2 million tonnes.  
 Ore Centre ("Terminal MC-6"): public yard of 530,000 tonnes, private yard of 250,000 tonnes.  
 Agribusiness Centre Grain terminal: 80,000 tonnes grain silo.  
 Agribusiness Centre Sugar terminal: 45,000 tonnes sugar silos operated by SHGT ("Societe Havraise de Gestion et de transport").  
 The Multibulks Centre has the necessary technical means for screening, grinding, mixing, long-term storage and re-forwarding onto complete trains, trucks and barges.

**Le Portel**

**Gie Boulogne Clinker**  
 Quai de l'Europe  
 Le Portel  
 62480  
 France  
 Contact: Mr Jacques Duron  
 Job Title: Administrator  
 T: + 33 6 21 31 85 97  
 F: + 33 6 21 33 94 57

**Lorient**

**Port de Commerce-Lorient**  
 3 Bd de la Rade  
 Lorient  
 56100  
 France  
 Contact: M J P Greverie  
 T: + 33 297 371 670  
 F: + 33 297 379 073  
 E: lorient.port.commerce@morbihan.cci.fr

**Marseille**

**Marseilles Grain Terminal**  
 Port Autonome de Marseille  
 Direction des Opérations - Terminaux de Marseille  
 23, place de la Joliette  
 BP 1965  
 Marseille  
 13226 Cedex 02  
 France  
 Contact: Mrs Sacha Roujier  
 Job Title: Marketing  
 T: + 33 4 91 39 44 21  
 F: + 33 4 91 39 57 00  
 E: gpmm@marseille-port.fr  
 W: www.marseille-port.fr

**Marseille**

**Port Autonome de Marseille/Fos**  
 23 Place de la Joliette  
 Hotel de la Direction du Port  
 Marseille  
 Cedex 02  
 13226  
 France  
 Contact: Mr Vincent Mutel  
 Job Title: Public Relations  
 T: + 33 0491 395320  
 F: + 33 0491 394024  
 E: gpmm@marseille-port.fr  
 W: www.marseille-port.fr

**Marseille**

**Port of Marseilles**  
 23 Place De La Joliette  
 BP 81965  
 Marseille  
 Cedex 02  
 13226  
 France  
 Contact: Mr Jean Claude Terrier  
 Job Title: Managing Director

5 – 7 March 2014 | Grand Hyatt Goa | India

# 13th Coaltrans GOA India

coaltrans.com/india | #CoaltransIndia



**Coaltrans**  
Conferences

Hear from

**Bharat Vir Wanchoo**  
Hon'ble Governor of Goa

**C S Verma**  
Chairman  
SAIL & ICVL; Chairman-cum-Managing Director, NMDC Limited

**Naveen Jindal**  
Executive Vice Chairman and Managing Director  
Jindal Steel and Power Limited

**Sutirtha Bhattacharya**  
IAS, Chairman and Managing Director  
Singareni Collieries Co.Ltd

**N N Mishra**  
Director (Operations)  
NTPC Limited

**Cameron Vorias**  
Managing Director/ Chief Executive Officer  
Sojitz Coal Mining Pty Ltd

Register by 24 January 2014 & save £150



Register for the 13th Coaltrans India and:

- Join India's largest coal industry gathering and network with over 1,100 senior industry players
- Hear from a spectacular line-up of industry CEOs as they provide insight on India's coal markets and offer perspective on the key trends that will affect your business
- Set up meetings prior to the event via our mobile Delegate Messenger Service
- **BRAND NEW:** Networking coal industry cricket tournament

Platinum Sponsors



Knowledge Infrastructure Systems Pvt. Ltd.



Gold Sponsors



Silver Sponsors



Bronze Sponsors



wherever you go



सत्यमेव जयते

Endorsed by  
MINISTRY OF COAL  
Government of India



T: + 33 4 91 39 4000/278  
 F: + 33 4 91 39 57 00  
 E: pam@marseille-port.fr  
 W: www.marseille-port.fr  
 Eastern and Western Harbors  
 Please see website: www.marseille-port.fr  
 Please see website: www.marseille-port.fr  
 Eastern: 450 acres  
 Western: 10,000 acres  
 Western: Distriport Logistic Area  
 450,000sqm  
 Please see website: www.marseille-port.fr

**Martigues**

**Carfos**  
 13, Boulevard Maritime  
 Martigues  
 13500  
 France  
 Contact: Mr Xavier Hauterat  
 T: + 33 424 06 71 82  
 F: + 33 424 06 34 94  
 E: xavier.hauterat@sea-invest-france.com  
 W: www.sea-invest.be

**Montoir-de-Bretagne**

**Sea-invest Montoir**  

Rue de la Coélette - BP 36  
 Montoir-de-Bretagne  
 44550  
 France  
 Contact: Mr Pascal Vialard  
 T: + 33 240 17 31 71  
 F: + 33 240 17 31 79  
 E: pascal.vialard@sea-invest-france.com  
 W: www.sea-invest.be

**Montoir-de-Bretagne**

**SONASTOCK & ATLANTIQUE STOCKAGE**  
 Montoir Export & Import Terminals  
 Montoir-de-Bretagne  
 France  
 Contact: Mr Thierry Coiffard  
 Job Title: Director  
 T: + 33 2 40 90 01 37  
 F: + 33 2 40 90 46 17  
 E: t.coiffard@sodistock.fr  
 W: www.sodistock.fr/anglais/accueilgb.htm

**Nantes**

**Grand Port Maritime Nantes St Nazaire**  
 I 894  
 Centre De Documentation  
 18 Quai Ernest Renaud  
 BP 18 609  
 Nantes  
 Cedex 04  
 44186  
 France  
 Contact: Mr Laurent Buvry  
 Job Title: Commercial Manager  
 T: + 33 2 40 44 20 26  
 F: + 33 2 40 44 21 81  
 E: l.buvry@nantes.port.fr  
 W: www.nantes.port.fr  
 Western France, on the Atlantic Seashore  
 1 Gantry crane - 700 t/h  
 1 Crane - 700 t/h  
 5 Cranes - 500 t/h each  
 3 Continuous unloaders - 1200 t/h each  
 1 Mobile conveyor belt - 350 t/h  
 Montoir - Agricul Terminal  
 4 Berths; Total length - 930 m;  
 Drafts up to 13,5 m  
 70,000 sqm  
 Leading French port for cattle feed imports, with a 60% market share.  
 Special focus on traceability, cleaning, dedicated conveyors &

storage, allowing strict separation of products. Quality control through HACCP process

**Nantes**

**Montoir Agri-Bulk Terminal**  
 18 Quai Ernest Renaud  
 Nantes  
 44031  
 France  
 Contact: Mr L Buvry  
 Job Title: Port Director  
 T: + 33 240 442 020  
 F: + 33 240 442 181  
 E: l.buvry@nantes.port.fr  
 W: www.nantes.port.fr

**Nantes**

**Montoir Coal Terminal**  
 Port Atlantique Nantes Saint-Nazaire  
 18 quai Ernest Renaud  
 BP 18609  
 Nantes 44186  
 France  
 Contact: Mr Pascal Freneau  
 Job Title: Marketing & Advertising Manager  
 T: + 33 2 40 44 2113  
 F: + 33 2 40 44 20 01  
 E: p.freneau@nantes.port.fr  
 W: www.nantes.port.fr

**Nantes**

**Port Atlantique-Montoir Agri-Bulk Terminal**  
 18 quai Ernest Renaud  
 BP 18609  
 Nantes  
 Cedex 4  
 44186  
 France  
 Contact: Mr Pascal Freneau  
 Job Title: Communication Manager  
 T: + 33 2 40 44 20 06  
 F: + 33 2 40 44 21 81  
 E: p.freneau@nantes.port.fr  
 W: www.nantes.port.fr  
 Western France

**Nantes**

**Roche-Maurice Terminal**  
 18 Quai Ernest Renaud  
 Nantes  
 44031  
 France  
 Contact: Mr M Buvry  
 Job Title: Commercial Manager  
 T: + 33 2 40 442 020  
 F: + 33 2 40 442 181  
 E: m.buvry@nantes.port.fr

**Nantes**

**SODISTOCK Group**  
 35 Rue des Usines  
 Nantes  
 cedex 4  
 44 000  
 France  
 Contact: Mr Daniel Finon  
 Job Title: Director  
 T: + 33 2 40 95 08 08  
 F: + 33 2 40 58 01 22  
 E: d.finon@sodistock.fr  
 W: www.sodistock.fr

**Nantes**

**SONASTOCK - Nantes Export Terminal**  
 Sortie No 30 - Porte de l'Estuaire  
 Nantes  
 44186  
 France  
 Contact: Mr Daniel Finon  
 Job Title: Directeur Général  
 T: + 33 2 40 95 60 61  
 F: + 33 2 40 58 15 59  
 E: d.finon@sodistock.fr  
 W: www.sodistock.fr/anglais/accueilgb.htm

**Paris**

**Port of Paris Authority**  
 1, quai de Grenelle  
 Paris  
 Cedex 15  
 75732  
 France  
 Contact: Mr Christophe Duchatellier  
 T: + 33 140 58 27 40  
 F: + 33 140 58 27 50  
 E: christophe.duchatellier@paris-ports.fr  
 W: www.paris-ports.fr

**Port De Montoir**

**Sea-invest France (Stocaloire)**

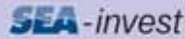

Terminal Agro Alimentaire  
 Port De Montoir  
 44550  
 France  
 Contact: Mr Florent Massart  
 T: + 33 232108516  
 F: + 331 55 66 81 50  
 E: trampset@sea-invest-france.com

**Rouen**

**HAROPA**  
 34 Boulevard de Boisguilbert  
 B.P. 4075  
 Cedex 3  
 Rouen  
 76022  
 France  
 Contact: Mr Olivier Van Hoorde  
 Job Title: Advertising Director  
 T: + 33 235 529 616  
 E: olivier.vanhoorde@haropaports.com  
 W: www.haropaports.com  
 HAROPA, combining the ports of Le Havre, Rouen and Paris, is the 4th biggest port complex in Northern Europe.  
 Connected to every continent, it serves the second largest consumer market in Europe.  
 Offering end-to-end multimodal transport solutions along the Seine artery, it provides a one-stop shop for your import/export logistics.

**Rouen**

**Lecureur**  
 Val de la Haye  
 QuennePort  
 Canteleu  
 Rouen  
 7630  
 France  
 Contact: Mr Patrick Chevallier  
 Job Title: Director  
 T: + 33 2 35 36 25 23  
 F: + 33 2 35 36 48 52  
 E: p.chevallier@lecoreur.com

**Rouen**

**Maprochim**  
 Centre Tertiaire Portuaire  
 19 Boulevard du Midi  
 Rouen  
 76100  
 France  
 Contact: Mr Michael Fouche  
 Job Title: Managing Director  
 T: + 33 2 3281 9633  
 F: + 33 2 3572 2691  
 E: commercial@maprochim.fr  
 W: www.maprochim.fr

**Rouen**

**Port of Rouen**  
 34 Blvd de Boisguilbert  
 Rouen  
 Cedex 3  
 F 76022  
 France  
 Contact: Mr Martin Butruille

Job Title: Traffic and Port Activity Manager  
 T: + 33 235 52 54 30  
 F: + 33 235 52 54 95  
 E: dtap@rouen.port.fr  
 W: www.rouen.port.fr  
 On the River Seine, between the Channel and Paris

**Rouen**

**SENALIA**  
 Presqu'île Elie  
 Rouen  
 76100  
 France  
 Contact: Mr Kindelberger  
 T: + 33 235 726 904  
 F: + 33 235 723 054  
 E: contact@senalia.com  
 W: www.senalia.com

**Rouen**

**SENALIA**  
 Boulevard Maritime  
 BP 71  
 Grand Couronne  
 Rouen  
 76530  
 France  
 Contact: Mr Marc Blaiset  
 T: + 33 235 183 030  
 F: + 33 235 183 033  
 E: MarcBlaiset@senalia.com  
 W: www.senalia.com

**Rouen**

**Silos Soufflet - SOCOMAC I/II Terminals**  
 Quai de Danemark  
 Dieppendalle Croisset  
 PO Box 1010  
 Rouen  
 76380  
 France  
 Contact: Mr De Braquillanges  
 T: +33 3 25 39 41 11 / + 33 235 363 145  
 F: + 33 235 085 671  
 E: pbrochot@soufflet-group.com

**Rouen**

**Simarex Vilette**  
 Mole de la Darse des Dockes  
 BP 7  
 Rouen  
 Petit Couronne  
 76650  
 France  
 Contact: Mr Charles Vedie  
 Job Title: Operations  
 T: + 33 2 3568 2402  
 F: + 33 2 3567 2993  
 E: c.vedie@simarex.fr  
 W: www.portofrouen.com/

**Rouen**

**Sogema**  
 Boulevard Maritime - BP 3  
 Grand-Couronne Terminal  
 Rouen  
 76530  
 France  
 Contact: Mr Robert Goudon  
 Job Title: Director  
 T: + 33 232 11 51 01  
 F: + 33 232 11 51 25  
 E: r.goudon@sea-invest.fr  
 W: www.sea-invest.be

**Saint Malo**

**St Malo Port Authority**  
 Terre-Plein de l'Ecluse du Naye  
 Saint Malo  
 35402  
 France  
 Contact: Mr Atrehu  
 Job Title: Vice Captain  
 T: + 33 299 20 25 00  
 F: + 33 029 94 02 58 7  
 E: atrehu@Saint-Malo.CCI.fr  
 North Brittany (France) West of

Channel France  
 3 cranes - 400 tph  
 1 crane - 200 tph  
 2 cranes - 100 tph  
 5 x 120 m - draft 9 m  
 5 x 100m - draft 550 m  
 190 000 sqm  
 30 000 sqm

**Sète**

**Sea-invest Sète**  
  
 Z.I. portuaire Darse 2  
 B.P. 68  
 Sète  
 Cedex 34201  
 France  
 Contact: Mr Pierre de Boutray  
 T: + 33 467 51 63 10  
 F: + 33 467 48 30 85  
 E: p.boutray@sea-invest-france.com  
 W: www.sea-invest.be

**Sète**

**Sete-Multibulk Berth**  
 2 quai Philippe Regy  
 BP 169  
 Sète  
 Cedex  
 34203  
 France  
 Contact: Mr Riethu  
 Job Title: Service du Développement - Cellule commerciale  
 T: + 33 4 67 46 3501  
 F: + 33 4 67 46 28 18  
 E: courmon.henri@portsudfrance-sete.fr  
 W: www.sete.port.fr  
 West Mediterranean  
 Max draft: 10.4m  
 10,000 sqm

**St Malo**

**SMG - Societe Malouine et Granvillaise**  
 12 Avenue Louis-Martin  
 St Malo  
 Cedex  
 35401  
 France  
 Contact: Mr Franck Rose  
 Job Title: Marketing  
 T: + 33 2 99 563 381  
 F: + 33 2 99 401 210  
 E: f.rose@blp.bollore.com

**Strasbourg**

**Strasbourg Port Authority**  
 25, rue de la Nuee-Bleue  
 BP 407 R9  
 Strasbourg  
 Cedex  
 67002  
 France  
 Contact: Mr Jean-Louis Jerome  
 Job Title: Port Director  
 T: + 33 388 21 74 74  
 F: + 33 388 23 56 57  
 E: jl.jerome@strasbourg.port.fr  
 W: www.strasbourg.port.fr

**Tarnos**

**Matrama Bayonne**  
 Rue de l'Industrie  
 Tarnos  
 40220  
 France  
 Contact: Mr Vincent Boullaut  
 T: + 33 240 321 735  
 F: + 33 240 650 745  
 E: vincent.boullaut@sea-invest.fr  
 W: www.ports-basques.com/ports/bayonne/  
 Mouth of the Adour river in the corner of the Bay of Biscay  
 30,000 sqm warehouse

# THE GATEWAY TO EUROPE.



## Our location benefits enable long-range services.

duisport offers more than excellent transport connections to enhance the efficiency of your operations in continental Europe. Our services range from 2.0 million sq. m. of warehousing space to the unique opportunities provided by a future oriented logistic park with outstanding state-of-the-art facilities, a perfect integration in transportation networks and plenty of space for developing your business.

duisport has gained a reputation as a transportation and trading hub and developed into a hinterland port of strategic importance for the North Sea ports.

We are ready for the future. duisport – We provide a European service.



Tel. +49 (0) 203 803-0  
mail@duisport.com  
www.duisport.com



**Toulon**

**Port of Toulon**  
PO Box 501  
244, avenue de L'Infanterie de Marine  
Toulon  
Cedex 9  
83041  
France  
Contact: Mr Thierry Herve  
Job Title: Harbour Master  
T: + 33 494 03 27 60 (harbour office)  
F: + 33 494 03 38 69  
E: thierry.herve@equipement.gouv.fr

**GABON**

**Libreville**

**Libreville Port Authority**  
Office et Rades du Gabon  
PO Box 1051  
Libreville  
Gabon  
Contact: Mr P Andzembe  
Job Title: Manager  
T: + 241 70 00 48  
F: + 241 70 37 35  
E: info@ports-gabon.com  
W: www.ports-gabon.com

**GABON**

**Libreville**

**Owendo Port Authority**  
PO Box 1051  
Libreville  
Gabon  
Job Title: Port Manager  
T: + 241 70 00 48 / 17 59 / 17 98  
F: + 241 70 37 35  
E: info@ports-gabon.com  
W: www.ports-gabon.com

**GEORGIA**

**Poti**

**Poti Sea Port Corporation**  
52, D. Agmashenebeli street  
Poti  
4401  
Georgia  
Contact: Mr Zviad Chkhartishvili  
Job Title: Head of Marketing Department  
T: + 995 493277 500 / 777  
E: zviad.chkhartishvili@apmterminals.com  
W: http://apmterminalsspoti.com/

**GERMANY**

**Brake**

**J. Müller Agri Terminal GmbH & Co. KG**  
Neustadtstraße 15  
Brake  
Lower Saxony  
26919  
Germany  
Contact: Mr Lars Gottschenkis  
Job Title: Marketing & Sales  
T: + 49 4401 914 211  
F: + 49 4401 914 228  
E: lars.gotschenkis@jmueeller.de  
W: www.jmueeller.de  
North of Germany  
Discharging: 20,000 mt/day  
Loading: 10,000 mt/day  
Max draught inward bound: 12.2m  
Max draught outward bound: 11.9m  
465,000 mt silo and flat storage  
(New vertical Silo with 47,000 mto capacity under construction and ready by Autum 2013) – thereafter total covered storage capacity  
512,000 mt (silo and flat storage)  
Crushing, drying, aspiration

available. Self service truck loading. Certificated: GMP B1, B2, B4.2, B4.4; B4.5, B5, Q+S, Öko-VO 834/ 2007. AEO Certificate, IFS Certificate.

**Brake**

**J. Müller Breakbulk Terminal GmbH & Co. KG**  
Nordstr. 2  
Brake  
26912  
Germany  
Contact: Mr Wilhelm Heyer  
Job Title: VP - Breakbulk Logistic Centre  
T: + 49 4401 914 470

E: wilhelm.heyer@jmueeller.de  
W: www.jmueeller.de  
German North Sea coast  
2x 88t container gantries, 3x 25t luffing cranes, 1x 1,000tph shiploader, 1x 32t slewing luffing crane, 1x 20t hydraulic crane  
Strompier (river pier); max draught 11.9m; length 275m  
Binnenhafen (inner port); max draught 5.35m;  
115,000sqm  
155,000sqm

**Brake**

**Niedersachsen Ports GmbH & Co. KG**  
PO Box 1262  
Brommstrasse 2  
Brake  
26912  
Germany  
Contact: Mr Heiko Uflacker  
Job Title: Harbour Master  
T: + 49 4401 925200  
F: + 49 4401 3272  
E: post-brake@nports.de  
W: www.nports.de  
German Bight, River Weser  
150,000sqm  
180,000sqm

**Bremen**

**Weserport GmbH**  
Huettenstrasse 20  
Bremen  
28237  
Germany  
Contact: Mr Michael Appelhans  
Job Title: Managing Director  
T: + 49 421 643 0182  
F: + 49 421 643 0164  
E: mappelhans@weserport.de  
W: www.weserport.de  
German North Sea Coast  
7 cranes up to 55 to each about 2,000m with draught 9.45m > 250,000 sqm  
> 20,000 sqm  
Please see our website  
www.weserport.de

**Bremerhaven**

**bremenports GmbH & Co. KG**  
Am Strom 2  
Bremerhaven  
27570  
Germany  
Contact: Mr Ronald Schwarze  
Job Title: Marketing  
T: + 49 421 30901 612  
F: + 49 421 30901 624  
E: ronald.schwarze@bremenports.de  
W: www.bremenports.de  
The Ports of Bremen and Bremerhaven, Northern Germany

**Brunsbüttel**

**Brunsbüttel Ports GmbH**  
Elbehafen  
Brunsbüttel  
Schleswig-Holstein  
D-25541  
Germany

Contact: Mr Frank Schnabel  
Job Title: Managing Director  
T: + 49 4852 884 35  
F: + 49 4852 884 26  
E: f.schnabel@schrammgroup.de  
W: www.schrammgroup.de  
At the lower Elbe and at the Kiel-Canal, direct access to North and Baltic Sea  
4 cranes up to 120 to, 2 Oil-fueling devices, etc.  
Vessel length up to 350m, Vessel width up to 55m, draught limits dry cargo pier 14.8m  
483,900sqm  
27,900sqm  
Brunsbüttel Ports GmbH is the owner of three ports at Brunsbüttel, Elbehafen, Oilport and Port of Ostermoor

**Duisburg**

**Duisburger Hafen AG**

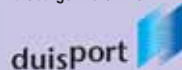

Alte Ruhrorter Straße 42 - 52  
Duisburg  
47119  
Germany  
Contact: Mr Julian Boecker  
T: + 49 203 803 4465  
F: + 49 203 803 4409  
E: julian.boecker@duisport.de  
W: www.duisport.de  
North Rhine-Westphalia, in the western part of the Ruhr district.  
1,350 ha area  
200 km of track  
9 container terminals with 15 gantry cranes  
130 cranes up to 500 t lifting capacity  
2 Ro/Ro facilities  
21 port basins, 5 import coal terminals  
2 Mio.  
Duisburger Hafen AG is the holding and management company of the Port of Duisburg, the largest inland port in the world.

**Duisburg**

**Rhenus AG & Co. KG**  
August-Hirsch-Strasse 3  
Duisburg  
47119  
Germany  
Contact: Mr Ehrenfried Reemer  
T: +49 203 8009 313  
F: +49 203 8009 307  
E: ehrenfried.reemer@de.rhenus.com

**Emden**

**Emden Port Authority**  
Niedersächsisches Hafenam  
Emden  
Friedrich Naumann Strasse 7-9  
Emden  
26725  
Germany  
Contact: Mr Frederick Voss  
Job Title: Marketing department  
T: + 49 4921 51770  
F: + 49 4921 979 860  
E: fvoss@nports.de  
W: www.seaport-dmden.de

**Emden**

**EVAG Emden Verkehrs und Automotive**  
Gesellschaft mbH  
Schweckendieckplatz 1  
Emden  
Lower Saxony  
26721  
Germany  
Contact: Mr Torsten Meinke  
Job Title: Area Manager  
T: + 49 4921 895 150  
F: + 49 4921 895 5150

E: torsten.meinke@evag.com  
W: www.evag.com  
North-West Germany / River Ems (North-Sea)  
3/Cranes Dischrate 10-15,000 tpd  
Crane reach 34m  
Airdraught 14m  
Length : 300m - EVAG controlled berth  
Draught alongside berth approx. 10.5m - 11m  
Limited by lock dims of 260 x 40m  
max experienced sizes: 242 x 32.4m (loa/beam)  
max inward draught 34-35'  
max outward draught 33-34'  
About 8,500sqm  
On request (occupied at present)  
Port Operator: Niedersachsen Ports GmbH Co KG Emden  
Direct access to Railway/Highway

**Flensburg**

**Flensburg Port Authority**  
Stadwerke Flensburg GmbH, Abt Hafetrieb  
PO Box 2751  
Flensburg  
24917  
Germany  
Contact: Mr Frank Partik  
Job Title: Harbour Master  
T: + 49 461 487 1505  
F: + 49 461 487 1699  
E: frank.partik@flensburgerhafen.de

**Hamburg**

**Buss Group GmbH & Co. KG**

Am Sandtorkai 48  
Hamburg  
20457  
Germany  
Contact: Dr Johann Killingier  
Job Title: Managing Partner  
T: + 49 40 3198-0  
F: + 49 40 31 98 20 00  
E: j.killingier@buss-group.de  
W: www.buss-group.de  
Port of Hamburg  
- 1 double boom crane with capacity of 40t, outreach max. 50 m,  
grab operation 16t  
- 1 crane with capacity of 45 t, outreach max.50 m,  
grap operation 16t  
- 2 single boom cranes with capacity of 8t, outreach max. 36 m  
- 1 mobile crane with capacity of 140t, outreach max. 51 m,  
grab operation 30t  
Discharge rate 15 t/day.  
2 double-link level luffing slew cranes (40-45t lifting capacity).  
2 single-link level luffing slew cranes (8t lifting capacity).  
Draught 11.5m, Main berth 380m  
215,000 sqm  
65,000 sqm  
The terminal has direct connections to the goods station Hamburg-Süd and to the BAB 1 und BAB 7 motorways.

**Hamburg**

**H J M (H Jürgen Müller GmbH)**  
1 Hafenstrasse 12-14  
Hamburg  
21079  
Germany  
T: + 49 40 725 86 90  
F: + 49 40 725 86 929  
E: info@hjm-hamburg.de  
W: www.hjm-hamburg.de  
Seehafen 1, Port of Hamburg  
3 track-bound cranes, 2 mobile cranes, 4 silo hoppers.  
2 berths. Quay length 250m. Max Depth 6.6m plus height of tide about 3.5m.  
20,000sqm  
3 enclosed silos of 32,500m3 total.

**Hamburg**

**BUSS Ross Terminal GmbH & Co KG**  
Am Travehafen / Schuppen 80-82  
Hamburg  
20457  
Germany  
Contact: Mr Heinz J Wasser  
Job Title: MD  
T: + 49 40 751 93 3500  
F: + 49 40 751 93 3100  
E: h.wasser@buss-group.de  
W: www.buss-group.de  
Port of Hamburg  
1x 104t mobile crane, various grabs.  
Discharge rate 8,000 - 10,000 tpd.  
Main berth 230m. Draught 11.5m.

Terminal area: 50,000 sqm  
Direct connections to the BAB1 and BAB7 motorways.

**Hamburg**

**Diamant Mühle Hamburg GmbH**  
Trettaustrasse 49  
Hamburg  
21107  
Germany  
Contact: Ms Gusco  
Job Title: Marketing Department  
T: + 49 40 75 109 01  
F: + 49 40 75 109 131  
E: info@diamant-mehl.de  
W: www.diamant-mehl.de  
Hamburg, Germany  
1 floating pontoon. 10m floating pontoon. 1 suction tube.  
100tph for grain.  
Max Depth 5m.  
Grain discharge only.

**Hamburg**

**Eichholtz GmbH**  
Rossweg 20  
Hamburg  
20457  
Germany  
T: + 49 40 741 39 00 0  
F: + 49 40 741 39 00 21  
E: info@eichholtz.de  
W: www.eichholtz.de  
Rosshafen/Hachmannkai, Port of Hamburg  
Mobile cranes.  
3 berths. Quay length 440m. Max Depth 11m.  
165,000sqm warehouse, of which 100,000sqm in the Free Port

**Hamburg**

**GTH - Getreide Terminal Hamburg (GmbH & Co.KG)**  
Eversween 11  
Hamburg  
D-21107  
Germany  
Contact: Mr Kay Boehmer  
T: + 49 40 75106 121  
F: + 49 40 75106 133  
E: k.boehmer@getreide-terminal.de  
W: www.getreide-terminal.de  
Port of Hamburg  
Discharge rate 1,000t/h.  
2 loading systems with up to 22,000t/day capacity.  
Draught 12.4m. Length 270m.  
Two warehouses capable of holding 35,000 tons of heavy grain.  
Eleven silo complexes that can hold a total of 220,000 tons, divided up into 550 cells with a capacity of between 60 and 3,000 tons.  
Drying, cleaning, cooling fumigation, customs clearance, sample check etc

**Hamburg**

**H J M (H Jürgen Müller GmbH)**  
1 Hafenstrasse 12-14  
Hamburg  
21079  
Germany  
T: + 49 40 725 86 90  
F: + 49 40 725 86 929  
E: info@hjm-hamburg.de  
W: www.hjm-hamburg.de  
Seehafen 1, Port of Hamburg  
3 track-bound cranes, 2 mobile cranes, 4 silo hoppers.  
2 berths. Quay length 250m. Max Depth 6.6m plus height of tide about 3.5m.  
20,000sqm  
3 enclosed silos of 32,500m3 total.

## Hamburg

### HaBeMa Futtermittel GmbH & Co KG

Pollhornweg 25  
Hamburg  
D - 21107  
Germany  
T: + 49 040 752705 0  
F: + 49 040 75 27 05 33  
E: kontakt@habema.com  
W: www.habema.com  
Reiherstieg-Süd, Port of Hamburg.  
Travelling crane, bridge slew crane, shiploader.  
Discharge capacity up to 10,000t/day.  
Loading capacity up to 15,000t/day.  
2 berths. Quay length 330m, Max depth 12m.  
61,000sqm warehouse space for approx. 150,000t of cargo.  
Rail connection to freight railway station Hohe Schaar, grain and animal feed loading for standard sea containers.

## Hamburg

### Hamburg Port Authority

Neuer Wandrahm 4  
Hamburg  
D - 20457  
Germany  
Contact: Mr Wolfgang Hurtienne  
Job Title: Head of Port Planning Division  
T: + 49 40 4 2847 2311  
F: + 49 40 4 2847 2499  
E: wolfgang.hurtienne@hpa.hamburg.de  
W: www.hpa.hamburg.de

## Hamburg

### Hamburg Sud

Willy-Brandt-Straße 59-61  
Hamburg  
20457  
Germany  
Contact: Mr Christoph Kelm  
T: + 49 40 3705 2676  
E: Christin.Terjung@ham.hamburgsud.com  
W: www.hamburgsud.com

## Hamburg

### HANSAPORT

Hafenbetriebsgesellschaft mbH  
Am Sandauhafen 20  
Hamburg  
21129  
Germany  
Contact: Mr Erhard Meller  
T: + 49 40 74003 201  
F: + 49 40 74003 222  
E: info@hansaport.de  
W: www.hansaport.de  
Port of Hamburg  
4x discharge bridges each with 38t lifting capacity.  
Handling capacity 15,000,000tpa  
3 berths. Draught 15.1m. Length 760m for large vessels, 240m for small vessels.  
350,000 sqm  
Rail connection with 15 tracks for block trains.

## Hamburg

### K+S Terminal (Kalikai)

K+S Transport GmbH  
Blumensand 27  
Hamburg  
D-21107  
Germany  
T: + 49 40 75275 0  
F: + 49 40 75275 122

E: kalitransport@k-plus-s.com  
W: www.kalitransport.com  
Port of Hamburg  
2x grabs (12/20 mt).  
3x Shiploaders.  
Loading rate 2,000/ 3,000 mt/hour  
Main berth 500m. Draught 11.3m  
Total storage 405,000mt in 12 sheds and 7 silos.

## Hamburg

### Kali- Transport Gesellschaft GmbH

Glockengießerwall 3  
Hamburg  
20095  
Germany  
Contact: Mr Frank Firmkes  
T: + 49 40 30906 0  
F: + 49 40 30906 113  
E: frank.firmkes@k-plus-s.com

## Hamburg

### Louis Hagel (GmbH & Co. KG)

Eversween 19  
Hamburg  
21107  
Germany  
Contact: Mrs Sandra Reidock  
T: + 49 40 751651  
F: + 49 40 7533440  
E: info@louis-hagel.com  
W: www.louis-hagel.com  
Port of Hamburg  
One 8t crane, one dry bulk loader (600-800t/h), two warehouses with several boxes, two truck loading facilities, a company owned railroad track  
The constant water-depth of 11 m (tide independent) allows loading of vessels with a breadth up to 25m and a loading tonnage of approximately 30,000t.

6.400 m<sup>2</sup>, 36.000t

The Hagel bulk terminal with a high-tec loader and combined storage capacities guarantees a quick and flexible handling of vessels up to 30,000 tons. Check out possible operations of our 8-tons crane for bulk goods.

## Hamburg

### Mittal Steel Hamburg GmbH

Dradenaustr. 33  
Hamburg  
21129  
Germany  
Contact: Ms Stephanie Tremblay  
T: + 49 40 74 080  
F: + 49 40 74 01432  
E: stephanie.tremblay@arcelormittal.com  
W: www.mittalsteel.com  
Dradenauhafen, Port of Hamburg  
1 level luffing crane 12.5t, 1 crane bridge 25t, 1 mobile grabber.  
Quay length 460m, Max Depth 12.5m  
Company terminal, rail connection.

## Hamburg

### NHG - Neuhof Hafengesellschaft mbH

Köhlbrandstraße 3  
Hamburg  
D-21107  
Germany  
Contact: Mrs Kleinschmidt  
T: + 49 40 752 7070  
F: + 49 40 752 2512  
E: info@neuhof-hafen.de  
W: www.neuhof-hafen.de  
Port of Hamburg  
3 elevator systems of which, 1 mechanical discharge tower - 1,000tph, 2 pneumatic elevators - 350tph each, 1 loading-discharge tower - 250tph, 1 loader 1,200tph.  
Approx capacity 2.5 million tpa  
4 berths, Draught 12.4m  
Length 175m / 110m  
180,000 tonnes  
Rail connection, truck dispatch.

## Hamburg

### OAM Baustoffe GmbH

Kirchenpauerkaai 29  
Hamburg  
20457  
Germany  
T: + 49 40 81 97 870  
F: + 49 40 81 97 8720  
E: info@oam-bau.de  
W: www.oam-bau.de  
Afrika-Terminal, Port of Hamburg.  
Inland-waterways vessels, barges, grabbers, Panamax.  
2 million tonnes capacity.  
4 berths. Quay length 100m. Max Depth 10.5m  
Quay facility with parallel rail siding, warehouse capacity.

## Hamburg

### Port of Hamburg Marketing Association

Pickhuben 6  
Hamburg  
D-20457  
Germany  
Contact: Mr Bengt van Beuningen  
Job Title: Director Communications  
T: + 49 40 3770 9110  
F: + 49 40 3770 9199  
E: vanbeuningen@hafen-hamburg.de  
W: www.hafen-hamburg.de  
Universal port Hamburg located in northern Germany  
Information about the different bulk terminals under  
www.portofhamburg.com.

## Hamburg

### Silo P. Kruse Betriebs-GmbH & Co. KG

Blumensand 31 - 33  
Hamburg  
D - 21107  
Germany  
Contact: Mrs Kleinschmidt  
Job Title: Management  
T: + 49 40 75206 0  
F: + 49 40 75206 206  
E: info@silo-p-kruse.de  
W: www.silo-p-kruse.de  
Port of Hamburg  
2 pneumatic systems, 1 travelling crane bridge. Handling capacity approx. 1,000tph.  
2 berths. Draught 12.5m. Length 275m  
80,000 tons in 200 silo compartments (ranging from 100 to 7,000 tons)  
Drying, cleaning

## Hamburg

### Wilhelm Mulch GmbH & Co KG

Zitadellenstrasse 8  
Hamburg  
21079  
Germany  
Contact: Mr Beyer  
T: + 49 40 77 14 41  
F: + 49 40 77 40 94  
E: beyer@mulch-umschlag.de  
W: www.mulch-umschlag.de  
Port of Hamburg, Germany.  
2 handling cranes with calibrated electro-mechanical grabber weighing system, product-specific grabbers for a range of bulk/general cargo.  
Quay length 156m  
8,000sqm of reinforced, enclosed open storage  
Rail connection.

## Itzehoe

### Itzehoe Port Authority

Stadtwerke Itzehoe  
Gasstrasse 18  
Itzehoe  
25524  
Germany  
Contact: Mr Lausecker  
Job Title: Harbour Master  
T: + 49 4821 774409  
F: + 49 4821 774417  
E: info@stadtwerke-itzehoe.de  
W: www.stadtwerke-itzehoe.de

## Krefeld

### Krefeld Port Authority

Oberstrasse 13  
Krefeld  
Udingen  
D-47829  
Germany  
Contact: Mrs Elizabeth Lehnen  
T: + 49 2151 49270  
F: + 49 2151 492750  
E: hafen-und-bahnbetriebe@krefeld.de

## Leer

### Rhenus AG

Hafenstrasse 14  
Leer  
26789  
Germany  
Contact: Mr Schröter  
T: + 49 491 92512 0  
F: + 49 491 92512 66  
E: info@de.rhenus.com  
North West Germany  
25,000 storage area  
Up to 5.3m draught seaport  
25,000sqm  
7,000sqm  
Trimodal terminal



## COAL INTO GERMANY

via Rhenus Midgard's Seaports

**BTW (Bulk Terminal Wilhelmshaven) former Niedersachsenbrücke, Jade Bay (Germany):**

- New: Capesize Vessels up to 250.000 dwt with a draft up to 18,50 m (60') sw
- Rail connections into Germany's hinterland and neighbourhood countries

**Coal Terminal Nordenham on the River Weser (Germany):**

- Rail- and inland waterway connections to Germany's hinterland and beyond
- Panamax- and partly laden Cape Size Vessels with a draft up to 13,10 m (43') fw

Both ports handle more than 5 million tons exceeding 10% of the imported coal into Germany.

**Rhenus, a company with a long history, is one of the world's leading providers of integral logistics services and has annual turnover totalling 4 billion Euro.**



Rhenus Midgard Wilhelmshaven GmbH & Co. KG - Lüneburger Str. 6 - D-26384 Wilhelmshaven  
Tel. +49 (0)4421 936-135 - Fax +49 (0)4421 936 104  
info.wilhelmshaven@de.rhenus.com - www.rhenus.com



**Neuss**

**Neuss Port Authority**  
Städtische Hafengebiete Neuss  
Hammer Landstrasse 3  
Neuss 41460  
Germany  
Contact: Mr Scheffer  
Job Title: Harbour Master  
T: + 49 2131 53 230  
F: + 49 2131 5323105  
E: info@nd-haefen.de

**Nordenham**

**Rhenus Midgard GmbH & Co. KG**



Midgardstr. 50  
Nordenham  
26954  
Germany  
Contact: Mr Michael Appelhans  
Job Title: Managing Director  
T: + 49 4731 81209  
F: + 49 4731 81258  
E: michael.appelhans@de.rhenus.com  
W: www.rhenus.com  
German Beight, at River Weser  
10 Shorecranes fitted for bulk and breakbulk cargo, heavylifts up to 100ts  
2.0km berths, max. draught 9,45m  
250,000sqm  
50,000sqm  
Further services like stevedoring, agency, chartering of deepsea vessels and river barges are offered out of one hand.

**Nuremberg**

**Hafen Nürnberg-Roth GmbH**

Rotterdam Str 2  
Nuremberg  
Bavaria  
90451  
Germany  
Contact: Mr Harald Leupold  
Job Title: Managing Director  
T: + 49 911 6429 418  
F: + 49 911 6429 410  
E: h.leupold@gvz-hafen.com  
W: www.gvz-hafen.com  
South Germany  
More than 11 Mill. tons cargo turn over p.y.  
3,370,000sqm  
260 companies located with more than 5,500 employees, multimodale gateway for South-East-Europe.

**Oldenburg**

**Seaports of Niedersachsen GmbH**

Hindenburgstrasse 28  
Oldenburg  
Niedersachsen  
D-26122  
Germany  
Contact: Ms Inke Onnen-Lübben  
Job Title: Managing Director  
T: + 49 441 361 88888  
F: + 49 441 361 88889  
E: onnen-luebben@seaports.de  
W: www.seaports.de  
Geographical prime location in Germany, directly on the estuaries of the large waterways in the German Bight and adjacent to the Kiel Canal.  
Seaports of Niedersachsen GmbH represents nine seaports with numerous port handling operators, trans-regionally active logistical networks and specialists for every type of cargo and port service.

**Rostock**

**Bulk Terminal Rostock GmbH**

Liebherrstraße 3  
Rostock  
D-18147

Germany  
Contact: Mr Günter Fett  
Job Title: Managing Director  
T: + 49 381 6662 120  
F: + 49 381 6662 575  
E: guenter.fett@portofrostock.de  
W: www.portofrostock.de

**Rostock**

**Getreide Service Rostock GmbH**  
Am Getreidehafen 3

Rostock  
D-18147  
Germany  
Contact: Mr Karsten Lentz  
Job Title: Managing Director  
T: + 49 381 6662 580  
F: + 49 381 6662 505  
E: karsten.lentz@portofrostock.de  
W: www.portofrostock.de  
Baltic Sea  
Loading/unloading cap. 300- 1000 tph  
Silos 360.000 t

**Rostock**

**Seehafen Rostock**

**Umschlagsgesellschaft mbH**  
Am Hansakai 14

Rostock  
18147  
Germany  
Contact: Mrs Monica Muller  
Job Title: Assistant  
T: + 49 381 6662101  
F: + 49 381 6662 205  
E: info@portofrostock.de  
W: www.portofrostock.de

**Stralsund**

**Port of Stralsund**

Stralsunder Hafen und Lagerhaus  
Hafenstrasse 20  
Stralsund 18439  
Germany  
Contact: Mr Wolfgang Ostenberg  
Job Title: Port Manager  
T: + 49 3831 25420  
F: + 49 3831 254297  
E: ostenberg@seehafen-stralsund.de

**Wilhelmshaven**

**Rhenus Midgard Wilhelmshaven GmbH & Co KG**

Lüneburger Str. 6  
Wilhelmshaven  
Lower Saxony  
26384  
Germany  
Contact: Mr Jürgen Kleemeyer  
Job Title: Coal Logistics Projects / Marketing & Sales  
T: + 49 4421 936 135  
F: + 49 4421 936 104  
E: juergen.kleemeyer@de.rhenus.com  
W: www.rhenus.com  
Port of Wilhelmshaven, Jade Bay (Germany)  
Discharging rate 25,000tpd  
BTW (Bulk Terminal  
Wilhelmshaven) draught 18.5m (60') sw  
120,000sqm  
BTW is fully developed for fully loaded Capesize with a draught up to 18.50m sw, discharging rate > 50,000tpd, 10 M tpa coal, 1.0 M t stockpile (extension for 3.0 M t) etc.

**GHANA**

**Takoradi**

**Ghana Ports & Harbours Authority**

PO Box 708  
Takoradi  
Ghana  
Contact: Mr Nester P Galley  
Job Title: Director of Port  
T: + 233 312 4073

F: + 233 312 2814  
E: takoradi@ghanaports.gov.gh  
W: www.ghanaports.gov.gh

**Takoradi**

**Takoradi Port Authority**

Ghana Ports Authority  
PO Box 708  
Takoradi  
Ghana  
Contact: Mr J E Quanash  
Job Title: Port Manager  
T: + 233 31 24073  
F: + 233 31 22814  
E: takoradi@ghanaports.net  
W: www.ghanaports.gov.gh

**Tema**

**Tema Port**

Valco Private Berth  
c/o Ghana Ports Authority  
PO Box 488  
Tema  
Ghana  
Contact: Mr I Carson  
Job Title: Port Services Director  
T: + 233 221 204136 8  
F: + 233 31 22814  
E: tema@ghanaports.net  
W: www.ghanaports.gov.gh

**GREECE**

**Alexandroupolis**

**Alexandroupolis Port Authority**

Alexandroupolis  
68100  
Greece  
Contact: Mr N Papanikolopoulos  
Job Title: Harbour Master  
T: + 30 255 102 6468  
F: + 30 255 102 1430  
E: alex@yen.gr

**Aliveri**

**Mylaki Port Authority**

c/o Milaki Shipping Agency Ltd  
18 A Nikka Street  
Aliveri  
345 00  
Greece

**Attica**

**Milaki Port-East Mediterranean Coal Terminal**

49-51 Sof Venizelou Str  
Lycovrissi  
Attica  
14123  
Greece  
Contact: Mr Andrew Healey  
Job Title: General Manager  
T: + 30 1 2898 111  
F: + 30 1 2840 021

**Chalkis**

**Chalkis Port Authority**

1 Athinion Avenue  
Chalkis  
34100  
Greece  
Contact: Mr George Papanicolaou  
Job Title: Harbour Master  
T: + 30 222 102 8888  
F: + 30 222 102 8888  
E: halk@yen.gr

**Chania Crete**

**Suda Bay Port**

c/o Port Authority of Chania  
21 Akti Tompazi  
Chania Crete  
Greece  
T: + 30 282 10 98888  
F: + 30 282 10 28387

**Corfu**

**Corfu Port Authority**

Xen Stratigou 2  
Corfu  
Greece  
T: +30 266 103 2655  
F: +30 266 103 9918

**Itea**

**Itea Port Authority**

Itea Harbour  
Akti Poseidonos & 1, Iroon Str.  
332  
Itea  
Greece  
Job Title: Port Master  
T: + 30 266 503 2319  
F: + 30 226 503 2100

**Kalamata**

**Kalamata Port Authority**

Harbour Office  
Kalamata  
24101  
Greece  
Job Title: Executive Director  
T: + 30 272 102 2218  
F: + 30 272 109 6880

**Milos Island**

**Milos Island Port Authority**

Adhamas Harbour  
Milos Island  
84800  
Greece  
Contact: Port Authority Employees  
T: +30 22870 22100 / 1/ 23360  
F: + 30 22870 22100  
E: milos@hcg.gr

**Nissyros**

**Yali Island Port Authority**

Port of Nissyros Island  
Nissyros Island  
Nissyros  
Greece  
Contact: Mr Boutsis Evagelos  
Job Title: Harbour Master  
T: + 30 224 203 1222  
F: + 30 224 203 1426

**Piraeus**

**Piraeus Port Authority**

10 Atki Miaouli  
Piraeus  
18538  
Greece  
Contact: Mr George Anoneripis  
Job Title: President / CEO  
T: + 30 210 4550229  
F: + 30 210 4550310  
E: prolp@olp.gr  
W: www.olp.gr

**Pylos**

**Pylos Port Authority**

Harbour Office  
Pylos  
24001  
Greece  
Contact: Mr T Kakalis  
Job Title: Harbour Master  
T: + 30 272 302 2225  
F: +30 272 302 2007  
E: pylo@yen.gr

**Thessaloniki**

**Thessaloniki Port Authority SA**

1st Pier  
Port of Thessaloniki  
Thessaloniki  
Central Macedonia  
54110  
Greece  
Contact: Mr Stylianos Aggeloudis  
Job Title: Chairman & CEO  
T: + 30 2310 593 105  
F: + 30 2310 510 500  
E: sekretariat@thpa.gr  
W: www.thpa.gr

Mediterranean Sea, Northern part of the Aegean Sea  
44 quay sea to shore gantry cranes  
3-40 tonnes lifting capacity  
14 berths, total length 3650m, draught 10-12m  
500,000sqm  
100,000sqm

**GUADELOUPE**

**Point A Pitre**

**Pointe-a-Pitre Port**  
Guadeloupe Port Authority  
PO Box 485  
Point A Pitre  
Cedex 97165  
Guadeloupe  
Contact: Mr Bernard Le Gall  
Job Title: Harbour Master  
T: + 590 590 686 320  
F: + 590 590 686 301  
E: b-legall@port-guadeloupe.com  
W: www.port-guadeloupe.com

**GUAM**

**Piti**

**Apra Harbour**  
Port Authority of Guam  
Suite 201  
1026 Cabras Highway  
Piti  
96925  
Guam  
Contact: Mrs Mary C. Torres  
Job Title: Port General Manager  
T: + 671 477 5931  
F: + 671 477 4445  
E: webmaster@portguam.com  
W: www.portguam.com/  
Western Pacific Region  
Tractor-31;Toplifter-4; Sideloader - 4; 40 lt. Shoreside Gantry-5; 20 ton Forklift-2;10 ton Forklift -4; 3 ton Forklift -1; 5 ton Forklift -9; 150 ton Mobile Harbor Crane -1;R.T.G.'s -2 3 containers; 2 general cargo; access to 2 big tanker fuel piers  
33 Acres  
86,000 sq. ft.  
The Port of Guam is currently undergoing a \$200 million modernization program to upgrade its facility.

**GUYANA**

**Georgetown**

**Georgetown Port Authority**  
Transport and Harbours  
Department  
Battery Road and Fort Street  
Kingston  
Georgetown  
Guyana  
Contact: Mr William Joseph  
Job Title: General Manager  
T: + 592 225 9350  
F: + 592 227 8545  
E: gnscc@guyana.net.gy  
W: www.gnscc.com

**Kingston**

**Linden Port Authority**

Transport and harbours Department  
Battery Road  
Kingston  
Georgetown  
Guyana  
Contact: Mr I English  
Job Title: General Manager  
T: + 592 2 78545  
F: + 592 2 78545  
E: gnscc@guyana.net.gy  
W: www.gnscc.com

## Kingston

**New Amsterdam Port Authority**  
c/o Transport and Harbours  
Department  
Battery Road  
Kingston  
Georgetown  
Guyana  
Contact: Mr I English  
Job Title: General Manager  
T: + 592 2 67842  
F: + 592 2 78545  
E: gnscc@guyana.net.gy  
W: www.gnscc.com

## HAITI

### Port Au Prince

**Port Au Prince Port Authority**  
National Port Authority  
PO Box 616  
Port Au Prince  
Haiti  
Contact: Mr J B Vital  
Job Title: Port Master  
T: + 509 223 2440  
F: + 509 221 3479  
E: apnpap@apn.gov.ht  
W: www.apn.gov.ht

## HONDURAS

### Puerto Cortes

**Terminales de Cortes, S.A de C.V**  
Bo. El Centro 2 av. 1-2 st.  
Apartado Postal 298  
Puerto Cortes  
11111  
Honduras  
Contact: Mr Francisco Laylle  
Job Title: General Manager  
T: + 504 2665 3040  
F: + 504 2665 1104  
E: gmanager@termisa.com  
W: www.termisa.com  
Puerto Cortes (Caribbean sea),  
San Lorenzo (Pacific Ocean)  
Bulk discharge with clamshells and  
hoppers, we can discharge 3  
handysize vessel at same time.  
Average discharge rate for bulk is  
1500 MT/WWD per workable hold  
with dedicated crane  
Berth #3 draft: 34ft; Berth #4 draft:  
28ft  
No uncovered storage inside the  
port

### Puerto Cortés

**National Port Company**  
Barrio EL Centro  
1 ave  
1 calle  
Puerto Cortés  
Nº. 18  
Honduras  
Contact: Mr José Manuel Arriaga  
Yacáman  
Job Title: General Manager  
T: + 504 665 0987  
F: + 504 665 1402  
E: gerencia@enp.hn

### Puerto Cortés

**Puerto Cortes Port Authority**  
Empresa Nacional Portuaria  
PO Box 18  
Puerto Cortés  
Honduras  
Contact: Snr Fernando E Alvarez L.  
Job Title: Assistant General  
Manager  
T: + 504 665-0987  
F: + 504 665-1402  
E: gerencia@enp.hn

## ICELAND

### Grundartangi

**Grundartangi Port**  
c/o Icelandic Alloys Ltd  
Skilmannahreppur, 301 Akranes  
Grundartangi  
Iceland  
Contact: Mr Smali  
Job Title: Transport Manager  
T: + 354 432 0390  
F: + 354 432 0101  
E: smali@klafi.is

### Hafnarfjordur

**Port of Hafnarfjordur**  
Óseyrarbraut 4  
Hafnarfjordur  
220  
Iceland  
Contact: Mr Kristinn Aadnegard  
Job Title: Harbour Master  
T: + 354 414 2300  
F: + 354 414 2301  
E: port@hafnarfjordur.is  
W: www.hafnarfjardarhofn.is  
South West Iceland, 10 km. south  
of Reykjavik, Iceland's Capital

### Raohusinu

**Vestmannaeyjar Port Authority**  
Harvarstjorn Vestmannaeyjar  
Raohusinu  
Vestmannaeyjar  
900  
Iceland  
Contact: Mr S Olafsson  
T: + 354 481 1207  
F: + 354 481 3115  
E: olisnorra@vestmannaeyjar.is

### Reykjavik

**Associated Icelandic Ports**  
Hafnarhusio/Tryggvagotú 17  
Reykjavik  
121  
Iceland  
Contact: Mr Gisli Gislason  
Job Title: Port Director  
T: + 354 525 8900  
F: + 354 525 8990  
E: gislig@faxi.is  
W: www.faxaports.is

## INDIA

### Adyar

**Subarnarekha Port Private Ltd**  
New No.84, Old No.50  
"Dakshin", 1st Ave, Indranagar  
Adyar  
Chennai  
600020  
India  
Contact: Mr Ramani Ramaswamy  
Job Title: Joint Managing Director  
T: + 914424431900  
F: + 914442607368 - Ext 18  
E: subarnarekha.port@gmail.com  
W: www.creativeports.com

### Bhavnagar Gujarat

**Bhavnagar Port Authority**  
Gujarat Maritime Board  
New Port Bhavnagar  
Bhavnagar Gujarat  
364005  
India  
Job Title: Port Officer  
T: + 91 2712 38346  
F: + 91 2712 34703  
E: gmbad1@sancharnet.in

### Bhubaneswar

**DPCL - Dhamra Port Company Limited**  
Fortune Towers, 2nd floor  
Chandrasekharpur

Bhubaneswar  
Orissa  
751 023  
India  
Contact: Mr Santosh Mohapatra  
Job Title: Chief Executive Officer  
T: + 91 674-2303829  
F: + 91 674-2303828  
E: ceo@dhamraport.com  
W: www.dhamraport.com

### Calcutta

**Calcutta Port Trust**  
15 Strand Road  
Calcutta  
700 001  
India  
Contact: Captain Akbagchi  
Job Title: Director Marine  
Department  
T: + 91 33 2230 3451  
F: + 91 33 2230 3214  
E: calport@vsnl.com  
W: www.portofcalcutta.com

### Calicut

**Calicut Port Authority**  
Port Officer Calicut  
PO Box 1108  
Kerala 673 032  
Calicut  
673032  
India  
Contact: Capt AK Bagchi  
Job Title: Director of Marine  
Department  
T: + 91 495 274604  
F: + 91 495 274604  
E: portsdire@asianet.in

### Chennai

**Ennore Port Limited**  
No.23, First Floor,  
P.T. Lee Chengalvaraya Naicker  
Maaligai  
Rajaji Salai,  
Chennai  
600 001  
India  
Contact: Mr Shri S. Velumani  
Job Title: Chairman  
T: + 91 44 25251666 / 1  
F: + 91 44 25251665  
E: svm@epcl.gov.in  
W: www.ennoreport.gov.in

### Chennai

**Karaikal Port Private Limited**  
4th Floor, MARG Panoram  
Block B, No. 334, Futura IT Park  
Rajiv Gandhi Salai (OMR)  
Sholinganallur  
Chennai  
Tamil Nadu  
600119  
India  
Contact: Mr N Suresh  
Job Title: Senior VP, Business  
Development  
T: + 91 44 4562 4000  
F: + 91 44 4562 4617  
E: business@karaikalport.com  
W: www.karaikalport.com  
300 kms south of Chennai on the  
Tamil Nadu coast  
3 MHC with 35 cbm grabs, 105  
tonnes each  
2 Capesize berths, 2 panamax size  
berths and 1 for smaller vessels up  
to 30,000dwt.  
450,000sqm  
63,000sqm  
- Multi Cargo Port.  
- Handles Gearless Panamax  
vessels.  
- Good connectivity through rail &  
road.  
- Handled Over 15 MMT of cargo  
so far.  
- Achieved good discharge rates.  
- No berthing delays.  
- Port capacity 50 MMT by 2016.

- Great potential for port based  
industries available near the port.

### Chennai

**Port of Chennai**  
Rajaji Salai  
Chennai 600 001  
India  
Job Title: Marketing Manager  
T: + 91 253 611 39 ext 2505  
F: + 91 253 602 78  
E: info@chennaiport.gov.in  
W: http://www.chennaiport.com

### Chennai

**Sical Logistics Limited**  
4th Floor, Spic House  
88 Mount Road  
Guindy  
Chennai  
600 032  
India  
Contact: Mr K Sridhar  
T: + 91 44 42118611  
F: + 91 44 42118620  
E: information@sical.com  
W: www.sical.com

### Churchgate

**Yogaytan Pvt. Ltd.**  
4, Vaswani Mansions,  
120, Dinsha Vaccha Road  
Churchgate  
Mumbai  
400020  
India  
Contact: Mr Harihardas Raj  
Job Title: Sr. Executive  
T: + 91-22-2288 0000  
F: + 91-22-2204 0000  
E: info@yogayatangroup.com  
W: www.yogayatangroup.com/

### Cochin

**Cochin Port Trust**  
Willingdon Island  
Cochin  
Kerala State  
682 009  
India  
Contact: Dr C. Unnikrishnan Nair  
Job Title: Traffic Manager  
T: + 91 484 266 6418  
F: + 91 484 266 6418  
E: tm@cochinport.gov.in  
W: www.cochinport.gov.in  
On the western coast of India  
towards Southwest 930km south of  
Mumbai and 320km north of  
Kanyakumari  
Latitude: 09°-57'-45" North  
Longitude: 76°-08'-59" East  
Mobile Harbour Crane(MHC)-1 no.  
of 40T cap.  
Mobile Crane-1no. of 40T cap.  
Fork Lift Trucks-22nos. of 3T  
cap.(includes 2 new Komatsu  
made)  
New Reach stacker-1 no. of 45T  
cap.  
Dedicated berth for FACT Ltd. with  
Grab unloader and mechanical  
conveyor for handling Fertiliser raw  
material  
3 lakh m2 at wharves. Vast open  
area available outside the wharves  
also.

### Devanampattinam

**Cuddalore Port Authority**  
Tamilnadu Port Department  
Marine House  
Beach Road  
Devanampattinam  
Tamil Nadu  
605 003  
India  
Contact: Mr S Sainath  
Job Title: Port Officer  
T: + 91 4142 2025

## Dist. Nellore

**Krishnapatnam Port Company Limited**  
P.O. Bag No. 1  
Muthukur  
Dist. Nellore  
Andhra Pradesh  
524 344  
India  
Job Title: Customer Service Team  
T: + 91 861 2377999  
F: + 91 861 2377046  
E: customerservice@krishnapatnamport.com  
W: www.krishnapatnamport.com

-> 14° 15' N latitude, 80° 08' E  
longitude.  
-> 180 km north of Chennai.  
-> Located in Nellore (District HQ of  
Andhra Pradesh), on National  
Highway 5 (Chennai-Kolkata).  
-> 26 km from Venkatachalam, the  
nearest rail head on the Chennai-  
Kolkata main line.  
-> Vast hinterland covering  
Southern Andhra Pradesh, Districts  
of Rayalseema, North Tamil Nadu  
and Eastern Karnataka.  
-> 13 shore cranes (10 Liebherr, 2  
Gottwald, 1 Sennebogen) with a  
capacity of 750 to 1,000 Mtpm per  
crane  
-> Dedicated port-owned cargo-  
handling equipment - tippers,  
loaders, excavators and dozers  
-> 4 locomotives for rake  
movements  
-> 23 weighbridges.  
-> 10 multi-purpose berths at north  
side and two berths at south side  
-> 18m draught; deepest port in  
India.  
-> Dedicated Project Cargo berth  
with 12 MT per CBM  
6,500 acres  
Warehouses with a total covered  
area of 1.52 Mn sq. ft for storing  
sensitive cargoes like Fertilizers, Agri  
commodities, etc.  
-> All weather port with 24 x 7  
operations, all throughout the year  
-> Deep draught capable of  
handling Capesize vessels  
-> High load & discharge rates  
leading to faster turnaround of  
vessels  
-> Strategically located port in  
terms of road / rail distances  
-> Port provides single window  
clearance system for port users  
from stevedoring to custom  
documentation without the  
inconvenience of multiple interfaces  
(CHA, Stevedores, Customs, Port)  
-> KPCL is now certified to the ISO  
9001, ISO 14001, OHSAS 18001  
and ISO 28000 management  
system standards by DNV

## Gandhinagar

**Gujarat Maritime Board**  
GMB Head Quarters  
Sector 10-A, Opp. Air Force Station  
Gandhinagar  
Gujarat  
382 010  
India  
Contact: Shri H K Dash  
Job Title: CEO  
T: + 91 79 232 383 46  
F: + 91 79 232 347 03  
E: gmbad1@sancharnet.in  
W: www.gmbports.org

## Goa

**Mormugao Port Trust**  
Headland Sada  
Goa  
403804  
India  
Contact: Mr KC Kuncheria  
Job Title: Traffic Manager/Chief



Mechanical Engineer  
T: + 91 0832 2521170  
F: + 91 0832 2521175  
E: cme@mptgoa.com  
W: www.mptgoa.com  
West Coast of India  
Mechanical Ore Handling Plant with a loading capacity of 8,000 tph  
2 no. Multipurpose General Cargo Berths  
1 no. Iron Ore handling berth.  
2 no. Coal/Coke handling berths operated on BOOT basis.  
3.25 lakh sqm  
41562 sqm.  
Besides Mechanical Ore Handling Plant, Iron Ore is also handled in mid stream by transhippers, floating cranes, ship's own gears and at Mooring Dolphins.

**Gujarat**

**Dahej Port Authority**  
Gujarat Maritime Board  
Sector 10-A, Opp. Air Force Station Gandhinagar  
Gujarat  
382 010  
India  
T: + 91 079 2323 8346  
F: + 91 079 2323 4703  
E: gmbad1@sancharnet.in  
W: www.gmbports.org

**Gujarat**

**Kandla Port Trust**  
PO Box 50  
Gandhidham  
Kutch  
Gujarat  
370 201  
India  
T: + 91 2836 238055  
F: + 91 2836 239055  
E: bdc@kandlaport.com  
W: www.kandlaport.com

**Haldia**

**TM International Logistics Ltd.**  
Finger Jetty Road  
Chiranjibpur  
Haldia  
East Midnapore(WB)  
721604  
India  
Contact: Mr K.L. Bhowmick  
Job Title: Chief of Port Operations  
T: + 91 3224 252150  
E: kb\_hal@tmilltd.com  
W: http://www.tmilltd.com/

**Hyderabad**

**Gangavaram Port Limited**  
Hansa Crest, 1st Floor  
Plot No.62, Road No.1  
Jubilee Hills  
Hyderabad  
Andhra Pradesh  
500 033  
India  
Contact: Mr Sanjay Gupta  
Job Title: Director - Commercial  
T: + 91 40 4434 9999  
F: + 91 40 4434 9990  
E: sgupta@gangavaram.com  
W: www.gangavaram.com

**Karnataka State**

**Karwar Port Authority**  
c/o Tata Marine Agencies  
The Director of Ports & IWT  
Uttar Kannada District  
Karnataka State  
Karwar  
581302  
India  
Job Title: Port Officer  
T: + 91 8382-21494  
F: + 91 8382 21488  
E: directorate@sancharnet.in

**Karnataka State**

**New Mangalore Port Trust**  
Panamburg  
Karnataka State  
Mangalore  
575 010  
India  
Contact: Mr Shri P. Tamilvanan  
Job Title: Chairman  
T: + 91 824 240 7300  
F: + 91 824 2408390  
E: nmpchairman@sify.com  
W: www.newmangalore-port.com

**Kolkata**

**Riverine Group**  
5 A, N. C. DUTTA SARANI  
3rd Floor  
Kolkata  
West Bengal  
700001  
India  
Contact: Mr Shrey Tayal  
Job Title: Director  
T: + 91 33 4005 4949  
F: + 91 33 4005 4909  
E: shreytayal@riverinegroup.co.in  
W: www.riverine-group.com

**Kolkata**

**T M International Logistics Limited**  
subsidiary of TATA Steel  
TATA Centre 14th Floor  
43 Jawaharlal Nehru Road  
Kolkata  
70071  
India  
Contact: Mr M S Sulochana Ghosh  
Job Title: RIC  
T: + 91 33 2300 9003  
F: + 91 33 2288 3011  
E: gsulochana@tatasteel.com

**Minapore**

**Haldia Port Authority**  
Calcutta Port Trust  
Haldia Dock Complex  
Jawahar Tower Annex  
Minapore  
721 607  
India  
Contact: Mr Rajeev Dube  
Job Title: General Manager-Operations  
T: + 91 3224 263 209  
F: + 91 3224 6310 0151  
E: haldia.dock@nic.in  
W: www.kolkataporttrust.gov.in

**Mumbai**

**Bombay Port Trust**  
Shoorji Vallabhdas Marg  
Ballard Estate  
Mumbai  
400038  
India  
Contact: Shri V. R. Joglekar  
Job Title: Chief Public Relations Officer  
T: + 91 22 261 4321  
F: + 91 22 261 1011  
E: pro@mbptmail.com  
W: http://mumbaiport.gov.in/  
LOA 110, beam: 32, dwt: 12,500 tonnes. Two heavy-duty cranes, discharging boom, hoppers, conveyor system on board, discharging rate 18,000 tonnes per day.

**Mumbai**

**J.M. Baxi & Co**  
Sapt Building  
2nd Floor  
18 J.N. Heredia Marg  
Ballard Estate  
Mumbai  
400 001  
India  
Contact: Mr John C. Alexander  
Job Title: Senior VP Business

Development  
T: + 91 22 2270 3779 / 82  
F: + 91 22 2210 3629  
E: jca@jmbaxi.com  
W: www.jmbaxi.com

**Mumbai**

**Seacrest Marine Services Pvt. Ltd.**  
201, Remi Biz Court A Wing  
Plot - 9, Shah Industrial Estate,  
Veera Desai Road,  
Andheri (W)  
Mumbai  
400053  
India  
Contact: Captain Sanjay Kumar  
T: + 91 22 27 566 813  
F: + 91 22 27 566 815  
E: operations@crestsea.com  
W: www.crestsea.net

**Mumbai**

**Skil Infrastructure Ltd**  
Skil House  
209 Bank Street  
Cross Lane, Fort  
Mumbai  
400023  
India  
Contact: Mr Nikhil Gandhi  
Job Title: Group Chairman  
T: + 91 22 66199163  
F: + 91 22 22696023  
E: excellent.india@gmail.com  
W: www.pipavav.com

**Mundra**

**Adani Ports and Special Economic Zone Limited**  
Navinal Island  
Mundra  
370421  
India  
Contact: Mr Sadhu Ravindra  
Job Title: Engineering Services  
T: +91-9687639233  
E: ravindra.sadhu@mundraport.com

**Nagapattinam**

**Nagapattinam Port Authority**  
Port Office  
PO Box No 6  
Nagapattinam  
Tamil Nadu State  
611 001  
India  
Contact: Captain M Anbarasan  
Job Title: Port Captain  
T: + 91 4356 242255  
F: + 91 4365 242363

**Nungambakkam**

**International Seaports (India) Pvt Ltd**  
East India Chambers, 3rd Floor  
3 Village Road  
Nungambakkam  
Chennai  
600 034  
India  
Job Title: Vice President  
T: + 91 44 2 8238804  
F: + 91 44 2 8238809  
E: info@ispl.co.in

**Orissa**

**Paradip Port Trust**  
PO Paradip Port  
District Jagatsinghpur  
Orissa  
754 142  
India  
Contact: Mr G.J. Rao  
Job Title: Chairman  
T: +91 6722222 046 /127  
F: + 91 6722 22256  
E: chmppt@paradipport.gov.in  
W: http://www.paradipport.gov.in/

**Porbander**

**Porbandar Port Authority**  
Bandar Road  
Porbander  
Gujarat State  
360 575  
India  
Job Title: Port Director  
T: + 91 286 20147  
F: + 91 286 44013  
E: gmbad1@sancharnet.in  
W: www.gmbports.org

**Port Okha**

**Port Okha Port Authority**  
Port Officer  
Gujarat Maritime Board  
Port Okha  
Gujarat State  
India  
Contact: Captain G.G Panday  
Job Title: Port Officer  
T: + 91 2892 262 001  
F: + 91 2892 262 002  
E: gmbad1@sancharnet.in  
W: www.gmbports.org

**Tuticorin**

**Tuticorin Port Trust**  
Tuticorin  
Tamil Nadu  
628 004  
India  
Contact: Mr N K Raghupathy IAS  
Job Title: Chairman  
T: + 91 461 235 2290  
F: + 91 461 235 2031  
E: info@tuticorinport.gov.in  
W: tuticorinport.gov.in/  
Located in the Gulf of Mannar.  
Latitude: 8° 45' North. Longitude: 78° 13' East on the east coast of India  
VOC I & II; 800,000tpa, AB I & II; 890,000tpa, VIII BERTH; 1,280,000tpa  
VOC I & II; 9.3m draught each, 25,000dwt and 40,000dwt, AB I & II; 8.6m & 9.3m draught, 40,000dwt, VIII BERTH; 10.8m draught, 65,000dwt  
60,000sqm + 5 hectares  
10,800sqm

**Visakhapatnam**

**Port of Visakhapatnam**  
Visakhapatnam  
Andhra Pradesh  
530-035  
India  
Contact: Mr Ajeya Kallam  
Job Title: Chairman  
T: + 91 891 256 2758  
F: + 91 891 256 5023  
E: info@vizagport.com  
W: www.vizagport.com

**Visakhapatnam**

**Visakhapatnam Port Trust**  
Visakhapatnam  
530 035  
Andhra Pradesh  
India  
Contact: Mr Ajeya Kallam  
Job Title: Chairman  
T: + 91 891 2876 001  
F: + 91 891 2565023  
E: info@vizagport.com  
W: www.vizagport.com

**INDONESIA**

**Bandar Lampung**

**PT. Bukit Asam (Persero) Tbk**  
Jl. Soekarno Hatta Km. 15  
Tarahan  
Bandar Lampung  
DKI Jakarta  
Indonesia  
Contact: Mr Edy Purwanto

Job Title: Senior Manager  
Marketing  
T: + 62 21 525 4014  
F: + 62 21 525 3992  
E: epurwanto@bukitasam.co.id  
W: www.ptba.co.id

**Banjarmasin**

**Port of Banjarmasin**  
PT (Persero) Pelabuhan Indonesia III Banjarmasin  
Jl Barito Hilir No 6  
Banjarmasin  
70117  
Indonesia  
Contact: Mr Anton Tri Agung  
Job Title: Shipping Superintendent  
T: + 62 51 153 670  
F: + 62 51 152 552  
E: inaport3@pp3.co.id  
W: www.pp3.co.id

**Bitung**

**Port of Bitung**  
Bitung Port Administration  
Indonesian Port Corp IV  
Jl DS Sumolang No 1  
Bitung  
95522  
Indonesia  
Contact: Mr Soedaryono  
Job Title: Manager  
T: + 62 43 821196  
F: + 62 43 821380

**Cilacap**

**Cilacap**  
Port Administrator  
Jalan Niaga  
Cilacap  
Indonesia  
Job Title: Port Director  
F: + 62 282 34217

**Cilegon**

**PT Krakatau Bandar Samudera**  
JL. May. Jend S. Parman  
Km. 13  
Cigading  
Ciwandan  
Cilegon  
Banten  
42447  
Indonesia  
Contact: Mr Zamhari Hamid  
Job Title: Comercial Director  
T: + 62 254 311182 / 0  
F: + 62 254 311178  
E: azhar@cigadingport.com  
W: www.cigadingport.com

**Irian Jaya**

**Amamapare**  
Freeport Indonesia Inc  
Irian Jaya  
Indonesia  
Contact: Mr S Rizal  
T: + 62 967 34018

**Jakarta**

**Balikpapan Coal Export Terminal**  
PT Demaga Perkasapratama  
The Landmark Centre Tower B  
29th Floor  
Jl Jend Sudirman No1  
Jakarta  
14310  
Indonesia  
Contact: Mr Edward Djumali  
T: + 62 21 570 155  
F: + 62 21 570 145

**Jakarta**

**Gebe Island**  
c/o PT Pelayaran Bahtera Adhiguna  
10-12 Jl Kalibesar Timur  
PO Box 1315  
Jakarta  
Indonesia

Job Title: Port Director  
T: + 62 21 691 2547  
F: + 62 21 690 1450

## Jakarta

**North Pulau Laut Coal Terminal**  
PT Arutmin Indonesia  
Mid Plaza 2, 9th Floor  
Jalan Jenderal Sudirman Kav. 10-11  
Jakarta  
10220  
Indonesia  
T: + 62 21 5720012  
F: + 62 21 5741689  
E: marketing@arutmin.com  
W: www.arutmin.com

## Jakarta

**P T Indominco Mandiri**  
Ventura Building  
8th Floor  
J1 RA Kartini No 26 Cilandak  
Jakarta  
12430  
Indonesia  
Contact: Mr Suriya  
Job Title: President Director  
T: + 62 021 750 8376  
F: + 62 021 750 8380  
E: dharماسubur@cbn.net.id

## Jakarta

**PT Indonesia Bulk Terminal**  
Jl. HR Rasuna Said  
Blok X-5, Kav. 1-2  
Menara Karya, 23rd Floor  
Jakarta  
12950  
Indonesia  
Contact: Mr Bram Surjadi  
Job Title: Marketing  
T: + 62 21 5211 265 / + 62 21 25533000 ext 3244  
F: + 62 21 522 4341  
E: marketing@ibt.co.id  
W: www.ptibt.com  
South Kalimantan, Indonesia  
2 discharging wharfs - 1500tph rate, 2 shiploaders - 3000 tph rate. 12 m tonnes annual throughput capacity  
Max vessel size 80,000dwt, max LOA 230m, max beam 36m, max draught 14.5m, 1 berth, 288m wharf length  
8 stockpiles, total capacity 800,000 tonnes  
Please see our website  
www.ptibt.com

## Jakarta

**PT MIANG BESAR COAL TERMINAL**  
Ventura Building  
5th Floor Suite 503  
Jl. R. A. Kartini No. 26  
Cilandak Barat  
Jakarta  
12430  
Indonesia  
Contact: Mr Jim Dracopoulos  
Job Title: Commercial and Marketing  
T: + 62 21 765 2544  
F: + 62 21 765 2627  
E: jdrac@mbct.co.id  
W: http://www.mbct.co.id

## Jakarta

**Pt. Pulau Laut**  
Jl. Raya Pelabuhan No.41  
Tanjung Priok  
Jakarta 14310  
Indonesia  
Contact: Mr Djoko (Tommy)  
Oetomo  
Job Title: President Director  
T: + 62 21 494 769  
F: + 62 21 430 0922

## Jakarta

**PT. Terminal Batubara Indah**  
World Trade Centre, 07th floor  
Jl. Jend Sudirman Kav. 29-31  
Jakarta  
12920  
Indonesia  
Contact: Mrs Lilly  
T: + 62 21 5712579  
F: + 62 21 571 2597  
W: www.pttbi.co.id

## Jakarta

**Pulau Laut**  
World Trade Centre 7 Floor  
JL Send  
Surdiman Kav 31  
Jakarta  
12920  
Indonesia  
Contact: Mr B T Kuan  
Job Title: General Manager  
T: + 62 21 522 9250  
F: + 52 21 522 4341

## Jakarta

**Tanjung Priok**  
PT (Persero) Peleabuhan Indonesia II  
Jalan Raya Pelabuhan No 9  
Tanjung Priok  
Jakarta  
14310  
Indonesia  
Contact: Mrs Lani  
Job Title: Port Manager  
T: + 62 21 430 1080  
F: + 62 21 437 2933  
E: priok@inaport2.co.id  
W: www.priokport.co.id

## Kijang

**Port of Kijang**  
c/o PT Aneka Tambang  
Unit-pertambangan Bauksit  
Kijang  
Tanjung Pinang  
Indonesia  
Job Title: Port Director  
T: + 62 622 21177  
F: + 62 622 61561

## Kotabaru

**PT Indonesia Bulk Terminal**  
Pulau Laut Coal Terminal  
PO Box. 118 Kalsel  
Kotabaru  
Kalimantan Selatan  
72111  
Indonesia  
Contact: Mr Wan Yazid  
Job Title: Terminal Manager  
T: + 62 5183 8800  
F: + 62 5183 8822  
E: marketing@ibt.co.id  
W: www.ptibt.com  
Pulau Laut on the Kalimantan Selatan  
Unloading Barges and Loading  
Vessels, 3,000tph  
10,000,000tpa of coal handled.  
120 hectare  
60 hectare

## Lampung

**Pelabuhan Panjang**  
Dit Jen Perhubungan Laut  
Pelabuhan Panjang  
Lampung  
Indonesia  
Contact: Mr Prayitno  
Job Title: Port Manager  
T: + 62 721 31098  
F: + 62 721 33237

## Lhokseumawe

**Port of Lhokseumawe**  
Ji Pelabuhan Lama 3  
Lhokseumawe  
Aceh

Indonesia  
Contact: Mr M Sandi  
Job Title: Port Manager  
T: + 62 645 43485  
F: + 62 645 43485

## Padang

**Port of Teluk Bayur**  
Jl Semarang No 3  
Teluk Bayur  
Padang  
25217  
Indonesia  
Contact: Mr Sarwediona  
Job Title: Port Manager  
T: + 62 751 61646  
F: + 62 751 61169  
E: corp\_sec@inaport2.co.id  
W: www.telukbayurport.com

## Padang

**Teluk Bayur Coal Terminal**  
PT Tambang Batubara Bukit Asam (PTBA)  
Jl Tanjung Priok  
No 01 Teluk Bayur  
Padang  
West Sumatra  
Indonesia  
Contact: Mr Muztav Sjab  
Job Title: Taluk Bayur Coal Terminal Manager  
T: + 62 734 4510 96  
F: + 62 21 525 4002  
E: corsec@bukitasam.co.id  
W: www.ptba.co.id

## Palembang

**Kertapati Coal Terminal**  
PT Tambang Batubara Bukit Asam (PTBA)  
Jl Stasiun Kerata Api  
Palembang  
South Sumatra  
Indonesia  
Contact: Mr Dadan Ruswandana  
Job Title: Coal Terminal Manager  
T: + 62 711 512 617  
F: + 62 711 511 388  
W: www.bukitasam.co.id

## Palembang

**Port Authority Palembang**  
Jl. Blihyu nomor 1  
Boom Baru  
Palembang  
South Sumatera  
30115  
Indonesia  
Contact: Mr Housan  
T: + 62 711 710611 / +62 8159946494  
F: + 62 711 711758  
E: tmplp@palembangport.com  
W: www.palembangport.com  
Latitude 02° - 58' - 48" S.  
Longitude 104° - 46' - 36" E.  
Max LOA 151m.  
Max Length: 475m  
Boom Baru: 8,173 sqm  
Sungai Lais: 16,700 sqm  
Boom Baru - Warehouse: 9,785 sqm  
Sungai Lais - Shed: 230 sqm

## Sabang

**Port of Sabang**  
Sabang Port Administration Office  
Dit Jen Perhubungan Laut  
Cabang Sabang  
Sabang  
Aceh  
Indonesia  
Job Title: Operations Manager  
T: + 62 652 21207  
E: humas@tps.co.id  
W: www.tps.co.id

## Surabaya

**Surabaya Port Authority**  
Jalan Tanjung Perak  
Timur 610

Surabaya  
Indonesia  
Contact: Mr Mfugand Briyanpo  
Job Title: Manager  
T: + 62 31 3291364  
F: + 62 31 313835  
E: humas@tps.co.id  
W: www.tps.co.id/

## Tanjung Priok

**Bogasari Flour Mills Terminal**  
Tanjung Priok  
Indonesia  
Contact: Mr Joko  
T: + 62 31 329 3082  
F: + 62 31 329 1843  
E: lagansa@bogasariflour.com  
W: www.bogasariflour.com

## IRAN

### Tehran

**Bandar Abbas Port Authority**  
Ports and Shipping Organisation  
751 Enghelab Avenue  
Tehran  
15994  
Iran  
Contact: Mr Sarwediona  
Job Title: Port Manager  
T: + 62 751 33533  
F: + 62 751 33569

### Tehran

**Chah Bandar Port Authority**  
Ports and Shipping Organisation  
751 Enghelab Avenue  
Tehran  
15994  
Iran  
Contact: Mr M R Ghaderi  
Job Title: Director General-Maritime Affairs  
T: + 98 21 880 9280  
F: + 98 21 880 9324

### Tehran

**Khorramshar Port Authority**  
Ports and Shipping Organisation  
751 Enghelab Avnue  
Tehran  
15994  
Iran  
Contact: Mr Mohammad Hossein Alaei  
Job Title: Public Relations Manager  
T: + 98 21 880 9280  
F: + 98 21 880 9324  
E: m\_alaei@khmail.ir  
W: www.khport.ir

## IRELAND

### Arklow

**Arklow Port Authority**  
Harbour Office  
South Quay  
Arklow  
Ireland  
Contact: Mr Tommy Myler  
Job Title: Harbour Master  
T: + 353 402 32466  
F: + 353 402 31068  
E: gavin@arklowportharbour.com

### Cork

**Port of Cork Company**  
Custom House Street  
Cork  
Munster  
Ireland  
Contact: Ms Sara Dymond  
Job Title: Marketing Executive  
T: + 353 21 427 3125  
F: + 353 21 427 6484  
E: sdymond@portofcork.ie  
W: www.portofcork.ie  
South Coast of Ireland  
2 high output dockside cranes

(rated capacity 400 tonnes per hour) and one mobile (rated capacity 600 tonnes per hour)  
Ringaskiddy Deepwater Berth:  
Length 485m Depth 13.4m CD  
South Jetties: Length 411m Depth 8.8m CD

### Cork

**Ringaskiddy Deepwater Terminal**  
Port of Cork Company  
Custom House Street  
Cork  
Ireland  
Contact: Mr Sean Geary  
T: + 353 21 4273125  
F: + 353 21 4276484  
E: info@portofcork.ie  
W: www.portofcork.ie

### Dublin

**Dublin Port & Docks Board**  
Port Centre  
Alexandra Road  
Dublin  
Ireland  
T: + 353 1887 60 00  
F: + 353 1874 12 41  
W: www.dublinport.ie

### Dundalk

**Dundalk Harbour Commissioners**  
Harbour Office  
40 Quay Street  
Dundalk  
Co Louth  
Ireland  
Contact: Captain Frank Allen  
Job Title: Harbour Master  
T: + 353 42 9334096  
F: + 353 42 35481  
E: dundalkport@eircon.net

### Foynes

**Shannon Foynes Port Company**  
Harbour Offices  
Main Street  
Foynes  
County Limerick  
Ireland  
Contact: Mr Martin Morrissey  
Job Title: Commercial Manager  
T: + 353 69 73100  
F: + 353 69 65 142  
E: mmorrissey@sfpcc.ie  
W: www.sfpcc.ie

### Galway

**Galway Harbour Company**  
Harbour Office  
New Docks  
Galway  
Ireland  
Contact: Captain Brian Sheridan  
Job Title: Harbour Master  
T: + 353 91 561874  
F: + 353 91 563738  
E: info@galwayharbour.com  
W: www.galwayharbour.com

### Greenore

**Greenore Port Limited**  
Greenore  
Co Louth  
Ireland  
Contact: Mr Roisin de Pasquale  
Job Title: Managing Director  
T: + 353 42 937 3170  
F: + 353 42 735 67  
E: info@greenore.net

### Kilrush

**Kilrush Port Authority**  
Kilrush Urban District Council  
Town Hall  
Kilrush  
Co Clare  
Ireland  
Contact: Mr John Corrie  
Job Title: Town Clerk



T: + 353 65 905 1047  
F: + 353 65 905 2821  
E: kilrush@clarecoo.ie

**Kinsale**

**Henry Good Limited**  
Waterlands  
Kinsale  
Co Cork  
Ireland  
Contact: Mr Roger Dale  
Job Title: Director  
T: + 353 21 4772300  
F: + 353 21 4772548

**Kinsale**

**Kinsale Harbour Commissioners**  
Harbour Office  
Pier Road  
Kinsale  
Co Cork  
Ireland  
Contact: Capt. Phil Devitt  
Job Title: Harbour Master/Secretary  
T: + 353 21 477 2503  
F: + 353 21 477 4695  
E: kharbour@iol.ie  
W: www.kinsaleharbour.com  
South Coast of Ireland  
1 Crane & Bob Cat  
68m long (Can handle vessels of 95m long ...up to 4,000 D/W)  
N/A  
N/A  
Henry Good Ltd. Agents, Hauliers and storage facilities (covered of approx. 5,000m<sup>2</sup>)

**New Ross**

**New Ross Port Company**  
Harbour Office  
The Quay  
New Ross  
Co Wexford  
Ireland  
Contact: Captain L J Foley  
Job Title: Harbour Master/CEO  
T: + 353 5142 1303  
F: + 353 5142 1294  
E: ceo@newrossport.iol.ie  
South coast Ireland.

**Tralee**

**Fenit Port Authority**  
Tralee and Fenit Harbour Commissioners  
Harbour Offices  
Fenit  
Tralee  
Co Kerry  
Ireland  
Contact: Mr D Buttmer  
Job Title: Port Manager  
T: + 353 66 36231  
F: + 353 66 36231  
E: fenitmarina@eircom.net

**Turvey**

**Moneypoint**  
Electricity Supply Board  
Moneypoint Generating Station  
Unit 19, Turvey Business Centre  
Turvey  
County Dublin  
Ireland  
Contact: Mr Paul Dunne  
T: + 353 1 8900466  
F: + 353 1 8900575  
E: info@moneypoint.ie

**Waterford**

**Port of Waterford Company**  
3rd Floor  
Marine Point  
Belview Port  
Slieverue  
Waterford  
Munster  
Ireland  
Contact: Mr Stan McIlvenny  
T: + 353 51 874907

F: + 353 51 874908  
E: jsm@portofwaterford.com  
W: www.portofwaterford.com  
South East of Ireland  
1 Liebherr RH 1080 Portal crane, with a 12 cubic metre grab, and a 400 T/hr pneumatic ship discharge unit  
1 Liebherr 250 portal crane, with a 65 tonne lift capacity, 20 cubic metre grab, and a new 11 cubic metre cactus grab  
513m of bulk quay  
Substantial  
Substantial

**Wicklow**

**Wicklow Port Co**  
Harbour Office  
North Quay  
Wicklow  
Ireland  
Contact: Capt. J.M. Barlow  
Job Title: Harbour Master/CEO  
T: + 353 404 67455  
F: + 353 404 67455  
E: wicklowport@eircom.net  
South East Ireland (Irish Sea)  
All mobile cranes depending on cargo. 150 tonne (plus) per hour on timber.  
110 metres length, draught 5.5mt.  
Total of 3 berths.  
To be advised on request  
To be advised on request  
All other cargoes can be accommodated by direct delivery. (Off hook)

**ISRAEL**

**Ashdod**

**Ashdod Port Co. Ltd**  
Ports and Railways Authority  
PO Box 9001  
Ashdod  
77191  
Israel  
Contact: Capt Yaakov Tzemach  
Job Title: Harbour Master  
T: + 972 8 851 7279  
F: + 972 8 851 7296  
E: yaakovt@ashdodport.co.il  
W: www.ashdod.org.il

**Ashkelon**

**The National Coal Supply Corporation (N.C.S.C)**  
Ashkelon Coal Terminal  
Ashkelon  
Israel  
T: + 972 3625 7000  
F: + 972 3625 7001  
E: ncsc@ncsc.co.il  
W: www.ncsc.co.il

**Eilat**

**Eilat Port Ltd - Israel**  
PO Box 37  
Eilat  
88100  
Israel  
Contact: Captain Guy Gilron  
Job Title: Harbour Master  
T: + 972 7 6358341  
F: + 972 7 6358300  
E: gilrong@eilatport.co.il  
W: www.israports.org.il  
South Israel  
Shipping & Ports  
200,000sqm  
30,000sqm  
Eilat port is the south entrance to Israel.

**Hadera**

**Port of Hadera**  
PO Box 314  
Hadera  
38102

Israel  
Contact: Mr Yoram Nachshol  
Job Title: Managing Director  
T: + 972 4 622 5577  
F: + 972 4 634 3034

**Hadera**

**The National Coal Supply Corporation Ltd (NCSC)**  
Hadera Coal Terminal  
Hadera  
Israel  
T: + 972 3625 7000  
F: + 972 3625 7001  
E: ncsc@ncsc.co.il  
W: www.ncsc.co.il

**Haifa**

**Haifa Grain Terminal**  
Israel Ports and Railways Authority  
PO Box 33539  
Haifa  
31334  
Israel  
Contact: Mr Mendy Zaltzman  
Job Title: Port Manager  
T: + 97 24 851 8111  
F: + 97 24 867 4853

**Haifa**

**Haifa Port Company Ltd**  
Haifa Port and Railways Authority  
PO Box 33539  
Haifa  
31334  
Israel  
Contact: Mr Mendy Zaltzman  
Job Title: Port Manager & Managing Director  
T: + 972 4 851 8111  
F: + 972 4 867 4853  
E: mendy.zaltzman@haifaport.co.il  
W: www.haifaport.com

**Tel Aviv**

**Israel Ports Company**  
74 Derech Menachem Begin  
Tel Aviv  
67215  
Israel  
Contact: Mr Dov Frohlinger  
Job Title: COO  
T: + 972 3565 7060  
F: + 972 3562 2281  
E: dov@israports.co.il  
W: www.israports.co.il  
Government owned company responsible for the management and development of Israel's seaport infrastructure.

**Tel Aviv**

**Ports & Railways Authority**  
Menachem Begin Road 74  
Tel Aviv  
61201  
Israel  
Contact: Ms Gittith Shlapobersky  
Job Title: Librarian  
T: + 972 3 5657087  
F: + 972 3 5619338  
E: info@israports.org.il

**Tel Aviv**

**Ports and Railways Authority of Israel**  
74 Menachem Rd  
Tel Aviv  
67215  
Israel  
Contact: Mr Gul Caplan  
Job Title: I/C Materials Handlings Equipment  
T: + 972 3 565 7913  
E: info@israports.co.il  
W: www.israports.org.il

**ITALY**

**Ancona**

**Ancona Coal Terminal**  
Ancona  
Italy  
Contact: Mr Paolo Galli  
T: + 39 071 2071664  
F: + 39 071 2077736  
E: operativo@anconamerici.it

**Ancona**

**Ancona Port Authority**  
Banchina Nazario Sauro 12  
Ancona  
60100  
Italy  
Contact: Mr Plavigi  
Job Title: Port Director  
T: + 39 071 207891  
F: + 39 071 2078940  
E: info@autoritaportuale.ancona.it  
W: www.autoritaportuale.ancona.it

**Barlette**

**Barletta Port Authority**  
Port Captain  
1 Campanone  
Via Colombo 30  
Barletta  
70051  
Italy  
Contact: Commendant Carbonara  
Job Title: Port Director  
T: + 39 088 353 1020  
F: + 39 088 353 3400  
E: barletta@guardiacostiera.it

**Cagliari**

**Port of Cagliari**  
Port Captain  
Cagliari  
09100  
Italy  
Contact: Mr N Silenti  
Job Title: Operations Director  
T: + 39 070 679 531  
F: + 39 070 679 533 45  
E: autorita.portuale@tiscali.it  
W: www.porto.cagliari.it

**Chioggia**

**Chioggia Port Authority**  
Port Captain  
Piazza Santa Croce 1290  
Chioggia  
30015  
Italy  
Contact: Mr R Barnabei  
Job Title: Port Commander  
T: + 39 041 520 5600  
F: + 39 041 550 6812  
E: info@chioggia.evanes.it

**Civitavecchia**

**Civitavecchia Port Authority**  
Consorzio Autonomo Pier Di  
Civitavecchia  
Porto di Civitavecchia  
Civitavecchia  
00053  
Italy  
Contact: Mr Marinucci  
Job Title: Port Director  
T: + 39 076 636 6201  
F: + 39 766 501717  
E: marinucci@portodicivitavecchia.it  
W: www.portidiroma.it

**Crotone**

**Crotone Port Authority**  
Liga Navale Italiana  
Port Captain  
Crotone  
Italy  
Contact: Captain Valentini  
Job Title: Port Captain  
T: + 39 0962 20721  
F: + 39 0962 290 2094

E: info@portodigiogliatauro.it  
W: www.portodigiogliatauro.it

**Gaeta & Civitavecchia**

**Intergroup S.r.l.**  
Lungomare Caboto 110  
Gaeta & Civitavecchia  
Rome area  
04024  
Italy  
Contact: Mr Giovanni Migliaccio  
Job Title: General Manager  
E: operativo@intergroup.it  
T: + 39 771 310 077  
F: + 39 771 472 114  
E: info@intergroup.it  
W: www.intergroup.it  
Central Italy, port of Romes.  
Gottwald cranes, Terberg tag master, Scania trucks, Caterpillere, linde forklifts, concetti packaging equipment.  
12m  
Services: National and International transport, warehousing, packaging, special cargo handling.

**Gela**

**Gela Port Authority**  
Gela Ufficio Circondariale Marittimo  
Street Mare no 156  
Gela  
93012  
Italy  
Contact: Mr Com Adrogano  
Job Title: Harbour Master  
T: + 39 0933 917755  
F: + 39 0933 913700  
E: gela@guardiacostiera.it

**Genova**

**Port of Genova**  
Palazzo San Giorgio  
Via Della Mercanzia 2  
Genova  
16123  
Italy  
Contact: Snr Pietro Oddone  
Job Title: Marketing Director  
T: + 39 010 241 2793  
F: + 39 010 241 2309  
E: p.oddone@porto.genova.it  
W: www.porto.genova.it

**Genova**

**Terminal Rinfuse Genova SpA**  
Palazzina Uffici  
Calata Rubattino  
Genova  
16126  
Italy  
Job Title: Commercial Director  
T: + 39 010 248 8620  
E: alessandro.vianello@euroports.it  
W: www.porto.genova.it

**La Spezia**

**La Spezia Port Authority**  
Viale Italia 4  
La Spezia  
Italy  
Contact: Mr Sergio Somaglia  
Job Title: Marketing Manager  
T: + 39 0187 546328  
F: + 39 0187 599664  
E: sergio.somaglia@porto.laspezia.it  
W: www.portolaspezia.it

**Livorno**

**Livorno Port Authority**  
Scali Rosciano 6  
Livorno  
57123  
Italy  
Contact: Mr Roberto Lippi  
Job Title: Head of Promotions Dept.  
T: + 39 058 624 9411  
F: + 39 0586 249 515  
E: marketing@porto.livorno.it  
W: www.portauthority.li.it  
Central Italy on the west coast  
Multipurpose and container port

with 31 terminals equipped.  
1,600,000sqm of harbour, useable land area of 2,500,000sqm, 11,250m of quays with 97 berths for vessel with up to 13 m draughts. Cereals - 340 metres quay  
Dry bulk cargo - 450 metres quay  
Forest, Pulp and Paper - 860 metres quay  
1,000,000 sqm  
70,000 sqm covered storage facilities  
A Logistic platform ( Interporto Vespucci) is 5 km away from the port and directly connected with 4 lane fast road and rail. Total uncovered storage of 822,000 sqm, total covered storage of 325,000sqm

## Manfredonia

### Manfredonia Port Authority

Port Captain  
Piazza Marconi  
Manfredonia  
Italy  
Contact: Captain Antonio Vincenzo Ranieri  
Job Title: Port Captain  
T: + 390 884 583 871  
F: + 39 0884 587388  
E: manfredonia@guardiacostiera.it

## Palermo

### Palermo Port Authority

Via Paino dell'Ucciardone 4  
Palermo  
90139  
Italy  
Contact: Mr Riccardo Damico  
Job Title: General Manager  
T: + 39 091 627 7111  
F: + 39 091 637 4291  
E: promocion@autport.pa.it  
W: www.autport.pa.it

## Piazzale Cabato

### Gaeta Port Authority

Port Captain  
Piazzale Cabato  
Gaeta  
04024  
Italy  
Contact: Mr Mario Magliulo  
Job Title: Port Director  
T: + 39 0771 460 088  
F: + 39 771 464 724  
E: gaeta@guardiacostiera.it

## Piombino

### TOP - Terminal Offshore Piombino

(subsidiary of Coeclerici SpA)  
Uff. Circondariale Marittimo  
P. Le Premuda 19  
Piombino  
Livorno  
57025  
Italy  
Contact: Mr Giordano Scotto d'Aniello  
Job Title: Head of Commercial Department (Logistics Division)  
T: + 39 02 624 69451  
F: + 39 02 694 69444  
E: newprojects@coeclerici.com  
W: www.coeclerici.com  
North West coast Italy  
500,000 tpa  
Max beam 42m, Max Airdraught 15m  
The self propelled Floating Transfer Station Bulk Irony is utilized since 2003 by Lucchini Steel Mill to overcome Piombino's draught restrictions. Bulk Irony was designed for lighterage part of the raw materials shipment (both coal and iron ore) offshore, thereby reducing the overall sea freight charge.

## Piombino (LI)

### Autorità Portuale di Piombino

Ente di Diritto Pubblico  
Legge 28 gennaio 1994, n. 84  
Piombino (LI)  
Toscana  
57025  
Italy  
Contact: Mr Giampiero Costagli  
Job Title: Responsabile Promozione, Comunicazione e PR  
T: + 39 0565 229210  
F: + 39 0565 229229  
E: g.costagli@ap.piombinoelba.it  
W: http://www.porto.piombino.li.it  
LOA 110, beam: 32, dwt: 12,5000 tonnes. Two heavy-duty cranes, discharging boom, hoppers, conveyor system on board, discharging rate 18,000 tonnes per day.

## Porto Torres

### Porto Torres Port Authority

Capitaneria di Porto Torres  
Porto Torres  
Italy  
Contact: Mr Luigi Gargiulo  
Job Title: Port Captain  
T: + 39 079 502258  
F: + 39 79 502090  
E: info@portodigioliatauro.it  
W: www.portodigioliatauro.it

## Ravenna

### Ravenna Port Authority

Via Magazzini Anteriori, 63  
Ravenna  
48100  
Italy  
Contact: Ms Mariliana Moschona  
Job Title: Marketing Manager  
T: + 39 0544 608811  
F: + 39 0544 421945  
E: mariliana.moschona@port.ravenna.it  
W: www.port.ravenna.it  
North East of Italy 44° 23'N 12° 17' East  
8 cranes, 3 gantry cranes, 9 pneumatic suckers, 3 bag chutes  
2,846m quay length  
1,358,000sqm  
2,575,000m<sup>3</sup> bulk cargo warehouses

## Sant'Antioco

### Sant'Antioco Port Authority

Località Ponta  
Sant'Antioco  
Sardinia  
I-09017  
Italy  
Contact: Mr Maurizio Paganini  
Job Title: Harbour Master  
T: + 39 078 18 3071  
F: + 39 078 18 3071  
E: compamareauop@interfree.it  
W: www.harbours.net/augusta

## Savona

### Authorita Potuati di Savona

vai Gramsci  
Savona  
17100  
Italy  
Contact: Mr Agostino Ghiglione  
T: + 39 01982 5541  
F: + 39 01982 7399  
E: authority@porto.sv.it  
W: www.porto.sv.it/english/The-Port/Port-s-Ope/Terminals/Rinfuse-So/savonasilos.htm\_cvt.htm#

## Savona

### Port Authority of Savona

Via Gramsci, 14  
Savona  
17100  
Italy  
T: + 39 019 85 541  
F: + 39 019 827399

E: authority@porto.sv.it  
W: www.porto.sv.it  
Northern Italy-Tyrrenian Sea  
Max depth 19.5m:  
Quay 16A: length 128m, depth 11m;  
Zone 26, length 390m, depth 15.5m;  
Public Berths; draught 15.5m;  
Zone 30, length 300m, depth 19.5m;  
Zone 31, length 180m, depth 15m;  
Zone 32, length 180m, depth 15m;  
Zone 14/15/16, length 292m, depth 12m;  
S. Raffale jetty, length 450m, depth 13m  
A number of terminals handling dry bulk exist at the Port

## Sicily

### Siracusa Port Authority

Capitaneria di Porto  
Siracusa  
Sicily  
Italy  
T: + 39 93 166 713  
F: + 39 93 169 260  
E: siracusa@guardiacostiera.it

## Torre Annunziata (NA)

### SOLACEM Spa

Molo di Levante - Interno Porto  
Torre Annunziata (NA)  
Naples  
80058  
Italy  
Contact: Dr Giuseppe Rocco  
Job Title: Managing Director  
T: + 39 081 8621199  
F: + 39 081 8615991  
E: direzione@solacem.it  
W: www.solacem.it  
South west Italy between Naples and Salerno.  
50 of 40m high cylindrical silos  
260m for bulk and cerilas for silos and 300m for general cargo, roro, breakbulk and containers.  
25,000sqm  
55,000 tons in silos + 6,500sqm in warehouse  
Vessel draught will increase to 11m, quay length to 100m and a further 50,000sqm storage will be made available. Security is being upgraded, new equipment is being purchased, and transport links between the Port and Naples-Salerno motorway will be made plus a new and direct rail link to the national network.

## Trieste

### Port of Trieste

PO Box 569  
Punto Franco Vecchio  
Trieste  
34100  
Italy  
Contact: Mr Franco Giannelli  
Job Title: Business Activity Manager  
T: + 39 040 673 2335  
F: + 39 040 673 2406  
E: fgiannelli@porto.trieste.it  
W: www.porto.trieste.it

## Trieste

### Trieste Port, Pier 7

Coeclerici Logistics  
Via Diaz 7  
Trieste  
34121  
Italy  
Contact: Mr Giovanni Stecconi  
T: + 39 010 605 3440  
F: + 39 010 605 3444  
E: info@coeclerici.com  
W: www.coeclerici.com  
Floating terminal Bulk Trieste, storage capacity 120,000dwt. Four Cavaletto systems, each with a discharging

capacity of 11,000 tonnes per day.  
One mobile crane.

## Vado Ligure (SV)

### Terminal Rinfuse Vado

Via Montegrappa 1  
Vado Ligure (SV)  
17047  
Italy  
Contact: Mr Vittorio Barzilai  
Job Title: Marketing and Sales  
T: + 39 019 216 06253  
F: + 39 019 216 06299  
E: vittorio.barzilai@terminalrinfuseitalia.it

## Venezia

### T.M.B SRL Venezia

Zattere 1401  
Venezia  
1-30123  
Italy  
T: + 39 041 533 4484  
F: + 39 041 533 4570

## Venice

### Port Authority of Venice

Santa Marta - Fabbriato 13  
Venice  
30123  
Italy  
Contact: Mr Antonio Revedin  
Job Title: Director  
T: + 39 041 533 4284  
F: + 39 041 533 4254  
E: antonio.revedin@port.venice.it  
W: www.port.venice.it

## Venice

### Port of Venice Marghera

Porto Commerciale Molo B  
Zattere 1401  
Venice  
30123  
Italy  
Contact: Mr Stefano Bonaldo  
Job Title: Statistics  
T: + 39 041 533 4281  
F: + 39 041 533 4577  
E: stefano.bonaldo@port.venice.it  
W: www.port.venice.it

## IVORY COAST

## Abidjan

### Port Autonome d'Abidjan

PO Box V85  
Abidjan  
Ivory Coast  
Contact: Mr Jean-Michel Moulod  
Job Title: Managing Director  
T: + 225 21 21 620  
F: + 225 21 24 80 80  
W: www.paa-ci.org/

## JAMAICA

## Kingston

### Kingston Port Authority

PO Box 116  
NewPort East  
Kingston  
Jamaica  
Contact: Mr H C De Lisser  
Job Title: Vice President  
T: + 1 876 922 0290  
F: + 1 876 924 9437  
E: hdelisser@portjam.com

## Kingston

### Port Authority of Jamaica

PO Box 474  
40 Harbour Street  
Kingston  
Jamaica  
Contact: Mr Lucian M Rattray  
T: + 1 876 922 0290  
F: + 1 876 922 6516

E: paj@portjam.com  
W: www.portjam.com

## Kingston

### Port Kaiser

Kaiser Terminal  
Port Authority of Jamaica  
15-17 Duke Street, PO Box 116  
Newport East  
Kingston  
Jamaica  
Contact: Mr J McFarlane  
Job Title: Port Director  
T: + 1 809 922 67 66  
F: + 1 809 922 64 19

## Kingston

### Port of Port Rhoades

Port Authority of Jamaica  
15-17 Duke Street  
Kingston  
Jamaica  
Job Title: Operations Manager  
T: + 1 876 922-0290  
F: + 1 876 924-9437  
E: paj@portjam.com  
W: www.portjam.com

## Saint Ann's Bay

### Ocho Rios Port

Jamaica Bauxite Mines  
Lydford PO  
Saint Ann's Bay  
Jamaica  
Contact: Mr Williams  
Job Title: Port Manager  
T: + 1 876 974 2603  
F: + 1 876 973 1556  
E: paj@portjam.com  
W: www.portjam.com

## St Catherine

### Port Esquivel

c/o WINDALCO (West Indies Alumina Company)  
PO Box 2  
Old Harbour  
St Catherine  
Jamaica  
Contact: Mr Gilbert Callaghan  
Job Title: Director  
T: + 1 876 983 9300  
F: + 1 876 983 2215  
E: gilbert.callaghan@windalco.com  
W: www.portjam.com  
Western Berth: Bulk loading Alumina - Max draught 11.9m.  
Eastern Berth: General Cargo - Max draught 11m, wharf length 198.12m.  
Mini Berth: Max draught 5m, length 70m.

## St Catherine

### West Indies Alumina Company

Port Esquivel  
PO Box 2  
Old Harbour  
St Catherine  
WI  
Jamaica  
Contact: Mr Gilbert Callaghan  
Job Title: Port & Railway Operations Manager  
T: + 876 525 2215  
F: + 876 983 2215  
E: gilbert.callaghan@windalco.com  
W: www.windalco.com  
West Indies  
1500 tonne/hr loading rate  
Berthing of caustic, oil, alumina, ethanol, lime, grain and general cargo  
None  
73 MT Alumina, 55,000 MT Caustic, 380,000 bbls Oil



## JAPAN

**Akigun****Port of Mitsukojima**

Mitsukojima Transshipment Co  
24-1 Tonoko 2-chome, Ondo-cho  
Akigun  
Hiroshima Pref  
Japan  
T: + 81 82 3253336

**Akita City****Port of Akita**

c/o Akita Kairiku Unso Co Ltd  
5-9, Nishi-2 Chome  
Tsuchizaki-Minato  
Akita City  
011  
Japan  
T: + 81 18 845 2021  
E: agent@kairiku.co.jp  
W: www.kairiku.co.jp  
Geographical 39°46'North /  
140°00'East  
One unloader (600MT/hr) for Bulk  
Concentrates  
Gaiko -13M No.1 Pier (for Bulk  
Concentrates)  
Max LOA 200M Max Draft 11.8M  
Nippon Daishowa Itagami Tohoku  
Dolphin (For Woodchip)  
Max LOA 210M Max Draft 10.0M

**Anan City****Port of Anan**

Anan Dobuku Office  
Aotani, Tomioka-cho  
Anan City  
Tokushima Prefecture  
Japan  
Contact: Mr Hirao Hisao  
Job Title: Director General  
T: + 81 886 212580  
F: + 81 886 212874

**Aomori****Port of Aomori**

Aomori Port Admin Office  
5-5, Hon-cho 4 chome  
Aomori  
Japan  
T: + 81 177 344101  
F: + 81 177 344101  
E: kowan@pref.aomori.lg.jp  
W: www.pref.aomori.lg.jp/

**Aomori****Port of Hachinohe**

Hachinohe Port Administration  
Office  
1-131 Kitanuma, Kawaragi  
Hachinohe-Shi  
Aomori  
039-1161  
Japan  
Contact: Mr Ishitori Masahiko  
Job Title: Director  
T: + 81 178 282105  
F: + 81 178 204746

**Chiba City****Chiba Port**

Port & Harbor Division  
Chiba Prefectural Government  
1-1 Ichiba-cho Chou-ku  
Chiba City  
260-8667  
Japan  
Job Title: Port and Harbour  
Management  
T: + 81 43 223 3835  
F: + 81 43 227 0928  
E: kousin2@mz.pref.chiba.lg.jp  
W: www.pref.chiba.lg.jp/  
kouwan/chibanokouwan  
Located in the northeastern part of  
Tokyo Bay and Japan's largest  
seaport.  
Public berth: 12m quay until  
30,000 DWT

Private berth: 19m quay more than  
30,000 DWT aside of JFE Steel  
Company.  
Public for forest products and  
private for many kinds  
of commodities.  
Only one hour's drive from central  
of Tokyo

**Chiba-City****Kisarazu Port**

Port & Harbor Division  
Chiba Prefectural Government  
1-1 Ichiba-cho Chuo-ku  
Chiba-City  
260-8667  
Japan  
T: + 81 43 223 3835  
F: + 81 43 227 0928  
E: kousin2@mz.pref.chiba.lg.jp  
W: www.pref.chiba.lg.jp/kouwan/  
chibanokouwan  
Inside Tokyo bay area and stands  
by the Trans Tokyo Bay bridge  
Public berth: 12 m quay until  
30,000 DWT  
Private berth: 19 m quay more than  
30,000 DWT  
Private berth is managed by big  
steelmaker works (Nippon Steel &  
Sumitomo Metal)  
Kisarazu port is appointed one of  
International Strategic Bulk Port for  
Iron Ore by Minister of Land  
&Transportation

**Chiyoda-ku****Idemitsu Bulk Terminal-Chiba**

c/ Industrial Energy Dpt. Idemitsu  
Kosan  
1-1 Marunouchi 3-chome  
Chiyoda-ku  
Tokyo  
100-8321  
Japan  
Contact: Mr T Nio  
T: + 81 3 3746 8721  
F: + 81 3 3746 3645  
W: www.idemitsu.co.jp

**Fukuoka City****Hakata Port & Harbour Bureau**

13-13 Sekijo-Machi  
Hakatu-ku  
Fukuoka City  
812  
Japan  
Contact: Mr Teizo Ishibashi  
Job Title: Deputy Executive Director  
T: + 81 92 282 7111  
F: + 81 92 291 7144  
W: www.port-of-hakata.or.jp/english

**Hakodate****Hakodate Port and Airport**

**Department**  
4-13 Shinonome-cho  
City of Hakodate  
Hakodate  
Hokkaido  
040-8666  
Japan  
Contact: Ms Yoshie Yorozuya  
Job Title: Promotion Section  
Manager  
T: + 81 138 21 3488  
F: + 81 138 26 2656  
E: yorozuya.y@  
city.hakodate.hokkaido.jp  
W: www.city.hakodate.hokkaido.jp/  
harbour/  
The southern part of Hokkaido and  
the southern entrance of Hokkaido.  
1 Jib Crane and 1 reach stacker.  
Nishi(West) Pier:(-4)312m (-  
5)140m, (-9)165m, (-6.5)105m  
Bandai Pier:(-4)67m, (-5.5)90m(-  
7.5)130m, (-10)185m, (-5.5)90m(-  
7.5)130m  
Kita(North) Pier:(-5)130m, (-  
5.5)88m, (-7.5)130m, (-5.5)330m  
Chuo(Central) Pier:(-8)133m, (-

5.5)130m, (-5.5)90m(-9)165m(-  
9)165m  
Minato-cho Pier: (-14)280m, (-  
12)240m  
Minato-cho Pier: 1.5ha (1.84ha  
During December to June)  
Minato-cho Pier: 0.09ha  
Reefer plug 220V:2 440V:28  
Spare:12 Total 40

**Handa City****Port of Kinuura**

Kinuura Port Authority  
1-1. 11-Gochi  
Handa City  
Aichi Prefecture  
Japan  
T: + 81 569 21 2451  
F: + 81 569 21 2459  
E: kinuura-komu@pref.aichi.lg.jp  
W: www.pref.aichi.jp/kensetsu-  
somu/kinuura-komu/index.html

**Hiroshima****Fukuyama Port Authority**

Port Section of Hiroshima  
Prefecture  
Motomashi, 10-52 Naka-ku  
Hiroshima  
730  
Japan  
T: + 81 849 45 3238  
F: + 81 849 45 3442

**Hiroshima****Hiroshima Port Authority**

23-53 Ujina Kaigan  
2-chome, Minami-ku  
Hiroshima  
Japan  
Contact: Mr M Shimizu  
Job Title: Port Manager  
T: + 81 82 251 7117  
F: + 81 82 253 8250  
E: soukouhou@pref.hiroshima.lg.jp

**Hiroshima****Kure Port Authority**

1-6 Chou, 4-chome  
Kure City  
Hiroshima  
Japan  
Contact: Mr Hiroyuki Shindo  
T: + 81 823 25 3334  
F: + 81 823 25 1361  
E: kureport@alto.ocn.ne.jp

**Hiroshima****Port of Takehara No 1P/S**

3035-13 Nagahama  
Tadami-cho  
Takehara-shi  
Hiroshima  
729-23  
Japan  
Contact: Captain Yamada  
T: + 81 846 27 0211  
F: + 81 846 24 1506

**Hokkaido****Tomato Coal Center**

622 Aza-Hamaatsuma  
Atsuma-cho  
Hokkaido 059-17  
Japan  
Contact: Mr Masatoshi Machida  
T: + 81 1452 83121  
F: + 81 1452 83123

**Ibaraki****Hitachi Port Authority**

Hitachi City Office  
Kuji-Cho 1-3-21  
Ibaraki  
Japan  
T: + 81 294 524 000  
F: + 81 294 535 337  
E: kowan5@pref.ibaraki.jp  
W: www.pref.ibaraki.jp

**Iymishima City****Port of Mishima-Kawane**

Marine Safety Agency  
Mishima-Kawane Branch  
6-45 Kamiya-Cho  
Iymishima City  
Ehime Pref  
799-04  
Japan  
T: + 81 89 623 5267  
E: mtjm-i88s3@pa.skr.mlit.go.jp

**Kagoshima City****Pacific Grain Terminal**

4-20 Nanei  
Kagoshima City  
Japan  
Contact: Mr Shigeichi Koriyama  
Job Title: Senior MD  
T: + 81 99 268 8291  
F: + 81 99 269 5553

**Kagoshima City****Port of Kagoshima**

Kagoshima Port and Harbour  
Kagoshima Port Operation Office  
18-16 Izumi-cho  
Kagoshima City  
Kagoshima  
892-0822  
Japan  
Contact: Mr Taturou Suga  
Job Title: Governor  
T: + 81 225 956 271  
F: + 81 225 956 273  
E: kowan@pref.kagoshima.lg.jp  
W: www.pref.kagoshima.jp/  
home/kowanaka/  
cruise-net/english/01kagoshima

**Kakogawa City****Higashi-Harima Port Authority**

c/o Kakogawa Dabuku  
Public Works Office Tenjingi  
Jike-machi  
Kakogawa City  
Hyogo Pref  
Japan  
T: + 81 78 3417711  
F: + 81 78 3416477  
E: wss.kobe@wilhelmsen.com

**Kamisui-City****Kanto Grain Terminal Co. Ltd**

2-3 Higashi Fukushima  
Kamisui-City  
Ibaraki-ken  
314-0103  
Japan  
Contact: Mr H Omori  
T: + 81 299 92 6531  
F: + 81 299 92 6548  
E: h.oomori@kanto-grain.co.jp  
Kamisui-City, Japan.  
1x Pneumatic unloader - 400tph  
2x Mechanical unloader - 400tph  
Chain conveyors & bucket  
elevators 400tph loading into silo  
via 3 routes, 200tph loading out to  
feed factories and trucks via 8  
routes.  
3x Hoppers 5 Mt loading in  
9x 2.5 Mt loading out.  
Max length 280m, Max depth 13m,  
Max DWT 73,000 (Panamax)  
Site area 29,865sqm  
Concrete silo with steel plate lined  
and steel silo.  
135 bins, 176,881t for corn,  
sorghum, barley etc  
15 bins, 16,264t for soybean meal  
etc.

**Kanda-Machi****Kanda Port**

Kanda Port Administration Office  
29 Branch minato-machi  
Kanda-Machi  
Fukouka Pref  
Japan  
Contact: Mr K Yano

Job Title: General Manager  
T: + 8193 434 0585  
F: + 8193 436 2875  
E: kowan@pref.fukuoka.lg.jp

**Kasaoka City****Kasaoka Port**

Kasaoka Public Works Office  
2-5 Rokuban-cho  
Kasaoka City  
Okayama Pref  
Japan  
T: + 81 86 563 5252  
E: wss.kobe@wilhelmsen.com

**Kawasaki City****Port of Kawasaki**

Port & Harbour Bureau of Kawasaki  
1-Miyamoto-cho, Kawasaki-ku  
Kawasaki City  
210  
Japan  
T: + 81 44 200 2111  
F: + 81 44 222 0219  
E: 58yuuti@city.kawasaki.jp

**Kitakyushu City****Kitakyushu Port & Harbour Authority**

2-7 Nishi-Kaigan  
1-chome, Moji-ku  
Kitakyushu City  
Fukuoka Pref  
801-8555  
Japan  
Contact: Mr Tashiro  
Job Title: Marketing  
T: + 81 93 3215933  
F: + 81 93 3215915  
E: kqport@kitaqport.or.jp  
W: www.kitaqport.or.jp/

**Kitakyushu City****Port of Hibikinade**

c/o Kitakyushu Port and Harbour  
Bureau  
Nishi-Kaigan 1-2-7 Moji-ku  
Kitakyushu City  
Fukuoka Pref  
801  
Japan  
T: + 81 93 321 5941  
F: + 81 93 321 5933  
E: wss.tokyo@wilhelmsen.com

**Kitakyushu City****Port of Kokura**

c/o Kitakyushu Port & Harbour  
Bureau  
2-7 Nishi-Kaigan 1-chome Moji-ku  
Kitakyushu City  
Fukuoka Pref  
801  
Japan  
Contact: Mr Tashiro  
Job Title: Marketing  
T: + 81 93 321 5941  
F: + 81 93 321 5915  
E: kqport@kitaqport.or.jp

**Kitakyushu City****Port of Yawata**

Kitakyushu Port and Harbour  
Bureau  
2-7 Nishi-Kaigan 1-chome, Moji-ku  
Kitakyushu City  
Fukuoka Pref  
801  
Japan  
Contact: Ms Keiko Katsura  
Job Title: Marketing  
T: + 81 93 321 5941  
F: + 81 93 321 5933  
E: kqport@kitaqport.or.jp

**Kitakyushu City****Yawata Hibikinada**

Port/Harbour Bureau of Kitakyushu  
City  
2-7 Nishikaigan

1-Chrome  
moji-ku  
Kitakyushu City  
801  
Japan  
T: + 81 93 331 1331  
F: + 81 93 321 5915

## Kobe

**Port Authority of Himeji**  
Public Works Division  
Hyogo Prefecture  
5-10-1 Shimoyamate-dori  
Chu-ku  
Kobe  
Japan  
T: + 81 78 362 9274  
F: + 81 78 322 6120  
E: kouwanka@pref.hyogo.jp  
W: www.shikamakaiun.co.jp/he47.htm

## Kobe

**Port of Kobe**  
Port & Harbour Bureau  
5-1, 6-chome Kano-cho  
Chou-Ku  
Kobe  
650  
Japan  
Contact: Mr Noriyoshi Okaguchi  
Job Title: Director General  
T: + 81 78 331 8181  
F: + 81 78 322 6120  
E: info\_kobeport@office.city.kobe.lg.jp  
W: www.city.kobe.jp/cityoffice/  
39/port/index.htm  
The centre of Japan (Latitude 34  
38-43N, Longitude 35 5-18E)  
Total Berths 234  
Berths 225, 43,442m  
Dolphins 9 31  
107,835sqm  
273,936sqm

## Kochi City

**Port of Kochi**  
Kochi Maritime Safety Office  
5-4-55, Sanbashi -dori  
Kochi City  
780  
Japan  
Job Title: Port Manager  
T: + 81 888 239888  
F: + 81 888 372111  
E: 175201@ken.pref.kochi.lg.jp

## Komatsushima City

**Port of Tokushima**  
**Komatsushima**  
Komatsushima Port and Harbour  
Office  
37,Shinko, Komatsushima-cho  
Komatsushima City  
Tokushima Pref  
Japan  
T: + 81 88 621 2028  
E: koe@city.komatsushima.  
tokushima.jp

## Kurashiki City

**Mizushima Port Authority**  
1-12 Mizushima Fukuzaki-cho  
Kurashiki City  
Okayama  
712-8056  
Japan  
Contact: Mr Imoue  
Job Title: Director  
T: + 81 864 447141  
F: + 81 841 483010  
E: wss.kobe@wilhelmsen.com  
W: www.pref.okayama.jp/  
bichu/mizu/port.htm

## Kushiro City

**Kushiro Port Authority**  
Port & Harbour Department  
Kushiro Kowan Goda Chosha  
100-17 Shin Fujich  
Kushiro City  
Hokkaido

Japan  
T: + 81 154 533 373  
F: + 81 154 533 373  
E: ku210101@city.kushiro.hokkaido.jp  
W: www.city.kushiro.hokkaido.jp/  
kouwan/minato/

## Maizuru City

**Maizuru Port Authority**  
Maizuru Port Admin Office  
19-5 Koaza Shimazaki Aza  
Matsukage  
Maizuru City  
Japan  
T: + 81 773 75 7184  
F: + 81 773 75 7198  
E: m-port@mx.nkansai.ne.jp  
W: www5.nkansai.ne.jp/off/m-  
port/index\_e.htm

## Marugame City

**Port of Marugame**  
Marugame Harbour Office  
127-16 Fukushima-cho  
Marugame City  
Kagawa  
Japan  
T: + 81 877-23-7696

## Minatoku

**Niihama Coal Centre**  
Sumitomo Coal Mining  
204, 3-Chrome  
Nishi-Shimbashi  
Minatoku  
Tokyo  
Japan  
Contact: Mr Yoshitoyo Nakayama  
Job Title: Deputy General Manager  
T: + 81 3 5404 0410  
F: + 81 3 5404 0447

## Moji-ku Kitakyushu City

**Moji Port Authority**  
Port and Harbour Bureau  
2-7 Nishi-Kaigan  
Moji-ku Kitakyushu City  
Fukuoka Pref  
Japan  
Contact: Mr Tashiro  
Job Title: Head of International  
Affairs  
T: + 81 93 321 5941  
F: + 81 93 321 5933  
E: wss.moji@wilhelmsen.com  
W: www.japanwelcomesyou.com/  
cssweb/ports/port/html/  
kitakyushu.html

## Moji-ku Kitakyushu City

**Port of Tobata**  
c/o Kitakyushu Port Bureau  
2-7 Nishikaigan, 1-chome,  
Moji-ku Kitakyushu City  
Fukuoka Pref 801  
Japan  
Contact: Mr Hiroyuki Tagami  
T: + 81 93 321 5941  
F: + 81 93 321 5915  
E: hiroyuki\_tagami01@  
city.kitakyushu.lg.jp  
W: www.kitaqport.or.jp

## Morioka

**Port of Kamaishi**  
Port and Harbour Department  
10-1 Uchimaruru  
Morioka  
Iwate Pref  
020  
Japan  
T: + 81 19 629 5912  
F: + 81 193 243962  
E: AG0010@pref.iwate.jp

## Morioka

**Port of Ofunato**  
Port & Harbour Section of Iwate  
Prefecture  
10-1 Uchimaruru

Morioka  
Iwate-Pref  
020  
Japan  
Contact: Mr H Kimura  
T: + 81 192 273111  
F: + 81 196 515 604  
E: wss.tokyo@wilhelmsen.com

## Mubanti

**Shukuzu Coal Centre**  
Koowan-Bu  
Hokkaido Muroran-shi  
Kaigan-Choo  
1-Chrome  
Mubanti  
Japan  
Contact: Mr T Nakamura  
Job Title: Manager  
T: + 81 143 244466  
F: + 81 143 240011

## Muroran City

**Muroran Port Authority**  
20-30 Kaigan-cho  
1-chome  
Muroran City  
Hokkaido Province  
Japan  
Contact: Mr Asei Sakata  
T: + 81 143 22 3191  
F: + 81 143 22 6069  
E: oport@city.muroran.hokkaido.jp  
W: www.city.muroran.hokkaido.jp

## Nagasaki City

**Port of Matsushima**  
Matsushima Port Authority  
Port and Harbour Section  
2-13 Edo-Machi  
Nagasaki City  
850  
Japan  
T: + 81 95 824 1111

## Nagoya

**Gamagori Port Authority**  
c/o Port and Harbour Section of  
Aichi Prefecture,  
3-1-2 Sannomaru  
Naka-Ku  
Nagoya  
460-01  
Japan  
T: + 81 52 654 7840  
F: + 81 52 650 7995

## Niigata City

**Port of Niigata**  
Bureau of Port and Airport  
Development  
Niigata Prefecture  
4-1 Shinko-cho  
Niigata City  
Niigata  
950-8570  
Japan  
Contact: Mr T Sugimoto  
T: + 81 0 25 280 5456  
F: + 81 25 284 5042  
E: T1700102@mail.pref.niigata.jp  
W: Port of Niigata

## Niihama City

**Port of Niihama**  
5-1 Ikku-cho  
1 chome  
Niihama City  
Ehime Pref  
792-0025  
Japan  
T: + 81 897 33 5151  
F: + 81 897 324 515  
E: wss.kobe@wilhelmsen.com

## Oita City

**Port of Oita**  
Oita Port Authority  
Shin Sangyotoshi Kaihatsu Kyoku  
3-33 Mukaibaru

Oita City  
Nishi 1-chome Oita Pref  
Japan  
T: + 81 97 558 5111  
F: + 81 97 553 0655  
W:  
www.pref.oita.jp/14300/faz/faz1/englis  
h/faz\_en.html

## Osaka City

**Port of Osaka**  
Osaka Port and Harbors Bureau  
WTC Bldg 41F  
1-14-16 Nanko-Kita  
Suminoe-ku  
Osaka City  
559-0034  
Japan  
Contact: Mr Tadashi Ito  
Job Title: Manager, Port Promotion  
T: + 81 6 6615 7764  
F: + 81 6 6615 7769  
E: na0004@city.osaka.lg.jp  
W: www.city.osaka.jp/port

## Otaru City

**Port of Otaru**  
Otaru Port Authority  
4-2 Minato-Machi  
Otaru City  
Hokkaido Pref  
Japan  
T: + 81 134 23 1109  
E: kowan@city.otaru.hokkaido.jp  
W: www.city.otaru.hokkaido.jp/  
minato/mina\_s.htm

## Sakaide City

**Sakaide Port Administration**  
5-32 Irifune-cho  
1-chome  
Sakaide City  
Kagawa Pref  
Japan  
T: + 81 877 46 2518  
E: kouwan1@city.sakaide.lg.jp

## Sakaide City

**Sakaide Port Administration**  
5-32 Irifune-cho, 1-chome  
Sakaide City  
Kagawa Pref  
Japan  
T: + 81 877 462 518  
F: + 81 877 464056

## Sasebo City

**Port of Sasebo**  
Port and Harbour Bureau  
3-5 Yorozu-cho  
Sasebo City  
Nagasaki Pref  
Japan  
T: + 81 956 226128  
F: + 81 956 226149

## Schimonoseki City

**Schimonoseki Port & Harbour  
Bureau**  
Schimonoseki City Government  
Nabe-cho  
1-1  
Schimonoseki City  
Yamaguchi Pref  
Japan  
Contact: Mr Toshihiko Nakano  
Job Title: Director General  
T: + 81 832 31 1111  
F: + 81 832 33 0860  
E: webmaster@schimonoseki-port.com  
W: www.schimonoseki-port.com

## Sendai

**Port of Ishinomaki**  
Ports & Harbors Promotion Division  
Public Works Department  
Miyagi Prefectural Government  
Aoba-ku  
Sendai  
Miyagi Pref.

980-8570  
Japan  
Contact: Mr Kimio Doi  
Job Title: Chairman  
T: + 81 22 211 3221  
F: + 81 225 956 273  
E: kousin@pref.miyagi.jp  
W: www.port-ishinomaki.jp

## Shibushi-shi

**Port of Shibushi**  
Shibushi Port Administrative Office  
6617-17 Cho Shibushi-cho,  
Shibushi-shi  
Kagoshima Pref  
899-7102  
Japan  
T: + 81 994 73 1651  
F: + 81 994 73 1671  
E: shibushi-  
minato@pref.kagoshima.lg.jp  
W: www.pref.kagoshima.jp/  
infra/port/minato/shibushi/index.html

## Shizuoka City

**Port Authority of Shimizu**  
9-25 Hinode-cho  
Shimizu-ku  
Shizuoka City  
Shizuoka Prefecture  
424-0922  
Japan  
Contact: Mr Aritsuka Kobayashi  
Job Title: Planning & Development  
Manager  
T: + 81 543 53 2203  
F: + 81 543 54 0380  
E: port@mail.wbs.ne.jp  
W: www.portofshimizu.com  
35 01 N  
138 32 E  
Grain,Cement,LNG,Oil,etc.  
335,901 sqm  
62,947 sqm  
Shimizu is the mail port of Shizuoka  
prefecture.The total container  
volume of Shimizu is 518,742 TEU  
in 2004 (7th in Japan). Shimizu  
open 24 hours a day.

## Shizuoka City

**Port of Tagonoura**  
Port Administrative Office  
2-1 Suzukawa-cho  
Fuji Shi  
Shizuoka City  
417  
Japan  
Contact: Mr Kyusaku Sato  
Job Title: Master of Tagonoura Port  
Office  
T: + 81 5 433 0495  
F: + 81 5 433 1009

## Takamtsu City

**Naoshima Port Authority**  
Port & Harbour Department  
1-10 Bancho 4-chome  
Takamtsu City  
Kagawa Pref  
Japan  
T: + 81 87 831 1111  
E: wss.tokyo@wilhelmsen.com

## Tokuyama City

**Tokuyama Port Authority**  
13-23 Chikko-cho  
Tokuyama City  
Yamaguchi Pref  
745-0025  
Japan  
Contact: Mr Hidoshi Onishi  
Job Title: Port Manager  
T: + 81 834 211787  
F: + 81 834 325090

## Tokuyama City

**Tonda Port Authority**  
c/o Shunan Port Admin Office  
13-23 Chikko-cho  
Tokuyama City



Yamaguchi Pref  
Japan  
Contact: Mr Masaru Kaneno  
Job Title: Port Manager  
T: + 81 834 211787  
F: + 81 834 325090

**Tokyo**

**Tokyo Metropolitan Government**  
Bureau of Port and Harbour 8-1  
Nishi-Shinjuku 2-chome,  
Shinjuku-ku  
Tokyo  
163-8001  
Japan  
Contact: Ms Toshiko Seki  
T: + 81 3 5320 5549  
F: + 81 3 5388 1576  
E: S0000517@section.metro.tokyo.jp  
W: www.kouwan.metro.tokyo.jp  
The port is on the north-western  
part of the Tokyo Bay. It is located  
in the area between the estuaries  
of the Arakawa and Tamagawa  
Rivers.  
Breakwater Length : 8,781m  
Mooring Facilities :  
-Wharves and Piers : 23,059m  
205 berths (incl. 4,479m, 15 berths  
for  
container)  
-Buoys : 3 2 berths  
-Dolphins : 31 19 berths  
-Landing Stage : 2,094m  
Timber Basins : 999,213 sqm 6  
berths  
Bulk Cargo Terminal : 1 berth,  
240m, -12m Oi Construction-  
Materials Terminal : 4 berths, 280m,  
-5m Oi Food Stuff Terminal : 3  
berths, 610m, -12m/-11m  
Shinagawa Terminal(Domestic) : 5  
berths, 856m, -8m Shibaura  
Terminal : 7 berths, 870m, -7.5m/ -  
5.5m  
Open-air Storage Yards (public) :  
1,010,595 sqm  
Transit Sheds (public) : 209,487  
sqm

**Tomakomai City**

**Tomakomai Port Authority**  
6-38, Minato-Machi 1-chome  
Tomakomai City  
Hokkaido  
053-0004  
Japan  
Contact: Mr Junichi Suzuki  
Job Title: Executive Vice President  
T: + 81 144 345551  
F: + 81 144 345559  
E: t-masuda@jptmk.com  
W: www.jptmk.com

**Toyama City**

**Toyama Port Authority**  
Administration Office  
5 Kaigan-dori  
Higashi Iwase,  
Toyama City  
Toyama  
931-8358  
Japan  
Contact: Mr K Yamaguchi  
T: + 81 764 377 131  
F: + 81 764 419 050

**Toyama City**

**Toyama-Shinko Public Berths**  
Fushiki Kairiku Unso  
Toyamashinko Branch  
4-2 Nagonoe  
Shinminato-shi  
Toyama City  
Japan  
T: + 81 766 82 1118  
F: + 81 766 84 3335

**Tsuruga City**

**Tsuruga Port Authority**  
2-1 Sakura-machi

Tsuruga City  
Fukui Pref  
Japan  
T: + 81 776 20 0489  
E: kowan@pref.fukui.lg.jp

**Ube City**

**Port of Ube, Okinoyama Coal Terminal**  
12-32 Nishihon-machi  
1-Chrome  
Ube City  
Yamaguchi Pref  
Japan  
Contact: Mr Masayoshi Wanishi  
Job Title: General Manager  
T: + 81 335 31 5971  
F: + 81 838 31 5885

**Usui City**

**Tsukumi Port Authority**  
Usuki Doboku Office  
72-254 Aza Susaki, Oaza Usaki  
Usui City  
Oita Pref 875-0041  
Japan  
T: + 81 972 634136

**Wakayama City**

**Smikin Transport Service**  
1850 Minato  
Wakayama City  
Hokkaido Pref  
Japan  
Contact: Mr Tutomu Oonishi  
T: + 81 734 51 5168  
F: + 81 734 51 5150

**Wakayama City**

**Wakayama Port Authority**  
Wakayama Shimotsu Admin Office  
22 Chikko 6- chome  
Wakayama City  
Hokkaido Pref  
Japan  
T: + 81 734 413154  
F: + 81 734 334839

**Yatsushiro City**

**Yatsushiro Port Office**  
249 Minato-machi  
Yatsushiro City  
Kumamoto Pref  
Japan  
Job Title: Port Office  
Superintendent  
T: + 81 96 333 2514  
E: kouwan@pref.kumamoto.lg.jp

**Yokohama**

**Port of Yokohama**  
Port and Harbour Bureau  
5F Sangyo-Boeki Center Boulevard  
2  
Yamashita-cho, Naka-ku  
Yokohama  
231-0023  
Japan  
Contact: Mr Kazuhiko Watanabe  
Job Title: Port Promotion Director  
T: + 81 45 671 7188  
F: + 81 45 671 7310  
E: portoubo@city.yokohama.jp  
W: www.city.yokohama.jp/me/port

**JERSEY**

**St Hellier**

**Induvac**  
Belrespiro  
La Route des Petits Camps  
St Hellier  
JE2 4JN  
Jersey  
Contact: Mr Ian Miller  
T: + 44 1534 767623  
F: + 44 1534 874088  
E: belrespiro@aol.com

**JORDAN**

**Aqaba**

**The Ports Corporation Aqaba**  
Port Corps of Aqaba  
PO Box 115  
Aqaba  
77110  
Jordan  
Contact: Mr Awwad Maytah  
Job Title: Director General  
T: + 962 3 201 4042  
F: + 962 3 201 6204  
E: info@aqabaports.gov.jo  
W: www.adc.jo

**KENYA**

**Mombasa**

**Grain Bulk Handlers Ltd**  
Grain House  
Beira Road  
Shimanzi  
PO Box 80469  
Mombasa  
Coast  
80100  
Kenya  
Contact: Mr Mujtaba Jaffer  
Job Title: CEO  
T: + 254 7030 17000  
F: + 254 7030 17444  
E: gbh@grainbulk.com  
W: www.grainbulk.com

**Mombasa**

**Kenya Ports Authority**  
PO Box 95009  
Mombasa  
Kenya  
Contact: Capt Twalib Khamis  
Job Title: General Manager -  
Operations  
T: + 254 41 312 211  
F: + 254 41 311 867  
E: tkhamis@kpa.co.ke  
W: www.kenya-ports.com  
East Africa on the Indian Ocean  
-Travelling Cranes - nos. 30, 5 - 20  
tonne  
-Portal electric fixed cranes - nos.  
3, - 3 tonne  
-Electric overhead travelling cranes  
- nos. 3, 2 - 10 tonne  
-Under hung jib - nos. 4, 1.5 tonne  
-Forklift trucks -nos. 50, 3 - 16  
tonne  
-Mobile cranes - nos. 13, 5 - 43  
tonne  
-Grain Bulk Handlers Ltd - Berth No  
- 3, Total Length (m) 166.4, Draft  
10, 2 Ship unloaders - 600 tonnes  
per hour  
-Magadi Soda Ltd - Berth No 9,  
Total length (m) 179.8, Draft 10.4, 1  
payloader  
-Mbaraki 1-Total length(m) 153,  
Draft 10.4 - 10.97  
-Mbaraki 2 -Total length(m) 153,  
Draft 10.4 - 10.97  
- Berth 11- Total length(m) 173.1,  
Draft 10.4 - 9.75  
- Berth 12, Total length(m) 166.4,  
Draft 10.4 - 9.75  
114,117 sqm  
132,781 sqm

**Mombasa**

**Port of Mombasa**  
Kenya Port Authority  
PO Box 95009  
Mombasa  
Kenya  
Contact: Mr Brown M. Ondego  
Job Title: Managing Director  
T: + 254 11 312211  
F: + 254 11 311867  
E: micd@kpa.co.ke

**KIRIBATI**

**Betio**

**Kiribati Ports Authority**  
PO Box 506  
Betio  
Tarawa  
Kiribati  
Contact: Mrs Rubee Eromanga  
T: + 686 25147  
F: + 686 26164  
E: kpa@tskl.net.ki

**KOREA**

**Gwang Yang-City**

**Posco Terminal Co., Ltd**  
Gwang Yang CTS Yard, 861  
Geumbo-dong  
Gwang Yang-City  
Jeonam  
Korea  
Contact: Mr Woo Sun-Moon  
Job Title: CEO  
T: + 82 61 793 7412  
F: + 82 61 790 6386  
E: info@poscoterminal.com  
W: www.poscoterminal.co.kr

**KUWAIT**

**Safat**

**Shuaiba Port**  
Kuwait Ports Authority  
PO Box 3874  
Safat 13039  
Capital of Latvia (Middle Latvia)  
Equipment Quant.  
Capacity  
Portal cranes 29 up to  
40t  
Caterpillar cranes 3 up to  
21t  
Forklifts 65 up to  
10t  
Forklifts 8 10t-  
25t  
Reach stacker 1 up to  
45t  
Tug masters 5 up to  
80t  
Scoop tractors 14 up to  
7,5m3  
Wagon tractors 9 40 t  
Locomotives 3 60  
wagons  
Berth / Length / Draught  
EO-7 / 190 / 9.5  
EO-9 / 130 / 6.6  
EO-10 / 150 / 7.0  
EO-11 / 140 / 7.2  
EO-12 / 159 / 7.0  
EO-14 / 210 / 11.7  
EO-15 / 212 / 11.7  
PM-16 / 145 / 9.5  
PM-17 / 145 / 9.5  
158,000 sqm  
59,800 sqm  
Total terminal area: 67.6 ha.  
Max vessel: length 225m; DWT  
76000t.  
Railway access roads: 19.5 km,  
Operative capacity for 400 wagons.

**Safat**

**Shuwaikh Port**  
c/o Kuwait Port Authority  
PO Box 3874  
Safat  
13039  
Kuwait  
Contact: Mr Alia Salem Al-Saba  
Job Title: Director General  
T: + 965 481 2622  
F: + 965 481 9714  
E: isaship@qualitynet.net  
W: www.isakwi.com/

**LATVIA**

**Liepaja**

**Liepaja Port Authority**  
4 Feniksa Street  
Liepaja  
34Z01  
Latvia  
Contact: Mr I Boja  
Job Title: Port Director  
T: + 371 34 29605  
F: + 371 34 80252  
E: port@sez.lv  
W: www.liepaja-sez.lv

**Liepaja**

**Liepaja Special Economic Zone Authority SEZ**  
4 Feniksa Street  
Liepaja  
3401  
Latvia  
Contact: Mr Aivers Boja  
Job Title: Port General Manager  
T: + 371 6 34 27605  
F: + 371 34 80252  
E: authority@sez.lv

W: www.liepaja.lv

**Riga**

**Freeport of Riga Authority**  
12 Kalpaka Boulevard  
Riga  
LV 1010  
Latvia  
Contact: Mr Leonids Loginovs  
Job Title: Chief Executive Officer  
T: + 371 6703 0800  
F: + 371 6703 0835  
E: info@freeporofriga.lv  
W: www.freeporofriga.lv/  
South-East of the Baltic Sea at the  
Riga Bay  
4 Container re-loaders, 30.5t  
15 Mobile cranes, 5 - 100t  
100 Cranes, 5 - 40t  
300 Forklifts, 1.5 - 25t  
Number of bulk berths: 52  
max length: 250 m  
max draft: 12.2 m  
1,797,000 sqm  
180,000 sqm

**Riga**

**Riga Central Terminal, LLC**  
15 k-1 Eksporta Street  
Riga  
LV-1045  
Latvia  
Contact: Ms Kristine Vizule  
Job Title: Marketing and PR  
Manager  
T: + 371 673 29816  
F: + 371 673 26501  
E: Kristine.vizule@rto.lv  
W: www.rto.lv  
Capital of Latvia (Middle Latvia)  
Equipment Quant.  
Capacity  
Portal cranes 29 up to  
40t  
Caterpillar cranes 3 up to  
21t  
Forklifts 65 up to  
10t  
Forklifts 8 10t-  
25t  
Reach stacker 1 up to  
45t  
Tug masters 5 up to  
80t  
Scoop tractors 14 up to  
7,5m3  
Wagon tractors 9 40 t  
Locomotives 3 60  
wagons  
Berth / Length / Draught  
EO-7 / 190 / 9.5  
EO-9 / 130 / 6.6  
EO-10 / 150 / 7.0  
EO-11 / 140 / 7.2  
EO-12 / 159 / 7.0  
EO-14 / 210 / 11.7  
EO-15 / 212 / 11.7  
PM-16 / 145 / 9.5  
PM-17 / 145 / 9.5  
158,000 sqm  
59,800 sqm  
Total terminal area: 67.6 ha.  
Max vessel: length 225m; DWT  
76000t.  
Railway access roads: 19.5 km,  
Operative capacity for 400 wagons.

**Riga**

**WT Terminal Ltd**  
Flotes Street 3a  
Riga  
LV-1016  
Latvia  
Contact: Mr Janis Lapins  
T: + 371 6780 6018  
F: + 371 6744 3001  
E: janis.lapins@wt-terminal.lv  
W: www.wt-terminal.lv  
In Freeport of Riga, Latvia  
3 cranes and 8 forklifts.  
500,000m3/tonnes/year  
350m, 5.5m draught

**Riga**

**WT Terminal Ltd**  
Flotes Street 3a  
Riga  
LV-1016  
Latvia  
Contact: Mr Janis Lapins  
T: + 371 6780 6018  
F: + 371 6744 3001  
E: janis.lapins@wt-terminal.lv  
W: www.wt-terminal.lv  
In Freeport of Riga, Latvia  
3 cranes and 8 forklifts.  
500,000m3/tonnes/year  
350m, 5.5m draught

95,000sqm  
9,000sqm

The terminal handles cargoes to/from vessels, trucks, railways wagons. The Terminal is able to store and transship several types of bulk & general cargoes. Terminal is fully ISPS - compliant. Our customers enjoy on-line stock control.

## Ventspils

**AS Ventspils Tirdzniecības Osta**  
22 Dzintaru Street  
Ventspils  
LV3602  
Latvia  
Contact: Ms Julianna Svendenko  
Job Title: Secretary  
T: +371 63668706  
F: +371 36 68870  
E: Julianna.Svendenko@vto.lv  
W: <http://www.vto.lv>

## Ventspils

**Free Port of Ventspils Authority**  
19 Jāņa Str.  
Ventspils  
LV 3601  
Latvia  
Contact: Mr Imants Sarmulis  
T: +371 6 362 2586  
F: +371 6 362 1297  
E: [marketing@portofventspils.lv](mailto:marketing@portofventspils.lv)  
W: [www.portofventspils.lv](http://www.portofventspils.lv)  
East coast of the Baltic Sea, West coast of Latvia, on the coasts of the river Venta.

A deepwater port with opportunities to accommodate Aframax type vessels for liquid cargoes and Panamax type vessels for dry bulk and general cargoes.

Max draught up to 15m.  
Dry bulk terminals are Kalija parks (transshipment of mineral fertilizers); Ventspils Commercial Port (transshipment of metals, coal, ferro-alloys, grain, raw sugar); grain transshipment terminal Ventspils Grain Terminal and closed storage coal terminal Baltic Coal Terminal.

## Ventspils

**JSC BALTIC COAL TERMINAL**  
39B Dzintaru Street  
Ventspils  
LV-3602  
Latvia  
Contact: Mr Ilya Sokolov  
Job Title: Chairman of the Board  
T: +371 636 34 000  
F: +371 636 34 001  
E: [info@balticcoal.com](mailto:info@balticcoal.com)  
W: [www.balticcoal.com](http://www.balticcoal.com)  
Latvia, Ventspils, The Baltic Sea  
Throughput capacity - 6 mln tons coal per year  
For ships up to 120,000dwt  
N/A  
Warehouse 24,000 sqm with storage up to 210,000 tonnes of coal.

Terminal uses modern coal transshipment technologies and has covered warehouse as well conveyor galleries to prevent environmental pollution. The deepwater pier depth is 16.0m and length 350m.

## Ventspils

**Kalija Parks**  
20a Dzintaru iela  
Ventspils  
3602  
Latvia  
Contact: Mr Dainis Treimanis  
Job Title: Member of the Board  
T: +371 636 07232  
F: +371 3625345  
E: [director@kp.vcp.lv](mailto:director@kp.vcp.lv)

W: [www.ventspils.lv](http://www.ventspils.lv)

## Ventspils

**Ventspils Grain Terminal**  
41 Dzintaru Street  
Ventspils  
LV 3602  
Latvia  
Contact: Mr Vladislavs Safranskis  
Job Title: Board Chairman  
T: +371 6 366 8802  
F: +371 366 8850  
E: [vgt@vgt.lv](mailto:vgt@vgt.lv)  
W: [www.vgt.lv](http://www.vgt.lv)

## LEBANON

### Beirut

**Chekaa Bay**  
c/o Port of Beirut  
PO Box 1490  
Beirut  
Lebanon  
Contact: Mr J Khazen  
Job Title: Port Director  
T: +961 1 580211  
F: +961 1 585835  
E: [info@portdebeyrouth.com](mailto:info@portdebeyrouth.com)  
W: [www.portdebeyrouth.com](http://www.portdebeyrouth.com)

### Beirut

**Port Authority of Selaata**  
c/o Port of Beirut  
PO Box 1490  
Beirut  
Lebanon  
Contact: Mr J Khazen  
Job Title: Port Director  
T: +961 1 601602  
F: +961 1 601602

### Tripoli

**Tripoli Port Authority**  
Service d'Exploitation du Port de Tripoli  
Tripoli  
Lebanon  
Contact: Mr Ahmad Taner  
Job Title: Manager  
T: +9616211775 / +9616600413  
F: +96 16220180  
E: [admin@portdetripoli.com](mailto:admin@portdetripoli.com)  
W: [www.tripoliport.com/](http://www.tripoliport.com/)

## LIBERIA

### Monrovia

**Monrovia Port**  
National Port Authority  
PO Box 10-18-49  
Monrovia  
1000  
Liberia  
Contact: Ms Elsie Dossen Bodio  
Job Title: President  
T: +231 221332  
F: +231 226388  
E: [natport@liberia.net](mailto:natport@liberia.net)

### Monrovia

**National Port Authority**  
Bushrod Island  
PO Box 1849  
Monrovia  
Liberia  
Contact: Mr Fassue Kellah  
Job Title: Managing Director  
T: +231 221332  
F: +231 226388  
E: [natport@liberia.net](mailto:natport@liberia.net)

### Robertsfield

**Buchanan Port Authority**  
Lamco JV Venture Operating Co  
c/o Roberts International AirPort  
Robertsfield  
Liberia  
Contact: Mr D Uittenbogaard

Job Title: Chief Agent  
T: +231 221332  
F: +231 226388  
E: [natport@liberia.net](mailto:natport@liberia.net)

## LITHUANIA

### Klaipeda

**BEGA, Stevedoring Company**  
Nemuno st. 2B  
Klaipeda  
LT - 91199  
Lithuania  
Contact: Mr Aloyzas Kuzmarskis  
Job Title: General Manager  
T: +370 46 395 500  
F: +370 46 380 384  
E: [bega@bega.lt](mailto:bega@bega.lt)  
W: [www.bega.lt](http://www.bega.lt)  
South-eastern coast of Baltic Sea; a good geographical location of the ice-free port of Klaipeda on the East-West trade route.  
6 million tonnes of cargo a year.  
Mobile ship loaders (up to 1500 tph), cranes (120 tons), covered/uncovered rail wagons loading stations (up to 50 rail cars at a time), own trucks and locomotives etc.  
Max length - 2km; Max draught - 13m  
300,000sqm  
525,000 tonnes  
Specialization: dry and liquid fertilizers, agribulks; minerals, cement, soda ash etc.  
Additional services: bulk packing, cargo forwarding, ships agency

### Klaipeda

**Joint-Stock Stevedoring Company**  
Klaipedos Smelte  
Nemuno Street 24  
Klaipeda  
5804  
Lithuania  
Contact: Mr Eduardoš Gawushkinas  
Job Title: General Manager  
T: +370 46 496306  
F: +370 46 496246  
E: [info@smelde.lt](mailto:info@smelde.lt)

### Klaipeda

**Klaipeda Stevedoring Company (KLASCO)**  
Zauvernio Street 18  
Klaipeda  
LT-92122  
Lithuania  
Contact: Mr Vidas Kuklierius  
Job Title: Senior Manager  
T: +370 46 399031  
F: +370 46 39 9235  
E: [vidas@klasco.lt](mailto:vidas@klasco.lt)  
W: [www.klasco.lt](http://www.klasco.lt)  
Lithuania, South East Coast of the Baltic Sea  
Into the vessel up to 1,500 mtp, from railcars - up to 800 mtp  
Berth length - 220m - depth - 14m  
For bulk products - 180,000 mt

### Klaipeda

**State Enterprise Klaipėda State Seaport Authority**  
J Janonio st. 24  
Klaipeda  
LT-92251  
Lithuania  
Contact: Mr Arturas Drungilas  
Job Title: Director for Marketing  
T: +370 46 499 748  
F: +370 46 499777  
E: [a.drungilas@port.lt](mailto:a.drungilas@port.lt)  
W: [www.portofklaipeda.lt](http://www.portofklaipeda.lt)  
Northernmost port on the Eastern coast of Baltic Sea.  
Mobile loaders, wheeled loaders,

cranes, warehouses.  
21 berths for bulk cargo  
780,300sqm  
368,000sqm

## Klaipeda

**Vakaru krova, UAB**  
Minijos g. 180  
Klaipeda  
LT-93269  
Lithuania  
Contact: Mr Nerijus Gričius  
Job Title: Director  
T: +370 46 483 883  
F: +370 46 483 884  
E: [nerijus.gricius@wsy.lt](mailto:nerijus.gricius@wsy.lt)  
W: [www.wsy.lt](http://www.wsy.lt)

## LUXEMBOURG

### Luxembourg

**Euroports Holdings S.a.r.l.**  
4th floor  
6, rue Jean Monnet  
Luxembourg  
Luxembourg  
L-2180  
Luxembourg  
Contact: Mr Richard Jennings  
Job Title: Chief Commercial Officer  
T: +352 621 555 866  
F: +352 26 75 41 05  
E: [Richard.jennings@euroports.com](mailto:Richard.jennings@euroports.com)  
W: [www.euroports.com](http://www.euroports.com)

## MADAGASCAR

### Toamasina

**Societe d'Exploitation du Port de Toamasina**  
PO Box 492  
Toamasina  
501  
Madagascar  
Contact: Mr Pierre Marolahy  
Job Title: General Manager  
T: +261 5 32155  
F: +261 5 335 58  
E: [sept@dts.mg](mailto:sept@dts.mg)

## MALAYSIA

### Butterworth

**Penang Port SDN BHD**  
SBU Cargo Services  
Administration Building  
Butterworth  
Penang  
12100  
Malaysia  
Contact: Mr Haji Abdul Rahim Abu Bakar  
Job Title: General Manager  
T: +60 4 3102200  
F: +60 4 3324414  
E: [Rahim@penangport.com.my](mailto:Rahim@penangport.com.my)  
W: [www.pgport.com.my](http://www.pgport.com.my)

### Johor

**Bulk & Breakbulk Terminal**  
Johor Port Berhad  
PO Box 151  
Wisma Kontena  
Pasir Gudang  
Johor  
81707  
Malaysia  
Contact: Captain Mohd. Slim Mohd. Din  
Job Title: Head of Bulk and Break Bulk  
T: +60 7253 5888  
F: +60 7251 0980  
E: [jpjb@johorport.com.my](mailto:jpjb@johorport.com.my)  
W: [www.johorport.com.my](http://www.johorport.com.my)

## Johor Baharu

**Johor Port BERHAD**  
PO Box 151  
Wisma Kontena  
Pasir Gudang  
Johor Baharu  
81707  
Malaysia  
Contact: Mr Ahmed Kamal  
Job Title: Head, Corporate Communications  
T: +60 7 253 5888  
F: +60 7 251 0980  
E: [akamal@johorport.com.my](mailto:akamal@johorport.com.my)  
W: [www.johorport.com.my](http://www.johorport.com.my)  
Eastern side of the southern tip of Peninsular Malaysia  
Bulk/Break Bulk: 2 Gantry Cranes, 2 Level-Luffing Cranes, Continuous Chain Unloader, 2 Dedicated Conveyors (1000 tonnes/hour), Shore Cranes at up to 300 tonne capacity.  
Breakbulk:

Berth Lighterage: 60m length, 6.0m depth, 6,500DWT displacement  
Berth W1: 110m length, 6.0m depth, 26,000DWT displacement  
Berth W2: 183m length, 11.0m depth, 39,000DWT displacement  
Berth W3: 183m length, 11.0m depth, 39,000DWT displacement  
Berth W4: 192m length, 12.7m depth, 78,000DWT displacement  
Berth W5: 217m length, 12.9m depth, 78,000DWT displacement  
Berth W6: 214m length, 13.0m depth, 78,000DWT displacement  
Multipurpose (Break Bulk, Dry Bulk & Container Cargo):  
Berth W7: 195m length, 13.5m depth, 80,000DWT displacement  
Berth W8: 195m length, 13.5m depth, 80,000DWT displacement  
Berth W9: 195m length, 13.5m depth, 80,000DWT displacement  
Berth W10: 195m length, 13.5m depth, 80,000DWT displacement  
Berth W11S: 230m length, 11.0m depth, 13,000DWT displacement  
Berth W11N: 120m length, 5.0m depth, 13,000DWT displacement  
Approximately 80,000 sqm  
Approximately 164,000 sqm  
JPB is listed on the London Metal Exchange for storage and handling of seven (7) non-ferrous metals: primary aluminium, aluminium alloy, lead, zinc, copper, nickel and tin.  
JPB runs its own Free Zone, which also has a rail depot.

## Kota Kinabalu

**Sabah Ports Authority**  
Locked Bag No 2005  
Kota Kinabalu  
Sabah  
88617  
Malaysia  
Contact: Datuk Mayong Omar  
Job Title: General Manager  
T: +60 88 538400  
F: +60 88 223036  
E: [sabport@po.jaring.my](mailto:sabport@po.jaring.my)  
W: [www.lpps.sabah.gov.my](http://www.lpps.sabah.gov.my)  
East & West and North of Sabah  
2,800 sqm -26,800 sqm  
Dry bulk cargo is currently handled using grabs and hoppers provided by the cargo owners/agents.

## Kuantan

**Kuantan Port Authority**  
KM 25, Jalan Kuantan-Kemaman  
Tanjung Gelang  
P.O. Box 161  
Kuantan  
25720  
Malaysia  
Contact: Mr Khairul Anuar Abdul Rahman  
Job Title: Chief Executive



Officer/General Manager  
T: + 60 9585 8000  
F: + 60 9585 8000  
E: lpktn@lpktn.gov.my

**Kuantan**

**Kuantan Port Consortium Sdn Bhd**  
Wisma  
PO Box 199  
Tanjung Gelang  
Kuantan  
Pahang  
25720  
Malaysia  
Contact: Mr Haji Khasbullah Bin A. Kadir

Job Title: Chief Operating Officer  
T: + 60 9 586 3888  
F: + 60 9 583 9393  
E: irpkho.kuantanport@ijm.com  
W: www.ijm.com/infrastructure/port/KuantanPort/  
East of Malaysia  
Grab Unloader  
Two - 400m  
30,000 sqm  
10,000 sqm  
Port Terminal handling fertilizers, mineral ores, coal, gypsum etc

**Kuantan**

**Lembaga Pelabuhan Kuantan**  
Tanjung Gelang  
Peti Surat 161  
Kuantan  
Pahang Darul Maknur  
25720  
Malaysia  
Contact: Mr Mohamad Iramhan  
T: + 60 9 585 8000  
F: + 60 9 583 3866  
E: lpktn@lpktn.gov.my  
W: www.lpkn.gov.my

**Labuan**

**Labuan Port Authority**  
W-2 Liberty Port Storage Area  
P.O. Box 81858  
Labuan  
87028  
Malaysia  
Contact: Mr C Simon  
Job Title: Port Manager  
T: + 60 87 421699  
F: + 60 87 421850  
E: labuanport@lpm.com.my  
W: www.lpm.com.my

**Malacca**

**Malacca Port Authority**  
Pelabuhan Tangjung Bruas  
Tanjung Kling  
Malacca  
76400  
Malaysia  
Contact: Mr Chua Yew Ling  
Job Title: Port Manager  
T: + 60 6 351 1766  
F: + 60 6 351 1216  
E: arum@portsworld.com

**Miri**

**Miri Port Authority**  
Jalan Miri Port  
Kuala Baram Industrial Estate  
Kuala Baram  
PO Box 1179, 98008 Miri, Sarawak  
Miri  
Sarawak  
98000  
Malaysia  
Contact: Madam Serawa Budol  
Job Title: Manager, Business Development Services  
T: + 60 85 609 031  
F: + 60 8 560 4841  
E: serawab@miriport.gov.my  
W: www.miriport.gov.my  
Lat 004 34' Long 114 2' 36" E  
1 x 100t mobile harbour crane

2 x 41t reachstacker  
9 x 3-4t, 1 x 7t and 3 x 3t forklifts  
1 x 20' spreader  
1 x 140t and 1 x 50t hydraulic truck mounted cranes  
5 x terminal tractor  
4 x 40' skeletal trailer  
1 x 40' platform trailer  
Total Length ~ 390m (6 berths of 65m length each)  
63,000sqm  
5,400sqm  
Container Yard ~ 328 ground slots,  
241 TGS, Reefer points 28 TGS  
Dangerous Goods Storage ~ 200sqm

**Penang**

**Penang Port SDN BHD**  
1 King Edward Place  
Georgetown  
Penang  
10300  
Malaysia  
Contact: Mr Ahmad Ibnihajar  
Job Title: Managing Director  
T: + 60 4 210 2211  
F: + 60 4 263 4792  
E: info@penangport.com.my  
W: www.penangport.com.my

**Penang**

**Penang Port Sdn Bhd (PPSB)**  
PO Box 1204,  
No 1 King Edward Place  
Penang  
10710  
Malaysia  
Contact: Mr Suri bin Yusop  
T: + 60 4 310 2210  
F: + 60 4 2634 792 / + 60 4 2613336  
E: suri@penangport.com.my  
W: www.penangport.com.my

**Penang**

**Prai Bulk Cargo Terminal**  
Penang Port Commission  
3A-6 Bangunan Sri Weld  
Pangkalan Weld  
Penang  
10300  
Malaysia  
Contact: Mr Noor Ariff bin Yusoff  
Job Title: General Manager  
T: + 60 4 263 3211  
F: + 60 4 263 2623  
E: sPPP@penangport.gov.my  
W: www.penangport.gov.my

**Port Kelang**

**West Fertilizer Terminal Sdn Bhd**  
Lot No 55709  
Dry Bulk Terminal 2  
Persiaran Teratai, Pulau Indah  
Port Kelang  
Selangor DE  
42009  
Malaysia  
Contact: Mr Leo Bernsen  
Job Title: General Manager  
T: + 60 3 31011886  
F: + 60 3 31011886  
E: enquiry@chunyuconstruction.com

**Port Klang**

**Northport (Malaysia) Bhd.**  
Jalan Pelabuhan  
North Port  
PO Box 234  
Port Klang  
Selangor Darul Ehsan  
42009  
Malaysia  
Contact: YBhg Dato' Basheer Hassan  
Job Title: CEO/Managing Director  
T: + 60 3 3169 8888  
F: + 60 3 3169 8811  
E: info@northport.com.my  
W: www.northport.com.my

**Port Klang**

**Port Klang Authority**  
Mail Bag Service 202  
Jalan Pelabuhan  
Port Klang  
Selangor  
42005  
Malaysia  
Contact: Mr G Shanti  
Job Title: Corporate Communications Manager  
T: + 60 3 3168 8211  
F: + 70 3 3167 0211  
E: shanti@pka.gov.my  
W: www.pka.gov.my  
West Coast of Peninsular Malaysia  
- 40km from Kuala Lumpur.  
Conveyor - 3, 110,000t  
6  
12,935sqm  
42,565sqm

**Pulau Indah**

**Westports Malaysia Sdn Bhd**  
P O Box 266  
Pulau Indah  
Port Kelang  
42009  
Malaysia  
Contact: Mr Nathan  
T: + 60 3 3169 4047  
F: + 60 3 3169 4119  
E: info@westportmalaysia.com.my  
W: www.westportsmalaysia.com/

**Sandakan**

**Sandakan Port Authority**  
PO Box 1368  
Sandakan  
Sabah  
90008  
Malaysia  
Contact: Mr Francis Lee Fah Hin  
Job Title: Port Manager  
T: + 60 89 612 411  
F: + 60 88 22 3036  
E: info@portarea.com

**Seri Manjung**

**Lumut Maritime Terminal Sdn Bhd**  
Lekir Bulk Terminal (LBT)  
Pulau Lekir 1  
Jln Teluk Rubiah  
Seri Manjung  
Perak  
32040  
Malaysia  
Contact: Mr Amin Bin Halim Rasip  
Job Title: Chief Executive Officer  
T: + 60 3 2141 7728  
F: + 60 3 2141 2995  
E: aminrasip@integrex.com.my  
W: www.lumutport.com  
On a reclaimed island, South East of Pangkor Island, Perak, West Malaysia (Off the Straits of Malacca)  
2 Grab Ship Unloaders with rated capacity of 1,500mtp each and 2 import conveyors lines with rated capacity of 3,800mtp each  
Total quay length about 800m  
About 80 acres (About 323,752sqm)  
Nil  
Minimum natural depth of 20m alongside the berth

**Sibu**

**Rajang Port Authority**  
Sibu  
Sarawak  
96000  
Malaysia  
Contact: Mr Chong Siew Yang  
Job Title: General Manager  
T: + 60 84 319 009  
F: + 60 84 318 754  
E: arum@portsworld.com  
W:

www.portsworld.com/Ports/rajangport.htm

**Terengganu Darul Iman**

**Kemaman Port Authority**  
Bangunan Demaga Timur  
Telok Kalung  
Terengganu Darul Iman  
Kemaman  
24000  
Malaysia  
Contact: Mr Dato 'Tik bin Mustaffa'  
Job Title: General Manager  
T: + 60 9 863 1590  
F: + 60 9 863 1599  
E: arum@portsworld.com

**Utara**

**Kelang Port Management**  
Tingkat 2  
Blok A  
Bangunan Pentadbiran  
Jalan Parang pelabuhan  
Utara  
Selangor  
42005  
Malaysia  
Contact: Mr A Kanesan  
T: + 60 3 3168 8211  
F: + 60 3 3168 7626  
E: onestopagency@pka.gov.my  
W: www.pka.gov.my

**MALTA**

**Marsa**

**Port of Valletta**  
Malta Transport Centre  
Ports & Yachting Directorate  
Xatt L-Ghassara Ta'L-Gheneb  
Marsa  
MRS 1917  
Malta  
Contact: Mr David Bugeja  
Job Title: Chief Officer  
T: + 356 22914 401  
F: + 356 21222 208  
E: david.bugeja@transport.gov.mt  
W: www.transport.gov.mt  
Malta

**Marsa**

**Transport Malta**  
Malta Transport Centre  
Xatt L-Ghassara Ta' L-Gheneb  
Marsa  
MRS 1917  
Malta  
Contact: Captain David Bugeja  
Job Title: Ports & Yachting Directorate  
T: +356 22914441  
F: + 356 2222208  
E: info.tm@transport.gov.mt  
W: www.transport.gov.mt  
Valletta  
Kordin Grain Terminal (KGT)  
Storage facility consists of 30 bins; 18 large bins with capacity of 3,800 metric tons each and 12 smaller bins 1,600 tons each.  
Buhler installations including - mobile mechanical bulk ship unloader with a maximum unloading capacity of 1,100 mtp/h; a mechanical railmounted ship loader with a peak loading capacity of 1,250 mtp/h; and direct ship-to-ship transfer facilities without the need to intake into silo.  
The terminal can accept fully laden Panamax grain bulk carriers of up to 80,000 DWT and can load coasters and feeder vessels of up to 20,000 DWT.  
Laboratory Wharf - length 190m, vessel loading.  
Magazine Wharf - length 252m, vessel unloading  
Fuel Wharf  
N/A

88,000 metric tons  
Transport Malta has a concession agreement with two cement importers who had invested in their own Silo facilities at Fuel Wharf.

**Paola**

**Kordin Grain Terminal Company Ltd**  
PO Box 25  
Paola  
PLA 01  
Malta  
Contact: Mr Alex Agius  
Job Title: Chief Executive  
T: + 356 2360 4112  
F: + 356 2360 4180  
E: aagius@malta.net  
W: www.kordingrain.com.mt  
Malta in Valletta port  
Ship unloader 1100mtp  
Ship loader 1200mtp  
Discharging facility: Magazine Wharf Grand Harbour, Valletta.  
200m length, 14m draught.  
Loading facility: Laboratory Wharf Grand Harbour, Valletta. 120m length, 10m draught.  
90,000t  
88,000t  
Located in the natural deep-draught Valletta Harbour, Kordin is in a most strategic location for the handling, storage and transhipment of all types of free flowing grains reaching the Mediterranean

**MAURITANIA**

**Nouadhibou**

**Port Autonome de Nouadhibou**  
PO Box 236  
Nouadhibou  
Mauritania  
Contact: Ms Gaye Sidatt  
Job Title: Harbour Director  
T: + 222 45 134  
E: contact@pan.mr  
W: www.portndb.com  
Draught 16.2m. Max LOA 310m. Max Beam 47m.

**MAURITIUS**

**Port Louis**

**Mauritius Ports Authority**  
PO Box 379  
H. Ramnarain Building  
Mer Rouge  
Port Louis  
Mauritius  
Contact: Mr Shekur Sunthah  
Job Title: Ag. Director General  
T: + 230 206 5400  
F: + 230 240 0856  
E: s.sunthah@mauport.com  
W: www.mauport.com  
2,400 km off east coast of Africa  
26 x 1t and 47 x 3t Hyster forklifts,  
7 x 5t forklifts, 3 x 7-10t empty handlers, 16 x 25t Douglas prime movers, 23 x 20t and 9 x 40t low bed trailers, 1 x 40t Gottwald crane.  
6 quays with maximum dredged depth of -12.2m  
8.05 Ha  
17,900sqm

**MEXICO**

**Acapulco**

**Port Authority of Acapulco**  
Costera Miguel Aleman, Malecon Fiscal  
Col Centro  
Acapulco  
39300  
Mexico  
Contact: Mr Francisco JE Lopez



## Terminales Portuarias del Pacífico

Terminales Portuarias del Pacífico, SAPI de CV (TPP)s, located at the Mexican Pacific coast on the Port of Lazaro Cardenas, Michoacan, will have an annual capacity of 7.0 million metric tons. During the first stage, it has a capacity of 3.5 million metric tons for bulk minerals and steel products handling, and rail and truck connecting the Mexico north region and the US.

Due to the dynamic nature of the mining industry, the increasing demand for steel and energy products and highly competitive markets, more efficient alternatives are required. So, TPP is committed to providing its customers with better infrastructures to promote international trade with the Asian-Pacific - North American region.



### INFRASTRUCTURE

- Two berths with a capacity to receive cape size vessels of up to 150,000 tons of dwt.
- Navigation channel with a draft of 16.5 meters (54.13 feet).
- Mobile cranes with grabs for loading/unloading different types of products with an average rate of 30,000 metric tons/day.
- Capacity to handle up to 7.0 million metric tons annually.
- Availability of a bonded storage area for importing products.
- Capacity to deliver and receive cargo by truck and railroad.
- Swift land connection to the country's main roads.
- Railway connection with the major industrial areas of the country and the southern United States.

[www.tpp.com.mx](http://www.tpp.com.mx)

Stiles  
 Job Title: Director General  
 T: + 52 971 40668  
 F: + 52 971 40436  
 E: marketing@apiacapulcoport.com  
 W: www.apiacapulcoport.com

### Altamira

**Cooper/T. Smith De Mexico SA de CV**  
 Mar Negro KM 0.380  
 Puerto Industrial  
 Col. Puerto De Altamira  
 Altamira  
 Tamaulipas  
 89603  
 Mexico  
 Contact: Mr Arturo Encinas  
 Job Title: General Director  
 T: + 52 833 260 45 00  
 F: + 52 833 260 10 82  
 E: arturo.encinas@coopertsmith.com  
 W: www.coopertsmith.com  
 Port of Altamira, Mexico  
 Two 45-ton gantry cranes with the capacity to unload 10,000 ton/day. Frontloaders and railcars.

### Altamira

**Industrial Port of Altamira**

Altamira  
 Tamaulipas  
 89608  
 Mexico  
 Contact: Ing. Jose Luis Diaz Covarrubias Hanún  
 Job Title: Director of Port Operations  
 T: + 52 833 260 60 76  
 F: + 52 833 260 60 70  
 E: jdiaz@puertoaltamira.com.mx  
 W: www.puerto-de-altamira.com.mx  
 Fastest growing port in Mexico

### Altamira

**Terminal Marítima de Altamira, SA de CV**

Altamira  
 Tamaulipas  
 89608  
 Mexico  
 Contact: Ing. Rogelio Maya Moncada  
 Job Title: Terminal Manager  
 T: + 52 833 260 1138  
 F: + 52 833 260 1142  
 E: tmamexplus@infosel.net.mx  
 W: www.atpaltamira.com.mx  
 Port of Altamira, Mexico  
 3 grab gantry cranes. Conveyor bands.  
 Loading/unloading ships: 10,000 ton/day.  
 Loading/unloading barges: 10,000 ton/day  
 Loading/unloading trucks and railroad cars.  
 Depth - 38 feet.  
 Length - 783 feet.  
 Max DWT - 55,000.  
 4 acre product storage yard.  
 Grain warehouse: 70,000 ton capacity.  
 Mineral grains warehouse: 45,000 ton capacity.  
 Largest facility of it's type in Latin America.

### Chiapas

**Port Authority of Puerto Madero**  
 Interior Recinto Portuario  
 Puerto Madero  
 Chiapas  
 96400  
 Mexico  
 Contact: Mr Jose Rafael Reyes Ruiz  
 Job Title: Director General  
 T: + 52 962 46757  
 F: + 52 962 46758  
 E: info@puertomadero.com

### Ensenada

**Port Authority of Ensenada**  
 Boulevard Teniente Azueta 224  
 Ensenada  
 22800  
 Mexico  
 Contact: Mr Carlos Jauregui  
 Job Title: General Director  
 T: + 52 646 178 2860  
 F: + 52 646 175 0301  
 E: atencionclientes@puertoensenada.com.mx  
 W: www.puertoensenada.com.mx/

### Garita de Otoy

**Morro Redondo Port Authority**  
 Exportadora de sal SA de CV  
 3a Oeste 17523-A Fracc  
 Garita de Otoy  
 Tijuana  
 BC ZP 22500  
 Mexico  
 Contact: Mr Orozco  
 T: + 52 66 869891  
 F: + 52 66 869891  
 E: info@portarea.com  
 W: www.portarea.com /

### Guaymas

**Port Authority of Guaymas**  
 Recinto Portuario Zona Franca  
 Guaymas  
 Sonora State  
 85430  
 Mexico  
 Contact: Mr Felipe de Jesus Rivadeneyra y Sauri  
 Job Title: Director General  
 T: + 52 622 41160  
 F: + 52 622 24743  
 W: www.puertodeguaymas.com

### La Paz

**San Juan de la Costa Port Authority**  
 Port Office  
 La Paz  
 A Brocado  
 Muelle y Comercio No 13  
 La Paz  
 Baja California State  
 Mexico  
 T: + 52 61 2122 7777  
 F: + 52 61 2122 7778  
 E: apibcs@prodigy.net.mx  
 W: www.bajaport.com

### Lazaro Cardenas

**Terminales Portuarias Del Pacífico, S A P I de C V**



Canal Oriente s/n, Av. Los Rios Interior  
 Isla del Cayacal, Apartado Postal 83  
 Lazaro Cardenas  
 Michoacán  
 60950  
 Mexico  
 T: + 52 753 533 0090  
 F: + 52 753 533 0090  
 E: cargo.tpp@tpp.com.mx  
 W: www.tpp.com.mx  
 Mexican Pacific Coast  
 2 LIEBHERR crane 550 & 600  
 4.0 million metric tons annual capacity  
 One berth 180m  
 10,000sqm  
 First bulk terminal on the Mexican Pacific, capable to handle Cape Size vessel up to 173,500 dwt.



**Mazatlan**

**Port Authority of Mazatlan**  
Interior Recinto Fiscal  
Mazatlan  
Sinaloa  
82000  
Mexico  
Contact: Mr Alfonso Gil Diaz  
T: + 52 669 9823019  
F: + 52 669 9821960  
E: marketing@apimazatlan.com.mx  
W: www.apimazatlan.com.mx

**Salina Cruz**

**Port Authority of Salina Cruz**  
Calle Miramar Esq Wilfrido C Cruz  
Edif  
Capitania de Puerto  
Salina Cruz  
70680  
Mexico  
Contact: Mr D Enrique Murga  
Arroyo  
T: + 52 971 41325  
F: + 52 971 42675  
E: puerto@puertosalinacruz.com.mx  
W: www.apisal.com.mx/

**San Carlos**

**San Carlos Port Authority**  
Calle Puerto Acapulco s/n  
San Carlos  
Baja California State  
CP 23740  
Mexico  
Contact: Captain Rodriguez  
Job Title: Port Captain  
T: + 52 113 60133  
F: + 52 113 60198  
E: apibcs@prodigy.net.mx  
W: www.apibcs.com/

**Tampico**

**Port Authority of Tampico**  
Edificio API Tampico s/n  
Recinto Portuario  
Tampico  
89000  
Mexico  
Contact: Ms Ana Laura Camarillo  
Torre  
Job Title: Commercial Manager  
T: + 52 833 241 14 41  
F: + 52 833 241 14 64  
E:  
acamarillo@puertodetampico.com.mx  
W: www.port-of-tampico.com.mx

**Topolobampo**

**Topolobampo Port Authority**  
Port Office  
Acceso al Parque Industrial  
Pesquero S. N.  
Topolobampo  
Sinola State  
81370  
Mexico  
Contact: Mr Cesar Madrazo Lozano  
Job Title: Director General  
T: + 52 686 20127  
F: + 52 686 20494  
E: comercial@apitopo.com.mx  
W: www.apitopa.com.mx

**Veracruz**

**Port Authority of Veracruz**  
Avenida Merina Mercante 210  
7 piso  
Veracruz  
91700  
Mexico  
Contact: Mr Juan Jose Sanchez  
Job Title: Director  
T: + 52 229 923 2170  
F: + 52 29 323040  
E: acoutolem@puertodeveracruz.com.mx  
W: www.puertodeveracruz.com.mx



**MOROCCO**

**Casablanca**

**Office d'Exploitation des Ports**  
4 rue Moussa Ibnou Nousseir  
Casablanca  
Morocco  
Contact: Mr M Hashami  
Job Title: Marketing Director  
T: + 212 2 317111  
F: + 212 2 313501  
E: administration@odep.org.ma  
W: www.odep.org.ma

**Casablanca**

**Port Nador**  
c/o Marbar SA Casablanca  
81 Avenue Houmane  
Fegovaki  
Casablanca  
Morocco  
Contact: Mr Adil  
Job Title: Port Director  
T: + 212 2 224190  
F: + 212 2265398  
E: n\_ouakka@marsamaroc.co.ma

**El Jadida**

**Agence Nationale Des Ports**  
Anl Jorf Lasfar  
Capitainerie du Port  
Km 22, Route Duzlidia  
El Jadida  
BP 407  
Morocco  
Contact: Mr Hamzaoui Mohamed  
Job Title: Harbour Master  
T: + 212 2334 5180  
F: + 212 2334 5093  
E:  
hamzaoui.mohamed25@menara.ma

**El Jadida**

**Jorf Lasfar Power Station**  
Jorf Lasfar Energy  
8P 99  
Sidi Bouzid  
El Jadida

Morocco  
Contact: Mr Boutaib Said  
T: + 212 3 34 5371  
F: + 212 3 34 5375  
E: jlec@jlec.co.ma

**Kenitra**

**Port of Kenitra**  
PO Box 23  
Kenitra  
Morocco  
Contact: Mr Hanough  
Job Title: Port Director  
T: + 212 7 371345  
F: + 212 7 372159

**Tangier**

**Port of Tangier**  
BP 305  
Tangier  
Morocco  
E: m\_saabou@marsamaroc.co.ma  
W: www.marsamaroc.co.ma

**MOZAMBIQUE**

**Beira**

**Cornelder de Moçambique, s.a.r.l**  
Porto da Beira  
PO Box 236  
Largo dos CFM  
Beira  
150 Be  
Mozambique  
Contact: Mr Felix Machado  
Job Title: Sales & Marketing  
Manager  
T: + 258 2332 2734/5  
F: + 258 2332 2736  
E: Cornelder.mz@teledata.mz

**Beira**

**Largo dos CFM-C**  
Porto da Beira  
PO Box 236  
Beira  
Sofala

Mozambique  
Contact: Mr Rui Fonseca  
Job Title: President & Chairman of  
the Board of Directors  
T: + 258 21431706  
F: + 258 21313364  
E: cirmefonseca@cfmnet.co.mz  
W: www.cfmnet.co.mz

**Maputo**

**Grindrod Terminals - Maputo**



Praca dos Trabalhadores  
Porto de Maputo  
Maputo  
Mozambique  
Contact: Mr Mark Flynn  
Job Title: Terminal Operations  
Manager  
T: + 258 21 720 350  
F: + 258 21 720 180  
E: markf@grindrod.co.mz  
W: www.grindrod.co.za  
Port of Matola - Maputo,  
Mozambique.  
Rail wagon tippers, conveyors,  
stacker/reclaimers and ship  
loaders. Current (2012) capacity -  
6million tons pa but expanding to  
handle 7.3 million tons pa in 2013.  
210m in length, can accommodate  
vessels up to 230m in length -  
depth at quayside current 12m,  
design 12m.  
70 000sqm  
Phase 4 development will add  
another 20mtpa coal terminal  
adjacent to the existing terminal.

**Maputo**

**Maputo Port Development  
Company SARL**  
Port Director's Building  
Port Maputo  
PO Box 2841

Maputo  
Mozambique  
Contact: Mr Ricardo Roberts  
Job Title: Commercial Manager  
T: + 258 21 313 920  
F: + 258 21 313 921  
E: ricardo.roberts@portmaputo.com  
W: www.portmaputo.com  
In the South of Mozambique -  
Maputo City  
2 mobile cranes general cargo  
(40&60tons)

2 gantry cranes 40tons and 2  
mobile cranes 100tons each at the  
container terminal)  
247,000sqm  
35,000sqm  
From middle next year, covered  
storage will increase to 65,000sqm.

**Maputo**

**Mozambique Ports and Railways  
- CFM**  
Praca dos Trabalhadores  
Maputo  
2158  
Mozambique  
Contact: Mr Antonio Jorge Libombo  
Job Title: Director  
T: + 258 21301390  
F: + 258 21301390  
E: alibombo@cfmnet.co.mz  
W: www.portmaputo.com

**Maputo**

**Portos e Caminhos De Ferro de  
Mozambique**  
E.P Praca dos Trabalhadores  
PO Box 2158  
Maputo  
Mozambique  
Contact: Mr Alberto Elias  
Job Title: Port Director  
T: + 258 21 303576  
F: + 258 21301508  
E: albertoelias@cfmnet.co.mz

## Matola Stema SA



Lingamo, 729  
Matola  
Mozambique  
Contact: Mr Silvino Moreno  
Job Title: Chief Executive Officer  
T: + 258 21 721 762 / +258 21 722770  
F: + 258 21 721 763  
E: stema@stema.co.mz  
W: www.stema.co.mz  
Southern Africa, East Coast  
Mobile unloader 250tph, Loader 500tph  
3 berthing Dolphin, 1 mooring Dolphin  
25,000t in bulk. 27 silo, 1700 each

## Nacala

**Nacala Port Authority**  
Direccao nacional dos Portos  
PO Box 70  
Nacala  
Mozambique  
Contact: Mr Boaventura M  
Cherinda  
Job Title: Port Director  
T: + 258 26 212927  
F: + 258 26 212034  
E: info@cdn.co.mz

## MYANMAR

### Yangon

**Yangon Port Authority**  
Myanmar Ports Corporation  
PO Box No 1  
Yangon  
Myanmar  
Contact: Mr U K M Gyi  
Job Title: Port Manager  
T: + 95 1 283122  
F: + 95 1 95134  
E: mpa-sad@mptmail.net.mm  
W: www.mot.gov.mm/mpa/index.html

## NAMIBIA

**Walvis Bay**  
Grindrod Terminals - Walvis Bay



1st Floor Grindrod House  
174 Third Street East  
Walvis Bay  
9000  
Namibia  
Contact: Mr Shakespeare Masiza  
Job Title: Regional Manager  
T: + 264 271 270  
F: + 264 271 280  
E: shakespeare@grindrod.com.na  
W: www.grindrod.co.za  
West coast of Africa in Namibia  
Conveyor belt, shiploader, rail discharge, screening plant. The

facility has the capacity to handle 725 000 tons pa.  
Two Berths adjacent to facilities 47 546  
Future projects/developments - 500 000 tons pa Sulphur handling facility 120 000 tons Fluorspar shed and 140 000 tons copper concentrate facility.

### Walvis Bay

**Namibian Ports Authority**  
PO Box 361  
Walvis Bay 9190  
Namibia  
Contact: Mr Cliff Shikuambi  
Job Title: Marketing Dept  
T: + 264 64 208 2207  
F: + 264 64 208 2323  
E: pr.assistant@namport.com.na  
W: www.namport.com  
Situating on the central Ocoastal region of Namibia  
2 x 100 tonnes mobile cranes  
2 x 45 tonnes reach stackers  
1 x 42 tonnes container stacker  
1 x 42 tonnes forklift with spreader  
2 x 45 tonnes Kalmar Reach stacker

### Walvis Bay

**Namport**  
No 17 13th Road  
PO Box 361  
Walvis Bay  
Namibia  
Contact: Mr Christian Faure  
Job Title: Marketing & Business  
Dvpt  
T: + 264 64 2082207  
F: + 264 64 2082323  
E: cfaure@namport.com.na

W: www.namport.com

## NAURU

### Aiwo

**Nauru Port Authority**  
P O Box 5  
Aiwo  
Nauru  
Contact: Mr B Blundell  
Job Title: Marketing Manager  
T: + 674 555 4191  
F: + 674 444 7352

## NETHERLANDS

## ANTILLES

### Bonaire

**Bonaire Pilots**  
Fort Oradse z/n  
Bonaire  
Netherlands Antilles  
Contact: Captain L O Statie  
Job Title: Harbour Master  
T: + 559-717-8151  
F: + 559-717-8797

## NEW

## CALEDONIA

### Houailou

**Societe des Mines du Cap Bocage**  
Presqu'île du Cap Bocage

Box no. 18  
Houailou  
98816  
New Caledonia  
Contact: Mr Stephane  
Job Title: Mine Manager  
T: + 687 42 4855  
F: + 687 42 5284  
E: smcb@canl.nc  
Port: Baie UGUE on East Coast of New Caledonia  
Commodities handled: Nickel Ore

### Noumea

**Port Authority of New Caledonia**  
PO Box 14  
Avenue James Cook  
Noumea  
98845  
New Caledonia  
Contact: Mr Phillipe Lafleur  
Job Title: Port Manager  
T: + 687 255000  
F: + 687 283772  
E: noumeaportnc@canl.nc

## NEW

## ZEALAND

### Auckland

**NZ Stevedoring Co Ltd**  
PO Box 1291  
Auckland  
New Zealand  
Contact: Mr R J Seamer  
T: + 649 303 4048  
F: + 649 379 4836



SILOS E TERMINAL GRANELEIRO DA MATOLA. SA

...a gateway to Southern Africa

Ship Loading and Unloading • Silo • Road and rail unloading • Railway/Truck loading in bulk • Loading bags into trucks • Truck expedition • Bagging

Phone: (258 21) 721762/ 722770 • Fax: +258 21 721763 • Cell: +258 82 3003576

E-mail: stema@stema.co.mz • Web: www.stema.co.mz

Head Office: 729, LÍNGAMO, MATOLA  
PO Box 1940, MAPUTO, MOZAMBIQUE





**Auckland**

**Onehunga Port Authority**  
c/o Ports of Auckland Ltd  
PO Box 2353  
Auckland  
New Zealand  
Contact: Mr Brian Jarman  
Job Title: Port Co-ordinator  
T: + 64 9 6364264  
F: + 64 9 6346599  
E: harcon@poal.co.nz  
W: www.poal.co.nz

**Auckland**

**Ports of Auckland Limited**  
Sunderland Street  
PO Box 1281  
Auckland  
1010  
New Zealand  
Contact: Mr Jens Madsen  
Job Title: Chief Executive  
T: + 64 9 366 0055  
F: + 64 9 367 5451  
E: info@poal.co.nz  
W: www.poal.co.nz

**Bluff**

**South Port NZ Ltd**  
PO Box 1  
Bluff  
9842  
New Zealand  
Contact: Mr Mark O'Connor  
Job Title: Chief Executive  
T: + 64 3 2128159  
F: + 64 3 2128685  
E: reception@southport.co.nz  
W: www.southport.co.nz

**Lyttelton**

**Lyttelton Coal Terminal**  
Private Bag 501  
Norwich Quay  
Lyttelton  
Canterbury  
New Zealand  
Contact: Mr Peter Davie  
Job Title: Chief Executive  
T: + 64 3328 8198  
F: + 64 3328 7828  
E: peter.davie@ipc.co.nz  
W: www.ipc.co.nz

**Mount Maunganui**

**NZL Group Limited t/a NZ  
Marshalling & Stevedoring**  
Private Bag 12506  
Mount Maunganui  
New Zealand  
Contact: Mr Tony Cousins  
Job Title: General Manager  
T: + 64 7 575 4440

**Napier**

**Port of Napier Ltd**  
PO Box 947  
Napier  
4140  
New Zealand  
Contact: Mr Garth Cowie  
Job Title: Chief Executive  
T: + 646 833 4400  
F: + 646 833 4408  
E: info@napierport.co.nz  
W: www.napierport.co.nz  
East Coast of North Island  
Including 800tph conveyor. Please  
see website for more details.  
Cassidy Quay 250m, 2 North 200m,  
2 South 200m  
16,600sqm

**New Plymouth**

**Port Taranaki Limited**  
PO Box 348  
New Plymouth  
4340  
New Zealand  
Contact: Mr Roy J Weaver

Job Title: Chief Executive  
T: + 64 6 751 0200  
F: + 64 6 751 0886  
E: nweaver@porttaranaki.co.nz  
W: www.porttaranaki.co.nz  
Centrally located on the West coast  
of New Zealand's North Island.  
For further information please refer  
to our website.

**Port Chalmers**

**Port Otago Ltd**  
PO Box 8  
Port Chalmers  
New Zealand  
Contact: Mr Geoff Plunket  
Job Title: Chief Executive  
T: + 64 3 472 7890  
F: + 64 3 472 9891  
E: pol@portotago.co.nz  
W: www.portotago.co.nz  
East Coast, South Island, New  
Zealand

**Ruakaka**

**North Port Ltd**  
North Tugz Limited  
PO Box 26  
Ruakaka  
0151  
New Zealand  
Contact: Mr Tom Greig  
Job Title: Marine Services Manager  
T: + 64 9 4328452  
F: + 64 9 4328475  
E: tom@northtugz.co.nz  
W: www.northport.co.nz  
North East of New Zealand East  
Coast  
Container Forklift to 36T capacity  
3 berths @ 580m with 13.0m to  
14.5m at CD  
28 ha  
5000 sqm

**Tauranga**

**C3 Limited (previously Toll  
Owens Ltd)**  
Maritime House  
10 Rata Street  
Mount Maunganui  
Private Bag 12501  
Tauranga  
Bay of Plenty  
3143  
New Zealand  
Contact: Mr Dean Camplin  
Job Title: Chief Executive  
T: + 64 7572 8972  
F: + 64 7575 2000  
E: Dean.Camplin@C3.co.nz  
W: www.c3.co.nz  
New Zealand - All 13 Ports  
Various Stevedoring and  
Marshalling Equipment

**Tauranga**

**Port of Tauranga Ltd**  
Sailisbury Avenue  
Mount Maunganui  
Private Bag 12504  
Tauranga  
3143  
New Zealand  
Contact: Mr Mark Cairns  
Job Title: Chief Executive  
T: + 64 7 572 8899  
F: + 64 7 572 8800  
E: marketing@port-tauranga.co.nz  
W: www.port-tauranga.co.nz  
Bay of Plenty, North Island, New  
Zealand  
Twelve (12) Hoppers ranging in  
size from 300 tonne to 50 tonne  
capacity  
Berth no./ max length / max depth  
/ max draught at LW:  
8 / 180m / 12.5m / 11.7m  
9 / 180m / 12.5m / 11.7m  
10 / 200m / 12.5m / 11.7m  
11 / 223m / 12.5m / 11.7m  
12 / Cement/Tanker / 12.9m /

12.0m  
Combined Mount Maunganui  
wharves and Tauranga Container  
Terminal:  
560,000sqm  
Mount Maunganui:  
Dry Storage 21,640sqm  
Cold Storage 22,500sqm  
General Cargo/Cool Storage  
3,670sqm  
Container Terminal :  
Dry Storage 37,378sqm  
Cold Storage 7,210sqm  
Port of Tauranga's land holdings  
total 188 hectares.

**Timaru**

**PrimePort Timaru**  
PO Box 544  
Timaru  
New Zealand  
Contact: Mr Jeremy Boys  
Job Title: Chief Executive  
T: + 643 6844199  
F: + 643 6840351  
E: info@primeport.co.nz  
W: www.port-timaru.co.nz

**Wanganui**

**Wanganui Port Authority**  
c/o Wanganui Port (2010)  
Castlecliff Wharf  
PO Box 623  
Wanganui  
New Zealand  
Contact: Mr J S M Blaikie  
Job Title: Harbour Master  
T: + 64 6 3447684  
F: + 64 6 3447524  
E: john.blaikie@wanganui.govt.nz  
W: www.wanganui.govt.nz

**Wellington**

**Port of Wellington**  
Port Operations  
PO Box 794  
Wellington  
New Zealand  
T: + 64 4 472 8912  
F: + 64 4 499 0720  
E: customerservices@  
centreport.co.nz

**Westport**

**Westport Harbour**  
PO Box 335  
Westport  
7866  
New Zealand  
Job Title: Harbour Master/ Port  
Manager  
T: + 64 3 788 8086  
F: + 64 3 789 6269  
E: westportharbour-nz@xtra.co.nz  
W: www.westportharbour.co.nz  
Situated on the NW coast of South  
Island, NZ.  
Fixed coal loader 400-1,000tph.  
Cement 700tph.  
20,000sqm

**NICARAGUA**

**Managua**

**Empresa Portuaria Nacional  
(EPN)**  
Residencial Bolonia  
De Optica Nicaraguense 1 C. al  
Lago y 1 C. Abajo.  
Managua  
Nicaragua  
Contact: Licenciado Virgilio  
Rommel Silva Munguia  
Job Title: Presidente Ejecutivo  
T: + 505 266 2545/4271  
F: + 505 266 2555  
E: vsilva@epn.com.ni  
W: www.epn.com.ni

**Sandino**

**Port Sandino**  
PO Box 100  
Sandino  
Leon  
Nicaragua  
Contact: Mr Oscar Vindell  
Job Title: Port Manager  
T: + 505 312226  
F: + 505 312261

**NIGERIA**

**Lagos**

**Lagos/Apapa**  
Nigerian Ports Authority  
PO Box 12588  
Lagos  
Nigeria  
Contact: Mr A A Suleiman  
Job Title: Port Director  
T: + 234 1 260 0620  
F: + 234 1 263 0306

**Lagos**

**Nigerian Ports Authority Plc**  
26/28 Marina  
Private Mail Bag 12588  
Lagos  
Nigeria  
Contact: Mr A.B Sanni  
Job Title: Port Manager  
T: + 234 1 260 0620  
F: + 234 1 263 0306

**Port Harcourt**

**Nigerian Ports Plc**  
Private Mail Bag 5043  
Basket House  
Port Harcourt  
Nigeria  
Contact: Mr Stephen Mgbakogu  
Job Title: Port Manager  
T: + 234 84 300370  
F: + 234 84 335402  
W: www.nigeria-ports.com/

**Port Harcourt**

**Port Harcourt**  
Nigerian Ports Authority  
PO Box 5043  
Port Harcourt  
Nigeria  
T: + 234 84 300370  
F: + 234 84 335402

**NORWAY**

**Brevik**

**Grenland Port Authority**  
Stromtangen  
PO Box 20  
Brevik  
N-3951  
Norway  
T: + 47 3593 1000  
F: + 47 3593 1011  
E: ghv@grenland-havn.no  
W: www.port.of.grenland.com

**Drummen**

**Port Authority of Drammen**  
Hans Kiaersgaten 1A  
Postboks 636T  
Drummen  
3041  
Norway  
Contact: Mr Einar Olsen  
Job Title: Port Manager/Executive  
Director  
T: + 47 32 20 86 50  
F: + 47 32 20 86 51  
E: einar.olsen@drammenhavn.no  
W: www.drammenhavn.no

**Farsund**

**Elkem Aluminium Lista**  
PO Box 128

Lista  
Farsund  
N-4551  
Norway  
Contact: Mr Trygve Lundegaard  
Job Title: Shipping Manager  
T: + 47 38 39 91 00  
F: + 47 38 39 92 57  
E: trygve.lundegaard@elkem.no

**Floro**

**Port Authority of Floro**  
PO Box 17  
Floro  
6901  
Norway  
Contact: Mr Arild Hovland  
Job Title: Harbour Master  
T: + 47 57 75 6740  
F: + 47 57 740 916  
E: arild.hovland@floro.kommune.no

**Glomfjord**

**Port Authority of Glomfjord**  
c/o Norsk Hydro AS  
Postboks 190  
Glomfjord  
8160  
Norway  
Contact: Mr Erik Knutsson  
T: + 47 75 71 91 00  
F: + 47 75 71 94 15  
E: erik.knutsson@yarra.com

**Husnes**

**Aluminium Works Terminal**  
PO Box 85  
Husnes  
N-5460  
Norway  
Contact: Mr M Rossland  
Job Title: Senior Manager Soral  
T: + 47 53 47 50 00  
F: + 47 53 47 53 98

**Kirkenes**

**Port of Kirkenes**  
Municipality of Sor-Varanger  
PO Box 406  
Kirkenes  
9901  
Norway  
Contact: Mr Arnt Kr. Marthinussen  
Job Title: Manager  
T: + 47 78 99 91 00  
F: + 47 78 99 12 00  
E: arntkr@kirkenes-havn.no

**Kristiansund**

**Kristiansund and Nordmøre Port  
Authority**  
Astrupsgate 9  
Kristiansund  
6509  
Norway  
Contact: Mr Arnt Helge Honstad  
Job Title: Harbour Master  
T: + 47 40 00 65 04  
F: + 47 71 67 14 83  
E: ahh@knhavn.no  
W: www.knhavn.no

**Larvik**

**Larvik Port Authority**  
PO Box 246  
Larvik  
3251  
Norway  
Contact: Mr Jan Fredrick Jonas  
Job Title: Port Director  
T: + 47 33 16 57 50  
F: + 47 33 16 57 59  
E: jfj@larvik.havn.no  
W: www.larvikhavn.vf.no

**Mo I Rana**

**Mo I Rana Port Authority**  
PO Box 185  
Mo I Rana  
8601

Norway  
Contact: Mr P Nygaard  
T: + 47 75 13 47 00  
F: + 47 75 13 47 01  
E: pa.nygaard@rana.kommune.no  
Draught 11.4m. Max LOA 250m.  
Max Beam 32.2m.

## Mosjoen

**Mosjoen Port Authority**  
Havnegaten 60  
Mosjoen  
8650  
Norway  
Contact: Mr Torbjorn Jorgensen  
Job Title: Harbour Master  
T: + 47 75 10 18 70  
F: + 47 75 10 18 71  
E: torbjorn.jorgensen@vefsn.kommune.no

## Moss

**Port Authority of Moss**  
Moss Maritime Senter  
Postboks 5020  
Moss N-1503  
Norway  
Contact: Mr F P Syvertsen  
Job Title: Harbour Master/Managing Director  
T: + 47 69 25 10 39  
F: + 47 69 25 07 38  
E: firmapost@moss-havn.no

## Narvik

**LKAB**  
Bolagsgata 40  
PO Box 314  
Narvik  
N-8504  
Norway  
Contact: Mr Svein Ivar Sivertsen  
Job Title: General Manager  
T: + 47 959 23870  
F: + 47 769 44925  
E: svein.sivertsen@lkab.com  
W: www.lkab.com  
North of Norway  
20 million tpa  
LOA, no limitation. Draught 27m.  
350.000 dwt  
0.8 million tons  
0.5 million tons  
From the end of 2009 all storage will be covered. Total 1.5 million tons

## Narvik

**Narvik Port Authority**  
PO Box 627  
Narvik  
N-8508  
Norway  
Contact: Mr Ivan Jorgensen  
Job Title: Port Captain  
T: + 47 76 95 03 70  
F: + 47 76 95 03 84  
E: ij@portofnarvik.com  
W: www.portofnarvik.com  
At the fjord head of Vestfjorden, North Norway  
LKAB Loading Facilities, 5-7000 tpa  
26 m depth, no length limit

## Orkanger

**Port of Orkanger**  
Thamshavn Verk A/S and Co  
PO Box 10  
Orkanger  
7301  
Norway  
Contact: Mrs Anita Berre  
T: + 47 72 48 04 00  
F: + 47 72 48 19 30  
E: anita.berre@orkla-shipping.no

## Ovre

**Aardalstangen**  
Hydro Aluminium Terminal Berths  
No 1 and No 2  
PO Box 303

Ovre  
Aardalstangen  
N-5870  
Norway  
Contact: Mr Johnny Hovland  
Job Title: Manager Bulk Handling  
T: + 47 57 64 98 53  
F: + 47 57 64 97 53  
E: johnny.hovland@hydro.com

## Sauda

**Sauda Port Authority**  
P.O.Box 111  
Sauda  
4201  
Norway  
Contact: Mr Handelan  
Job Title: Harbour Master  
T: + 47 52 78 62 72  
F: + 47 52 78 15 65  
E: sauski@online.no

## Sentrum

**Oslo Port Authority**  
PO Box 230  
Sentrum  
Oslo  
N-0103  
Norway  
Contact: Ms Anne Sigrid Hamran  
Job Title: Port Director  
T: + 47 23 49 2610  
F: + 47 23 49 2601  
E: anne.sigrid.hamran@ohv.oslo.no  
W: www.oslohavn.no  
The Port of Oslo handles over 500.000 tonnes of cement annually, and up to 200.000 tonnes of grain a year.

## Stavanger

**Port Authority of Stavanger**  
Nedre Strandgt 51  
Stavanger  
4005  
Norway  
Contact: Mr Bjorn Helgoy  
Job Title: Port Director  
T: + 47 51 50 12 00  
F: + 47 51 50 12 22  
E: bjorn.helgoy@stavanger.havn.no  
W: www.stavanger.havn.no

## Stavanger

**Stavanger Havn**  
Nedre Banegt 60  
Potsboks 1569  
Kjelvene  
Stavanger  
4004  
Norway  
T: + 47 51 89 10 45  
F: + 47 51 89 04 40

## Sunnalsora

**Hydro Aluminium Private Terminal**  
PO Box 51  
Sunnalsora  
N-6600  
Norway  
Contact: Mr Sigmund Elshaug  
Job Title: Port Manager  
T: + 47 71 69 3384  
F: + 47 71 69 36 07  
E: sigmund.elshaug@hydro.com  
North West of Norway  
Two Portal Cranes 15 and 30 ton, 1 pneumatic unloading equipment  
300 meter, draft: 10,40 meter high water (planned to increase draft to 13 meter)

## Sunnalsora

**Hydro Aluminium Sunndal A/S**  
Sunnalsora  
6600  
Norway  
Contact: Mr Sigmund Elshaug  
Job Title: Port Manager  
T: + 47 71 69 30 00

F: + 47 71 69 36 07  
E: Sigmund.Elshaug@hydro.com

## Svolvaer

**Vagan**  
Vagan Havnevesen KF  
Skipsagentur  
PO Box 121  
Svolvaer  
N8301  
Norway  
Contact: Mr Kjell Hansen  
Job Title: Harbour Master  
T: + 47 76 06 79 90  
F: + 47 76 06 79 91  
E: post@vagan-havnevesen.no  
W: www.vagan-havnevesen.no

## OMAN

## Muscat

**Port Sultan Qaboos**  
Port Services Corporation (SAOG)  
PO Box 133  
Muscat  
100  
Oman  
Contact: Mrs Sunita Ramakrishan  
Job Title: Marketing Manager  
T: + 968 24714000  
F: + 968 24714007  
E: mktg@pscoman.com  
W: www.pscoman.com

## PAKISTAN

## Karachi

**Bulk Trade International**  
1A Anchor House 111  
15C 4th Commercial Lane  
Zamzama  
Karachi  
75600  
Pakistan  
Contact: Mr Syed Warasat Hussain  
Job Title: Director  
T: + 92 21 5833981  
F: + 92 21 5833982  
E: bti@attglobal.net

## Karachi

**Pak Shaheen Group**  
36-A/2, Lalazar, Opposite Beach  
Luxury Hotel  
Off M.T. Khan Road  
Karachi  
74000  
Pakistan  
Contact: Mr Yussuf Farrukh  
Job Title: COE - Services  
T: + 92 21 3285 1800  
F: + 92 21 561 2230  
E: yfarrukh@pakshaheen.com.pk  
W: www.pakshaheen.com.pk

## Karachi

**Port Muhammad Bin Qasim**  
Port Qasim Authority  
PO Box 75020  
Karachi  
75020  
Pakistan  
Contact: Captain Azhar  
Job Title: General Manager  
T: + 92 21 927 2111  
F: + 92 21 473 010  
E: info@portqasim.org  
W: www.portqasim.org.pk

## PAPUA NEW

## GUINEA

## Alotau

**Alotau Port Authority**  
PNG Harbours Board

PO Box 42  
Alotau  
Papua New Guinea  
Contact: Mr John Tungapit  
Job Title: Port Manager  
T: + 675 211 637  
F: + 675 611 276  
E: enquiries@pngports.com.pg  
W: www.pngports.com.pg

## Kavieng

**Kavieng Port Authority**  
PNG Harbours Board  
PO Box 127  
Kavieng  
New Ireland  
Papua New Guinea  
Contact: Mr S Gems  
Job Title: Port Manager  
T: + 675 984 2182  
F: + 675 984 1408

## Kimbe

**Kieta Port Authority**  
PO Box 65  
Kimbe  
Papua New Guinea  
T: + 675 935134  
E: BusinessManager.Kieta@pngports.com.pg  
W: www.pngports.com.pg

## Kimbe

**Kimbe Port Authority**  
PO Box 65  
Kimbe  
Papua New Guinea  
Contact: Mr John Tungapit  
Job Title: Port Manager  
T: + 675 211 637  
F: + 675 935 609  
E: enquiries@pngports.com.pg

## Lae

**Lae Port Authority**  
c/o PNG Harbours Board  
PO Box 563  
Lae  
Papua New Guinea  
Contact: Mr Joshua Taruna  
Job Title: Regional Port Manager  
T: + 675 426 434  
F: + 675 856 2506  
E: enquiries@pngports.com.pg

## Lae

**PNG Ports Corporation Limited**  
PO Box 563  
Lae  
Papua New Guinea  
Contact: Mr Tony Aelingian Willie  
Job Title: Senior Port Manager  
T: + 675 4722477  
F: + 675 4722543  
E: tony.willie@pngharbours.com.pg  
North of Australia - Lae Port is the biggest port in Papua New Guinea  
30 tonnes allowed on all berths  
400m berth length  
Approx 1 sq km  
Approx 0.5 sq km  
Lae Port handles Roro, Containerised, Bulk fuel Tankers, Gas Tankers, and Gen bulk vessels. Berth length up to 1 km.  
Port operates on 24 hours operations.

## Popondetta

**Oro Bay Port Authority**  
PNG Harbours Board  
PO Box 160  
Popondetta  
Papua New Guinea  
Job Title: Port Manager  
T: + 675 3 229 263  
F: + 675 3 223 207  
E: enquiries@pngports.com.pg  
W: www.pngports.com.pg

## Rabaul

**Rabaul Port Authority**  
PO Box 592  
Rabaul  
Papua New Guinea  
Contact: Mr J Taruna  
Job Title: Regional Port Manager  
T: + 675 921317  
F: + 675 921367  
E: enquiries@pngports.com.pg

## PERU

## Arequipa

**Terminal Internacional del Sur SA**  
Tisur SA  
Puerto Matarani  
Arequipa  
Peru  
Contact: Snr Mario Hart Potesta  
T: + 51 54 9 557197  
F: + 51 54 9 557044

## Callao

**Conchan Port Authority**  
Empresa Nacional de Puertos  
Terminal Maritimo  
Callao  
Peru  
T: + 51 1 429 9210  
F: + 51 1 465 6717  
W: www.cementoslima.com.pe

## Callao

**ENAPU SA**  
Port Terminal of Callao  
Callao  
1No260  
Peru  
Contact: Mr Luis Vargas Caballero  
Cooban  
Job Title: President and Chief Executive  
T: + 51 1429 9210  
F: + 51 1469 1011  
E: principal@enapu.gob.pe  
W: www.enapu.com.pe

## Chancy

**Chancay Port Authority**  
c/o Agencias Unidas Chancay SA  
Malecon de Puerto 248  
Chancy  
Peru  
Job Title: Port Manager  
T: + 51 2095

## Ilo

**Agencia Maritima Busonich**  
c/o Moguegua no 100  
Ilo  
Peru  
Contact: Mr Marco Busonich  
T: + 51 54 782962  
F: + 51 54 782962  
E: maritima@cosapidata.com.pe  
W: www.iconet.net.pe/enapu

## Iquitos

**Iquitos Port Authority**  
Avenida la Marina  
Iquitos  
s/n Punchana  
Peru  
Contact: Mr Hernan Marroquin  
Talavera  
Job Title: Port Manager  
T: + 51 94 251955  
F: + 51 94 252041  
W: www.enapu.com.pe

## La Caleta

**Port Authority of Chimbote**  
Departamento de Ancash Region  
Chavin  
Malecon Grau s/n  
La Caleta  
Chimbote



Peru  
 Contact: Mr Julio Cesar Zamorano  
 Calvo  
 Job Title: Port Manager  
 T: + 51 44 323831  
 F: + 51 44 321199  
 E: chenapu@iconet.net.pe  
 W: www.iconet.net.pe/enapu

**La Perla**  
**Autoridad Portuaria Nacional**

Av. Santa Rosa, 135  
 La Perla  
 Callao  
 Peru  
 Contact: Mr Frank Boyle Alvaro  
 Job Title: President  
 T: 511 630 9600  
 F: 511 630 9620  
 E: Informes@apn.gob.pe  
 W: www.apn.gob.pe

**Moquegua**  
**ILO Port Terminal**

Jr Matara  
 Moquegua  
 104 100  
 Peru  
 Contact: Mr Julio Zamorano Calvo  
 Job Title: Office Manager  
 T: + 51 1429 9210  
 F: + 51 1 465 6717  
 E: info@enapu.gob.pe  
 W: www.enapu.com.pe/

**Pisco**

**General San Martin Port Authority**

Punta Pejerrey Paracas  
 Pisco  
 Peru  
 Contact: Mr Alfredo Ibarcena Moran  
 Job Title: Port Manager  
 T: + 51 34 532972  
 F: + 51 34 532972  
 W: www.enapu.com.pe

**Supe Puerto**

**Supe Port Authority**  
 Giron Callao 302  
 Empresa Nacional de Puertos  
 Ancash Department  
 Supe Puerto  
 Peru  
 Contact: Mr Comte Camino  
 Job Title: Port Manager  
 T: + 51 34 364045  
 F: + 51 34 364045

**Trujillo**  
**ENAPU SA**

Salaverry Port Terminal  
 Calle Cordova s/n  
 Salaverry, Trujillo  
 Peru  
 Contact: Ms Eufrosina Hilda Santa Maria Rubio  
 Job Title: Manager  
 T: + 51 4443 7359  
 F: + 51 4443 7359  
 E: tpsalaverry@enapu.com.pe  
 W: www.enapu.com.pe

**PHILIPPINES**

**Batangas City**

**Batangas Port Authority**  
 Philippine Ports Authority  
 Santa Clara  
 Batangas City  
 Luzon Island  
 Philippines  
 Contact: Mr Edmond Moreno  
 Job Title: Manager  
 T: + 63 437 231 701  
 F: + 63 437 230 1604  
 E: alex\_t\_cruz@ppa.com.ph  
 W: www.ppa.com.ph/Port%20Profile/  
 SouthLuzon/batangas/batangas.htm

**Cagayan de Oro City**

**Masao Port Authority**  
 Philippine Ports Authority  
 Port Management Unit  
 Cagayan de Oro City  
 Philippines  
 Contact: Mr Felix M Barcala  
 Job Title: Port Manager  
 T: + 63 920 8522468  
 F: + 63 43 2886187  
 E: pmocalapan@yahoo.com  
 W: www.ppa.com.ph/

**Cagayan de Oro City**

**Philippine Ports Authority**  
 Philippine Port Authority  
 Port District Office of Northern Mindanao  
 Agora Gate  
 Port Area  
 Cagayan de Oro City  
 9000  
 Philippines  
 Contact: Mr Bienvenido P Basco  
 Job Title: Port District Manager  
 T: + 63 88 8562819  
 F: + 63 88 8562820  
 E: info@ppa.com.ph  
 W: www.ppa.com.ph

**Cebu City**

**Cebu Port Authority**  
 Philippines Port Authority  
 North Reclamation Area  
 CIP Complex  
 Cebu City  
 Philippines  
 Contact: Mr Manuel Gorme  
 Job Title: Acting Manager  
 T: + 63 32 96241  
 E: info@cpa.gov.ph

**Iligan City**

**Iligan Port Authority**  
 Philippine Ports Authority  
 Port Area  
 Iligan City  
 Philippines  
 Contact: Mr E L Delacruz  
 Job Title: Port Manager  
 T: + 63 76 621013  
 E: ppalligan@yahoo.com

**Iloilo City**

**Iloilo Port Management Office**  
 Philippine Ports Authority  
 Bgy Loboc, La Paz  
 Iloilo City  
 Iloilo Province  
 Philippines  
 Contact: Mr Christian B Santillan  
 Job Title: Manager  
 T: + 63 33 76945  
 F: + 63 33 76945  
 E: info@ppa.com.ph

**Jolo Sulu**

**Jolo Port Authority**  
 Philippine Ports Authority  
 Jolo Sulu  
 Philippines  
 Contact: Mr Sisali B Arap  
 Job Title: Manager PMO-Jolo  
 T: + 63 2 914  
 E: info@ppa.com.ph

**La Union**

**San Fernando Port Authority**  
 Philippine Ports Authority  
 Port Management Office  
 San Fernando  
 La Union  
 Luzon Island  
 Philippines  
 Contact: Mr Adolfo Amor Junior  
 Job Title: Port Manager  
 T: + 63 72 412557  
 F: + 63 72 415580

**Legazpi City**

**Lagazpi Port Management Authority**  
 PMO Legazpi  
 Pier Site  
 Legazpi City  
 4500  
 Philippines  
 Contact: Ms Hazel A Garchitorena  
 Job Title: Acting Terminal Supervisor  
 T: + 63 522 480 7890  
 F: + 63 522 480 7890

**Makati City**

**Mariveles Port-Smithbell & Co**  
 Smith Bell Building  
 2294 Pasong Tamo Extension  
 Makati City  
 1231  
 Philippines  
 T: + 63 2 816 7851  
 F: + 63 2 813-6949  
 E: ho@smithbell.com.ph

**Makati City**

**Wilhelmsen-Smith Bell Shipping, Inc.**  
 2294 Pasong Tamo Extension  
 Makati City  
 1231  
 Philippines  
 Contact: Mr Fausto R Preysler Jr  
 Job Title: President & Chairman  
 T: + 63 2 8167851 to 58  
 F: + 63 2 8150199 / + 63 2 8136949  
 E: preysler@smithbell.com.ph  
 W: www.smithbell.com.ph

**Manila**

**Asian Terminals Incorporated**  
 A Bonifacio Drive  
 Port Area  
 South Harbor  
 Manila  
 Philippines  
 Contact: Mr Suhail Al Banna  
 Job Title: Executive Vice President - Technical  
 T: + 63 2 528 6000  
 F: + 63 2 527 2467  
 E: webmaster@asianterminals.com.ph  
 W: www.asianterminals.com.ph

**Manila**

**Mariveles Grain Terminal (MGT)**  
 A. Bonifacio Drive Port Area  
 Manila  
 Bataan  
 1018  
 Philippines  
 Contact: Mr Ruel S Lagtapon  
 Job Title: AVP & Terminal Manager  
 T: +632 528-6000  
 F: +632 527-3647  
 E: ruell@asianterminals.com.ph  
 W: www.asianterminals.com.ph

**Manila**

**Philippine Ports Authority**  
 Port Management Unit  
 Bonifacio Drive  
 South Harbour Port Area  
 Manila  
 Philippines  
 Contact: Atty. JUAN C STA. ANA  
 Job Title: General Manager  
 T: + 53 2 527 4856  
 F: + 53 2 527 4854  
 E: jostaana@ppa.com.ph  
 W: www.ppa.com.ph

**Tacloban**

**Philippine Ports Authority**  
 Brgy 1 & 4, Port Area,  
 Tacloban City  
 Tacloban  
 Leyte  
 6500

Philippines  
 Contact: Mr Dominador D. Licayan  
 Job Title: Port Manager  
 T: + 63 53 321 6704  
 F: + 63 53 325 7248  
 E: pmotacloban@ppavis.com  
 W: www.ppavis.com  
 Lat 11° 15' N ; Long 125°00' E..  
 The port is located on the NE of Leyte Island and is the regional capital of Eastern Visayas.  
 Crane - 25t  
 Length 813m, Draught along berth 5.78m below MLLW  
 4,459sqm  
 576.60sqm

**POLAND**

**Gdansk**

**Port of Gdansk Authority SA**  
 Zamknieta 18  
 Gdansk  
 Pomeranian  
 80-955  
 Poland  
 Contact: Mr Julian Skelnik  
 Job Title: Foreign Relations, Mrking & Promo. Director,Proxy  
 T: + 48 58 737 99 00  
 F: + 48 58 737 99 02  
 E: julian.skelnik@portgdansk.pl  
 W: www.portgdansk.pl  
 Centre of the Southern Coast of the Baltic Sea

Cranes from 3.2 t to 25t. Conveying systems, defrosting systems, automated sampling machines, railcar tippers, railway sidings etc.  
 PORT FREE ZONE: Area 31 ha; Warehouses area 38,553sqm, Warehouses capacity 32,000t, Open stores 113,400sqm, Cranes from 6 to 16t.  
 OLIWSKIE QUAY: Warehouses area 30,000sqm , Warehouses capacity 15,000t, Elevator 5,000t, Open stores 35,534sqm, Cranes from 6 to 16t.  
 WISLANE QUAY- cranes from 6 to 25t, Warehouses area 19,727sqm, Grain elevator 8,500t, Open stores 91,307sqm, 2 bunkers 3,945sqm.  
 PRZEMYSLOWE QUAY - cranes 3t, Warehouses area 11,839sqm, Warehouses capacity 75,000t.  
 CHEMIKOW QUAY - cranes 8t and gantry cranes 20t, warehouses capacity 75,000t.  
 RUDOWE QUAY - cranes from 8 to 25t, Open stores 34,610sqm, 2 bunkers 5,093sqm.  
 WEGLOWE QUAY - cranes from 8 to 25t, 5 bunkers 12,583sqm.  
 OBRONCOW POCZTY POLSKIEJ QUAY - cranes from 3.2 to 6.3t, open stores 20,000sqm.  
 COAL TERMINAL - Open stores 17,355sqm, 5 bunkers 73,085sqm.

In Port of Gdansk there are acceptable the vessels with the following parameters: up to 400m in length and 15m draught.  
 549,525sqm  
 107,022sqm  
 The Port of Gdansk is situated at the intersection of the principal European transport routes, providing the most convenient connection between both Central and Eastern Europe and Scandinavia as well as between Western and Eastern Europe.

**Gdansk**

**PPS Port Polnocny Co Ltd**  
 23 Budowniczych Portu Polnocnego Str  
 Gdansk  
 80-601

Poland  
 Contact: Mr Andrzej Kasprzak  
 Job Title: President  
 T: + 48 58 737 60 52  
 E: polnocny@portgdansk.pl  
 W: www.portgdansk.pl

**Gdansk**

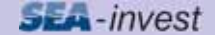
**Port Polnocny Sea-invest**  

SEA-invest  
 Skaldenstraat 1  
 9042 GHENT - BELGIUM  
 T: +32 9 255 02 11  
 W: info@sea-invest.be  
 W: www.sea-invest.com  
 Dry bulk distribution and storage centre for import, export and transshipment of raw materials. Mainly coal and iron ore, but also all kind of dry bulk cargoes. Two jetties each with a draught of 15m, allowing for the loading and unloading of vessels of up to 150,000dwt. Two cranes, each with a lifting capacity of 50 tonnes. Two maritime shiploaders, able to load Capesize vessels. One train loading station. Five stacker/reclaimers. 32 ha stockpiling area. Up to date environmental equipment.

**Gdynia**

**Baltic Grain Terminal**  
 Indyjska 2 Street  
 Gdynia  
 81-336  
 Poland  
 Contact: Mr Marek Kwiatkowski  
 Job Title: Logistics Director  
 T: + 48 58 627 4372  
 F: + 48 58 621 5544  
 E: btztrade@btz.gdynia.pl  
 W: www.port.gdynia.pl  
 North of Poland; Baltic Sea  
 2 berth's reloaders: Buhler and Transmec; 1 mln tpa  
 2 berths: Indyjskie of 245m length and 11m depth; Norweskie of 115m length and 8.5m depth  
 51,000t (elevator, silos and flat warehouse)  
 The Terminal serves ships up to 70,000dwt

**Gdynia**

**Baltic Ports Organization Secretariat**  
 c/o Actia Forum  
 Gdynia  
 81-368  
 Poland  
 Contact: Mr Bogdan Oldakowski  
 Job Title: Secretary General  
 T: + 48 58 627 24 67  
 F: + 48 58 627 24 27  
 E: bpo.office@actiaforum.pl  
 W: www.bpoports.com

**Gdynia**

**BTDG - Baltic General Cargo Terminal Gdynia ltd**  
 Dokerów 7 St  
 Gdynia  
 81-336  
 Poland  
 Contact: Mr Jacek Dubicki  
 Job Title: General Director  
 T: + 48 58 627 40 90  
 F: + 48 58 627 41 07  
 W: www.btdg.pl

## Gdynia

Maritime Bulk Terminal Gdynia Ltd



ul. Węglowa 4  
Gdynia  
81-341  
Poland

Contact: Mr Rinus Roose  
Job Title: Manager Marketing and Development

T: + 48 58 627 4555  
F: + 48 58 621 5354

E: roose@mtmg.gdynia.pl

W: www.mtmg.gdynia.pl

North of Poland on the Baltic Sea

15 shore grab-hook cranes, capacity of 8, 10, 16 and 40 tonnes, 3 self-propelled grab-hook cranes of the lifting capacity of 24-124 tonnes, stationary pneumatic-mechanical conveyor, covered device for grain reloading with the electronic container scales, 2 weighbridges for wagons and 3 weighbridges for trucks, external parking for 122 trucks.

- Dutch quay: length 500m, depth 13m

- Southern Pier of Danish quay (dedicated for liquid chemicals): length 170m, depth 9,1m

- Swedish quay: length 444m, depth 10.6m

- Silesian quay: length 353m depth 8.6m

73,070sqm

17,055sqm and 20,000 m3

## Gdynia

Port of Gdynia

Ul. Rotterdamska 9  
Gdynia  
81-337  
Poland

Contact: Mr Janusz Jarosiński

Job Title: Managing Director

T: + 48 58 627 4002

F: + 48 58 621 6916

E: marketing@port.gdynia.pl

W: www.port.gdynia.pl

## Gdynia

Rudoport SA

Kpt. Z W Witolda Poinca 1  
Gdynia  
80-955  
Poland

Contact: Dr Eng Jerzy Pasinski

T: + 48 58 6213696

F: + 48 58 6213698

E: rudoport@portgdansk.pl

Poland Nord - Gdansk

In investing process

140,000 sqm (total uncovered and covered)

## Kolobrzeg

Port Authority of Kolobrzeg

c/o Polish Baltic Shipping Co  
ul. Portowa 41  
Kolobrzeg  
78-100  
Poland

Contact: Mr W Grzesznik

Job Title: Director

T: + 48 94 352 5211

F: + 48 94 352 6612

E: info@polferries.pl

W: www.polferries.pl

## Police

Port Police

Zakłady Chemiczne 'Police' S.A.,  
ul. Kuznicka 1,  
Police  
72-010  
Poland

Contact: Mr Roman Polak

Job Title: Port Manager

T: + 48 91 317 4330

F: + 48 91 317 1519

E: rpolak@zchpolice.com

W:

www.polfracht.pl/polfracht/psal/localinf

/polic/portpoli.htm

φ = 53°33,7' N λ = 014°35,4' E

15 tys. m2

N/A

## Swinoujscie

Port Handlowy Swinoujscie Sp. z o.o.

ul. Bunkrowa 1  
Swinoujscie  
Zachodniopomorskie  
72-602  
Poland

Contact: Mr Lukasz Przyszlak

Job Title: Trade & Marketing Director

T: + 48 91 32 77 524

F: + 48 91 32 77 520

E: lukasz.przyszlak@phs.com.pl

W: www.phs.com.pl

North West of Poland on the Baltic Sea

9 shore cranes (10-140 ton capacity), 1 coal loading device, Coal Terminal, Cereal Terminal, Iron Ore Terminal, Biomass Terminal

4 berths

156,235sqm

23,930sqm

Max ships' draught 13.2m, port's annual handling potential ca 12 million tons

## Szczecin

Andreas sp. z o.o.

St. Oder 72

Szczecin

71820

Poland

Contact: Mr P. Andreas

Job Title: President

T: + 48 91 453 8691

F: + 48 91 421 5914

E: p.andreas@andreas.szczecin.pl

W: www.andreas.szczecin.pl

## Szczecin

Bulk Cargo - Port Szczecin Sp. z o.o.

Gdanska 21

Szczecin

Zachodniopomorskie

70-661

Poland

Contact: Mr Bogdan Walczak

Job Title: Marketing Director

T: + 48 91 4 307 112

F: + 48 91 4 307 115

E: bwalczak@bulkcargo.com.pl

W: www.bulkcargo.com.pl

At the mouth of the Odra river, the 65 km from the coast of the Baltic Sea, at the crossroads of transport routes from north to the south of Europe

Stationary cranes x 31, Mobile cranes x 14, Loaders x 14, Bulldozers x 5, Fork-lift trucks x 42, Locomotive x 3, Wheel tractors x 12, Conveyors x 20, Trailers x 22, 11 quays available. From 188m - 525m length and 6.4m - 9.15m depth

300,000sqm

40,000sqm

We are the most multipurpose stevedoring company with comprehensive storing and reloading offer covering all groups of cargoes.

Szczecin: 27,000 sqm

Grain silo in Szczecin: 73,000 cu m. Silo EWA has a total capacity of 55,000t including 158 bins and 13 storeys of flat storage. There are three other silos, of total storage capacity over 15,000t.

The port complex of Szczecin and Swinoujscie is of crucial significance for Polish economics. That largest dry bulk cargo centre at Polish sea-coast handles nearly 50 % of the country's coal exports and nearly 100% of its sea-shipped iron ore imported.

Szczecin: 27,000 sqm

Grain silo in Szczecin: 73,000 cu m. Silo EWA has a total capacity of 55,000t including 158 bins and 13 storeys of flat storage. There are three other silos, of total storage capacity over 15,000t.

The port complex of Szczecin and Swinoujscie is of crucial significance for Polish economics. That largest dry bulk cargo centre at Polish sea-coast handles nearly 50 % of the country's coal exports and nearly 100% of its sea-shipped iron ore imported.

Szczecin: 27,000 sqm

Grain silo in Szczecin: 73,000 cu m. Silo EWA has a total capacity of 55,000t including 158 bins and 13 storeys of flat storage. There are three other silos, of total storage capacity over 15,000t.

The port complex of Szczecin and Swinoujscie is of crucial significance for Polish economics. That largest dry bulk cargo centre at Polish sea-coast handles nearly 50 % of the country's coal exports and nearly 100% of its sea-shipped iron ore imported.

Szczecin: 27,000 sqm

Grain silo in Szczecin: 73,000 cu m. Silo EWA has a total capacity of 55,000t including 158 bins and 13 storeys of flat storage. There are three other silos, of total storage capacity over 15,000t.

The port complex of Szczecin and Swinoujscie is of crucial significance for Polish economics. That largest dry bulk cargo centre at Polish sea-coast handles nearly 50 % of the country's coal exports and nearly 100% of its sea-shipped iron ore imported.

Szczecin: 27,000 sqm

Grain silo in Szczecin: 73,000 cu m. Silo EWA has a total capacity of 55,000t including 158 bins and 13 storeys of flat storage. There are three other silos, of total storage capacity over 15,000t.

The port complex of Szczecin and Swinoujscie is of crucial significance for Polish economics. That largest dry bulk cargo centre at Polish sea-coast handles nearly 50 % of the country's coal exports and nearly 100% of its sea-shipped iron ore imported.

Szczecin: 27,000 sqm

Grain silo in Szczecin: 73,000 cu m. Silo EWA has a total capacity of 55,000t including 158 bins and 13 storeys of flat storage. There are three other silos, of total storage capacity over 15,000t.

The port complex of Szczecin and Swinoujscie is of crucial significance for Polish economics. That largest dry bulk cargo centre at Polish sea-coast handles nearly 50 % of the country's coal exports and nearly 100% of its sea-shipped iron ore imported.

Szczecin: 27,000 sqm

Grain silo in Szczecin: 73,000 cu m. Silo EWA has a total capacity of 55,000t including 158 bins and 13 storeys of flat storage. There are three other silos, of total storage capacity over 15,000t.

The port complex of Szczecin and Swinoujscie is of crucial significance for Polish economics. That largest dry bulk cargo centre at Polish sea-coast handles nearly 50 % of the country's coal exports and nearly 100% of its sea-shipped iron ore imported.

Szczecin: 27,000 sqm

Grain silo in Szczecin: 73,000 cu m. Silo EWA has a total capacity of 55,000t including 158 bins and 13 storeys of flat storage. There are three other silos, of total storage capacity over 15,000t.

The port complex of Szczecin and Swinoujscie is of crucial significance for Polish economics. That largest dry bulk cargo centre at Polish sea-coast handles nearly 50 % of the country's coal exports and nearly 100% of its sea-shipped iron ore imported.

Szczecin: 27,000 sqm

Grain silo in Szczecin: 73,000 cu m. Silo EWA has a total capacity of 55,000t including 158 bins and 13 storeys of flat storage. There are three other silos, of total storage capacity over 15,000t.

The port complex of Szczecin and Swinoujscie is of crucial significance for Polish economics. That largest dry bulk cargo centre at Polish sea-coast handles nearly 50 % of the country's coal exports and nearly 100% of its sea-shipped iron ore imported.

Szczecin: 27,000 sqm

Grain silo in Szczecin: 73,000 cu m. Silo EWA has a total capacity of 55,000t including 158 bins and 13 storeys of flat storage. There are three other silos, of total storage capacity over 15,000t.

The port complex of Szczecin and Swinoujscie is of crucial significance for Polish economics. That largest dry bulk cargo centre at Polish sea-coast handles nearly 50 % of the country's coal exports and nearly 100% of its sea-shipped iron ore imported.

Szczecin: 27,000 sqm

Grain silo in Szczecin: 73,000 cu m. Silo EWA has a total capacity of 55,000t including 158 bins and 13 storeys of flat storage. There are three other silos, of total storage capacity over 15,000t.

The port complex of Szczecin and Swinoujscie is of crucial significance for Polish economics. That largest dry bulk cargo centre at Polish sea-coast handles nearly 50 % of the country's coal exports and nearly 100% of its sea-shipped iron ore imported.

Szczecin: 27,000 sqm

Grain silo in Szczecin: 73,000 cu m. Silo EWA has a total capacity of 55,000t including 158 bins and 13 storeys of flat storage. There are three other silos, of total storage capacity over 15,000t.

The port complex of Szczecin and Swinoujscie is of crucial significance for Polish economics. That largest dry bulk cargo centre at Polish sea-coast handles nearly 50 % of the country's coal exports and nearly 100% of its sea-shipped iron ore imported.

Szczecin: 27,000 sqm

Grain silo in Szczecin: 73,000 cu m. Silo EWA has a total capacity of 55,000t including 158 bins and 13 storeys of flat storage. There are three other silos, of total storage capacity over 15,000t.

The port complex of Szczecin and Swinoujscie is of crucial significance for Polish economics. That largest dry bulk cargo centre at Polish sea-coast handles nearly 50 % of the country's coal exports and nearly 100% of its sea-shipped iron ore imported.

Szczecin: 27,000 sqm

Grain silo in Szczecin: 73,000 cu m. Silo EWA has a total capacity of 55,000t including 158 bins and 13 storeys of flat storage. There are three other silos, of total storage capacity over 15,000t.

The port complex of Szczecin and Swinoujscie is of crucial significance for Polish economics. That largest dry bulk cargo centre at Polish sea-coast handles nearly 50 % of the country's coal exports and nearly 100% of its sea-shipped iron ore imported.

Szczecin: 27,000 sqm

Grain silo in Szczecin: 73,000 cu m. Silo EWA has a total capacity of 55,000t including 158 bins and 13 storeys of flat storage. There are three other silos, of total storage capacity over 15,000t.

The port complex of Szczecin and Swinoujscie is of crucial significance for Polish economics. That largest dry bulk cargo centre at Polish sea-coast handles nearly 50 % of the country's coal exports and nearly 100% of its sea-shipped iron ore imported.

Szczecin: 27,000 sqm

Grain silo in Szczecin: 73,000 cu m. Silo EWA has a total capacity of 55,000t including 158 bins and 13 storeys of flat storage. There are three other silos, of total storage capacity over 15,000t.

The port complex of Szczecin and Swinoujscie is of crucial significance for Polish economics. That largest dry bulk cargo centre at Polish sea-coast handles nearly 50 % of the country's coal exports and nearly 100% of its sea-shipped iron ore imported.

Szczecin: 27,000 sqm

Grain silo in Szczecin: 73,000 cu m. Silo EWA has a total capacity of 55,000t including 158 bins and 13 storeys of flat storage. There are three other silos, of total storage capacity over 15,000t.

The port complex of Szczecin and Swinoujscie is of crucial significance for Polish economics. That largest dry bulk cargo centre at Polish sea-coast handles nearly 50 % of the country's coal exports and nearly 100% of its sea-shipped iron ore imported.

Szczecin: 27,000 sqm

Grain silo in Szczecin: 73,000 cu m. Silo EWA has a total capacity of 55,000t including 158 bins and 13 storeys of flat storage. There are three other silos, of total storage capacity over 15,000t.

The port complex of Szczecin and Swinoujscie is of crucial significance for Polish economics. That largest dry bulk cargo centre at Polish sea-coast handles nearly 50 % of the country's coal exports and nearly 100% of its sea-shipped iron ore imported.

Szczecin: 27,000 sqm

Grain silo in Szczecin: 73,000 cu m. Silo EWA has a total capacity of 55,000t including 158 bins and 13 storeys of flat storage. There are three other silos, of total storage capacity over 15,000t.

The port complex of Szczecin and Swinoujscie is of crucial significance for Polish economics. That largest dry bulk cargo centre at Polish sea-coast handles nearly 50 % of the country's coal exports and nearly 100% of its sea-shipped iron ore imported.

Szczecin: 27,000 sqm

Grain silo in Szczecin: 73,000 cu m. Silo EWA has a total capacity of 55,000t including 158 bins and 13 storeys of flat storage. There are three other silos, of total storage capacity over 15,000t.

The port complex of Szczecin and Swinoujscie is of crucial significance for Polish economics. That largest dry bulk cargo centre at Polish sea-coast handles nearly 50 % of the country's coal exports and nearly 100% of its sea-shipped iron ore imported.

Szczecin: 27,000 sqm

Grain silo in Szczecin: 73,000 cu m. Silo EWA has a total capacity of 55,000t including 158 bins and 13 storeys of flat storage. There are three other silos, of total storage capacity over 15,000t.

The port complex of Szczecin and Swinoujscie is of crucial significance for Polish economics. That largest dry bulk cargo centre at Polish sea-coast handles nearly 50 % of the country's coal exports and nearly 100% of its sea-shipped iron ore imported.

Szczecin: 27,000 sqm

Grain silo in Szczecin: 73,000 cu m. Silo EWA has a total capacity of 55,000t including 158 bins and 13 storeys of flat storage. There are three other silos, of total storage capacity over 15,000t.

The port complex of Szczecin and Swinoujscie is of crucial significance for Polish economics. That largest dry bulk cargo centre at Polish sea-coast handles nearly 50 % of the country's coal exports and nearly 100% of its sea-shipped iron ore imported.

Szczecin: 27,000 sqm

000tph capacity, 2 wagon tippers and defreezing station and a belt conveyors system.

Szczecin: 1 x wagon tipper and 1,000tph shiploader. 2 cranes and 7 telescopic ship loaders.

Loading/discharging of vessels at max rate of 10,000tpd for grain and 3,500tpd for feed.

Swinoujscie: Bulk carriers up to 270m in length, 13.2m draught

Swinoujscie quays: Górnolaskie (245m long, 12.8m draught), Hutników (329m long, 13.2m draught), Chemików (282m long, 12.8m draught), Portowcow (245m long, 11.9m draught).

Szczecin: Vessels up to 210m in length and 9.15m draught

Szczecin: quays: Górnolaskie (282m long, 9.15m draught), Noteckie (283m long, 6.4m draught), Regalica (210m long, 6.7m draught), Huk (268m long, 7.20m draught), Gliwickie (260m long, 9.15m draught), Bytomskie (342m long, 9.15m draught), Wałbrzyskie (270m long, 8.7m draught), Pirs Węglowy (188m long, 9.15m draught), Chorzowskie (290m long, 9.15m draught), Katowickie (525m long, 9.15m draught), Parnica (320m long, 7.0m draught).

Grain silo quays in Szczecin: Zbozowe quay (220m long, 9.15m draught), Snop (316m long, 5.8m draught), Bydgoskie (125m long, 5.8m draught), Poznanskie (80m long, 5.2m draught).

Swinoujscie: 156,000sqm of open storage for up to 700,000 tonnes of coal. An open storage area of 70,000 tonne capacity for iron ore. Szczecin: 267,000 sqm.

35,000sqm of open storage for up to 170,000t of coal.

Swinoujscie: 20,000 sqm. 100,000-tonne capacity warehouse with its belt conveyor installation.

Szczecin: 27,000 sqm

Grain silo in Szczecin: 73,000 cu m. Silo EWA has a total capacity of 55,000t including 158 bins and 13 storeys of flat storage. There are three other silos, of total storage capacity over 15,000t.

The port complex of Szczecin and Swinoujscie is of crucial significance for Polish economics. That largest dry bulk cargo centre at Polish sea-coast handles nearly 50 % of the country's coal exports and nearly 100% of its sea-shipped iron ore imported.

Szczecin: 27,000 sqm

Grain silo in Szczecin: 73,000 cu m. Silo EWA has a total capacity of 55,000t including 158 bins and 13 storeys of flat storage. There are three other silos, of total storage capacity over 15,000t.

The port complex of Szczecin and Swinoujscie is of crucial significance for Polish economics. That largest dry bulk cargo centre at Polish sea-coast handles nearly 50 % of the country's coal exports and nearly 100% of its sea-shipped iron ore imported.

Szczecin: 27,000 sqm



Completely enclosed conveying system from ship to silos and transfer from silos to truck or rail wagon.  
Monitor control room fully computerized.

**Barreiro**

**Barreiro Terminal - Atlanport**



Sociedade de Exploração Portuária, S.A  
Largo Alexandre Herculano  
Complexo Industrial da Quimiparque  
Apartado 5109  
Barreiro  
2831-904  
Portugal  
Contact: Eng Ramalho de Nascimento  
Job Title: Executive Director  
T: + 351 21 206 6610/11/12  
F: + 351 21 206 6629  
E: atlanport@atlanport.pt  
W: atlanport@atlanport.pt  
www.ete.pt/Grupo/Empresas/Atlanport\_E.htm  
Lisbon (Located on the south bank in the Tagus River)  
Installed handling capacity: 800,000tpa  
EquipmenQuay no. 2: Two 10-Ton Porticos (500tph each), Quay no. 5: Two 5-Ton Road cranes, 1 cargo conveyor belt with a rhythm of approximately 150tph and a power of 18,5 kw, 2 spinning cranes to handle scrap, 4 loading shovels + 3 forklifts, respectively, de 2,5 , 3 and 10 Tons.  
Length of quay: 170m + 200m  
Depths: -10,5m and -9,5m ZH  
This terminal receives mainly solid bulk.

**Funchal**

**Port Authority of Madeira**

Avenida Sa Carneiro 4  
Funchal  
Madeira  
9004-518  
Portugal  
Contact: Mr Fernando Silva  
Job Title: Administration  
T: + 351 291 208 600  
F: + 351 291 220 196  
E: marketing@apram.pt

**Gafanha da Nazaré**

**APA - Administração do Porto de Aveiro, S.A.**

Edifício 9 - Forte da Barra  
Apartado 91  
Gafanha da Nazaré  
3834-908  
Portugal  
Contact: Dr Luis Manuel Dionisio Marques  
Job Title: Board Member  
T: + 351 234 393 300  
F: + 351 234 393 399  
E: geral@portodeaveiro.pt  
W: www.portodeaveiro.pt  
Latitude 40° 39' N Longitude 8° 48' 5 W  
Situating in an internal lagoon, known as the Ria of Aveiro, in the Atlantic Eastern coast of Europe.  
Total Quay Length: North Terminal - 900 m, South Terminal - 400 m, Solid Bulk Terminal - 750m  
North Terminal - 328,000 sqm, South Terminal - 47,000 sqm, Solid Bulk Terminal - 260,000 sqm  
Recording an annual traffic of 3 million tonnes, Aveiro is a

multifunctional port, performing a primordial part in its area of influence rendering services to: ceramics; chemical; viticultural; metallurgical; wood and by-products; agri-products and building construction industries.

**Leca da Palmeira**

**Port Authority of Leixoes**  
Administração dos Portos do Douro e Leixões, S.A.  
Avenida da Liberdade  
Apartado 3004  
Leca da Palmeira  
Matosinhos  
4451-851  
Portugal  
Contact: Mr Amadeu Ferreira da Rocha  
Job Title: Director do Gabinete de Estudos e Planeamento  
T: + 351 229 990 700  
F: + 351 229 955 062  
E: correio@portofeixoes.pt  
W: www.apd.pt

**Lisbon**

**APL - Administration of Port of Lisbon**

Rua da Junqueira, 94  
Lisbon  
1349-026  
Portugal  
Contact: Mr Fernanda Silva  
Job Title: Marketing  
T: + 351 21 361 1023  
F: + 351 21 862 0308  
E: fpsilva@portodelisboa.pt  
W: www.portodelisboa.pt/.../PORT\_FACILITIES/

**Lisbon**

**Iberol - Sociedade Iberica de Biocombustíveis**

e Oleaginosas, SA  
Av. Frei Miguel Contreiras  
54-2  
Lisbon  
1700-213  
Portugal  
Contact: Snr José António  
Job Title: Logistic Director  
T: + 351 21 843 16 24  
F: + 351 21 843 16 92  
E: jose.antonio.iberol@sortico.pt  
W: www.iberol.com.pt

**Lisbon**

**Lisbon Port Authority**

Rua da Junqueira 94  
Lisbon  
1349-026 Lisboa  
Portugal  
Contact: Ms Sandra Rodrigues  
Job Title: Commercial Relations  
T: + 351 21 3611026 / 5  
F: + 351 21 392 2041  
E: srodrigues@portodelisboa.pt  
W: www.porto-de-lisboa.pt  
In the Tagus estuary.  
Dry bulk cargo; more than 5,200,000t last year, of which 3,550,000t were agri-bulk.  
The port of Lisbon has several specialised terminals for dry bulk cargo on both banks of the Tagus.  
The port of Lisbon is a natural port, opened throughout the whole year.  
Please see our website www.porto-de-lisboa.pt for more information.

**Lisbon**

**Poço Bispo Multipurpose Terminal - TMPB**



ETE - Empresa de Tráfego e Estiva, S.A.  
Largo do Corpo Santo, 21  
Lisbon  
1200-129 Lisboa  
Portugal  
Contact: Engº António Jordão  
T: + 351 211 128 048  
F: + 351 211 128 045  
E: tmpb@ete.pt  
W: www.ete.pt/Grupo/Empresas/Ete\_E.htm  
Lisbon (Located on the north bank in the Tagus River)  
Installed handling capacity: 2,000,000tpa  
Equipment: 2 Mobil Cranes, 40t and 64t respectively, 3x 6t Electrical rail crane, 2 reach stackers, 2 hoppers, 5 frontal forklifts; 3 loading shovel, 3 BobCats.  
5 floating cranes, 15 barges with 45,000 tons capacity, 3 tug boats.  
Length of quay: 420m  
Depths: -5 e -6m ZH  
9,950sqm  
10,100sqm  
The terminal handles all types of general cargo, special break bulk and project and is particularly active on grain bulk.

**Lisbon**

**Silopor - Empresa de Silos Portuários, S.A**

(Beato Bulk Foodstuffs Terminal)  
Av. Infante D.Henrique  
Terminal Portuário do Beato  
Lisbon  
1900 Lisboa  
Portugal  
Contact: Mr Carlos Silva  
Job Title: Trade Manager  
T: + 351 21 392 32 61  
F: + 351 21 392 32 69  
E: carlos.silva@silopor.com  
W: www.silopor.pt  
Lisbon (Located on the north bank in the Tagus River)  
Installed handling capacity: 1,320,000tpa. Equipment: 1 pneumatic unloader (600tph) with two telescopic lances, 1 mechanical unloader (600tph) with a lance.  
Length of Quay: 198m  
Depths: -7,3m ZH  
This terminal is equipped for handling solid bulk. Wheat, barley, corn, oatmeal, broad beans and lucerne are the main merchandise handled.

**Lisbon**

**Silopor - Empresa De Silos Portuários, SA**

(Trafaria Bulk Foodstuffs Terminal)  
Rua das Matas Nacionais  
Lisbon  
2825-867 Trafaria  
Portugal  
Contact: Mr Carlos Silva  
Job Title: Commercial Director  
T: + 351 21 392 3260  
F: + 351 21 290 3269  
E: carlos.silva@silopor.com  
W: www.silopor.com  
Lisbon (Located on the south bank

in the Tagus River)  
Installed handling capacity: 2,200,000tpa.  
Equipment: 3 pneumatic unloaders (1,000 tph each) with two reversible lances, 4 loaders with two loading shovels each, Conveyor belt to the silos.  
Length of Quay: 210m+220m+240m+225m  
Depths: -7m/-14m/-13m/-17,5m ZH  
The deep water terminal of Trafaria is one of the largest in Europe, with a total storage capacity of 200.000 tonnes for grain, derived products, and oleaginous products and other agricultural foodstuffs. It receives Panamax and Capesize vessels.

**Lisbon**

**Sovena - Oilseeds Portugal, SA**

(Palença Bulk Foodstuffs Terminal)  
Palença de Baixo - Apartado 24  
Lisbon  
2801-801Almada  
Portugal  
Contact: Engº Lina Dionisio  
T: + 351 21 294 90 00  
F: + 351 21 294 90 19  
E: lina.dionisio@sovena.pt  
W: www.sovenagroup.com/  
Lisbon (Located on the south bank in the Tagus River)  
Installed handling capacity: 1,570,000tpa. Equipment: 2 pneumatic unloaders (600tph each), 1 mechanical unloader (900tph), 1 mobile loader for vessels (600tph), 1 barge loader (600tph), 2 pipelines of 10" and 1 of 6" (Quay no. 2), 1 pipeline of 10" (Quay no. 1).  
Length of Quay: 100m+180m  
Depths: -12,5m-15m ZH  
This terminal handles solid bulk

**In Group Guided by the Sea...**

<ul style="list-style-type: none"> <li>Atlanport</li> <li>Autopart</li> <li>Avanport</li> <li>ETE</li> <li>ETE Logística (AOL, Lixisul, Neosul)</li> <li>Eurulme</li> <li>Genivel Serviços</li> <li>Mais Seguros</li> <li>Marcopagos</li> <li>Mareport</li> <li>Navallogis</li> </ul>	<ul style="list-style-type: none"> <li>Navigrime</li> <li>Navex</li> <li>Operflis</li> <li>Portainers</li> <li>SBC</li> <li>SOCOMAR Aveiro</li> <li>Socarfe</li> <li>Softens</li> <li>STM (Navique)</li> </ul>	<ul style="list-style-type: none"> <li>TCGL</li> <li>TCL</li> <li>Transflis</li> <li>Transmarul</li> <li>Transmarul Açores</li> <li>Transmarul Madeira</li> <li>Transportes Siza e Mendes Vieira &amp; Silveira</li> </ul>
---------------------------------------------------------------------------------------------------------------------------------------------------------------------------------------------------------------------------------------------------------------------------------------	----------------------------------------------------------------------------------------------------------------------------------------------------------------------------------------------------------------	----------------------------------------------------------------------------------------------------------------------------------------------------------------------------------------------------------------------------

GRUPO E.T.E.

Largo do Corpo Santo, 21 | 1200-129 LISBOA | Tel. 211 128 000 | Fax 211 128 095 | info@ete.pt | www.ete.pt

(oleaginous seeds) and liquid bulk (edible oils).

## Lisbon

### TPB - SILOPOR SA

(Beato Silopor Terminal)  
R. Cintura do Porto de Lisboa  
Lisbon  
1900-263 Lisboa  
Portugal  
Contact: Mr Helder Cruz  
T: + 351 21 862 11 60  
F: + 351 21 862 03 08  
E: comercial@tmb.pt  
W: www.silopor.pt

Lisbon (Located on the north bank in the Tagus River)

Installed handling capacity: 252,000tpa  
Equipment: 3 Auto Cranes, respectively, de 70, 90 and 140 Ton, 6 6-Ton Electrical road cranes, 5 12-Ton Electrical road cranes, 31 electric/diesel forklifts; 4 loading shovels; 17 palette holders; 3 grain hoppers.

Length of quay: 500m

Depths: -6 e -7m ZH

5,500sqm

15,000sqm

The TMB receives all types of general cargo, and is equipped to handle breakbulk cargo and some types of solid bulk. Roles of paper, aluminium, fruit and sugar are the merchandise which is mostly handled here.

Short-sea vessels mainly moor here.

## Setubal

### Junta Autonoma Do Porto De Setubal

Pracaj De Republica

Setubal

2900

Portugal

Contact: Mr Antonio Reairo

T: + 351 265 235 667

F: + 351 265 534 622

E: suporte@mail.telepac.pt

W: www.cidadevirtual.pt

## Setubal

### Sadomar

Rua Praia Da Saude 231

Setubal

2900

Portugal

Contact: Mr Jose M Sardinha

T: + 351 65 2908

F: + 351 65 523 002

## Sines

### Porto de Sines SA

Apartado 16

Sines

750-953

Portugal

Contact: Ms Anna-Rita Rosa

Job Title: Marketing

T: + 351 269 860 600

F: + 351 269 860 790

E: ana.rosa@portodesines.pt

W: www.portodesines.pt

## Trafaria

### Trafaria Terminal - Silopor

Rua das Matas Nacionais

Trafaria

2825-867

Portugal

Contact: Mr Francisco Belo

Job Title: Manager

T: + 351 21 392 33 50/360

F: + 351 21 290 52 45

E: francisco.belo@silopor.com

W: www.silopor.pt

South Bank of Tagus River at

Lisbon's Harbour

Discharge: 3 Pneumatic mobil

shipunloaders with a rate of 1,000tph each.

Loading: Sea Going Vessels and Barges with a rate of 2, 000tph

Loading Trucks: 7 000tpd

Two intake quays for ships with 20m and 18m depths respectively,

able to receive ships up to 100000 dwt.

Not applicable

200,000 Tons in Vertical storage

with 114 separated Vertical Bins

HACCP and SGSA Implemented

NP EN ISO 22000:2005 Certified

## Vila Franca de Xira

### Alhandra Terminal- Cimpor

#### Industria de Cimentos SA

Centro de Produção de Alhandra

- Praçeta Teófilo de Araújo Rato,

Apartado 1

Vila Franca de Xira

2601-908 Alhandra

Portugal

Contact: Dr Ana Cristina Ascenso

T: + 351 21 940 87 00

F: + 351 21 940 87 33

E: aascenso@cimpor.com

W: www.cimpor.pt

Lisbon (Located on the north bank in the Tagus River)

Installed handling capacity:

430,000tpa

Equipment: Loading station for bulk

- 300tph

Length of Quay: 177m

Depth: -5m ZH

Licensed Area: 80,705sqm

Solid bulk cargo, destined for the

production of cement, is handled at

this terminal.

## PUERTO RICO

## San Juan

### Port of Ponce

Port of the Americas Authority

PO Box 362350

San Juan

00936-2350

Puerto Rico

Contact: Mr Thomas E Kierce

Job Title: Communications

Management Consultants

T: + 1 787 274 8181

F: + 1 787 274 0140

E: cmcorporation@cmc-pr.com

W: www.portoftheamericas.com

## San Juan

### Puerto Rico Port Authority

PO Box 362829

San Juan

PR 009366-2829

Puerto Rico

Contact: Mr Herman Sulsona

Job Title: Executive Director

T: + 1 787 29 8480

F: + 1 787 22 7867

## QATAR

## Doha

### Qatar Flour Mills Co

PO Box 1444

Doha

1444

Qatar

Contact: Mr Tarique Mohammad

Job Title: General Manager

T: + 974 4415000

F: + 974 4438137

E: qfmmgmt@qatar.net.qa

W: www.qatarflourmills.com

## Doha

### Umm Said Ports Authority

Mesaieed

PO Box 313

Doha

Qatar

Job Title: Harbour Master

T: + 974 457 457

F: + 974 413 563

E: harbourdohaport@qatar.net.qa

## REPUBLIC OF

## CONGO

## Pointe Noire

### Port Authority of Pointe Noire

PO Box 711

Pointe Noire

Republic of Congo

Job Title: Administration Officer

T: + 242 940052

F: + 242 942042

Lat: 4° 47' 4" S

Long: 11° 49' 58" E

Cargo pier max depth: 3.4m - 4.6m

## REPUBLIC OF

## GUINEA

## Conakry

### Conakry Port Authority

Direction du Port

PO Box 534

Conakry

Republic of Guinea

Contact: Mr M Doucoure

Job Title: Harbour Master

T: + 224 442737

F: + 224 412604

## Conakry

### Direction du Port de Kamsar

Office d'Amenagement -de-Boke

PO Box 820

Conakry

Republic of Guinea

Contact: Mr M.L Cisse

Job Title: Director

T: + 224 163 2117

F: + 224 163 2116

## Conakry

### Port Autonome de Conakry

PO Box 805

Conakry

Republic of Guinea

Contact: Mr Bangley Camara

Job Title: Director General

T: + 224 412 737

F: + 224 412 604

E: pac@eti-bull.net

## REPUBLIC OF

## YEMEN

## Hodeidah

### Hodeidah Port

Yemen Red Sea Ports Corporation

PO Box 3183

Hodeidah

Hodeidah

Republic of Yemen

Contact: Eng. Issa A. Hashem

Job Title: Executive Chairman

Chairman of the board

T: + 967 3 217064

F: + 967 3 211561

E: chairman@hodport.com

W: www.hodport.com

## REUNION

## Le Port Cedex, Reunion

## Direction Departementale de

### L'Equipment

2 Rue Evariste de Parry

PO Box 2002

Le Port Cedex, Reunion

97821

Reunion

Contact: Capt M Berthelot

Job Title: Harbour Master

T: + 262 420955

F: + 262 420602

## ROMANIA

## Agigea

### Silotrans SRL

Constanta Port - South

Agigea

Dobrogea

907015

Romania

Contact: Mr Djordje Krkijus

Job Title: Silo Manager

T: + 40 241 743350

F: + 40 241 743250

E: ConstantaSilotrans@chsinc.com

W: www.chsinc.com

## Braila

### Braila Port Authority

Harbour Master's Office

Gara Fluviala Street

Braila

Romania

Contact: Mr Vladut Branza

T: + 40 239 612 184

F: + 40 2 39 612066

E: capitania-braila@ma.ro

W: www.ma.ro

## Constanta

### Comvex SA

Incinta Port Dana 80-84

Constanta

900900

Romania

Contact: Mr Viorel Panait

Job Title: Terminal Manager

T: + 40 241 639 016

F: + 40 241 639 010

E: viorelpanait@comvex.ro

W: www.comvex.ro

Western Black Sea Coast

Three Shipunloaders 50t lifting

cap/2000tph discharging cap- each.

Four Stacker reclaimers. Three

barge loaders. One Railcars

loading terminal.

18m depth

17.5m SWAD

64 HA

Up to 3.0 mil mt storage capacity

simultaneously; sprinkler

installations for dust control; no

other restrictions for vessels sizes;

belt conveyors system with high

operational flexibility, full covered

transfer points and total length of

22km.

## Constanta

### SC MINMETAL SA Constanta / Romania



Moscow  
119002  
Russia  
Contact: Mr Alexander Aliev  
Job Title: Department Chief  
T: + 7 49 5735 4331  
F: + 7 49 5735 4331  
E: aar@portmc.ru  
W: www.vpnet.ru

**Murmansk**

**Port of Murmansk Authority**  
Portoviy Prezd 19  
Murmansk  
183024  
Russia  
Contact: Mr Dmitriev Alexander  
Job Title: Harbour Master  
T: + 7 8152 689 111  
F: + 7 8152 423 127  
E: mmtp@mmtp.ru  
W: www.murmansk.ru

**Nakhodka**

**Nakhodka Port Authority**  
22 Port Street  
Nakhodka  
Primorsky Krai  
692900  
Russia  
Contact: Mr Nikolay L. Pesotsky  
Job Title: Commercial Director  
T: + 7 4236 6198 35  
F: + 7 4236 6198 00  
E: nikolay.pesotsky@ncsp.ru  
W: www.ncsp.ru

**Nakhodka**

**VP- Vostochny Port**  
Wrangel-1  
Nakhodka  
Primorsky Krai  
692941  
Russia  
Contact: Mr Sergey N. Kushnarev  
Job Title: Chief of Marketing and Logistics Department  
T: + 7 4236 665 271  
F: + 7 4236 665 153  
E: vp@vpnet.ru  
W: www.vpnet.ru  
Far-East of Russia

**Novorossiysk**

**Novorossiysk Port Authority**  
2, Mira str.  
Novorossiysk  
Krasnodar Region  
353900  
Russia  
Contact: Mr Georgiy Antonyan  
Job Title: Harbour Master  
T: + 7 8617 602 516  
F: + 7 8617 676 378  
E: referent@nle.ru  
W: www.nle.ru

**St Petersburg**

**Seaport of St Petersburg JSC**  
Mezhevoy Kanal 5  
St Petersburg  
198035  
Russia  
Contact: Ms Alexandra Chaschina  
Job Title: Specialist of Department of PR and Advertising  
T: + 7 812 714 91 25  
F: + 7 812 714 94 98  
E: a.chaschina@seaport.spb.ru  
W: www.seaport.spb.ru  
North West Russia on the Baltic Sea  
56 gantry cranes up to 40 tons hoisting capacity, a floating crane of 300 tons capacity, 2 Liebherr mobile rubber-tyred cranes LHM 600 with the lifting capacity up to 140 tons, 1 truck-mounted crane with the lifting capacity of 55 tons, 244 different specialized loading mechanisms.

32 berths in disposal with total length 5,3 km and draught up to 11.5m  
412,000sqm  
46,000sqm  
The JSC "Seaport of St. Petersburg" is the largest operator providing dry cargo transshipment in Saint-Petersburg port and the North-West of Russia.

**Tuapse**

**Port of Tuapse Authority**  
8 Gorkogo Street  
Tuapse  
352800  
Russia  
Contact: Mr Oleg Antonov  
Job Title: General Director  
T: + 7 86167 76 4 00  
F: + 7 86167 76 4 03  
E: map@tuapseport.ru  
W: www.tuapseport.ru

**Ulgorsk**

**Ulgorsk Port Authority**  
Primouskaya ul 7  
Ulgorsk  
Russia  
Job Title: Port Manager  
T: + 7 42432 21771

**Vanino**

**Vanino Commercial Sea Port, PJSC**  
1 Zhelezodorozhnaya Str.  
Vanino  
Khabarovsk Territory  
682860  
Russia  
Contact: Mr Apollon Shengeliya  
Job Title: General Director  
T: + 7 421 37 5 09 23  
F: + 7 872 140 26 10  
E: market@vcsp.ru  
W: www.vcsp.ru

**Vanino**

**Vanino Port Authority**  
FEPCO, Khabarovsk Krai  
Ul Zelezodorozhnaya 1  
Vanino  
682860  
Russia  
Contact: Mr A G Briankina  
T: + 7 421 377 7799  
F: + 7 421 377 7575  
E: vanino.port@gjn.ru

**Vladivostok**

**Vladivostok Port Authority**  
Vladivostok Commercial Port  
9 Strelnikova Street  
Vladivostok  
690600  
Russia  
Contact: Mr Yuri Sidorenko  
Job Title: Marketing Director  
T: + 7 4232 495 222  
F: + 7 4232 222364  
E: office@gavmrp.vladivostok.ru  
W: www.vladcomport.ru

**Vyborg**

**Port of Vyborg Authority**  
Ulitsa Yuzhny Val 1  
Vyborg  
188900  
Russia  
Contact: Mr Ovechkin  
Job Title: Harbour Master  
T: + 7 812 782 0477  
F: + 7 812 783 2485  
E: mapvyb@vbg.spb.ru

**SAUDI**

**ARABIA**

**Dammam**

**Arabian Agricultural Services (ARASCO)**  
Dammam - Al-Khobar, Coastal Road  
PO Box 6977  
Dammam  
Eastern  
31452  
Saudi Arabia  
Contact: Mr Abdulaziz Abdulla Al-Fayez  
Job Title: Logistic President  
T: + 966 3 859 1171  
F: + 966 3 859 4474  
E: a.alfayez@arasco.com  
W: www.arasco.com

**Dammam**

**King Abdul Aziz Port Authority-Dammam**  
PO Box 28062  
Dammam  
Eastern Province  
31437  
Saudi Arabia  
Contact: Mr Abdullah Alhammad  
Job Title: Deputy Port Director  
T: + 966 3 858 3500  
F: + 966 3 858 3945  
E: kaap@ports.gov.sa  
W: www.ports.gov.sa

**Dammam**

**Ras Al Mishab**  
c/o Gulf Agency Company Saudi Arabia  
PO Box 335  
Dammam  
31411  
Saudi Arabia  
Contact: Mr Abdulla Al-Havage  
Job Title: Port Manager  
T: + 966 3 832 8762  
F: + 966 3 832 3035  
E: dammam@gacworld.com

**Jeddah**

**AJWA Port Services Co.**  
PO Box 16645  
Jeddah  
21474  
Saudi Arabia  
Contact: Mr Saleh N Al-Fadhli  
Job Title: General Manager  
T: + 966 264 712 50  
F: + 966 264 704 25 / 906 06  
E: snalfadhli@ajwa.com  
W: www.ajwagroup.com  
Jeddah Islamic Port and Yanbu Commercial Port.  
Both ports along the Red Sea coast of Saudi Arabia  
5 Grain ship-unloaders: capacity from 200 to 400tph at Jeddah & Yanbu. A large fleet of different cargo handling equipment including 1x 100 ton swl mobile harbor crane at Yanbu Commercial Port.  
Ajwa grain silos opp. Berth # 03 in Jeddah and 7 berths in Yanbu. Maximum draught at Yanbu is 14m. 65,000sqm in Yanbu.  
45,000sqm of shed & warehouse storage and 40,000t of vertical silos for dry bulk cargo storage in Yanbu.  
Bulk grain storage capacity at Jeddah port is 120,000t.  
Ajwa handles bulk grain at Jeddah port. At Yanbu port cargo handled includes containers, general, bulk, Ro-Ro & live-stock, while transshipment cargo enjoys 3 months demurrage free storage.

**Jeddah**

**Jeddah Islamic Port**  
PO Box 9285  
Jeddah  
21188  
Saudi Arabia  
Contact: Mr Sahir M Tahlawi  
Job Title: Port Director General  
T: + 966 2 647 1200 ext 2121 / 6477702  
F: + 966 2 647 7411  
E: jip@ports.gov.sa  
W: www.ports.gov.sa  
Red Sea Port, west coast of Saudi Arabia  
19 unloaders, pneumatic and mechanical, 100 - 600tph capacity  
5 x 250m long, 11.5 - 13.5m draught, 2 x 181m, 10.4 - 11.5m draught  
No storage of grains in open area 120,000t silos  
In addition, 2 unloaders should be in service within one year.

**Jizan**

**Jizan Port Management**  
PO Box 16  
Jizan  
Saudi Arabia  
Contact: Mr Abdul Hamid Saaddi  
Job Title: Director General  
T: + 966 7 317 1000  
F: + 966 7 317 0777  
E: info@ports.gov.sa

**Yanbu**

**Yanbu Commercial Port**  
Yanbu Port Management  
PO Box 1019  
Yanbu  
Al Bahr  
Saudi Arabia  
Contact: Mr A R Al-Khateeb  
Job Title: Port Director  
T: + 966 4 322 1163  
F: + 966 4 322 7643  
E: info@ports.gov.sa

**SENEGAL**

**Dakar**

**Port Autonome de Dakar**  
21 Boulevard de la Liberation  
PO Box 3195  
Dakar  
Senegal  
Contact: Mr Souleye Sall  
Job Title: Port Director  
T: + 221 234545  
F: + 221 233606  
E: pad@portdakar.sn

**SEYCHELLES**

**Victoria**

**Seychelles Ports Authority**  
PO Box 47  
New Port  
Mahe Quay  
Victoria  
Seychelles  
Contact: Captain Daniel Hoareau  
Job Title: Harbour Master  
T: + 248 224701  
F: + 248 224004  
E: enquiries@seychellesports.sc  
W: www.spa.sc

**SIERRA**

**LEONE**

**Cline Town**

**Sierra Leone Port Authority**  
PM Bag 386  
Cline Town

Freetown  
Sierra Leone  
Contact: Mr Helmut Friedrichs  
Job Title: General Manager  
T: + 232 22 250 111  
F: + 232 22 250 616

**Freetown**

**Pepel**  
c/o Marampa Iron Ore Mining Co  
PO Box 735  
Freetown  
Sierra Leone  
Job Title: Harbour Master  
T: + 232 24542

**Freetown**

**Sierra Leone Ports Authority**  
Queen Elizabeth II Quay  
PO Box 386  
Freetown  
Sierra Leone  
Contact: Capt P Schiffard  
Job Title: Director of Operations  
T: + 232 22 250111  
F: + 232 22 250616

**SINGAPORE**

**Jurong**

**Sembawang Terminal**  
c/o Port of Singapore Authority  
PO Box 300  
PSA Building Post Office  
Jurong  
0511  
Singapore  
Contact: Ms Karyn Yap  
Job Title: Marketing Manager  
T: + 65 274 7111  
F: + 65 274 4677

**Singapore**

**Jaldhi Overseas Pte Ltd**  
101 Cecil Street  
08-06 Tong Eng Building  
Singapore  
069533  
Singapore  
Contact: Mr Vira Chand Bothra  
T: + 65 6223 8929  
F: + 65 6223 8920  
E: vcb@jaldhi.com  
W: www.jaldhi.com/

**Singapore**

**Jurong Port Pte Ltd**  
37 Jurong Port Road  
Singapore  
619110  
Singapore  
Contact: Mr Achaibar Gupta  
Job Title: Senior Manager  
Corporate Communications  
T: + 65 6265 0666 / 66609582  
F: + 65 6261 4359  
E: achaibar@jp.com.sg  
W: www.jp.com.sg

**Singapore**

**LD Ports & Logistics**  
45A Club Street  
Singapore  
Singapore  
Singapore  
Contact: Mr Patrick Jourdain  
Job Title: General Manager  
T: + 65 6576 9877  
E: patrick.jourdain@oms.sg  
W: www.ldportslogistics.com

**Singapore**

**Maritime and Port Authority of Singapore**  
460 Alexandra Road  
# 19-00 PSA Building  
Singapore  
119963  
Singapore



[www.bulkconnections.com](http://www.bulkconnections.com)

**Bulk** *connections*





T: + 65 6375 1600  
F: + 65 6275 9247  
E: qsm@mpa.gov.sg  
W: www.mpa.gov.sg

**Singapore**

**Offshore Bulk Terminal Pte Ltd**  
50, Collyer Quay  
OUE Bayfront, #06-04  
Singapore  
049321  
Singapore  
Contact: Mr Stephen Suharya  
Job Title: Director  
T: + 65 6534 2928  
F: + 65 6509 5519  
E: marketing@obt-group.com  
W: http://www.obt-group.com

**Singapore**

**Sin Heng Chan (Singapore) Pte Ltd**  
Lot A 5052 Jurong Port  
Jurong Port Road  
Singapore  
619111  
Singapore  
Contact: Mdm Poon Poay Huang  
Job Title: General Manager  
T: + 65 6268 4711 ext 216  
F: + 65 6268 5711  
E: info@sinhengchan.com.sg  
W: www.sinhengchan.com.sg

**SLOVENIA**

**Koper**

**Luka Koper d.d., Dry Bulk Cargo Terminal**  
Vojkovo Nabrežje 38  
Koper  
SI-6501  
Slovenia  
Contact: Mr Ivan Peric  
Job Title: Director - Dry Bulk Cargo Terminal  
T: + 386 566 56 511  
F: + 386 566 56 509  
E: ivan.peric@luka-kp.si  
W: www.luka-kp.si  
Slovenian coast, the northernmost part of the Adriatic  
3x Gantry crane 16 ton; 1 kangeroo crane 16 ton  
3 Berths  
40,000mt  
80,000mt  
Different types of Minerals  
Quayside 525 m  
Sea depth 6 - 12,5 m  
Special capacities for Alumina  
Sea depth 9 m  
Berth1  
Storage capacity 20.000mt  
Our terminal is also specialized in handling and warehousing different kinds of cereals and fodder.

**SOUTH**

**AFRICA**

**Bishopsgate**

**South African Sugar Association**  
SA Sugar Terminal Department  
PO Box 61104  
Bishopsgate  
KZN  
4008  
South Africa  
Contact: Mr S Suleman  
T: + 27 31 365 8100  
F: + 27 301 1313  
E: shaffee.suleman@sasa.org.za  
W: www.sasa.org.za

**Durban**

**Bidfreight Port Operations (Pty) Ltd**  
PO Box 900  
Durban  
4000  
South Africa  
Contact: Ms Belinda Kruger  
Job Title: Executive Assistant & Corporate Communications  
T: + 27 31 274 2400  
F: + 27 31 205 4116  
E: marketing@bidports.co.za  
W: www.bidports.co.za  
All major ports in South Africa  
BPO offer an integrated port operations solution to customers importing or exporting in South Africa.

**Durban**

**Bulk Connections**



PO Box 21273  
Bluff  
Durban  
KwaZulu Natal  
4036  
South Africa  
Contact: Mr Iain Geldart  
Job Title: MD  
T: + 27 31 466 1960  
F: + 27 31 466 9667  
E: iaing@bulkconnections.com  
W: www.bulkconnections.com  
East Coast of South Africa  
Sized sensitive loading equipment.  
Capacity of 3.5 million tpa.  
Three berths, up to 10.3m deep  
Berth 3. Length 184m. Draught 8.8m.  
Berth 4. Length 220m. Draught 10.3m.  
140,000 sqm  
4,000 sqm  
Bulk Connections is an import/export, multi modal bulk terminal specialising in soft handling of cargo.

**Durban**

**Grindrod Terminals**



PO Box 1  
Durban  
KwaZulu Natal  
4000  
South Africa  
Contact: Mr Sean Rowan  
Job Title: CEO Grindrod Terminals  
T: + 27 31 302 7700  
F: + 27 31 302 7701  
E: seanr@grindrod.co.za  
W: www.grindrod.co.za

**Durban**

**Grindrod Terminals - Maydon Wharf**



34 Shadwell Road  
Maydon Wharf  
Durban  
Kwazulu Natal  
4001  
South Africa  
Contact: Mr Paul Leisegang  
Job Title: Regional Manager  
T: + 27 31 274 3270  
F: + 27 31 2743277  
E: paul@grindrod.co.za

W: www.grindrod.co.za  
South Africa - Kwazulu Natal  
Have access to 14 multi user berths of varying lengths. Draught of between 9m and 10.3m . Preferential berthing rights at one berth.  
Container terminal - in excess of 1300 container slots.  
Storage capacity of 150 000 tons (Bulk, Break Bulk and Bagged).  
Container handling and packing facilities. Intermodal warehouse and container yards - 176 655m2.

**Durban**

**South African Bulk Terminals LTD**

101 Maydon Road  
Maydon Wharf  
Durban  
KwaZulu Natal  
4001  
South Africa  
Contact: Mr Koos Smith  
Job Title: Managing Director  
T: + 27 31 327 5048  
F: + 27 31 304 6794  
E: koos.smith@sabulk.co.za  
W: www.bidvest.co.za  
Durban, South Africa  
MW5 - SKT 800 + 300 tph/ load 500 tph  
IV3 - Pneumatic(2) 640 tph/load 1500 tph  
MW5 200m/9.6m  
IV3 up to 255m/12.8m  
MW5 - 150 000 tonnes silo/bin  
IV3 - 69500 tonnes silos + 5650 vegetable oil storage tanks

**Durban**

**South African Sugar Association (Pty) Ltd**

PO Box 700  
Mount Edgecombe  
Durban  
KwaZulu Natal  
0300  
South Africa  
Contact: Mr Vino Naicker  
T: + 27 31508 7000  
F: + 27 31508 7189  
E: vinona@sasa.org.za  
W: www.sasa.org.za

**Durban**

**Transnet Port Terminals Head Office**

Kingsmead Office Park  
Stalwart Simelane/Stanger Street  
Durban  
KwaZulu Natal  
4001  
South Africa  
Contact: Ms Mbali Mathenjwa  
T: + 27 31 3088310  
F: + 27 31 308 8336  
E: Mbali.Mathenjwa@transnet.net  
W: www.transnetportterminals.net  
16 terminals situated in 7 commercial ports along South Africa's coastline.  
Transnet Port Terminals (previously South African Port Operations) is responsible for cargo handling and logistics services.

**East London**

**S A Port Ops East London Grain Terminal**

P O Box 101  
East London  
5200  
South Africa  
Contact: Mr Neil Pettifer  
T: + 27 43 700 2027  
F: + 27 43 700 2304  
E: neil.pettifer@transnet.net  
W: www.transnetnationalportsauthority.net

**East London**

**Transnet National Port Authority**  
PO Box 101  
East London  
5200  
South Africa  
Contact: Capt Naresh Sewnath  
Job Title: Port Captain  
T: + 27 43 700 1176  
F: + 27 43 700 2227  
E: naresh.newnath@transnet.net

**Johannesburg**

**Anglo Coal**  
PO Box 61587  
Marshalltown  
Johannesburg  
Gauteng  
2107  
South Africa  
Contact: Mr Kevin Martens  
Job Title: General Manager, Logistics  
T: + 27 11 638 5422  
F: + 27 11 638 5428  
E: kmartens@angloamerican.co.za  
W: www.angloamerican.co.uk

**Johansberg**

**National Ports Authority of South Africa (NPASA)**

30 Wellington Road  
Parktown  
Johansberg  
Gauteng  
2193  
South Africa  
Contact: Mr Pieter Smit  
Job Title: Marketing Manager  
T: + 27 11 351 9019  
F: + 27 11 351 9023  
E: pieters@npa.co.za  
W: www.npa.co.za

**Port Elizabeth**

**Portnet Port Elizabeth**  
P O Box 162  
Port Elizabeth  
6000  
South Africa  
Contact: Mr Manie Coetzee  
Job Title: Marketing  
T: + 27 41 507 2604  
F: + 27 41 558 383  
E: manie.coetzee@transnet.net  
W: www.transnet.net

**Port Elizabeth**

**Transnet Port Terminals**  
PO Box 162  
Port Elizabeth  
6000  
South Africa  
Contact: Ms Nandi Oliphant  
T: + 27 41 507 1824  
F: + 27 41 507 1801  
E: nandi.oliphant@transnet.net  
W: www.transnetportterminals.net  
Over 2 million tons annual throughput.  
Exports more than 1.7 million tons of manganese ore.  
4 berths  
Value-added services include packing and unpacking of containers, storage and additional logistics management.

**Richards Bay**

**Port of Richards Bay**  
PO Box 181  
Richards Bay  
KwaZulu Natal  
3900  
South Africa  
Contact: Mr Preston Khomo  
Job Title: Port Manager  
T: +27 35 905 3203  
F: +27 35 905 3333  
E: Preston.Khomo@transnet.net  
W: www.ports.co.za/richards-bay.php  
Located approximately 160km north-east of Durban and 465km

south of Maputo on the eastern seaboard of South Africa.  
Please see our website for more information - www.npa.co.za  
Please see our website for more information - www.npa.co.za  
Please see our website for more information - www.npa.co.za  
Please see our website for more information - www.npa.co.za  
The port's hinterland comprises the Northern Kwazulu Natal, Gauteng and Mpumalanga regions. The port boasts substantial bulk handling capacity, excellent rail/port connections, transshipment facilities and growing container handling facilities. It also offers easy access to South Africa's national road and rail network with substantial growth capacity in rail network link.

**Richards Bay**

**Richards Bay Coal Terminal**  
PO Box 56  
Richards Bay  
KwaZulu Natal  
3900  
South Africa  
Contact: Mr Ronald Llaie  
Job Title: Acting Corporate Affairs Manager  
T: + 27 35 904 4015  
F: + 27 35 907 7200  
E: rllaie@rbct.co.za  
W: www.rbct.co.za  
Eastern seaboard of South Africa.  
4x shiploaders, 6x stacker reclaimers, 2 stackers, 1 reclainer, 58m conveyor belt system up to 2.5m wide, travelling up to 22km/h  
301, 302, 303, 304, 305.  
Permissible draught 17.5m  
6.7 million tonnes  
Export capacity of 72 million tones per annum.  
Land surface area of 254,114 hectares

**Richards Bay**

**Transnet Port Terminals**  
Dry Bulk Terminal  
Customer Services Department  
PO Box 1793  
Richards Bay  
KwaZulu Natal  
3900  
South Africa  
Contact: Mr Warren Vickers  
Job Title: Customer Services Manager  
T: + 27 35 905 3105  
F: + 27 35 905 3216  
E: Warren.Vickers@transnet.net  
W: www.transnet.net  
The port of Richards Bay is located about 180 km north of Durban, South Africa.  
4 General purpose ship loaders (2,500tph)  
2 Pneumatic woodchip loaders (700 & 1,000 tph each)  
3 Grab unloaders (1,500 tph)  
3 Mobile harbour cranes (600 tph)  
2 Pneumatic unloaders (600 & 500 tph)  
Berth 609 - 300m - 14.0m draught  
Berth 701 - 240m - 14.0m draught  
Berth 702 - 300m - 17.5m draught  
Berth 703 - 240m - 17.5m draught  
Berth 704 - 240m - 17.5m draught  
Berth 705 - 280m - 17.5m draught  
Berth 801 - 260m - 17.5m draught  
Berth 804 - 260m - 17.5m draught  
Import: nil  
Export: Area ABC West : 3 x 50 000 ton; Area ABC East : 2 x 100 000 ton  
Import: 25 000m2 (shed)  
Export: 38 910m2 (sheds)  
Export: 120,600m3 (silos & storage bins)





# Experience the power of integrated freight logistics solutions

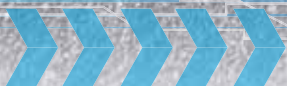

For comprehensive freight logistics, shipping and trading solutions for minerals, coal and ore. For a network of terminals strategically situated across southern Africa providing total cargo flow management from pit to port as well as storage, ship loading, discharging, stevedoring, clearing, forwarding and stock management. For a complete Corridor Management facility, expertly moving cargo by rail and road as well as a large modern fleet of dry bulk vessels operating worldwide. For specialist worldwide procurement, physical movement and distribution of industrial raw materials. We have the expertise, and capabilities to make it happen.



[www.grindrod.co.za](http://www.grindrod.co.za)



**Integrated logistics solutions from a single provider**



Over 13 million tonnes of bulk cargo is imported and exported via a fully computerised conveyor belt system, controlled from a central control room. 40 Km of conveyor belt links seven private harbour bound industries to the quayside operation of loading and discharging vessels. NB Vessels must ballast during discharge to maintain 18.0m max air-draught. Magnetite and Anthrasite also handled.

**Richard's Bay  
Grindrod Terminals**



PO Box 10744  
Meerensee  
Richard's Bay  
KwaZulu Natal  
3901  
South Africa  
Contact: Mr Christo Coetzer  
Job Title: Executive - Terminals  
T: + 27 35 797 9092  
F: + 27 35 797 9033  
E: christoc@grindrod.co.za  
W: www.grindrod.co.za  
South Africa - Kwazulu Natal  
4,0 million tons handled annually.  
Four different sites have the capacity to handle 5 million tons pa.  
Import: 3 berths (Max. vessel length x max. Draught depth) 1@ 240 x 13.5m, 1@ 220 x 13.5 and 1@ 260 x 17.0m Export: 5 berths (Max. vessel length x max. Draught depth) 2 @ 200 x 17.0m, 1@ 190 x 17.0 and 2 @ 230 x 17.0m.  
35,400m<sup>2</sup> Silo storage 79,000 tonnes @ cargo SG of 2.5 61,000m<sup>2</sup>  
Terminals are belt connected to the quayside for imports and exports. Grindrod is well equipped to handle all sorts of cargoes from tipping of trains, bulk storage, bagging of products and containerisation of cargoes.

**Saldanha**

**S A Port Ops**  
Private Bag X14  
Saldanha  
7395  
South Africa  
Contact: Mr Deon Julies  
Job Title: Business Unit Executive  
T: + 27 22 703 4710  
F: + 27 22 703 4832  
E: deon.julies@transnet.net

**Saldanha**

**Saldanha Bulk Terminal**  
Private Bag X8  
Saldanha  
4395  
South Africa  
Contact: Mr Christopher Gomez  
Job Title: Communications Manager  
T: + 27 22 703 4204  
F: + 27 22 703 4828  
E: christopherg@saportops.co.za

**SOUTH**

**KOREA**

**Cheju**

**Cheju Port Authority**  
918-30 Geonip-Dong  
Cheju  
South Korea  
Job Title: Port Manager

T: + 82 64 22 1754  
F: + 82 64 57 5002

**Donghae**

**Mukho Port Authority**  
Donghae District Maritime Port Administration  
Donghae  
South Korea  
Job Title: Port Manager  
T: + 82 394 521 7000  
F: + 82 394 521 0317

**Donghae City**

**Donghae Port Authority**  
806 Cheongok-dong  
Donghae City  
Gangwon  
240-716  
South Korea  
Contact: Mr K Nam  
Job Title: Port Manager  
T: + 82 33 533 3011  
F: + 82 33-533-1415  
E: info@portarea.com  
W: www.portdonghae.go.kr

**Inchon**

**Korea Silo Company Pier 7**  
3 1-KA Pukung-Dong  
Chung-Gu  
Inchon  
South Korea  
T: + 82 32 763 3211  
F: + 82 32 763 9178  
E: marcello\_b@yahoo.com  
W: www.koreasilco.co.kr

**Jung-gu**

**Incheon Port Authority**  
193 Seohaero  
1-17 Hang-dong 7 ga  
Jung-gu  
Incheon  
402-705  
South Korea  
Contact: Mr Lee Jeeong-Ryool  
Job Title: Port Management Division  
T: + 82 32 880 6114  
F: + 82 32 884 3563  
E: demigod@icpa.or.kr  
W: www.portincheon.go.kr/

**Kunsan**

**Changhang Port Authority**  
Kunsan Port Authority  
1-7 Jangmi-Dong  
Kunsan  
South Korea  
Job Title: Port Manager  
T: + 82 654 420660  
F: + 82 654 433217

**Kunsan**

**Kunsan Port Authority**  
1-7 Jangmi-Dong  
Kunsan  
South Korea  
Job Title: Port Manager  
T: + 82 654 420 660  
F: + 82 654 433 217

**Masan-South**

**Masan Port Authority**  
1-6 Wolpo-Dong  
Masan-South  
South Korea  
Job Title: Port Manager  
T: + 82 551 456177  
F: + 82 551 456179

**Nam Ku**

**Ulsan Port Authority**  
Ulsan District Maritime  
139-9 Maeam Dong  
Nam Ku  
Ulsan  
South Korea  
Job Title: Port Manager

T: + 82 522 614881  
F: + 82 522 614873

**Pohang**

**Pohang District Maritime & Port Authority**  
58-7 Hangku-Dong  
Pohang  
South Korea  
T: + 82 562 421881  
F: + 82 562 451623

**Pohang**

**Port of Pohang**  
Pohang District Maritime & Port Authority  
58-7 Hangku-dong  
Pohang  
South Korea  
T: + 82 562 421 812  
F: + 82 562 422 122

**Ulsan**

**Port of Ulsan Public Piers 1&2**  
Ulsan District Maritime and Port Authority  
139-9 Maeam-dong  
Ulsan  
South Korea  
Contact: Mr Jeong Chang-won  
T: + 82 52 228 5500  
F: + 82 52 228 5549  
W: www.ulsan.mltm.go.kr

**Yosu**

**Samil Port Authority**  
c/o Yosu District Maritime Port Authority  
335-2 Sojung-Dong  
Yosu  
South Korea  
Job Title: Port Manager  
T: + 82 662 624953  
F: + 82 662 645 436

**Yosu**

**Yoesu Port Authority**  
335-1 Sujeoung-dong  
Yosu  
South Korea  
Job Title: Port Manager  
T: + 82 61 660 9000  
F: + 82 61 662 4054  
W: www.yosu.momaf.go.kr

**SPAIN**

**Alicudia**

**Port of Alicudia**  
Autoridad Portuaria de Baleares  
Ed. Arranque Muelle Pesquero, s/n  
Alicudia  
Balearic Islands  
07410  
Spain  
Contact: Ms Teresa Alonso  
Job Title: Estrategic Plan Manager  
T: + 34 971 22 81 50 ext 241  
F: + 34 971 54 91 67  
E: portsdebalears@portsdebalears.com  
W: www.portsdebalears.com  
Eastern Mediterranean Sea.  
Balearic Islands Archipelago.  
North of Mallorca  
Muelle Ribera. Productos Asfálticos, S.A.. Betunes asfálticos, descarga por tubería, 3 silos en Muelle Ribera de 1.990 m<sup>3</sup>.  
Muelle Comercial. Portland de Mallorca. Cemento, descarga por tubería 200 Tn./hora  
Muelle Adosado 3.200 e.m. (coal)

**Algeciras**

**Port Authority of La Bahía de Algeciras**  
Apartado No7

Paseo de la Conferencia S/N  
Algeciras  
Cadiz  
11207  
Spain  
Contact: Mr Gerardo Landaluze  
Job Title: Marketing Manager  
T: + 34 9 56 58 54 00  
F: + 34 9 56 58 54 45  
E: glandaluze@apba.es  
W: www.apba.es

**Alicante**

**Port of Alicante**  
Muelle de Poniente 11  
Alicante  
03001  
Spain  
Contact: Mr Luis Charles Lopez  
Job Title: Marketing  
T: + 34 96 513 0134  
E: alicanteport@alicanteport.com  
W: www.alicanteport.com

**Almeria**

**Carboneras**  
c/o Autoridad Portuaria de AlmeriaMotril  
Muelle de Levante s/n  
Almeria  
04071  
Spain  
Contact: Mr Muelle Levante  
Job Title: Port Director  
T: + 34 9 50 23 60 33  
F: + 34 9 50 23 29 49  
E: almeria@apalmeria.com  
W: www.apalmeria.com/

**Almeria**

**Port of Almeria**  
Muelle Levante s/n  
Almeria  
04071  
Spain  
Contact: Mrs Trinidad Cabeo Rodriguez  
Job Title: President  
T: + 34 950 236 0033  
F: + 34 950 232 949  
E: tcabeo@apalmeria.com  
W: www.apalmeriamotril.com

**Asturias**

**Port Authority of Aviles**  
El Muelle 8  
Avile  
Asturias  
33400  
Spain  
Contact: Ms Cristina Lopez  
Job Title: Head of Marketing  
T: + 34 9 8 554 11 11  
F: + 34 9 8 554 04 79  
E: cristinal@puertoaviles.com  
W: www.puertoaviles.es

**Barcelona**

**Cemex España**  
01B Adossat Wharf  
Port of Barcelona  
Barcelona  
08039  
Spain  
Contact: Almodeno Lomillo  
Job Title: Marketing  
T: +34 918 00 78 00 / +34 902 23 63 93  
F: + 34 93 221 93 44  
W: www.cemex.es

**Barcelona**

**Ergansa**  
22B Contradic Est Wharf  
Barcelona  
Spain  
Contact: Mr Jordi Archs  
Job Title: General Manager and CEO  
T: + 34 93 2954580/4433716  
F: + 34 93 442 20 28

E: gerencia@ergransa.es  
W: www.ergransa.es

**Barcelona**

**Ergansa Terminal**  
11 Muelle Contradique  
Barcelona  
Spain  
Contact: Mr Jorge Arch Miquel  
T: + 34 93 295 45 80  
F: + 34 933 173 042  
E: gerencia@ergransa.es  
W: www.ergransa.es

**Barcelona**

**Moyresa Molturacion y Refino SA**  
23A Oest Wharf  
Port of Barcelona  
Barcelona  
08039  
Spain  
T: + 34 934 43 40 00  
F: + 34 934 41 05 16

**Barcelona**

**Port of Barcelona**  
WTC, Ed. Est, Moll de Barcelona s/n  
Barcelona  
08039  
Spain  
Contact: Mrs Norma de la Fuente  
Job Title: Communications & Institutional Relations Director  
T: + 34 9 3 306 88 00  
F: + 34 9 3 306 88 58  
E: norma\_dela Fuente@portdebarcelona.es  
W: www.portdebarcelona.es  
West Mediterranean

The Port of Barcelona has 6 companies dedicated to solid bulks:  
- Porcemen, S.A and Cemex España (Cement)  
- Ergansa (Grain)  
- Cargill España, S.A and Moyresa/Bunge (Soya products)  
- Tramer, S.A (Potash)  
1422 m.l  
38,192sqm approx.  
17,659sqm approx.  
Total surface: 138,035sqm

**Barcelona**

**Portcemen, SA**  
22c Contradic Wharf  
Port of Barcelona  
Barcelona  
08039  
Spain  
Contact: Mr Eduard Duran  
Job Title: Managing Director  
T: + 34 93 443 05 14  
F: + 34 93 443 10 29  
E: portcemen@entorno.es  
W: www.portcemen.com

**Barcelona**

**Tramer SA**  
01B Adossat Nord Wharf  
Port of Barcelona  
Barcelona  
08039  
Spain  
T: + 34 93 442 19 40  
F: + 34 93 443 20 73  
E: tramer@iberposash.com

**Bilbao**

**Autoridad Portuaria De Bilbao**  
Campo De Volantin 37  
Bilbao  
Bizkaia  
48007  
Spain  
Contact: Mr Julio Burgos  
Job Title: Desarollo Comercial  
T: + 34 94 487 1200  
F: + 34 94 487 1410  
E: jburgos@bilbaoport.es  
W: www.bilbaoport.es

Inner quays: Nemar, Adosado & Princesa docks  
Outer Abra: AZ1 & Punta Sollana docks

Inner quays: 2 overhead gantries of 35t, 7 luffing cranes of 16t  
Outer Abra quays: 2 on tyre wheel cranes of 105 & 140t, 1 mobile crane of 25t, conveyor belts for grains (2,000 tph) and clinker (1,000 tph), continuous loader for sulphate (700 tph)  
Inner quays: total length 1,027m, draught 14m.  
Outer Abra quays: total length 1,250m, draught 21m.  
220,100sqm  
53,800 + silos for grain with 100,000t of storage capacity  
Industrial installations: grinder for oil seeds, clinker mill, drying shed for coke.

## Cádiz

### Cádiz Bay Port Authority

Plaza de España 17  
Cádiz  
11006  
Spain  
Contact: Ms Kate Bonet  
Job Title: Marketing Manager  
T: + 34 9 56 24 04 00  
F: + 34 9 56 24 04 76  
E: cadiz@puertocadiz.com  
W: www.puertocadiz.com

## Cartagena

### Port Authority of Cartagena

Plaza Heroes de Cavite s/n  
Cartagena  
Murcia  
30201  
Spain  
Contact: Mr Fernando Munoz  
Job Title: Commercial Director  
T: + 34 9 68 32 58 00  
F: + 34 9 68 32 58 15  
E: fmunoz@apc.es  
W: www.apc.es  
0° 59' O Longitude 37° 35' N  
Latitude  
South East of Spain on the South Mediterranean Coast  
Escombreras Basin  
ISO 9001/2008- Certification in solid bulks traffic, general merchandise traffic, container and Cruiser.  
ISO 14001:2004 - Environmental management system  
EMAS - Certificate  
OHSAS 18001 :2007 - Management system of health and safety

- 7 x 100 T mobile cranes capable of operating at both quays.  
- Cranes of 40T, 30T and 12T  
Principe Felipe E004: Length 180m, Draught 11.9m.  
Principe Felipe E005: Length 175m, Draught of 13.2m  
Principe Felipe E006: Length 175m, Draught 13.72m  
Isaac Peral E007: Length 240m, Draught 13.72m  
Isaac Peral E008: Length 240m, Draught 13.72m  
Muelle Sur E023: Length 301m, Draught 21m  
Muelle Sur E024: Length 302m, Draught 21m  
Total Bulk Berth 1869 m (linear meters without special installation)  
Total Bulk Berth 456 m (linear meters with special installation)  
Dique-SW E025: Length 411 m, Draught 26 m (Shelter dock, waiting ships)  
Dique -SW E026: Length 411 m, Draught 26 m (Shelter dock, waiting ships)  
224,741 sqm  
86,060 sqm

Industrial and logistics activities area: 28 Ha

## Cartagena

### Port of Aguilas

Port Services Parque 1 entresuela  
Cartagena  
Murcia  
Spain  
Contact: Mr Pedro Albadalejo  
Job Title: Port Manager  
T: + 34 9 68 36 24 98  
F: + 34 9 68 36 23 27

## Ferrol

### Port Authority of Ferrol – San Cibrao

Muelle Curuxeiros s/n  
Ferrol  
A Coruña  
15401  
Spain  
Contact: Mr Julio Hernández  
Job Title: Commercial Manager  
T: + 34 981 338 064  
F: + 34 981 33 80 01  
E: jhernandez@apfsc.es  
W: www.apfsc.es  
North West of Spain  
Quays, cranes, berths, warehouses, etc.  
Draughts up to 20 meters

## Ferrol

### Port Authority of Ferrol-San Ciprian

Muelle de Curuxeiros s/n  
Ferrol  
15401  
Spain  
Contact: Mr Miguel Villalobos  
Job Title: Port Director  
T: + 34 981 369 155  
F: + 34 9 981 35 31 74  
E: ferrol@ferrol.portel.es  
W: www.porto-ferrolsanqiprian.com

## Formentera

### Port of La Savina

Autoridad Portuaria de Baleares  
Passeig de la Marina, s/n  
Formentera  
Balearic Islands  
07870  
Spain  
Contact: Ms Teresa Alonso  
T: + 34 91 32 21 30  
F: + 34 91 32 21 30  
E: portsdebalears@portsdebalears.com  
W: www.portsdebalears.com  
Eastern Mediterranean Sea  
Balearic Islands Archipelago. North of Formentera

## Garrucha

### Garrucha

Empresa Publica de Puertos de Andalucía  
Puerto Pesquero de Garrucha  
Garrucha  
Almería  
04630  
Spain  
Contact: Mr AF Romero  
Job Title: Port Director  
T: + 34 9 50 46 02 36  
F: + 34 9 50 13 26 36

## Gijón

### EBHI - European Bulk Handling Installation

Muelle Marcelino León s/n  
El Musel  
Gijón  
Asturias  
33212  
Spain  
Contact: Mr Laureano Lourido  
Job Title: Managing Director  
T: + 34 985 308 507

F: + 34 985 308 123  
E: llourido@ebhi.es  
W: www.ebhi.es  
North coast of Spain.  
17 Million tons per year capacity with a maximum daily throughput of 100,000 tons.  
No LOA / DWT limitation. 18m draught (60 feet)  
260,000sqm

## Gijón

### Port Authority of Gijón

Claudio Alvargonzalez 32  
Gijón  
Asturias  
33201  
Spain  
Job Title: President  
T: + 34 985 17 96 07  
F: + 34 985 35 99 17  
E: comunicacion@puertogijon.es  
W: www.puertogijon.es  
Northwest of Spain on the Cantabrian Sea (Atlantic coast) 5° 41'W 43°34'N  
28 cranes ( 3 cranes of 2.200 tph)  
Main bulk terminal for coal and iron ore: EBHISA (EUROPEAN BULK HANDLING INSTALLATION)  
Length: 800 m.  
Draught: 270 m with 20m. depth at L.W.O.S.T. and 530 m with 21 m depth at L.W.O.S.T.  
2,569,402 sqm  
60,459 sqm  
EBHISA is an enterprise owned by Port of Gijón -more than 80%- with other regional companies.

## Huelva

### Port Authority of Huelva

Avda Real Sociedad Colombina  
Onubenso 1  
Huelva  
21001  
Spain  
Contact: Mr Enrique P Gomez  
Job Title: Director  
T: + 34 9 59 21 31 00  
F: + 34 9 59 21 31 01  
E: aph@puertohuelva.com  
W: www.puertohuelva.com

## Ibiza

### Port of Ibiza

Autoridad Portuaria de Baleares  
Moll Interior, 1  
Ibiza  
Balearic Islands  
07800  
Spain  
Contact: Ms Teresa Alonso  
T: + 34 971 31 06 11  
F: + 34 971 31 04 00  
E: portsdebalears@portsdebalears.com  
W: www.portsdebalears.com  
Eastern Mediterranean Sea  
Balearic Islands Archipelago. South of Ibiza

## La Coruña

### Muelle del Centenario

Autoridad Portuaria de la Coruna  
Avda de la Marina 3  
La Coruña  
15002  
Spain  
Contact: Mr Luis Felipe Fernandez  
Rueda  
T: + 34 981 22 74 02  
F: + 34 9 81 205 862  
E: explotacion@puertocoruna.com  
W: www.puertocoruna.com

## La Coruña

### Port Authority of La Coruña

Avenida de la Marina 3  
La Coruña  
15001

Spain  
Contact: Ms Marta Rodríguez  
Pantín  
Job Title: Commercial Unit Manager  
T: + 34 981 219 621  
F: + 34 981 219 600  
E: mrodrig@puertocoruna.com  
W: www.puertocoruna.com  
North West of Spain  
More than 1000 m long  
32,000sqm  
66,400sqm  
New outer port in Punta Langosteira for bulks (250 ha surface; 22 m draft; 900 m long).

## La Coruña

### T.M.G.A. SL

Cuesta de la Palloza  
1-Entlo  
La Coruña  
15006  
Spain  
Contact: Mr Juan Ibanez  
Job Title: Managing Director  
T: + 34 981 175690  
F: + 34 981 227556  
E: jibanez@mconsiflet.com  
W: www.tmga.es

## La Coruña

### Terminales Maritimos de Galicia, S.L.

Muelle Calvo Sotelo S/N  
La Coruña  
15006  
Spain  
Contact: Mr Iago Mallo Sanz  
Job Title: Technical Manager  
T: + 34 981 12 61 69  
F: + 34 981 12 22 35  
E: imallo@tmga.es  
W: www.tmga.es  
North West of Spain on the North Coast

## Los Barrios

### Endesa

PO Box 11  
Los Barrios  
Cádiz  
11370  
Spain  
Contact: Mr Francisco Aamoros  
Job Title: Commercial Department  
T: +34 6256 04 167  
F: + 34 956 6782 11  
E: info@unesa.es

## Madrid

### Ership S.A.U

5th Floor  
Lagasca 88  
Madrid  
28001  
Spain  
Contact: Mr Jorge Alvargonzalez  
Job Title: Shipbroker  
T: + 34 91 4263400  
F: + 34 91 5757565  
E: jorge.alvargonzalez@ership.com  
W: www.ership.com

## Madrid

### Puertos del Estado

Avda.del Partenon, 10  
Campo de las Naciones  
Madrid  
28042  
Spain  
Contact: Mr Jose Maria Sanchez Segovia  
T: + 34 91 524 55 00  
F: + 34 91 524 55 01  
E: presidencia.puertos@puertos.es  
W: www.puertos.es

## Mahón

### Port of Mahón

Autoridad Portuaria de Baleares  
Moll de Llevant, 1

Mahón  
Balearic Islands  
07701  
Spain  
Contact: Ms Teresa Alonso  
T: + 34 971 36 30 88/66  
F: + 34 971 36 31 01  
E: portsdebalears@portsdebalears.com  
W: www.portsdebalears.com  
Eastern Mediterranean Sea  
Balearic Islands Archipelago. East of Menorca  
Muelle Cos Nou. Valenciana de Cementos. 2 Silos cemento de 1.500 Tn. de capacidad, 1 silo de 1.900 Tn.  
Muelle Cos Nou 58.945 e.m.

## Malaga

### Malaga Port Authority

Muelle de Canovas s/n  
Malaga  
29001  
Spain  
Contact: Mr Sebastian Camps  
Job Title: Managing Director of Malagaport A.I.E  
T: + 34 952 125 013  
F: + 34 952 125 014  
E: info@malagaport.net  
W: www.malagaport.net  
Southern Spain, 80 miles from the Strait Gibraltar  
Total: 6,210 metres (ro ro ramps, containers, dry and liquid bulk, fishing and cruises berths)  
Docks 5, 6 and 7  
353,498sqm  
4,884sqm

## Marin

### Ceferino Nogueira SA

Avenida Oresense 1-B  
Marin  
Pontevedra  
36900  
Spain  
Contact: Mr Ceferino Nogueira Garcia  
T: + 34 986 88 0600  
F: + 34 986 88 4776  
E: info@nogar.es

## Melilla

### Port Authority of Melilla

Avda of Spanish Navy No 4  
Melilla  
52001  
Spain  
Contact: Mr Alejandro Suarez  
Job Title: Marketing Department  
T: + 34 952 673 600  
F: + 34 952 674 838  
E: asuarez@puertodemelilla.es  
W: www.puertomelilla.com

## Motril

### Motril Port - Granada

c/Recinto Portuario s/n  
Motril  
Granada  
18613  
Spain  
Contact: Ms Jessica Martin  
T: + 34 958 601 207 ext 160  
F: + 34 958 601 234  
E: jmartin@motrilport.com  
W: www.apmotril.es  
South East Spain, Strait of Gibraltar  
Promotion and commercialization  
Port of Motril-Granada

## Motril

### Port of Motril

C/ Recinto Portuario, S/N  
Motril  
Granada  
18613  
Spain  
Contact: Mr Domingo Reyes Martín



Job Title: Operations & Port Services  
 T: + 34 958 60 12 07  
 F: + 34 958 60 12 34  
 E: dreyes@apmotril.com  
 W: www.apmotril.com  
 South East Spain, Strait of Gibraltar, Alboran Sea  
 2 cranes, 350 and 250 tph  
 607 / 260m length, 12/10m depth  
 683,929sqm  
 6,174sqm  
 Please see our website  
 www.apmotril.com for more details

**Palma**

**Port of Palma**  
 Autoridad Portuaria de Baleares  
 Muelle Viejo 3  
 Palma  
 Balearic Islands  
 07012  
 Spain  
 Contact: Mr M Ginard  
 Job Title: Head of Marketing  
 T: + 34 971 22 81 50  
 F: + 34 971 72 69 48  
 E: mginard@portsdebaleares.com  
 W: www.portsdebaleares.com  
 Eastern Mediterranean Sea  
 Balearic Islands Archipelago. South of Mallorca  
 Dique del Oeste - 2ª alineación. Silos y almacenes Baleares, S.A.. 3 Silos de cemento de 3.800 Tn. de capacidad, 1 toma de descarga de 200 Tn./hora  
 Dique del Oeste - 2ª alineación. Cemex España, S.A.. 3 Silos de cemento de 3.800 Tn. de capacidad, 1 toma de descarga de 200 Tn./hora  
 Muelle de Ribera-18.644 e.m.  
 Muelle de Ribera 4.651 e.m. (Grain/Agribulk)

**Pasaia**

**Port Authority of Pasaia**  
 Edificio Transatlántico, Zona Portuaria s/n  
 Apartado 56  
 Pasaia  
 Gipuzkoa, Basque Country  
 20110  
 Spain  
 Contact: Mr Gorka Reizabal  
 Job Title: Press and PR Department  
 T: + 34 943 35 18 44  
 F: + 34 943 35 01 41  
 E: greizabal@puertopasajes.net  
 W: www.puertopasajes.net  
 North Spain, Bay of Biscay  
 43° 19' 15,82" N.  
 01° 55' 15,98" W.

**Pto. Alcudia**

**Transportes Marítimos Alcudia, SA**  
 Teodoro Canet No 26  
 Pto. Alcudia  
 Mallorca-Baleares  
 07400  
 Spain  
 Contact: Mr Miguel Oliver  
 Job Title: Managing Director  
 T: + 34 971 545 932/28  
 F: + 34 971 547 356  
 E: moliver@tmalcudia.com  
 W: www.portsdebaleares.com

**Sagunto**

**Port of Sagunto**  
 Autoridad Portuaria de Valencia  
 Muelle Centro SN  
 Sagunto  
 46520  
 Spain  
 Contact: Mr Ramon Izquierdo  
 Job Title: Port Administrator  
 T: + 34 96 269 9002  
 F: + 34 96 3268 0972

E: psagunto@valenciaport.com

**Santa Cruz de Tenerife**

**Port Authority of Tenerife**  
 Avenida Francisco La Roche No 49  
 Santa Cruz de Tenerife  
 Canary Islands  
 Spain  
 Contact: Mr Manuel Fernandez del Castillo  
 Job Title: Port Director  
 T: + 34 9 22 605400  
 F: + 34 9 22 605479  
 E: comercial@puertosdetenerife.org  
 W: www.puertosdetenerife.org

**Santander**

**Port Authority of Santander**  
 Muelle de Maliaño s/n  
 Santander  
 Cantabria  
 39009  
 Spain  
 Contact: Ms Sophie Lanos  
 Job Title: Marketing Assistant  
 T: + 34 942 203600  
 F: + 34 942 203632  
 E: comercial@puertosantander.com  
 W: www.puertosantander.com  
 Situated on Europe's Atlantic Coast, on the largest bay in northern Spain, in the Cantabrico's sea.  
 16 Portal cranes: 1x 16-35t, 62.5-312.5 tph; 10x 16t, 62.5-312.5 tph; 4x 12t, 25-150 tph, 1x 35t, 4x 50/80 t mobile cranes  
 CADEVESA-CANTABRIASIL: Total area 10.441sqm; Length 180m; Width 37m; Depth 8m.  
 NUEVA MONTAÑA-GLOBA: Total Area 10.474sqm; Length 218m; Depth 5m.  
 RAOS 1: Total area 98.107sqm; Length 300m; Depth 13m.  
 RAOS 2: Total area 66.964sqm; Length 208m; Depth 13m.  
 RAOS 3: Total area 151.303sqm; Length 569m; Depth 13m.  
 RAOS 4: Total area 43.402sqm; Length 356m; Depth 13m.  
 RAOS 5: Total area 15.000sqm; Length 335m; Depth 10m.  
 Dry bulk cargo terminal - the only completely indoor terminal in the world; highly computerized, state of the art equipment, high performance, minimal emissions into the atmosphere. Unloading capacity: 2,250 tph, 20,000 tpd.  
 758,651sqm  
 122,772sqm  
 Solid Bulks  
 2008: 3,732,466 Tons  
 2009: 2,919,749 Tons

**Santander**

**Puerto de Santander**  
 Autoridad Portuaria de Santander  
 Muelles de Maliaño s/n  
 Santander  
 Cantabria E390 09  
 Spain  
 Contact: Mr José Joaquín Martínez Sieso  
 Job Title: Chairman  
 T: + 34 942 20 36 00  
 F: + 34 942 20 36 33  
 E: info@puertosantander.com  
 W: www.puertosantander.com  
 North of Spain on the north Cantabrian coast.  
 Water Depth 13m  
 Panamax  
 1.76m  
 911,768sqm  
 160,498sqm  
 - Santander to Madrid 393 kilometers. tax free.  
 - High intermodal accessibility  
 - Multipurpose port.Last generation terminals

**Sevilla**

**Port Authority of Sevilla**  
 Avenida de Molini No 6  
 Sevilla  
 41012  
 Spain  
 Contact: Mr Manuel A. Fernandez González  
 Job Title: President  
 T: + 34 954 24 73 00  
 F: + 34 954 24 73 33  
 E: sevilla@apsevilla.com  
 W: www.apsevilla.com

**Tarragona**

**Berge Maritima**  
 Tarragona  
 Spain  
 Contact: Mr. Daniel Vega  
 T: + 34 977 55 05 00  
 F: + 34 977 48 43 82  
 E: consignacion.tar@berge-m.es  
 W: www.berge-m.es

**Tarragona**

**Codemar-Iberbulk**  
 Muelle de Castilla, s.n.  
 Tarragona  
 43004  
 Spain  
 Contact: Mr Luis Fernández  
 Job Title: General Manager  
 T: + 34 9 77 21 5273  
 F: + 34 9 77 22 98 53  
 E: lfernandez@codemar-iberbulk.es  
 W: www.codemar-iberbulk.es  
 North East of Spain in the Mediterranean Coast. South of Barcelona. Distance to Barcelona 100km.  
 Limitation according to the public information by the Port Authority of Tarragona.  
 Out 34,000 sqm covered flat stores  
 Conveyor belts running from quayside to three of five flat stores in our facilities at the Muelle de Castilla yard.

**Tarragona**

**Euroports Iberica TPS**  
 Aptdo. Correos 839  
 Tarragona  
 Tarragona  
 43080  
 Spain  
 Contact: Mr Javier Herrera  
 Job Title: Commercial Manager  
 T: + 34 977 22 22 19  
 F: + 34 977 22 04 59  
 E: jherrera@europortsiberica.com  
 W: www.euroports.com  
 North Mediterranean coast of Spain  
 Unload: 24,000t/day for coal, 14,000t/day for agribulk  
 Draught from 18.5m to 13.2m  
 160,000sqm  
 70,000sqm  
 Handling Pulp, Steel and all type of General Cargo, developing at this step a new specialized terminal.

**Tarragona**

**Port Authority of Tarragona**  
 Passeig de l'Escullera s/n  
 Tarragona  
 43004  
 Spain  
 Contact: Mr Pedro Bernal  
 Job Title: Commercial Manager  
 T: + 34 977 259 400  
 F: + 34 977 241 372  
 E: omercial@porttarragona.cat  
 W: www.porttarragona.cat

**Tarragona**

**Silos de Tarragona SA (SITASA)**  
 Muelle Castilla s/n Ap.160  
 Tarragona  
 43080

Spain  
 Contact: Mr Joan Marc Papiro  
 Job Title: Director  
 T: + 34 977 259 500  
 F: + 34 977 259 530  
 E: jmpapiro@silostgna.com  
 W: www.silostgna.com

**Torreveja**

**Torreveja Port Authority**  
 Esplanada del Mar s/n  
 Torreveja  
 Spain  
 Job Title: Port Director  
 T: + 34 96 571 0234  
 F: + 34 96 571 0234

**Valencia**

**Inst Portuarios de Estudios**  
 Puerto de Málaga  
 Muelle de Cánovas  
 Valencia  
 46024  
 Spain  
 Contact: Mr Ramon Gomez-Ferrer Boldova  
 Job Title: Director  
 T: + 34 952 125 011  
 F: + 34 952 125 014  
 E: iep@puertomalaga.com  
 W: http://www.puertomalaga.com/

**Valencia**

**Port Authority of Valencia**  
 Av. Muelle del Turia s/n  
 Valencia  
 46024  
 Spain  
 Contact: Ms Francesca Antonelli  
 Job Title: Marketing Manager  
 T: + 34 9 6 393 95 00  
 E: fantonelli@valenciaport.com  
 W: www.valenciaport.com  
 Spain's Eastern Mediterranean Coastline

**Vigo**

**Port Authority of Vigo**  
 Plaza de la Estrella, 1 (VIGO)  
 Vigo  
 E-36201  
 Spain  
 Contact: Ms Dolores Rois  
 Job Title: Commercial Director  
 T: + 34 9 86 26 80 00  
 F: + 34 9 86 26 80 01  
 E: drois@apvigo.es  
 W: www.apvigo.es

**Vilagarcía de Arousa**

**Port of Vilagarcía**  
 Peirao de Pasaxeiros, 1  
 Vilagarcía de Arousa  
 Pontevedra  
 36600  
 Spain  
 Contact: Mr Juan Diego Perez Freire  
 Job Title: Director Manager  
 T: + 349 86 565 129 / +349 06 565921  
 F: + 349 86 507923  
 E: juandiego@portovilagarcia.com  
 W: www.portovilagarcia.com  
 Northwest of the Iberian Peninsula. Ria of Arousa.  
 Dry bulks by special installation and Dry bulks without special installation  
 80,200sqm  
 109,692sqm  
 During the year 2005, Vilagarcía Port moved 1,184,178 tonnes

**Vilagarcía de Arousa**

**Autoridad Portuaria de Vilagarcía de Arousa**  
 Avenida de la Marina, 15  
 Vilagarcía de Arousa  
 36600  
 Spain

Contact: Ms Patricia González Núñez  
 Job Title: Jefa de Unidad de Relaciones Externas  
 T: + 34 986 56 59 20  
 E: comunicacion@portovilagarcia.es  
 W: www.portovilagarcia.es  
 North West of Spain, on the Atlantic coast of Galicia  
 10 lines of quay, 9 crane onto rails, 2 mobile high-tonnage cranes, pipelines systems for liquid bulks and for cement.  
 - For solid bulks by specific installation: 303 linear metres, depth 13 m.  
 - For solid bulks without specific installation: 2.665 linear metres, depth max. 13m., min. 7m.  
 124,017sqm  
 96,416sqm  
 The Port enjoys a privileged location in a wide, sheltered bay, and has excellent communications by road and railway. The nearest airports are about 45 min. distant.

**SRI LANKA**

**Galle**

**Galle Port**  
 Sri Lanka Ports Authority  
 Cloisenberg Jetty  
 Magalla  
 Galle  
 Sri Lanka  
 Job Title: Harbour Master  
 T: + 94 11 242 1201  
 F: + 94 11 244 0651  
 E: webmaster@slpa.lk

**ST PIERRE &**

**MIQUELON**

**Saint-Pierre and Miquelon**  
**Saint-Pierre Harbour**  
 Quai de l'Alysse  
 BP 4217  
 Saint-Pierre and Miquelon  
 97500  
 St Pierre & Miquelon  
 Contact: Mr Enrique Perez  
 Job Title: Harbour Master  
 T: + 11 508 410 974  
 F: + 11 508 410 979  
 E: enrique.perez@equipement.gouv.fr  
 W: www.saint-pierre-et-miquelon.developpement-durable.gouv.fr  
 The North Atlantic Ocean, south of the Canadian province of Newfoundland and Labrador.  
 5 mobile cranes (5t-20t capacity).  
 Wheel crane (70 t).  
 3 wharfs up to 170sqm long.  
 Draught: 6m-8.5m  
 17,500sqm  
 2,800sqm in warehouse

**ST VINCENT**

**& THE**

**GRENADINES**

**Kingstown**

**Kingstown**  
 St Vincent Port Authority  
 PO Box 1237  
 Kingstown  
 St Vincent & The Grenadines  
 Contact: Mr Brennan B King  
 Job Title: Harbour Master  
 T: + 1809 4561830  
 F: + 1809 45626732

E: portsvg@mail.caribsurf.com

## SUDAN

### Port Sudan

#### Sea Ports Corporation

PO Box 531  
Port Sudan  
Sudan  
Contact: Eng Ibrahim A. Ahmed  
Job Title: General Manager  
T: + 249 2910  
F: + 249 2127  
E: ohag\_ohag@hotmail.com  
North East coast. 1200 miles south  
swiscanal-Egypt  
16 quay cranes, 6 STS gantry, 15  
RTG, 46 handling facilities with  
average loading capacity 3-50 tons  
4 berths - overall length 861m,  
depth 16m for each  
850,000m  
1,350,000m  
New projects for container berths  
and Suakin Port, livestock &  
vegetables loading new terminal  
under construction.

## SULTANATE OF OMAN

### Muscat

#### Oman Flour Mills Co SAOG

PO Box 566  
Ruwi-112  
Muscat  
Sultanate of Oman  
Contact: Mr Ali Habaj  
Job Title: General Manager  
T: + 968 24711155  
F: + 968 24714711  
E: flour@omantel.net.om  
W: www.omanfoumills.com

### N. Azaiba

#### Port of Duqm

4th Floor, Almarshreq Building  
18 November Street  
N. Azaiba  
Sultanate of Oman  
Contact: Mr Peter Broers  
Job Title: CEO  
T: + 968 24 587 343  
F: + 968 24 342 800  
E: info@portduqm.com  
W: www.portduqm.com

## SURINAME

### Paramaribo

#### N.V. Havenbeheer Suriname

Suriname Ports Management  
Company  
Havenlaan Zuid #5  
Paramaribo  
Suriname  
Contact: Mr John A. Defares  
Job Title: Managing Director/CEO  
T: + 597 40 2375  
F: + 597 40 3691  
E: smeport@sr.net  
Nieuwe Haven  
Within the Capital (Paramaribo)  
about 20 km up stream of the  
"Suriname river".  
Cranes with lifting capacity of 100  
tons  
No special Bulk facilities  
8.9 ha  
Temporary shed about 2,000sqm  
The port is nearing the finalization  
of a rehabilitation process. In 2010  
more covered storage space will be  
created.

## SWEDEN

### Gavle

#### Port of Gavle Authority

Fredriksskans  
Gavle  
805 95  
Sweden  
Job Title: Port Director  
T: + 46 26 17 88 44 dct  
F: + 46 26 14 09 79  
E: info@gavlehamn.se  
W: http://www.gavle-port.se/

### Göteborg

#### Port of Göteborg

Nordatlauten  
Gate 5  
Göteborg  
SE 403 38  
Sweden  
Contact: Ms Susan Hansel  
Job Title: Media Relations officer  
T: + 46 31 731 23 25  
F: + 46 31 731 22 03  
E: eva.jonasson@portgot.se  
W: www.portgot.se

### Halmstad

#### Halmstad Port

PO Box 1  
Halmstad  
301 02  
Sweden  
Contact: Ms Bergitta Johansson  
Job Title: Production Manager  
T: + 46 35 15 53 14  
F: + 46 35 14 05 93  
E: birgitta.j@porthalmstad.com  
W: www.halmstadharbour.se

### Helsingborg

#### Helsingborg Coal Terminal

PO Box 821  
Helsingborg  
S-25108  
Sweden  
Contact: Mr Andreas Eriksson  
Job Title: Information Officer  
T: + 46 4210 6300  
F: + 46 4212 4374  
E: andreas.eriksson@  
port.helsingborg.se  
W: www.port.helsingborg.se

### Helsingborg

#### Helsingborgs Hamn, Port of

Helsingborg  
Oceangatan 3  
PO Box 821  
Helsingborg  
SE 251 08  
Sweden  
Contact: Mr Kjell-Åke Ranft  
Job Title: Sales Manager  
T: + 46 42 10 63 00  
F: + 46 42 28 22 99  
E: kjell.ranft@port.helsingborg.se  
W: www.port.helsingborg.se  
Swedish southwest coast  
Handles fiberfuels and for the local  
powerplant.

### Helsingborg

#### Lantmännen, Farmers Assoc.

Massgodsleden  
Helsingborg  
252 25  
Sweden  
Contact: Mr Claes Nilsson  
Job Title: Operations Manager  
T: + 46 42 19 57 00  
F: + 46 42 14 87 86  
E: claes.nilsson@lantmannen.com  
W: www.lantmannen.se

### Husum

#### Husum Port

Mo ch Domsjö AB  
Harbour Department, Husum Mill

Husum  
890 35  
Sweden  
Contact: Mr Conny Sallander  
Job Title: Port Manager  
T: + 46 660 78714  
F: + 46 660 299 028  
E: conny.sallander@ovikshamn.se  
W: www.ornskoldsvikshamn.se/

### Kalmar

#### Kalmar Hamn AB (Port of

Kalmar)  
PO Box 810  
Kalmar  
391 28  
Sweden  
Contact: Mr Carl-Johan Nordheim  
Job Title: Managing Director  
T: + 46 480 45 14 50  
F: + 46 480 45 14 58  
E: info@kalmarhamn.se  
W: www.kalmar.se/kalmarhamn  
South East Coast of Sweden  
7 mobile cranes, 15-36 tonnes  
capacity  
max depths 7.7m  
75,000sqm  
13,000sqm

### Karlshamn

#### Port of Karlshamn

PO Box 8  
Karlshamn  
374 21  
Sweden  
Contact: Mr Bjorn Nilesen  
Job Title: Marketing Manager  
T: + 46 454 30 50 00  
F: + 46 45 48 10 40  
E: info@karlshamnshamn.se  
W: www.karlshamnshamn.se

### Karlstad

#### Vänerhamn AB

Stuvargatan 1  
Karlstad  
652 21  
Sweden  
Contact: Mr Tobias Uhn  
Job Title: Sales Manager  
T: + 46 54 14 48 60  
F: + 46 54 21 33 16  
E: tobias.uhn@vanerhamn.se  
W: www.vanerhamn.se  
Five modern ports at lake Vänern,  
strategically located in the heart of  
Sweden. Ports are Vänersborg,  
Lidköping, Otterbäckan,  
Kristinehamn and Karlstad. Well-  
developed infrastructure and  
excellent opportunities for  
combining sea transport with road  
and rail.  
11 railborne, 4 fixed and 6 mobile  
crane, Heavy lift crane 200 tonnes.  
Forklifts, loading machines and  
bobcats.  
argest vessel size 88 x 13,20 x  
5,40 m (Vänernmax)  
312,000 sqm  
109,000 sqm

### Kristinehamn

#### Kristinehamn Port

Hamnvagen 6A  
Kristinehamn  
681 30  
Sweden  
Contact: Mr Carlerik Holmlin  
Job Title: Harbour Master  
T: + 46 550 87750  
F: + 46 550 83897  
E: carlerik.holmlin@vanerhamn.se

### Lulea

#### Port of Lulea

Stromovagen 9  
Lulea  
SE 974 37

Sweden  
Contact: Mr Roger Danell  
Job Title: Port Director  
T: + 46 9204 53000  
F: + 46 920 25 55 94  
E: leif.berg@hamn.lulea.se  
W: http://www.lulea.se/hamnen

### Lysekil

#### Port of Lysekil

Hamnkontoret  
Lysekil  
S-453 80  
Sweden  
Contact: Mr Olle Samuelson  
Job Title: Harbour Master  
T: + 46 523 14090  
F: + 46 523 14094  
E: olle.samuelson@lysekil.se  
W: www.lysekilhamn.se  
West of Sweden  
Cranes, Hopper, Fork-lifts etc  
30,000sqm  
30,000sqm

### Malmö

#### Copenhagen Malmö Port AB

Terminalgatan 18  
Box 566  
Malmö  
S-201 25  
Sweden  
Contact: Mr Soren Balken  
Job Title: Marketing Coordinator  
T: + 46 40 680 4100  
F: + 46 40 180 501  
E: soren.balken@cmport.com  
W: www.cmport.com  
Copenhagen Malmö Port is located  
in the Øresundregion with terminals  
in both Denmark and Sweden.  
CMP: 3 stationary cranes 20 tons  
1 mobilecrane 64 tons, capacity  
12,000 tonnes of coal a day  
1 multidocker 8.5 tons, 1 Fuchs  
CMP facilities:  
Swede Harbour/1001,1002 - 200 m  
- 13.5 m  
Södra Bulk/ 740, 750, 751 - 6.0 m  
Prövestenen/855,856,857,858,859,  
860,861 - 679 meters - 10.5 - 6.0 m  
Private operators:  
Amagerværket/835,836,837,838 -  
440 meters - 12.0 m  
Margreteholm/825 - 140 meters -  
6.0 m  
Kalkbrænderihavnen/401,402 - 230  
m - 6.7 m  
Approx 500,000 sqm  
28,500 sqm  
A new 180,000sqm terminal for bulk  
is constructed. Terminal has 650m  
of quay with a water depth of  
11.4m.

### Oxelsund

#### Oxelosunds Hamn AB

Box 1200  
Oxelsund SE-61324  
Sweden  
Contact: Mr Bo Ytterstrom  
Job Title: Marketing Manager  
T: + 46 155 258 000  
F: + 46 1553 4321  
E: bo.ytterstrom@oxhamn.se  
W: www.oxhamn.se  
Draught 15.3m. Max LOA 265m.  
Max Beam 41m.

### Södertälje

#### Port of Sodertälje

PO Box 2016  
Södertälje  
151 02  
Sweden  
Contact: Mr Erik Froste  
Job Title: Managing Director  
T: + 46 8 55 02 37 40  
F: + 46 8 55 03 19 49  
E: info@soeport.se  
W: www.soeport.se

### Sonderhamn

#### Sonderhamn Port

Strandgatan 4  
Sonderhamn  
826 60  
Sweden  
Contact: Mr Tommi Eriksen  
Job Title: Harbour Master  
T: + 46 270 28 41 32  
F: + 46 270 28 41 26  
E: info@ssh.se

### Stockholm

#### Port of Hargshamn

742 50 Hargshamn  
Stockholm  
Sweden  
Contact: Mr Hakan Nilsson  
Job Title: Port Director  
T: + 46 173 20155  
F: + 46 173 20311  
E: hakan.nilsson@hargshamn.se  
W: www.hargshamn.se

### Uddevalla

#### Uddevalla Port

Uddevalla Hamnterminal AB  
PO Box 543  
Bastiongatan 5  
Uddevalla  
451 21  
Sweden  
Contact: Mr Ulf Stenberger  
Job Title: Harbour Master  
T: + 46 522 912 04 / + 46 522 91244  
F: + 46 522 33630  
E: ulf.stenberger@uddevalla-hamn.se  
W: www.stockholmshamn.se

### Västerås

#### Mälarenhamn AB

Box 3013  
Västerås  
720 03  
Sweden  
Contact: Mr Magnus Johansson  
Job Title: Sales Manager  
T: + 46 21 150100  
F: + 46 21 150145  
E: magnus.johansson@  
malarhamnar.se  
W: www.malarhamnar.se  
In the lake of Mälaren we have two  
ports, one in Köping and one in  
Västerås, Sweden  
Cranes, loaders, Rechstackers,  
trucks, etc.  
7 berths  
100,000sqm  
55,000sqm  
Receiving ships up to 7,000 tons  
net weight. Ongoing investments to  
receive 13,000 tons. Reaching 1/3  
of Swedens population within 200  
km radius (3 million people).

### Ystad

#### Port of Ystad

Bornholmsgatan 6  
Ystad  
Scania  
27139  
Sweden  
Contact: Mr Michael Törnfeldt  
Job Title: Operational Manager  
T: + 46 411 577 661  
F: + 46 411 749 50  
E: michael.tornfeldt@ystad.se  
W: www.port.ystad.se  
Ystad is situated on the south coast  
of Sweden. N55 - 24,5 - E 013 -  
43'  
Cranes: 1 mobile, capacity 40  
tons.  
Stevedoring: Ystad Stevedores,  
fork trucks (max 7 tons), terminal  
tugmasters, bobcats and loading  
machines.  
Bulk, ferry and industrial port  
guarantees a water depth of 7.2m  
at normal tide levels. Water depth  
in the anchorage basin 15m.



Quays: Length 1.100 m. Load allowed 2-3 t./m<sup>3</sup>. Axle pressure 10/16 t. 1,000m railway tracks in the dock area.  
Warehouses: The Port Administration: 4.500 sqm, Ystades Stevedores 2.200 sqm and Pol-Line 400 sqm  
The Port of Ystad is ISPS certified.

**SWITZERLAND**

**Basel**

**Port of Switzerland**  
Hochbergerstrasse 160  
Basel  
CH-4019  
Switzerland  
Contact: Ms Nina Hochstrasser  
Job Title: Communication Officer  
T: + 41 61 639 9597  
F: + 41 61 639 9514  
E: nina.hochstrasser@portof.ch  
W: www.port-of-switzerland.ch  
North West of Switzerland  
60 cranes  
7 km, 3.2 m  
200,000 sqm  
250,000 sqm  
Container terminals, distribution centers, tank storage, elevators

**Basel**

**Rhenus-Alpina AG**

Basel  
Switzerland  
Contact: Ms Claudia Bracher  
T: + 41 61 639 33 33  
F: + 41 61 639 34 66  
E: info@rhenus.ch

**Basel**

**Ultra-Brag AG**

Südquaistrasse 55  
Basel  
CH-4019  
Switzerland  
Contact: Mr Beat Heydrich  
Job Title: CEO  
T: + 41 61 639 72 00  
F: + 41 61 639 72 10  
E: info@ultra-brag.ch  
W: www.u-b.ch  
Ports of Basel, Switzerland (City of Basel, Birsfelden, Auhafen)  
Various cranes up to 600mt lifting capacity  
25,000sqm  
30,000sqm  
3 silos for storage of up to 90,000mt grain and animal feeds

**Birsfelden**

**BIRS Terminal AG**

Hafenstrasse 54  
Postfach  
Birsfelden  
CH 4127  
Switzerland  
Contact: Ms Sabine Schmid  
T: + 41 61 377 8032  
F: + 41 61 377 8010  
E: sabine.schmid@birsterminal.ch  
W: www.birsterminal.ch

**Lugano**

**Interbulk**

Via Bagutti 6  
Lugano  
6904  
Switzerland  
Contact: Mr Michele Caffarena  
Job Title: International Terminals Department  
T: + 41 91 911 37 41  
F: + 41 91 911 37 29  
E: m.caffarena@interbulk.ch

**SYRIA**

**Lattakia**

**Lattakia General Port Company**  
PO Box 220  
Baghdad Street  
Lattakia  
Syria  
Contact: Mr Mdhath Abou Al-Shamlat  
Job Title: General Manager  
T: +963 41 476452  
F: +963 41 475760  
E: info@bahharshipping.com

**Tartous**

**Tartous Port Authority**  
PO Box 86  
Tartous  
Syria  
Contact: Eng. Zaki-E Najib  
Job Title: Port Manager  
T: + 963 43 313 752  
F: + 963 43 315 602  
E: ta-pco@mail.sy  
W: www.tartousport.com

**TAIWAN**

**Hualien**

**Hualien Port**  
Hualien Harbour Bureau  
No 66 Hai-Ann Road  
Hualien  
Taiwan  
Contact: Mr Li Keh-Shul  
Job Title: Harbour Bureau Director  
T: + 886 38 325131  
F: + 886 38 333757  
E: lly@mail.hlhb.gov.tw  
W: www.hlhb.gov.tw

**Kaohsiung**

**Kaohsiung Harbour Bureau**  
No. 62  
Lin Hai 2nd Rd  
Kaohsiung  
Taiwan  
Contact: Mr Ting-Yi Tsai  
Job Title: Harbour Manager  
T: + 886 7 562 2100  
F: + 886 7 521 6915  
E: p04685@mail.khb.gov.tw  
W: www.khb.gov.tw  
South West coast of Taiwan  
18 cement silos (278,000t), 2 grain silos (180,000t), 1 coal silo (80,000t)  
20 dry bulk cargo wharves  
6 open storage yards (44,885sqm)  
50 warehouses (221,662sqm)

**Keelung**

**Keelung Port Authority**

Keelung Harbour Bureau  
Port Building  
1 Chung Cheng Road  
Keelung  
202  
Taiwan  
Contact: Mr Han Te An  
Job Title: Director  
T: + 886 2 428 1156  
F: + 886 2 428 5613  
E: dttd200@klhb.gov.tw  
W: www.jlhb.gov.tw

**Mai Liao**

**Mai Liao Harbour Administration Corp**  
No 1-1 Formosa Industrial Complex  
Mai Liao  
Yunlin County  
638  
Taiwan  
T: + 886 5681 2766  
F: + 886 5681 2135  
E: captliow@fpg.com.tw  
West South West of Taiwan  
1x grab type/12,000tpd, 2x bucket



type/15,000tpd, 4x screw type/25,000tpd  
E2, E3, E4, E5  
Other commodities handled - industrial salt.

**Suao Port Building**

**Su-Ao Port Authority**

Su-Ao Harbour Bureau  
3rd Floor  
Suao Port Building  
Suao  
Taiwan  
Contact: Mr Kuo-Hung Yeh  
Job Title: Port Manager  
T: + 886 39 972001  
F: + 886 39 952739  
E: srdykh@klhb.gov.tw

**Taichung**

**Port of Taichung, Asia Cement Berth**

Taichung Harbour Bureau  
Wuchi  
Taichung  
Taiwan  
Contact: Mr CT Huang  
Job Title: Director  
T: + 886 4 656 2611  
F: + 886 4 656 5703

**Taichung**

**Taichung-Wharf No 1**

Pei Heng 11 Road  
Ching Shui Chen  
Taichung  
Taiwan  
T: + 886 4 656 4211  
F: + 886 4 656 8069

**Taipei**

**Eastern Media International Corporation**

8th Floor  
Yu Tai Enterprise Building  
368 Fu Hsing South Road  
Section 1  
Taipei  
106  
Taiwan  
Contact: Mr Michael LY Pan  
Job Title: Executive Vice President  
T: + 886 2 2755 7565  
F: + 886 2 2702 8079  
E: spokesman@emic.com.tw  
W: www.emic.com.tw

**Wuchi**

**Taichung Port Authority**

Taichung Harbour Bureau  
Harbour Building  
Wuchi  
Taichung District  
Taiwan  
Contact: Mr C T Huang  
Job Title: Director  
T: + 886 4 656 2611  
F: + 886 4 656 5702  
E: director@mail.tchb.gov.tw  
W: www.tchb.gov.tw

**TANZANIA**

**Dar es Salaam**

**Tanzania Harbours Authority**

Bandari Street  
PO Box 9184  
Dar es Salaam  
Tanzania  
Contact: Mr Flavian Kinunda  
Job Title: Director of Marketing  
T: + 255 22 2115559  
F: + 255 22 2115559  
E: kinunda@tanzaniaports.com

**Dar es Salaam**

**Tanzania Ports Authority**

Dar es Salaam Port  
PO Box 1130  
Dar es Salaam  
Tanzania  
Contact: Mr Iddi Mkwata  
Job Title: Port Manager  
T: + 255 22 2113642  
F: + 255 22 2113646  
E: pmdsm@tanzaniaports.com  
W: www.tanzaniaports.com  
Latitude 6.5 and Longitude 39.17  
East Coast of East Africa  
General cargo Terminal- Mobile cranes 63T, 35T, Portal cranes, Tractors, Trailers, Frontloader, Forklifts, bagging units, hoppers, etc.  
2 berths, designed water depth of 12.2m., length of 183m.each.  
82,700sqm  
66,900sqm

**Kurasini**

**Grindrod Terminals - Dar Es Salaam**



Bandari Road, Plot 2A,  
Mission to Seafarer's Compound  
Annex Building Ground Floor  
Kurasini  
Dar Es Salaam  
Tanzania  
Contact: Mr Peter Buchholz  
Job Title: Regional Manager  
T: + 255 22 213 3848  
F: + 255 22 213 3848  
E: peterb@grindrod.co.tz  
W: www.grindrod.co.za  
East coast of Africa in Tanzania  
15 000 million tons bulk sulphur can be handled per vessel

Berth No7  
Shed No 4 2700m2  
Currently discharge, store and bag commodity. Handle 80 000 tons of sulphur pa but have the capability of handling other commodities such as Nickel, copper concentrate, Ingots, Manganese ore and Fertilizer.

**THAILAND**

**Bangpli**

**S.P. Intermarine Co., Ltd**  
150/90 Moo 3 Soi Wongsepap  
Teparak Road (Km.10)  
Bangpli Yai  
Bangpli  
Samutprakram  
10540  
Thailand  
Contact: Mr Krithep Suwanajakorn  
Job Title: Marketing Department  
T: + 662 385 5335  
F: + 662 385 5910  
E: info@spintermarine.co.th  
W: www.spintermarine.co.th  
Gulf of Thailand  
4 VERSA MAX transshipment stations.  
10 high-speed floating cranes.  
Commodity-specific grabs.  
Transshipment capacity up to 2,000 TPH.  
More than 2,000,000 metric tons of various cargoes per year..  
Suitable for all agri and industrial bulks.

**Sattahip**

**Sattahip Port Authority**

102/21 Moo 6 Plutalaung  
Sattahip  
Cholburi Province  
Thailand  
Job Title: Port Director  
T: + 66 38 43134850  
F: + 66 38 431261

**Singhanakorn**

**Chaophaya Terminal International Co. Ltd**

Songkhla Port  
Moo 7, Huakao  
Singhanakorn  
Songkhla  
90280  
Thailand  
Contact: Mr Jun Tao  
Job Title: Port Director  
T: + 66 74 3310738  
F: + 66 74 331199  
E: info.skp@ctic.co.th  
W: www.ctic.co.th

**THE GAMBIA**

**Banjul**

**The Gambia Ports Authority**

Liberation Ave  
Banjul  
The Gambia  
Contact: Miss Naffi Macdougall  
T: + 220 229940  
F: + 220 227268  
E: info@accessgambia.com  
W: www.accessgambia.com/



# coal meets Europe

Welcome to the port of Amsterdam. Where coal meets Europe. As Europe's second-largest coal port, Amsterdam is a leading player within the business. The existing large and flexible terminals - offering custom made solutions - attract a substantial share of Europe's need for 'import coal'. And the demand is rising. The port of Amsterdam is ready to accommodate this market growth and has the ambition to do so in a sustainable manner. Amsterdam has a unique logistic location within the world's largest energy hub: the ARA range (Amsterdam, Rotterdam, Antwerp). Situated in

Europe's largest delta the port of Amsterdam offers a dynamic international hub with a sea-entrance-draft up to 17.8 meters and excellent hinterland connections for inland shipping, rail and road. All together an excellent location for your coal business.

Want to know more about the port of Amsterdam where coal meets Europe?

Go to [www.portofamsterdam.com](http://www.portofamsterdam.com) or contact our Commercial Division, Cluster Energy directly via [lex.de.ridder@portofamsterdam.nl](mailto:lex.de.ridder@portofamsterdam.nl)



**THE  
NETHERLANDS**

**Amsterdam**

**Amfert**  
Fosfaatweg 48  
PO Box 313  
Amsterdam  
1000 AH  
The Netherlands  
Contact: Mr Rainer Marx  
Job Title: Logistics & Purchasing  
Manager  
T: + 31 20 581 5100  
F: + 31 20 686 8328  
E: marx@amfert.nl  
W: www.amfert.nl

**Amsterdam**

**B.V. Bouwgrondstoffen AGM**  
Amerikahavenweg 12  
Amsterdam  
1045 AD  
The Netherlands  
Contact: Mr Lennard Marth  
Job Title: Terminal Manager  
T: + 31 20 614 7821  
F: + 31 20 614 5984  
E: l.martha@paes-nl.com

**Amsterdam**

**Civil and Marine Nederland**  
Amerikahavenweg 11  
Amsterdam  
1045 AA  
The Netherlands  
Contact: Mr Lennard Marth  
Job Title: Operations Director  
T: + 31 20 614 7928  
F: + 31 20 614 7918  
E: hanson-dc@wxs.nl

**Amsterdam**

**Graham - Grondstoffen Exp.  
Amsterdam (Arc Marine)**  
Amerikahavenweg 14  
Amsterdam  
1045 AD  
The Netherlands  
Contact: Mr Koos Van Der Steen  
Job Title: Commercial Manager  
T: + 31 20 614 6949  
F: + 31 20 613 4959

**Amsterdam**

**Maja Stuwadoors Rotterdam**  
PO Box 57196  
Amsterdam  
1040 BB  
The Netherlands  
Contact: Mr Arie Holleman  
T: + 31 20 684 2194  
F: + 31 20 684 7024  
E: info@majastuwadoors.nl  
W: www.majastuwadoors.nl  
Port of Amsterdam, Rotterdam,  
Netherlands  
Floating operation with floating  
cranes in the ports of Amsterdam  
and Rotterdam. Operating with 8  
floating cranes with capacities upto  
1.000 mtp. Approx. 4 million tons  
a year throughput.  
Capesize vessels discharging on  
the buoys

**Amsterdam**

**Oba - Bulk Terminal Amsterdam**  
Westhavenweg 70  
Amsterdam  
1042 AL  
The Netherlands  
Contact: Mr Hans Fijlstra  
Job Title: Managing Director  
T: + 31 20 587 3700  
F: + 31 20 611 6908  
E: directie@oba-bulk.nl  
W: www.oba-bulk.nl

Amsterdam North Sea  
4 gantry cranes: 60t, 50t, 2x 30t.; 1  
floating crane: 50t; 1 floating  
weighing tower;  
2 Stackers; 2 Reclaimers;  
Conveyor belt systems with  
powerful magnetic separators; 1  
ship loader (coaster); 2 barge  
loaders; 1 Train loader.  
1,200m quay  
600,000sqm  
25,000sqm  
Annual volume 20 million tonnes.  
Products handled: Coal, Agribulk,  
Minerals, Biomass.  
Additional services: Mixing,  
crushing, screening.  
All transport modalities: Ships from  
Capes to Coasters, barges, rail,  
road.

**Amsterdam**

**Port of Amsterdam**



Harbour Building  
De Ruijterkade 7  
PO Box 19406  
Amsterdam  
N-Holland  
1000 GK  
The Netherlands  
Contact: Mr Lex de Ridder  
Job Title: Commercial Manager Unit  
Bulk  
T: + 31 20 523 4577  
F: + 31 20 523 5077  
E: lex.de.ridder@portofamsterdam.nl  
W: www.portofamsterdam.com  
The Netherlands  
Amsterdam is one of Europe's  
leading dry bulk ports. Dedicated  
bulk terminals in all fields of drybulk  
logistics offer their flexible, personal  
services; for further information see  
above contact details.

**Amsterdam**

**Rietlanden Terminals BV**  
PO Box 59191  
Amsterdam  
1040KD  
The Netherlands  
Contact: Mr Karl Schot  
Job Title: Managing Director  
T: + 31 20 506 1144  
F: + 31 20 613 0724  
E: karl.schot@rietlanden.com  
W: www.rietlanden.com  
Amsterdam  
5 floating cranes  
60 hectares

**Badhoevedorp**

**IGMA**  
Schipholweg 337 D  
Badhoevedorp  
1171 PL  
The Netherlands  
Contact: Mr Rob Hansen  
Job Title: General Manager  
T: + 31 20 5801 613  
F: + 31 20 5808 606  
E: info@igma.nl  
W: www.igma.nl  
Port of Amsterdam  
5 cranes/ 2 siwertells/2 suckers  
5 berths for capes/panamax  
50,000sqm  
140,000sqm

**Botlek**

**Borax Rotterdam N.V.**  
Welplaatweg 104  
Botlek  
Rotterdam  
3197 ZG  
The Netherlands  
Contact: Mr van der Linde



Job Title: General Manager  
T: + 31 10 490 9600  
F: + 31 10 416 0023  
E: boraxrotterdam@borax.com

E: haulich@jewometaal.com  
W: www.jewo.com

**Delfzijl**

**Aldel - Aluminium Delfzijl**  
PO Box 133  
Delfzijl NL 9930 AC  
The Netherlands  
Contact: Mr S Fokkens  
T: + 31 0596 638357  
F: + 31 0596 638402  
E: info@aldel.nl  
W: www.aldel.nl  
North East of The Netherlands  
Smelter 110KT

**Delfzijl**

**Groningen Seaports**  
Handelskade Oost 1  
Postbus 20004  
Delfzijl  
9930 PA  
The Netherlands  
Contact: Mr Jannes Stokroos  
Job Title: Director Shipping  
T: + 31 59 66 40 400  
F: + 31 59 66 30 464  
E: j.stokroos@groningen-  
seaports.com  
W: www.groning-seaports.com

**Botlek**

**Jewometaal Stainless Processing**  
Quebecstraat 7  
Botlek  
Rotterdam  
3197 KL  
The Netherlands  
Contact: Mr Henk Aulich  
Job Title: Managing Director  
T: + 31 181 242 424  
F: + 31 181 242 425

**HUDIG  
VEDER | SINCE 1795**

**International  
Shipping &  
Forwarding**

---

**Your solution for mineral logistics  
Bulk & Breakbulk**

- ◆ Short sea / deep sea chartering
- ◆ Ships agencies
- ◆ Barging
- ◆ Stevedoring
- ◆ Storage
- ◆ Door-to-door logistics
- ◆ Cargo inspection, supervision
- ◆ Weight / draught surveys
- ◆ Sampling, preparation and analysing
- ◆ Customs clearance
- ◆ GMP+ and ISO 9001 certified

**Hudig & Veder Bulk B.V.**  
Debussystraat 2  
3161 WD Rhoon  
The Netherlands  
T: +31 10 5066600 E: bulk@hudigveder.nl  
F: +31 10 5012819 W: hudigveder.nl





## European Bulk Services Rotterdam



### European Bulk Services (E.B.S.)B.V.

Elbeweg 117 ▶ Europoort Rotterdam ▶ Port no. 5820 ▶ P.O. Box 1204 ▶ 3180 AE ▶ Rozenburg ▶ The Netherlands  
T +31(0)181-258121 ▶ F +31(0)181-258154 ▶ E [sales@ebsbulk.nl](mailto:sales@ebsbulk.nl) ▶ W [www.ebsbulk.nl](http://www.ebsbulk.nl)



**Dordrecht**

**BV Zeehavenbedrijf Dordrecht**  
(ZHD Stevedoring)



PO Box 12  
Dordrecht  
3300 AA  
The Netherlands  
Contact: Mr Leo Lokker  
Job Title: Commercial Director  
T: + 31 78 61 11 009  
F: + 31 78 63 32 815  
E: leo.lokker@zhd.nl  
W: www.zhd.nl  
Rotterdam, Dordrecht and Moerdijk  
15 cranes - 8 up to 50 tons lifting capacity (incl. 3 self-propelled floating cranes)  
Dordrecht 1.750m draught 31'  
Moerdijk 950m draught 28'  
(Lightening in Rotterdam possible with floating cranes)  
LOA: 201 m.  
Beam: 32,5 m.  
150.000 sqm  
80.000 sqm  
ZHD is an independent stevedoring company operating in Dordrecht, Moerdijk and Rotterdam. ZHD has large expansion plans, which includes development of 18 hectares "green field" (31' draught) and construction of new warehouses.

**Dordrecht**

**Port Authority of Dordrecht**  
Menwekade 56  
Dordrecht  
3311 TH  
The Netherlands

Contact: Mr Niek Ooijevaar  
Job Title: Harbour Master  
T: + 31 78 639 7875  
F: + 31 78 639 7879  
E: nooijevaar@dordrecht.nl

**Europoort - Rt**

**Ertsoverslagbedrijf Europoort C.V. (EECV)**

Markweg 131  
Europoort - Rt  
Zuid-Holland  
3198 NB  
The Netherlands  
Contact: Mr Burkhard Decker  
Job Title: Management Board  
T: + 31 181 25 77 02  
F: + 31 181 25 77 03  
E: Info.eecv@thyssenkrupp.com  
W: www.eecv.nl  
Port of Rotterdam Europoort  
3 grab unloaders each 2300 tph,  
1 continuous shipunloader 3000 tph,  
6 stacker reclaimers 4600 tph each,  
3 barge loaders 4600 tph each,  
1 train loading station 2000 tph.  
3 berths, 18.5-23.7m draught  
Vessel size up to 365,000dwt.  
40 ha

**Farmsum**

**Akzonobel**  
Oosterhorn 4  
Farmsum  
Delfzijl  
9936 HD  
The Netherlands  
Contact: Mr Arend Niemeijer  
Job Title: Shipping Manager  
T: + 31 596 64 7000  
E: arend.niemeijer@akzonobel.com  
W: www.akzonobel.salt

**Ijmuiden**

**Nebam BV**  
PO Box 512  
Ijmuiden  
1970 AM  
The Netherlands  
Contact: Mr Marcel Botterhuis  
Job Title: Manager Agency Dept  
T: + 31 251 495521  
F: + 31 251 470279  
E: marcel.botterhuis@nebam.nl  
W: www.NEBAM.nl

**Koudekerk aan den Rijn**

**ENBO BV**  
3 Hondsdijk  
Koudekerk aan den Rijn  
HG  
2396  
The Netherlands  
Contact: Mr Jan Lahuis  
Job Title: Advertising  
T: + 31 713 413 600  
F: + 31 713 416 007  
E: info@enbo.nl

**Mierlo**

**International Bulk Handling Technology BV**  
PO Box 47  
Mierlo  
5730 AA  
The Netherlands  
Contact: Mr Johan M.A.M. Brands  
Job Title: Technical Manager  
T: + 31 492 664 885  
F: + 31 492 664 695  
E: info@ibtbulk.nl  
W: www.ibtbulk.nl  
Offers over 42 years of expertise in design, manufacturing and maintenance of bulkhandling systems. Recently completed projects include ship loading facilities, reclaimers, hoppers, bins, automated train and ship loading/unloading facilities.

Beltwall and pipe conveyors. Located in Indonesia, China, Argentina, Germany, USA and The Netherlands.

**Moerdijk**

**Associated Metal Services B.V.**  
Vlasweg 19  
PO Box 14  
Moerdijk  
Noord-Brabant  
4780 AA  
The Netherlands  
Contact: Mr Albert Marcha van Ommen  
Job Title: Managing Director  
T: + 31 168 393203  
F: + 31 168 393202  
E: a.vanommenjr@eurorijn.com  
W: www.eurorijn.com  
Rotterdam area (Moerdijk)  
3 cranes - 6000 tons per month  
3 payloaders - 10 vt trucks  
2 weigh bridges  
Draught 8.90m, quay 700 metres  
20,000sqm  
45,000sqm  
We also offer processing and packing services.

**Moerdijk**

**Combined Cargo Terminals B.V.**  
Graanweg 19  
Moerdijk  
Noord-Brabant  
4782 PP  
The Netherlands  
Contact: Mr Luc Smits  
Job Title: Managing Director  
T: + 31 168 334270  
F: + 31 168 381193  
E: info@cctmoerdijk.com  
W: www.cctmoerdijk.com  
Moerdijk  
Crane cap till 150m  
Quay length 1,600m, draught 8.90m

250,000sqm  
22,000sqm

**Rotterdam**

**C. Steinweg-Handelsvem BV**  
Parmentierplein 1  
Rotterdam  
Zuid-Holland  
3088 GN  
The Netherlands  
Contact: Mr Henk Poen  
Job Title: Director Ferro Alloys  
T: + 31 10 487 93 96  
F: + 31 10 487 92 78  
E: h.poen@nl.steinweg.com  
W: www.steinweg.com  
Waalhaven, The Netherlands.  
Rotterdam, Port NO. 2186  
Cranes, crushing/screening possibilities  
Quayside of 300m. Draught approx. 10m.  
40,000 sqm  
60,000 sqm  
Stevedoring/storage/crushing/screening. Packing of bulk ferro alloy.

**Rotterdam**

**European Bulk Services (EBS) BV**



Elbeweg 117, Port number 5820  
3198 LC Europoort-Rotterdam  
P.O. Box 1204  
3180 AE Rozenburg  
The Netherlands  
Contact: Mr Taco de Vries  
Job Title: Managing Director  
T: + 31 181 258 147  
F: + 31 181 258 154  
E: sales@ebsbulk.nl  
W: www.ebsbulk.nl  
Rotterdam, The Netherlands  
Floating grab cranes; gantry cranes



**An independent stevedoring company operating in Dordrecht, Moerdijk and Rotterdam.**



- bulkhandling
- warehousing
- storage
- containerhandling

*More than just a stevedore*

**Terminal Dordrecht**  
's-Gravendeelsedijk 175  
3316 AS Dordrecht

T +31 (0)78-6 111 000  
F +31 (0)78-6 111 001  
E info@zhd.nl

**Terminal Moerdijk**  
Vlasweg 19  
4782 PW Moerdijk

T +31 (0)168-328 050  
F +31 (0)168-327 678

**WWW.ZHD.NL**



**OVET** B.V.  
[www.ovet.nl](http://www.ovet.nl)



Mr. F.J. Haarmanweg 16d  
4538 AR Terneuzen  
The Netherlands

Tel.: +31 115 676 700  
Fax: +31 115 620 316  
E-mail: [info@ovet.nl](mailto:info@ovet.nl)

Contact: Mr. Jan Agten  
Mr. Bram Peters  
Mr. Sander van der Veeke

**NEW: TRAIN LOADING STATION**  
**LOCATION: TERMINAL VLISSINGEN**  
**TRAIN CAPACITY: UNLIMITED D-CLASS**



36t  
Cape, panamax, handy, coaster  
berth  
36 ha  
500,000m<sup>3</sup>  
1 agri-bulk/grain handling terminal  
1 multi-purpose bulk terminal (coal,  
minerals, agri, biomass)  
Various storage modes for different  
products.

**Rotterdam**  
Europees-Massagoed  
Overslagbedrijf (EMO) BV



PO Box 9000  
Maasvlakte RT  
Rotterdam  
3199 XA  
The Netherlands  
Contact: Mr Sjaak Roukema  
Job Title: Commercial Manager  
T: + 31 181 371113  
F: + 31 181 371222  
E: j.c.roukema@emo.nl  
W: www.emo.nl  
Maasvlakte - Rotterdam  
1 x 36 tonne lift capacity floating  
crane  
3 x 85 tonne lift capacity grab  
unloaders  
2 x 55 tonne lift capacity grab  
unloaders  
Draught 23m.  
Storage capacity 7 million m/t  
EMO offers a discharge capacity of  
around 42 mta. Daily unloading  
rates of up to 175,000 tonnes  
4 bulk carriers can be accommodated  
simultaneously.

**Rotterdam**  
Marcor Stevedoring BV  
Rotterdam



Dodewaardstraat 14  
(Port Number 2175)  
Rotterdam  
3087 BA  
The Netherlands  
Contact: Mr Aad Groenenboom  
Job Title: Director  
T: + 31 10 299 21 21  
F: + 31 10 299 21 22  
E: a.groenenboom@marcor.nl  
W: www.marcor.nl  
Throughout the Port of Rotterdam  
4 floating cranes; up to 1,400 tph  
per crane  
2 floating weighing towers for agri  
bulk only  
No restrictions for Panamax  
vessels; even Cape size vessel are  
possible.  
Floating storage vessel and



numerous barges.  
Floating storage vessel and  
numerous barges.  
Fast, flexible and reliable high  
quality standards.

**Rotterdam**  
Meneba

Posbus 5149  
Rotterdam  
3008 AC  
The Netherlands  
Contact: Ms Wendy de Vos  
T: + 31 10 4238911  
F: + 31 10 4238625  
E: w.devos@meneba.com  
W: www.meneba.com

**Rotterdam**

Oxbow Coal B.V.  
P.O. Box 51060  
Rotterdam  
3007 GB  
The Netherlands  
Contact: Mr Ewoud Colenbrander  
Job Title: Director of International  
Operations  
T: +31104419200  
F: +31104360692  
E: Ewoud.Colenbrander@  
oxbow.com  
W: www.oxbow.com

**Rotterdam**

Port of Rotterdam  
PO Box 6622  
Rotterdam 3002 AP  
The Netherlands  
Contact: Mr Martin Ouwerkerk  
T: + 31 10 2521627  
E: info@portofrotterdam.com  
W: www.portofrotterdam.com  
Rotterdam, The Netherlands  
Total port area 10,500 ha  
Area of industrial sites 5,100 ha  
Bulk cranes 58  
Dry Bulk terminals 15  
Area of water 3,440 ha  
Infrastructure 1,960 ha  
Port length 40  
km

Quay length 74  
km  
Slope length 187  
km  
4.7 million (m2) total Rotterdam +  
other great Rotterdam  
The aim of the Port of Rotterdam  
Authority is to enhance the port of  
Rotterdam's competitive position as  
a logistics hub and world-class  
industrial complex. Not only in  
terms of size, but also quality. The  
core tasks of the Port Authority are  
to develop, manage and run the  
port in a sustainable way and to  
maintain a speedy and safe service  
for shipping.

**MARCOR**  
STEVEDORING B.V.

YOUR PARTNER IN LOGISTICS



Marcor Stevedoring B.V. – Dodewaardstraat 14 – NL-3087 BA Rotterdam  
Tel. +31(0) 10 299 21 21 – Fax +31(0) 10 299 21 22 – info@marcor.nl – www.marcor.nl

# EMO – 40 years fully equipped to meet your expectations



Please visit [emo.nl](http://emo.nl) to monitor our progress.





## LOOK TO THE FUTURE AND PLAN AHEAD

Since 1973, the EMO terminal in the Rotterdam port has been a major hub in transporting coal and iron ore from all over the world to the European hinterland. EMO has always been a reliable partner for its customers in helping to control these flows of goods by combining daily processes with a clear vision for the future.

EMO is able to accommodate the world's largest dry bulk vessels, and yet we never cease to look to the future and plan ahead – now more than ever! In 2012, we have strongly increased our storage and transshipment capacity and efficiency by commissioning five new, state-of-the-art projects: the seventh stacker reclaimer, the fifth unloader, the second fully automated coal wagon loader, a brand-new sea-going vessel loader along an innovative, new quay, and a high-tech operations centre. These projects ensure that we are fully equipped to enhance our safety, efficiency and sustainability performance, and to continue to serve you as a reliable partner in dry bulk transshipment in the coming decades.

# stevedoring & warehousing rotterdam

- PROJECT CARGO
- INDUSTRIAL BREAKBULK
- 730 METRES QUAY LENGTH
- HEAVY LIFT STORAGE AREA
- HEAVY LIFT UP TO 1800 TONS

Lifting your cargoes faster

ISPS CERTIFIED

AEO-F CERTIFIED



**(rhb)**  
ROTTERDAM

Waalhaven n.z. 4  
3087 BL Rotterdam  
P.O. Box 55092  
3008 EB Rotterdam  
Portnumber 2157

TELEPHONE  
+31 (0)10 429 94 33

FAX  
+31 (0)10 429 02 61

E-MAIL  
office@rhb.nl

WEB  
www.rhb.nl

shorecranes up to 208 tons



## Rotterdam

### RHB Stevedoring & Warehousing



Waalhaven NZ 4  
Port Number 2 1 5 7  
Rotterdam  
ZH  
3087 BL  
The Netherlands  
Contact: Mr Peter van der Pluijm  
Job Title: Managing Director  
T: + 31 10 429 9433  
F: + 31 10 429 0261  
E: office@rhb.nl  
W: www.rhb.nl  
Rotterdam - The Netherlands  
Shorecranes up to 208 m/tons  
Floating cranes up to 1500 m/tons  
ISPS certified quay of 730m length  
with 8 shorecranes & 4 floating  
cranes, max draught 10m. AEO-F  
certified.  
30,000sqm  
15,000sqm  
Handling project cargoes, industrial  
breakbulk, heavy lifts, metals, steel  
and general cargoes incl.  
oversized.

## Rotterdam

### Stuwadoors en Controlebedrijf BV

Dodewaardstraat 14  
Rotterdam  
3087 BA  
The Netherlands  
Contact: Mr Nico Westerdeke  
T: + 31 10 28 31 044  
F: + 31 10 28 31 040  
E: info@oosterom.com

W: www.oosterom.com

## Rotterdam

### Van Uden Bulk Logistics

Gustoweg 68  
Rotterdam  
3029 AS  
The Netherlands  
Contact: Mr Robert van Muiden  
Job Title: General Manager  
T: + 31 10 221 40 20  
F: + 31 10 476 19 27  
E: r.vanmuiden@vubl.nl  
W: www.van-uden.nl  
Port of Rotterdam  
7 cranes, private owned terminal  
warehouses, weighing bridge etc.  
Merwehaven Bulk Terminal nr. 385  
50,000 sqm  
12,500 sqm  
Specialized in door-to-door logistic  
services for drybulk minerals as  
well as packed in bigbags and/or  
pallets. GMP certified.

## Rotterdam

### Van Uden NedCargo

Van Maasdijkweg 27  
Rotterdam  
3088 EC  
The Netherlands  
Contact: Mr Diederik Antvelink  
T: + 31 10 7990200  
F: + 31 10 7990299  
E: d.antvelink@van-uden.nl  
W: www.NedCargo.com

## Rotterdam

### Van Uden Stevedoring

Gustoweg 68  
(Port number 385)  
Rotterdam  
3029 AS  
The Netherlands  
Contact: Mr Gerard de Jong

T: + 31 10 476 0171  
F: + 31 10 476 1927  
E: g.dejong@vanudenstevedoring.nl  
W: www.vanuden.nl  
Rotterdam  
6 cranes each a capacity of 500  
tons an hour  
650 mtr quay length, draft 10.2m  
(high tide), draft 9.65m (low tide)  
25,000 sqm  
20,000 sqm  
10 bunkers with capacity of 500  
tons each.

## Rozenburg

### EP Shipping & Trading BV

PO Box 1050  
Rozenburg  
3180 AB  
The Netherlands  
Contact: Mr Eddy Van de Wijngaart  
(snr)  
T: + 31 181 402 788  
F: + 31 181 402 689  
E: eps@epship.nl  
W: www.epship.nl

## Sas van Ghent

### Cerestar Benelux

PO Box 9  
Sas van Ghent  
4550 AB  
The Netherlands  
Contact: Mr Tony van der Stad  
T: + 31 115 459 000  
F: + 31 115 451 033  
E: info@cerestar.com  
W: www.cerestar.com

## Sas van Ghent

### Zuid-Chemie

Westkade 38a  
PO Box 70  
Sas van Ghent  
4550 AB

The Netherlands  
Contact: Mr Wim Wille  
Job Title: Marketing Department  
T: +31 115 456 000  
F: +31 115 451 647  
E: info.nl@rosier.eu  
W: www.zuidchemie.nl

## Schiedam

### Nieuwe Waterweg Silo BV

Nieuwe Waterwegstraat 55  
(Port 542)  
Schiedam  
3115 HE  
The Netherlands  
Contact: Mr. Jan Maasdam  
Job Title: Managing Director  
Contact: Mr Bastiaan de Heer  
Job Title: Commercial Operations  
Manager  
T: + 31 10 427 12 30  
M: +31 6 - 10922231  
F: + 31 10 473 75 73  
E: info@nwsilo.nl  
W: www.nwsilo.nl  
As a storage and transshipment  
company, Nieuwe Waterweg Silo  
b.v. specialises in loading and  
discharging of small vessels,  
coasters, barges, trucks or  
containers (bulk).  
We handle agribulk (with or without  
weighing) and minerals such as  
fertilizers, ferro, cokes, stones etc.  
We do have GMP+, ISPS.  
Our silo has a storage capacity of  
abt. 4500 mts., a total of 9 cells.  
At our berth we have two cranes  
with a transshipment capacity  
unweighed, abt. 450 tons p/h. per  
crane and transshipment weighed  
abt. 200 tons p/h bss light grain,  
pellets and approx. 300 t/h (bss  
heavy grain).  
Draught (guaranteed) 8 mtr., width:  
18 mtr., length: max 2 coasters

totally 160 mtr.  
Load / discharge time trucks, abt.  
10 min. p/truck.  
Our major clients are located in The  
Netherlands, Germany, Great-  
Britain, Belgium, Scandinavia,  
France, Spain, Switzerland and  
Austria.

## Schiedam

### Van Mannekus & Co

Nieuwe Waterwegstraat 540  
Schiedam  
The Netherlands  
Contact: Mr Henk Don  
Job Title: Manager  
T: + 31 10 409 15 00  
F: + 31 10 473 08 80  
E: h.don@mannekus.com

## Stiens

### EMG-Silo Groningen

PO Box 22  
Stiens  
9050 AA  
The Netherlands  
Contact: Mr Sjoerd De Vries  
T: + 31 566 625710  
F: + 31 566 625711  
E: sj.devries@tell.devries.nl  
W: http://www.feedlogistics.nl



Being in business for nearly a century has allowed us to build a solid reputation with our customers and subcontractors. We can charter tonnage, select the right port; find the best terminals, stevedores and process throughput via road, rail and inland waterway to the final destination. We organize and coordinate all freight inspections, customs affairs and paper work. Having the best specialists in the cargo handling and transport business, Gans Cargo Operations is able to provide her customers with competitive prices for bulk-, break-bulk and containerized cargoes. Our strong teams of cargo superintendents monitor all 'on site' transactions in the ports of Rotterdam, Antwerp, Amsterdam, Ghent, Terneuzen, Flushing, Ostend and Zeebrugge, as well as every other European port at customer's request.

If your company is looking to move freight or commodities in bulk and/or containers in and out of Europe, then you need one central cargo manager -Gans. Let us prove what our fast, cost-effective organization can offer you and discover that there is a better way to move your freight around the world.

Rotterdam, The Netherlands  
Phone: +31-10-501 34 55  
E-mail: gans@ganscargo.com



Ghent, Belgium  
Phone: +32-9-251 78 79  
E-mail: gans.gent@ganscargo.com



# Verbrugge Terneuzen Terminals

## Your European Hub

The Verbrugge Bulk Terminal is one of Europe's most modern terminals.

Verbrugge Terminals is well equipped to arrange through-transportation of your products using all existing modes:

- by road, using its own fleet
- by rail, loading block trains using its new loading facility
- by water, both inland and short sea using its own chartering departments.

Cutting edge in-house information services are provided.

Offering a total logistical package enables us to integrate your supply chain and thereby be highly competitive.



**VERBRUGGE  
TERNEUZEN TERMINALS B.V.**

P.O. Box 5  
4530 AA Terneuzen  
The Netherlands

+31 (0) 115 64 64 91  
mario.rijt@verbrugge.nl  
www.verbrugge.nl



**Terneuzen**  
Ovet BV - Terneuzen Terminal



Mr F.J. Haarmanweg 16 d  
Terneuzen  
Zeeland  
NL-4538 AR  
The Netherlands  
Contact: Mr Sander ven der Veeke  
Job Title: Account & Planning  
Manager

T: + 31 115 676 741  
F: + 31 115 620 316  
E: info@ovet.nl  
W: www.ovet.nl  
South West of The Netherlands:  
Kaloorthaven, Vlissingen +  
Massagedharbour, Terneuzen  
4 floating cranes (3 floating cranes  
with 25t lifting capacity each/ 1  
floating crane with 36t lifting  
capacity) / 80,000 tonnes per day /  
1,000tph free digging capacity.  
— Vlissingen Terminal:  
Capazität up to 180,000 tonnes /  
Max draught 16.5m salt water/  
1,000m quay  
- Terneuzen Terminal:  
Panamax up to 80,000 tonnes /  
Max draught 12.5m fresh water/  
1,400m quay  
- 2 anchorage places on the

river Scheldt  
- Vlissingen Terminal:  
2,000,000 tonnes open storage/  
315,000sqm paved terrain.  
- Terneuzen Terminal:  
600,000 tonnes open storage  
160,000sqm paved terrain  
1 Shed with 6 compartments of  
1,000sqm each. So total 6,000sqm,  
7,500 cubic meters.  
Both terminals equipped with:  
(Mobile) screening, crushing,  
blending and de-ironing  
installations. Trainloading and  
mobileshore cranes. Lightening  
operations possible for vessels  
which are too deep to enter the  
ports of Terneuzen, Ghent and  
Antwerp.

**Terneuzen**  
Terneuzen Port Authority

Zeeland Seaports  
PO Box 132  
Noorwegenweg 1  
Terneuzen  
4530 CA  
The Netherlands  
Contact: Mr Francesco Faes  
Job Title: Commercial Director  
T: + 31 115 647400  
F: + 31 115 647500  
E: francesco.faes@zeeland-  
seaports.com

**Terneuzen**  
Verbrugge Terneuzen Terminals



Zwedenweg 1  
Harbour 1361  
PO Box 5  
Terneuzen  
4530 AA  
The Netherlands  
Contact: Mr Mario H. L. van Rijt  
Job Title: Director Bulk & Marine  
T: + 31 115 646 491  
F: + 31 115 646 490  
E: mario.rijt@verbrugge.nl  
W: www.verbrugge.nl  
South West of the Netherlands, at  
the North Sea, right at the Scheldt  
estuary  
Draught: 12,25m / Quay length:  
1.800m / Harbour width: 250m

**Terneuzen**  
Zeeland Seaports



PO Box 132  
Terneuzen  
4530 AC  
The Netherlands  
Contact: Mr Arno Dirkzwager  
Job Title: Communication Manager  
T: + 31 115 647 400  
F: + 31 115 647 500  
E: arno.dirkzwager@  
zeelandseaports.com  
W: www.zeelandseaports.com  
At the entrance of the Western  
Scheldt River  
Zeeland Seaports represent the  
ports of Terneuzen and Vlissingen.  
Both ports have an open  
connection to the North Sea.  
Vessels with a draught of 16.5m  
can be accommodated.

**Vlaardingen**  
Port of Vlaardingen

PO Box 1002  
Vlaardingen  
3130 EB  
The Netherlands  
Contact: Mrs Petra de Wit  
Job Title: Harbour Master  
T: + 31 10 248 4561  
F: + 31 10 434 43 73  
E: p.de.wit@vlaardingen.nl  
W: www.havenkantoor.vlaardingen.nl  
South West of Holland on the North  
Sea  
...being a neighbour of Rotterdam  
means sharing in the advantages of  
a world port. At the same time we  
can offer you a more personal  
approach!



It's in our character

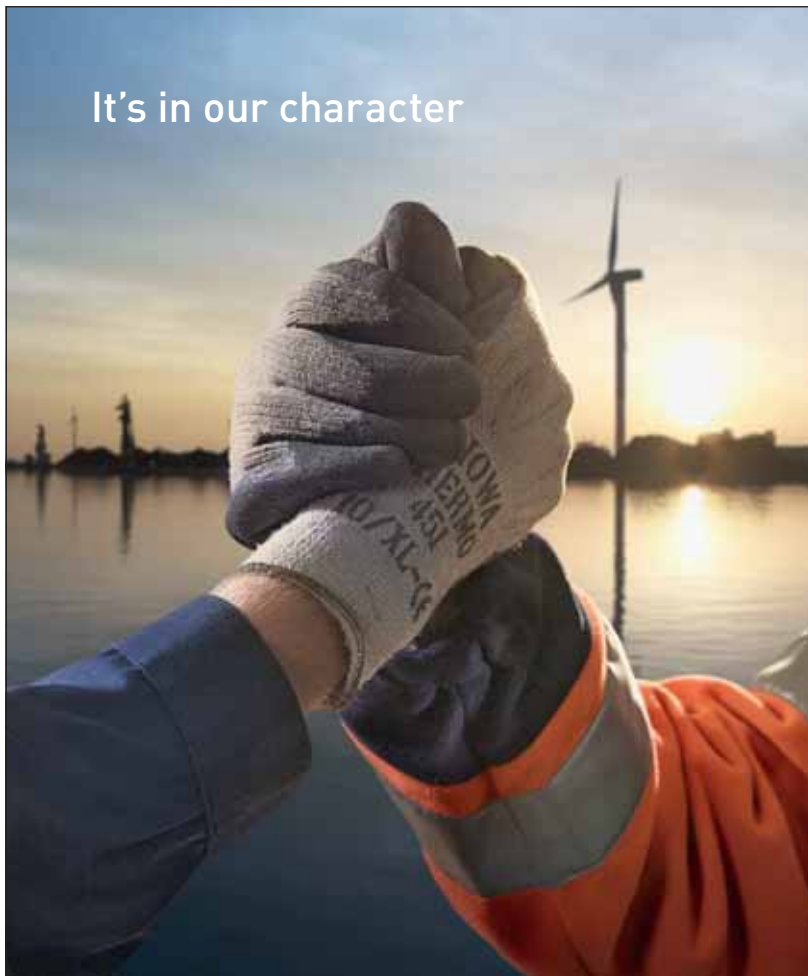

The port is our life. Hands-on mentality, hard work and accessible people, that's our character. Anyone who gets to know Zeeland Seaports becomes acquainted with professionals who are proud of their ports. We understand that your interests are also our interests. Clients come first. Always. We know what's important to your company. That's all in our character, and one of our many strengths:

- location on open sea
- draft of 16.5 metres
- congestion-free connections with the hinterland
- no nine-to-five mentality
- accessible ports and people
- dedicated terminals for a broad range of cargo
- you can reach us 24/7 at +31 115 647400

ports of vlissingen and terneuzen  
[www.zeelandseaports.com](http://www.zeelandseaports.com)



driven by dedication





## Rotterdam Bulk Terminal, your dry Bulk Cargo Specialist

Operating around-the-clock, RBT has a wide knowledge of dry bulk commodities and is continually expanding its specialization to understand and provide the right answer to all your challenges. Our future lies in serving our clients not only with effective transhipment and storage, but also by being a solution thinking partner.

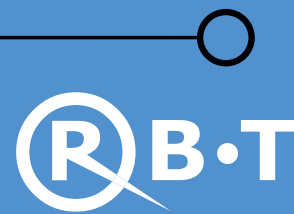

[www.rbtrotterdam.com](http://www.rbtrotterdam.com)



Agricultural & Fertilizers



Industrial minerals



Energy & Steel



Biomass

Rotterdam Bulk Terminal (R.B.T.) B.V.  
Schiedamsedijk 16  
3134 KK Vlaardingen  
The Netherlands  
Tel: +31 (0)10 234 35 55  
E-mail: [info@rbtrotterdam.com](mailto:info@rbtrotterdam.com)





**Vlaardingen**

Rotterdam Bulk Terminal (R.B.T.) B.V.



Schiedamsedijk 16  
(Harbour no. 610)  
Vlaardingen  
South Holland  
3134 KK  
The Netherlands  
Contact: Mrs Carola Broers-Keuning  
Job Title: Director  
T: + 31 10 234 35 55  
F: + 31 10 234 21 85  
E: info@rbtrtdam.com  
W: www.rbtrtdam.com  
Rotterdam Port Area  
2 Gantry Cranes 350 - 600 tph  
525m quay length and 12m draught  
50,000 sqm  
20,000 sqm  
Throughput capacity of 3.000.000 tpa

**Viissingen**

Ovet BV - Viissingen Terminal



Mr F.J. Haarmanweg 16 d  
Terneuzen  
Zeeland  
NL-4538 AR  
The Netherlands  
Contact: Mr Jan Agten  
Job Title: Commercial Manager  
T: + 31 115 676 700  
F: + 31 115 620 316  
E: info@ovet.nl  
W: www.ovet.nl  
South West of The Netherlands:  
Kaloothaven, Viissingen +  
Massagoedharbour, Terneuzen  
4 floating cranes (3 floating cranes  
with 25t lifting capacity each/ 1  
floating crane with 36t lifting  
capacity)/ 80,000 tonnes per day /  
1,000tph free digging capacity.  
- Viissingen Terminal:  
Capsize up to 180,000 tonnes /  
Max draught 16.5m salt water/  
1,000m quay  
- Terneuzen Terminal:  
Panamax up to 80,000 tonnes /  
Max draught 12.5m fresh water/  
1,400m quay  
- 2 anchorage places on the  
river Scheldt:  
For lightening vessels for Antwerp,  
Ghent and Terneuzen. Max draught  
16.5m salt water.  
- Viissingen Terminal:  
2,000,000 tonnes open storage/  
315,000sqm paved terrain.  
- Terneuzen Terminal:  
600,000 tonnes open storage  
160,000sqm paved terrain  
1 Shed with 6 compartments of  
1,000sqm each. So total 6,000sqm.  
Both terminals equipped with:  
(Mobile) screening, crushing,  
blending and de-ironing  
installations. Trainloading and  
mobileshore cranes. Lightening  
operations possible for vessels  
which are too deep to enter the  
ports of Terneuzen, Ghent and  
Antwerp.

**Zwijndrecht**

Agro Delta Group

Zwijndrecht  
Lindtsedijk 62  
PO Box 120  
Zwijndrecht  
ZH  
3330 AC  
The Netherlands  
Contact: Mr John van Belle  
Job Title: Managing Director/Owner  
T: + 31 78 6100900  
F: + 31 78 6100301  
E: jvbelle@agro-delta.nl  
W: www.agro-delta.nl  
The Netherlands, riverside near  
Rotterdam. Port of Dordrecht and  
Zwijndrecht.  
2 bulcranes, shovels, fork-lift  
trucks, 3 weighbridges, screening  
facilities for fertiliser, cleaning  
facilities for grains, seeds and  
pulses  
4 berths, 3 with 4 mtr draught, 1  
with 8,75 mtr draught  
54,000 sqm, 60,000 m.t. silo space  
Storage and handling of grains,  
seeds, pulses, rice, fertiliser,  
feedstuffs, breakbulk and rental of  
warehouses.

**TOGA**

**Lome**

Office Togolaise des Phosphates  
PO Box 379  
Lome  
Toga  
Contact: Mr K Atefebu  
Job Title: Harbour Master  
T: + 228 213901  
F: + 228 217105

**TRINIDAD & TOBAGO**

**Couvra Trinidad**

Point Lisas Industrial Port  
Development Corp Ltd  
PO Bag 191  
Apdo Postal  
Couvra Trinidad  
Trinidad & Tobago  
Contact: Ms Cindy Asevero  
T: + 1 868 636 2201  
F: + 1 868 679 7659  
E: casevero@plipdeco.com

**Point Lisas**

Point Lisas Industrial Port  
Development Corp  
Atlantic Avenue  
Point Lisas Estate  
Point Lisas  
Trinidad & Tobago  
Contact: Mr Rawle Baddaloo  
Job Title: Divisional Port Manager  
T: + 1 868 636 4913  
F: + 1 868 636 4061  
E: plipdeco@plipdeco.com  
W: www.trinidad.net/plipdeco

**Port of Spain**

Chaguaramas Terminals Ltd  
Chag Terminals Drive  
PO Box 608  
Port of Spain  
Trinidad & Tobago  
Job Title: General Manager  
T: + 1 86 634 4384  
F: + 1 86 634 4542

**Port of Spain**

Cronstadt Island  
Baroid Trinidad Services Ltd  
PO Box 765  
Port of Spain

Trinidad & Tobago  
Contact: Mr C Fuller  
Job Title: General Manager  
T: + 1 86 680 2428  
F: + 1 86 627 5193

**Port of Spain**

Port Authority of Trinidad and  
Tobago  
1 Dock Road  
Port of Spain  
Trinidad & Tobago  
Contact: Mr Kelvin Harris  
Job Title: Divisional Manager  
Operations  
T: +1 868 625-2644  
F: + 1 86 627 266  
E: kelvinh@patnt.com  
W: www.patnt.com

**Port of Spain**

Port Authority of Trinidad and  
Tobago  
Dock Road  
Port of Spain  
Trinidad & Tobago  
Contact: Ms Kathleen Maxwell  
Job Title: Manager  
T: + 868 623 2901 5

**TUNISIA**

**Bizerte**

Office des Ports Nationaux  
Tunisiens  
Quai Tarek Ibn Ziad  
Bizerte  
7000  
Tunisia  
Contact: Mr Mohamed Adel  
Mokhtar  
Job Title: Director  
T: + 216 2 431139  
F: + 216 2 433688  
E: ommp@ommp.nat.tn  
W: www.ommp.nat.tn

**Bizerte**

Port Authority of Bizerte  
Quai Tarek Ibn Zied  
Bizerte  
7000  
Tunisia  
Contact: Mr Ben Sadhel  
Job Title: Port Director  
T: + 216 71 735 300  
F: + 216 71 735 812  
E: ommp@ommp.nat.tn  
W: www.ommp.nat.tn

**Port de la Goulette**

Port Authority of Tunis Goulette  
Batiment Administratif  
Port de la Goulette  
Tunisia  
Job Title: Port Director  
T: + 216 1 735 300  
F: + 216 1 736 812  
E: ommp@ommp.nat.tn  
W: www.ommp.nat.tn

**Sfax**

Port Authority of Sfax  
Office des Ports Nationaux  
Tunisiens  
Rue Okba Ibn Nafaa  
Sfax  
3029  
Tunisia  
Contact: Captain Lamere Chokri  
Job Title: Port Captain  
T: + 216 4 225040  
F: + 216 4 225107  
E: ommp@ommp.nat.tn  
W: www.ommp.nat.tn

**TURKEY**

**Bursa**

Gemlik Port  
Kocacukur Mevkii  
101 Gemlik  
Bursa  
Turkey  
Contact: Mr Ali Kerim leil demirhan  
Job Title: Assistant General  
Manager  
T: + 90 224 524 88 31  
F: + 90 224 524 88 30  
E: gemport@gemport.com.tr  
W: www.gemport.com.tr/

**Eregli**

Eregli Port Authority  
Nevzat Direk  
Karadeniz Eregli  
Liman Baskanligi  
Eregli  
67330  
Turkey  
Contact: Mr Turget Ege  
Job Title: Harbour Master  
T: + 90 372 323 1007  
F: + 90 372 323 1169  
E: kdzeregli@denizcilik.gov.tr  
W: www.denizcilik.go.tr

**Hereke-Izmit**

NUH Cement Factory of Hereke  
Akyar Mevkii  
PO Box 7  
Hereke-Izmit  
1000  
Turkey  
Contact: Mr Seyid Uluabay  
Job Title: General Manager  
T: + 90 262 511 3975  
F: + 90 262 511 4112

**Istanbul**

Toros Tarim Sanayi ve Ticaret A -  
TOROS Ceyhan Term  
Buyukdere Caddesi  
Tekfen Tower, 19th Floor  
4 Levent  
Sisli  
Istanbul  
Marmara  
34394  
Turkey  
Contact: Mr Aydin Erdemir  
Job Title: Vice President - Terminal  
& Port Activities  
T: + 90 212 357 02 02 ext. 284/286  
F: + 90 212 357 02 31  
E: aydin.erdemir@toros.com.tr  
W: www.toros.com.tr

South of Turkey, on the South East  
Coast of Mediterranean Sea.  
Seaports Coordinates - West Jetty  
36 55 00 N - 35 58 54 E  
36 54 24 N - 35 59 06 E  
Seaport Coordinates - East Jetty  
36 55 12 N - 35 59 18 E  
36 54 30 N - 35 59 34 E  
For Dry Bulk and General Cargo;  
up to 14,400.000 tons  
loading/unloading capacity per year.  
For Liquids (including petroleum  
and chemical products); up to  
13,500.000 tons loading/unloading  
capacity per year.  
For dry bulk up to 110,000 DWT.  
For oil and chemical liquid up to  
40,000 DWT.  
1,000,000 sqm  
Warehouse capacity is 160,000 ton.  
Storage Tanks capacity is 236,500  
m3.  
Ceyhan Terminal is located in the  
heart of the Ceyhan Energy Zone in  
the East Med in proximity to the  
BTC (Baku Tiblisi Ceyhan crude oil  
pipe line) and Kerkuk-Ceyhan  
(Botas Iraq) crude oil pipe lines.

**Izmir**

Izmir Port  
General Directorate of Turkish  
State Railways  
Liman Isletmesi Mudurlugu  
Izmir  
Turkey  
Job Title: Port Director  
T: + 90 232 463 2252  
F: + 90 232 463 2248  
E: izmirilman@tcdd.gov.tr  
W: www.tcdd.gov.tr

**Mersin**

Famagusta Port Authority  
Works and Tourism Ministry Ports  
Department  
Mersin  
North Cyprus  
10  
Turkey  
Contact: Mr Enver Yetili  
Job Title: Director of Ports  
T: + 90 392 36 62627  
F: + 90 392 36 66465  
E: fpa@cc.emu.edu.tr

**Tekirdag**

Tekirdag Port  
TDI  
Tekirdag Liman Isletmesi  
Mudurlugu  
Tekirdag  
Turkey  
Contact: Mr Rasim Sinel  
Job Title: Port Director  
T: + 90 282 261 0800  
F: + 90 282 261 2346

**Tekkeköy/Samsun**

Toros Tarim San. ve Tic. A.  
Samsun Ordu Karayolu 14.km  
Sanayi Mah  
Tekkeköy/Samsun  
55300  
Turkey  
Contact: Mr Ismail Turan  
Job Title: Toros Terminal Opr. Man  
T: + 90 2123570202  
F: + 90 2123570231  
E: ismail.turan@toros.com.tr  
W: www.toros.com.tr

**Trabzon**

Trabzon Port  
Ports Management  
Trabzon Liman Isletmesi Mudurlugu  
Trabzon  
Turkey  
Contact: Mr Taner Kaskin  
Job Title: Harbour Master  
T: + 90 462 321 1073  
F: + 90 462 322 1004  
E: info@cerrahogullari.com.tr

**UAE**

**Abu Dhabi**

Abu Dhabi Seaport Authority  
PO Box 422  
Mina Zayed  
Abu Dhabi  
UAE  
Contact: Mr Mubarak Al Buainain  
Job Title: Port Director  
T: + 971 2 730 600  
F: + 971 2 731023  
E: mrktdebt@emirates.net.ae  
W: www.portzayed.gov.ae

**Abu Dhabi**

Port Zayed  
Abu Dhabi  
UAE  
Contact: Mr Mohammed Wagdy  
Job Title: Corporate  
Communications & Branding Officer  
T: + 971 2 6975270  
F: + 971 2 6975166

E: mohammed.wajdi@adterminals.ae  
W: www.portzayed.gov.ae

## Ajman

**Emirates Ports Services**  
PO Box 388  
Ajman  
UAE  
T: + 971 06 7470111  
F: + 971 06 7470333  
E: mail@ajmanport.gov.ae  
W: www.ajmanport.gov.ae/

## Dubai

**DP World**  
PO Box 17000  
Dubai  
UAE  
Contact: Mr Raveen Guliani  
T: + 971 4 881 5645  
F: + 971 4 881 7777  
E: marketing@dpworld.com  
W: www.dpworld.com

## Dubai

**Dubai Port World**  
PO Box 17000  
Dubai  
UAE  
Contact: Mr Abdul Rahim Al Qassim  
Job Title: Director  
T: + 971 4 2621241  
F: + 971 4 2663331  
E: AbdulRahim.alQassim@dpworld.com  
W: www.dpworld.ae/

## Fujairah

**Port of Fujairah**  
PO Box 787  
Fujairah  
UAE  
Contact: Captain Mousa Morad  
Job Title: General Manager  
T: + 971 9222 8800  
F: + 971 9222 8811  
E: Gms\_pot@fujairahport.ae  
W: www.fujairahport.ae

## UK

### Ayr

**Associated British Ports (Ayr and Troon)**  
Associated British Ports  
Port Office  
North Harbour Street  
Ayr  
KA8 8AH  
UK  
Contact: Mr Colin Hume  
Job Title: Commercial & Administration Manager  
T: + 44 1292 281687  
F: + 44 1292 287787  
E: chume@abports.co.uk  
W: www.abports.co.uk  
West Coast of Scotland, entrance to the Firth of Clyde  
3 hydraulic excavator cranes, several shovels, telehandlers, FLTs  
1 rail wagon discharge, rail connected quays  
Various - Max Length 110m, Max Draught 5.8m - 6.2m  
Extensive  
20,000sqm  
Also experienced in Heavy Lift operations.

### Ayr

**Ayr**  
ABP Port Office  
Ayr  
Ayrshire  
KA8 8AH  
UK  
Contact: Mr P Creswell  
Job Title: Port Manager  
T: + 44 1292 281 687

F: + 44 1292 287 787  
E: ayr@abports.co.uk  
W: www.abports.co.uk

## Barrow upon Humber

**New Holland Bulk Services**  
PO Box 1, Old Ferry Terminal  
New Holland  
Barrow upon Humber  
South Humber-side  
DN19 7SD  
UK  
Contact: Mr James Lyne  
Job Title: Managing Director  
T: + 44 1469 531 102  
F: + 44 1469 531 966  
E: james.lyne@newhollandbulkservices.co.uk

## Barrow-In-Furness

**Port of Barrow-in-Furness**  
Associated British Ports  
Ramsden Dock Road  
Barrow-In-Furness  
Cumbria  
LA14 2TW  
UK  
Contact: Mr Chris Clouter  
Job Title: Port Operations Manager  
T: + 44 1229 822911  
F: + 44 1229 835822  
E: barrow@abports.co.uk  
W: www.abports.co.uk  
North West England, West Coast, Irish Sea  
200,000sqm  
6,000sqm  
Ideal base port for offshore wind farm installation projects and long term O & M.

## Belfast

**Belfast Harbour Commissioners**  
Harbour Office  
Corporation Square  
Belfast  
BT1 3AL  
UK  
Job Title: Deputy Harbour Master  
T: + 44 2890553015  
E: michael.evans@belfast-harbour.co.uk  
W: www.belfast-harbour.co.uk/  
N. Ireland  
Over 3 million tonnes of Dry Bulk products each year.  
Almost 500,000 tonnes of Break Bulk in 2003.  
Please see website for equipment details.

## Berwick-Upon-Tweed

**Berwick Harbour Commission**  
Harbour Master's Office  
Tweed Dock  
Berwick-Upon-Tweed  
Northumberland  
TD15 2AB  
UK  
Contact: Mr. Alan Irving  
Job Title: CEO  
T: + 44 1289 307404  
F: + 44 1289 332 854  
E: info@bhshipping.com  
W: www.portofberwick.co.uk

## Blyth

**Port of Blyth**  
South Harbour  
Blyth  
Northumberland  
NE24 3PB  
UK  
Contact: Mr Martin Lawlor  
Job Title: Commercial Director  
T: + 44 1670 352066  
F: + 44 1670 368540  
E: commercial@blythport.co.uk

## Bootle

**E-ON UK Liverpool**  
Bulk Terminal  
Gladstone Dock  
Bootle  
Merseyside  
L20 1BE  
UK  
Contact: Mr Ken Jones  
T: + 44 151 933 0860  
F: + 44 151 933 0867  
E: ken.jones@eon-uk.com

## Boston

**Lingrain Services Ltd**  
The Dock  
Boston  
Lincs  
PE21 6BJ  
UK  
Contact: Mr Tony A Drew  
Job Title: Manager  
T: + 44 1205 366 484  
F: + 44 1205 368242  
E: tony.drew@centaurgrain.com

## Bristol

**The Bristol Port Company**  
St Andrews House  
St Andrews Road  
Avonmouth  
Bristol  
Avon  
BS11 9DQ  
UK  
Contact: Mrs Jullie Gough  
Job Title: Commercial Executive  
T: + 44 117 982 0000  
F: + 44 117 982 0698  
E: julie.gough@bristolport.co.uk  
W: www.bristolport.co.uk  
Bristol Port - South West England  
Royal Portbury Dock - 2  
Continuous Ship Unloaders  
2500tph, Shiploader 2000tph.  
Avonmouth Dock - Gottwald 260  
HMK, 3 x mobile cranes & numerous jib cranes.  
300m loa, 41m breath, 14.5m draught  
Royal Portbury - 700,000t Coal  
Royal Portbury - 200,000t AFS

## Canningtown

**European Metal Recycling Ltd**  
Bidden Street  
Canningtown  
London  
E16 4SZ  
UK  
Contact: Mr Bob Garwood  
Job Title: Southern Director  
T: + 44 20 7476 3104  
F: + 44 20 7474 5633  
E: bob.garwood@emrltd.com  
W: www.emrltd.com  
London, North side of River Thames.  
Bulk handling cranes  
Handle vessels up to 4,000 DWCC  
10,000sqm  
None

## Cardiff

**ABP South Wales (Ports of Newport, Cardiff, Barry, Port Talbot & Swansea)**  
Queen Alexandra House  
Cargo Road  
Cardiff  
South Glamorgan  
CF10 4LY  
UK  
Contact: Mr Matthew Kennerly  
Job Title: Port Director  
T: + 44 870 609 6699  
F: + 44 2920 835001  
E: mkennerly@abports.co.uk  
W: www.abports.co.uk

## Cardiff

**Associated British Ports**  
Queen Alexandra House  
Cargo Road  
Cardiff  
CF10 4LY  
UK  
Contact: Mr Callum Couper  
Job Title: Port Manager  
T: + 44 870 609 6699  
F: + 44 29 208 35001  
E: ccouper@abports.co.uk  
W: www.abports.co.uk  
South Wales  
Cranes up to 45MT, Materials Handlers, Various Quayside Equipment and mobile plant  
Up to 35,000 dwt  
In excess of 250,000sqm  
Circa 100,000sqm  
Port of Cardiff has road connections to the M4 and links to the Midlands as well as rail connections to the national network.

## Coleraine

**Coleraine Harbour Commissioners**  
Harbour Office  
4 Riversdale Road  
Coleraine  
Co Londonderry  
BT52 1RY  
UK  
Contact: Mr Pat McKeegan  
Job Title: Harbour Manager  
T: + 44 28 703 42012  
F: + 44 28 703 52000  
E: coleraineharbour@aol.com  
W: www.ports.org.uk/

## Dundee

**Forth Ports PLC - Port of Dundee**  
King George V Wharf  
Port Control Office  
Dundee  
DD1 3LJ  
UK  
Contact: Mr Matt North  
Job Title: Port Manager  
T: + 44 1382 224121  
F: + 44 1382 200834  
E: matt.north@forthports.co.uk  
W: www.forthports.co.uk

## Dundee

**Grainfax**  
Carolina Port  
Dundee Harbour  
Dundee  
DD1 3LW  
UK  
Contact: Mr Alan Burns  
T: + 44 132 4668 400  
F: + 44 1382 878 135  
E: alan.burns@forthports.co.uk  
W: www.grainfax.co.uk  
Dundee, East of Scotland  
2 Cranes - 300 t per hour  
Up to 9.5 m, 400 m lda  
20 000 sqm

## Egham

**Cemex UK**  
Coldharbour Lane  
Thorpe  
Egham  
Surrey  
TW20 8TD  
UK  
Contact: Mr Gavin Cowen  
Job Title: Plant Director  
T: + 44 1932 568 833  
F: + 44 1375 856618  
E: gavin.cowen@cemex.com  
W: www.cemex.co.uk/

## Falmouth

**A & P Falmouth Ltd**  
The Docks

Falmouth  
Cornwall  
TR11 4NR  
UK  
Contact: Mr Mike Reynolds  
Job Title: Port Operations Director  
T: + 44 1326 212100  
F: + 44 1326 211635  
E: mike.reynolds@ap-falmouth.co.uk  
W: www.ap-group.co.uk  
South West of England  
1 X Liebherr LHM 150.  
Grab cranes, up to 500 tonnes per hour  
3 berths total length: 640m, maximum draught 8.2m  
10,000 sqm  
7,500 sqm  
Strategically placed in SW approaches of English Channel.  
Rail connected and capable of handling a wide range of commodities.

## Felixstowe

**Felixstowe Dock & Railway Company**  
Tomline House  
The Docks  
Felixstowe  
Suffolk  
IP11 8TB  
UK  
Contact: Mr Richard Pearson  
Job Title: Managing Director  
T: + 44 1394 604500  
F: + 44 1394 604929  
E: enquiries@fdrc.co.uk  
W: www.portoffelixstowe.co.uk/

## Fowey

**Fowey Harbour Commissioners**  
Harbour Office  
Albert Quay  
Fowey  
Cornwall  
PL23 1AJ  
UK  
Contact: Mr M J Sutherland  
Job Title: Chief Executive  
Officer/Harbour Master  
T: + 44 1726 832472  
F: + 44 1726 833738  
E: info@foweyharbour.co.uk

## Garston

**ABP - Garston**  
Dock Road  
Garston  
Liverpool  
L19 2JW  
UK  
Contact: Mr Paul Jervis  
Job Title: Port Manager  
T: + 44 151 427 5971  
F: + 44 151 494 3232  
E: pjervis@abports.co.uk  
W: www.abports.co.uk  
North West England on North Bank of River Mersey. 10km upstream from Liverpool City Centre  
Lat 50 21'N Long 02 54'W  
2 Mobile exc/Heavy Lift crane/Grain conveyors  
Various upto 150m LOA  
30,000sqm  
10,000sqm  
Duty Free/TASCC/Soil Association approved bulk stores.

## Glasgow

**Clyde Port Authority**  
16 Robertson Street  
Glasgow  
Strathclyde  
G2 8DS  
UK  
Contact: Mr David Jerome  
Job Title: Marketing  
T: + 44 141 241 8530  
E: david.jerome@clydeport.co.uk



**Glasgow**

**Clydeport Operations**  
16 Robertson Street  
Glasgow  
Ayrshire  
G2 8DS  
UK  
Contact: Mr David Jerome  
Job Title: Marketing  
T: + 44 141 221 8733  
E: david.jerome@clydeport.co.uk  
W: www.clydeport.co.uk

**Goole**

**ABP - Goole Port**  
East Parade  
Goole  
East Yorkshire  
DN14 5RB  
UK  
Contact: Mr Phil Coombes  
Job Title: Commercial Manager  
T: + 44 1482 327 171  
F: + 44 1482 608 434  
01482 608 434  
E: pcoombes@abports.co.uk  
W: www.abports.co.uk  
Goole is located on the River Ouse, some 80km from the open sea and 2km from the M62. A wide range of facilities are available for handling unitised, bulk and general cargo with a particular strength in containers, steel and timber.

**Grangemouth**

**Casper Shipping Ltd**  
2nd Floor  
5 Kerse Road  
Grangemouth  
FK3 8HQ  
UK  
Contact: Mr Douglas Couser  
Job Title: Office Manager  
T: + 44 1324 486486  
F: + 44 1324 486444  
E: dcouser@casperltd.com  
W: www.casperltd.com

**Grangemouth**

**Forth Ports Plc**  
Carron House  
Central Dock Road  
Grangemouth  
Stirlingshire  
FK3 8TY  
UK  
Contact: Mr Dave Mc Pherson  
Job Title: Port Manager  
T: + 44 1324 668 400  
F: + 44 1324 668 484  
E: marketing@forthports.co.uk  
W: www.forthports.co.uk

**Grangemouth**

**Grangemouth**  
Forth Ports PLC  
Dock Office  
Grangemouth  
Stirlingshire  
FK3 8UE  
UK  
Contact: Mr Derek Knox  
Job Title: Port Manager  
T: + 44 1324 482591  
F: + 44 1324 665106  
E: enquiries@forthports.co.uk  
W: www.forthports.co.uk  
Grangemouth on the Firth of Forth  
3 x Ship-to-shore Container  
Cranes, 13 x Straddle Carriers, 3 x  
Empty Container Handlers, 2 x  
40tonne FLT's  
5,000sqm  
19,000sqm

**Grangemouth**

**Leith Docks**  
Forth Ports PLC  
Carron House  
Central Dock Road

Grangemouth  
Scotland  
SK38TY  
UK  
Contact: Mr Alan C Burns  
T: + 44 131 555 8750  
F: + 44 131 555 1212  
E: alan.burns@forthports.co.uk  
W: www.forthports.co.uk

**Gravesend**

**Port of London Authority**  
London River House  
Royal Pier Road  
Gravesend  
DA12 2BG  
UK  
Contact: Mr Doug Kempster  
Job Title: Marketing  
T: + 44 14 7456 2366  
F: + 44 14 7456 2398  
E: martin.garside@hotmail.com  
W: www.portoflondon.co.uk

**Great Yarmouth**

**East Port UK**  
20/21 South Quay  
Great Yarmouth  
Norfolk  
NR30 2RE  
UK  
Contact: Mr Eddie Freeman  
Job Title: Chief Executive  
T: + 44 1493 335500  
F: + 44 1493 852480  
E: efreeman@eastportuk.co.uk  
W: www.eastportuk.co.uk  
Norfolk (East Coast)  
Fleet of cranes up to 80 tonne truck  
mobile equivalent, grain elevators,  
forklift trucks, mechanical loading  
shovels. Full specifications  
available on application.  
6 kilometres of commercial quays.  
Main bulk berths located at East  
Quay, Ocean Terminal, Atlas  
Terminal. All vessels that can gain  
entry to the port can access all  
berths.  
Open Storage in excess of 40  
acres available  
Warehouses are located at  
strategic points around the port  
varying in size from 8,000 to 25,000  
sq ft. total available approximately  
250,000 sq ft  
Access is normally available on a  
round-the-clock basis. Very low  
tidal range (less than 2m). No locks  
or bridges in the commercial area.  
2 weighbridges and state of the art  
grain testing equipment available  
on site.

**Grimsby**

**Associated British Ports -  
Grimsby & Immingham**  
Port Office  
Cleethorpe Road  
Grimsby  
North East Lincolnshire  
DN31 3LL  
UK  
Contact: Mr John Fitzgerald  
Job Title: Port Director  
T: + 44 1472 359 181  
F: + 44 1472 242 488  
E: jfitzgerald@abports.co.uk  
W: www.abports.co.uk

**Hartlepool**

**Tees and Hartlepool Port  
Authority**  
Hartlepool Docks  
Middleton Road  
Hartlepool  
Cleveland  
TS24 0SE  
UK  
Contact: Ms Kirsten Potter  
Job Title: Marketing  
T: + 44 1642 87 7000

F: + 44 1642 87 7056  
E: kirsten.potter@pdpports.co.uk  
W: www.thpal.co.uk

**Holywell**

**Mostyn Docks Limited**  
Mostyn  
Holywell  
Clwyd  
CH8 9HD  
UK  
Contact: Mr R C Hyde-Linaker  
Job Title: Harbour Master  
T: + 44 1745 560335  
F: + 44 1745 560324  
E: harbourmaster@portofmostyn.com  
North East Wales  
One crane up to 26t, FLT up to 25t.  
Loading Shovels Bobcats Etc.  
Up to 120m length overall and 6m  
draught.  
5 Acres adjacent to berths  
25,000sqm

**Hull**

**ABP - Port of Hull**  
PO Box 1  
Port House  
Northern Gateway  
Hull  
HU9 5PQ  
UK  
Contact: Mr Phil Coombes  
Job Title: Commercial Manager  
T: + 44 1482 327 171  
F: + 44 1482 326 283  
E: pcoombes@abports.co.uk  
W: www.abports.co.uk  
Hull's has trade links with Europe,  
Scandinavia and the Baltic, in addition  
to world-wide deep-sea services. Hull  
is the UK's leading softwood timber  
port, and is the only passenger port  
on the Humber estuary.

**Hull**

**Frontier Agriculture Ltd**  
King George Dock  
Hull  
HU9 5PR  
UK  
Contact: Mr Tony Greendale  
Job Title: Silo Manager  
T: + 44 1482 701281  
F: + 44 1482 784891  
E: tony.greendale@frontierag.co.uk

**Hull**

**Titan Cement UK**  
Shed 12  
King George Dock  
Hull  
HU9 5PR  
UK  
Contact: Mr Phil Langdale  
Job Title: General Manager  
T: + 44 1482 784 012  
F: + 44 1482 784 013  
E: info@titanuk.co.uk  
W: www.titanuk.co.uk

**Immingham**

**Casper Shipping Ltd**  
Riverside House  
East Riverside  
Immingham  
NE Lincolnshire  
DN40 2LZ  
UK  
Contact: Mr David Healey  
T: + 44 1469 575 246  
F: + 44 1469 575 589  
E: immingham@casperltd.com  
W: www.casperltd.com  
North East Lincolnshire  
3 x shore mobile and 2 x shore  
gantry  
LOA 295m x beam 45m x airdraft  
17m x draught 14.20m - subject to  
tidal conditions  
Tidal predictions available on

request.

**Ipswich**

**ABP - Port of Ipswich**  
Old Custom House  
Key Street  
Ipswich  
Suffolk  
IP4 1BY  
UK  
Contact: Mr Alan Mason  
Job Title: Sales Manager  
T: + 44 1473 231010  
F: + 44 1473 230914  
E: amason@abports.co.uk  
W: www.abports.co.uk  
East coast, Suffolk, England  
All equipment necessary for  
bulk/neo bulk cargoes.  
Vessels up to 15,000dwt.  
Various areas at all port berths.  
74,000sqm  
Extensive variety of purpose built,  
modern storage facilities adjacent  
to berths.

**Ipswich**

**ABP Port of Lowestoft**  
Old Custom House  
Key Street  
Ipswich  
Suffolk  
IP4 1BY  
UK  
Contact: Mr Alastair MacFarlane  
Job Title: Port Manager  
T: + 44 147 323 1010  
F: + 44 147 328 8488  
E: amacfarlane@abports.co.uk  
East of England on the North Sea  
Silo berth 10,000t grain & 4,000t  
cement  
6m draught m.a.a.b.j.a. 10,000  
approx  
10,000sqm

**Ipswich**

**Clarksons Port Services**  
Sentinel Terminal  
East Bank  
Cliff Quay  
Ipswich  
IP3 OBS  
UK  
Contact: Mr Julian Scott  
Job Title: Director  
T: + 44 1473 254435  
F: + 44 1473 254438  
E: Julian.Scott@clarksons.com  
W: www.clarksons.com

**Ipswich**

**The Grain Terminal (Ipswich) Ltd**  
Cliff Quay  
Ipswich  
Suffolk  
123 OBG  
UK  
Contact: Mr Tim Capey  
Job Title: Director  
T: + 44 1473 250461  
F: + 44 1473 233212  
E: info@grainterminal-ips.com  
W: www.ipswichgrainterminal.com/  
East Anglia  
Ipswich (600 mt load rate/hr)  
Ipswich (5 cranes)  
Harwich Grain Terminal (6000 mt  
load rate /day)  
Ipswich 80,000 mt  
Harwich 25,000 mt

**Isle of Man**

**Port of Ramsey**  
Harbour Master's Office  
East Quay  
Ramsey  
Isle of Man  
IM8 IBG  
UK  
Job Title: The Manager

T: +44 1624 812 245  
F: +44 1624 815 361  
E: ramsey.port@gov.im  
W: www.gov.im/harbours  
Isle of Man  
Private. Mobile cranes  
L = 58m. Max draught 4.0m spring  
tide  
None  
Private warehouse

**Kings Lynn**

**King's Lynn Conservancy Board**  
Harbour Office  
Common Staith  
Kings Lynn  
Norfolk  
PE30 1LL  
UK  
Contact: Mr J Lorking  
Job Title: Harbour Master  
T: + 44 1553 773411  
F: + 44 1553 768185  
E: harbourmaster@  
portauthoritykingslynn.fsnet.co.uk

**Liverpool**

**Mersey Docks & Harbour  
Company**  
Maritime Centre  
Port of Liverpool  
Liverpool  
Merseyside  
L21 1LA  
UK  
Contact: Ms Ruth Hodgson  
T: + 44 15 194 96 324  
E: ruth.hodgson@peelports.co.uk  
W: www.merseydocks.co.uk  
North West of England at mouth of  
River Mersey  
Specialist cranes and equipment  
to handle all cargoes specific to the  
Port  
Numerous berths and facilities  
located in both Liverpool and  
Birkenhead Dock systems.  
8,100,000 sqm  
500,000 sqm  
A multi functional Port with  
individual companies specialising in  
the handling, storage, and  
distribution of the various  
commodities handled through the  
Port's facilities.

**Liverpool**

**Royal Seaforth Grain Terminal**  
Royal Seaforth Dock  
Liverpool  
L21 1JD  
UK  
Contact: Mr Colin McLoughlin  
T: + 44 151 949 6201  
F: + 44 151 949 6461  
E: colin.mcloughlin@peelports.com

**London**

**MacQuarie Capital (Europe)  
Limited**  
28 Ropemaker Street  
London  
EC2Y 9HD  
UK  
Contact: Mr Jim Lennon  
Job Title: Executive Director  
T: + 44 20 3037 4271  
F: + 44 20 3037 4306  
E: jim.lennon@macquarie.com

**Londonderry**

**Londonderry Port & Harbour  
Commissioners**  
Harbour Office  
Port Road  
Lisahally  
Londonderry  
Northern Ireland  
BT47 6FL  
UK  
Contact: Mr Bill McCann

Job Title: Harbour Master  
T: + 44 287 186 1113  
F: + 44 28 7186 1168  
E: bill@londonderry-port.co.uk  
W: www.londonderryport.com

## Manningtree

### Mistley Quay & Forwarding

High Street  
Mistley  
Manningtree  
Essex  
CO11 1HB  
UK  
Contact: Mr John Jenkins  
Job Title: Port Manager  
T: + 44 1206 394431  
F: + 44 1206 393882  
E: jrjenkins@twlogistics.co.uk

## Merton

**ABP**  
Merton Lane  
Merton  
York  
YO19 5GH  
UK  
Contact: Mr David Wood  
Job Title: General Manager  
T: + 44 1904 488333  
F: + 44 1904 489837  
E: david.wood@abpbeef.com

## Methil

### Port of Burntisland

Forth Ports PLC  
Dock Office  
Methil  
Fife  
KY8 3RE  
UK  
Contact: Mr Murray  
Murray Cheyne  
Job Title: Port Superintendent  
T: + 44 1383 413 366  
F: + 44 1333 424 873  
E: alan.burns@forthports.co.uk

## Middlesbrough

### Casper Shipping Ltd

Cleveland Business Centre  
1 Watson Street  
Middlesbrough  
Cleveland  
TS1 2RQ  
UK  
Contact: Mr Michael Shakesheff  
Job Title: Managing Director  
T: + 44 1642 233 570  
F: + 44 1642 243 936  
E: mshakesheff@casperitd.com  
W: www.casperitd.com

## Montrose

### Montrose Port Authority

South Quay  
Ferryden  
Montrose  
Angus  
DD10 9SL  
UK  
Contact: Mr John Paterson  
Job Title: Chief Executive  
T: + 44 1674 672302  
F: + 44 1674 675530  
E: info@montroseport.co.uk  
W: www.montroseport.co.uk  
East Coast of Scotland  
Craneage/Elevators etc.  
Quayside Bulk Stores  
60,000sqm  
200,000sqm  
Available uncovered & covered  
storage, varies week by week

## Near Hull

### Hull Agency (Goole)

Casper Shipping Ltd  
Saltend Office DL1 (Upper Floor)  
Saltend Hedon  
Near Hull

East Yorkshire  
HU12 8DS  
UK  
Contact: Mr Don Mussett  
T: + 44 1482 891533  
F: + 44 1482 891186  
E: hull@casperitd.com  
W: www.casperitd.com

## Newport

### ABP - Port of Newport

Dock Office  
Alexandra Dock  
Newport  
Gwent  
NP20 2UW  
UK  
Contact: Mr Clive Thomas  
Job Title: Deputy Port Manager  
T: + 44 870 609 6699  
F: + 44 1633 221285  
E: cjthomas@abports.co.uk  
W: www.abports.co.uk  
South Wales

## Newport

### ABP - Port of Swansea

Dock Office  
Alexandra Dock  
Newport  
Gwent  
NP20 2UW  
UK  
Contact: Mr Clive Thomas  
Job Title: Deputy Port Manager  
T: + 44 870 609 6699  
F: + 44 1633 221285  
E: cjthomas@abports.co.uk  
W: www.abports.co.uk/swansea

## Newport

### Newport Stevedores Ltd

Eastway Road, North Dock  
Alexandra Dock  
Newport  
Gwent  
NP9 2NP  
UK  
Contact: Mr Matthew Kennerley  
Job Title: Port Director  
T: + 44 1633 220969  
F: + 44 1633 221371  
E: info@abports.co.uk

## North Killingholme

### Humber Sea Terminal

Simon Warehousing and  
Distribution  
Clough lane  
North Killingholme  
DN40 3JP  
UK  
Contact: Mr Hugh Gates  
T: + 44 1469 542 125  
F: + 44 1469 541 121  
E: hugh.gates@simonports.co.uk  
W: www.simongroup.plc.uk

## Nottingham

### Hull Bulk Handling Ltd

Fernwood House  
Fernwood Drive  
Main Road  
Watnall  
Nottingham  
NG16 1LA  
UK  
Contact: Mr Charles Holehouse  
Job Title: Managing Director  
T: + 44 11 593 893 78  
F: + 44 1482 784 895  
E: charles.holehouse@fernwood.co.uk  
W: www.hullbulk.co.uk  
North East of England on the North  
Sea, Humber Estuary  
2 x Butterley 15 tonne grab crane  
up to 1300 tph  
10 Quay, Queen Elizabeth Dock  
195m LOA.  
10.4m Draught.

25.5m Beam  
165,000 sqm  
Available on request  
Terminal is road /rail and barge  
connected see website :  
www.hullbulk.co.uk for further  
details

## Oban

### Glensanda Harbour

Yeoman Glensanda  
Rhugh Garbh Depot  
Barcaldine  
Oban  
Argyll  
PA37 1SE  
UK  
Contact: Captain John Jackson  
Job Title: Harbour Master/Pilot  
T: + 44 1631 730537  
F: + 44 1631 730460  
E: john.jackson@foster-yeoman.co.uk  
West Coast of Scotland.  
One ship loader capable of loading  
Panamax size vessels at 6 000 tph.  
Berth length 100m with mooring  
dolphins on shore. Max length  
256m - max draught 14.5 m on  
high tide.  
Approximately 7 000 000 m/t  
crushed granite aggregates are  
shipped out annually from  
Glensanda.

## Padstow

### Padstow Harbour

Commissioners  
Harbour Office  
West Quay  
Padstow  
Cornwall  
PL28 8AQ  
UK  
Contact: Mr R M Atkinson  
Job Title: Harbour Master  
T: + 44 1841 532239  
F: + 44 1841 533346  
E: padstowharbour@btconnect.com  
W: www.padstow-harbour.co.uk

## Penzance

### Penzance Harbour

Harbour Office, North Arm  
Wharf Road  
Penzance  
Cornwall  
TR18 4AH  
UK  
Contact: Mr Neil Clark  
Job Title: Harbour Master  
T: + 44 1736 366113  
F: + 44 1736 366114  
E: neil.clark@penwith.gov.uk  
W: www.penwith.gov.uk

## Perth

### Perth Harbour

Perth Harbour Office  
Friarton Road  
Perth  
Scotland  
PH2 8BB  
UK  
Job Title: Harbour Master  
T: + 44 1738 624056  
F: + 44 1738 622263  
An inland port on the east coast of  
Scotland approx. 26 miles from the  
fairway buoy on the River Tay.  
Vessels up to 90 metres accepted.  
All stevedoring and storage is  
handled by independent operators.

## Poole

### Poole Harbour Commissioners

20 New Quay Road  
Hamworthy  
Poole  
Dorset  
BH15 4AF  
UK  
Contact: Mr Jim Stewart  
Job Title: Chief Executive  
T: + 44 1202 440210  
F: + 44 1202 440212  
E: chiefexecutive@phc.co.uk  
W: www.phc.co.uk

## Port Talbot

### ABP - Port Talbot

Puckey House  
The Docks  
Port Talbot  
West Glamorgan  
SA13 1RB  
UK  
Contact: Mr Matthew Kennerley  
Job Title: Port Director  
T: + 44 870 609 6699  
F: + 44 1792 332 255  
E: mkennerley@abports.co.uk  
W: www.abports.co.uk

## Portbury

### Agricultural Bulk Services

Royal Portbury Dock  
Portbury  
Bristol  
BS20 9XL  
UK  
Contact: Mr James Reeson  
T: + 44 1275 375 777  
F: + 44 1275 374932  
E: james.reeson@bristolport.co.uk

## Portland

### Portland Port Ltd

Port Office  
Castletown  
Portland  
Dorset  
DT5 1PP  
UK  
Contact: Mr Steve Davies  
Job Title: Director and General  
Manager  
T: + 44 1305 824044  
F: + 44 1305 823045  
E: l.green.pa@portland-port.co.uk  
W: www.portland-port.co.uk  
UK SouthCoast  
50t - 15t 2 Cranes  
6t 2 Cranes  
300t 1 Crane  
13 Commercial Berths -Max  
Draft13m  
Max LOA250m  
30,000m2  
10,000m2

## Rosyth

### Port of Methil

Forth Ports PLC  
Exmouth Building  
Rosyth  
Fife  
KY11 2XP  
UK  
Contact: Mr Alan Burns  
Job Title: Port Manager  
T: + 44 1383 413 366  
F: + 44 1383 414 499  
E: alan.burns@forthports.co.uk

## Runcorn

### Manchester Ship Canal Company Ltd

Engineering Workshops  
Runcorn Docks  
Percival Lane  
Runcorn  
Cheshire  
WAT4 4UY  
UK  
Contact: Mr Dean Hammond  
Job Title: General Manager  
T: + 44 01928 508550  
F: + 44 01928 567469  
E: mail@shipcanal.co.uk  
W: www.shipcanal.co.uk

## Rye

### Rastrum Ltd

Rye Wharf  
Harbour Road  
Rye  
East Sussex  
TN31 7TE  
UK  
Contact: Mr Rod Chapman  
Job Title: Director  
T: + 44 1797 224778  
F: + 44 1797 223650  
E: rodc@ryewharf.co.uk  
W: www.ryewharf.co.uk  
South East Coast of England  
Mechanical Handling 500tph  
2 x 2,500 tonnes  
50,000sqm  
30,000sqm

## Seaham

### Seaham Harbour Dock Company

Cargo Durham Distribution Centre  
Seaham  
Durham  
SR7 7NZ  
UK  
Contact: Mr Alan Luscombe  
Job Title: Managing Director  
T: + 44 191 516 1700  
F: + 44 191 516 1701  
E: alanluscombe@victoriagroup.co.uk  
W: www.portofseaham.demon.co.uk

## Sharpness

### Port of Sharpness

c/o Sharpness Docks Ltd  
Sharpness  
Gloucester  
GL13 9UX  
UK  
Contact: Mr Garry Strickland  
Job Title: General Manager/Director  
T: + 44 1453 811644  
F: + 44 1453 811990  
E: info@sharpnessdock.co.uk  
South West England Bristol  
Channel  
4 x Portal cranes at 6.0 mts  
capacity  
1 x Cement pump  
2 x Grain elevators  
3 x WCK mobile cranes  
200 mts per hour  
14 berths - 6 metres draft  
50 000 sqm  
250 000 sf  
2 x Grain export silos with  
combined capacity of 16 000  
tonnes

## Silloth

### ABP - Port of Silloth

Dock Office  
New Dock  
Silloth  
Cumbria  
CA7 4JQ  
UK  
Contact: Captain C Puxley  
Job Title: Harbour Master & Port  
Superintendent  
T: + 44 1697 331358  
F: + 44 1697 332709  
E: silloth@abports.co.uk  
W: www.abports.co.uk

## South Shields

### Port of Tyne

Maritime House  
Tyne Dock  
South Shields  
Tyne & Wear  
NE34 9PT  
UK  
Contact: Mr Andy Fulds  
Job Title: Commercial Manager  
T: + 44 191 455 2671  
F: + 44 191 454 1460  
E: andy.fulds@portoftyne.co.uk  
W: www.portoftyne.co.uk  
Riverside Quay, north east of



England on the north east coast  
 Location - South Side River Tyne  
 54 degrees 59.13'N 001 degrees  
 27.3'W (Chart BA 1934)  
 Distance to sea 2.2 miles  
 · 6.9 ha Container Terminal  
 · Heavy duty harbour mobile  
 cranes and associated equipment  
 (Gottwald and Liebherr)  
 · Heavy-duty mobile loading  
 shovels  
 · Fork lift trucks  
 · Pallet storage: 58,000 pallet  
 slots available  
 · Intermodal rail terminal and  
 in-house distribution fleet  
 Riverside Quay: 574m long Depth  
 of Water 12.1m below Chart Datum  
 20,000sqm Customs Approved  
 open storage area  
 21,000sqm Customs Approved  
 transit shed storage  
 The Port of Tyne is a deep river  
 port open 24 hours/7 days a week  
 and situated to the A1, M1, A19  
 road links and with a rail terminal  
 linking to the main London  
 Edinburgh rail network.

**Southampton**

**ABP - Southampton**  
 Ocean Gate  
 Atlantic Way  
 Eastern Docks  
 Southampton  
 SO1 1XQ  
 UK  
 Contact: Mr Douglas Morrison  
 Job Title: Port Director  
 T: + 44 2380 48 88 00  
 F: + 44 2380 33 64 02  
 E: dmorrison@abports.co.uk  
 W: www.abports.co.uk

**Southampton**

**Solent Stevedores Ltd**  
 King George V Dock  
 Western Avenue  
 Western Docks  
 Southampton  
 Hampshire  
 SO15 0HH  
 UK  
 Contact: Mr Stuart Cullen  
 Job Title: Managing Director  
 T: + 44 1453 544 449  
 F: + 44 1453 549 149  
 E: stuart@solentstevedores.com  
 W: www.solentstevedores.co.uk  
 Southampton on the Solent,  
 Hampshire: Silvertown on the  
 Thames, London  
 Mobile harbour cranes, quay  
 cranes, conveyor system, quayside  
 equipment, 4 x public weighbridges  
 75,000sqm  
 20,000sqm

**Southampton**

**Southampton Grain Terminal Ltd**  
 Gate 4 Berth 36  
 Test Road  
 Eastern Docks  
 Southampton  
 SO14 3GG  
 UK  
 Contact: Mr Richard Pollard  
 Job Title: Director  
 T: + 44 2 380 334433  
 F: + 44 2 380 330657  
 E: richard.pollard@sgtsilos.co.uk  
 South of England on English  
 Channel  
 Ship loader at up to 1,000tph  
 36 Berth vessels up to 220m - tidal  
 min 9.3m  
 Not applicable  
 Concrete silos - 28,000t  
 Vessels up to 235m may be  
 accommodated

**Sunderland**

**Port of Sunderland**  
 Capstan House  
 Greenwells Quay  
 South Docks  
 Barrack Street  
 Sunderland  
 Tyne & Wear  
 SR1 2BU  
 UK  
 Contact: Mr Matthew Hunt  
 Job Title: Port Director  
 T: + 44 191 553 2100  
 F: + 44 191 553 2120  
 E: ian.duncan@  
 portofsunderland.org.uk  
 W: www.portofsunderland.org.uk  
 North East of England on the East  
 Coast  
 East Quay South, Hudson Dock:  
 183m long, 5.5m draught  
 6 400 sqm  
 Nil  
 Current bulk materials are  
 accommodated on a self-handled  
 basis. All berths are serviced by a  
 crawler crane if required.

**Swansea**

**ABP Harbour Office**  
 Lock Head  
 King's Dock  
 Swansea  
 West Glamorgan  
 SA1 1QR  
 UK  
 Contact: Mr Clive Thomas  
 Job Title: Deputy Port Manager  
 T: + 44 870 609 6699  
 F: + 44 1792 332255  
 E: cjthomas@abports.co.uk  
 W: www.abports.co.uk  
 South Wales

**Teignmouth**

**ABP - Teignmouth**  
 Teignmouth  
 Devon  
 UK  
 Contact: Mr Colin Greenwell  
 Job Title: Port Manager  
 T: + 44 1626 774044  
 F: + 44 1626 776240  
 E: teignmouth@abports.co.uk

**Tilbury**

**Port of Tilbury London Limited**  
 Lesley Ford House  
 Tilbury FreePort  
 Tilbury  
 Essex  
 RM18 7EH  
 UK  
 Contact: Mrs Tracey Sampson  
 T: + 44 1375 852 200  
 F: + 44 1375 855 106  
 E: caroline.gerrard@potll.com  
 W: www.forthports.co.uk

**Tilbury**

**Port of Tilbury London Ltd -  
 Grain Terminal**  
 Tilbury FreePort  
 Tilbury  
 Essex  
 RM18 7EH  
 UK  
 Contact: Mr Peter Ward  
 Job Title: Senior Asset Manager -  
 Grain & Bulks  
 T: + 44 1375 852485  
 F: + 44 1375 852250  
 E: peter.ward@potll.com  
 W: www.forthports.co.uk/ports/tilbury/  
 South East England  
 2 continuous unloaders, 2,000mt per  
 hour.  
 2 harbour mobile grab cranes.  
 Grain 12.5m. Bulks 10.5m  
 120,000 silos.  
 80,000 flat stores.  
 1 Grain Terminal for import/export.

2 Bulk Handling berths.

**Tilbury**

**Stema Shipping UK**  
 Powell Duffryn House  
 21 Berth  
 Tilbury Docks  
 Tilbury  
 Essex  
 RM18 7JT  
 UK  
 Contact: Mr Terje Johansen  
 T: + 44 1375 857890  
 F: + 44 1375 857456  
 E: enquiries@stema.co.uk  
 W: www.stema.co.uk

**Warrenpoint**

**Warrenpoint Harbour Authority**  
 The Docks  
 Warrenpoint  
 Co Down  
 BT34 3JR  
 UK  
 Contact: Mr Kerin Grant  
 Job Title: Operations Director  
 T: +44 28 4175 2878  
 F: + 28 4175 2875  
 E: bmcjury@warrenpointharbour.co.uk  
 East Coast - Northern Ireland  
 4 Mobile, 2 Grantry - up to 43  
 tonnes swc  
 6 Berths

**Whitstable**

**Whitstable Harbour**  
 Harbour Office  
 Whitstable  
 Kent  
 CT5 1AB  
 UK  
 Contact: Mr Michael Weir  
 Job Title: Port Manager & Harbour  
 Master  
 T: + 44 1227 274086  
 E: whitstable.harbour@  
 canterbury.gov.uk  
 W: http://whitstable.seapublish.co.uk/  
 South East Kent  
 Cranes to be hired from private  
 contractor  
 West Quay 170m  
 East Quay 140  
 5700 sqm

**Wolverhampton**

**Tarmac Limited**  
 Millfields Road  
 Ettingshall  
 Wolverhampton  
 West Midlands  
 WV4 6JP  
 UK  
 Contact: Mr Paul Burgess  
 Job Title: Production Manager  
 T: + 44 1206 332 464  
 E: enquiries@tarmac.co.uk  
 W: www.tarmac.co.uk/

**Workington**

**Port of Workington**  
 Cumbria County Council  
 Prince of Wales Dock  
 Port of Workington  
 Workington  
 Cumbria  
 CA14 2JH  
 UK  
 Contact: Mr Colin Sharpe  
 Job Title: Business Development  
 Manager  
 T: + 44 1900 602301  
 F: + 44 1900 604696  
 E: gateway@portofworkington.co.uk  
 W: www.portofworkington.gov.uk  
 North West of England on the  
 Cumbrian coast  
 Up to 12,000 tonne DWAT  
 7 berths 772m total inc. ro-ro  
 20,000sqm  
 6,500sqm

Bulk, break bulk, project cargo,  
 containers across sea, rail and  
 road. In-house stevedoring and  
 marine section.

**UKRAINE**

**Berdiansk**

**Berdiansk Port Authority**  
 13/7 Maxim Gorky Street  
 Berdiansk  
 Zaporozhie Province  
 71112  
 Ukraine  
 Contact: Mr Anatolij Reznikov  
 Job Title: Director General  
 T: + 380 61 53 32210  
 F: + 380 61 53 36593  
 E: post@bstport.berdiansk.net  
 W: www.ukrport.org.ua/p-berdiansk-  
 e.htm

**Ilichevsk**

**Port of Ilichevsk Authority**  
 6 Trouda Square  
 Ilichevsk  
 270901  
 Ukraine  
 T: +380 48 68 691 600  
 F: +380 48 68 693 606  
 E: pm@ilport.com.ua

**Izmail**

**Commercial Sea Port of Izmail**  
 Str. Portovaya 7  
 Izmail  
 68600  
 Ukraine  
 Contact: Mr Valentin F Kotelnj  
 Job Title: Port Director  
 T: + 380 4841 25601  
 F: + 380 4841 26258  
 E: ves@izmpport.com.ua

**Kerch**

**The Kerch Merchant Port**  
 28 Kirova Street  
 Kerch  
 Crimea  
 334512  
 Ukraine  
 T: + 380 654 777-83-80  
 F: + 380 654 35-64-01  
 E: ukrport@ukrport.org.ua  
 W: www.ukrport.org.ua

**Kyiv**

**PORTINVEST LLC**  
 Velyka Vasylykivska street 77A  
 Kyiv  
 Kyiv  
 03150  
 Ukraine  
 Contact: Ms Olena Svitlychna  
 Job Title: PR-Manager  
 T: + 38 044 581 81 24  
 F: + 38 050 359 95 00  
 E: olena.svitlychna@  
 portinvest.com.ua  
 W: www.portinvest.com.ua

**Mariupol**

**Mariupol Sea Commercial Port**  
 99, Admiral Lunin Avenue  
 Mariupol  
 Donetsk Region  
 87510  
 Ukraine  
 Contact: Mr Aleksandr Oleynik  
 Job Title: Director of the Port  
 T: + 380 629 408 634  
 F: + 380 629 408 660  
 E: mail@marport.net  
 W: www.marport.net  
 South East of Ukraine, North West  
 part of Taganrog Gulf of the Sea of  
 Azov,  
 14 miles from the gulf entry  
 Portal cranes 5-50 tn capacity  
 Floating cranes 100-150 tn capacity

Container loaders 40 tn capacity  
 18 Berths TOTAL, 8 Berths - BULK  
 cargo, 10 Berths - GENERAL cargo  
 270,033.3 sqm  
 14,073.3 sqm  
 Mariupol Port is one of the leading  
 ports in Ukraine on mechanization,  
 hydro-engineering construction. It is  
 one of 3 Ukrainian largest ports as  
 to dry cargo handling volumes.

**Nikoleav**

**Nikolayev Port Authority**  
 23 Zavodskaya Street  
 Nikoleav  
 327004  
 Ukraine  
 Job Title: Port Director  
 T: + 380 512 508 400  
 F: + 380 512 508 807  
 E: nmp@portnikolaev.com  
 W: www.portnikolaev.com

**Odessa**

**Odessa Port Silo**  
 4 Khebnaya Gavan  
 Odessa  
 65003  
 Ukraine  
 Contact: Mr Igor A. Zubrich  
 Job Title: Director  
 T: +380 48 723 24 60  
 F: + 380 48 741 14 21  
 E: portelevator@paco.net  
 W: www.portelevator.odessa.ua/eng/  
 photogallery.html

**Odessa**

**Port of Odessa Authority**  
 1 Vakulenchuk Square  
 Mersky Port  
 Odessa 27004  
 Ukraine  
 Contact: Mr AP Kharitoshin  
 Job Title: Harbour Master  
 T: + 380 482 218081  
 F: + 380 482 348328  
 E: info@portgdansk.pl

**Odessa**

**PortInvest**  
 11 Polskiy Uzviz  
 Odessa 65026  
 Ukraine  
 Contact: Mr Ilya Cerkasskis  
 Job Title: Project Manager  
 T: + 38 048 740 04 06  
 F: + 38 048 710 04 01  
 E: ilja.cerkasskis@portinvest.com.ua  
 W: www.portinvest.com.ua

**Odessa**

**Transinvestservice (TIS) Ltd**  
 50 Chapayev Str  
 Vizirka Village  
 Kominternovo District  
 Odessa  
 67543  
 Ukraine  
 Contact: Mr Andrey Stavnitser  
 Job Title: Deputy Director  
 T: + 380 482 300 711  
 F: + 380 482 300 735  
 E: mail@tis.ua  
 W: www.tis.ua  
 Yuzhny port, North Coast of the  
 Black Sea  
 Total truck discharge- 1000  
 trucks/day.  
 Total RW discharge - 1000  
 wagons/day  
 5 million tonnes per year  
 Depth 14m. Length 760m  
 Vessel size limitation: Capesize  
 DWT up to 130,000 tons  
 Total storage: 770,000 mt  
 380,000 tonnes - total storage for  
 grains  
 20,000 sqm  
 65,000 sqm

**Port of Kilia**

**Kiliya Transshipment Point**  
4 Zheleznyakova Street  
Port of Kilia  
Odessa Region  
683000  
Ukraine  
Contact: Mr Bladimir Chernobykin  
Job Title: Managing Director  
T: + 38 04843 238 81  
F: + 38 04843 237 03  
E: kilport kiliya.uptel.net

**Reni**

**Port of Reni**  
188 Dunayskaya Str.  
Reni  
Odessa  
68802  
Ukraine  
Contact: Mr Yuriy Pishchalo  
Job Title: Manager of Marketing and Commerce Dpt  
T: + 380 4840 42652  
F: + 380 4840 26739  
E: ovspport@reni.uptel.net  
W: www.portreni.com.ua  
South-west of Ukraine at the junction of the Ukrainian, Romanian and Moldovian borders, at the crossing of 4 transport corridors: Cretan No. 7 and No. 9, Euro-Asian and Black Sea.  
2 x cranes, lifting capacity 36t and 250t  
3 x floating cranes, lifting capacity 5t, 16t and 100t  
Variety of gantry cranes, fork lift trucks, bucket loaders etc.  
39 specialised berths, handling cargoes including general, bulk, and loose bulk.  
Vessel size limitation - draught enabling passage along Sulinsky Canal (7 m.), which connects the Danube with the Black Sea.  
195,000sqm  
30,000sqm

**Vikovo**

**Port of Ust-Dunaysk**  
2 Pridunayskaya Street  
Vikovo  
Odessa  
272626  
Ukraine  
Contact: Mr Pavel V Kosinets  
Job Title: General Director  
T: + 380 4843 31135

**Yalta**

**Yalta Sea Trade Port Authority**  
5 President F D Roosevelt Street  
Yalta  
Crimea  
334200  
Ukraine  
Contact: Mr Sergiy Tarakanov  
Job Title: General Manager  
T: + 380 654 230 065  
F: + 380 654 323 926  
E: yasco@mail.ylt.crimea.com

**Yuzhny**

**JV Transinvestservice TIS**  
Chapayeva Str  
50 v Vizirka  
Kominter-Novskii District  
Yuzhny  
Odessa Region  
67543  
Ukraine  
Contact: Mr Oleg Sologul  
Job Title: Industrial Engineer  
T: + 380 482 725711  
F: + 380 480 300735  
E: mail@tis.ua  
W: www.tis.ua

**Yuzhny**

**Port Yuzhny**  
Bulk and General Cargo Terminal  
Yuzhny  
Odessa Region  
65481  
Ukraine  
Contact: Mr V Ivanov  
Job Title: General Port Director  
T: +380 487 507 254  
F: + 380 48 750 7254  
E: boss@port-yuzhny.com.ua  
W: www.port.yuzhny.odessa.ua

**UNITED ARAB**

**EMIRATES**

**Abu Dhabi**

**E-ships Oldendorff Logistics**  
Villa 15/2  
4th Street  
Zone 1 Sector 15  
Abu Dhabi  
112575  
United Arab Emirates  
T: + 971 2 642 03 67  
F: + 971 2 642 03 57  
W: http://www.eol.ae/

**URUGUAY**

**Montevideo**

**Corporación Navios S.A.**  
Juan Carlos Gomez 1445 esc 701  
esquina 25 de Mayo  
Montevideo  
Montevideo  
11.000  
Uruguay  
Contact: Mr Pablo Soler Brusa  
Job Title: General Manager  
T: + 598 2 9163310  
F: + 598 2 9162874  
E: psoler@naviosterminals.com  
W: www.naviosterminals.com

**Montevideo**

**Paysandu Coordinadora de Puertos Uruguay**  
Administracion Nacionala de Puertos  
Rambla 25 de Agosto de 1825 No 160  
Montevideo  
Uruguay  
Job Title: Port Director  
T: + 598 2917 0731  
F: + 598 2916 0754  
E: info@puertos.com.uy  
W: http://puertos.com.uy

**Montevideo**

**T.G.U.S.A. Uruguayan Grain Terminals**  
Rondeau Ave 1908 .5  
Montevideo  
11800  
Uruguay  
Contact: Mr A Deambrosi  
Job Title: President  
F: + 598 2929 0603  
W: www.tgu.com.uy

**Nueva Palmira**

**Terminal Nueva Palmira**  
Ruta 12km  
Nueva Palmira  
Uruguay  
Contact: Mr R R Grien  
T: + 5982 628 80 59  
F: + 5982 628 65 62  
E: rgrien@anp.com.uy  
W: www.tgu.com.uy

**Rio Negro**

**Terminal Fray Bentos**  
Puerto Fray Bentos  
Rio Negro  
Uruguay  
F: + 598 4562 7428  
W: www.tgu.com.uy

**USA**

**Aberdeen**

**Port of Grays Harbor**  
PO Box 660  
Aberdeen  
Washington  
98520-0141  
USA  
Contact: Mr Seth Taylor  
Job Title: Marine Terminal Manager  
T: + 1 360 533 9528  
F: + 1 360 533 9505  
E: staylor@portgrays.org  
W: www.portofgraysharbor.com  
PNW North America  
Dry bulk loader 1200mtp  
Terminal 2, 600', -41MLLW  
160,000sqm  
6,500sqm

**Albany**

**Albany Port District Commission**  
Administration Building  
Port of Albany  
Albany  
NY 12202  
USA  
Contact: Mr Rich Hendrick  
Job Title: General Manager  
T: + 1 518 463 8763  
F: + 1 518 463 8767  
E: Rhendrick@portofalbany.us  
W: www.Portofalbany.us  
124 miles north of New York Harbor on the Hudson River.  
Forklifts and cranes of various capacities.  
1 grain berth of 228m in length with a draught of 9.45m and various multi-use berths.  
8 ha.  
27,900 sqm

**Albany**

**Port of Albany**  
106 Smith Boulevard  
Albany  
NY  
12202  
USA  
Contact: Mr Anthony Vasil  
Job Title: Business Development and Marketing Manager  
T: + 1 518 463 8763  
E: tvasil@portofalbany.us  
W: http://www.portofalbany.us/

**Alexandria**

**American Association of Port Authorities (AAPA)**  
1010 Duke Street  
Alexandria  
VA  
22314  
USA  
Contact: Mr Aaron Ellis  
Job Title: Public Affairs Director  
T: + 1 703 684 5700  
F: + 1 703 684 6321  
E: aeellis@aapa-ports.org  
W: www.aapa-ports.org  
Trade association representing ports throughout the Western Hemisphere.

**Ama**

**ADM Gromark-Destrehan**  
PO Box 120  
Ama  
LA 70031  
USA  
Contact: Ms Ruth Sacra

T: + 1 504 431 8245  
F: + 1 504 431 7275  
E: ruth\_sacra@admworld.com

**Anacortes**

**Metro Ports**  
PO Box 406  
Anacortes  
WA  
98221  
USA  
Contact: Mr Tony Johnson  
Job Title: Anacortes Operations  
T: + 1 360 299 2931  
F: + 1 360 299 3932  
E: info@metroports.com  
W: www.metroports.com  
Port of Anacortes

**Anacortes**

**Metro Ports**  
Pier 2  
Port of Anacortes  
Anacortes  
Washington  
98221  
USA  
Contact: Mr Tony Johnson  
Job Title: Terminal Superintendent  
T: + 1 360 299 2931  
F: + 1 360 299 3932  
E: Tony.johnson@metroports.com  
W: www.metroports.com  
USA; Pacific Northwest  
1,100 MT/Hour shiploader (fixed)  
Max depth 13.4m, Wharf Length 140.8/345.3m (dolphine)  
Truck access; truck wash

**Anacortes**

**Port of Anacortes**  
100 Commercial Ave  
Anacortes  
WA  
98221  
USA  
Contact: Mr Josh Beaner  
Job Title: Marine, Security & Aviation Services Manager  
T: + 1 360 299 1828  
F: + 1 360 293 9608  
E: josh@portofanacortes.com  
W: www.portofanacortes.com  
Pacific Northwest  
Mobile Bulk Outloader 380tph  
1 berth:465',1,028' w/dolphins  
5.5 acres  
0.75 acre  
We have two other terminals mainly used for lay status and Drop and Vac's.

**Anchorage**

**North Star Terminal Stevedore Company**  
PO Box 102019  
Anchorage  
AK 99501  
USA  
Contact: Mr Steve Post  
Job Title: Manager  
T: + 1 907 272 7537 X117  
F: + 1 907 272 8755  
W: www.northstarak.com

**Anchorage**

**Port of Anchorage**  
2000 Anchorage Port Road  
Anchorage  
Alaska  
AK 99501  
USA  
Contact: Mr Richard Wilson  
Job Title: Port Director  
T: + 1 907 343 6200  
F: + 1 907 277 5636  
E: port@ci.anchorage.ak.us  
W: www.portofalaska.com  
Anchorage, Alaska

**Arabi**

**Associated Terminals of St Bernard**  
8000 St. Bernard Hwy  
Reserve  
Arabi  
Louisiana 70032  
USA  
Contact: Mr Zeljko Franks  
Job Title: Vice President  
T: + 1 504 277 5101  
F: + 1 504 279 8353  
E: zfranks@associatedterminals.com  
W: www.associatedterminals.com  
Lower Mississippi River miles 86 to 91  
Fleet of midstream stevedoring cranes, dock cranes, conveyors, mobile equipment  
Four midstream berths, one set of mooring dolphins, and wharves for handling bulk and general cargoes  
150,000 sq ft  
240,000 sq ft  
ATSB is the major terminal facility on the Mississippi River handling both bulk and breakbulk cargoes. Multiple docks and berths, as well as warehouses for bulk and breakbulk, rail and truck connections make ATSB the right choice for shippers.

**Argo**

**Kinder Morgan Terminals**  
Midwest Regional Office  
8500 West 68th Street  
Argo  
Illinois  
60501  
USA  
Contact: Mr Brian Feyereisen  
Job Title: Commercial Director  
T: + 1 708 496 2890  
F: + 1 708 496 2888  
E: Brian\_Feyereisen@kindermorgan.com  
W: www.kindermorgan.com

**Baltimore**

**Baltimore Terminal**  
CNX Marine Terminals Inc.  
3800 Newgate Avenue  
Baltimore  
Maryland  
MD 21224-6404  
USA  
Contact: Mr Chris Marsh  
Job Title: Vice President  
T: + 1 410 631 6426  
F: + 1 410 631 6425  
E: chrismarsh@consolenergy.com  
W: www.consolenergy.com

**Baltimore**

**Maryland Port Administration**  
The World Trade Centre  
Baltimore  
Maryland  
21202-304  
USA  
Contact: Mr Louis LoBianco  
T: + 1 410 385 4455  
F: + 1 410 333 1126  
E: sras@mdot.state.md.us  
W: www.mpa.state.md.us

**Baltimore**

**Port of Baltimore**  
Maryland Port Administration  
World Trade Center  
401 East Pratt Street  
Baltimore  
MD 21202-3041  
USA  
Contact: Mr Richard Scher  
Job Title: Director of Communications  
T: + 1 410 385 4483  
F: + 1 410 385 4485  
E: rscher@marylandports.com



**Baltimore**

**Rukert Terminals Corp**  
2021 S. Clinton St  
PO Box 5163  
Baltimore  
MD  
21224  
USA  
Contact: Mr John Coulter  
T: + 1 410 276 1013  
F: + 1 410 327 2315  
E: john@rukert.com  
W: www.rukert.com  
Rukert Terminals is located on the Northwest branch of the Patapsco River, a tributary of the Chesapeake Bay. Baltimore gains great advantage over other East Coast ports with a geographic location that is closest to the U. S. Midwest.  
4 cranes  
1 Rapid discharge Bulk Unloader 400tph  
2 175 ton Crawlers  
1 70 ton Mobile  
Pier 5 Bulk (PECO Gantry Crane)  
875 feet 39.5 feet  
Lazaretto A Bulk / Break-Bulk / Containers 525 feet 35 feet  
Pier C Break-Bulk / Special Projects 1000 feet 35  
160,000 sqm  
112,000 sqm  
Since 1921, Rukert Terminals Corporation has been a privately-owned and operated company which specializes in the handling of metals, ores, fertilizers, alloys, and other dry bulk and break-bulk cargoes. Services include stevedoring, warehousing, and transfer to and from vessel, rail or truck.

**Baton Rouge**

**Louisiana Mid-Stream Terminals, LLC**  
8280 YMCA Plaza Drive #2  
Baton Rouge  
LA  
70810  
USA  
T: + 1 225 324 6038  
F: + 1 225 767 9648  
E: traffic@lamidstream.com  
W: www.cooperconsolidated.com  
Mississippi River, Milepost 134, LaPlace, Louisiana  
Mechanical Sampling, Magnet, 20000TPD  
Mid-Stream Buoys  
In Barges  
N/A  
LMO (Louisiana Mid-Stream One) floating terminal.

**Bayonne**

**Duraport Marine & Rail Terminal, LLC**  
PO Box 1009  
Bayonne  
New Jersey  
07002  
USA  
Contact: Mr Vincent Alessi  
Job Title: President  
T: + 1 201 437 0703  
F: + 1 201 437 0158  
E: vincealessi@aol.com

**Beaumont**

**Beaumont Bulk Terminal Inc**  
1399 Carroll Street  
Beaumont  
Texas  
77701  
USA  
Contact: Mr Rusty Harris  
T: + 1 409 839 4888  
F: + 1 409 835 0838  
E: dahrel\_harris@kindermorgan.com

W: www.tgsgroup.com

**Beaumont**

**Port of Beaumont**  
PO Drawer 2297  
1255 Main St  
Beaumont  
Texas  
USA  
Contact: Mr John Roby  
Job Title: Transportation Manager  
T: + 1 409 835 5367  
F: + 1 409 835 0512  
E: jrr@portofbeaumont.com  
W: www.portofbeaumont.com

**Bellingham**

**Port of Bellingham**  
PO Box 1677  
1801 Roeder Avenue  
Bellingham  
WA  
98277  
USA  
Contact: Mr Dan Stahl  
Job Title: Director of Marine Services  
T: + 1 360 676 2500  
F: + 1 360 671 6411  
E: dans@portofbellingham.com  
W: www.portofbellingham.com  
North Puget Sound - 15 miles south of Canadian Border  
1600 ft of berthing area of 32' depth  
35,000 sqm  
8,000 sqm

**Benicia**

**Port of Benicia Authority**  
PO Box 315  
Benicia  
CA  
94510  
USA  
Contact: Mr Jimmy Triplett  
Job Title: Port Manager  
T: + 1 707 745 2394  
F: + 1 707 746 1485  
E: jtriplett@amports.com  
W: www.amports.com  
San Francisco Bay Area, California, USA

**Boston**

**Massport Maritime Department**  
One Harborside Drive  
Boston  
MA  
02128-2909  
USA  
Contact: Ms Lynn Vikesland  
Job Title: Market Research Manager  
T: + 1 617 946 4429  
F: + 1 617 946 4466  
E: lvikesland@massport.com  
W: www.massport.com

**Braithwaite**

**Plaquemines Port**  
Harbour & Terminal District  
124 Edna LaFrance Road  
Braithwaite  
LA  
70040  
USA  
Contact: Mr John L Pennison  
Job Title: Port Manager  
T: + 1 504 682 7920  
F: + 1 504 682 0649  
E: plaqport@bellsouth.net  
W: www.portofplaquemes.com  
Lower Mississippi River South of New Orleans, La., Mid-Gulf Coast

**Bridgeport**

**Bridgeport Port Authority**  
330 Water Street  
Bridgeport  
CT  
06604

USA  
Contact: Mr Joseph C Savino Jr  
Job Title: Harbour Master  
T: + 1 956 831 4592  
F: + 1 956 831 5006  
E: bpt.port.auth@snet.net  
W: www.portconneticut.com

**Brownsville**

**Port of Brownsville**  
1000 Foust Rd.  
Brownsville  
Texas  
78521  
USA  
Contact: Mr Eduardo Campirano  
Job Title: CEO & Port Director  
T: + 1 956 831 4592  
F: + 1 956 831 5006  
E: eacampirano@portofbrownsville.com  
W: www.portofbrownsville.com

**Brunswick**

**Marine Port Terminals Inc**  
225 Newcastle Street  
Brunswick  
GA  
31520  
USA  
Contact: Mr David Proctor  
Job Title: Terminal Manager  
T: + 1 912 264 4044 x238  
F: + 1 912 267 6352  
E: dproctor@logistec.com

**Buffalo**

**Port of Buffalo**  
Gateway Metroport  
PO Box 880  
2544 Clinton Street  
Buffalo  
New York  
14224  
USA  
Contact: Mr Jim Pfohl  
Job Title: Port Director  
T: + 1 716 826 2890  
F: + 1 716 826 1342  
E: jpfohl@buffalocrushedstone.com  
Lackawanna, New York south of Buffalo on Lake Erie.  
60,000 sqm  
None currently available.

**Burlingame**

**Ports America**  
1270 Drake Avenue  
Burlingame  
CA  
94010  
USA  
Contact: Mr Peter Stone  
T: + 1 510 749 7400  
F: + 1 510 769 9626  
W: http://www.portsamerica.com/  
US West Coast, South & Mid-Atlantic

**Camden**

**Delaware River Port Authority**  
One Port Centre  
2 Riverside Drive  
Camden  
NJ 08101  
USA  
Contact: Mr Raymond A Lawler  
Job Title: Asst. Director  
T: + 1 856 968 2000  
F: + 1 856 968 2226  
E: info@lists.drpa.org

**Camden**

**South Jersey Ports Corp**  
PO Box 129  
2500 Broadway  
Camden  
NJ  
08104  
USA  
Contact: Mr Joseph A Balzano

T: + 1 856 757 4969  
F: + 1 856 757 4903  
E: sjpc@southjerseyport.com

**Canonsburg**

**CONSOL Energy Inc.**  
CNX Center  
1000 Consol Energy Drive  
Canonsburg  
PA  
15317-6506  
USA  
Contact: Mr Christopher Marsh  
Job Title: General Manager  
T: + 1 410 631 6419  
E: regispetermel@consolenergy.com  
W: www.consolenergy.com

**Cape Canaveral**

**Port Canaveral**  
Canaveral Port Authority  
445 Challenger Road  
Suite 301  
Cape Canaveral  
FL  
32920  
USA  
Contact: Mrs Shannon Feeley  
Job Title: Senior Manager, Business Development  
T: + 1 321 783 7831  
F: + 1 321 783 3748  
E: SFeeley@portcanaveral.com  
W: www.portcanaveral.com  
Center of State of Florida, on Atlantic Ocean; due East of Orlando  
Bulk conveyors, breakbulk facilities available, waterfront refrigerated warehousing. Land available.  
South Cargo Piers 4 & 5 at 12 meters draught MLW  
North Cargo Piers 1, 2, 3, & 4 at 12 meters draft MLW  
101,175sqm  
70,000sqm  
We've handled bulk and breakbulk since 1955. See our website www.portcanaveral.com for more information.

**Carteret**

**Kinder Morgan Liquid Terminals, LLC**  
1 Terminal Road  
Carteret  
New Jersey  
07008  
USA  
Contact: Mr Scott Johnston  
Job Title: Director, Business Development  
T: + 1 732 969 5721  
F: + 1 732 969 3575  
E: scott\_johnston@kindermorgan.com

**Caruthersville**

**Pemiscot County Port Authority**  
111 E 3rd Street  
Caruthersville  
MO 63830  
USA  
Contact: Mr David P. Madison  
Job Title: Director  
T: + 1 573 333 4125  
F: + 1 573 333 4216  
E: pemiscotport@yahoo.com  
W: www.pemiscotport.com  
Lower Mississippi River mile 849.9  
Public dock; tower crane  
Nine (9) barge berths  
Rail access; two interstate highways; many large available sites

**Catoosa**

**Gavilon Fertilizer, LLC**  
5640 W Channel Road  
Catoosa  
Oklahoma  
74015

USA  
Contact: Mr Matt Benda  
Job Title: Terminal Manager  
T: + 1 918 266 1244  
F: + 1 918 266 6129  
E: matthew.benda@gavilon.com  
River mile 445 on the Arkansas River  
70,000t  
Other commodities handled: salt

**Catoosa**

**Tulsa Port of Catoosa**  
5350 Cimarron Road  
Catoosa  
OK 74015 - 3027  
USA  
Contact: Mr Robert W Portiss  
Job Title: Port Director  
T: + 1 918 266 2291  
F: + 1 918 266 7678  
E: bob@tulsaport.com  
W: www.tulsaport.com  
Central US.  
See website  
See website  
10 acres  
80,000 short tons

**Ceredo**

**Kanawha River Terminal Inc**  
Main and River  
PO Box 308  
Ceredo  
West Virginia  
25507  
USA  
Contact: Mr Matt Gaston  
Job Title: Manager  
T: + 1 304 526 0753  
F: + 1 304 453 5521

**Charleston**

**Kinder Morgan Terminals - Pier IX Terminal**  
Mid Atlantic Regional Office  
1801 Milford Street  
Charleston  
South Carolina  
29405  
USA  
T: + 1 843 843 0543  
F: + 1 843 853 3367  
W: www.kindermorgan.com

**Charleston**

**Kinder Morgan Terminals - Shipyard River Terminal**  
Mid Atlantic Regional Office  
1801 Milford Street  
Charleston  
South Carolina  
29405  
USA  
T: + 1 843 843 0543  
F: + 1 843 853 3367  
W: www.kindermorgan.com

**Charleston**

**Port of Charleston**  
South Carolina State Ports Authority  
PO Box 22287  
Charleston  
SC  
29413  
USA  
Contact: Mr Fred Stribling  
Job Title: VP Marketing & Sales  
T: Port of Bellingham  
F: + 1 843 577 8710  
E: SCSPAMktg\_Sales@scspa.com

**Charleston**

**Stevens Shipping & Terminal Co**  
PO Box 22826  
Charleston  
SC  
29413-2826  
USA  
Contact: Mr Norman Massey

# LOGISTICS WITHOUT BARRIERS.



The dynamic power of teamwork with asset-driven logistics.



[cooperconsolidated.com](http://cooperconsolidated.com)

STEVEDORING | BARGE | TRUCK | RAIL | OCEAN | INLAND TERMINALS

[sales@cooper-consolidated.com](mailto:sales@cooper-consolidated.com) 985-871-4403



Job Title: Operations Manager  
T: + 1 912 651 4000  
F: + 1 843 527 4577

**Charlotte**

**CSX World Terminals**

2101 Rexford Road  
Suite 250 West  
Charlotte  
North Carolina  
28211  
USA

Contact: Mr Gert De Piper  
Job Title: Senior Vice President,  
Chief  
T: + 1 704 973 7200  
F: + 1 704 9737246  
W: www.csxwt.com

**Chesapeake**

**Kinder Morgan Elizabeth River Terminals**

4100 Buell Street  
Chesapeake  
VA 23324  
USA

Contact: Ms Jennifer Darden  
T: + 1 757 543 0335  
F: + 1 757 543 8936  
E: jennifer\_darden@  
kindermorgan.com  
W: www.kindermorgan.com  
Southern Branch Elizabeth River  
2x 100'0 berths @ 35'  
110 acre terminal  
Over 600,000 sq feet  
Storage and handling, including  
valve added services, of dry bulk  
materials.

**Chicago**

**Illinois International Port Dist.**

3600 East 95th Street  
Chicago  
IL  
60617  
USA

Contact: Mr Anthony G Ianello Jnr  
Job Title: Executive Director  
T: + 1 773 646 4400  
F: + 1 773 221 7678  
E: iipd@iipd.com  
W: www.iipd.com  
South of Chicago on Lake Michigan  
and the Calumet River.

**Chicago**

**KCBX Terminals Company**

10730 South Burley Ave.  
Chicago  
IL  
60617  
USA

Contact: Mr Tom Kramer  
Job Title: General Manager  
T: + 1 773 933 5302  
F: + 1 773 933 5309  
E: kramert@kochind.com  
108th Street & Calumet River,  
Chicago, IL  
Rotary dump 2,000tph unloading  
system  
Bottom dump 2,000 tph unloading  
system  
Single 1,500 tph ship loader  
6,000,000t annual capacity  
Single loading berth 800ft length  
2,000,000t  
River barge unloading and loading  
services.

**Cleveland**

**Port of Cleveland**

1375 E. 9th Street  
#2300  
Cleveland  
Ohio  
44114-1786  
USA

Contact: Mr Eric Hirsimaki  
Job Title: Marketing

T: + 1 216 241 8004  
F: + 1 216 241 8016  
E: eric.hirsimaki@portofcleveland.com  
Downtown Cleveland, Ohio USA on  
Lake Erie  
4 Cranes to 150 tons  
Cleveland Bulk Terminal: 300m  
length, 8.3m depth  
40 hectares  
35000sqm  
Good rail and road access

**Conneaut**

**Pittsburgh & Conneaut Dock Co.**

950 Ford Ave  
Conneaut  
Ohio  
44030  
USA

Contact: Mr James Rogers  
Job Title: Senior Manager of Dock  
Operations  
T: + 1 440 599 0242  
F: + 1 440 599 0245  
E: James.Rogers@cnworldwide.com  
W: www.cn.ca  
West Of Erie Pa. on Lake Erie  
4 reclaimers and 4 stackers  
5 million sqm

**Convent**

**IC RailMarine Terminal (ICRMT)**

7790 LA, Highway 44  
Convent  
LA  
70723  
USA

Job Title: President  
T: + 1 225 562 5201  
F: + 1 225 562 9948  
E: bruce.conti@cn.ca  
MP 161.0 AHP Mississippi River  
(East bank between Baton Rouge  
and New Orleans)  
IMPUSA Ship Unloader - 1500 MtpH,  
Gotwald Ship Unloader - 900 MtpH,  
Metalna Traveling Ship Loader-  
2700 MtpH, EMS Tech Barge  
Loader - 450 MtpH (all nameplate  
rates)  
Vessels 850' LOA-Beam 150'  
34 acres - two pads - 1.2 million  
tons  
none  
Italmimpianti Traveling Radial  
Stacker, Heyl & Patterson  
Rotary/Bottom Car Dumper,  
Kanawha Railcar Batch Loader,  
130 Railcar Unit Train Loop Track.  
Railroad: Canadian National  
Railroad

**Convent**

**St. James Stevedoring Partners, LLC**

9114 Stevedoring Road  
Convent  
LA  
70723  
USA

Contact: Mr John C Crane  
Job Title: Vice President  
T: + 1 225 562 3919  
F: + 1 225 562 3515  
E: jcrane@sjstevedore.com  
W: www.sjstevedore.com  
Mississippi River, Texas Gulf  
8 Gottwald Floating Cranes  
6 midstream berths for handling up  
to cape sized vessels  
St. James operates a coal auger  
barge for obtaining mechanical coal  
samples.

**Coos Bay**

**Oregon International Port of**

**Coos Bay**  
PO Box 1215  
Coos Bay  
OR  
97420  
USA

Contact: Mr Jeffrey Bishop  
Job Title: General Manager  
T: + 1 541 267 7678  
F: + 1 541 269 1475  
E: jbishop@portofcoosbay.com  
W: www.portofcoosbay.com

**Cora**

**Kinder Morgan Terminals - Cora**

Mid Atlantic Regional Office  
1801 Milford Street  
Charleston  
South Carolina  
29405  
USA

Contact: Mr Brian Feyereisen  
T: + 1 843 853 0453  
F: + 1 843 853 7971  
E: brian\_feyereisen@  
kindermorgan.com  
W: www.kindermorgan.com

**Cordova**

**Port of Cordova**

P.O.Box 1210  
Cordova  
Alaska  
AK 99574  
USA

Contact: Mr Dale R Muma  
Job Title: Port Director  
T: + 1 907 4246400  
F: + 1 907 4246000  
E: harbor@cityofcordova.net

**Corpus Christi**

**Boyd-Campbell Company**

210 S. Carancahua  
Suite 620  
Corpus Christi  
Texas  
78401  
USA

Contact: Mr Sonny Boyd  
Job Title: Manager/Agent  
T: + 1 361 884 9321  
F: + 1 361 884 9067  
E: agency@boyd-campbell.com  
Corpus Christi and Point Comfort,  
Texas, USA  
Stevedore bulk cargoes, break bulk  
cargoes and heavy lift cargoes.  
Bulk Materials Dock #1 - one rolling  
gantry crane with grab bucket that  
can be used for loading or  
unloading bulk cargoes.  
Bulk Materials Dock #2 - one radial  
loader.

Port owned property may be leased  
short term or long term.  
Port public pads for bulk cargoes at  
Bulk Handling Terminal .  
Large amounts of pads for break  
bulk cargo in South and North Side  
Cargo Terminals.  
Limited private covered storage for  
bulk cargoes.  
Port has 1 large covered storage  
area in their North Side Cargo  
Terminal and 2 large covered  
storage areas in their South Side  
Cargo Terminal that can be used for  
bulk or break bulk cargoes.  
North and South Side Cargo  
Terminals have wide aprons or  
open docks for discharge direct to  
trucks or rail.

**Corpus Christi**

**Port of Corpus Christi**

PO Box 1541  
222 Power Street  
Corpus Christi  
TX  
78403  
USA

Contact: Mr Maynard "Sandy"  
Sanders  
Job Title: Deputy Port Director  
Operations  
T: + 1 361 885 6115  
F: + 1 361 882 7110

E: jvalls@pocca.com  
W: www.portofcorpuschristi.com

**Corpus Christi**

**Port of Corpus Christi - Bulk**

**Terminal**  
PO Box 1541  
222 Power Street  
Corpus Christi  
TX  
78403  
USA

Contact: Mr Paul (Skip) Kaup  
Job Title: Bulk Terminal Manager  
T: + 1 361 883 1162  
F: + 1 361 883 1652  
E: paulg@pocca.com  
W: www.portofcorpuschristi.com  
Gulf of Mexico  
Gantry Crane 600tph. Shiploader  
1,500tph  
Depth: 45'

**Corpus Christi**

**Public Elevator**

PO Box 2229  
Corpus Christi  
TX 78403  
USA

Contact: Mr Ed Altemus  
Job Title: Director of Trade  
T: + 1 361 882 1456  
F: + 1 361 882 1998

**Corpus Christi**

**Sherwin Alumina, L.P.**

PO Box 9911  
Corpus Christi  
Texas  
78469  
USA

Contact: Mr Josh Autenrieth  
Job Title: Port Superintendent  
T: + 1 361 7772434  
F: + 1 361 7772347  
E: raabrajano@sherwinalumina.com

**Corte Madera**

**The Pasha Group**

Suite 1000  
5725 Paradise Drive  
Corte Madera  
CA  
94925  
USA

Contact: Ms Gabriela Grubb  
T: + 1 415 9 276 400  
F: + 1 415 924 5672  
E: Gabriela\_Grubb@pashanet.com  
W: www.pashagroup.com

**Darrow**

**Burnside Bulk Marine Terminal**

4258 Highway 44  
Darrow  
LA  
70725  
USA

Contact: Mr Mike Tenchuk  
Job Title: CEO  
T: + 1 225 289 5211  
F: + 1 225 474 3719  
E: mike.tenchuk@ormet.com  
W: www.burnsideterminal.com

**Darrow**

**Cooper/Consolidated**



PO Box 242  
Darrow  
LA  
70724  
USA

Contact: Ms Billy Fitzpatrick  
Job Title: Vice President  
T: + 1 225 473 4288  
F: + 1 225 473 6161

E: billy.fitzpatrick@coopertsmith.com  
W: www.coopertsmith.com  
US East, West and Gulf coast, US  
Inland Waterways, Mexico,  
Venezuela, Brazil, Colombia  
Multiple Floating Derricks, Shore  
cranes, Elevators  
Midstream US Gulf, East coast  
100,000mt US Gulf

**Davant**

**U.S. United Bulk Terminal**

14537 Highway 15  
Davant  
Louisiana  
70040  
USA

Contact: Mr Brian Miles  
T: + 1 504 301 9193  
F: + 1 504 834 2772  
E: brian.miles@united-mar.com  
W: www.unitedbulkterminal.com  
Mile Post 55 Lower Mississippi  
River, Left Descending Bank  
Storage Capacity: 5 million tonnes  
Throughput Capacity: 25 million  
tonnes  
Berthing available for four  
Panamax  
5 million tonnes  
Largest full service terminal on the  
Mississippi River

**Davant**

**United Bulk Terminals - Davant**

14537 Hwy 15  
Davant  
LA  
70040  
USA

Contact: Mr Brian Miles  
Job Title: Vice President of Sales &  
Marketing  
T: + 1 504 301 9193  
E: brian.miles@  
unitedbulkterminals.com  
W: www.unitedbulkterminals.com  
Lower Mississippi river Mile Post  
55. Davant, LA USA.  
4 Berths  
Buoys; #1 Dock- 2200 ft; #2 Dock  
1000 ft  
200 acres- storage space for 5  
million tonnes  
N/A  
United Bulk Terminals-Davant is a  
full service bulk stevedore. We can  
handle four panamax vessels at  
one time. Most storage space on  
the Mississippi River. Package  
Logistics opportunities available.

**Decatur**

**ARTCO**

4666 Faries Parkway  
Decatur  
IL  
62526  
USA

Contact: Mr Kevin Van Meter  
Job Title: Director  
T: + 1 217 424 5556  
F: + 1 217 451 4122  
E: kevin.vanmeter@adm.com  
W: www.admworld.com

**Decatur**

**Kinder Morgan Terminals -**

**Decatur**

Lower River Regional Office  
7116 Highway 22  
PO Box 625  
Sorrento  
LA  
70778-0625  
USA

Contact: Mr Hans Luetkemeier  
Job Title: Commercial Director  
T: + 1 225 675 0308  
F: + 1 225 675 8259  
E: hans\_luetkemeier@  
kindermorgan.com

W: [www.kindermorgan.com/bulk\\_terminals/](http://www.kindermorgan.com/bulk_terminals/)

## Detroit

### Detroit / Wayne County Port Authority

8109 E. Jefferson Ave.  
Detroit  
MI  
48214  
USA  
Contact: Miss Cheryl Solomon  
Job Title: Marketing Director  
T: + 1 313 331 3842x310  
F: + 1 313 331 5457  
E: [solomon@portdetroit.com](mailto:solomon@portdetroit.com)  
W: [www.portdetroit.com](http://www.portdetroit.com)

## Detroit

### Port of Detroit

8109 Jefferson Avenue  
Detroit  
Michigan  
48214  
USA  
Contact: Ms Cheryl Graham  
Solomon  
Job Title: Marketing Director  
T: + 1 313 331 3842 ext 310  
F: + 1 313 331 5457  
E: [solomon@portdetroit.com](mailto:solomon@portdetroit.com)  
W: [www.portdetroit.com](http://www.portdetroit.com)

## Duluth

### AGP Grain Limited

602 Arthur Avenue  
Duluth  
MN  
55802-2602  
USA  
Job Title: Superintendent  
T: + 1 218 722 0538  
F: + 1 218 722 0076  
E: [info@agp.com](mailto:info@agp.com)  
W: [www.agp.com/](http://www.agp.com/)

## Duluth

### Duluth Seaway Port Authority

1200 Port Terminal Drive  
Duluth  
MN  
55802-2609  
USA  
Contact: Ms Adele Yorde  
Job Title: Public Relations Manager  
T: + 1 218 727 8525  
F: + 1 218 727 6888  
E: [ayorde@duluthport.com](mailto:ayorde@duluthport.com)  
W: [www.duluthport.com](http://www.duluthport.com)  
Western-most tip of Lake Superior and Great Lakes/ Saint Lawrence Seaway System in North America. 20 privately owned/operated commercial docks: 10 bulk cargo, 2 ore docks, 1 coal terminal, 7 grain elevators; 1 fueling depot; tug/barge services; plus 1 breakbulk terminal. On average, the Port of Duluth-Superior sees nearly 1,000 vessel calls and handles 40 million net tons each year with principal cargoes: iron ore, coal, grain, limestone, cement, salt and other commodities plus heavy-lift and project cargo.

## Duluth

### General Mills Elevator A

200 Garfield Ave.  
Duluth  
MN  
55802  
USA  
Contact: Mr Douglas Christiansen  
Job Title: General Manager  
T: + 1 218 722 7759  
F: + 1 218 727 7956  
E: [doug.christiansen@genmills.com](mailto:doug.christiansen@genmills.com)

## Duluth

### Krech Ojard & Assoc

227 W 1st St  
Suite 200  
Duluth  
Minnesota  
55082  
USA  
Contact: Mr Kevin Ehrenreich  
Job Title: Director Infrastructure Services  
T: + 1 218 727 3282  
F: + 1 218 727 1216  
E: [kevin.ehrenreich@krechojard.com](mailto:kevin.ehrenreich@krechojard.com)  
W: [www.krechojard.com](http://www.krechojard.com)

## East Liverpool

### Columbiana County Port Authority

1250 St. George Street  
East Liverpool  
Ohio  
43920  
USA  
Contact: Mr Tracy Drake  
Job Title: Chief Executive Officer  
T: + 1 330 386 9051  
F: + 1 330 386 1122  
E: [ccpa@ccpa-ohioriver.com](mailto:ccpa@ccpa-ohioriver.com)  
Wellsville Intermodal Facility - Ohio River mile Post 49. Pittsburgh-Cleveland Area  
60 ton bridge crane/bulk Conveyor System  
Opening - 2011

## Eastport

### Eastport Port Authority

PO Box 278  
3 Madison Street  
Eastport  
ME  
04631  
USA  
Contact: Mr Christopher Gardner  
Job Title: Executive Director  
T: + 1 207 853 4614  
F: + 1 207 583 9584  
E: [eportauth@nemaine.com](mailto:eportauth@nemaine.com)  
W: [www.portofeastport.org](http://www.portofeastport.org)

## Erie

### Mount Fort Terminal

PO Box 179  
2 East Bay Drive  
Erie  
PA  
16512-0179  
USA  
Contact: Mr Callaghan  
Job Title: Terminal Manager  
T: + 1 814 453 6721  
F: + 1 814 453 5138  
E: [dtodeagleton@aol.com](mailto:dtodeagleton@aol.com)

## Eureka

### Humboldt Bay Harbour District

P.O.Box 1030  
Eureka  
California  
CA 95502-1030  
USA  
Contact: Mr David Hull  
Job Title: Chief Executive Officer  
T: + 1 707 4430801  
F: + 1 707 443080  
E: [info@portofhumboldtport.org](mailto:info@portofhumboldtport.org)

## Evansville

### Kinder Morgan Terminals - Evansville

Midwest Regional Office  
8500 West 68th Street  
Argo  
Illinois  
60501  
USA  
Contact: Mr Roy Cook  
T: + 1 414 769 1901 ext-120  
F: + 1 414 769 1144  
E: [roy\\_cook@kindermorgan.com](mailto:roy_cook@kindermorgan.com)

W: [www.kindermorgan.com](http://www.kindermorgan.com)

## Everett

### Port of Everett

PO Box 538  
Everett  
WA  
98206  
USA  
Contact: Ms Lisa Lefebber  
Job Title: PR/Communication Administrator  
T: + 1 425 259 3164  
F: + 1 425 252 7366  
E: [lislam@portofeverett.com](mailto:lislam@portofeverett.com)  
W: [www.portofeverett.com](http://www.portofeverett.com)  
West Coast of USA  
Lift up to 100 tons  
7  
36,000 sq ft  
2 x 40 LT Mitsubishi Gantry Cranes will be in service year 2005.

## Fields Landing

### Port of Eureka

Fields Landing  
PO Box 266  
Fields Landing  
CA 95537  
USA  
Contact: Mr Stamwood A Murphy  
Jnr  
Job Title: Port Owner  
T: + 1 707 443 5631  
F: + 1 707 443 3553  
W: [www.humboldtport.org](http://www.humboldtport.org)

## Fort Lauderdale

### Port Everglades Department of Broward County

1850 Eller Drive  
6th Floor Administration Building  
Fort Lauderdale  
FL  
33316  
USA  
Contact: Ms Ellen Kennedy  
Job Title: Marketing  
T: + 1 954 523 3404  
F: + 1 954 525 1910  
E: [portevergladescargo@broward.org](mailto:portevergladescargo@broward.org)  
W: [www.co.broward.fl.us/port.htm](http://www.co.broward.fl.us/port.htm)

## Fresno

### Penny Newman Grain Co

PO Box 12147  
Fresno  
California  
93776  
USA  
Contact: Mr Mike Nicoletti  
T: + 1 559 448 8800  
F: + 1 559 448 0500  
E: [mike@penny-newman.com](mailto:mike@penny-newman.com)

## Galveston

### Farmland Elevator G

3100 Wharf Rd  
PO Box 2647  
Galveston  
Texas  
77553  
USA  
T: + 1 409 763 6447  
F: + 1 409 763 8608

## Galveston

### Metro Ports

PO Box 1252  
Galveston  
TX  
77553  
USA  
Contact: Mr Troy Gouger  
Job Title: General Manager  
T: + 1 409 762 8131  
F: + 1 409 762 1006  
E: [troy.gouger@metroports.com](mailto:troy.gouger@metroports.com)  
W: [www.metroports.com](http://www.metroports.com)

## Galveston

### Port of Galveston

PO Box 328  
Galveston  
Texas  
77553  
USA  
Contact: Captain John G Peterlin III  
Job Title: Senior Director of Marketing  
T: + 1 409 766 6112  
F: + 1 409 766 6107  
E: [jpeterlin@portofgalveston.com](mailto:jpeterlin@portofgalveston.com)  
W: [www.portofgalveston.com](http://www.portofgalveston.com)

## Georgetown

### Liberty Terminals, LLC

PO Box 1498  
Georgetown  
29442  
USA  
Contact: Mr Perri R Collins  
Job Title: Managing Member  
T: + 1 843 527 1743  
F: + 1 843 527 1743  
E: [sc@liberty-terminals.com](mailto:sc@liberty-terminals.com)

## Georgetown

### Port of Georgetown

South Carolina State Ports Authority  
PO Box 601  
1324 Dock Street, Pier 31  
Georgetown  
SC  
29440  
USA  
Contact: Mr L David Schronce  
Job Title: Director  
T: + 1 843 527 4476  
F: + 1 843 527 2601  
E: [dschronce@scspsa.com](mailto:dschronce@scspsa.com)

## Georgetown

### Stevedoring Services of America (SSA)

609 Kaminski Street  
Georgetown  
SC  
29442  
USA  
Contact: Mr Buddy Wiggins  
Job Title: Operations Manager  
T: + 1 843 971 2900  
F: + 1 843 971 2919  
E: [buddy.wiggins@ssamarine.com](mailto:buddy.wiggins@ssamarine.com)

## Georgetown

### Winyah Stevedoring Inc

PO Box 1498  
Georgetown  
SC  
29442  
USA  
Contact: Mr Perry Collins  
T: + 1 843 527 2823  
F: + 1 843 527 1179

## Georgetown

### WSI of the Southeast llc

PO Box 1498  
Georgetown  
SC  
29442  
USA  
Contact: Mr Perry Collins  
Job Title: General Manager  
T: + 1 843 527 2823  
F: + 1 843 527 1179  
E: [perry.collins@wsijason.com](mailto:perry.collins@wsijason.com)  
W: [www.wsijason.com](http://www.wsijason.com)

## Glen Carbon

### SynFuel Technologies Inc.

20A Kettle River Drive  
Glen Carbon  
IL  
62034  
USA  
Contact: Mr Robert Van Patten

Job Title: President  
T: + 1 618 655 1201  
F: + 1 618 656 1363  
E: [rmvanpatten@aol.com](mailto:rmvanpatten@aol.com)

## Grand Rivers

### Kinder Morgan Terminals - Grand Rivers

Mid Atlantic Regional Office  
1801 Milford Street  
Charleston  
South Carolina  
29405  
USA  
T: + 1 843 722 2878  
F: + 1 843 722 5720  
W: [www.kindermorgan.com](http://www.kindermorgan.com)

## Green Bay

### Port of Green Bay

Brown County  
2561 S. Broadway Street  
Green Bay  
WI  
54304  
USA  
Contact: Mr Dean Haen  
Job Title: Port Manager  
T: + 1 920 492 4950  
F: + 1 920 492 4957  
E: [haen\\_dr@co.brown.wi.us](mailto:haen_dr@co.brown.wi.us)  
W: [www.portofgreenbay.com](http://www.portofgreenbay.com)

## Gretna

### Associated Grain Terminals

848 Behrman Hwy  
Gretna  
Louisiana  
70053  
USA  
Contact: Mr Bill Sullivan  
Job Title: Terminal Manager  
T: + 1 985 536 4520  
F: + 1 985 536 4521  
E: [bill@associatedterminals.com](mailto:bill@associatedterminals.com)  
W: [www.associatedterminals.com](http://www.associatedterminals.com)  
Lower Mississippi River miles 56 to 58  
Floating grain elevator and fleet of midstream stevedoring cranes.  
Three midstream berths  
0  
0  
AGT offers a flexible and reliable one-stop shop for moving bulk cargo on the Lower Mississippi. Short vessel transit times make this an ideal port to move cargo efficiently at midstream berths.

## Gulfport

### Mississippi State Port Authority at Gulfport

One Hancock Plaza  
Suite 1401  
Gulfport  
MS  
39501/39502  
USA  
Contact: Mr John H Webb  
Job Title: Deputy Director of Engineering  
T: + 1 228-865 4300  
F: + 1 228-865 4335  
E: [jwebb@shipmspa.com](mailto:jwebb@shipmspa.com)  
W: [www.shipmspa.com](http://www.shipmspa.com)

## Hilo

### Hilo Harbour

Department of Transportation  
Harbours Division  
80 Kuhio Street  
Hilo  
HI 96720  
USA  
Contact: Mr Jeff D Hood  
Job Title: District Manager  
T: + 1 808 933 8850  
F: + 1 808 933 8851  
E: [Jeff.Hood@hawaii.gov](mailto:Jeff.Hood@hawaii.gov)



**Hilo**

**State of Hawaii, Department of Transportation**

Harbours Division, Hawaii District  
Hilo  
HI  
96720  
USA  
Contact: Mr Jeff D. Hood  
Job Title: District Manager  
T: +1 808 933 8850  
F: +1 808 933 8851  
E: jeff.d.hood@hawaii.gov  
W: www.state.hi.us/dot/harbors  
Hawaii Island  
None  
1265 feet  
Hawaii Island Harbors District has two ports, Hilo & Kawaihae. Hilo is on the east side & Kawaihae is on the west side of the island.

**Homer**

**City of Homer Port and Harbor**

4350 Homer Spit Road  
Homer  
Alaska  
99603  
USA  
Contact: Mr Bryan Hawkins  
Job Title: Port  
Director/Harbor Master  
T: +1 907 235 3160  
F: +1 907 235 3152  
E: port@ci.homer.ak.us  
W: http://www.cityofhomer-ak.gov/port  
End of Homer Spit in Kachemak Bay, Alaska  
Small Harbor with 920 reserved stalls and over 6,000 linear feet of transient moorage available; Port consisting of two commercial docks; Fish dock for loading/unloading seafood

**Honolulu**

**Honolulu Port Authority**

700 Fort Street  
Honolulu  
HI  
96813  
USA  
Contact: Mr Scott Cunningham  
Job Title: Harbour Master  
T: +1 808 587 2050  
F: +1 808 587 2065  
E: dotpao@hawaii.gov  
W: www.hawaii.gov/dakine/index.html  
Pier 23  
South coast of island of Oahu  
Max draught 34' / 10.36m

**Houston**

**Cooper/T. Smith Stevedoring**



2315 McCarty Drive  
Houston  
Texas  
77029  
USA  
Contact: Mr Britton Cooper  
Job Title: Vice President Operations  
T: +1 713 675 0017  
F: +1 713 675 2370  
E: britton.cooper@coopertsmith.com  
W: www.coopertsmith.com

**Houston**

**Port of Houston Authority**

111 East Loop North  
Houston  
Texas  
77209-4326  
USA  
Contact: Ms Lisa Whitlock  
Job Title: Advertising Manager  
T: +1 713 670 2644

F: +1 713 670 2564  
E: lwhitlock@poha.com  
W: www.portofhouston.com

**Houston**

**Public Elevator 2**

PO Box 2562  
Houston  
Texas  
77252-2562  
USA  
Contact: Mr Jimmy Jamison  
T: +1 713 670 2676  
F: +1 713 670 2562

**Houston**

**Texas Terminals LP**

15902 Peninsula Blvd  
Houston  
Texas  
77015  
USA  
Contact: Mr Robert Schwarz  
Job Title: General manager  
T: +1 281 457 3131  
F: +1 281 457 3232  
E: Info@TexasTerminals.com  
W: http://texasterminals.com/

**Houston**

**Tx Tx Corporation**

11811 Interstate  
10 East  
Suite 630  
Houston  
Texas  
77029  
USA  
Contact: Mr Gary Nixon  
T: +1 713 453 0664  
F: +1 713 453 2756

**Humble**

**P&O Ports Texas, Inc.**

5810 Wilson Road  
Suite 220  
Humble  
Texas  
77396  
USA  
Contact: Mr Norman Lamb  
Job Title: Vice President  
T: +1 832 615 7201  
F: +1 832 615 7250  
E: norman.lamb@portsamerica.com  
W: www.portsamerica.com  
Houston, Tx; Galveston, TX; Beaumont, TX,

Corpus Christi, TX and Freeport, TX  
Contract Stevedore and Terminal Operator

**Indiana**

**Port of Indiana**

Burns Int'l Harbour 6600  
US Highway  
12 Portage  
Indiana  
46368  
USA  
Contact: Mr Peter Becarthy  
T: +1 219 787 8636  
F: +1 219 787 8842  
E: info@portsofindiana.com

**Indianapolis**

**Burns International Harbour-Port of Indiana**

Indiana Port Commission  
150 West Market Street  
Suite 603  
Indianapolis  
IN  
46204  
USA  
Contact: Mr Jody Peacock  
Job Title: Marketing  
T: +1 317 232 9200  
F: +1 317 232 0137

E: jpeacock@portsofindiana.com  
W: www.portsofindiana.com

**Jacksonville**

**Jacksonville Electric Authority**

21 West Church St  
Jacksonville  
FL 32202  
USA  
Contact: Mr Wanyonyi Kendrick  
Job Title: Chief Information Officer  
T: +1 904 665 7217  
E: kendwj@jea.com  
W: www.jea.com

**Jacksonville**

**Jacksonville Port Authority**

2831 Talleyrand Avenue  
Jacksonville  
FL 32206  
USA  
Contact: Mr R Comer  
Job Title: Assistant Production Manager  
T: +1 904 630 3070  
F: +1 904 630 3066  
E: info@jaxport.com  
W: www.jaxport.com

**Juneau**

**Port of Juneau**

City Dock and Alaska Steam Dock  
155 South Seward  
Juneau  
Alaska  
AK 99801  
USA  
Contact: Mr John Stone  
Job Title: Port Director  
T: +1 907-586-0292  
F: +1 907-586-0295  
E: john.stone@ci.juneau.ak.us  
W: www.juneau.lib.ak.us

**Kalama**

**Harvest States Elevator**

400 Toteff Road  
Kalama  
Washington  
98625  
USA  
Contact: Mr Lance Helgeson  
T: +1 360 673 2011  
F: +1 360 673 5101  
E: lance.helgeson@chsinc.com

**Kalama**

**Peavey Elevator**

2211North Hendricks Drive  
PO Box 1008  
Kalama  
Washington  
98625  
USA  
Contact: Mr Steve Oakes  
T: +1 360 673 3900  
F: +1 360 673 3910

**Kenai**

**Port of Kenai**

210 Fidalgo  
Kenai  
Alaska  
AK 99611  
USA  
Contact: Mr Keith Kornelis  
Job Title: Port Director  
T: +1 907 2837535  
F: +1 907 2621892  
E: bfrates@ci.kenai.ak.us  
W: www.ci.kenai.ak.us

**Kenova**

**Big Sandy Terminal Inc**

Big Sandy River Road  
Kenova  
West Virginia  
25530  
USA  
Contact: Mr Alan Johnson

Job Title: President  
T: +1 304 453 4000  
F: +1 304 453 1117  
E: alan.johnson@nscorp.com

**Kirkland**

**Macquarie Ports Inc**

620 Kirkland Way  
Suite 206  
Kirkland  
WA  
98033  
USA  
Contact: Mr James Leonard  
E: james.leonard@macquarie.com  
W: www.macquarie.com

**Kodiak**

**City of Kodiak Harbour Department**

403 Marine Way  
Kodiak  
Alaska  
AK 99615  
USA  
Contact: Mr G V McCorkle  
Job Title: Harbour Master  
T: + 907 486 8080  
F: + 907 486 8090  
W: www.kodiak.org

**La Place**

**Port of South Louisiana**

171 Belle Terre Boulevard  
La Place  
Louisiana  
70068  
USA  
Contact: Ms Linda Prudhomme  
Job Title: Director of Business Development  
T: +1 985 652 9278  
F: +1 985 652 9518  
E: lprudhomme@portsl.com  
W: www.portsl.com  
Lower Mississippi River  
60 private and public docks and facilities - 278 million tonnes/year  
Globalplex Intermodal Terminal  
Bulk Cargo Handling Facility - 570"x44"  
(Port-Owned)  
Two 50,000 ton cement domes  
The Port of South Louisiana covers 54 miles on the lower Mississippi River (mile 114-118). "America's largest tonnage port".

**Lake Charles**

**Lake Charles Harbor & Terminal District**

PO Box 3753  
150 Marine Street  
Lake Charles  
LA 70602  
USA  
Contact: Mr Dan Loughney  
Job Title: Director of Marketing & Trade Development  
T: +1 337 439 3661  
F: +1 337 493 3528  
E: marketing@portlc.com  
W: www.portlc.com

**Lake Charles**

**Port of Lake Charles**

150 Marine Street  
Lake Charles  
LA  
70602  
USA  
Contact: Mr Winn  
T: +1 337 439 3661  
F: +1 337 439 3523  
E: marketing@portlc.com  
W: www.portlc.com

**Lamberts Point**

**Norfolk Southern - Lamberts Point**

Coal Business Group  
110 Franklin Rd  
Roanoke  
VA  
24042-0026  
USA  
Contact: Mr Mark H Bower  
Job Title: Group VP Export & Metallurgical Coal Marketing  
T: +1 540 985 6711  
F: +1 540 985 6398  
E: Mark.Bower@nscorp.com  
W: www.nscorp.com  
Hampton Roads, Virginia USA

**Laplace**

**Consolidated Terminals & Logistics Company**



Midstream buoys at Laplace.  
c/o headquarters at:  
PO Box 249  
Mandeville

LA  
70470-0249  
USA  
Contact: Mr Brent C Mahana  
Director of Sales & Marketing  
T: +1 985 871 4403  
F: +1 985 867 3509  
E: Brent.Mahana@cgb.com  
W: www.ctlconline.com  
Location: Lower Mississippi River  
Equipment & Capacity: Multiple high capacity floating cranes. Mid-stream coal transfer facility aka "LMO", dry dock, turn fleet servicing 500+ barges, aggregate dock/yard with 20,000 ton capacity and scales  
Bulk Berths: 11 mid-stream berths (mp 111-180)  
CTLC offers full inland logistics including vessel Stevedoring, Barging, Terminal, Truck and Rail delivery to all inland destinations.

**Laplace**

**Cooper/Consolidated**



Midstream buoys at Laplace.  
c/o headquarters at:  
PO Box 249  
Mandeville

LA  
70470-0249  
USA  
Contact: Mr Brent C Mahana  
General Manager - Sales  
T: +1 985 871 4403  
F: +1 985 867 3509  
E: Brent.Mahana@cgb.com  
W: www.cooperconsolidated.com  
Location: Lower Mississippi River  
Equipment & Capacity: Multiple high capacity floating cranes  
Mid-stream coal transfer facility aka "LMO"  
and mid-stream grain transfer facility aka "The America"  
Bulk Berths: 11 mid-stream berths (mp 111-180)  
Total uncovered Storage: n/a  
Total covered Storage: n/a  
We specialize in full logistics solutions. Services include stevedoring, barging, trucking, rail, inland terminaling, as well as barge fleet, cleaning and repairs.

## Long Beach

Cooper/T. Smith Stevedoring



PO Box 229

Long Beach

California

90801

USA

Contact: Mr Ed Viner

Job Title: Assistant Vice

President/Operations Manager

T: + 1 562 436 2259

F: + 1 562 590 0547

E: ed.viner@coopertsmith.com

W: www.coopertsmith.com

## Long Beach

MCC-Lucky Cement Terminal

1150 Pier F Avenue

Pier F Berth 208

Long Beach

California

90802

USA

Contact: Mr Marty Marcum

Job Title: Manager of Operations

T: + 1 562 495 0600

F: + 1 562 495 5929

## Long Beach

Metro Ports

1045 Pier G Avenue

Long Beach

California

90802

USA

Contact: Mr Brian Johnson

Job Title: Vice President Business

Development

T: + 1 310 816 6523

F: + 1 310 816 6519

E: info@metroports.com

W: www.metroports.com

Port of Long Beach Berths G212-

214

1 x 2500 Mtp, 1 X 4,500 Mtp

traveling shiploaders

2 berths, 1900' total (1 x 40'

draught, 1 x 50' draught at MLLW)

## Long Beach

Metro Ports

Port of Long Beach

Berths 212-214

1045 Pier G Avenue

Long Beach

California

90802

USA

Contact: Mr Malcolm Pitt

Job Title: Terminal Manager

T: + 1 562 983 8400

F: + 1 562 983 8520

E: malcolm.pitt@metsteco.com

W: www.metroports.com

## Long Beach

Port of Long Beach

PO Box 570

Long Beach

CA

90801

USA

Contact: Mr Art Wong

Job Title: Director of

Communications

T: + 1 562 590 4123

F: + 1 310 437 3231

E: wong@polb.com

W: www.polb.com

## Longview

Port of Longview

PO Box 1258

Longview

WA

98632-7739

USA

Contact: Mrs Laurie Nelson-Cooley

Job Title: Business Development

Manager

T: + 1 360 425 3305

F: + 1 360 425 8650

E: lnelson-

cooley@portoflongview.com

W: www.portoflongview.com

Southwest Washington State, USA

Bulk, breakbulk and project cargo

handling

Berth 2, Berth 5

2 million sq. ft.

1 million sq. ft.

Premier bulk, breakbulk and project

cargo handling port in SW

Washington State on the deep draft

Columbia River.

## Louisville

Kinder Morgan Terminals -

Louisville

Midwest Regional Office

8500 West 68th Street

Argo

Illinois

60501

USA

Contact: Mr Roy Cook

T: + 1 414 769 1901 ext-120

F: + 1 414 769 1144

E: roy\_cook@kindermorgan.com

W: www.kindermorgan.com

## Louisville

Schaefer-Cooper Warehousing

7200 Riverport Drive

Louisville

Kentucky

KY 40258

USA

Contact: Mr Jeff McCord

Job Title: Sales Manager

T: + 1 317 374 5240

E: jeff.mccord@coopertsmith.com

W: www.coopertsmith.com

## Mandeville

Consolidated Terminals &

Logistics Company

PO Box 249

Mandeville

LA

70470-0249

USA

Contact: Mr Brent C Mahana

Job Title: Director of Sales &

Marketing

T: + 1 985 871 4403

F: + 1 985 867 3509

E: Brent.Mahana@cgb.com

W: www.ctconline.com

Mississippi River mile post 133 -

180 AHP

11 high capacity floating cranes

9 midstream vessel anchorages

In addition to being the largest

stevedoring group in the US Gulf,

CTLC offers full inland logistics

including vessel Stevedoring,

Barging, Terminal, Truck and Rail

delivery to all inland destinations.

## Mandeville

Cooper/Consolidated

PO Box 249

Mandeville

LA

70470-0249

USA

Contact: Mr Brent C Mahana

Job Title: General Manager - Sales

T: + 1 985 871 4403

F: + 1 985 867 3509

E: Brent.Mahana@cgb.com

W: www.cooperconsolidated.com

Lower Mississippi River

Multiple high capacity floating

cranes

Mid-stream coal transfer facility aka

"LMO"

and mid-stream grain transfer

facility aka "The America"

11 mid-stream berths (mp 111-180)

n/a

n/a

We specialize in full logistics

solutions. Services include

stevedoring, barging, trucking, rail,

inland terminaling, as well as barge

fleetling, cleaning and repairs.

## Maumee

Kuhlman Corporation

1845 Indian Wood Circle

Maumee

Ohio

43537

USA

Contact: Mr Steve Smigelski

Job Title: General Manager

T: + 1 419 897 6000

F: + 1 419 897 6061

E: ssmigelski@kuhlman-corp.com

W: www.kuhlman-corp.com

Western Lake Erie Basin

175,000 MT

140,000 MT

## Maumee

The Andersons - Maumee Grain

Marine facilities

Kuhlman & Edwin Drive

General offices

PO Box 119

480 W. Dussel Drive

Maumee

Ohio

43537

USA

Contact: Mr Jim McKinstry

Job Title: Director, Development

and Transportation

T: + 1 419 891 6565

F: + 1 419 891 6513

E: jim\_mckinstry@andersonsinc.com

W: www.andersonsinc.com

Maumee River / Toledo, OH

2 x 1000 ft @ Seaway draught

1 million metric tons

Load rate at each facility

approximately 1,000tph

## Maumee

The Andersons, Inc

PO Box 119

Maumee

Ohio

43537-0119

USA

Contact: Mr Don Wray

T: + 1 419 241 8943

F: + 1 419 255 5366

E: don\_wray@andersonsinc.com

W: www.andersonsinc.com

Toledo/Lake Erie

Grain Merchant

1,000 ft/seaway draft

Grain shipping and receiving. Bulk

liquid and dry ag fertilizer. NSRR.

## Metairie

Kinder Morgan Terminals

3500 N. Causeway Blvd

Suite 210

Metairie

LA

70002

USA

Contact: Mr John Vaughn

Job Title: Senior Accountant

T: +1 504 620 4639

F: +1 504 620 4698

E: john\_vaughn@kindermorgan.com

## Metropolis

AEPI/Cook Coal Terminal

PO Box 870 3316 N. US 45 Rd.

Metropolis

IL

62960

USA

Contact: Mr Robert Korte

Job Title: Plant Manager

T: + 1 618 524 9345

F: + 1 618 524 1968

E: rskorte@aep.com

W: www.aep.com

Metropolis, Illinois - Ohio River

947.5

## Miami

Panama Canal Authority (ACP)

Marketing Division (MEMC)

PO Box 526725

Miami

FL 33152-6725

USA

Contact: Mr Yumiko E Casiano

Job Title: Marketing Department

T: + 1-507-272-1586

F: + 1-507-272-1622

E: ycasiano@pancanal.com

W: www.pancanal.com

## Miami

Port of Miami

1015 N America Way

Miami

FLA

33132

USA

Contact: Mr Bill Johnson



**Mobile**

**Port of Mobile**  
Alabama State Port Authority  
PO Box 1588  
Mobile  
AL  
36633 1588  
USA  
Contact: Ms Judith Adams  
Job Title: Manager, Media Relations  
T: + 1 251 441 7003  
F: + 1 334 441 7216  
E: jadams@asdd.com  
W: www.asdd.com  
Eastern Gulf of Mexico  
5 bulk cranes 750-15000 tph  
5 bulk loaders 1000-3000 tph  
40t paceco container crane  
Gotwald 330 mobile harbor  
3 berths at 45' draft 1000' length  
2 berths at 40' draft 750' length  
Grain berth 40' draft 900' length  
Cement berth 40' draft 750' length  
25 general cargo berths 40' draft  
180,000 square meters general cargo  
25,000 square meters bulk  
Served by 5 class one railroads, 2 interstate highways, and a 1500 mile inland waterway system

**Mobile**

**Stevedoring Services of America**  
PO Box 2188  
Mobile  
AL 36652  
USA  
Contact: Mr Brian R. Frennea  
T: + 1 334 438 4771  
F: + 1 334 432 3180

**Monaca**

**Colona Terminal Services**  
1755 Pennsylvania Ave  
Monaca  
Pennsylvania  
15061  
USA  
Contact: Mr Mark McClymonds  
Job Title: President  
T: + 1 724 368 8040  
F: + 1 724 368 0550  
E: sales@colonatransfer.com  
W: www.colonatransfer.com

**Monroe**

**Tower Monroe Port Commission**  
PO Box 585  
Monroe  
MI 48161  
USA  
Contact: Mr M McCray  
Job Title: Executive Director  
@with line:

**Morehead City**

**North Carolina State Ports Authority/Morehead City**  
113 Arendell St.  
Morehead City  
NC  
28557  
USA  
Contact: Ms Shannon Moody  
Job Title: Director, Communications  
T: + 1 910 343 6482  
F: + 1 910 343 6225  
E: shannon\_moody@ncports.com  
W: www.ncports.com  
Port of Morehead situated along the Newport River and Bogue Sound  
2 gantry cranes, 1 container crane, 3 mobile cranes & cargo handling equipment  
Dry bulk facility (used mainly for phosphate) w/ 225,000 ton capacity warehouse, conveyor system & shiploader. Open storage dry bulk facility which can outload 1,000 tons per hr. w/ a two-million-ton annual capacity.  
Approximately 14 acres of paved,

open storage.  
457,564 sq. ft. of covered, sprinklered warehouse storage.  
Approximately 205 acres, w/ 150 (+/-) acres suitable for port industrial development on Radio Island (In Morehead City)

**Mount Pleasant**

**Strachan Shipping Co**  
950 Houston Northcutt Boulevard  
Watermark Plaza, Suite 200  
Mount Pleasant  
SC  
29464  
USA  
Contact: Mr Bill Adams  
T: + 1 843 856 1000  
F: + 1 843 856 1013

**Mount Vernon**

**Ports Of Indiana**  
Southwind Maritime Centre  
2751 Bluff Rd  
Mount Vernon  
IN  
47620-8521  
USA  
Contact: Mr Phillip Wizbacher  
Job Title: Port Director  
T: + 1 812 833 2166  
F: + 1 812 838 4377  
E: pwizbacher@portsofindiana.com  
W: www.portsofindiana.com

**Myrtle Grove**

**International Marine Terminals**  
Myrtle Grove Terminal  
18559 HWY 23  
Myrtle Grove  
LA  
70083-9722  
USA  
Contact: Mr Adam Smith  
Job Title: General Manager  
T: + 1 504 310 5000  
F: + 1 255 656 2071  
E: adam\_smith@kindermorgan.com  
W: www.kindermorgan.com  
Myrtle Grove, Louisiana, Milepost 57 Mississippi River, 30 miles south of New Orleans  
Full Service Marine Terminal which also operates a fleet service for up to 300 barges.  
Three vessel berths and one barge berth, including midstream mooring buoys for direct transfer cargoes.  
1,300,000 tons capacity  
N/A  
247 SHINC  
A Kinder Morgan Operated Terminal

**New Haven**

**New Haven**  
Gateway Terminal  
400 Waterfront Street  
New Haven  
CT  
06512  
USA  
Contact: Mr Tom Dubno  
T: + 1 203 230 0778  
F: + 1 203 437 7251

**New Haven**

**New Haven Terminal**  
Logistec Connecticut Inc  
PO Box 9411  
100 Waterfront Street  
New Haven  
CT  
06534-0411  
USA  
Contact: Mr James Schine  
Job Title: Sales and Marketing Manager  
T: + 1 203 468 0805  
F: + 1 203 469 1318

**New Orleans**

**Cooper/T. Smith Stevedoring**



One Canal Place  
365 Canal Street  
Suite 1450  
New Orleans  
LA  
70130  
USA  
Contact: Mr Eric Hansen  
Job Title: Vice President  
T: + 1 504 569 2160  
F: + 1 504 569 2188  
E: eric.hansen@coopertsmith.com  
W: www.coopertsmith.com

**New Orleans**

**Port of New Orleans**  
1350 Port of New Orleans Place  
New Orleans  
LA  
70130  
USA  
Contact: Ms Janine Mansour  
Job Title: Commercial Manager  
T: + 1 504 528 3533  
E: info@portno.com  
W: www.portno.com

**Newark**

**Metal Management NE**  
Foot Hawkins Street  
Newark  
New Jersey  
NJ 07105  
USA  
Contact: Mr Mike Henderson Jr.  
T: + 1 973 344 5575 / 4570  
F: + 1 973 344 8155  
E: mhendersonjr@mtim.com  
W: www.mtim.com

**Newport News**

**Dominion Terminal Associates LLP**  
600 Harbor Road  
Pier 11  
Newport News  
Virginia  
VA-23607  
USA  
Contact: Mr Rick Cole  
Job Title: President  
T: + 1 757 245 2275  
F: + 1 757 247 9729  
E: rcole@dominionterminal.com  
W: www.dominionterminal.com  
Port of Hampton Roads, Virginia, USA  
1 tandem rotary dumper, 2 stacker/reclaimers, 1 reclaimer, 1 finger pier, 1 shiploader  
Capacity: 20 million tonnes (net) annually.  
Depth at mean low water; 50 feet (15.24m)  
1.7 million tonnes (net)  
Inbound and Outbound sampling.  
Blending, using two 4,000 tonne silos

**Newport News**

**Kinder Morgan - Pier IX Terminal**  
1900 Harbor Access Road  
Newport News  
Virginia  
23607  
USA  
Contact: Mr Joseph De Matteo  
Job Title: Terminal Manager  
T: + 1 757 928 1520  
F: + 1 757 928 1560  
E: Joseph\_DeMatteo@kindermorgan.com  
W: www.kindermorgan.com  
Mid Atlantic US; Newport News VA  
Coal and Cement Handling

Equipment; Export and Import; 14m tpa capacity  
Cape and Panamax vessel berthing

**Norfolk**

**Virginia International Terminals Inc**  
PO Box 1367  
Norfolk  
VA 23501  
USA  
Contact: Mr Dave Rudlof  
Job Title: Dir. Engineering & Maintenance  
T: + 1 757 440 7000  
F: + 1 757 391 6223  
W: www.vit.org

**Norfolk**

**Virginia Maritime Association**  
236 East Plume Street  
Norfolk  
Virginia  
23510  
USA  
Contact: Mr David  
Job Title: Administrator  
T: + 1 757 622 2639  
F: + 1 757 622 6302  
E: vma@portofhamptonroads.com  
W: www.portofhamptonroads.com

**Norfolk**

**Virginia Port Authority**  
Hampton Roads District  
600 World Trade Centre  
Norfolk  
VA  
23510 1696  
USA  
Contact: Ms Linda Ford  
Job Title: Director of Port Promotion  
T: + 1 757 683 8000  
F: + 1 757 683 8500  
E: lford@portofvirginia.com  
W: www.portofvirginia.com

**North Charleston**

**Cooper/T. Smith Stevedoring**



2030 Hayter Street  
Building 58A Pier C  
North Charleston  
South Carolina  
29405  
USA  
Contact: Mr Ronnie Turner  
Job Title: Vice President  
T: + 1 843 744 1613  
F: + 1 843 554 2975  
E: ronnie.turner@coopertsmith.com  
W: www.coopertsmith.com

**Oakland**

**Port of Oakland**  
PO Box 2064  
Oakland  
California  
94604  
USA  
Contact: Mr Jerry Bridges  
Job Title: Chief Executive Officer  
T: + 1 510 627 1100  
F: + 1 510 839 5104  
E: jbridges@portofoakland.com  
W: www.portofoakland.com

**Oakville**

**The Andersons**  
500 Oakville Road  
Oakville  
IN  
47367  
USA  
Contact: Ms Dawn Betancourt  
Job Title: General Manager  
T: + 1 765 288 1951

F: + 1 765 288 4176  
E: dawn\_betancourt@andersonsinc.com  
W: www.andersonsgrain.com

**Ogdensburg**

**Ogdensburg Bridge & Port Authority**  
1 Bridge Plaza  
Ogdensburg  
NY 13669  
USA  
Contact: Mr Wade Davis  
Job Title: Executive Director  
T: + 1 360 528 4080  
F: + 1 315 393 7068  
E: wadavis@ogdensport.com  
W: www.ogdensport.com

**Olympia**

**Port of Olympia**  
915 Washington Street NE  
Olympia  
WA 98501-6931  
USA  
Contact: Mr Jim Amador  
Job Title: Marine Terminal Director  
T: + 1 360 528 8032  
F: + 1 360 528 8093  
E: JimA@portolympia.com  
Northwest Coast of United States  
2-40 LT gantry cranes, 15 forklifts (8,000-30,000 lb lift capacity), container handling equipment, log loaders, bucket loaders  
No bulk facilities. Continuous berth face (berths 1-2-3) equalling 1,750 feet  
57 acres  
2 acres (76,000 square feet)

**Omaha**

**Hansen-Mueller Company**  
12231 Emmet Street  
Omaha  
NE  
68164  
USA  
Contact: Mr John W. Orr  
Job Title: President  
T: + 1 402 491 3385  
F: + 1 402 491 0645  
E: john@hmgrain.com  
W: www.hmgrain.com  
Houston, TX  
1,500tph (3 x 21 m3 grabs + 2 x 10 m3 grabs + 3 vessel receiving hoppers)  
135,000 tonnes

**Oswego**

**Port of Oswego Authority**  
1 East Second Street  
Oswego  
NY  
13126  
USA  
Contact: Mr Jonathan Daniels  
Job Title: Executive Director  
T: + 1 315 806 6405  
F: + 1 315 343 5498  
E: jdaniels@portoswego.com  
W: www.portoswego.com

**Owensboro**

**Kinder Morgan Terminals - Owensboro**  
Midwest Regional Office  
8500 West 68th Street  
Argo  
Illinois  
60501  
USA  
Contact: Mr William Patterson  
T: + 1 708 496 2891  
F: + 1 708 496 2540  
E: william\_patterson@kindermorgan.com  
W: www.kindermorgan.com

## Pago Pago

**Port of Pago Pago**  
Department of Port Administration  
Government Of American Samoa  
PO Box 1539  
Pago Pago  
American Samoa  
96799  
USA  
Contact: Mr Matagi R Ma'ilo  
Mcmoore  
Job Title: Port Director  
T: + 1 684 6334251  
F: + 1 684 6335281  
E: Matagi.Mcmoore@Americansamoa.gov  
W: www.americansamoa.gov

## Palmer

**Port MacKenzie, Matanuska-Susitna Borough**  
350 E. Dahlia Avenue  
Palmer  
Palmer  
AK  
99645  
USA  
Contact: Mr Marc Van Dongen  
Job Title: Port Director  
T: + 1 907 357 6153  
F: + 1 907 357 6836  
E: Port.Mackenzie@matsugov.us  
W: www.portmackenzie.com

## Palmer

**Port MacKenzie/Mat-Su Borough**  
350 East Dahlia Ave  
Palmer  
Alaska  
AK 99645  
USA  
T: + 1 907 745 1265  
F: + 1 907 745 1248  
E: portmackenzie@matsugov.us  
W: www.portmackenzie.com  
NW of Anchorage Alaska - 2 miles  
220 ton crane, 100 ton crane.  
2,000tph conveyor.  
500ft barge dock @ -20MLLW +  
1200ft dock @ -60MLLW  
14 sq miles  
50,000 sq ft

## Palmetto

**Port Manatee Forestry Terminal Inc**  
600 Regal Cruise Way  
Palmetto  
Florida  
34221  
USA  
T: + 1 941 729 2424  
F: + 1 941 729 4343  
E: tamwww@gearbulk.com  
W: www.gearbulk.com

## Pascagoula

**Port of Pascagoula**  
3033 Pascagoula Street  
Pascagoula  
MS  
39567 0070  
USA  
Contact: Ms Betty Ann White  
Job Title: Manager, Government  
Affairs & Public Relations  
T: + 1 228 762 4041  
F: + 1 228 762 7476  
E: info@portofpascagoula.com  
W: www.portofpascagoula.com

## Pensacola

**Port of Pensacola**  
PO Box 889  
700 S Barracks Street  
Pensacola  
FL  
32594-0889  
USA  
Contact: Ms Amy Miller  
Job Title: Business Development

Manager  
T: + 1 850 436 5070  
F: + 1 850 435 1879  
E: info@portofpensacola.com  
W: www.portofpensacola.com

## Philadelphia

**Agway**  
3501 S C Columbus BLVD  
Pier 122 South  
Philadelphia  
PA  
19148  
USA  
Contact: Mr George Moore  
Job Title: Foreman  
T: + 1 215 467 5861  
F: + 1 215 467 5874  
E: gmoore@growmark.com  
W: www.agway.com

## Philadelphia

**Port of Philadelphia & Camden**  
3460 North Delaware Avenue  
2nd Floor  
Philadelphia  
PA 19134  
USA  
Contact: Mr Sean E Mahoney  
T: + 1 215 426 2441  
F: + 1 215 426 2447  
E: semahoney@philaport.com  
North East on the Delaware River  
9 Cranes  
21 - 20' 180' - 40'  
1 132 922 sqm  
355 353 sqm

## Piti

**Port Authority of Guam**  
1026 Cabras Highway  
Suite 201  
Piti  
Guam  
96915  
USA  
Contact: Mr Joseph W. Duenas  
Job Title: General Manager  
T: + 671 71 477 5931/35  
F: + 671 71 477 2689  
E: mphenderson@portofguam.com  
W: www.portofguam.com  
Western Pacific  
2 Ship-shore container gantries 1  
Hitachi 40t, 1 Paccoco 40t; Mobile  
cranes (truck-mounted) 1 Grove  
150t; Yard gantries 2 Paccoco 40t;  
Front end handlers/reachstackers 3  
Hyster 40t, 5 Hyster 7.5t.  
Total Area 132,000sqm  
3,300sqm

## Point Comfort

**Port of Point Comfort/Port Lavaca**  
The Calhoun County Navigation  
District  
PO Box 397  
Point Comfort  
TX  
77978  
USA  
Contact: Mr Robert Van Borssum  
Job Title: Port Director  
T: + 1 361 987 2813  
F: + 1 361 987 2189  
E: info@portofplpc.com

## Port Allen

**Associated Terminals of Baton Rouge/Port Allen**  
1133 Mahaffey Road  
Port Allen  
Louisiana  
70876  
USA  
Contact: Mr Barry Hoth  
Job Title: Vice President  
T: + 1 985 479 6358  
F: + 1 985 479 6360  
E: barry@associatedterminals.com

W: www.associatedterminals.com  
Lower Mississippi River Baton  
Rouge / Port Allen  
Dock cranes, conveyors, mobile  
equipment.  
400-linear ft. of water frontage.  
50,000 sq ft  
30,000 sq ft  
Barge terminal just inside of the  
Port Allen locks. Facility meets a  
demand for cargo transfers  
between barge, storage and truck.  
The terminal is located on the  
Intracoastal Waterway in Port Allen,  
adjacent to the Port of Greater  
Baton Rouge.

## Port Allen

**Port of Greater Baton Rouge**  
PO Box 380  
Port Allen  
LA  
70767  
USA  
Contact: Ms Karen St. Cyr  
Job Title: Director of Public Affairs  
T: + 1 225 342 1660 ext. 1206  
F: + 1 225 342 1666  
E: stcyrk@portgbr.com  
W: www.portgbr.com

## Port Angeles

**Port of Port Angeles**  
338 West First Street  
Port Angeles  
WA 98362  
USA  
Contact: Mr Jeffery Robb  
Job Title: Executive Director  
T: + 1 360 457 1138  
F: + 1 360 452 3959  
E: jeffr@portofpa.com

## Port Arthur

**Pabtex**  
209 Taft Ave. Extension  
PO Box 3635  
Port Arthur  
TX 77643  
USA  
Contact: Mr Greg Alder  
Job Title: Terminal Manager  
T: + 1 409 962 8343  
F: + 1 409 962 8581  
E: gregalder@savageservices.com  
W: www.savageservices.com

## Port Arthur

**Port of Port Arthur**  
PO Box 1428  
221 Houston Avenue  
Port Arthur  
TX  
77641  
USA  
Contact: Mr Orlando Ciramella  
Job Title: Senior Director of Trade  
Development  
T: + 1 409 983 2011  
F: + 1 409 985 9312  
E: orlando@portofportarthur.com  
W: http://www.portofportarthur.com/  
On Gulf Intracoastal Waterway - 19  
miles Gulf of Mexico  
75 ton level lifting gantry crane  
Dock length 946m; Road Dock  
25m; 31m April; 40' water  
69m  
48m

## Port Hueneme

**Port Hueneme Port Authority**  
PO Box 608  
Port Hueneme  
CA  
93044  
USA  
Contact: Mr Tony  
Job Title: Executive Director  
T: + 1 805 488 3677  
F: + 1 805 488 2620

E: wberg@portofhueneme.org

## Port Newark

**Port Authority of NY & N Jersey**  
260 Kellogg Street  
3 Rd Floor  
Port Newark  
NY  
N.J. 07114  
USA  
Contact: Mr Robert Gaffney  
Job Title: Director  
T: + 1 212 435 6001  
F: + 1 212 435 6030  
E: rgaffney@panynj.gov

## Port Royal

**Port of Port Royal**  
South Carolina State Ports  
Authority  
601 Paris Avenue  
Port Royal  
SC  
29935-2431  
USA  
Contact: Mr A J Pesavento  
Job Title: Terminal Manager  
T: + 1 803 524 9311  
F: + 1 803 524 5397  
E: scspainfo@scspa.com  
W: www.portofcharleston.com/  
proyal.htm

## Port Smith

**Granite State Minerals**  
227 Market Street  
Port Smith  
New Hampshire  
03801  
USA  
Contact: Mr Paul Wentworth  
Job Title: Marketing  
T: + 1 603 436 8505  
E: gmsalt@aol.com  
Mid-Atlantic- USA  
Conventional/Self un-loader  
Capacity  
40 Acres  
100,000 Sq Ft  
Dry Cargo Specialist

## Portland

**Columbia Grain Elevator**  
1300 SW 5th Avenue  
Suite 2929  
Portland  
Oregon  
97201  
USA  
Contact: Mr Amer Badawi  
Job Title: VP  
T: + 1 503 224 8624  
F: + 1 503 241 0296  
E: web-info@columbiagrains.com  
W: www.columbiagrains.com

## Portland

**International Terminals**  
PO Box 10047  
Portland  
Oregon  
97296-0047  
USA  
Contact: Mr Chuck Ford  
Job Title: Terminal Superintendent  
T: + 1 503 286 6923  
F: + 1 503 286 6960  
E: cterhune@schn.com  
W: www.intterm.com

## Portland

**Port of Portland**  
PO Box 3529  
Portland  
OR  
97208  
USA  
Contact: Mr Josh Thomas  
Job Title: Media Relations Manager  
T: + 1 503 415 6054  
E: joshua.thomas@portofportland.com

W: www.portofportland.com  
The Port is located in Portland,  
Ore. at the confluence of the  
Columbia and Willamette Rivers.  
Terminal 2: 49 acres, bulk,  
breakbulk steel, heavy lift project  
cargo.  
Terminal 4: 280 acres, autos,  
mineral and liquid bulks.  
Terminal 5: 159 acres, mineral  
bulks, grain, manufacturing.  
Terminal 6: 386 acres, containers,  
autos, breakbulk steel.  
Terminal 2: 4 berths, draught 35-  
43', 50t and 40t cranes.  
Terminal 4: 7 berths, draught 35-43'  
Terminal 5: 2 berths, 1 industrial  
dock, draught 43'  
Terminal 6: 5 berths, 9 quayside  
gantry cranes, draught 43'  
310,000 sq ft  
The Port's proximity to major  
highways, mainline railroads, and  
barging on the Columbia-Snake  
River system provide auto, bulk,  
breakbulk, liquid bulk and container  
shippers with cost-effective, reliable  
gateways to domestic and  
international markets.

## Portsmouth

**Sprague Energy**  
Two International Drive  
Suite 200  
Portsmouth  
New Hampshire  
03801  
USA  
Contact: Mr James Therriault  
Job Title: VP Marketing  
T: + 1 603 430 5372  
F: + 1 603 766 7448  
E: jtherriault@spragueenergy.com  
W: www.spragueenergy.com  
North East United States.  
Searsport Maine, Portland Maine,  
Portsmouth NH, Boston MA,  
Providence RI  
Twenty terminals

## Providence

**Waterson Terminal Services**  
35 Terminal Road  
Providence  
RI  
02905  
USA  
Contact: Mr Christopher Waterson  
Job Title: General Manager  
T: + 1 401 461 9900 ext 230  
F: + 1 401 461 6240  
E: chris@watersonllc.com  
W: www.watersonllc.com  
Port of Providence, Rhode Island  
Including 2x Barge Cranes with  
140 ton stevedoring capacity and  
up to 1,500 TPH production rates.  
6 berths - 3500 linear feet of  
berthing. Please see website  
www.watersonllc.com for further  
details.  
20+ acres paved open lay down  
area.  
Two warehouses totaling over  
250,000 square feet of storage.  
Sited on our 105 acres we offer  
over 3,500 feet of linear berthing  
capable of working 6 vessels at any  
one time.

## Pueblo

**Association of American Railroads**  
PO Box 11130  
Pueblo  
CO  
81001  
USA  
Contact: Ms Patricia Reilly  
Job Title: Vice President  
Communications  
T: + 1 719 584 0749



F: + 1 719 585 1895  
E: preilly@aar.org  
W: www.aar.org

**Redwood City**

**Port of Redwood City**  
675 Seaport Blvd  
Redwood City  
CA  
94063-2794  
USA  
Contact: Mr Steve Wright  
Job Title: Operations Manager  
T: + 1 650 306 4150 ext 16  
F: + 1 650 369 7636  
E: swright@redwoodcityport.com  
San Francisco Bay in Northern California - mid way between San Francisco and San Jose  
Not applicable - Private equipment  
5 Wharves with 34 draught

**Reserve**

**Associated Terminals at Globalplex**  
1342 Highway 44  
Reserve  
Louisiana  
70084  
USA  
Contact: Mr Barry Hoth  
Job Title: Vice President  
T: + 1 985 479 6358  
F: + 1 985 479 6360  
E: barry@associatedterminals.com  
W: www.associatedterminals.com  
Miles 136-141 Lower Mississippi River  
Two dock-mounted gantry cranes, fleet of midstream stevedoring cranes as well as mobile cargo handling equipment  
Five berths  
177,000 sq ft  
206,000 sq ft  
Associated Terminals at Globalplex is one of the largest multiple purpose terminals on the Lower Mississippi River. Both bulk and breakbulk cargoes can be handled and stored in multiple warehouses as well as in open storage. Rail and truck connections are available.

**Reserve**

**Associated Terminals LLC**  
1342 Highway 44  
Reserve  
Reserve  
Louisiana  
70084  
USA  
Contact: Mr Todd Fuller  
Job Title: Sr. Vice President  
T: + 1 985 536 4520  
F: + 1 985 536 4521  
E: todd@associatedterminals.com  
W: www.associatedterminals.com  
Lower Mississippi River miles 56.8 to 141.5  
Fleet of high-capacity floating cranes plus mobile equipment  
12 midstream berths  
427,000 sq ft  
536,000 sq ft  
Associated Terminals is one of the largest midstream stevedoring companies on the Mississippi River, operating a fleet of twelve high capacity floating cranes. The company transloads cargo to and from vessels and barges at twelve mid-stream anchorage facilities on the lower Mississippi, as well as at additional dockside and on-site locations.

**Richmond**

**Levin Richmond Terminal Corporation (LRTC)**  
402 Wright Avenue  
Richmond

CA  
94804  
USA  
Contact: Ms Barbara N. O'Neill  
Job Title: Director of Marketing - Bulk Operations  
T: + 1 510 307 4009  
F: + 1 510 236 0129  
E: barbara@levinterminal.com  
W: www.levinterminal.com  
West Coast of United States  
Three 50-tonne diesel/hydraulic gantry cranes, One 25-tonne electric gantry crane. New ship-loader rated at 1,000tph.  
2 Berths, A-Berth Depth is -12.5m, 182.9m length.  
Berth, Depth is -9.1m, 243.8m length  
12.14 hectares  
15,850m covered storage being used for calcined petroleum coke. Privately owned and operated diversified marine dry bulk facility. Rail served by RPRC, which connects with the UPRR and BNSF.

**Richmond**

**Port of Richmond**  
1411 Harbour Way South  
Richmond  
California  
CA 948404  
USA  
Contact: Mr Jim Matzorkis  
Job Title: Executive Director  
T: + 1 510 215 4600  
F: + 1 510 233 3105  
E: Richmondport@yahoo.com

**Roanoke**

**Ashtabula Coal Pier**  
110 Franklin Road  
Roanoke  
VA  
24042-0026  
USA  
Contact: Mr Randy Carter  
Job Title: Director  
T: + 1 540 985 6795 / + 1 540 524-6044  
F: + 1 540 985 6398  
E: Randy.Carter@nscorp.com

**Saint Paul**

**Port of St Paul**  
Village Cove  
St Paul Port Authority  
PO Box 901  
Saint Paul  
Alaska  
AK 99660  
USA  
Contact: Mr Larry Mercurliett  
Job Title: City Manager  
T: + 1 907 546 3140  
F: + 1 907 546 3140  
E: info@sppa.com

**Salt Lake City**

**Savage Companies**  
6340 South  
3000 East Suite 600  
Salt Lake City  
Utah  
84121  
USA  
Contact: Mr Nathan Savage  
Job Title: Director Marketing Coal & Petcoke  
T: +1 801 944 6600  
E: nathans@savagecompanies.com

**San Diego**

**Port of San Diego**  
601 Switzer St  
10th Avenue marine Terminal  
San Diego  
California  
CA 92101-7811  
USA

Contact: Ms Marguerite Elicone  
Job Title: Principal PR/Marketing Representative  
T: + 1 619 686 6281  
F: + 1 619 686 7288  
E: helpdesk@portofsandiego.org  
W: www.portofsandiego.org

**San Francisco**

**Port of San Francisco**  
Pier 1, The Embarcadero  
San Francisco  
California  
CA 94111-4263  
USA  
Contact: Mr Jim Maloney  
Job Title: Maritime Marketing Manager  
T: + 1 415 274 0519  
F: + 1 415 274 0412  
E: Jim.Maloney@sfpport.com  
W: www.sfpport.com

West Coast of United States in Central California.  
6 gantry cranes  
6 deepwater berths  
120,000sqm

**San Pedro**

**Los Angeles Export Terminal**  
160 W 6th Street  
San Pedro  
CA  
90731  
USA  
Contact: Mr Jim Holland  
T: +1 562 436 5234  
F: + 1 310 732 0107  
E: jeholland@laxtinc.com

**San Pedro**

**Los Angeles Harbour Department**  
425 South Palos Verdes Street  
PO Box 151  
San Pedro  
CA  
90733  
USA  
Contact: Mr Jim Mac Lellan  
Job Title: Director of Trade Services  
T: + 1 310 732 3870  
E: jmaclellan@portla.org

**San Pedro**

**Marine Terminals Corporation**  
2001 John S. Gibson Blvd  
San Pedro  
CA  
90731  
USA  
Contact: Mr Dan Wylie  
Job Title: Executive V P - General Stevedoring Operations  
T: +1 510 4 208 578  
F: +1 510 5 479 352  
E: donwy@mtcorp.com

**San Pedro**

**Port of Los Angeles**  
PO Box 151  
San Pedro  
California  
90733-0151  
USA  
Contact: Ms Geraldine Knatz  
Job Title: Executive Director  
T: + 1 310 7323456  
F: + 1 310 8316936  
E: kos-read@portla.org  
W: www.portoflosangeles.org

**San Pedro**

**World Port LA (Port of Los Angeles)**  
425 S.Palos Verdes St  
PO Box 151  
San Pedro  
CA  
90733

USA  
Contact: Ms Geraldine Knatz  
Job Title: Executive Director  
T: + 1 310 732 7678  
E: gknatz@portla.org  
W: www.portoflosangeles.org

**Sandusky**

**CT Stevedoring**  
2705 West Monroe Street  
PO Box 2647  
Sandusky  
OH  
44870  
USA  
Contact: Mr Ron House  
Job Title: General Manager  
T: + 1 419 626 0801  
F: + 1 419 626 8248  
E: Ron.house@coopertsmith.com  
W: www.coopertsmith.com

**Sandusky**

**Sandusky Dock Corporation, Pier #3**  
2705 West Monroe Street  
PO Box #899  
Sandusky  
Ohio  
44870  
USA  
Contact: Mr Jeff Smith  
Job Title: Superintendent  
T: + 1 419 626 1215  
F: + 1 419 483 1296  
E: jeff.smith@nscorp.com  
W: www.nscorp.com  
Pier #3 is nearly a mile in length and surrounded on three sides by the waters of Sandusky Bay, Ohio, USA  
Ship-loader is capable of loading 9,000 tons per hour (cars and reclaim combined) with a 75' outboard reach

**Savannah**

**Georgia Ports Authority USA**  
PO Box 2406  
Savannah  
Georgia  
31402  
USA  
Contact: Mr Bill Jakubsen  
Job Title: Global Manager, Ro-Ro, Bulk & General Cargo  
T: + 1 912 964 3891  
F: + 1 912 964 3869  
E: bjakubsen@gaports.com  
W: www.gaports.com  
Georgia's deepwater ports of Savannah & Brunswick are geographically positioned on the U.S. East Coast, centrally located to service the U.S. Southeast and Midwest.  
The GPA maintains an extensive inventory of bulk handling equipment. Visit www.gaports.com for handling equipment details by terminal and port. Or, email bjakubsen@gaports.com.  
Deepwater Berthing, All Terminals  
Visit www.gaports.com for berthing details by terminal and port. Or, email bjakubsen@gaports.com.  
Multiple Terminal Operations combining to provide over 85 ha of open storage.  
Multiple Terminal Operations combining to provide 190,500 m2 of covered storage.  
Port of Brunswick:  
1. Colonel's Island Terminal Agri-bulk Facility owned & operated by GPA.  
Served by 2 class 1 railroads and immediate access to interstate.  
2. Mayor's Point Terminal owned & operated by GPA. Focus on Forest Products.  
3. East River Terminal in

Brunswick, Georgia leased to Logistec, USA, Inc. They are operating a wood pellet & wood chips export terminal.

**Savannah**

**Metro Ports**  
16 Foundation Drive  
Garden City  
Savannah  
GA  
31408  
USA  
Contact: Mr Ted Winter  
Job Title: VP Business Development  
T: + 1 310 816 6545  
F: + 1 912 963 5640  
E: info@metroports.com  
W: www.metroports.com  
Port of Savannah Berth 1A

**Seattle**

**Port of Seattle**  
Pier 69  
PO Box 1209  
Seattle  
WA 98111  
USA  
Contact: Mr Mic Dinsmore  
Job Title: Executive Director  
T: + 1 206 728 3000  
F: + 1 206 728 3754  
E: info@portseattle.org  
W: www.portseattle.org

**Seattle**

**Stevedoring Services of America**  
1131 SW Klickitat Way  
Seattle  
WA  
98134  
USA  
Job Title: Pay Roll  
T: + 1 206 623 0304  
F: + 1 206 623 0179  
E: info@ssamarine.com  
W: www.ssofa.com

**Seward**

**Aurora Energy Services, LLC**  
PO Box 1789  
Seward  
Alaska  
99664  
USA  
Contact: Mr Victor Stoltz  
Job Title: General Foreman  
T: + 1 907 224 3120  
F: + 1 907 224 3921  
E: vstoltz@usibelli.com  
Seward, Alaska, USA  
Bucketwheel stacker reclaim.  
Fixed position luffing & slewing shiploader. Load rate 700-1,000tph.  
Berth type: dolphin 900ft (berth face), 1,360ft (dolphin to dolphin)  
Stockpile capacity 190,000mt  
Year round ice free port

**Seward**

**Port of Seward**  
PO Box 167  
Seward  
Alaska  
AK 99664  
USA  
Contact: Mr Foster Singleton  
Job Title: Harbour Master  
T: + 1 907 2243331  
F: + 1 907 2247187  
E: harbormaster@cityofseward.net

**Skagway**

**Port of Skagway**  
City of Skagway  
PO Box 415  
Skagway  
Alaska  
AK 99840

USA  
 Contact: Mr Matt O'Boyle  
 Job Title: Harbour Master  
 T: + 1 907 983 2628  
 F: + 1 907 983 3087  
 E: m.oboyle@skagway.org  
 W: www.skagway.org

## St Louis

**Bunge St Louis**  
 PO Box 28500  
 St Louis  
 Missouri  
 63146  
 USA  
 Contact: Mr Roy Tomson  
 T: + 1 314 292 2000  
 E: bna.ebusiness@bunge.com  
 W: www.bungenorthamerica.com

## St Louis

**Cahokia Marine Services**  
 1441 Hampton Avenue  
 St Louis  
 MO  
 63139  
 USA  
 Contact: Mr John Brereton  
 Job Title: Vice President Marketing  
 T: + 1 314 647 7529  
 F: + 1 314 647 8084  
 E: jbrereton@slay.com

## Stamford

**Oxbow Carbon Minerals**  
 850 Canal Street  
 Stamford  
 Connecticut  
 CT 06902  
 USA  
 Contact: Mr Gary J. Dielsi  
 Job Title: Vice President,  
 Operations  
 T: + 1 203 353 8888  
 E: gary.dielsi@oxbow.com

## Stockton

**Metro Ports**  
 World Trade Centre - Suite J  
 2321 West Washington Street  
 Stockton  
 California  
 95203  
 USA  
 Contact: Mr Jon Allyn  
 Job Title: Director, Business  
 Development  
 T: + 1 510 522 9164  
 F: + 1 310 816 6519  
 E: info@metroports.com  
 W: www.metroports.com  
 Port of Stockton

## Stockton

**Metropolitan Stevedore Company**  
 2321 West Washington Street  
 Suite J  
 Stockton  
 CA  
 95203  
 USA  
 Contact: Mr Thomas Mogan  
 Job Title: Terminal Manager  
 T: + 1 209 943 7252  
 F: + 1 209 943 2656  
 E: thomas.mogan@metsteco.com  
 W: www.metsteco.com  
 California Delta  
 3,000 Mtp  
 11.3m Draught; 335m Berth (with  
 Dolphins)  
 48,600 sqm (Other Port tenants)  
 None  
 Truck pit and rotary rail car tipper

## Stockton

**Port of Stockton**  
 2201 W. Washington Street  
 PO Box 2089  
 Stockton  
 CA



95201  
 USA  
 Contact: Mr Bill Lewicki  
 Job Title: Director of Marketing  
 T: + 1 209 946 0246  
 F: + 1 209 466 5986  
 E: blewicki@stocktonport.com  
 W: www.portofstockton.com  
 75 nautical miles (120 km) East  
 from San Francisco Bay, California  
 USA.  
 Bulk export loading tower  
 Average channel depth at 10.6m  
 809 hectares  
 715,000 sqm  
 Serviced by both Union Pacific &  
 BNSF RR

## Stockton

**Sunshine Cement, Inc**  
 Suite I  
 2321 West Washington  
 Stockton  
 CA 95203  
 USA  
 Contact: Mr Randy Snyder  
 Job Title: VP / GM  
 T: + 1 209 467 8325  
 F: + 1 209 467 8065  
 E: rsnyder@sunshinecement.com

## Superior

**Cenex Harvest States**  
 41 Dock St  
 PO Box 518  
 Superior  
 WI  
 54880  
 USA  
 Contact: Mr Lance Helgeson  
 Job Title: Superintendent  
 T: + 1 715 392 4734  
 F: + 1 715 394 6926  
 E: lance.helgeson@chcinc.com

## Superior

**Peavey Company - Connor's  
 Point Elevator**  
 400 N Mail Street  
 PO Box 937  
 Superior  
 WI  
 54880  
 USA  
 Contact: Mr Mick Sertich  
 Job Title: Superintendent  
 T: + 1 715 392 9853  
 F: + 1 715 392 9874  
 E: msertich@conagrain.com

## Superior

**Superior Midwest Energy  
 Terminal**  
 PO Box 787  
 Superior  
 Wisconsin  
 54880  
 USA  
 Contact: Mr Fred Shusterich  
 Job Title: Vice President  
 T: + 1 715 392 9807  
 F: + 1 715 392 9137  
 E: fshusterich@midwestenergy.com  
 W: www.midwestenergy.com

## Tacoma

**Port of Tacoma Authority**  
 Port of Tacoma

PO Box 1837  
 Tacoma  
 WA  
 98401  
 USA  
 Contact: Mr Larry Kvidera  
 Job Title: Manager Marketing &  
 International Trade  
 T: + 1 253 428 8650  
 E: lkvidera@portoftacoma.com  
 W: www.portoftacoma.com

## Tacoma

**Stevedoring Services of America**  
 1980 Milwaukee Way  
 Tacoma  
 WA 98421  
 USA  
 Contact: Mr Bob Luxa  
 Job Title: General Manager  
 T: + 1 253 383 1763  
 F: + 1 253 272 9570  
 E: robert.luxa@ssamarine.com  
 W: www.ssamarine.com

## Tallahassee

**Florida Ports Council**  
 315 Calhoun Street  
 Suite 712  
 Tallahassee  
 FL  
 32301  
 USA  
 Contact: Mr Michael Rubin  
 @with line:

## Tampa

**Kinder Morgan Terminals -  
 Tampaplex Terminal**  
 Southeast Regional Office  
 4942 Port Sutton Road  
 Tampa  
 Florida  
 33619  
 USA  
 Contact: Mr Roy Cook  
 T: + 1 414 769 1901 ext-120  
 F: + 1 414 769 1144  
 E: roy\_cook@kindermorgan.com  
 W: www.kindermorgan.com

## Tampa

**Tampa Bay International  
 Terminals Inc**  
 1101 Channelside Drive  
 Tampa  
 Florida  
 33602  
 USA  
 Contact: Mr Robert (Bob) Callahan  
 Job Title: President, CEO  
 T: + 1 813 241 1805  
 F: + 1 813 241 1810  
 E: bcallahan@tampaport.com  
 W: www.tampaport.com

## Tampa

**Tampa Bay Stevedores Ltd**  
 4801 Port Sutton Road  
 Tampa  
 Florida  
 33619  
 USA  
 Contact: Mr William Rudolph  
 T: + 1 813 248 1971  
 F: + 1 813 242 8011

## Tampa

**Tampa Port Authority**  
 1101 Channelside Drive  
 Tampa  
 Florida  
 33602  
 USA  
 Contact: Mr Greg Lovelace  
 Job Title: Director of Marketing  
 T: + 1 813 9055123  
 F: + 1 813 9055109  
 E: glovelace@tampaport.com  
 W: www.tampaport.com  
 Central west coast of Florida (USA)  
 max draft/berth dimension: max  
 alongside/height of dock  
 face/commodities handled:  
 berth 1: 10.28m/198m/2.28m/scrap  
 berth 2: 10.21m/198m/2.28m/liquid  
 sulphur  
 berth 3: 9.44m/168m/2.28/cement  
 berth 21: 5.8m/137m/2.4m  
 berth 22: 10.4m/213m/3m/liquid  
 sulphur  
 berth 23:  
 10.5m/304m/3.65m/fertilizer  
 berth 24:  
 10.28m/217.9m/2.4m/chemical  
 berth 24b: 4.3m/68.5m/1.9m/berth  
 berth 26:  
 9.6m/243.8m/3.35m/cement,  
 aggregate  
 berth 30: 13.1m/304.7m/2.6m/LPG  
 berth 31:  
 13.1m/304.7m/2.6m/cement,  
 aggregate  
 berth 204:  
 10.3m/280m/3m/fertilizer  
 berth 205:  
 10.3m/176.7m/2.6m/juice  
 berth 219:  
 11.4m/263.6m/3.35m/bulk  
 berth 220: 12.4m/274m/3.35m/bulk  
 berth 223:  
 10.2m/228.5m/2.4m/petro  
 berth 224: 4.2m/54.8m/2.4m/bulk  
 berth 226: 12.1m/268m/2.4m/petro  
 berth 227: 12.1m/268m/2.4m/petro  
 berth 256: 10.28m/230m/3.04m/dry  
 bulk  
 Contact Tampa Port Authority  
 Contact Tampa Port Authority  
 As Florida's largest port, Tampa  
 handles nearly 50 M tpa, or half of  
 the State of Florida's total seaborne  
 cargo tonnage.

## Tampa

**United Maritime Group**  
 601 S Harbour Island Boulevard  
 Suite 230  
 Tampa  
 Florida  
 33602  
 USA  
 Contact: Mr Robin Hastings  
 Job Title: Vice President,  
 Commercial  
 T: + 1 813 209 4218  
 F: + 1 813 273 0248  
 E: sales@united-mar.com  
 W: www.unitedmaritimegroup.com

## Texas City

**Oxbow Carbon & Minerals LLC**  
 PO Box 100  
 Texas City  
 TX  
 77592  
 USA  
 Contact: Mr Don Covert  
 Job Title: Facility Manager  
 T: + 1 409 944 3500  
 F: + 1 409 944 3523  
 E: Don.Covert@oxbow.com  
 W: www.oxbow.com  
 Texas Gulf Coast, USA  
 Stationary Dry Bulk Ship Loader.  
 Load Rate 20,000 metric tons per  
 weather working day of 24  
 consecutive hours.  
 Dock #45, 1 berth

22 acres

## Texas City

**Port of Texas City**  
 Texas City Terminal Railway Co  
 2425 Highway 146 N  
 Texas City  
 TX 77590  
 USA  
 Contact: Mr Dennis Jennings  
 Job Title: Director of Rail  
 Operations  
 T: + 1 409 945 4461(x23)  
 F: + 1 409 945 8479  
 E: info@railporttc.com  
 W: www.railporttc.com

## Toledo

**ADM Grain Company Ltd**  
 1301 Miami St.  
 Toledo  
 Ohio  
 43605  
 USA  
 Contact: Mr Marty Wendt  
 Job Title: Regional Manager,  
 Northern Ohio & Michigan  
 T: + 1 419 324 0800  
 F: + 1 419 324 0791  
 E: marty\_wendt@admworld.com  
 W: www.admworld.com  
 Lake Erie  
 Load and discharge vessels  
 2 berths  
 9.2 million bushel  
 CSXT 65 car train Loader. Can also  
 unload covered hoppers. In  
 addition, Inbound and Outbound  
 trucks.

## Toledo

**CSX Coal Dock**  
 PO Box 8279  
 Station A  
 Toledo  
 OH  
 43605  
 USA  
 Contact: Mr Paul LeCompte  
 T: + 1 419 697 2353  
 F: + 1 419 697 2320  
 E: paul\_lecompte@csx.com  
 W: www.csx.com

## Toledo

**Midwest Terminals of Toledo  
 International, Inc**  
 3518 St. Lawrence Drive  
 Toledo  
 OH  
 43605  
 USA  
 Contact: Mr Jason Lowery  
 Job Title: Director of Business  
 Development  
 T: + 1 419 897 6868 ext 211  
 F: + 1 419 691 7016  
 E: jason.lowery@mwti.com  
 W: www.midwestterminals.com  
 Great Lakes (West end of Lake  
 Erie)  
 6 shore cranes, ship loading  
 conveyor  
 7 berths for a total of 4,000 feet of  
 dock frontage  
 100 acres  
 675,000 square feet  
 - Located at the mouth of the  
 Maumee River with no air draught  
 restrictions  
 - Seaway Draught at all berths  
 - 24 hour discharge service  
 - Foreign Trade Zone  
 - NYMEX approved warehouse  
 space  
 - Central location to several  
 markets; 40 percent of US  
 households within 10 hours  
 - Truck and Rail served



**Toledo**

Toledo-Lucas County Port Authority



One Maritime Plaza, 7th Floor  
Toledo  
Ohio  
43604  
USA  
Contact: Mr Joseph Cappel  
Job Title: Director of Cargo Development  
T: + 1 419 243 8251  
F: + 1 419 243 1835  
E: jcappel@toledoportauthority.org  
W: www.toledoseaport.org  
Western Basin of Lake Erie at the mouth of the Maumee River General Cargo Facility (Midwest Terminals of Toledo International Inc.) has mobile harbor cranes and gantry cranes for bulk, project cargo, break-bulk handling. Ship loading conveyor system, hoppers and loaders for bulk material handling, on-dock rail, FTZ #8, warehousing, LME and NYMEX approved facility.  
General Cargo Facility (Midwest Terminals of Toledo International Inc.) has 1,250 m. of dock frontage with a Seaway draft of 8.5 m. accommodates multiple loaded vessels with no air draft restrictions. 1,133,120sqm  
62,710sqm  
As the most cargo diverse and largest land mass Port on the Great Lakes, we have a terminal to match your cargo's handling requirements and your logistics needs. Please contact the Toledo-Lucas County

Port Authority for additional information.

**Valdez**

**Port of Valdez**  
PO Box 307  
Valdez  
Alaska  
AK 99686  
USA

Contact: Ms Diane Kinney  
Job Title: Port Operations Supervisor  
T: + 1 907 835 4564  
F: + 1 907 835 4479  
E: portofvaldez@ci.valdez.ak.us  
W: www.ci.valdez.ak.us/port

**Vancouver**

**Port of Vancouver, USA**

3103 Lower River Road  
Vancouver  
Washington  
98660  
USA

Contact: Mr Alastair Smith  
Job Title: Sr. Director of Marketing and Operations  
T: + 1 360 893 3611  
F: + 1 360 735 1565  
E: info@portvanusa.com  
W: www.portvanusa.com  
Pacific Northwest on the Columbia River approximately 106 miles from the Pacific Ocean.  
Liebherr 500S model Crane capable of 140 tonnes. P&H Crane/80 tonne capacity. Paccoc Crane/ 53 tonne capacity w/spreader bar. Big Washington Crane/60 tonne capacity.  
Grain Elevator, Berth 1  
715' length w/dolphins  
Depth: 40' draught  
One mobile gantry spout served by conveyor system, one marine leg serving belt conveyor, silos. Total

storage capacity about 5 million bushels.

Dry bulk dock, Berth 7  
800' length  
Depth: 40' draft  
Telescoping conveyor loader  
250 acres of open storage and marshalling yards  
1,194,610 sq feet  
Accessible by river, road and rail, the Port of Vancouver, USA is well-equipped to handle all kinds of bulk cargo including mineral concentrates, bentonite clay, copper concentrates, bauxite, hydrate aluminum and ores.

**Vancouver**

**United Grain Corp**

900 Washington Street  
Suite 700  
Vancouver  
WA  
98660  
USA  
Contact: Mr Augusto Bassanini  
Job Title: VP Marketing  
T: + 1 360 816 1901  
E: augusto@ugcpnw.com  
W: www.ugcpnw.com

**Vancouver**

**Vancouver-United Grain Elevator**

1927 Elevator Way  
Vancouver  
Washington  
98660  
USA

Contact: Mr John Todd  
Job Title: Manager  
T: + 1 360 693 1521  
F: + 1 360 694 1986  
E: jtodd@unitedharvest.com

**Wheelersburg**

Norfolk Southern - Wheelersburg Terminal

110 Franklin Road  
Roanoke  
Virginia  
24042-0026  
USA  
Contact: Mr Randy Carter  
Job Title: Director Industrial Coal Marketing & Transloading  
T: + 1 540 985 6795  
F: + 1 540 985 6398  
E: Randy.Carter@nscorp.com  
W: www.nscorp.com

**Whittier**

**Whittier Port Authority**

**Commission**  
PO Box 639  
Whittier  
Alaska  
99693  
USA  
Contact: Ms Sue Miller  
Job Title: Harbourmaster  
T: + 1 907 4722327  
F: + 1 907 4722472  
E: harbormaster@whittieralaska.gov  
W: www.whittieralaska.gov

**Wilmington**

**Metro Ports**

348 Shipyard Blvd  
Wilmington  
NC 28412  
USA  
Contact: Mr Ted H Winter  
Job Title: Vice President Business Development  
T: + 1 310 816 6545  
F: + 1 910 798 6188  
E: info@metports.com  
W: www.metports.com  
Port of Wilmington

**Wilmington**

**Metro Ports**

348 Shipyard Blvd  
Wilmington  
California  
NC 28412  
USA  
Contact: Mr Rob Waterman  
Job Title: Vice President, Bulk Operations  
T: + 1 310 816 6557  
F: + 1 310 816 6519  
E: rob.waterman@metsteco.com  
W: www.metsteco.com  
The Port of Long Beach, CA USA  
2 shiploaders 5,000tph, 2,500tph capacity  
2 berths (40', 50' draught) 1800' total wharf length, rotary and bottom dump rail car receiving  
2 truck bottom dump pits  
The operations staff at Metropolitan Stevedore Company has extensive experience in the handling of bulk cargoes. Metropolitan has a rich history of every kind and of every description. From grab buckets to highly automated, fully enclosed systems. We are the experts in our field.

**Wilmington**  
**Metropolitan Stevedore Company**  
PO Box 547  
Wilmington  
California  
90748  
USA  
Contact: Mr Malcolm Pitt  
T: + 1 562 983 8425  
F: + 1 562 983 8520  
E: malcolm.pitt@metsteco.com  
W: www.metsteco.com  
USA; South California, Port of Long Beach  
2 travelling shiploaders. #1 - 2,500 MT/Hour, # 2 - 5,000 MT/Hour

# THE PORT OF TOLEDO

The Port of Toledo - a 12 time recipient of the Robert J. Lewis Pacesetter Award - is at the forefront of cargo handling technology on the Great Lakes. Home to 15 terminals and a full service shipyard, the Port of Toledo is the largest landmass seaport on the Great Lakes. The Toledo-Lucas County Port Authority has acquired two new Liebherr Mobile Harbor Cranes, a High Rise Material Handler and other modern technologies that make it one of the most modern ports in the Midwest.

**A newly launched virtual tour at [www.tourtheport.com](http://www.tourtheport.com), provides customers a convenient and timely look at Toledo's waterfront resources.**



TOLEDO | LUCAS COUNTY  
**PORT AUTHORITY**

[toledoseaport.org](http://toledoseaport.org)

| +1 419 243 8251



1548m - wharf.  
5.24m Draught - Berth 212.  
12.2m Draught - Berth 214  
12,787 sqm  
81,550 sqm (5 Port Tenants)  
2 truck receiving pits, rotary rail car  
tipper, 2 rail bottom dumps.

**Wilmington**

**North Carolina State Ports  
Authority/ Wilmington**

PO Box 9002  
2202 Burnett Road  
Wilmington  
NC  
28402  
USA  
Contact: Ms Susan Pridgen  
Job Title: Editorial Specialist,  
External Affairs  
T: + 1 910 343 6492  
E: susan.pridgen@ncports.com  
W: www.ncports.com  
Located on the eastbank of the  
Cape Fear River  
7 container cranes, 2 gantry  
cranes, 4 x 100ft gauge container  
cranes to be delivered early 2007,  
9 top-lift container handlers &  
various other cargo handling  
equipment.  
42' shipping channel, bulk and  
general cargo berths. Open and  
covered storage dry bulk facility.  
Covered dry bulk facility w/2.5  
million cubic foot storage capacity &  
import conveyor system for grain  
which can handle 1,000 tons per  
hour. Export woodchip facility.  
80 acres of paved, open area;  
nearly 25 acres of semi-improved  
open storage area.  
Almost 1 million sq. ft. of covered,  
sprinklered storage.  
Nearly 100 acres available for dev.  
North of present terminal. 94 acres  
available for development South of  
present terminal.

**Wilmington  
Pasha Stevedoring & Terminals**



802 S Fries Ave  
Wilmington  
CA  
90744  
USA  
Contact: Mr Fred Vandeventer  
Job Title: VP, Contract  
Administration  
T: + 1 310 233 2000  
E: Fred.vandeventer@  
psterminals.com  
W: www.psterminals.com  
Port of Los Angeles, California  
Berths 174-181  
Berths 153-155..Berths 207-209  
Forklifts 2T-45T For all cargoes,Top  
handlers,Side Handlers, Mafi  
Trailers, Bobcats & UTR's, 3-41mt  
hammerhead shore cranes  
174-181~40 acres ~ 255,000 ft  
covered storage , water depth  
35ft-45ft Rail access, 3300 Linear  
feet berth space  
153-155~ 12 acres~180,000 ft  
covered storage , water depth 32-  
35 ft, 1700 linear feet berth space  
207-209~86 acres~2180 linear feet  
berth space, 40-45 water depth,  
50,000 ft covered space  
With supporting omni-terminal  
operations, and diversified in  
international vessel loading, Pasha  
Stevedoring & Terminals excels in  
containers, breakbulk, steel, and

heavy-lift cargo, providing  
personalized solutions for faster,  
safer shipments.

**Wilmington**

**Port of Wilmington,  
Delaware/Diamond State Port Co**

Robert F. Senseny Administration  
Building  
1 Hausel Road  
Wilmington  
Delaware  
19801-5852  
USA  
Contact: Mr Gene Bailey  
Job Title: Executive Director  
T: + 1 302 472 7802  
F: + 1 302 472 7825  
E: gbailey@port.state.de.us  
W: www.portofwilmingtonde.com  
Mid-Atlantic Port on the confluence  
of the Christina and Delaware  
Rivers, 65 miles from the Atlantic  
Two 50 ton capacity gantry  
container/bulk cranes  
7 deep-water berths on the  
Christina and another berth on the  
Delaware River  
33 acres on-dock, adjacent off-site  
storage and distribution facilities  
available  
250 sf of dry warehouse, adjacent  
off-site storage and distribution  
facilities available  
Specialized services:  
Product tarping, scale weighs,  
project management, engineering  
oversight, customized on-site  
processing, site facilitatng,  
inventory management, material  
bagging / packaging, palletizing,  
material sizing, material blending,  
crushing / Screening, dust  
management / control, in-plant  
operations, rail access.

**VENEZUELA**

**Estado**

**Venteminales**  
Apartado 234  
Puerto Cabello  
Estado  
Carabobo  
Venezuela  
Contact: Mr Johan Vermeulen  
T: + 58 242 769 647  
F: + 58 242 769 358  
E: agemar@agemar.com.ve

**Guidad Guayana**

**Interalumina**  
Zone Ind Mantanzas Apt 289  
Estado Boliver  
Guidad Guayana  
Venezuela  
Contact: Mr L Mok  
Job Title: Gerente de Planta  
T: + 58 212 911 411  
F: + 58 212 911 411  
E: info@interalumina.com.ar

**Maracaibo**

**BDV - Bulkguasare de Venezuela,  
SA**

(subsidiary of Coeclerici Logistics  
SPA)  
Calle 77  
Esq. Av 3C - Edif. Los Cerros  
Piso 4. of 4B  
Maracaibo Zulia 4001  
Venezuela  
Contact: Captain Guido Villani  
Job Title: Terminal Manager  
T: + 58 414 364 1331  
F: + 58 261 793 3576  
E: guidus2000@hotmail.com  
W: www.coeclerici.com  
Lake of Maracaibo  
8,000,000tpa  
Max Beam: 44m  
60,000t  
Commercial Contact: Capt

Giordano Scotto Coeclerici  
Logistics Spa- Piazza Diaz 7-  
20123 Milan- email:  
newprojects@coeclerici.com

**Maracaibo**

**Carbones del Guasare SA**  
Centro De Operaciones Guasare  
Av 9B Edif Banco  
Industrial Piso 5  
Maracaibo, Zulia 4001  
Venezuela  
Contact: Mr Jose Rios  
Job Title: Marketing  
T: + 58 261 797 3831  
F: + 58 261 790 6664  
E: jrrios@guasare.com  
W: www.guasare.com

**Maracaibo**

**Port Authority of Maracaibo**  
Av 2 El Milagro  
Modulo De Servicio  
Puerto de Maracibo  
Maracaibo  
Venezuela  
Contact: Ms Teresa Reyes  
Job Title: Commercial Manager  
T: + 58 0261 7231721  
F: + 58 0261 7231272  
E: info@puertodemaracaibo.com  
W: www.puertodemaracaibo.com

**Santa Cruz de Mara**

**Santa Cruz Coal Terminal**  
Carbones del Guasare SA  
Terminal de Embarque  
Edificio Banco Industrial, Piso 3  
Santa Cruz de Mara  
Edo Zulia 4002  
Venezuela  
Contact: Ms Larissa Chacin  
Job Title: Marketing Manager  
T: + 58 261 790 6620  
E: lchacin@guasare.com  
W: www.guasare.com

**VIETNAM**

**Ho Chi Min city**

**Ho Chi Minh Port Authority**

No 3 Nguyen  
Tat Thanh Street  
District 4  
Ho Chi Min city  
Vietnam  
Contact: Mr Tran Van On  
T: + 84 8 829 1825  
F: + 84 8 822 4168  
E: csg@hcm.vnn.vn

**Ngo Quyen District**

**Haiphong Port Authority**

84 Tran Phu Street  
Ngo Quyen District  
Hai Phong 8431  
Vietnam  
Contact: Mr Chang Mgyuen  
Job Title: Secretary to the General  
Director  
T: + 84 31385 9945  
F: + 84 31383 6943  
E: haiphongport@hn.vnn.vn  
W: www.haiphongport.com.vn  
20 52 N - 106 43'E, North East of  
Vietnam  
- 33 Multipurposed shore cranes:  
with lifting capacity from 5t to 42t  
- 2 Floating cranes: with lifting  
capacity from 10 to 85t  
- 6 QC: lifting capacity: 36t  
- 12 RTG: lifting capacity: 40t  
- 46 forklifts: from 3 to over 20t  
- 25 Mobile crane: from 25 to 50t  
- 4 Electronic weighing bridge: 80t  
- 10 tug boats  
11 berths with total lengths of 2 km  
600,000sqm  
40,000sqm







# Pasha Stevedoring & Terminals Handles All Cargo All The Time

Pasha Stevedoring & Terminals excels in handling steel, breakbulk, agricultural products, containers, and heavy-lift/project cargo, with supporting Omni-terminal operations and expert diversification in international vessel loading.

*Delivering personalized solutions for faster, safer shipments.*



PORT OF LOS ANGELES • PORT OF SAN DIEGO • PORT OF GRAYS HARBOR

(310) 835-9869 / [www.psterminals.com](http://www.psterminals.com)

# PORTS & TERMINALS COMMODITIES HANDLED

**KEY:**

- CL = coal
- CC = coking coal
- PC = petcoke
- G-A = grain/agribulk
- AF = animal feed
- CM = cement
- CLK = clinker
- IO = iron ore
- BX = bauxite
- AL = alumina
- FR = fertilizer
- G-FGD = gypsum & FGD
- AG = aggregates
- SU = sugar
- SOY = soya products
- SODA = soda ash
- MIN = mineral concentrates
- CHEM = powdered chemicals
- BC = bagged cargoes
- FRS = forest products
- STL = steel products
- P&P = pulp & paper
- MB = minor bulks
- OTH = other commodities



COMMODITIES	CL	CC	PC	G-A	AF	CM	CLK	IO	BX	AL	FR	G-FGD	AG	SU	SOY	SODA	MIN	CHEM	BC	FRS	STL	P&P	MB	OTH	
<b>ALBANIA</b>																									
<b>Durres</b>																									
Port Authority of Durres				✓																					
<b>ALGERIA</b>																									
<b>Algiers</b>																									
Enterprise Portuaire d'Alger																									
<b>Annaba</b>																									
Enterprise Portuaire de Annaba	✓	✓		✓	✓	✓	✓	✓			✓			✓	✓	✓		✓	✓	✓	✓	✓	✓	✓	✓
<b>Bejaia</b>																									
Entreprise Portuaire de Bejaia																									
<b>Beni Saf</b>																									
Entreprise Portuaire de Beni Saf																									
<b>Ghazaouet</b>																									
Port Authority of Ghazaouet	✓			✓							✓														
<b>Mostaganem</b>																									
Enterprise Portuaire de Mostaganem																									
<b>Skikda</b>																									
Enterprise Portuaire de Skikda				✓																					
<b>ANGOLA</b>																									
<b>Lobito</b>																									
Porto do Lobito E.P.				✓	✓	✓	✓	✓	✓		✓		✓		✓						✓	✓	✓	✓	✓
<b>Luanda</b>																									
Cabinda Gulf Oil Company Limited																									
<b>Luanda</b>																									
Porto de Luanda								✓																	
<b>ARGENTINA</b>																									
<b>Bahia Blanca</b>																									
Bahia Blanca Port				✓																					
<b>Bahia Blanca</b>																									
Glencore/Toepfer Grain Elevator				✓																					
<b>Bahia Blanca</b>																									
Oleaginoso Moreno Hermanos SA				✓																					
<b>Bahia Blanca</b>																									
Puerto De Bahia Blanca				✓																					
<b>Bahia Blanca</b>																									
Terminal Bahia Blanca, Piers 5/6, 7/8 and 9				✓																					



COMMODITIES	CL	CC	PC	G-A	AF	CM	CLK	IO	BX	AL	FR	G-FGD	AG	SU	SOY	SODA	MIN	CHEM	BC	FRS	STL	P&P	MB	OTH
<b>Barranqueras</b>																								
Puerto de Barranqueras																								
<b>Barranqueras</b>																								
Puerto de Barranqueras						✓		✓																
<b>Buenos Aires</b>																								
ACA Berth - San Lorenzo Port				✓																				
<b>Buenos Aires</b>																								
ACA Berth Nbr 3 - Quequen Port				✓																				
<b>Buenos Aires</b>																								
Del Bene SA				✓																				
<b>Buenos Aires</b>																								
Quebracho Elevator				✓																				
<b>Buenos Aires</b>																								
SA Berth				✓																				
<b>Buenos Aires</b>																								
Terminal 4				✓																				
<b>Buenos Aires</b>																								
Terminal Buenos Aires SA				✓																				
<b>Buenos Aires</b>																								
Terminal EMCYM				✓																				
<b>Buenos Aires</b>																								
Terminals Rio de la Plata																								
<b>Buenos Aires</b>																								
TPA Terminals Portuarias Argentinas																								
<b>Diamante</b>																								
Port of Diamante				✓																				
<b>Ensenada</b>																								
La Plata Port Administration								✓															✓	✓
<b>Puerto General San Martin</b>																								
Terminal 6 S.A.				✓											✓									
<b>Quequen</b>																								
Consorcio de Gestion del																								
Puerto de Quequen				✓							✓				✓									✓
<b>Quequen</b>																								
Puerto Quequen				✓																				
<b>Rosario</b>																								
Neptun SA - Operadores Maritimos				✓																				
<b>Rosario</b>																								
Puerto Rosario																								
<b>Rosario</b>																								
Puerto Rosario																								
<b>San Lorenzo</b>																								
Port of San Lorenzo				✓																				
<b>San Lorenzo</b>																								
Vicentin Elevator				✓																				
<b>San Pedro</b>																								
Puerto de San Pedro																								
<b>San Pedro</b>																								
Terminal Puerto San Pedro S.A.				✓							✓										✓		✓	✓
<b>Santa Fe</b>																								
Administration Puerto Santa Fe				✓																			✓	✓
<b>Villa Constitucion</b>																								
Villa Constitucion Port Authority				✓				✓														✓	✓	✓
<b>Zarate</b>																								
Zarate Port SA											✓							✓		✓	✓	✓		
<b>ARUBA</b>																								
<b>Oranjestad</b>																								
Port of Oranjestad													✓											
<b>San Nicolas</b>																								
San Nicolas Bay Port			✓								✓													
<b>AUSTRALIA</b>																								
<b>Adelaide</b>																								
ABB Grain				✓																				
<b>Adelaide</b>																								
Flinders Ports Pty Ltd						✓																		✓
<b>Adelaide</b>																								
Flinders Ports Pty. Ltd				✓	✓	✓	✓	✓			✓					✓	✓				✓			✓
<b>Adelaide</b>																								
Port Giles Grain Terminal				✓																				
<b>Adelaide</b>																								
Port Pirie Grain Terminal Berth 2				✓																				

# COMMODITIES HANDLED

COMMODITIES	CL	CC	PC	G-A	AF	CM	CLK	IO	BX	AL	FR	G-FGD	AG	SU	SOY	SODA	MIN	CHEM	BC	FRS	STL	P&P	MB	OTH
<b>Adelaide</b>																								
SACBH Ardrossan Grain Terminal				✓																				
<b>Adelaide</b>																								
Thevenard Grain Terminal				✓																				
<b>Adelaide</b>																								
Wallaroo Grain Terminal Berth 2				✓																				
<b>Albany</b>																								
Port of Albany				✓							✓													
<b>Brisbane</b>																								
Cape Flattery																							✓	
<b>Brisbane</b>																								
North Queensland Bulk																								
Ports Corporation Limited	✓	✓		✓					✓		✓			✓										✓
<b>Brisbane</b>																								
Port Weipa									✓														✓	
<b>Brisbane</b>																								
Queensland Bulk Handling																								
Coal Export Terminal	✓																							
<b>Bunbury</b>																								
Bunbury Port Authority				✓						✓	✓							✓			✓		✓	✓
<b>Burnie</b>																								
Tasmanian Ports																								
<b>Cairns</b>																								
Ports North											✓			✓									✓	✓
<b>Carrington</b>																								
GrainCorp Operations Ltd				✓																				
<b>Carrington</b>																								
Newcastle Agri Terminal				✓																				
<b>Carrington</b>																								
Port Waratah Coal Services																								
Limited (PWCS)	✓																							
<b>Dampier</b>																								
Dampier Port Authority									✓														✓	
<b>Darwin</b>																								
Darwin Port Corporation									✓															✓
<b>Darwin</b>																								
P&O Automotive and	✓			✓	✓	✓	✓	✓			✓	✓			✓	✓	✓	✓	✓	✓	✓	✓	✓	✓
General Stevedoring																								
<b>East Davenport</b>																								
P & O Automotive &																								
General Stevedoring									✓															
<b>East Perth</b>																								
James Point Pty Ltd (JPPL)																								
<b>Esperance</b>																								
Esperance Ports - Sean & Land				✓				✓			✓						✓							✓
<b>Fremantle</b>																								
Fremantle Ports	✓			✓							✓												✓	
<b>Geelong</b>																								
Geelong Port				✓	✓		✓		✓	✓	✓	✓	✓		✓	✓	✓			✓	✓	✓	✓	✓
<b>Geraldton</b>																								
Geraldton Port Authority				✓				✓			✓						✓						✓	
<b>Gladstone</b>																								
Barney Point Coal Terminal	✓																							
<b>Gladstone</b>																								
Central Queensland Ports Authority											✓												✓	
<b>Gladstone</b>																								
Gladstone Ports Corporation	✓			✓	✓	✓			✓		✓													
<b>Gladstone</b>																								
Gladstone Ports Corporation	✓																							
<b>Gladstone</b>																								
Grainco Queensland Gladstone																								
Terminal Berth 2				✓																				
<b>Hastings</b>																								
Port of Hastings Authority																					✓			✓
<b>Kooragang Island</b>																								
Newcastle Coal Infrastructure Group	✓																							
<b>Mackay</b>																								
Dalrymple Bay Coal Terminal (DBCT)	✓																							
<b>Melbourne</b>																								
P & O Ports - Geelong				✓							✓													
<b>Melbourne</b>																								
Port of Melbourne Corporation						✓					✓			✓										



COMMODITIES	CL	CC	PC	G-A	AF	CM	CLK	IO	BX	AL	FR	G-FGD	AG	SU	SOY	SODA	MIN	CHEM	BC	FRS	STL	P&P	MB	OTH
<b>Newcastle</b>																								
Newcastle Port Corporation	✓	✓	✓	✓	✓	✓			✓	✓	✓				✓	✓	✓	✓	✓	✓	✓	✓	✓	✓
<b>North Mackay</b>																								
Hay Point Coal Terminal (HPCT)	✓																							
<b>North Sydney</b>																								
Patrick Stevedores																								
Operations Pty Limited				✓	✓						✓								✓	✓	✓	✓	✓	✓
<b>Perth</b>																								
CBH Albany Grain Terminal				✓																				
<b>Perth</b>																								
CBH Esperance Grain Terminal				✓																				
<b>Perth</b>																								
CBH Geraldton Grain Terminal				✓																				
<b>Perth</b>																								
CBH Kwinana Grain Terminal				✓																				
<b>Pinekenba</b>																								
Grainco Queensland																								
Pinekenba Terminal				✓																				
<b>Port Adelaide</b>																								
Flinders Ports - Port Pirie	✓			✓				✓			✓						✓					✓		✓
<b>Port Hedland</b>																								
Port Hedland Port Authority								✓																✓
<b>Port Kembla</b>																								
Port Kembla Port Corporation	✓	✓		✓		✓	✓	✓	✓		✓	✓	✓	✓		✓	✓				✓	✓	✓	✓
<b>Port Lincoln</b>																								
Flinders Ports P/L				✓							✓													
<b>Port of Brisbane</b>																								
Port of Brisbane Pty Ltd	✓			✓		✓	✓				✓	✓	✓	✓	✓	✓					✓	✓		✓
<b>Portland</b>																								
Port of Portland Pty Ltd				✓	✓				✓	✓	✓						✓				✓		✓	✓
<b>Portland</b>																								
Vicgrain Portland Terminal				✓																	✓			
<b>Seventeen Mile Rocks</b>																								
Mitchell Ports																								
<b>Sydney</b>																								
Patrick the Australian Stevedore												✓										✓		✓
<b>Tasmania</b>																								
Tasmanian Ports Corporation (Tasports)																								
<b>Thevenard</b>																								
Thevenard Port				✓								✓												✓
<b>Toowoomba</b>																								
Grainco Queensland																								
Fisherman Island Terminal				✓																				
<b>Townsville</b>																								
Port of Townsville Limited		✓		✓	✓	✓		✓			✓			✓			✓					✓	✓	✓
<b>Walsh Bay</b>																								
Sydney Ports Corporation				✓		✓		✓			✓			✓								✓		
<b>West Perth</b>																								
Co-Operative Bulk Handling Ltd				✓																				
<b>Wollongong</b>																								
Port Kembla Coal Terminal Limited	✓		✓										✓											
<b>Wollongong</b>																								
Port Kembla Grain Terminal -				✓																				
<b>Wyndham</b>																								
CGL Wyndham Port																	✓		✓					
<b>Wynum Central</b>																								
Patrick Stevedores																							✓	✓
<b>BAHAMAS</b>																								
<b>Freeport</b>																								
Grand Bahama Port Authority																								
<b>BAHRAIN</b>																								
<b>Manama</b>																								
Mina Salman Port Authority				✓					✓															
<b>BANGLADESH</b>																								
<b>Chittagong</b>																								
Chittagong Port Authority				✓		✓					✓													
<b>BARBADOS</b>																								
<b>Bridgetown</b>																								
Barbados Port Authority						✓							✓											

# COMMODITIES HANDLED

COMMODITIES	CL	CC	PC	G-A	AF	CM	CLK	IO	BX	AL	FR	G-FGD	AG	SU	SOY	SODA	MIN	CHEM	BC	FRS	STL	P&P	MB	OTH	
<b>BELGIUM</b>																									
<b>Antwerpen</b>																									
Alfaport Antwerpen	✓			✓		✓					✓			✓						✓	✓	✓			
<b>Antwerpen</b>																									
Antwerp Bulk Terminal (ABT)	✓						✓	✓	✓		✓	✓	✓											✓	
<b>Antwerpen</b>																									
Antwerp Port Authority	✓			✓	✓	✓	✓	✓	✓		✓	✓	✓	✓						✓	✓	✓	✓		
<b>Antwerpen</b>																									
Boortmalt Group				✓																					
<b>Antwerpen</b>																									
Euroports Belgium NV									✓		✓			✓		✓									
<b>Antwerpen</b>																									
Noord Natie Terminal														✓											
<b>Antwerpen</b>																									
SCR - Sibelco																								✓	
<b>Brugge</b>																									
Firma Germain D'Hoore - Ostende																									
<b>Gent</b>																									
Arcelor Steel Belgium NV	✓		✓					✓																✓	
<b>Gent</b>																									
Ensagent NV			✓						✓		✓														
<b>Gent</b>																									
Euro-Silo NV				✓																					
<b>Gent</b>																									
Ghent Coal Terminal NV - GCT	✓	✓	✓																		✓			✓	
<b>Gent</b>																									
Ghent Port Company amp	✓	✓	✓	✓	✓	✓	✓	✓	✓	✓	✓	✓	✓	✓	✓	✓	✓	✓	✓	✓	✓	✓	✓	✓	✓
<b>Gent</b>																									
Ghent Transport & Storage				✓	✓			✓			✓		✓	✓	✓										
<b>Gent</b>																									
Manuport NV								✓	✓		✓			✓											
<b>Gent</b>																									
Mekol																									
<b>Gent</b>																									
Reyniers Havenbedryf NV											✓														
<b>Gent</b>																									
Stukwerkers Havenbedrijf NV				✓	✓		✓		✓		✓		✓							✓	✓	✓	✓		
<b>Kallo</b>																									
Belgian Scrap Terminal NV																									
<b>Kallo</b>																									
Metal Terminals International (MTI)																						✓		✓	
<b>Liege</b>																									
Liege Port Authority	✓	✓	✓	✓	✓	✓	✓	✓	✓	✓	✓	✓	✓		✓		✓	✓		✓	✓	✓	✓	✓	
<b>Liege</b>																									
Terval S.A.	✓											✓													
<b>Oostende</b>																									
Ter Polder	✓				✓		✓			✓	✓					✓	✓			✓	✓		✓	✓	
<b>Puurs</b>																									
SMEG Belgium NV				✓																					
<b>Roeselare</b>																									
Van Eeckhout Vervoermaatschappij						✓																			
<b>Seraing</b>																									
CTB Logistics SA	✓	✓	✓	✓	✓		✓	✓			✓						✓			✓	✓		✓		
<b>Zeebrugge</b>																									
Devreese & Simon NV																									
<b>Zeebrugge</b>																									
Zeebrugse Behandlings Maatschappij																									
<b>BENIN</b>																									
<b>Cotonou</b>																									
Port Autonome de Cotonou																									
<b>BERMUDA</b>																									
<b>Hamilton</b>																									
Department Marine & Port Services						✓																			
<b>BRAZIL</b>																									
<b>Anchieta</b>																									
Port Authority of Ponta Uba								✓																	
<b>Angra dos Reis</b>																									
Port of Angra dos Reis				✓																					
<b>Aracruz</b>																									
Portocel-Terminal Especializado																									



COMMODITIES	CL	CC	PC	G-A	AF	CM	CLK	IO	BX	AL	FR	G-FGD	AG	SU	SOY	SODA	MIN	CHEM	BC	FRS	STL	P&P	MB	OTH	
de Barra do Riacho																					✓		✓		
<b>Baia de Aratu</b>																									
Port of Aratu									✓		✓								✓						
<b>Belem</b>																									
Port Authority of Para				✓																					
<b>Belem</b>																									
Port of Belem				✓																					
<b>Fortaleza</b>																									
Port of Fortaleza				✓																					
<b>Ilheus</b>																									
Port of Ilheus				✓																					
<b>Imbituba</b>																									
Imbituba Port Authority	✓		✓								✓														
<b>Itaguaí</b>																									
CSN – Terminal de Carvão																									
e Minério TECAR	✓																								
<b>Jaragua</b>																									
Port of Maceio				✓										✓											
<b>Manaus</b>																									
Port of Manaus				✓																					
<b>Município de Oriximiná</b>																									
Trombetas Port									✓																
<b>Natal</b>																									
Natal Port Authority				✓																					
<b>Niteroi</b>																									
Port of Noiteroi				✓																					
<b>Para State</b>																									
Port Authority of Vila Do Conde									✓																
<b>Paranagua</b>																									
Paranagua Port Authority				✓																					
<b>Paranagua</b>																									
PFT-Paranaguá Forestry Terminals																					✓				
<b>Paranagua</b>																									
Port Silo/Socopar Berths 1/2; Gransol Berth 3				✓																					
<b>Pelotas</b>																									
Port of Pelotas				✓																					
<b>Porto Alegre</b>																									
Port of Porto Alegre	✓			✓																					
<b>Recife</b>																									
Port of Recife				✓										✓											
<b>Rio de Janeiro</b>																									
Cia Docas Do Rio de Janeiro																									
<b>Rio de Janeiro</b>																									
Companhia Portuaria																									
Baia de Sepetiba																									
<b>Rio de Janeiro</b>																									
Petroleo Brasileiro SA-Petrobras				✓																					
<b>Rio de Janeiro</b>																									
Port of Forno				✓																				✓	
<b>Rio de Janeiro</b>																									
Rio de Janeiro Port Authority	✓							✓	✓		✓														
<b>Rio Grande</b>																									
Bianchini Terminal				✓																					
<b>Rio Grande</b>																									
Port of Rio Grande				✓				✓			✓														
<b>Salvador</b>																									
Port Authority of Salvador																									
<b>Santos</b>																									
Companhia Docas do Estado de São Paulo - CODESP	✓			✓	✓						✓			✓	✓	✓					✓	✓	✓		
<b>Santos</b>																									
Port of Santos	✓	✓						✓			✓			✓	✓										
<b>Santos</b>																									
Tropical Agencia Maritima Ltda.	✓	✓	✓	✓	✓		✓		✓		✓	✓	✓				✓	✓						✓	
<b>Sao Francisco do Sul</b>																									
Sao Francisco do Sul Port Authority	✓			✓				✓			✓										✓	✓			✓
<b>Sao Luis</b>																									
Port of Ponta da Madeira				✓				✓	✓																
<b>Sao Paulo</b>																									
Coinbra - Grain				✓																					
<b>Vitoria</b>																									

# COMMODITIES HANDLED

COMMODITIES	CL	CC	PC	G-A	AF	CM	CLK	IO	BX	AL	FR	G-FGD	AG	SU	SOY	SODA	MIN	CHEM	BC	FRS	STL	P&P	MB	OTH
Capuaba Quay Grain Terminal/ Port of Vitoria				✓																				
<b>Vitoria</b>																								
Port Authority of Espirito Santo Vitoria				✓				✓																
Tubarao Port Authority	✓		✓					✓															✓	
<b>BULGARIA</b>																								
<b>Bourgas</b>																								
Bulk Terminal 2A	✓																							
<b>Bourgas</b>																								
Port of Bourgas JSC	✓	✓	✓	✓	✓		✓	✓	✓		✓			✓	✓		✓			✓	✓			✓
<b>CAMBODIA</b>																								
<b>Sihanoukville</b>																								
Sihanoukville Autonomous Port (PAS)				✓																				
<b>CAMEROON</b>																								
<b>Douala</b>																								
Cameroon National Ports Authority																								
<b>Douala</b>																								
Delmas Cameroon (CMA-CGM Group)				✓					✓												✓			
<b>CANADA</b>																								
<b>Becancour</b>																								
Becancour Waterfront Industrial Park	✓		✓	✓	✓				✓	✓	✓				✓				✓		✓			✓
<b>Belledune</b>																								
Port of Belledune	✓	✓	✓								✓	✓	✓				✓		✓	✓		✓		✓
<b>Burlington</b>																								
Lloyd's Register																								
<b>Churchill</b>																								
Hudson Bay Port Terminal				✓																				
<b>Contrecoeur</b>																								
Logistec	✓						✓	✓	✓		✓		✓				✓		✓					✓
<b>Contrecoeur</b>																								
Terminal Maritime Contrecoeur Inc	✓	✓				✓	✓	✓	✓		✓						✓							
<b>Corner Brook</b>																								
Corner Brook Port Corporation						✓																		
<b>Dartmouth</b>																								
Port Authority of Georgetown																						✓		
<b>Delta</b>																								
Westshore Terminals	✓	✓	✓																					
<b>Goderich</b>																								
Southpier Terminals Limited				✓							✓													
<b>Guelph</b>																								
Parrish & Heimbecker				✓	✓								✓		✓									
<b>Halifax</b>																								
Halifax Grain Elevator Ltd				✓																				
<b>Halifax</b>																								
Halifax Port Corporation				✓																			✓	
<b>Hamilton</b>																								
Hamilton Port Authority	✓		✓	✓			✓	✓			✓	✓	✓		✓					✓	✓		✓	✓
<b>Hamilton</b>																								
Richardson International Ltd				✓																				
<b>La Baie</b>																								
Alcan Primary Metal Group									✓															
<b>Milford</b>																								
National Gypsum Co Ltd												✓												
<b>Montreal</b>																								
Federal Marine Terminals	✓					✓			✓					✓										✓
<b>Montreal</b>																								
Les Silos Port-Cartier																								
<b>Montreal</b>																								
Logistec Corporation	✓				✓	✓	✓	✓	✓		✓	✓	✓	✓							✓	✓		✓
<b>Montreal</b>																								
Montreal Port Authority (Grain Terminal)				✓																				
<b>Montreal</b>																								
Port of Montreal Authority				✓	✓			✓			✓	✓	✓	✓	✓		✓		✓	✓	✓	✓	✓	✓
<b>Montreal</b>																								
Strudes Inc	✓		✓	✓		✓		✓	✓		✓											✓	✓	
<b>North Vancouver</b>																								
Kinder Morgan Canada Terminals																								



COMMODITIES	CL	CC	PC	G-A	AF	CM	CLK	IO	BX	AL	FR	G-FGD	AG	SU	SOY	SODA	MIN	CHEM	BC	FRS	STL	P&P	MB	OTH
Limited Partnership				✓	✓						✓						✓		✓				✓	✓
<b>North Vancouver</b>																								
Neptune Bulk Terminals (Canada) Ltd	✓										✓													
<b>North Vancouver</b>																								
Richardson International Ltd				✓																				
<b>Nova Scotia</b>																								
Port of Hantsport												✓												
<b>Oshawa</b>																								
Oshawa Harbour Commission																								
<b>Ottawa</b>																								
Portha Inc																								
<b>Ottawa</b>																								
Transport Canada									✓															
<b>Owen Sound</b>																								
Great Lakes Elevator				✓																				
<b>Parrsboro</b>																								
Port Authority of Parrsboro																								
<b>Port Cartier</b>																								
Les Silos Port Cartier				✓																				
<b>Port Colborne</b>																								
Port Colborne Grain Terminal				✓																				
<b>Prescott</b>																								
Port of Prescott				✓																				
<b>Prince Rupert</b>																								
Prince Rupert Port Authority	✓	✓		✓																	✓	✓	✓	✓
<b>Prince Rupert</b>																								
Prince Rupert, Ridley Island Grain Elevator				✓																				
<b>Prince Rupert</b>																								
Ridley Terminals Inc	✓	✓	✓					✓			✓										✓			
<b>Quebec City</b>																								
Bunge of Canada Elevator				✓																				
<b>Quebec City</b>																								
Quebec Port Authority	✓	✓		✓	✓	✓	✓	✓	✓	✓	✓	✓		✓									✓	
<b>Quebec City</b>																								
Sillery Distribution Center Inc.				✓																				
<b>Quebec City</b>																								
St Lawrence Stevedoring	✓	✓	✓				✓	✓	✓	✓	✓	✓	✓	✓			✓							✓
<b>Regina</b>																								
Viterra Inc				✓																				
<b>Saint John</b>																								
Saint John Port Authority			✓								✓		✓					✓	✓	✓	✓	✓	✓	✓
<b>Salaberry-de-Valleyfield</b>																								
Valport Maritime Services Inc.	✓			✓			✓		✓		✓		✓				✓	✓	✓	✓	✓	✓	✓	✓
<b>Saskatoon</b>																								
Canpotex Limited											✓													
<b>Sept-Iles</b>																								
Iron Ore Company of Canada								✓																
<b>Sept-Iles</b>																								
Porlier Express Inc	✓	✓	✓	✓					✓	✓			✓	✓			✓							
<b>Sept-Iles</b>																								
Sept-Iles Port Authority		✓	✓					✓		✓			✓	✓			✓				✓		✓	✓
<b>Sept-Iles</b>																								
Tessier Ltd																								
<b>Sept-Iles</b>																								
Wabush Mines																								
<b>Sorel-Tracy</b>																								
Richardson International (Quebec)				✓																				
<b>Squamish</b>																								
Squamish Terminals Ltd																			✓	✓	✓	✓		✓
<b>St Catharines</b>																								
The St Lawrence Seaway Management Corporation	✓	✓	✓	✓	✓	✓	✓	✓	✓	✓	✓	✓	✓	✓	✓	✓	✓	✓			✓	✓	✓	✓
<b>St Johns</b>																								
Port of Stephenville																								✓
<b>St Johns</b>																								
Ports & Harbours																								✓
<b>Sydney</b>																								
Sydney Ports	✓																							
<b>Thunder Bay</b>																								
Mission Terminal				✓																				

# COMMODITIES HANDLED

COMMODITIES	CL	CC	PC	G-A	AF	CM	CLK	IO	BX	AL	FR	G-FGD	AG	SU	SOY	SODA	MIN	CHEM	BC	FRS	STL	P&P	MB	OTH
<b>Thunder Bay</b>																								
Richardson International Ltd				✓																				
<b>Thunder Bay</b>																								
Thunder Bay Port Authority	✓		✓	✓							✓		✓			✓			✓	✓	✓	✓		
<b>Thunder Bay</b>																								
Thunder Bay Terminals Ltd	✓		✓	✓							✓													
<b>Thunder Bay</b>																								
Valley Camp Terminal, Inc.	✓	✓	✓								✓					✓					✓			
<b>Thunder Bay</b>																								
Western Grain By-Products				✓																				
<b>Toronto</b>																								
Toronto Port Authority	✓	✓		✓	✓	✓	✓				✓	✓	✓	✓	✓	✓	✓	✓		✓	✓	✓	✓	✓
<b>Trois-Rivières</b>																								
Groupe Somavrac																								
<b>Trois-Rivières</b>																								
Port of Trois Rivières	✓		✓	✓		✓	✓			✓	✓	✓			✓						✓	✓	✓	
<b>Trois-Rivières</b>																								
Somavrac Inc.																					✓	✓	✓	
<b>Trois-Rivières</b>																								
Three Rivers Elevators				✓																				
<b>Valleyfield</b>																								
Valport Maritime Services Inc	✓			✓	✓				✓		✓	✓	✓				✓	✓	✓	✓	✓	✓	✓	
<b>Vancouver</b>																								
Cascadia Terminal				✓																				
<b>Vancouver</b>																								
Port of Vancouver	✓			✓	✓						✓		✓	✓			✓				✓	✓	✓	✓
<b>Victoria</b>																								
Little Narrows Gypsum Company Ltd						✓																		
<b>Ville de La Baie</b>																								
Rio Tinto Alcan Port Alfred			✓						✓	✓														
<b>WaWa</b>																								
Michipicoten Harbour								✓	✓												✓			
<b>West Vancouver</b>																								
Canpotex Terminals Limited											✓													
<b>Windsor</b>																								
ADM Agri-Industries Company/				✓												✓								
<b>Windsor</b>																								
Port of Windsor				✓		✓							✓	✓	✓						✓	✓		✓
<b>Winnipeg</b>																								
Richardson International Ltd				✓																				
<b>Winnipeg</b>																								
Viterra				✓																				
<b>CANARY ISLANDS</b>																								
<b>Santa Cruz</b>																								
Junta del Puerto de Sto Cruz																								
<b>CAPE VERDE</b>																								
<b>Praia</b>																								
Capitania dos Portos de Sotavento																								
<b>CHILE</b>																								
<b>Antofagasta</b>																								
Caleta Coloso																								
<b>Arica</b>																								
Puerto Arica	✓			✓				✓			✓				✓		✓	✓						
<b>Castilla</b>																								
Tocopilla	✓																							
<b>Concepcion</b>																								
Neuling Graneles SA	✓			✓				✓	✓		✓													
<b>Iquique</b>																								
Empresa Portuaria Iquique																								
<b>La Serena</b>																								
Port Authority of Guayacan								✓																
<b>Lirquen</b>																								
Port of Lirquen SA											✓													
<b>Mejillones</b>																								
Puerto Angamos	✓		✓				✓											✓						✓
<b>Mejillones</b>																								
Puerto de Mejillones S.A	✓		✓				✓											✓						✓
<b>Mejillones</b>																								
Terminal Graneles del Norte S.A.	✓																✓	✓						
<b>Puerto Natales</b>																								
Port of Puerto Natales																								✓



COMMODITIES	CL	CC	PC	G-A	AF	CM	CLK	IO	BX	AL	FR	G-FGD	AG	SU	SOY	SODA	MIN	CHEM	BC	FRS	STL	P&P	MB	OTH
<b>Quintero</b>																								
Port Authority of Quintero	✓			✓					✓															
<b>San Antonio</b>																								
Puerto Panul S.A.																								
<b>Santiago</b>																								
E.CL S.A.	✓	✓	✓			✓	✓	✓		✓							✓	✓						✓
<b>Santiago</b>																								
Portuaria Puchoo SA	✓			✓																				
<b>Tocopilla</b>																								
Central Termoelectrica Tocopilla	✓																							
<b>Valparaíso</b>																								
Saam				✓																	✓			
<b>Valparaíso</b>																								
Valparaiso Port Authority	✓																							
<b>CHINA</b>																								
<b>Anqing</b>																								
Anqing Port Authority	✓							✓								✓								
<b>Beihai</b>																								
Behai Harbour Administration				✓																				
<b>Chiwan</b>																								
Chiwan Harbour Container																								
Office Building				✓		✓																		
<b>Chongquin</b>																								
Chongquin Port Authority	✓								✓				✓											
<b>Dalian</b>																								
Dalian Bay Coal Terminal	✓																							
<b>Dalian</b>																								
Dalian Port Authority	✓			✓																				
<b>Dalian</b>																								
DCW Group Co																								
<b>Dalian</b>																								
Ganjingzi Coal Terminal	✓																							
<b>Dongfang County</b>																								
Basuo Port Corporation	✓			✓	✓	✓		✓														✓		✓
<b>Fangcheng</b>																								
Fangcheng HarbourAdministration	✓																							✓
<b>Fujian Province</b>																								
Dongshan Port Authority						✓																		
<b>Fuzhou</b>																								
Fuzhou Port																								✓
<b>Guangzhou</b>																								
Xinggong No1				✓																				
<b>Haikou</b>																								
Haikou Port Authority								✓																
<b>Hong Kong</b>																								
China Cement Co (HK) Ltd						✓																		
<b>Hong Kong</b>																								
CLP Power HK Limited	✓																							
<b>Hong Kong</b>																								
The Hongkong Electric Company Ltd	✓															✓								
<b>Hualien</b>																								
Hualien Harbour Bureau	✓																							
<b>Jiangsu</b>																								
Port of Lianyungang	✓																							
<b>Jinzhou</b>																								
Jinzhou Port Authority						✓		✓	✓															✓
<b>Lianyungang</b>																								
Lianyungang Port Authority	✓			✓		✓																		
<b>Longkou City</b>																								
Longkou Port Authority				✓		✓																		✓
<b>Nanjing</b>																								
Nanjing Port Authority								✓																
<b>Nantong</b>																								
Nantong Port Authority	✓			✓																				
<b>Ningbo</b>																								
Ningbo Port Authority	✓			✓				✓					✓										✓	✓
<b>Pinghu</b>																								
Zhapu Port Authority	✓			✓		✓																		
<b>Putian</b>																								
Port of Xiuyu	✓			✓																			✓	✓
<b>Qingdao</b>																								
Port of Qingdao	✓			✓																			✓	✓

# COMMODITIES HANDLED

COMMODITIES	CL	CC	PC	G-A	AF	CM	CLK	IO	BX	AL	FR	G-FGD	AG	SU	SOY	SODA	MIN	CHEM	BC	FRS	STL	P&P	MB	OTH
<b>Qingdao</b>																								
Port of Qingdao Coal Terminal	✓																							
<b>Qingdao</b>																								
Xigang Company				✓				✓		✓	✓										✓	✓	✓	
<b>Qinhuangdao</b>																								
Qinhuangdao Port Authority	✓			✓		✓		✓			✓										✓	✓		✓
<b>Rizhao City</b>																								
Rizhao Port Authority	✓			✓		✓		✓	✓		✓													
<b>Sanya</b>																								
Sanya Port	✓			✓							✓			✓										✓
<b>Shanghai</b>																								
Ming Sheng Stevedores																								
No 3/4 Terminals				✓																				
<b>Shanghai</b>																								
Shanghai International																								
Port Group (SIPG)	✓			✓				✓	✓		✓													
<b>Shanghai</b>																								
Shanghai Port Luojing Bulk Terminals	✓																							
<b>Shantou</b>																								
Shantou Port																								✓
<b>Shenzhen</b>																								
Chiwan Port Authority				✓		✓					✓			✓										
<b>Shenzhen</b>																								
Shekou Port Service Co Ltd				✓																				
<b>Shenzhen</b>																								
Shenzhen Haixin Harbour																								
Development Co Ltd											✓											✓		
<b>Shenzhen</b>																								
Shenzhen Yantian Port								✓			✓											✓		✓
<b>Shijiazhuang</b>																								
Hebei Port Group Co, Inc	✓																							
<b>Taizhou City</b>																								
Port of Haimen	✓																							
<b>Tanggu</b>																								
Tianjin Port Authority	✓			✓					✓		✓											✓		
<b>Tanggu</b>																								
Tianjin Xingang Sinor Terminal Co Ltd																					✓	✓		
<b>Tangshan</b>																								
Jintang Port	✓																							
<b>Wenzhou</b>																								
Wenzhou Port																								✓
<b>Wuhu</b>																								
Wuhu Port Authority	✓			✓					✓		✓													
<b>Xiamen</b>																								
Xiamen Harbour Authority	✓			✓							✓													✓
<b>Yantai</b>																								
Yantai Port Authority	✓												✓									✓		
<b>Yingkou</b>																								
Port of Yingkou	✓			✓				✓			✓													✓
<b>Zhanjiang</b>																								
Zhanjiang Port Authority	✓			✓		✓			✓		✓		✓									✓		
<b>Zhanjiang</b>																								
Zhanjiang Port Authority	✓					✓		✓	✓															✓
<b>Zhenjiang</b>																								
Zhenjiang Port Authority	✓			✓				✓			✓													✓
<b>Zhoushan</b>																								
Zhoushan Port Administrative Bureau	✓					✓																		
<b>Zhoushan</b>																								
Zhoushan Port Haitong																								
Transshipment & Storage Co Ltd	✓																							
<b>COLOMBIA</b>																								
<b>Barranquilla</b>																								
Carbones del Carrejon LLC	✓																							
<b>Barranquilla</b>																								
Cementos del Caribe						✓																		
<b>Barranquilla</b>																								
Compas SA	✓	✓				✓	✓	✓	✓		✓	✓	✓						✓			✓		
<b>Barranquilla</b>																								
Port of Puerto Bolivar	✓																							
<b>Barranquilla</b>																								
Sociedad Portuaria Del Norte	✓			✓																				
<b>Barranquilla</b>																								



COMMODITIES	CL	CC	PC	G-A	AF	CM	CLK	IO	BX	AL	FR	G-FGD	AG	SU	SOY	SODA	MIN	CHEM	BC	FRS	STL	P&P	MB	OTH	
<b>Colombia</b>																									
Sociedad Portuaria Regional de Barranquilla SA	✓																								
<b>Barranquilla</b>																									
Tolu	✓																								
<b>Bogota</b>																									
Puertos de Colombia																									
<b>Bogota</b>																									
Santa Marta Coal Terminal	✓																								
<b>Buenaventura</b>																									
Sociedad Portuaria Regional de Buenaventura S.A				✓							✓														
<b>Santa Marta</b>																									
Port of Santa Marta	✓			✓											✓						✓			✓	
<b>Santa Marta</b>																									
Puerto Prodeco	✓																								
<b>Soceidad Portuaria Santa Marta</b>																									
CTS de Colombia	✓																								
<b>CROATIA</b>																									
<b>Ploce</b>																									
Port of Ploce Authority	✓	✓	✓	✓			✓	✓	✓	✓				✓	✓						✓	✓			✓
<b>Rijeka</b>																									
LUKA Rijeka d.d.	✓							✓							✓						✓				
<b>Rijeka</b>																									
Terminal Bakar	✓							✓																	
<b>Zadar</b>																									
Zadar Port Authority				✓		✓									✓										
<b>CUBA</b>																									
<b>Antilla</b>																									
Antilla Port Authority				✓										✓											
<b>Antilla</b>																									
Nicaró	✓																								
<b>Antilla</b>																									
Port of Felton											✓														
<b>Cardenas</b>																									
Port of Cardenas											✓			✓											
<b>Cienfuegos</b>																									
Port of Cienfuegos				✓		✓								✓											
<b>Havana</b>																									
Port Authority of Havana	✓			✓							✓														
<b>Mariel</b>																									
Port of Mariel														✓											
<b>Matanzas</b>																									
Port Authority of Matanzas											✓														
<b>Puerto Tarafa Nuevitas</b>																									
Port of Nuevitas						✓								✓											
<b>Santiago de Cuba</b>																									
Port of Santiago de Cuba				✓		✓								✓											
<b>CURACAO</b>																									
<b>Willemstad</b>																									
Curacao Ports Authority				✓		✓								✓					✓				✓	✓	✓
<b>CYPRUS</b>																									
<b>Nicosia</b>																									
Cyprus Port Authority																									
<b>Nicosia</b>																									
Lemesos Port c/o Cyprus Port Authority				✓	✓										✓						✓	✓		✓	
<b>Nicosia</b>																									
Port of Vassiliko c/o Cyprus Ports Authority		✓	✓	✓	✓	✓	✓	✓			✓				✓									✓	
<b>Nicosia</b>																									
Vassiliko Cement Works Ltd				✓		✓																			
<b>Nicosia</b>																									
Vassiliko Port				✓		✓																			
<b>DENMARK</b>																									
<b>Aabenraa</b>																									
Aabenraa Havn Port Authority				✓		✓																			
<b>Aabenraa</b>																									
Ensted Transit Harbour I/S	✓																				✓				
<b>Aalborg</b>																									
Aalborg Bulk Terminal				✓	✓						✓				✓						✓	✓		✓	

# COMMODITIES HANDLED

COMMODITIES	CL	CC	PC	G-A	AF	CM	CLK	IO	BX	AL	FR	G-FGD	AG	SU	SOY	SODA	MIN	CHEM	BC	FRS	STL	P&P	MB	OTH
<b>Aalborg</b>																								
Aalborg Portland						✓																		
<b>Aalborg</b>																								
Port of Aalborg				✓	✓		✓					✓	✓								✓	✓		✓
<b>Aarhus</b>																								
Cargo Service A/S				✓	✓						✓		✓		✓							✓	✓	
<b>Aarhus</b>																								
Port of Aarhus	✓			✓		✓																		
<b>Bandholm</b>																								
Port of Bandholm				✓							✓													
<b>Charlottenlund</b>																								
Copenhagen Merchants				✓	✓						✓				✓						✓			
<b>Copenhagen</b>																								
Copenhagen Malmo Port AB	✓		✓	✓		✓						✓	✓	✓							✓	✓	✓	✓
<b>Esbjerg</b>																								
Port of Esbjerg	✓																							
<b>Fredericia</b>																								
Associated Danish Ports A/S																								
Port of Fredericia				✓	✓	✓					✓		✓	✓	✓			✓				✓	✓	✓
<b>Fredericia</b>																								
DLA Agro				✓																				
<b>Fredericia</b>																								
Fredericia Bulk Terminal c/o																								
Fredericia Shipping				✓	✓						✓				✓						✓	✓	✓	✓
<b>Grenaa</b>																								
Grenaa Bulk Terminal				✓																				
<b>Grenaa</b>																								
Port of Grenaa Ltd.				✓																	✓			
<b>Haderslev</b>																								
Port of Haderslev				✓							✓													
<b>Horsens</b>																								
Port Authority Horsens				✓																				✓
<b>Kalundborg</b>																								
Asnaes Power Station									✓		✓													
<b>Kalundborg</b>																								
Kalundborg Bulk Terminal				✓																				
<b>Kalundborg</b>																								
Kalundborg Port Authority				✓	✓						✓	✓		✓								✓	✓	✓
<b>Kolding</b>																								
Kolding Port Authority				✓	✓	✓					✓				✓						✓	✓		
<b>Korsoer</b>																								
Port of Korsøer				✓		✓																		
<b>Naestved</b>																								
Naestved Port				✓							✓													✓
<b>Nakskov</b>																								
Nakskov Port				✓																				
<b>Nykøbing Falster</b>																								
Guldborgsund Havne	✓			✓							✓			✓						✓	✓		✓	✓
<b>Odense</b>																								
Port of Odense				✓		✓					✓											✓		✓
<b>Randers</b>																								
Randers Port	✓			✓	✓	✓	✓		✓		✓		✓		✓			✓			✓	✓	✓	✓
<b>Rodby</b>																								
Rodby Port Authority				✓							✓													
<b>Roenne</b>																								
BAF (Bornholms Andels Foderstofforretning)				✓																				
<b>Roenne</b>																								
Port of Roenne Ltd.	✓			✓	✓	✓					✓		✓		✓						✓		✓	
<b>Roenne</b>																								
Roenne Port Authority				✓																				
<b>Skaelskor</b>																								
Skaelskor Port Authority				✓																				
<b>Skaelskor</b>																								
Stigsnaesvaerkets Port Authority	✓																							
<b>Skoodstrup</b>																								
Studstrup Port Authority	✓																							
<b>Vordingborg</b>																								
Vordingborg Port Authority				✓							✓		✓											✓
<b>DOMINICAN REPUBLIC</b>																								
<b>Santa Domingo</b>																								
Port of Santo Domingo				✓							✓													



COMMODITIES	CL	CC	PC	G-A	AF	CM	CLK	IO	BX	AL	FR	G-FGD	AG	SU	SOY	SODA	MIN	CHEM	BC	FRS	STL	P&P	MB	OTH	
<b>Santo Domingo</b>																									
Agencias Navieras B&R, S.A.S	✓	✓	✓	✓	✓	✓	✓	✓	✓	✓	✓	✓	✓	✓	✓	✓	✓	✓	✓	✓	✓	✓	✓	✓	✓
<b>Santo Domingo</b>																									
Cabo Rojo Port Authority									✓															✓	
<b>Santo Domingo</b>																									
Maritima Dominicana SA	✓		✓	✓		✓	✓				✓		✓	✓	✓	✓	✓		✓	✓	✓	✓	✓	✓	✓
<b>ECUADOR</b>																									
<b>Guayaquil</b>																									
Port Authority of Guayaquil				✓																					
<b>EGYPT</b>																									
<b>Alexandria</b>																									
Alexandria Port Authority	✓			✓		✓					✓														
<b>Alexandria</b>																									
Kamaria Grain Terminal				✓																					
<b>Cairo</b>																									
Abu Zenima Port Authority								✓																	
<b>Cairo</b>																									
EI Sokhna Port Development Company								✓			✓														
<b>Cairo</b>																									
EI Wadi Holdings				✓																					
<b>Cairo</b>																									
Medsofts				✓																					
<b>Cairo</b>																									
Sinai Manganese Co S A E																									
<b>Damietta</b>																									
Damietta Port Authority				✓																					
<b>Damietta</b>																									
Mina Damyat Terminal				✓																					
<b>Hamrawein</b>																									
Hamrawein Port Authority									✓		✓														
<b>Ismailia</b>																									
Port Authority of Safaga				✓							✓		✓												
<b>Ismailia</b>																									
Suez Canal Authority																									
<b>Port Said</b>																									
Port Said Port Authority				✓																					
<b>Port Tewfik</b>																									
Red Sea Port Authority																									
<b>Safaga</b>																									
Safaga Grain Berth No1				✓																					
<b>EL SALVADOR</b>																									
<b>Acajutla</b>																									
Port of Acajutla				✓							✓														
<b>ERITREA</b>																									
<b>Assab</b>																									
Assab Port Administration				✓							✓														
<b>ESTONIA</b>																									
<b>Tallinn</b>																									
AS Baltic Chemical Terminal											✓														
<b>Tallinn</b>																									
AS Coal Terminal	✓																								
<b>Tallinn</b>																									
AS DBT (Dry Bulk Terminal)											✓														
<b>Tallinn</b>																									
AS MGT Muuga Grain Terminal				✓																					
<b>Tallinn</b>																									
KS Stevedoring				✓																					
<b>Tallinn</b>																									
Muuga (Novotallinskiy)	✓			✓							✓		✓											✓	
<b>Tallinn</b>																									
PETROMAKS SPEDITORI AS	✓			✓																					
<b>Tallinn</b>																									
Port of Tallinn	✓			✓	✓		✓			✓	✓		✓	✓	✓				✓	✓	✓	✓	✓	✓	✓
<b>Viimsi Vald</b>																									
AS Stivis	✓										✓										✓	✓			
<b>FJI</b>																									
<b>Suva</b>																									
Ports Authority of Fiji								✓																	

# COMMODITIES HANDLED

COMMODITIES	CL	CC	PC	G-A	AF	CM	CLK	IO	BX	AL	FR	G-FGD	AG	SU	SOY	SODA	MIN	CHEM	BC	FRS	STL	P&P	MB	OTH	
<b>FINLAND</b>																									
<b>Hamina</b>																									
Port of Hamina Ltd																					✓				
<b>Kokkola</b>																									
Oy M Raunheimo Ab																				✓	✓	✓			
<b>Kokkola</b>																									
Port of Kokkola						✓														✓	✓	✓			
<b>Kotka</b>																									
Port Of Kotka Ltd				✓							✓										✓			✓	
<b>Kotka</b>																									
Steveco Oy				✓							✓				✓		✓				✓				✓
<b>Kotka</b>																									
UPM Logistics																					✓		✓		
<b>Loviisa</b>																									
Port of Loviisa				✓	✓																				
<b>Naantali</b>																									
Port of Naantali	✓			✓		✓																			
<b>Naantali</b>																									
Port of Olkiluoto																									
<b>Oulu</b>																									
Herman Andersson Oy																									
<b>Oulu</b>																									
Oulu Stevedoring OY																									
<b>Oulu</b>																									
Port of Oulu				✓		✓																	✓		
<b>Pori</b>																									
Port of Pori	✓																				✓				✓
<b>Raahe</b>																									
Port of Raahe																								✓	
<b>Rauma</b>																									
Euroports Rauma (previously OY Rauma Stevedoring)											✓		✓					✓	✓	✓	✓	✓	✓	✓	✓
<b>Rauma</b>																									
Port of Rauma Authority				✓	✓																✓	✓	✓		✓
<b>Turku</b>																									
Port of Turku Authority				✓											✓						✓	✓	✓	✓	
<b>Vaasa</b>																									
Port of Vaasa	✓			✓	✓										✓										
<b>Vantaa</b>																									
Suomen Viljava Oy				✓																					
<b>FRANCE</b>																									
<b>Bassens</b>																									
CIMALIT						✓																			
<b>Bassens</b>																									
Gemadocks											✓														
<b>Bassens</b>																									
Sea-invest Bordeaux																									
<b>Bassens</b>																									
Ste Aquitaine du Silo de Bordeaux-Bassens				✓																					
<b>Blainville Sur Orne</b>																									
SOGEMAR																									
<b>Blaye</b>																									
Blaye Grain Terminal				✓																					
<b>Bordeaux</b>																									
Bordeaux Port Authority	✓			✓	✓	✓		✓			✓	✓	✓		✓					✓	✓	✓	✓	✓	✓
<b>Bordeaux</b>																									
SAIPOL				✓																					
<b>Bordeaux</b>																									
SEMABLA				✓																					
<b>Bordeaux</b>																									
SPBL				✓																					
<b>Boucau</b>																									
Maisica				✓																					
<b>Brest</b>																									
CCI - Chambre de Commerce et d'industrie																									
<b>Brest</b>																									
Port of Brest - CCI				✓	✓	✓	✓				✓	✓	✓								✓	✓			
<b>Brest</b>																									
Port of Brest - CCI				✓	✓	✓	✓				✓				✓										
<b>Brest</b>																									



COMMODITIES	CL	CC	PC	G-A	AF	CM	CLK	IO	BX	AL	FR	G-FGD	AG	SU	SOY	SODA	MIN	CHEM	BC	FRS	STL	P&P	MB	OTH
Port of Brest Dry Bulk Terminal				✓	✓	✓	✓				✓	✓	✓								✓			
<b>Calais</b>																								
Port of Calais																								
<b>Cedex 1</b>																								
Atlantic Pofrt La Rochelle	✓																							
<b>Cherbourg-Octeville</b>																								
Port de Cherbourg	✓																							
<b>Dieppe</b>																								
Dieppe Port				✓								✓									✓	✓		✓
<b>Dunkerque</b>																								
Port of Dunkerque	✓			✓				✓	✓		✓		✓	✓							✓	✓		
<b>Dunkerque</b>																								
Sea-Bulk Terminal																								
<b>Dunkerque</b>																								
SGD - Silo a Grain Dunkerque				✓																				
<b>Dunkerque</b>																								
Silonor				✓																				
<b>Fecamp</b>																								
Fecamp Port Authority																							✓	✓
<b>La Rochelle</b>																								
Port Atlantique La Rochelle																					✓			
<b>La Rochelle-Pallice</b>																								
Silo de la Rochelle Pallice				✓																				
<b>Le Havre</b>																								
Coal Terminal	✓																							
<b>Le Havre</b>																								
Le Havre Multi-Bulk Terminal	✓		✓	✓	✓											✓								
<b>Le Havre</b>																								
Port of Le Havre Authority	✓			✓	✓	✓		✓	✓		✓		✓	✓							✓	✓	✓	
<b>Le Portel</b>																								
Gie Boulogne Clinker						✓	✓																	
<b>Lorient</b>																								
Port de Commerce-Lorient				✓																				
<b>Marseille</b>																								
Marseilles Grain Terminal				✓																				
<b>Marseille</b>																								
Port Autonome de Marseille/Fos									✓															
<b>Marseille</b>																								
Port of Marseilles	✓	✓	✓	✓	✓	✓	✓	✓	✓	✓	✓		✓	✓	✓	✓			✓	✓	✓	✓	✓	✓
<b>Martigues</b>																								
Carfos	✓																							
<b>Montoir-de-Bretagne</b>																								
Sea-invest Montoir																								
<b>Montoir-de-Bretagne</b>																								
SONASTOCK & ATLANTIQUE STOCKAGE				✓																				
<b>Nantes</b>																								
Grand Port Maritime																								
Nantes St Nazaire	✓	✓	✓	✓	✓	✓	✓	✓			✓	✓	✓	✓	✓				✓	✓	✓		✓	✓
<b>Nantes</b>																								
Montoir Agri-Bulk Terminal				✓							✓													
<b>Nantes</b>																								
Montoir Coal Terminal	✓																							
<b>Nantes</b>																								
Port Atlantique-Montoir																								
Agri-Bulk Terminal	✓	✓	✓	✓	✓	✓	✓	✓	✓	✓	✓	✓	✓	✓	✓	✓	✓	✓	✓	✓	✓	✓	✓	✓
<b>Nantes</b>																								
Roche-Maurice Terminal				✓																				
<b>Nantes</b>																								
SODISTOCK Group				✓																				
<b>Nantes</b>																								
SONASTOCK - Nantes																								
Export Terminal				✓																				
<b>Paris</b>																								
Port of Paris Authority				✓		✓							✓											✓
<b>Port De Montoir</b>																								
Sea-invest France (Stocaloire)	✓			✓																				
<b>Rouen</b>																								
HAROPA																								
<b>Rouen</b>																								
Lecureur				✓																				
<b>Rouen</b>																								

# COMMODITIES HANDLED

COMMODITIES	CL	CC	PC	G-A	AF	CM	CLK	IO	BX	AL	FR	G-FGD	AG	SU	SOY	SODA	MIN	CHEM	BC	FRS	STL	P&P	MB	OTH	
<b>Maprochim</b>											✓														
<b>Rouen</b>																									
Port of Rouen	✓			✓	✓				✓		✓		✓	✓							✓	✓	✓	✓	
<b>Rouen</b>																									
SENALIA				✓																					
<b>Rouen</b>																									
SENALIA				✓																					
<b>Rouen</b>																									
Silos Soufflet -																									
SOCOMAC I/II Terminals				✓																					
<b>Rouen</b>																									
Simarex Villette				✓																					
<b>Rouen</b>																									
Sogema																									
<b>Saint Malo</b>																									
St Malo Port Authority	✓			✓	✓	✓	✓	✓	✓		✓	✓	✓	✓							✓	✓	✓	✓	
<b>Sète</b>																									
Sea-invest Sète																									
<b>Sète</b>																									
Sete-Multibulk Berth				✓																	✓		✓		
<b>St Malo</b>																									
SMG - Societe Malouine																									
et Granvillaise				✓							✓														
<b>Strasbourg</b>																									
Strasbourg Port Authority				✓							✓														✓
<b>Tarnos</b>																									
Matrama Bayonne				✓		✓					✓										✓	✓			
<b>Toulon</b>																									
Port of Toulon						✓	✓		✓																
<b>GABON</b>																									
<b>Libreville</b>																									
Libreville Port Authority													✓												
<b>Libreville</b>																									
Owendo Port Authority								✓	✓																✓
<b>GEORGIA</b>																									
<b>Poti</b>																									
Poti Sea Port Corporation																									
<b>GERMANY</b>																									
<b>Brake</b>																									
J. Müller Agri Terminal GmbH & Co. KG				✓	✓						✓			✓	✓	✓	✓		✓				✓	✓	
<b>Brake</b>																									
J. Müller Breakbulk Terminal GmbH & Co. KG																					✓	✓	✓		
<b>Brake</b>																									
Niedersachsen Ports GmbH & Co. KG				✓							✓			✓					✓			✓	✓		
<b>Bremen</b>																									
Weserport GmbH	✓	✓	✓	✓	✓	✓		✓	✓	✓	✓	✓									✓	✓			
<b>Bremerhaven</b>																									
bremenports GmbH & Co. KG	✓	✓		✓		✓		✓													✓	✓	✓		
<b>Brunsbüttel</b>																									
Brunsbüttel Ports GmbH	✓	✓	✓			✓	✓	✓	✓	✓	✓	✓						✓	✓	✓	✓	✓	✓	✓	✓
<b>Duisburg</b>																									
Duisburger Hafen AG	✓	✓			✓	✓		✓		✓	✓			✓					✓	✓	✓	✓	✓		
<b>Duisburg</b>																									
Rhenus AG & Co. KG	✓																								
<b>Emden</b>																									
Emden Port Authority				✓																				✓	
<b>Emden</b>																									
EVAG Emder Verkehrs und Automotive	✓	✓	✓	✓	✓	✓	✓	✓	✓	✓	✓	✓						✓				✓	✓	✓	✓
<b>Flensburg</b>																									
Flensburg Port Authority	✓			✓							✓		✓											✓	
<b>Hamburg</b>																									
Buss Group GmbH & Co. KG													✓					✓							
<b>Hamburg</b>																									
BUSS Ross Terminal GmbH & Co KG																									✓
<b>Hamburg</b>																									
Diamant Mühle Hamburg GmbH				✓																					



COMMODITIES	CL	CC	PC	G-A	AF	CM	CLK	IO	BX	AL	FR	G-FGD	AG	SU	SOY	SODA	MIN	CHEM	BC	FRS	STL	P&P	MB	OTH
<b>Hamburg</b>																								
Eichholtz GmbH				✓																				
<b>Hamburg</b>																								
GTH - Getreide Terminal																								
Hamburg (GmbH & Co.KG)				✓																				
<b>Hamburg</b>																								
H J M (H Jürgen Müller GmbH)	✓		✓	✓	✓		✓	✓	✓		✓	✓	✓		✓			✓	✓		✓		✓	
<b>Hamburg</b>																								
HaBeMa Futtermittel GmbH																								
& Co KG				✓																				
<b>Hamburg</b>																								
Hamburg Port Authority																								
<b>Hamburg</b>																								
Hamburg Sud																								
<b>Hamburg</b>																								
HANSAPORT	✓							✓																
<b>Hamburg</b>																								
K+S Terminal (Kalikai)				✓							✓						✓							
<b>Hamburg</b>																								
Kali- Transport Gesellschaft GmbH											✓													
<b>Hamburg</b>																								
Louis Hagel (GmbH & Co. KG)											✓													
<b>Hamburg</b>																								
Mittal Steel Hamburg GmbH								✓														✓		
<b>Hamburg</b>																								
NHG - Neuhof																								
Hafengesellschaft mbH				✓																				
<b>Hamburg</b>																								
OAM Baustoffe GmbH													✓											
<b>Hamburg</b>																								
Port of Hamburg																								
Marketing Association	✓			✓	✓	✓		✓	✓	✓	✓	✓		✓	✓	✓					✓	✓	✓	
<b>Hamburg</b>																								
Silo P. Kruse Betriebs-GmbH																								
& Co. KG				✓																				
<b>Hamburg</b>																								
Wilhelm Mulch GmbH & Co KG																								✓
<b>Itzehoe</b>																								
Itzehoe Port Authority				✓							✓													
<b>Krefeld</b>																								
Krefeld Port Authority				✓																				
<b>Leer</b>																								
Rhenus AG				✓	✓	✓		✓			✓				✓				✓	✓	✓	✓	✓	
<b>Neuss</b>																								
Neuss Port Authority				✓																				
<b>Nordenham</b>																								
Rhenus Midgard GmbH & Co. KG	✓	✓	✓	✓	✓	✓	✓	✓	✓		✓	✓								✓	✓	✓	✓	✓
<b>Nuremberg</b>																								
Hafen Nürnberg-Roth GmbH	✓			✓		✓	✓	✓			✓				✓							✓		✓
<b>Oldenburg</b>																								
Seaports of Niedersachsen GmbH	✓	✓		✓	✓	✓	✓	✓	✓	✓	✓	✓	✓	✓	✓	✓	✓	✓	✓	✓	✓	✓	✓	✓
<b>Rostock</b>																								
Bulk Terminal Rostock GmbH	✓			✓				✓			✓													
<b>Rostock</b>																								
Getreide Service Rostock GmbH				✓	✓		✓				✓													
<b>Rostock</b>																								
Seehafen Rostock																								
Umschlagsgesellschaft mbH	✓			✓				✓			✓													
<b>Stralsund</b>																								
Port of Stralsund				✓							✓		✓											✓
<b>Wilhelmshaven</b>																								
Rhenus Midgard																								
Wilhelmshaven GmbH & Co KG	✓	✓						✓																
<b>GHANA</b>																								
<b>Takoradi</b>																								
Ghana Ports & Harbours Authority																								
<b>Takoradi</b>																								
Takoradi Port Authority	✓			✓					✓		✓		✓											
<b>Tema</b>																								
Tema Port									✓															
<b>GREECE</b>																								

# COMMODITIES HANDLED

COMMODITIES	CL	CC	PC	G-A	AF	CM	CLK	IO	BX	AL	FR	G-FGD	AG	SU	SOY	SODA	MIN	CHEM	BC	FRS	STL	P&P	MB	OTH
<b>Alexandroupolis</b>																								
Alexandroupolis Port Authority				✓																				
<b>Aliveri</b>																								
Mylaki Port Authority	✓					✓																		
<b>Attica</b>																								
Milaki Port-East Mediterranean																								
Coal Terminal	✓																							
<b>Chalkis</b>																								
Chalkis Port Authority	✓					✓					✓													
<b>Chania Crete</b>																								
Suda Bay Port				✓																				
<b>Corfu</b>																								
Corfu Port Authority				✓																				
<b>Itea</b>																								
Itea Port Authority									✓															
<b>Kalamata</b>																								
Kalamata Port Authority				✓																	✓			
<b>Milos Island</b>																								
Milos Island Port Authority								✓	✓															
<b>Nissyros</b>																								
Yali Island Port Authority														✓										
<b>Piraeus</b>																								
Piraeus Port Authority				✓							✓													
<b>Pylos</b>																								
Pylos Port Authority																								✓
<b>Thessaloniki</b>																								
Thessaloniki Port Authority SA	✓			✓	✓	✓	✓	✓	✓		✓	✓			✓						✓	✓		✓
<b>GUADELOUPE</b>																								
<b>Point A Pitre</b>																								
Pointe-a-Pitre Port	✓			✓			✓				✓	✓	✓	✓										
<b>GUAM</b>																								
<b>Piti</b>																								
Apra Harbour													✓									✓		✓
<b>GUYANA</b>																								
<b>Georgetown</b>																								
Georgetown Port Authority				✓										✓										
<b>Kingston</b>																								
Linden Port Authority									✓															
<b>Kingston</b>																								
New Amsterdam Port Authority									✓															
<b>HAITI</b>																								
<b>Port Au Prince</b>																								
Port Au Prince Port Authority				✓		✓		✓						✓										
<b>HONDURAS</b>																								
<b>Puerto Cortes</b>																								
Terminales de Cortes, S.A de C.V				✓	✓	✓	✓				✓			✓							✓	✓	✓	
<b>Puerto Cortés</b>																								
National Port Company																								
<b>Puerto Cortés</b>																								
Puerto Cortes Port Authority				✓				✓	✓		✓			✓										
<b>ICELAND</b>																								
<b>Grundartangi</b>																								
Grundartangi Port	✓																							
<b>Hafnarfjordur</b>																								
Port of Hafnarfjordur									✓	✓			✓											✓
<b>Raohusinu</b>																								
Vestmannaeyjar Port Authority																								✓
<b>Reykjavik</b>																								
Associated Icelandic Ports				✓		✓					✓													
<b>INDIA</b>																								
<b>Adyar</b>																								
Subarnarekha Port Private Ltd	✓	✓	✓	✓		✓	✓	✓																
<b>Bhavnagar Gujarat</b>																								
Bhavnagar Port Authority																								✓
<b>Bhubaneswar</b>																								
DPCL - Dhamra Port																								
Company Limited	✓	✓						✓																
<b>Calcutta</b>																								



COMMODITIES	CL	CC	PC	G-A	AF	CM	CLK	IO	BX	AL	FR	G-FGD	AG	SU	SOY	SODA	MIN	CHEM	BC	FRS	STL	P&P	MB	OTH
Calcutta Port Trust	✓			✓		✓		✓	✓					✓										✓
<b>Calicut</b>																								
Calicut Port Authority				✓				✓	✓															
<b>Chennai</b>																								
Ennore Port Limited	✓							✓																
<b>Chennai</b>																								
Karaikal Port Private Limited	✓	✓	✓	✓		✓		✓			✓	✓	✓	✓					✓	✓	✓		✓	✓
<b>Chennai</b>																								
Port of Chennai	✓																							
<b>Chennai</b>																								
Sical Logistics Limited																								
<b>Churchgate</b>																								
Yogaytan Ports Pvt. Ltd.																								
<b>Cochin</b>																								
Cochin Port Trust	✓			✓		✓	✓		✓		✓	✓	✓			✓	✓				✓	✓	✓	✓
<b>Devanampattinam</b>																								
Cuddalore Port Authority	✓							✓																
<b>Dist. Nellore</b>																								
Krishnapatnam Port																								
Company Limited	✓	✓	✓	✓	✓	✓	✓	✓			✓	✓		✓			✓	✓	✓	✓	✓	✓	✓	✓
<b>Gandhinagar</b>																								
Gujarat Maritime Board	✓			✓		✓					✓													
<b>Goa</b>																								
Mormugao Port Trust	✓	✓	✓					✓	✓	✓	✓								✓		✓			✓
<b>Gujarat</b>																								
Dahej Port Authority											✓													
<b>Gujarat</b>																								
Kandla Port Trust				✓							✓													
<b>Haldia</b>																								
TM International Logistics Ltd.	✓	✓	✓																			✓		
<b>Hyderabad</b>																								
Gangavaram Port Limited	✓																							
<b>Karnataka State</b>																								
Karwar Port Authority								✓	✓		✓		✓											✓
<b>Karnataka State</b>																								
New Mangalore Port Trust	✓			✓				✓	✓		✓													
<b>Kolkata</b>																								
Riverine Group	✓	✓		✓				✓											✓					
<b>Kolkata</b>																								
T M International Logistics Limited		✓						✓			✓											✓		
<b>Minapore</b>																								
Haldia Port Authority	✓							✓	✓		✓													✓
<b>Mumbai</b>																								
Bombay Port Trust	✓			✓							✓													
<b>Mumbai</b>																								
J.M. Baxi & Co	✓			✓	✓			✓			✓			✓								✓	✓	
<b>Mumbai</b>																								
Seacrest Marine Services Pvt. Ltd.	✓			✓				✓																
<b>Mumbai</b>																								
Skil Infrastructure Ltd	✓																							
<b>Mundra</b>																								
Adani Ports and Special																								
Economic Zone Limited																								
<b>Nagapattinam</b>																								
Nagapattinam Port Authority				✓							✓													
<b>Nungambakkam</b>																								
International Seaports (India) Pvt Ltd	✓																							
<b>Orissa</b>																								
Paradip Port Trust	✓			✓				✓	✓		✓													✓
<b>Porbander</b>																								
Porbandar Port Authority	✓		✓	✓		✓			✓		✓													
<b>Port Okha</b>																								
Port Okha Port Authority	✓		✓	✓		✓	✓		✓		✓													✓
<b>Tuticorin</b>																								
Tuticorin Port Trust	✓			✓		✓		✓																
<b>Visakhapatnam</b>																								
Port of Visakhapatnam	✓							✓																✓
<b>Visakhapatnam</b>																								
Visakhapatnam Port Trust	✓					✓		✓	✓		✓													✓
<b>INDONESIA</b>																								
<b>Bandar Lampung</b>																								
PT. Bukit Asam (Persero) Tbk	✓																							

# COMMODITIES HANDLED

COMMODITIES	CL	CC	PC	G-A	AF	CM	CLK	IO	BX	AL	FR	G-FGD	AG	SU	SOY	SODA	MIN	CHEM	BC	FRS	STL	P&P	MB	OTH
<b>Banjarmasin</b>																								
Port of Banjarmasin	✓																							
<b>Bitung</b>																								
Port of Bitung																								
<b>Cilacap</b>																								
Cilacap						✓		✓			✓													✓
<b>Cilegon</b>																								
PT Krakatau Bandar Samudera	✓																							
<b>Irian Jaya</b>																								
Amamapare								✓	✓															
<b>Jakarta</b>																								
Balikipapan Coal Export Terminal	✓																							
<b>Jakarta</b>																								
Gebe Island								✓	✓															
<b>Jakarta</b>																								
North Pulau Laut Coal Terminal	✓																							
<b>Jakarta</b>																								
P T Indominco Mandiri	✓																							
<b>Jakarta</b>																								
PT Indonesia Bulk Terminal	✓	✓																						
<b>Jakarta</b>																								
PT MIANG BESAR COAL TERMINAL	✓																							
<b>Jakarta</b>																								
Pt. Pulau Laut																								
<b>Jakarta</b>																								
PT. Terminal Batubara Indah	✓																							
<b>Jakarta</b>																								
Pulau Laut	✓																							
<b>Jakarta</b>																								
Tanjung Priok				✓		✓																		✓
<b>Kijang</b>																								
Port of Kijang									✓															
<b>Kotabaru</b>																								
PT Indonesia Bulk Terminal	✓	✓																						
<b>Lampung</b>																								
Pelabuhan Panjang	✓			✓																				
<b>Lhokseumawe</b>																								
Port of Lhokseumawe											✓													
<b>Padang</b>																								
Port of Teluk Bayur	✓					✓																		
<b>Padang</b>																								
Teluk Bayur Coal Terminal	✓																							
<b>Palembang</b>																								
Kertapati Coal Terminal	✓																							
<b>Palembang</b>																								
Port Authority Palembang											✓													
<b>Sabang</b>																								
Port of Sabang	✓																							
<b>Surabaya</b>																								
Surabaya Port Authority	✓			✓							✓													
<b>Tanjung Priok</b>																								
Bogasari Flour Mills Terminal				✓																				
<b>IRAN</b>																								
<b>Tehran</b>																								
Bandar Abbas Port Authority				✓				✓			✓													
<b>Tehran</b>																								
Chah Bandar Port Authority								✓																
<b>Tehran</b>																								
Khorranshar Port Authority						✓																		
<b>IRELAND</b>																								
<b>Arklow</b>																								
Arklow Port Authority																✓								
<b>Cork</b>																								
Port of Cork Company	✓			✓	✓	✓					✓		✓		✓		✓				✓	✓	✓	✓
<b>Cork</b>																								
Ringaskiddy Deepwater Terminal				✓																				
<b>Dublin</b>																								
Dublin Port & Docks Board	✓			✓				✓	✓		✓		✓											✓
<b>Dundalk</b>																								
Dundalk Harbour Commissioners	✓			✓																				
<b>Foynes</b>																								



COMMODITIES	CL	CC	PC	G-A	AF	CM	CLK	IO	BX	AL	FR	G-FGD	AG	SU	SOY	SODA	MIN	CHEM	BC	FRS	STL	P&P	MB	OTH
<b>Shannon Foynes Port Company</b>	✓			✓					✓		✓													
<b>Galway</b>																								
Galway Harbour Company	✓			✓							✓													
<b>Greenore</b>																								
Greenore Port Limited	✓			✓							✓													
<b>Kilrush</b>																								
Kilrush Port Authority				✓																				
<b>Kinsale</b>																								
Henry Good Limited				✓																				
<b>Kinsale</b>																								
Kinsale Harbour Commissioners				✓	✓						✓													
<b>New Ross</b>																								
New Ross Port Company	✓		✓	✓	✓	✓	✓	✓			✓									✓	✓	✓		✓
<b>Tralee</b>																								
Fenit Port Authority	✓																							
<b>Turvey</b>																								
Moneyport	✓																							
<b>Waterford</b>																								
Port of Waterford Company	✓			✓	✓	✓	✓				✓	✓	✓		✓				✓	✓	✓	✓		✓
<b>Wicklow</b>																								
Wicklow Port Co																					✓	✓	✓	✓
<b>ISRAEL</b>																								
<b>Ashdod</b>																								
Ashdod Port Co. Ltd	✓			✓							✓													
<b>Ashkelon</b>																								
The National Coal Supply Corporation (N.C.S.C)	✓																							
<b>Eilat</b>																								
Eilat Port Ltd - Israel											✓													
<b>Hadera</b>																								
Port of Hadera	✓																							
<b>Hadera</b>																								
The National Coal Supply Corporation Ltd (NCSC)	✓																							
<b>Haifa</b>																								
Haifa Grain Terminal				✓																				
<b>Haifa</b>																								
Haifa Port Company Ltd	✓			✓																				
<b>Tel Aviv</b>																								
Israel Ports Company																								✓
<b>Tel Aviv</b>																								
Ports & Railways Authority																								
<b>Tel Aviv</b>																								
Ports and Railways Authority of Israel																								
<b>ITALY</b>																								
<b>Ancona</b>																								
Ancona Coal Terminal	✓																							
<b>Ancona</b>																								
Ancona Port Authority				✓		✓		✓			✓													✓
<b>Barlette</b>																								
Barletta Port Authority	✓			✓																				✓
<b>Cagliari</b>																								
Port of Cagliari	✓			✓																				✓
<b>Chioggia</b>																								
Chioggia Port Authority																								✓
<b>Civitavecchia</b>																								
Civitavecchia Port Authority	✓		✓	✓							✓												✓	✓
<b>Crotone</b>																								
Crotone Port Authority				✓																				✓
<b>Gaeta &amp; Civitavecchia</b>																								
Intergroup S.r.l.	✓		✓	✓		✓	✓	✓	✓	✓	✓	✓	✓	✓		✓	✓	✓	✓	✓	✓	✓	✓	✓
<b>Gela</b>																								
Gela Port Authority											✓													
<b>Genova</b>																								
Port of Genova				✓																				
<b>Genova</b>																								
Terminal Rinfuse Genova SpA	✓			✓				✓	✓		✓		✓									✓		✓
<b>La Spezia</b>																								
La Spezia Port Authority	✓			✓							✓													
<b>Livorno</b>																								
Livorno Port Authority	✓			✓		✓		✓	✓	✓	✓				✓		✓	✓		✓		✓		

# COMMODITIES HANDLED

COMMODITIES	CL	CC	PC	G-A	AF	CM	CLK	IO	BX	AL	FR	G-FGD	AG	SU	SOY	SODA	MIN	CHEM	BC	FRS	STL	P&P	MB	OTH
<b>Manfredonia</b>																								
Manfredonia Port Authority				✓							✓		✓											✓
<b>Palermo</b>																								
Palermo Port Authority	✓			✓				✓																✓
<b>Piazzale Cabato</b>																								
Gaeta Port Authority				✓		✓					✓		✓										✓	✓
<b>Piombino</b>																								
TOP - Terminal Offshore Piombino	✓							✓														✓		
<b>Piombino (LI)</b>																								
Autorità Portuale di Piombino	✓							✓	✓													✓	✓	✓
<b>Porto Torres</b>																								
Porto Torres Port Authority											✓													✓
<b>Ravenna</b>																								
Ravenna Port Authority	✓	✓	✓	✓	✓	✓	✓	✓			✓			✓	✓	✓	✓	✓			✓	✓		
<b>Sant'Antioco</b>																								
Sant'Antioco Port Authority	✓																							
<b>Savona</b>																								
Autorità Portuale di Savona				✓																				
<b>Savona</b>																								
Port Authority of Savona	✓		✓	✓		✓	✓				✓				✓	✓					✓	✓	✓	✓
<b>Sicily</b>																								
Siracusa Port Authority				✓																				
<b>Torre Annunziata (NA)</b>																								
SOLACEM Spa				✓	✓	✓				✓	✓			✓	✓				✓	✓	✓	✓	✓	✓
<b>Trieste</b>																								
Port of Trieste				✓				✓	✓												✓			
<b>Trieste</b>																								
Trieste Port, Pier 7																								
<b>Vado Ligure (SV)</b>																								
Terminal Rinfuse Vado	✓																							
<b>Venezia</b>																								
T.M.B SRL Venezia				✓																				
<b>Venice</b>																								
Port Authority of Venice																						✓		
<b>Venice</b>																								
Port of Venice Marghera	✓			✓																				
<b>IVORY COAST</b>																								
<b>Abidjan</b>																								
Port Autonome d'Abidjan									✓		✓													
<b>JAMAICA</b>																								
<b>Kingston</b>																								
Kingston Port Authority				✓		✓						✓												
<b>Kingston</b>																								
Port Authority of Jamaica																								
<b>Kingston</b>																								
Port Kaiser									✓															
<b>Kingston</b>																								
Port of Port Rhoades									✓															
<b>Saint Ann's Bay</b>																								
Ocho Rios Port									✓					✓										
<b>St Catherine</b>																								
Port Esquivel				✓	✓	✓				✓	✓		✓		✓	✓		✓	✓		✓			✓
<b>St Catherine</b>																								
West Indies Alumina Company				✓	✓	✓				✓	✓		✓		✓	✓		✓			✓			✓
<b>JAPAN</b>																								
<b>Akigun</b>																								
Port of Mitsukojima																								✓
<b>Akita City</b>																								
Port of Akita				✓		✓		✓	✓		✓	✓	✓								✓		✓	✓
<b>Anan City</b>																								
Port of Anan											✓													✓
<b>Aomori</b>																								
Port of Aomori																							✓	✓
<b>Aomori</b>																								
Port of Hachinohe	✓			✓		✓		✓													✓			
<b>Chiba City</b>																								
Chiba Port				✓		✓		✓						✓				✓			✓			
<b>Chiba-city</b>																								
Kisarazu Port	✓		✓					✓	✓				✓									✓	✓	✓
<b>Chiyoda-ku</b>																								
Idemitsu Bulk Terminal-Chiba	✓																							



COMMODITIES	CL	CC	PC	G-A	AF	CM	CLK	IO	BX	AL	FR	G-FGD	AG	SU	SOY	SODA	MIN	CHEM	BC	FRS	STL	P&P	MB	OTH
<b>Fukuoko City</b>																								
Hakata Port & Harbour Bureau				✓										✓										
<b>Hakodate</b>																								
Hakodate Port and Airport Department	✓			✓	✓	✓	✓				✓	✓	✓	✓				✓	✓	✓	✓		✓	✓
<b>Handa City</b>																								
Port of Kinuura				✓										✓									✓	✓
<b>Hiroshima</b>																								
Fukuyama Port Authority	✓							✓															✓	✓
<b>Hiroshima</b>																								
Hiroshima Port Authority	✓			✓																				
<b>Hiroshima</b>																								
Kure Port Authority	✓							✓	✓															
<b>Hiroshima</b>																								
Port of Takehara No 1P/S	✓																							
<b>Hokkaido</b>																								
Tomato Coal Center	✓																							
<b>Ibaraki</b>																								
Hitachi Port Authority	✓																							✓
<b>Iymishima City</b>																								
Port of Mishima-Kawanoe	✓			✓																				
<b>Kagoshima City</b>																								
Pacific Grain Terminal				✓																				
<b>Kagoshima City</b>																								
Port of Kagoshima				✓																				✓
<b>Kakogawa City</b>																								
Higashi-Harima Port Authority	✓							✓	✓												✓		✓	
<b>Kamisui-City</b>																								
Kanto Grain Terminal Co. Ltd				✓																				
<b>Kanda-Machi</b>																								
Kanda Port						✓																		✓
<b>Kasaoka City</b>																								
Kasaoka Port																						✓	✓	✓
<b>Kawasaki City</b>																								
Port of Kawasaki	✓			✓				✓	✓													✓		✓
<b>Kitakyushu City</b>																								
Kitakyushu Port & Harbour Authority	✓							✓														✓		
<b>Kitakyushu City</b>																								
Port of Hibikinade												✓												
<b>Kitakyushu City</b>																								
Port of Kokura	✓							✓																
<b>Kitakyushu City</b>																								
Port of Yawata																						✓		✓
<b>Kitakyushu City</b>																								
Yawata Hibikinada	✓					✓																		
<b>Kobe</b>																								
Port Authority of Himeji																								✓
<b>Kobe</b>																								
Port of Kobe	✓	✓	✓	✓	✓	✓	✓	✓	✓	✓	✓	✓	✓	✓	✓	✓	✓	✓	✓	✓	✓	✓	✓	✓
<b>Kochi City</b>																								
Port of Kochi	✓																							✓
<b>Komatsushima City</b>																								
Port of Tokushima Komatsushima						✓																		
<b>Kurashiki City</b>																								
Mizushima Port Authority	✓			✓				✓															✓	✓
<b>Kushiro City</b>																								
Kushiro Port Authority	✓			✓		✓															✓			
<b>Maizuru City</b>																								
Maizuru Port Authority																								✓
<b>Marugame City</b>																								
Port of Marugame				✓																				
<b>Minatoku</b>																								
Niihama Coal Centre	✓																							
<b>Moji-ku Kitakyushu City</b>																								
Moji Port Authority	✓			✓		✓		✓				✓											✓	
<b>Moji-ku Kitakyushu City</b>																								
Port of Tobata	✓							✓	✓															
<b>Morioka</b>																								
Port of Kamaishi	✓		✓					✓																
<b>Morioka</b>																								
Port of Ofunato	✓		✓			✓		✓				✓												✓
<b>Mubanti</b>																								

# COMMODITIES HANDLED

COMMODITIES	CL	CC	PC	G-A	AF	CM	CLK	IO	BX	AL	FR	G-FGD	AG	SU	SOY	SODA	MIN	CHEM	BC	FRS	STL	P&P	MB	OTH	
Shukuzu Coal Centre	✓																								
<b>Muroran City</b>																									
Muroran Port Authority	✓							✓	✓												✓				
<b>Nagasaki City</b>																									
Port of Matsushima																								✓	
<b>Nagoya</b>																									
Gamagori Port Authority																								✓	
<b>Niigata City</b>																									
Port of Niigata	✓																								
<b>Niihama City</b>																									
Port of Niihama	✓								✓															✓	
<b>Oita City</b>																									
Port of Oita	✓							✓																	
<b>Osaka City</b>																									
Port of Osaka	✓		✓	✓		✓		✓															✓	✓	
<b>Otaru City</b>																									
Port of Otaru				✓		✓		✓	✓																
<b>Sakaide City</b>																									
Sakaide Port Administration				✓																					
<b>Sakaide City</b>																									
Sakaide Port Administration	✓		✓	✓					✓																
<b>Sasebo City</b>																									
Port of Sasebo				✓																					
<b>Schimonoseki City</b>																									
Shimonoseki Port & Harbour Bureau				✓							✓										✓	✓			
<b>Sendai</b>																									
Port of Ishinomaki	✓			✓							✓														
<b>Shibushi-shi</b>																									
Port of Shibushi				✓		✓																			
<b>Shizuoka City</b>																									
Port Authority of Shimizu	✓		✓	✓	✓	✓		✓	✓	✓	✓			✓	✓	✓		✓		✓	✓	✓	✓	✓	
<b>Shizuoka City</b>																									
Port of Tagonoura				✓																	✓				
<b>Takamtsu City</b>																									
Naoshima Port Authority								✓																	
<b>Tokuyama City</b>																									
Tokuyama Port Authority						✓		✓	✓		✓														
<b>Tokuyama City</b>																									
Tonda Port Authority																								✓	
<b>Tokyo</b>																									
Tokyo Metropolitan Government	✓			✓		✓															✓	✓	✓	✓	
<b>Tomakomai City</b>																									
Tomakomai Port Authority	✓			✓		✓			✓		✓													✓	
<b>Toyama City</b>																									
Toyama Port Authority						✓																			
<b>Toyama City</b>																									
Toyama-Shinko Public Berths	✓																								
<b>Tsuruga City</b>																									
Tsuruga Port Authority	✓					✓					✓		✓												
<b>Ube City</b>																									
Port of Ube, Okinoyama																									
Coal Terminal	✓																								
<b>Usui City</b>																									
Tsukumi Port Authority	✓					✓																		✓	
<b>Wakayama City</b>																									
Smikin Transport Service	✓																								
<b>Wakayama City</b>																									
Wakayama Port Authority	✓							✓																	
<b>Yatsushiro City</b>																									
Yatsushiro Port Office																								✓	
<b>Yokohama</b>																									
Port of Yokohama	✓			✓		✓		✓	✓					✓										✓	
<b>JERSEY</b>																									
<b>St Hellier</b>																									
Induvac						✓																			
<b>JORDAN</b>																									
<b>Aqaba</b>																									
The Ports Corporation Aqaba				✓		✓					✓														
<b>KENYA</b>																									
<b>Mombasa</b>																									
Grain Bulk Handlers Ltd				✓																					



COMMODITIES	CL	CC	PC	G-A	AF	CM	CLK	IO	BX	AL	FR	G-FGD	AG	SU	SOY	SODA	MIN	CHEM	BC	FRS	STL	P&P	MB	OTH	
<b>Mombasa</b>																									
Kenya Ports Authority	✓			✓	✓	✓	✓	✓	✓		✓	✓	✓	✓							✓	✓	✓	✓	
<b>Mombasa</b>																									
Port of Mombasa	✓			✓		✓					✓			✓											
<b>KIRIBATI</b>																									
<b>Betio</b>																									
Kiribati Ports Authority											✓														
<b>KOREA</b>																									
<b>Gwang Yang-City</b>																									
Posco Terminal Co., Ltd	✓																								
<b>KUWAIT</b>																									
<b>Safat</b>																									
Shuaiba Port			✓			✓		✓			✓														✓
<b>Safat</b>																									
Shuwaikh Port				✓		✓																			
<b>LATVIA</b>																									
<b>Liepaja</b>																									
Liepaja Port Authority													✓												
<b>Liepaja</b>																									
Liepaja Special Economic Zone Authority SEZ				✓																					
<b>Riga</b>																									
Freeport of Riga Authority	✓			✓							✓			✓							✓			✓	
<b>Riga</b>																									
Riga Central Terminal, LLC	✓	✓	✓	✓	✓			✓			✓			✓	✓				✓		✓	✓	✓	✓	✓
<b>Riga</b>																									
WT Terminal Ltd											✓		✓			✓				✓	✓	✓	✓	✓	✓
<b>Ventspils</b>																									
AS Ventspils Tirdzniecibas Osta	✓																								
<b>Ventspils</b>																									
Free Port of Ventspils Authority	✓			✓				✓			✓			✓							✓	✓		✓	✓
<b>Ventspils</b>																									
JSC BALTIC COAL TERMINAL	✓																								
<b>Ventspils</b>																									
Kalija Parks											✓														
<b>Ventspils</b>																									
Ventspils Grain Terminal				✓																					
<b>LEBANON</b>																									
<b>Beirut</b>																									
Chekaa Bay						✓																			
<b>Beirut</b>																									
Port Authority of Selaata				✓																					
<b>Tripoli</b>																									
Tripoli Port Authority				✓																					
<b>LIBERIA</b>																									
<b>Monrovia</b>																									
Monrovia Port								✓																	
<b>Monrovia</b>																									
National Port Authority																									
<b>Robertsonfield</b>																									
Buchanan Port Authority								✓																	
<b>LITHUANIA</b>																									
<b>Klaipeda</b>																									
BEGA, Stevedoring Company				✓	✓	✓	✓			✓	✓		✓	✓	✓	✓	✓		✓	✓		✓	✓	✓	✓
<b>Klaipeda</b>																									
Joint-Stock Stevedoring Company				✓																					✓
<b>Klaipeda</b>																									
Klaipeda Stevedoring Company (KLASCO)				✓	✓		✓	✓	✓		✓	✓	✓	✓	✓						✓	✓	✓	✓	✓
<b>Klaipeda</b>																									
State Enterprise Klaip da State Seaport Authority				✓	✓	✓	✓	✓			✓			✓	✓	✓	✓	✓			✓	✓	✓	✓	✓
<b>Klaipeda</b>																									
Vakaru krova, UAB																					✓				
<b>LUXEMBOURG</b>																									
<b>Luxembourg</b>																									
Euroports Holdings S.a.r.l.	✓	✓	✓	✓		✓	✓	✓																	

# COMMODITIES HANDLED

COMMODITIES	CL	CC	PC	G-A	AF	CM	CLK	IO	BX	AL	FR	G-FGD	AG	SU	SOY	SODA	MIN	CHEM	BC	FRS	STL	P&P	MB	OTH
<b>MADAGASCAR</b>																								
<b>Toamasina</b>																								
Societe d'Exploitation du Port de Toamasina																								
<b>MALAYSIA</b>																								
<b>Butterworth</b>																								
Penang Port SDN BHD																								
<b>Johor</b>																								
Bulk & Breakbulk Terminal																								
<b>Johor Baharu</b>																								
Johor Port BERHAD																								
<b>Kota Kinabalu</b>																								
Sabah Ports Authority																								
<b>Kuantan</b>																								
Kuantan Port Authority																								
<b>Kuantan</b>																								
Kuantan Port Consortium Sdn Bhd																								
<b>Kuantan</b>																								
Lembaga Pelabuhan Kuantan																								
<b>Labuan</b>																								
Labuan Port Authority																								
<b>Malacca</b>																								
Malacca Port Authority																								
<b>Miri</b>																								
Miri Port Authority																								
<b>Penang</b>																								
Penang Port SDN BHD																								
<b>Penang</b>																								
Penang Port Sdn Bhd (PPSB)																								
<b>Penang</b>																								
Prai Bulk Cargo Terminal																								
<b>Port Kelang</b>																								
West Fertilizer Terminal Sdn Bhd																								
<b>Port Klang</b>																								
Northport (Malaysia) Bhd.																								
<b>Port Klang</b>																								
Port Klang Authority																								
<b>Pulau Indah</b>																								
Westports Malaysia Sdn Bhd																								
<b>Sandakan</b>																								
Sandakan Port Authority																								
<b>Seri Manjung</b>																								
Lumut Maritime Terminal Sdn Bhd																								
<b>Sibu</b>																								
Rajang Port Authority																								
<b>Terengganu Darul Iman</b>																								
Kemaman Port Authority																								
<b>Utara</b>																								
Kelang Port Management																								
<b>MALTA</b>																								
<b>Marsa</b>																								
Port of Valletta																								
<b>Marsa</b>																								
Transport Malta																								
<b>Paola</b>																								
Kordin Grain Terminal Company Ltd																								
<b>MAURITANIA</b>																								
<b>Nouadhibou</b>																								
Port Autonome de Nouadhibou																								
<b>MAURITIUS</b>																								
<b>Port Louis</b>																								
Mauritius Ports Authority																								
<b>MEXICO</b>																								
<b>Acapulco</b>																								
Port Authority of Acapulco																								
<b>Altamira</b>																								
Cooper/T. Smith De																								
Mexico SA de CV																								
<b>Altamira</b>																								



COMMODITIES	CL	CC	PC	G-A	AF	CM	CLK	IO	BX	AL	FR	G-FGD	AG	SU	SOY	SODA	MIN	CHEM	BC	FRS	STL	P&P	MB	OTH		
Industrial Port of Altamira				✓													✓				✓					
<b>Altamira</b>																										
Terminal Maritima de Altamira, SA de CV				✓													✓									
<b>Chiapas</b>																										
Port Authority of Puerto Madero																								✓		
<b>Ensenada</b>																										
Port Authority of Ensenada						✓															✓					
<b>Garita de Otay</b>																										
Morro Redondo Port Authority																								✓		
<b>Guaymas</b>																										
Port Authority of Guaymas																								✓		
<b>La Paz</b>																										
San Juan de la Costa Port Authority											✓															
<b>Lazaro Cardenas</b>																										
Terminales Portuarias Del Pacifico, S A P I de C V	✓	✓	✓					✓									✓									
<b>Mazatlan</b>																										
Port Authority of Mazatlan				✓																				✓		
<b>Salina Cruz</b>																										
Port Authority of Salina Cruz				✓		✓																				
<b>San Carlos</b>																										
San Carlos Port Authority				✓																						
<b>Tampico</b>																										
Port Authority of Tampico	✓			✓		✓						✓														
<b>Topolobampo</b>																										
Topolobampo Port Authority						✓					✓															
<b>Veracruz</b>																										
Port Authority of Veracruz				✓		✓			✓		✓			✓												
<b>MOROCCO</b>																										
<b>Casablanca</b>																										
Office d'Exploitation des Ports																										
<b>Casablanca</b>																										
Port Nador				✓																						
<b>El Jadida</b>																										
Agence Nationale Des Ports	✓			✓		✓					✓															
<b>El Jadida</b>																										
Jorf Lasfar Power Station	✓										✓															
<b>Kenitra</b>																										
Port of Kenitra				✓																						
<b>Tangier</b>																										
Port of Tangier				✓																						
<b>MOZAMBIQUE</b>																										
<b>Beira</b>																										
Cornelder de Moçambique, s.a.r.l																										
<b>Beira</b>																										
Largo dos CFM-C	✓							✓																		
<b>Maputo</b>																										
Grindrod Terminals - Maputo	✓							✓																		
<b>Maputo</b>																										
Maputo Port Development Company SARL	✓		✓	✓		✓	✓	✓		✓	✓	✓		✓	✓	✓	✓		✓	✓	✓	✓	✓	✓	✓	
<b>Maputo</b>																										
Mozambique Ports and Railways - CFM	✓			✓				✓						✓								✓			✓	
<b>Maputo</b>																										
Portos e Caminhos De Ferro de Mozambique				✓				✓						✓												
<b>Matola</b>																										
Stema SA				✓	✓										✓											
<b>Nacala</b>																										
Nacala Port Authority				✓							✓															
<b>MYANMAR</b>																										
<b>Yangon</b>																										
Yangon Port Authority	✓			✓																						
<b>NAMIBIA</b>																										
<b>Walvis Bay</b>																										
Grindrod Terminals - Walvis Bay																									✓	
<b>Walvis Bay</b>																										
Namibian Ports Authority	✓			✓				✓	✓								✓						✓		✓	

# COMMODITIES HANDLED

COMMODITIES	CL	CC	PC	G-A	AF	CM	CLK	IO	BX	AL	FR	G-FGD	AG	SU	SOY	SODA	MIN	CHEM	BC	FRS	STL	P&P	MB	OTH
<b>Walvis Bay</b>																								
Namport																								
<b>NAURU</b>																								
<b>Aiwo</b>																								
Nauru Port Authority											✓													
<b>NETHERLANDS ANTILLES</b>																								
<b>Bonaire</b>																								
Bonaire Pilots				✓																				✓
<b>NEW CALEDONIA</b>																								
<b>Houailou</b>																								
Societe des Mines du Cap Bocage																								✓
<b>Noumea</b>																								
Port Authority of New Caledonia	✓			✓				✓				✓												✓
<b>NEW ZEALAND</b>																								
<b>Auckland</b>																								
NZ Stevedoring Co Ltd																								
<b>Auckland</b>																								
Onehunga Port Authority																								✓
<b>Auckland</b>																								
Ports of Auckland Limited	✓			✓	✓	✓						✓	✓	✓	✓	✓				✓	✓	✓	✓	✓
<b>Bluff</b>																								
South Port NZ Ltd	✓	✓	✓	✓	✓	✓				✓	✓										✓			✓
<b>Lyttelton</b>																								
Lyttelton Coal Terminal	✓																							
<b>Mount Maunganui</b>																								
NZL Group Limited t/a NZ Marshalling & Stevedoring																								
<b>Napier</b>																								
Port of Napier Ltd						✓					✓									✓	✓	✓	✓	
<b>New Plymouth</b>																								
Port Taranaki Limited	✓			✓	✓	✓					✓				✓						✓			
<b>Port Chalmers</b>																								
Port Otago Ltd						✓					✓										✓			
<b>Ruakaka</b>																								
North Port Ltd	✓			✓	✓	✓					✓	✓	✓							✓	✓	✓	✓	✓
<b>Tauranga</b>																								
C3 Limited (previously Toll Owens Ltd)	✓			✓	✓						✓	✓								✓	✓	✓	✓	✓
<b>Tauranga</b>																								
Port of Tauranga Ltd	✓	✓		✓	✓	✓	✓				✓	✓		✓	✓	✓			✓	✓	✓	✓	✓	✓
<b>Timaru</b>																								
PrimePort Timaru				✓							✓			✓										
<b>Wanganui</b>																								
Wanganui Port Authority				✓							✓		✓								✓			✓
<b>Wellington</b>																								
Port of Wellington				✓							✓		✓											
<b>Westport</b>																								
Westport Harbour	✓					✓	✓				✓	✓								✓				
<b>NICARAGUA</b>																								
<b>Managua</b>																								
Empresa Portuaria Nacional (EPN)																								
<b>Sandino</b>																								
Port Sandino											✓													
<b>NIGERIA</b>																								
<b>Lagos</b>																								
Lagos/Apapa	✓			✓							✓													✓
<b>Lagos</b>																								
Nigerian Ports Authority Plc	✓					✓					✓													
<b>Port Harcourt</b>																								
Nigerian Ports Plc																								
<b>Port Harcourt</b>																								
Port Harcourt	✓																							
<b>NORWAY</b>																								
<b>Brevik</b>																								
Grenland Port Authority	✓																							
<b>Drummen</b>																								
Port Authority of Drammen				✓																				
<b>Farsund</b>																								



COMMODITIES	CL	CC	PC	G-A	AF	CM	CLK	IO	BX	AL	FR	G-FGD	AG	SU	SOY	SODA	MIN	CHEM	BC	FRS	STL	P&P	MB	OTH
<b>Elkem Aluminium Lista</b>									✓															
<b>Floro</b>																								
Port Authority of Floro																								
<b>Glomfjord</b>																								
Port Authority of Glomfjord											✓													
<b>Husnes</b>																								
Aluminium Works Terminal									✓															
<b>Kirkenes</b>																								
Port of Kirkenes								✓																
<b>Kristiansund</b>																								
Kristiansund and Nordmøre																								
Port Authority																								✓
<b>Larvik</b>																								
Larvik Port Authority								✓																✓
<b>Mo I Rana</b>																								
Mo I Rana Port Authority	✓		✓					✓	✓															✓
<b>Mosjoen</b>																								
Mosjoen Port Authority									✓															
<b>Moss</b>																								
Port Authority of Moss				✓																				
<b>Narvik</b>																								
LKAB								✓									✓							
<b>Narvik</b>																								
Narvik Port Authority								✓																✓
<b>Orkanger</b>																								
Port of Orkanger								✓																✓
<b>Ovre</b>																								
Aardalstangen			✓							✓														
<b>Sauda</b>																								
Sauda Port Authority								✓	✓															
<b>Sentrum</b>																								
Oslo Port Authority				✓		✓					✓			✓			✓				✓			
<b>Stavanger</b>																								
Port Authority of Stavanger				✓																				✓
<b>Stavanger</b>																								
Stavanger Havneseilo				✓																				
<b>Sunnalsora</b>																								
Hydro Aluminium Private Terminal									✓															
<b>Sunnalsora</b>																								
Hydro Aluminium Sunndal A/S			✓							✓														
<b>Svolvaer</b>																								
Vagan																								✓
<b>OMAN</b>																								
<b>Muscat</b>																								
Port Sultan Qaboos			✓	✓		✓	✓				✓			✓		✓			✓	✓	✓	✓	✓	✓
<b>PAKISTAN</b>																								
<b>Karachi</b>																								
Bulk Trade International																								
<b>Karachi</b>																								
Pak Shaheen Group	✓	✓	✓	✓				✓			✓													
<b>Karachi</b>																								
Port Muhammad Bin Qasim	✓			✓		✓	✓	✓			✓			✓										
<b>PAPUA NEW GUINEA</b>																								
<b>Alotau</b>																								
Alotau Port Authority																								✓
<b>Kavieng</b>																								
Kavieng Port Authority																								✓
<b>Kimbe</b>																								
Kieta Port Authority																								✓
<b>Kimbe</b>																								
Kimbe Port Authority																								✓
<b>Lae</b>																								
Lae Port Authority																								✓
<b>Lae</b>																								
PNG Ports Corporation Limited				✓	✓	✓	✓				✓		✓	✓						✓	✓	✓	✓	✓
<b>Popondetta</b>																								
Oro Bay Port Authority																								✓
<b>Rabaul</b>																								
Rabaul Port Authority																								✓
<b>PERU</b>																								

# COMMODITIES HANDLED

COMMODITIES	CL	CC	PC	G-A	AF	CM	CLK	IO	BX	AL	FR	G-FGD	AG	SU	SOY	SODA	MIN	CHEM	BC	FRS	STL	P&P	MB	OTH
<b>Arequipa</b>																								
Terminal Internacional del Sur SA																								
<b>Callao</b>																								
Conchan Port Authority						✓																		
<b>Callao</b>																								
ENAPU SA	✓																							
<b>Chancy</b>																								
Chancay Port Authority																								✓
<b>Ilo</b>																								
Agencia Maritima Busonich																								✓
<b>Iquitos</b>																								
Iquitos Port Authority				✓																				
<b>La Caleta</b>																								
Port Authority of Chimbote	✓		✓	✓				✓	✓		✓													✓
<b>La Perla</b>																								
Autoridad Portuaria Nacional																								
<b>Moquegua</b>																								
ILO Port Terminal	✓																							
<b>Pisco</b>																								
General San Martin Port Authority				✓							✓													
<b>Supé Puerto</b>																								
Supé Port Authority				✓																				
<b>Trujillo</b>																								
ENAPU SA	✓																							
<b>PHILIPPINES</b>																								
<b>Batangas City</b>																								
Batangas Port Authority	✓																							✓
<b>Cagayan de Oro City</b>																								
Masao Port Authority				✓							✓			✓										✓
<b>Cagayan de Oro City</b>																								
Philippine Ports Authority				✓							✓			✓								✓		✓
<b>Cebu City</b>																								
Cebu Port Authority																								✓
<b>Iligan City</b>																								
Iligan Port Authority																								✓
<b>Iloilo City</b>																								
Iloilo Port Management Office																								✓
<b>Jolo Sulu</b>																								
Jolo Port Authority				✓																				
<b>La Union</b>																								
San Fernando Port Authority																								✓
<b>Legazpi City</b>																								
Lagazpi Port Management Authority				✓																				
<b>Makati City</b>																								
Mariveles Port-Smithbell & Co				✓																				
<b>Makati City</b>																								
Wilhelmsen-Smith Bell Shipping, Inc.	✓			✓	✓	✓	✓	✓	✓	✓	✓		✓	✓	✓	✓	✓	✓		✓	✓	✓	✓	
<b>Manila</b>																								
Asian Terminals Incorporated				✓																				
<b>Manila</b>																								
Mariveles Grain Terminal (MGT)				✓																				
<b>Manila</b>																								
Philippine Ports Authority											✓													
<b>Tacloban</b>																								
Phillippine Ports Authority				✓	✓						✓			✓	✓							✓	✓	✓
<b>POLAND</b>																								
<b>Gdansk</b>																								
Port of Gdansk Authority SA	✓	✓	✓	✓	✓	✓	✓	✓	✓	✓	✓	✓	✓	✓	✓	✓	✓	✓	✓	✓	✓	✓	✓	✓
<b>Gdansk</b>																								
PPS Port Polnocny Co Ltd	✓																							
<b>Gdynia</b>																								
Baltic Grain Terminal				✓	✓																			
<b>Gdynia</b>																								
Baltic Ports Organization Secretariat																								
<b>Gdynia</b>																								
BTDG - Baltic General Cargo Terminal Gdynia Ltd												✓										✓		
<b>Gdynia</b>																								
Maritime Bulk Terminal Gdynia Ltd	✓	✓	✓	✓	✓		✓	✓	✓	✓	✓		✓	✓	✓				✓			✓	✓	
<b>Gdynia</b>																								
Port of Gdynia	✓	✓						✓	✓		✓													



COMMODITIES	CL	CC	PC	G-A	AF	CM	CLK	IO	BX	AL	FR	G-FGD	AG	SU	SOY	SODA	MIN	CHEM	BC	FRS	STL	P&P	MB	OTH
<b>Gdynia</b>																								
Rudoport SA	✓	✓						✓					✓											
<b>Kolobrzeg</b>																								
Port Authority of Kolobrzeg																								
<b>Police</b>																								
Port Police											✓													✓
<b>Swinoujscie</b>																								
Port Handlowy Swinoujscie Sp. z o.o.	✓	✓	✓	✓	✓	✓	✓	✓	✓	✓	✓	✓	✓	✓	✓	✓	✓	✓	✓	✓	✓	✓	✓	✓
<b>Szczecin</b>																								
Andreas sp. z o.o.				✓																				
<b>Szczecin</b>																								
Bulk Cargo - Port Szczecin Sp. z.o.o.	✓	✓	✓	✓	✓	✓	✓	✓	✓	✓	✓		✓		✓		✓	✓			✓		✓	
<b>Szczecin</b>																								
Przedsiębiorstwo Usług Portowych				✓																				
<b>Szczecin</b>																								
Szczecin and Swinoujscie Seaports Authority	✓	✓	✓	✓	✓	✓	✓		✓	✓	✓	✓	✓	✓	✓	✓	✓	✓	✓	✓	✓	✓	✓	✓
<b>PORTUGAL</b>																								
<b>Aveiro</b>																								
Socarpor (Aveiro) SA				✓		✓	✓				✓						✓			✓	✓	✓	✓	
<b>Barreiro</b>																								
Barreiro Terminal - Atlanport	✓							✓			✓						✓				✓		✓	✓
<b>Funchal</b>																								
Port Authority of Maderia				✓																				
<b>Gafanha da Nazaré</b>																								
APA - Administração do Porto de Aveiro, S.A.				✓		✓					✓										✓			✓
<b>Leca da Palmeira</b>																								
Port Authority of Leixoes				✓						✓											✓	✓		
<b>Lisbon</b>																								
APL - Administration of Port of Lisbon				✓																				
<b>Lisbon</b>																								
Iberol - Sociedade Iberica de Biocombustíveis				✓												✓								✓
<b>Lisbon</b>																								
Lisbon Port Authority	✓			✓		✓		✓	✓		✓													
<b>Lisbon</b>																								
Poço Bispo Multipurpose Terminal - TMPB	✓			✓	✓	✓	✓				✓			✓	✓				✓	✓	✓	✓	✓	✓
<b>Lisbon</b>																								
Silopor - Empresa de Silos Portuários, S.A				✓																				
<b>Lisbon</b>																								
Silopor - Empresa De Silos Portuários, SA				✓	✓											✓								✓
<b>Lisbon</b>																								
Sovena - Oilseeds Portugal, SA				✓	✓											✓								✓
<b>Lisbon</b>																								
TPB - SILOPOR SA										✓				✓					✓	✓	✓	✓	✓	✓
<b>Setubal</b>																								
Junta Autonoma Do Porto De Setubal	✓			✓							✓													
<b>Setubal</b>																								
Sadomar																								
<b>Sines</b>																								
Porto de Sines SA	✓																							
<b>Trafaria</b>																								
Trafaria Terminal - Silopor				✓																				
<b>Vila Franca de Xira</b>																								
Alhandra Terminal- Cimpor Industria de Cimentos SA						✓	✓																	✓
<b>PUERTO RICO</b>																								
<b>San Juan</b>																								
Port of Ponce	✓																							
<b>San Juan</b>																								
Puerto Rico Port Authority				✓																				
<b>QATAR</b>																								
<b>Doha</b>																								
Qatar Flour Mills Co				✓																				
<b>Doha</b>																								

# COMMODITIES HANDLED

COMMODITIES	CL	CC	PC	G-A	AF	CM	CLK	IO	BX	AL	FR	G-FGD	AG	SU	SOY	SODA	MIN	CHEM	BC	FRS	STL	P&P	MB	OTH	
Umm Said Ports Authority				✓		✓		✓			✓													✓	
<b>REPUBLIC OF CONGO</b>																									
<b>Pointe Noire</b>																									
Port Authority of Pointe Noire	✓							✓																	
<b>REPUBLIC OF GUINEA</b>																									
<b>Conakry</b>																									
Conakry Port Authority				✓				✓	✓															✓	
<b>Conakry</b>																									
Direction du Port de Kamsar									✓																
<b>Conakry</b>																									
Port Autonome de Conakry				✓				✓	✓																
<b>REPUBLIC OF YEMEN</b>																									
<b>Hodeidah</b>																									
Hodeidah Port				✓																					
<b>REUNION</b>																									
<b>Le Port Cedex, Reunion</b>																									
Direction Departementale de L'Equipment																									
<b>ROMANIA</b>																									
<b>Agigea</b>																									
Silotrans SRL																									
<b>Braila</b>																									
Braila Port Authority				✓		✓		✓			✓														✓
<b>Constanta</b>																									
Comvex SA	✓	✓	✓				✓	✓	✓		✓						✓								✓
<b>Constanta</b>																									
SC MINMETAL SA Constanta / Romania	✓			✓				✓	✓					✓								✓			
<b>Constanta</b>																									
SC Silotrans Srl																									
<b>Constantza</b>																									
Constantza Port Administration	✓	✓		✓				✓			✓														
<b>Constantza</b>																									
Sicim SA																									
<b>Sulina</b>																									
Sulina Free Zone Administration						✓					✓														✓
<b>RUSSIA</b>																									
<b>Arkangelsk</b>																									
Port of Arkangelsk				✓							✓											✓	✓		
<b>Building 4</b>																									
Management Company EFCO																									
<b>Kaliningrad</b>																									
Transmarine																									
																					✓	✓			
<b>Moscow</b>																									
North Western Management Co., Ltd	✓	✓																							
<b>Murmansk</b>																									
Port of Murmansk Authority	✓							✓	✓		✓														✓
<b>Nakhodka</b>																									
Nakhodka Port Authority	✓			✓		✓		✓	✓		✓													✓	✓
<b>Nakhodka</b>																									
VP- Vostochny Port	✓						✓	✓			✓		✓								✓	✓			
<b>Novorossiysk</b>																									
Novorossiysk Port Authority	✓			✓		✓		✓						✓										✓	
<b>St Petersburg</b>																									
Seaport of St Petersburg JSC				✓	✓					✓	✓				✓	✓			✓	✓	✓	✓	✓	✓	✓
<b>Tuapse</b>																									
Port of Tuapse Authority	✓																								
<b>Ulegorsk</b>																									
Ulegorsk Port Authority																									
																									✓
<b>Vanino</b>																									
Vanino Commercial Sea Port, PJSC	✓																				✓				
<b>Vanino</b>																									
Vanino Port Authority																									
	✓																								
<b>Vladivstok</b>																									
Vladivostok Port Authority	✓			✓		✓		✓			✓			✓											✓
<b>Vyborg</b>																									
Port of Vyborg Authority	✓							✓	✓				✓	✓											✓
<b>SAUDI ARABIA</b>																									



COMMODITIES	CL	CC	PC	G-A	AF	CM	CLK	IO	BX	AL	FR	G-FGD	AG	SU	SOY	SODA	MIN	CHEM	BC	FRS	STL	P&P	MB	OTH
<b>Dammam</b>																								
Arabian Agricultural Services (ARASCO)				✓																				
<b>Dammam</b>																								
King Abdul Aziz Port Authority-Dammam				✓		✓		✓	✓		✓													
<b>Dammam</b>																								
Ras Al Mishab						✓																		
<b>Jeddah</b>																								
AJWA Port Services Co.			✓	✓	✓	✓	✓				✓	✓	✓		✓	✓	✓	✓	✓	✓	✓	✓	✓	✓
<b>Jeddah</b>																								
Jeddah Islamic Port				✓	✓	✓	✓				✓			✓	✓			✓	✓	✓	✓	✓		✓
<b>Jizan</b>																								
Jizan Port Management				✓		✓								✓										
<b>Yanbu</b>																								
Yanbu Commercial Port			✓	✓		✓																		
<b>SENEGAL</b>																								
<b>Dakar</b>																								
Port Autonome de Dakar																								
<b>SEYCHELLES</b>																								
<b>Victoria</b>																								
Seychelles Ports Authority						✓																		
<b>SIERRA LEONE</b>																								
<b>Cline Town</b>																								
Sierra Leone Port Authority				✓					✓															✓
<b>Freetown</b>																								
Pepel								✓																
<b>Freetown</b>																								
Sierra Leone Ports Authority				✓																				
<b>SINGAPORE</b>																								
<b>Jurong</b>																								
Sembawang Terminal																						✓		✓
<b>Singapore</b>																								
Jaldhi Overseas Pte Ltd																								
<b>Singapore</b>																								
Jurong Port Pte Ltd						✓	✓							✓									✓	✓
<b>Singapore</b>																								
LD Ports & Logistics	✓							✓																
<b>Singapore</b>																								
Maritime and Port Authority of Singapore																								
<b>Singapore</b>																								
Offshore Bulk Terminal Pte Ltd	✓							✓																
<b>Singapore</b>																								
Sin Heng Chan (Singapore) Pte Ltd						✓																		
<b>SLOVENIA</b>																								
<b>Koper</b>																								
Luka Koper d.d.,Dry Bulk Cargo Terminal			✓	✓		✓	✓	✓	✓	✓	✓			✓	✓	✓	✓	✓						
<b>SOUTH AFRICA</b>																								
<b>Bishopsgate</b>																								
South African Sugar Association														✓										
<b>Durban</b>																								
Bidfreight Port Operations (Pty) Ltd				✓		✓		✓					✓								✓	✓	✓	✓
<b>Durban</b>																								
Bulk Connections			✓			✓	✓	✓			✓		✓										✓	✓
<b>Durban</b>																								
Grindrod Terminals	✓	✓						✓			✓													✓
<b>Durban</b>																								
Grindrod Terminals - Maydon Wharf											✓								✓					
<b>Durban</b>																								
South African Bulk Terminals LTD				✓	✓						✓			✓	✓	✓	✓	✓					✓	
<b>Durban</b>																								
South African Sugar Association (Pty) Ltd														✓										
<b>Durban</b>																								
Transnet Port Terminals Head Office	✓			✓				✓					✓		✓							✓		✓
<b>East London</b>																								
S A Port Ops East London																								

# COMMODITIES HANDLED

COMMODITIES	CL	CC	PC	G-A	AF	CM	CLK	IO	BX	AL	FR	G-FGD	AG	SU	SOY	SODA	MIN	CHEM	BC	FRS	STL	P&P	MB	OTH
Grain Terminal				✓																				
<b>East London</b>																								
Transnet National Port Authority																								
<b>Johannesburg</b>																								
Anglo Coal	✓																							
<b>Johansberg</b>																								
National Ports Authority of South Africa (NPASA)				✓		✓							✓								✓			✓
<b>Port Elizabeth</b>																								
Portnet Port Elizabeth								✓	✓														✓	✓
<b>Port Elizabeth</b>																								
Transnet Port Terminals				✓											✓						✓	✓	✓	
<b>Richards Bay</b>																								
Port of Richards Bay	✓						✓		✓		✓										✓	✓	✓	✓
<b>Richards Bay</b>																								
Richards Bay Coal Terminal	✓																							
<b>Richards Bay</b>																								
Transnet Port Terminals	✓	✓	✓						✓	✓	✓							✓			✓		✓	✓
<b>Richard's Bay</b>																								
Grindrod Terminals	✓	✓					✓						✓					✓	✓				✓	✓
<b>Saldanha</b>																								
S A Port Ops																								
<b>Saldanha</b>																								
Saldanha Bulk Terminal								✓																
<b>SOUTH KOREA</b>																								
<b>Cheju</b>																								
Cheju Port Authority																								✓
<b>Donghae</b>																								
Mukho Port Authority	✓					✓																		✓
<b>Donghae City</b>																								
Donghae Port Authority	✓					✓			✓			✓												✓
<b>Inchon</b>																								
Korea Silo Company Pier 7				✓																				
<b>Jung-gu</b>																								
Incheon Port Authority	✓			✓																				
<b>Kunsan</b>																								
Changhang Port Authority																								✓
<b>Kunsan</b>																								
Kunsan Port Authority																								✓
<b>Masan-South</b>																								
Masan Port Authority																								✓
<b>Nam Ku</b>																								
Ulsan Port Authority	✓			✓		✓		✓			✓		✓											✓
<b>Pohang</b>																								
Pohang District Maritime & Port Authority	✓							✓																
<b>Pohang</b>																								
Port of Pohang	✓																							
<b>Ulsan</b>																								
Port of Ulsan Public Piers 1&2	✓			✓		✓		✓			✓		✓											
<b>Yosu</b>																								
Samil Port Authority											✓													
<b>Yosu</b>																								
Yoesu Port Authority	✓			✓							✓													
<b>SPAIN</b>																								
<b>Alcudia</b>																								
Port of Alcudia	✓					✓	✓																	
<b>Algeciras</b>																								
Port Authority of La Bahia de Algeciras	✓					✓																✓	✓	
<b>Alicante</b>																								
Port of Alicante	✓					✓		✓																
<b>Almeria</b>																								
Carboneras	✓		✓			✓		✓																✓
<b>Almeria</b>																								
Port of Almeria	✓																							
<b>Asturias</b>																								
Port Authority of Aviles	✓			✓				✓	✓		✓												✓	✓
<b>Barcelona</b>																								
Cemex España																								
<b>Barcelona</b>																								



COMMODITIES	CL	CC	PC	G-A	AF	CM	CLK	IO	BX	AL	FR	G-FGD	AG	SU	SOY	SODA	MIN	CHEM	BC	FRS	STL	P&P	MB	OTH	
<b>Egransa</b>				✓																					
<b>Barcelona</b>																									
Egransa Terminal				✓																					
<b>Barcelona</b>																									
Moyresa Molturacion y Refino SA				✓																					
<b>Barcelona</b>																									
Port of Barcelona	✓		✓	✓		✓	✓	✓	✓		✓			✓	✓		✓	✓			✓	✓	✓	✓	✓
<b>Barcelona</b>																									
Portcemen, SA						✓																			
<b>Barcelona</b>																									
Tramer SA											✓														
<b>Bilbao</b>																									
Autoridad Portuaria De Bilbao	✓		✓	✓	✓	✓	✓	✓	✓		✓				✓		✓	✓			✓	✓	✓	✓	✓
<b>Cadiz</b>																									
Cadiz Bay Port Authority	✓			✓		✓	✓				✓		✓	✓											✓
<b>Cartagena</b>																									
Port Authority of Cartagena	✓		✓	✓	✓	✓	✓	✓			✓	✓	✓		✓	✓	✓	✓			✓	✓	✓	✓	✓
<b>Cartagena</b>																									
Port of Aguilas				✓		✓																			
<b>Ferrol</b>																									
Port Authority of Ferrol –																									
San Cibrao	✓					✓	✓	✓	✓	✓			✓				✓				✓	✓	✓	✓	✓
<b>Ferrol</b>																									
Port Authority of Ferrol-San Ciprian	✓			✓							✓										✓			✓	
<b>Formentera</b>																									
Port of La Savina																									
<b>Garrucha</b>																									
Garrucha		✓										✓	✓												
<b>Gijón</b>																									
EBHI - European Bulk																									
Handling Installation	✓	✓	✓					✓									✓								
<b>Gijón</b>																									
Port Authority of Gijon	✓	✓	✓	✓		✓	✓	✓			✓										✓	✓	✓	✓	
<b>Huelva</b>																									
Port Authority of Huelva	✓										✓														✓
<b>Ibiza</b>																									
Port of Ibiza																									
<b>La Coruña</b>																									
Muelle del Centenario	✓																								
<b>La Coruña</b>																									
Port Authority of La Coruña	✓			✓	✓	✓	✓			✓					✓							✓		✓	✓
<b>La Coruña</b>																									
T.M.G.A. SL	✓			✓							✓				✓						✓	✓			
<b>La Coruña</b>																									
Terminales Maritimos de Galicia, S.L.	✓	✓	✓	✓	✓	✓	✓	✓	✓	✓	✓	✓	✓	✓	✓	✓	✓	✓			✓	✓	✓	✓	
<b>Los Barrios</b>																									
Endesa	✓							✓	✓																
<b>Madrid</b>																									
Ership S.A.U				✓																					
<b>Madrid</b>																									
Puertos del Estado																									
<b>Mahon</b>																									
Port of Mahon						✓																			
<b>Malaga</b>																									
Malaga Port Authority	✓	✓		✓		✓	✓				✓						✓				✓				✓
<b>Marin</b>																									
Ceferino Nogueira SA				✓																					
<b>Melilla</b>																									
Port Authority of Melilla						✓		✓	✓																
<b>Motril</b>																									
Motril Port - Granada																									
<b>Motril</b>																									
Port of Motril	✓			✓		✓	✓				✓						✓	✓	✓	✓	✓	✓	✓	✓	✓
<b>Palma</b>																									
Port of Palma				✓		✓					✓														✓
<b>Pasaia</b>																									
Port Authority of Pasaia	✓		✓	✓		✓		✓		✓	✓											✓	✓		✓
<b>Pto. Alcudia</b>																									
Transportes Maritimos Alcudia, SA	✓																								
<b>Sagunto</b>																									
Port of Sagunto	✓					✓					✓														
<b>Santa Cruz de Tenerife</b>																									

# COMMODITIES HANDLED

COMMODITIES	CL	CC	PC	G-A	AF	CM	CLK	IO	BX	AL	FR	G-FGD	AG	SU	SOY	SODA	MIN	CHEM	BC	FRS	STL	P&P	MB	OTH
Port Authority of Tenerife				✓		✓					✓													✓
<b>Santander</b>																								
Port Authority of Santander	✓			✓	✓	✓	✓	✓			✓			✓	✓		✓				✓	✓	✓	✓
<b>Santander</b>																								
Puerto de Santander	✓	✓	✓	✓	✓	✓		✓		✓	✓		✓	✓	✓	✓	✓	✓	✓	✓	✓	✓	✓	✓
<b>Sevilla</b>																								
Port Authority of Sevilla	✓			✓																				
<b>Tarragona</b>																								
Berge Maritima				✓																				
<b>Tarragona</b>																								
Codemar-Iberbulk				✓																				✓
<b>Tarragona</b>																								
Euroports Iberica TPS	✓		✓	✓	✓		✓				✓	✓			✓	✓	✓	✓	✓	✓	✓	✓	✓	✓
<b>Tarragona</b>																								
Port Authority of Tarragona	✓		✓	✓	✓	✓	✓				✓				✓						✓	✓	✓	✓
<b>Tarragona</b>																								
Silos de Tarragona SA (SITASA)				✓																				
<b>Torre Vieja</b>																								
Torre Vieja Port Authority						✓																		✓
<b>Valencia</b>																								
Inst Portuarios de Estudios																								
<b>Valencia</b>																								
Port Authority of Valencia	✓	✓	✓	✓	✓	✓	✓				✓		✓		✓		✓	✓	✓	✓	✓	✓	✓	✓
<b>Vigo</b>																								
Port Authority of Vigo				✓		✓		✓	✓		✓													
<b>Vilagarcía de Arousa</b>																								
Port of Vilagarcía				✓		✓				✓	✓							✓				✓		
<b>Vilagarcía de Arousa</b>																								
Autoridad Portuaria de Vilagarcía de Arousa				✓	✓	✓					✓							✓	✓	✓	✓	✓	✓	✓
<b>SRI LANKA</b>																								
<b>Galle</b>																								
Galle Port				✓		✓					✓	✓												
<b>ST PIERRE &amp; MIQUELON</b>																								
<b>Saint-Pierre and Miquelon</b>																								
Saint-Pierre Harbour																								✓
<b>ST VINCENT &amp; THE GRENADINES</b>																								
<b>Kingstown</b>																								
Kingstown				✓																				
<b>SUDAN</b>																								
<b>Port Sudan</b>																								
Sea Ports Corporation	✓	✓	✓	✓	✓			✓	✓		✓		✓	✓	✓		✓	✓	✓	✓	✓	✓	✓	✓
<b>SULTANATE OF OMAN</b>																								
<b>Muscat</b>																								
Oman Flour Mills Co SAOG				✓																				
<b>N. Azaiba</b>																								
Port of Duqm																								
<b>SURINAME</b>																								
<b>Paramaribo</b>																								
N.V. Havenbeheer Suriname				✓	✓	✓	✓				✓		✓	✓	✓	✓	✓	✓	✓	✓	✓	✓	✓	✓
<b>SWEDEN</b>																								
<b>Gavle</b>																								
Port of Gavle Authority									✓												✓	✓		✓
<b>Göteborg</b>																								
Port of Göteborg																					✓			
<b>Halmstad</b>																								
Halmstad Port	✓																				✓	✓		
<b>Helsingborg</b>																								
Helsingborg Coal Terminal	✓																							
<b>Helsingborg</b>																								
Helsingborgs Hamn, Port of Helsingborg				✓					✓		✓													
<b>Helsingborg</b>																								
Lantmännen, Farmers Assoc.				✓																				
<b>Husum</b>																								
Husum Port																								
<b>Kalmar</b>																								
Kalmar Hamn AB (Port of Kalmar)				✓	✓		✓				✓		✓	✓							✓	✓		✓



COMMODITIES	CL	CC	PC	G-A	AF	CM	CLK	IO	BX	AL	FR	G-FGD	AG	SU	SOY	SODA	MIN	CHEM	BC	FRS	STL	P&P	MB	OTH
<b>Karlshamn</b>																								
Port of Karlshamn				✓																	✓			
<b>Karlstad</b>																								
Vänerhamn AB	✓		✓	✓	✓	✓		✓	✓		✓		✓		✓	✓	✓		✓	✓	✓	✓	✓	
<b>Kristinehamn</b>																								
Kristinehamn Port	✓			✓				✓																
<b>Lulea</b>																								
Port of Lulea	✓	✓	✓			✓		✓	✓															
<b>Lysekil</b>																								
Port of Lysekil				✓													✓		✓	✓	✓	✓	✓	✓
<b>Malmö</b>																								
Copenhagen Malmö Port AB	✓		✓	✓		✓						✓	✓	✓							✓	✓	✓	✓
<b>Oxelsund</b>																								
Oxelösunds Hamn AB	✓																							
<b>Södertälje</b>																								
Port of Sodertälje																								
<b>Sonderhamn</b>																								
Sonderhamn Port				✓																				
<b>Stockholm</b>																								
Port of Hargshamn								✓	✓												✓			
<b>Uddevalla</b>																								
Uddevalla Port				✓				✓	✓		✓													
<b>Västerås</b>																								
Mälaren Hamn AB	✓	✓	✓	✓	✓	✓		✓		✓	✓		✓				✓	✓	✓	✓	✓	✓	✓	✓
<b>Ystad</b>																								
Port of Ystad	✓			✓							✓								✓	✓				✓
<b>SWITZERLAND</b>																								
<b>Basel</b>																								
Port of Switzerland	✓	✓	✓	✓	✓	✓				✓	✓	✓	✓	✓	✓	✓	✓	✓	✓	✓	✓	✓	✓	✓
<b>Basel</b>																								
Rhenus-Alpina AG				✓																				
<b>Basel</b>																								
Ultra-Brag AG	✓	✓	✓	✓	✓					✓	✓			✓	✓		✓		✓	✓	✓	✓	✓	✓
<b>Birsfelden</b>																								
BIRS Terminal AG	✓	✓						✓					✓									✓		
<b>Lugano</b>																								
Interbulk						✓	✓																	
<b>SYRIA</b>																								
<b>Lattakia</b>																								
Lattakia General Port Company				✓																				
<b>Tartous</b>																								
Tartous Port Authority											✓													
<b>TAIWAN</b>																								
<b>Hualien</b>																								
Hualien Port	✓					✓						✓	✓											✓
<b>Kaohsiung</b>																								
Kaohsiung Harbour Bureau	✓	✓		✓	✓	✓	✓	✓	✓	✓	✓	✓		✓	✓	✓	✓	✓	✓	✓	✓	✓	✓	✓
<b>Keelung</b>																								
Keelung Port Authority	✓			✓		✓																		
<b>Mai Liao</b>																								
Mai Liao Harbour Administration Corp	✓		✓														✓							✓
<b>Suao Port Building</b>																								
Su-Ao Port Authority	✓					✓																		
<b>Taichung</b>																								
Port of Taichung, Asia Cement Berth																								
<b>Taichung</b>																								
Taichung-Wharf No 1				✓																				
<b>Taipei</b>																								
Eastern Media																								
International Corporation				✓																				
<b>Wuchi</b>																								
Taichung Port Authority	✓			✓		✓							✓										✓	✓
<b>TANZANIA</b>																								
<b>Dar es Salaam</b>																								
Tanzania Harbours Authority				✓																				
<b>Dar es Salaam</b>																								
Tanzania Ports Authority	✓			✓	✓	✓	✓	✓			✓	✓		✓	✓	✓	✓	✓	✓	✓	✓	✓	✓	✓
<b>Kurasini</b>																								
Grindrod Terminals - Dar Es Salaam																		✓						
<b>THAILAND</b>																								

# COMMODITIES HANDLED

COMMODITIES	CL	CC	PC	G-A	AF	CM	CLK	IO	BX	AL	FR	G-FGD	AG	SU	SOY	SODA	MIN	CHEM	BC	FRS	STL	P&P	MB	OTH
<b>Bangli</b>																								
S.P. Intermarine Co., Ltd	✓			✓				✓																
<b>Sattahip</b>																								
Sattahip Port Authority																								✓
<b>Singhanakorn</b>																								
Chaophaya Terminal International Co. Ltd				✓							✓													
<b>THE GAMBIA</b>																								
<b>Banjul</b>																								
The Gambia Ports Authority																								
<b>THE NETHERLANDS</b>																								
<b>Amsterdam</b>																								
Amfert											✓													
<b>Amsterdam</b>																								
B.V. Bouwgrondstoffen AGM													✓											
<b>Amsterdam</b>																								
Civil and Marine Nederland													✓											
<b>Amsterdam</b>																								
Graham - Grondstoffen Exp.																								
Amsterdam (Arc Marine)													✓											
<b>Amsterdam</b>																								
Maja Stuwadoors Rotterdam	✓			✓				✓																
<b>Amsterdam</b>																								
OBA - Bulk Terminal Amsterdam	✓	✓	✓	✓	✓				✓				✓		✓		✓				✓		✓	
<b>Amsterdam</b>																								
Port of Amsterdam	✓	✓	✓	✓	✓	✓	✓		✓	✓	✓	✓	✓	✓	✓	✓	✓	✓	✓		✓	✓	✓	✓
<b>Amsterdam</b>																								
Rietlanden Terminals BV	✓	✓						✓																✓
<b>Badhoevedorp</b>																								
IGMA	✓	✓		✓	✓	✓	✓	✓	✓	✓	✓	✓		✓	✓	✓	✓	✓	✓		✓		✓	
<b>Botlek</b>																								
Borax Rotterdam N.V.																								
<b>Botlek</b>																								
Jewometaal Stainless Processing																						✓		
<b>Delfzijl</b>																								
Aldel - Aluminium Delfzijl										✓														
<b>Delfzijl</b>																								
Groningen Seaports																								
<b>Dordrecht</b>																								
BV Zeehavenbedrijf Dordrecht																								
(ZHD Stevedoring)	✓	✓	✓	✓	✓	✓	✓	✓	✓	✓	✓	✓	✓	✓	✓	✓	✓	✓	✓	✓	✓	✓	✓	✓
<b>Dordrecht</b>																								
Port Authority of Dordrecht				✓							✓													✓
<b>Europoort - Rt</b>																								
Ertsoverslagbedrijf Europoort																								
C.V. (EECV)	✓	✓						✓																
<b>Farnsum</b>																								
Akzonobel	✓																							✓
<b>Ijmuiden</b>																								
Nebam BV	✓							✓	✓													✓		
<b>Koudekerk aan den Rijn</b>																								
ENBO BV						✓																		
<b>Mierlo</b>																								
International Bulk Handling																								
Technology BV	✓		✓					✓			✓		✓	✓										
<b>Moerdijk</b>																								
Associated Metal Services B.V.				✓	✓	✓		✓	✓	✓	✓						✓		✓	✓	✓	✓	✓	✓
<b>Moerdijk</b>																								
Combined Cargo Terminals B.V.										✓									✓		✓	✓	✓	✓
<b>Rotterdam</b>																								
C. Steinweg-Handelsvem BV									✓													✓	✓	✓
<b>Rotterdam</b>																								
European Bulk Services (EBS) BV	✓	✓	✓	✓	✓	✓	✓	✓	✓	✓	✓		✓	✓	✓	✓	✓	✓					✓	✓
<b>Rotterdam</b>																								
Europees-Massagoed																								
Overslagbedrijf (EMO) BV	✓	✓						✓																
<b>Rotterdam</b>																								
Marcor Stevedoring BV Rotterdam	✓	✓	✓	✓	✓		✓	✓	✓	✓	✓	✓	✓	✓	✓	✓	✓	✓				✓		✓
<b>Rotterdam</b>																								
Meneba				✓																				
<b>Rotterdam</b>																								



COMMODITIES	CL	CC	PC	G-A	AF	CM	CLK	IO	BX	AL	FR	G-FGD	AG	SU	SOY	SODA	MIN	CHEM	BC	FRS	STL	P&P	MB	OTH
Oxbow Coal B.V.	✓	✓	✓																					
<b>Rotterdam</b>																								
Port of Rotterdam	✓	✓	✓	✓	✓	✓	✓	✓	✓	✓	✓	✓	✓	✓	✓	✓	✓	✓	✓	✓	✓	✓	✓	✓
<b>Rotterdam</b>																								
RHB Stevedoring & Warehousing																			✓	✓	✓	✓		✓
<b>Rotterdam</b>																								
Stuwadoors en Controlebedrijf BV					✓																	✓		✓
<b>Rotterdam</b>																								
Van Uden Bulk Logistics			✓	✓	✓		✓	✓	✓	✓		✓	✓			✓	✓	✓	✓			✓	✓	✓
<b>Rotterdam</b>																								
Van Uden NedCargo																					✓			
<b>Rotterdam</b>																								
Van Uden Stevedoring	✓			✓	✓		✓	✓	✓		✓	✓					✓				✓		✓	✓
<b>Rozenburg</b>																								
EP Shipping & Trading BV	✓			✓																				
<b>Sas van Ghent</b>																								
Cerestar Benelux																								
<b>Sas van Ghent</b>																								
Zuid-Chemie											✓													
<b>Schiedam</b>																								
Nieuwe Waterweg Silo	✓		✓	✓	✓	✓	✓	✓	✓		✓	✓		✓	✓						✓	✓		✓
<b>Schiedam</b>																								
Van Mannekus & Co																							✓	
<b>Stiens</b>																								
EMG-Silo Groningen				✓																				
<b>Terneuzen</b>																								
Ovet BV - Terneuzen Terminal	✓	✓	✓	✓	✓		✓	✓	✓	✓	✓	✓	✓		✓	✓	✓				✓	✓		✓
<b>Terneuzen</b>																								
Terneuzen Port Authority																								
<b>Terneuzen</b>																								
Verbrugge Terneuzen Terminals					✓						✓					✓	✓	✓	✓	✓	✓	✓	✓	✓
<b>Terneuzen</b>																								
Zeeland Seaports	✓			✓					✓		✓										✓	✓	✓	✓
<b>Vlaardingen</b>																								
Port of Vlaardingen	✓			✓	✓		✓	✓	✓		✓											✓		✓
<b>Vlaardingen</b>																								
Rotterdam Bulk Terminal																								
(R.B.T.) B.V.	✓	✓	✓	✓			✓	✓	✓		✓		✓	✓			✓						✓	✓
<b>Vlissingen</b>																								
Ovet BV - Vlissingen Terminal	✓	✓	✓	✓	✓		✓	✓	✓	✓	✓	✓	✓		✓	✓	✓				✓	✓		✓
<b>Zwijndrecht</b>																								
Agro Delta Group				✓	✓						✓				✓									✓
<b>TOGA</b>																								
<b>Lome</b>																								
Office Togolaise des Phosphates																								
<b>TRINIDAD &amp; TOBAGO</b>																								
<b>Couvra Trinidad</b>																								
Point Lisas Industrial Port																					✓	✓		
Development Corp Ltd																								
<b>Point Lisas</b>																								
Point Lisas Industrial Port																								
Development Corp				✓		✓		✓			✓	✓		✓							✓		✓	✓
<b>Port of Spain</b>																								
Chaguaramas Terminals Ltd								✓	✓															
<b>Port of Spain</b>																								
Cronstadt Island																								✓
<b>Port of Spain</b>																								
Port Authority of Trinidad and Tobago				✓																				
<b>Port of Spain</b>																								
Port of Spain				✓																				
<b>TUNISIA</b>																								
<b>Bizerte</b>																								
Office des Ports Nationaux Tunisiens				✓							✓													
<b>Bizerte</b>																								
Port Authority of Bizerte				✓		✓																		
<b>Port de la Goulette</b>																								
Port Authority of Tunis Goulette				✓				✓			✓													
<b>Sfax</b>																								
Port Authority of Sfax				✓							✓													✓
<b>TURKEY</b>																								

# COMMODITIES HANDLED

COMMODITIES	CL	CC	PC	G-A	AF	CM	CLK	IO	BX	AL	FR	G-FGD	AG	SU	SOY	SODA	MIN	CHEM	BC	FRS	STL	P&P	MB	OTH
<b>Bursa</b>																								
Gemlik Port											✓													
<b>Eregli</b>																								
Eregli Port Authority	✓							✓	✓															
<b>Hereke-Izmit</b>																								
NUH Cement Factory of Hereke						✓																		
<b>Istanbul</b>																								
Toros Tarım Sanayi ve Ticaret A -TOROS Ceyhan Term	✓	✓	✓	✓	✓	✓	✓	✓	✓	✓	✓	✓	✓	✓	✓	✓	✓	✓	✓	✓	✓	✓	✓	✓
<b>Izmir</b>																								
Izmir Port				✓				✓	✓															
<b>Mersin</b>																								
Famagusta Port Authority				✓		✓						✓												
<b>Tekirdag</b>																								
Tekirdag Port				✓																				
<b>Tekkeköy/Samsun</b>																								
Toros Tarım San. ve Tic. A.	✓																							
<b>Trabzon</b>																								
Trabzon Port				✓				✓	✓															
<b>UAE</b>																								
<b>Abu Dhabi</b>																								
Abu Dhabi Seaport Authority				✓							✓													✓
<b>Abu Dhabi</b>																								
Port Zayed																								
<b>Ajman</b>																								
Emirates Ports Services																								
<b>Dubai</b>																								
DP World	✓			✓		✓		✓			✓										✓	✓	✓	
<b>Dubai</b>																								
Dubai Port World			✓	✓	✓		✓	✓	✓	✓	✓	✓	✓	✓					✓	✓	✓	✓		✓
<b>Fujairah</b>																								
Port of Fujairah								✓	✓				✓											✓
<b>UK</b>																								
<b>Ayr</b>																								
Associated British Ports (Ayr and Troon)	✓			✓	✓	✓					✓		✓		✓	✓			✓	✓	✓			✓
<b>Ayr</b>																								
Ayr	✓			✓							✓													
<b>Barrow upon Humber</b>																								
New Holland Bulk Services				✓							✓													
<b>Barrow-in-Furness</b>																								
Port of Barrow-in-Furness													✓								✓	✓	✓	✓
<b>Belfast</b>																								
Belfast Harbour Commissioners	✓		✓	✓	✓	✓	✓				✓				✓						✓	✓	✓	
<b>Berwick-Upon-Tweed</b>																								
Berwick Harbour Commission				✓	✓	✓					✓										✓			✓
<b>Blyth</b>																								
Port of Blyth	✓																				✓		✓	
<b>Bootle</b>																								
E-ON UK Liverpool	✓																							
<b>Boston</b>																								
Lingrain Services Ltd				✓																				
<b>Bristol</b>																								
The Bristol Port Company	✓			✓	✓						✓	✓	✓		✓				✓	✓		✓	✓	
<b>Canningtown</b>																								
European Metal Recycling Ltd	✓	✓						✓					✓											✓
<b>Cardiff</b>																								
ABP South Wales (Ports of Newport, Cardiff)	✓			✓		✓																		
<b>Cardiff</b>																								
Associated British Ports	✓			✓	✓	✓	✓	✓	✓	✓	✓	✓	✓	✓	✓	✓	✓	✓	✓	✓	✓	✓	✓	✓
<b>Coleraine</b>																								
Coleraine Harbour Commissioners	✓																							✓
<b>Dundee</b>																								
Forth Ports PLC - Port of Dundee				✓							✓													
<b>Dundee</b>																								
Grainfax				✓	✓								✓											
<b>Egham</b>																								
Cemex UK						✓																		
<b>Falmouth</b>																								
A & P Falmouth Ltd	✓	✓		✓	✓						✓		✓					✓	✓	✓			✓	
<b>Felixstowe</b>																								



COMMODITIES	CL	CC	PC	G-A	AF	CM	CLK	IO	BX	AL	FR	G-FGD	AG	SU	SOY	SODA	MIN	CHEM	BC	FRS	STL	P&P	MB	OTH	
Felixstowe Dock & Railway Company																								✓	
<b>Fowey</b>																									✓
Fowey Harbour Commissioners																									✓
<b>Garston</b>																									
ABP - Garston				✓	✓	✓	✓				✓		✓		✓				✓	✓	✓	✓	✓	✓	✓
<b>Glasgow</b>																									
Clyde Port Authority	✓					✓							✓								✓				✓
<b>Glasgow</b>																									
Clydeport Operations	✓					✓		✓					✓								✓				
<b>Goole</b>																									
ABP - Goole Port				✓		✓			✓		✓								✓	✓	✓		✓	✓	✓
<b>Grangemouth</b>																									
Casper Shipping Ltd																						✓			
<b>Grangemouth</b>																									
Forth Ports Plc				✓																					
<b>Grangemouth</b>																									
Grangemouth	✓									✓			✓				✓	✓	✓	✓	✓	✓	✓	✓	✓
<b>Grangemouth</b>																									
Leith Docks	✓			✓							✓														
<b>Gravesend</b>																									
Port of London Authority	✓			✓																					
<b>Great Yarmouth</b>																									
East Port UK	✓			✓	✓	✓					✓		✓								✓		✓	✓	
<b>Grimsby</b>																									
Associated British Ports - Grimsby & Immingham	✓		✓	✓	✓	✓	✓	✓	✓		✓	✓	✓	✓							✓	✓	✓	✓	✓
<b>Hartlepool</b>																									
Tees and Hartlepool Port Authority	✓		✓	✓				✓	✓		✓		✓											✓	
<b>Holywell</b>																									
Mostyn Docks Limited					✓							✓										✓			
<b>Hull</b>																									
ABP - Port of Hull	✓			✓	✓	✓					✓		✓						✓	✓	✓	✓	✓	✓	✓
<b>Hull</b>																									
Frontier Agriculture Ltd				✓																					
<b>Hull</b>																									
Titan Cement UK						✓																			
<b>Immingham</b>																									
Casper Shipping Ltd	✓	✓	✓	✓	✓			✓					✓		✓									✓	
<b>Ipswich</b>																									
ABP - Port of Ipswich	✓			✓	✓	✓	✓			✓	✓		✓		✓	✓		✓	✓	✓	✓	✓	✓	✓	✓
<b>Ipswich</b>																									
ABP Port of Lowestoft				✓		✓					✓		✓								✓				
<b>Ipswich</b>																									
Clarksons Port Services				✓																					
<b>Ipswich</b>																									
The Grain Terminal (Ipswich) Ltd				✓	✓																				
<b>Isle of Man</b>																									
Port of Ramsey	✓			✓	✓	✓					✓													✓	✓
<b>Kings Lynn</b>																									
King's Lynn Conservancy Board				✓																					
<b>Liverpool</b>																									
Mersey Docks & Harbour Company	✓			✓	✓	✓	✓				✓		✓		✓						✓	✓	✓	✓	✓
<b>Liverpool</b>																									
Royal Seaforth Grain Terminal				✓																					
<b>London</b>																									
MacQuarie Capital (Europe) Limited																									
<b>Londonderry</b>																									
Londonderry Port & Harbour Commissioners	✓			✓		✓					✓														✓
<b>Manningtree</b>																									
Mistley Quay & Forwarding				✓				✓	✓		✓														
<b>Merton</b>																									
ABP																									
<b>Methil</b>																									
Port of Burntisland									✓																
<b>Middlesbrough</b>																									
Casper Shipping Ltd	✓																								
<b>Montrose</b>																									
Montrose Port Authority				✓	✓	✓					✓				✓			✓	✓	✓	✓	✓	✓	✓	✓
<b>Near Hull</b>																									
Hull Agency (Goole)	✓																								
<b>Newport</b>																									

# COMMODITIES HANDLED

COMMODITIES	CL	CC	PC	G-A	AF	CM	CLK	IO	BX	AL	FR	G-FGD	AG	SU	SOY	SODA	MIN	CHEM	BC	FRS	STL	P&P	MB	OTH	
<b>ABP - Port of Newport</b>	✓	✓	✓	✓	✓	✓					✓		✓				✓			✓	✓	✓	✓	✓	
<b>Newport</b>																									
<b>ABP - Port of Swansea</b>	✓					✓							✓												
<b>Newport</b>																									
<b>Newport Stevedores Ltd</b>	✓		✓			✓																			✓
<b>North Killingholme</b>																									
<b>Humber Sea Terminal</b>																									
<b>Nottingham</b>																									
<b>Hull Bulk Handling Ltd</b>	✓		✓	✓	✓							✓	✓		✓									✓	
<b>Oban</b>																									
<b>Glensanda Harbour</b>													✓												
<b>Padstow</b>																									
<b>Padstow Harbour Commissioners</b>				✓							✓		✓												✓
<b>Penzance</b>																									
<b>Penzance Harbour</b>																									✓
<b>Perth</b>																									
<b>Perth Harbour</b>	✓		✓	✓	✓						✓		✓								✓				✓
<b>Poole</b>																									
<b>Poole Harbour Commissioners</b>				✓																					✓
<b>Port Talbot</b>																									
<b>ABP - Port Talbot</b>	✓																								
<b>Portbury</b>																									
<b>Agricultural Bulk Services</b>				✓																					
<b>Portland</b>																									
<b>Portland Port Ltd</b>				✓							✓		✓								✓	✓			
<b>Rosyth</b>																									
<b>Port of Methil</b>	✓			✓							✓														✓
<b>Runcorn</b>																									
<b>Manchester Ship Canal Company Ltd</b>				✓		✓				✓	✓		✓			✓	✓								✓
<b>Rye</b>																									
<b>Rastrum Ltd</b>				✓	✓								✓						✓	✓	✓		✓		
<b>Seaham</b>																									
<b>Seaham Harbour Dock Company</b>	✓			✓							✓		✓												✓
<b>Sharpness</b>																									
<b>Port of Sharpness</b>	✓			✓	✓	✓					✓		✓								✓	✓		✓	✓
<b>Silloth</b>																									
<b>ABP - Port of Silloth</b>				✓		✓					✓														
<b>South Shields</b>																									
<b>Port of Tyne</b>	✓	✓	✓	✓	✓	✓	✓	✓	✓	✓	✓	✓	✓	✓	✓	✓	✓	✓	✓	✓	✓	✓	✓	✓	✓
<b>Southampton</b>																									
<b>ABP - Southampton</b>				✓		✓					✓														
<b>Southampton</b>																									
<b>Solent Stevedores Ltd</b>				✓	✓			✓			✓	✓	✓	✓	✓				✓	✓	✓		✓	✓	✓
<b>Southampton</b>																									
<b>Southampton Grain Terminal Ltd</b>				✓																					
<b>Sunderland</b>																									
<b>Port of Sunderland</b>	✓	✓	✓				✓				✓	✓	✓								✓	✓	✓		
<b>Swansea</b>																									
<b>ABP Harbour Office</b>	✓	✓		✓		✓		✓			✓		✓				✓				✓	✓	✓		✓
<b>Teignmouth</b>																									
<b>ABP - Teignmouth</b>				✓																					
<b>Tilbury</b>																									
<b>Port of Tilbury London Limited</b>				✓							✓										✓	✓	✓		
<b>Tilbury</b>																									
<b>Port of Tilbury London Ltd - Grain Terminal</b>				✓	✓						✓			✓											
<b>Tilbury</b>																									
<b>Stema Shipping UK</b>													✓												
<b>Warrenpoint</b>																									
<b>Warrenpoint Harbour Authority</b>				✓																	✓	✓			
<b>Whitstable</b>																									
<b>Whitstable Harbour</b>													✓												
<b>Wolverhampton</b>																									
<b>Tarmac Limited</b>													✓												
<b>Workington</b>																									
<b>Port of Workington</b>				✓	✓	✓					✓	✓	✓					✓	✓	✓	✓	✓	✓	✓	✓
<b>UKRAINE</b>																									
<b>Berdiansk</b>																									
<b>Berdiansk Port Authority</b>				✓				✓			✓														
<b>Ilichevsk</b>																									
<b>Port of Ilichevsk Authority</b>								✓																	
<b>Izmail</b>																									



COMMODITIES	CL	CC	PC	G-A	AF	CM	CLK	IO	BX	AL	FR	G-FGD	AG	SU	SOY	SODA	MIN	CHEM	BC	FRS	STL	P&P	MB	OTH		
Commercial Sea Port of Izmail	✓			✓																						
<b>Kerch</b>																										
The Kerch Merchant Port																							✓	✓		
<b>Kyiv</b>																										
PORTINVEST LLC																										
<b>Mariupol</b>																										
Mariupol Sea Commercial Port	✓	✓	✓	✓				✓	✓		✓							✓	✓		✓			✓		
<b>Nikoleav</b>																										
Nikolayev Port Authority				✓				✓																		
<b>Odessa</b>																										
Odessa Port Silo				✓																						
<b>Odessa</b>																										
Port of Odessa Authority				✓		✓								✓												
<b>Odessa</b>																										
PortInvest																										
<b>Odessa</b>																										
Transinvestservice (TIS) Ltd	✓	✓		✓				✓			✓							✓								
<b>Port of Kilia</b>																										
Kiliya Transhipment Point				✓																						
<b>Reni</b>																										
Port of Reni	✓	✓	✓	✓	✓	✓	✓	✓	✓	✓	✓	✓	✓	✓	✓	✓	✓	✓	✓	✓	✓	✓	✓	✓		
<b>Vikovo</b>																										
Port of Ust-Dunaysk				✓																						
<b>Yalta</b>																										
Yalta Sea Trade Port Authority																								✓		
<b>Yuzhny</b>																										
JV Transinvestservice TIS				✓							✓															
<b>Yuzhny</b>																										
Port Yuzhny	✓			✓			✓	✓	✓		✓										✓					
<b>UNITED ARAB EMIRATES</b>																										
<b>Abu Dhabi</b>																										
E-ships Oldendorff Logistics	✓							✓																		
<b>URUGUAY</b>																										
<b>Montevideo</b>																										
Corporación Navios S.A.				✓																						
<b>Montevideo</b>																										
Paysandu Coordinadora																										
de Puertos Uruguay				✓																						
<b>Montevideo</b>																										
T.G.U.S.A Uruguayan Grain Terminals				✓																						
<b>Nueva Palmira</b>																										
Terminal Nueva Palmira				✓																						
<b>Rio Negro</b>																										
Terminal Fray Bentos				✓																						
<b>USA</b>																										
<b>Aberdeen</b>																										
Port of Grays Harbor				✓	✓				✓				✓								✓	✓	✓		✓	
<b>Albany</b>																										
Albany Port District Commission				✓	✓						✓			✓							✓	✓	✓			
<b>Albany</b>																										
Port of Albany				✓																	✓	✓				
<b>Alexandria</b>																										
American Association of Port Authorities (AAPA)																										
<b>Ama</b>																										
ADM Gromark-Destrehan				✓																						
<b>Anacortes</b>																										
Metro Ports				✓									✓					✓								
<b>Anacortes</b>																										
Metro Ports				✓																					✓	
<b>Anacortes</b>																										
Port of Anacortes				✓														✓		✓	✓					
<b>Anchorage</b>																										
North Star Terminal																										
Stevedore Company																					✓			✓		
<b>Anchorage</b>																										
Port of Anchorage							✓																			
<b>Arabi</b>																										
Associated Terminals																										
of St Bernard	✓	✓	✓	✓	✓			✓	✓	✓	✓	✓	✓	✓	✓	✓	✓	✓	✓	✓	✓	✓	✓	✓	✓	
<b>Argo</b>																										

# COMMODITIES HANDLED

COMMODITIES	CL	CC	PC	G-A	AF	CM	CLK	IO	BX	AL	FR	G-FGD	AG	SU	SOY	SODA	MIN	CHEM	BC	FRS	STL	P&P	MB	OTH	
Kinder Morgan Terminals	✓																								
<b>Baltimore</b>																									
Baltimore Terminal	✓																								
<b>Baltimore</b>																									
Maryland Port Administration																									
<b>Baltimore</b>																									
Port of Baltimore	✓			✓				✓	✓		✓	✓									✓				
<b>Baltimore</b>																									
Rukert Terminals Corp				✓					✓		✓	✓	✓								✓		✓	✓	
<b>Baton Rouge</b>																									
Louisiana Mid-Stream Terminals, LLC	✓	✓	✓																						
<b>Bayonne</b>																									
Duraport Marine & Rail Terminal, LLC													✓												
<b>Beaumont</b>																									
Beaumont Bulk Terminal Inc				✓				✓													✓	✓			
<b>Beaumont</b>																									
Port of Beaumont				✓																	✓	✓		✓	
<b>Bellingham</b>																									
Port of Bellingham					✓					✓	✓		✓								✓		✓		
<b>Benicia</b>																									
Port of Benicia Authority			✓																						✓
<b>Boston</b>																									
Massport Maritime Department	✓			✓		✓		✓				✓													
<b>Braithwaite</b>																									
Plaquemines Port	✓	✓		✓																				✓	
<b>Bridgeport</b>																									
Bridgeport Port Authority													✓											✓	✓
<b>Brownsville</b>																									
Port of Brownsville				✓						✓															
<b>Brunswick</b>																									
Marine Port Terminals Inc			✓	✓							✓														✓
<b>Buffalo</b>																									
Port of Buffalo	✓		✓					✓				✓	✓								✓	✓			✓
<b>Burlingame</b>																									
Ports America						✓	✓				✓	✓	✓								✓	✓	✓	✓	✓
<b>Camden</b>																									
Delaware River Port Authority																									
<b>Camden</b>																									
South Jersey Ports Corp			✓																		✓				
<b>Canonsburg</b>																									
CONSOL Energy Inc.	✓																				✓	✓			
<b>Cape Canaveral</b>																									
Port Canaveral					✓	✓					✓	✓	✓				✓		✓	✓	✓	✓	✓		✓
<b>Carteret</b>																									
Kinder Morgan Liquid Terminals, LLC																									
<b>Caruthersville</b>																									
Pemiscot County Port Authority				✓							✓														✓
<b>Catoosa</b>																									
Gavilon Fertilizer, LLC				✓							✓	✓													✓
<b>Catoosa</b>																									
Tulsa Port of Catoosa				✓							✓	✓							✓			✓			✓
<b>Ceredo</b>																									
Kanawha River Terminal Inc	✓																								
<b>Charleston</b>																									
Kinder Morgan Terminals -																									
Pier IX Terminal	✓																								
<b>Charleston</b>																									
Kinder Morgan Terminals -																									
Shipyard River Terminal	✓																								
<b>Charleston</b>																									
Port of Charleston	✓			✓							✓														
<b>Charleston</b>																									
Stevens Shipping & Terminal Co																									
<b>Charlotte</b>																									
CSX World Terminals																									
<b>Chesapeake</b>																									
Kinder Morgan Elizabeth																									
River Terminals				✓					✓		✓														
<b>Chicago</b>																									
Illinois International Port Dist.	✓	✓	✓	✓	✓	✓	✓	✓	✓	✓	✓	✓	✓	✓	✓	✓	✓	✓	✓	✓	✓	✓	✓	✓	✓
<b>Chicago</b>																									
KCBX Terminals Company	✓	✓	✓					✓																	



COMMODITIES	CL	CC	PC	G-A	AF	CM	CLK	IO	BX	AL	FR	G-FGD	AG	SU	SOY	SODA	MIN	CHEM	BC	FRS	STL	P&P	MB	OTH
<b>Cleveland</b>																								
Port of Cleveland						✓		✓														✓		✓
<b>Conneaut</b>																								
Pittsburgh & Conneaut Dock Co.	✓	✓	✓					✓			✓	✓	✓				✓						✓	✓
<b>Convent</b>																								
IC RailMarine Terminal (ICRMT)	✓	✓	✓					✓			✓		✓				✓					✓		✓
<b>Convent</b>																								
St. James Stevedoring Partners, LLC	✓	✓	✓	✓	✓	✓	✓	✓	✓	✓	✓	✓	✓	✓	✓	✓	✓		✓	✓	✓	✓	✓	✓
<b>Coos Bay</b>																								
Oregon International																								
Port of Coos Bay								✓													✓	✓		
<b>Cora</b>																								
Kinder Morgan Terminals - Cora						✓																		
<b>Cordova</b>																								
Port of Cordova																								
<b>Corpus Christi</b>																								
Boyd-Campbell Company	✓	✓	✓	✓	✓	✓	✓	✓					✓						✓			✓	✓	✓
<b>Corpus Christi</b>																								
Port of Corpus Christi	✓		✓	✓				✓	✓															
<b>Corpus Christi</b>																								
Port of Corpus Christi - Bulk Terminal	✓	✓	✓	✓	✓			✓	✓				✓								✓	✓		✓
<b>Corpus Christi</b>																								
Public Elevator				✓																				
<b>Corpus Christi</b>																								
Sherwin Alumina, L.P.									✓	✓														
<b>Corte Madera</b>																								
The Pasha Group																					✓	✓	✓	
<b>Darrow</b>																								
Burnside Bulk Marine Terminal	✓								✓	✓														
<b>Darrow</b>																								
Cooper/Consolidated	✓	✓	✓	✓	✓	✓	✓	✓	✓	✓	✓	✓	✓	✓	✓	✓	✓	✓			✓	✓	✓	✓
<b>Davant</b>																								
U.S. United Bulk Terminal	✓	✓	✓					✓		✓	✓	✓	✓										✓	
<b>Davant</b>																								
United Bulk Terminals - Davant	✓	✓	✓																					
<b>Decatur</b>																								
ARTCO	✓		✓	✓					✓	✓	✓													
<b>Decatur</b>																								
Kinder Morgan Terminals - Decatur	✓			✓	✓	✓	✓	✓	✓		✓	✓	✓								✓	✓	✓	✓
<b>Detroit</b>																								
Detroit / Wayne County Port Authority				✓																		✓		✓
<b>Detroit</b>																								
Port of Detroit																						✓		
<b>Duluth</b>																								
AGP Grain Limited				✓																				
<b>Duluth</b>																								
Duluth Seaway Port Authority	✓	✓		✓	✓	✓	✓	✓			✓		✓				✓		✓	✓	✓	✓	✓	✓
<b>Duluth</b>																								
General Mills Elevator A				✓																				
<b>Duluth</b>																								
Krech Ojard & Assoc	✓					✓	✓	✓					✓				✓					✓		
<b>East Liverpool</b>																								
Columbiana County Port Authority																								✓
<b>Eastport</b>																								
Eastport Port Authority													✓								✓			
<b>Erie</b>																								
Mount Fort Terminal													✓										✓	✓
<b>Eureka</b>																								
Humboldt Bay Harbour District																								
<b>Evansville</b>																								
Kinder Morgan Terminals - Evansville	✓																							
<b>Everett</b>																								
Port of Everett										✓											✓	✓		✓
<b>Fields Landing</b>																								
Port of Eureka				✓																	✓			
<b>Fort Lauderdale</b>																								
Port Everglades Department of Broward County	✓	✓				✓			✓														✓	✓
<b>Fresno</b>																								
Penny Newman Grain Co				✓																				
<b>Galveston</b>																								

# COMMODITIES HANDLED

COMMODITIES	CL	CC	PC	G-A	AF	CM	CLK	IO	BX	AL	FR	G-FGD	AG	SU	SOY	SODA	MIN	CHEM	BC	FRS	STL	P&P	MB	OTH
Farmland Elevator G				✓																				
<b>Galveston</b>																								
Metro Ports																								
<b>Galveston</b>																								
Port of Galveston				✓										✓							✓	✓		
<b>Georgetown</b>																								
Liberty Terminals, LLC																								
<b>Georgetown</b>																								
Port of Georgetown						✓		✓					✓											
<b>Georgetown</b>																								
Stevedoring Services of America (SSA)	✓																							
<b>Georgetown</b>																								
Winyah Stevedoring Inc																								
<b>Georgetown</b>																								
WSI of the Southeast llc	✓																							
<b>Glen Carbon</b>																								
SynFuel Technologies Inc.																								
<b>Grand Rivers</b>																								
Kinder Morgan Terminals - Grand Rivers	✓																							
<b>Green Bay</b>																								
Port of Green Bay	✓				✓	✓															✓	✓	✓	✓
<b>Gretna</b>																								
Associated Grain Terminals				✓	✓																			✓
<b>Gulfport</b>																								
Mississippi State Port Authority at Gulfport																								
<b>Hilo</b>																								
Hilo Harbour	✓																							
<b>Hilo</b>																								
State of Hawaii, Department of Transportation						✓													✓	✓				
<b>Homer</b>																								
City of Homer Port and Harbor																			✓	✓	✓		✓	✓
<b>Honolulu</b>																								
Honolulu Port Authority				✓																				
<b>Houston</b>																								
Cooper/T. Smith Stevedoring																								
<b>Houston</b>																								
Port of Houston Authority			✓	✓				✓														✓		
<b>Houston</b>																								
Public Elevator 2				✓																				
<b>Houston</b>																								
Texas Terminals LP	✓			✓		✓																		
<b>Houston</b>																								
Tx Tx Corporation	✓																							
<b>Humble</b>																								
P&O Ports Texas, Inc.				✓																	✓	✓	✓	
<b>Indiana</b>																								
Port of Indiana																								
<b>Indianapolis</b>																								
Burns International																								
Harbour-Port of Indiana		✓		✓							✓											✓		
<b>Jacksonville</b>																								
Jacksonville Electric Authority																								
<b>Jacksonville</b>																								
Jacksonville Port Authority																								
<b>Juneau</b>																								
Port of Juneau																								
<b>Kalama</b>																								
Harvest States Elevator				✓																				
<b>Kalama</b>																								
Peavey Elevator				✓																				
<b>Kenai</b>																								
Port of Kenai																								
<b>Kenova</b>																								
Big Sandy Terminal Inc	✓																							
<b>Kirkland</b>																								
Macquarie Ports Inc																								
<b>Kodiak</b>																								
City of Kodiak Harbour Department																								

COMMODITIES	CL	CC	PC	G-A	AF	CM	CLK	IO	BX	AL	FR	G-FGD	AG	SU	SOY	SODA	MIN	CHEM	BC	FRS	STL	P&P	MB	OTH
<b>La Place</b>																								
Port of South Louisiana	✓	✓	✓	✓	✓	✓	✓	✓	✓	✓	✓		✓	✓	✓	✓	✓	✓				✓		
<b>Lake Charles</b>																								
Lake Charles Harbor & Terminal District			✓	✓					✓												✓			
<b>Lake Charles</b>																								
Port of Lake Charles				✓																				
<b>Lamberts Point</b>																								
Norfolk Southern - Lamberts Point	✓																							
<b>Long Beach</b>																								
Cooper/T. Smith Stevedoring	✓																							
<b>Long Beach</b>																								
MCC-Lucky Cement Terminal						✓																		
<b>Long Beach</b>																								
Metro Ports	✓		✓			✓					✓					✓	✓							
<b>Long Beach</b>																								
Metro Ports	✓																							
<b>Long Beach</b>																								
Port of Long Beach	✓		✓	✓		✓						✓										✓		
<b>Longview</b>																								
Port of Longview			✓	✓	✓			✓			✓				✓	✓	✓		✓	✓	✓	✓	✓	✓
<b>Louisville</b>																								
Kinder Morgan Terminals - Louisville	✓																							
<b>Louisville</b>																								
Schaefer-Cooper Warehousing	✓																							
<b>Mandeville</b>																								
Consolidated Terminals & Logistics Company	✓	✓	✓	✓	✓	✓	✓	✓	✓	✓	✓	✓	✓	✓			✓				✓	✓	✓	✓
<b>Mandeville</b>																								
Cooper/Consolidated	✓	✓	✓	✓	✓	✓	✓	✓	✓	✓	✓	✓	✓	✓	✓	✓	✓	✓	✓	✓	✓	✓	✓	✓
<b>Maumee</b>																								
Kuhlman Corporation				✓	✓						✓			✓										
<b>Maumee</b>																								
The Andersons - Maumee Grain Marine facilities				✓	✓						✓				✓									
<b>Maumee</b>																								
The Andersons, Inc				✓	✓										✓									
<b>Metairie</b>																								
Kinder Morgan Terminals	✓		✓								✓		✓											
<b>Metropolis</b>																								
AEP/Cook Coal Terminal	✓																							
<b>Miami</b>																								
Panama Canal Authority (ACP)																								
<b>Miami</b>																								
Port of Miami																								
<b>Milwaukee</b>																								
Continental Grain Elevator				✓																				
<b>Milwaukee</b>																								
Milwaukee Bulk Terminals	✓											✓	✓											
<b>Milwaukee</b>																								
Port of Milwaukee	✓	✓		✓		✓	✓				✓	✓							✓			✓	✓	✓
<b>Mobile</b>																								
Alabama State Port Authority	✓								✓													✓	✓	
<b>Mobile</b>																								
Cooper/T. Smith Stevedoring	✓					✓		✓														✓		
<b>Mobile</b>																								
FGDI LLC - ASPA Pier D																								
Grain Elevator				✓																				
<b>Mobile</b>																								
McDuffie Coal Terminal	✓																							
<b>Mobile</b>																								
Port of Mobile	✓			✓		✓		✓	✓			✓	✓								✓	✓	✓	✓
<b>Mobile</b>																								
Stevedoring Services Services of America																								
<b>Monaca</b>																								
Colona Terminal Services	✓	✓										✓	✓				✓							
<b>Monroe</b>																								
Tower Monroe Port Commision																								
<b>Morehead City</b>																								
North Carolina State Ports																								



# COMMODITIES HANDLED

COMMODITIES	CL	CC	PC	G-A	AF	CM	CLK	IO	BX	AL	FR	G-FGD	AG	SU	SOY	SODA	MIN	CHEM	BC	FRS	STL	P&P	MB	OTH	
Authority/Morehead City				✓	✓	✓					✓		✓								✓	✓	✓		✓
<b>Mount Pleasant</b>																									
Strachan Shipping Co	✓																								✓
<b>Mount Vernon</b>																									
Ports Of Indiana				✓								✓													
<b>Myrtle Grove</b>																									
International Marine Terminals	✓		✓			✓	✓	✓			✓		✓											✓	
<b>New Haven</b>																									
New Haven	✓											✓													✓
<b>New Haven</b>																									
New Haven Terminal																									✓
<b>New Orleans</b>																									
Cooper/T. Smith Stevedoring	✓																								
<b>New Orleans</b>																									
Port of New Orleans										✓												✓			
<b>Newark</b>																									
Metal Management NE	✓							✓	✓			✓										✓			
<b>Newport News</b>																									
Dominion Terminal Associates LLP	✓	✓	✓																						
<b>Newport News</b>																									
Kinder Morgan -Pier IX Terminal	✓					✓																			
<b>Norfolk</b>																									
Virginia International Terminals Inc				✓																					
<b>Norfolk</b>																									
Virginia Maritime Association	✓																								
<b>Norfolk</b>																									
Virginia Port Authority																									
<b>North Charleston</b>																									
Cooper/T. Smith Stevedoring																									
<b>Oakland</b>																									
Port of Oakland													✓									✓		✓	
<b>Oakville</b>																									
The Andersons				✓																					
<b>Ogdensburg</b>																									
Ogdensburg Bridge & Port Authority																									
<b>Olympia</b>																									
Port of Olympia																				✓	✓	✓	✓		✓
<b>Omaha</b>																									
Hansen-Mueller Company				✓																					
<b>Oswego</b>																									
Port of Oswego Authority				✓		✓					✓														
<b>Owensboro</b>																									
Kinder Morgan Terminals - Owensboro	✓																								
<b>Pago Pago</b>																									
Port of Pago Pago																									
<b>Palmer</b>																									
Port MacKenzie, Matanuska-Susitna Borough	✓					✓							✓							✓	✓				✓
<b>Palmer</b>																									
Port MacKenzie/Mat-Su Borough	✓					✓							✓								✓	✓			
<b>Palmetto</b>																									
Port Manatee Forestry Terminal Inc																					✓				
<b>Pascagoula</b>																									
Port of Pascagoula				✓						✓	✓		✓								✓	✓	✓	✓	✓
<b>Pensacola</b>																									
Port of Pensacola				✓							✓		✓											✓	
<b>Philadelphia</b>																									
Agway				✓																					
<b>Philadelphia</b>																									
Port of Philadelphia & Camden																					✓	✓	✓		
<b>Piti</b>																									
Port Authority of Guam						✓							✓												✓
<b>Point Comfort</b>																									
Port of Point Comfort/Port Lavaca									✓																
<b>Port Allen</b>																									
Associated Terminals of Baton Rouge/Port Allen	✓	✓			✓			✓	✓		✓	✓	✓			✓	✓	✓		✓	✓	✓	✓		✓
<b>Port Allen</b>																									
Port of Greater Baton Rouge	✓		✓	✓		✓	✓	✓														✓			✓
<b>Port Angeles</b>																									
Port of Port Angeles																					✓		✓		

COMMODITIES	CL	CC	PC	G-A	AF	CM	CLK	IO	BX	AL	FR	G-FGD	AG	SU	SOY	SODA	MIN	CHEM	BC	FRS	STL	P&P	MB	OTH
<b>Port Arthur</b>																								
Pabtex	✓		✓																					
<b>Port Arthur</b>																								
Port of Port Arthur			✓										✓						✓	✓	✓	✓		✓
<b>Port Hueneme</b>																								
Port Hueneme Port Authority				✓																				✓
<b>Port Newark</b>																								
Port Authority of NY & N Jersey	✓			✓																				
<b>Port Royal</b>																								
Port of Port Royal																								✓
<b>Port Smith</b>																								
Granite State Minerals	✓			✓		✓	✓	✓			✓		✓											✓
<b>Portland</b>																								
Columbia Grain Elevator				✓																				
<b>Portland</b>																								
International Terminals								✓																
<b>Portland</b>																								
Port of Portland				✓	✓			✓									✓	✓	✓	✓	✓	✓	✓	✓
<b>Portsmouth</b>																								
Sprague Energy	✓	✓	✓			✓	✓	✓	✓			✓	✓							✓	✓	✓	✓	✓
<b>Providence</b>																								
Waterson Terminal Services	✓	✓	✓			✓		✓	✓	✓			✓							✓	✓	✓		✓
<b>Pueblo</b>																								
Association of American Railroads																								
<b>Redwood City</b>																								
Port of Redwood City						✓			✓			✓	✓								✓		✓	
<b>Reserve</b>																								
Associated Terminals at Globalplex	✓	✓	✓		✓			✓	✓	✓	✓	✓	✓				✓	✓	✓	✓	✓	✓	✓	✓
<b>Reserve</b>																								
Associated Terminals LLC	✓	✓	✓	✓	✓	✓	✓	✓	✓	✓	✓	✓	✓	✓	✓	✓	✓	✓		✓	✓	✓	✓	✓
<b>Richmond</b>																								
Levin Richmond Terminal Corporation (LRTC)	✓	✓	✓					✓									✓						✓	✓
<b>Richmond</b>																								
Port of Richmond																								
<b>Roanoke</b>																								
Ashtabula Coal Pier	✓																							
<b>Saint Paul</b>																								
Port of St Paul																								
<b>Salt Lake City</b>																								
Savage Companies	✓																							
<b>San Diego</b>																								
Port of San Diego																						✓		
<b>San Francisco</b>																								
Port of San Francisco											✓		✓						✓	✓	✓	✓	✓	✓
<b>San Pedro</b>																								
Los Angeles Export Terminal		✓																						
<b>San Pedro</b>																								
Los Angeles Harbour Department																								✓
<b>San Pedro</b>																								
Marine Terminals Corporation						✓															✓	✓	✓	
<b>San Pedro</b>																								
Port of Los Angeles																								
<b>San Pedro</b>																								
World Port LA (Port of Los Angeles)	✓																							
<b>Sandusky</b>																								
CT Stevedoring	✓																							
<b>Sandusky</b>																								
Sandusky Dock Corporation, Pier #3	✓		✓																					
<b>Savannah</b>																								
Georgia Ports Authority USA				✓	✓			✓			✓	✓	✓			✓			✓	✓	✓	✓	✓	✓
<b>Savannah</b>																								
Metro Ports									✓		✓	✓	✓		✓	✓	✓		✓					✓
<b>Seattle</b>																								
Port of Seattle				✓		✓			✓			✓	✓								✓	✓	✓	
<b>Seattle</b>																								
Stevedoring Services of America	✓																				✓	✓		
<b>Seward</b>																								
Aurora Energy Services, LLC	✓																							
<b>Seward</b>																								
Port of Seward																								
<b>Skagway</b>																								

# COMMODITIES HANDLED

COMMODITIES	CL	CC	PC	G-A	AF	CM	CLK	IO	BX	AL	FR	G-FGD	AG	SU	SOY	SODA	MIN	CHEM	BC	FRS	STL	P&P	MB	OTH	
Port of Skagway																									
<b>St Louis</b>																									
Bunge St Louis				✓																					
<b>St Louis</b>																									
Cahokia Marine Services	✓																								
<b>Stamford</b>																									
Oxbow Carbon Minerals		✓	✓																						
<b>Stockton</b>																									
Metro Ports	✓		✓			✓		✓			✓		✓							✓		✓			✓
<b>Stockton</b>																									
Metropolitan Stevedore Company	✓	✓	✓					✓					✓					✓							
<b>Stockton</b>																									
Port of Stockton	✓	✓	✓	✓	✓	✓	✓	✓	✓	✓	✓	✓	✓	✓	✓	✓	✓	✓	✓	✓	✓	✓	✓	✓	✓
<b>Stockton</b>																									
Sunshine Cement, Inc						✓																			
<b>Superior</b>																									
Cenex Harvest States				✓																					
<b>Superior</b>																									
Peavey Company - Connor's Point Elevator				✓																					
<b>Superior</b>																									
Superior Midwest Energy Terminal	✓																								
<b>Tacoma</b>																									
Port of Tacoma Authority				✓					✓																
<b>Tacoma</b>																									
Stevedoring Services of America				✓																					
<b>Tallahassee</b>																									
Florida Ports Council																									
<b>Tampa</b>																									
Kinder Morgan Terminals - Tampaplex Terminal	✓																								
<b>Tampa</b>																									
Tampa Bay International Terminals Inc																					✓	✓			
<b>Tampa</b>																									
Tampa Bay Stevedores Ltd											✓														
<b>Tampa</b>																									
Tampa Port Authority	✓			✓	✓	✓					✓	✓	✓								✓	✓	✓	✓	✓
<b>Tampa</b>																									
United Maritime Group	✓							✓			✓														
<b>Texas City</b>																									
Oxbow Carbon & Minerals LLC	✓		✓																						
<b>Texas City</b>																									
Port of Texas City			✓	✓							✓														
<b>Toledo</b>																									
ADM Grain Company Ltd				✓	✓											✓									
<b>Toledo</b>																									
CSX Coal Dock	✓																								
<b>Toledo</b>																									
Midwest Terminals of Toledo International, Inc	✓		✓	✓	✓			✓	✓	✓	✓		✓	✓								✓			
<b>Toledo</b>																									
Toledo-Lucas County Port Authority	✓	✓	✓	✓	✓	✓	✓	✓	✓	✓	✓	✓	✓	✓	✓	✓	✓	✓	✓	✓	✓	✓	✓	✓	✓
<b>Valdez</b>																									
Port of Valdez						✓															✓				
<b>Vancouver</b>																									
Port of Vancouver, USA				✓		✓			✓		✓							✓			✓	✓	✓	✓	✓
<b>Vancouver</b>																									
United Grain Corp				✓																					
<b>Vancouver</b>																									
Vancouver-United Grain Elevator				✓																					
<b>Wheelersburg</b>																									
Norfolk Southern - Wheelersburg Terminal	✓																								
<b>Whittier</b>																									
Whittier Port Authority Commission																									
<b>Wilmington</b>																									
Metro Ports											✓							✓		✓	✓	✓	✓		✓
<b>Wilmington</b>																									
Metro Ports	✓		✓								✓						✓			✓	✓	✓			
<b>Wilmington</b>																									
Metropolitan Stevedore Company	✓	✓	✓					✓					✓				✓	✓							



COMMODITIES	CL	CC	PC	G-A	AF	CM	CLK	IO	BX	AL	FR	G-FGD	AG	SU	SOY	SODA	MIN	CHEM	BC	FRS	STL	P&P	MB	OTH	
<b>Wilmington</b>																									
North Carolina State Ports Authority/ Wilmington	✓		✓	✓	✓	✓					✓	✓	✓			✓		✓	✓	✓	✓	✓		✓	
<b>Wilmington</b>																									
Pasha Stevedoring & Terminals				✓																✓	✓	✓		✓	
<b>Wilmington</b>																									
Port of Wilmington, Delaware/Diamond State Port Co			✓		✓			✓	✓		✓								✓	✓	✓	✓		✓	
<b>VENEZUELA</b>																									
<b>Estado</b>																									
Ventterminales											✓														
<b>Guidad Guayana</b>																									
Interalumina																									
<b>Maracaibo</b>																									
BDV - Bulkguasare de Venezuela, SA	✓																								
<b>Maracaibo</b>																									
Carbones del Guasare SA	✓																								
<b>Maracaibo</b>																									
Port Authority of Maracaibo				✓																					
<b>Santa Cruz de Mara</b>																									
Santa Cruz Coal Terminal	✓																								
<b>VIETNAM</b>																									
<b>Ho Chi Min city</b>																									
Ho Chi Minh Port Authority				✓		✓					✓													✓	
<b>Ngo Quyen District</b>																									
Haiphong Port Authority	✓			✓	✓	✓	✓	✓	✓	✓	✓		✓	✓	✓	✓	✓				✓	✓	✓	✓	✓



Company	Page	Company	Page
ABB Switzerland Ltd	6	Nemag BV	57
Achenbach GmbH Metalltechnik	2	Neuro Industrietechnik GmbH	59
Agrico Sales, Inc.	4	NKM Noell Special Cranes GmbH	117
Anvil Attachments	8	ORTS GmbH Maschinenfabrik	60
Bedeschi SpA	10	Ovet BV	196
BLUG Credeblug S.L.	12	Pirs SAS	64
Bühler AG, Grain Logistics	13	PIV Drives GmbH - a Brevini Power Transmission Co.	48
Bulk Connections	184	PLM Cranes B.V.	Front Cover, 62
Bulk Logistic Landmark	14	Poço Bispo Multipurpose Terminal - TMPB	181
Buttimer Bulk Engineering	14	Port of Amsterdam	192
BV Zeehavenbedrijf Dordrecht (ZHD Stevedoring)	195	Port of Belledune	142
Caterpillar SARL	16	Port of Dunkerque	156
CFS Handling srl.	18	Port of Pori	154
Christianson Systems Inc.	20	Port-Trade ApS	63
Cimbria Bulk Equipment	21	RAM Spreaders	66
Cleveland Cascades Ltd	23	RBL-REI France	68
Coaltrans Conferences Ltd	158	RC Inspection B.V.	69
Conductix-Wampfler AG	22	RHB Stevedoring & Warehousing	200
Cooper/Consolidated	212	RHC Heavy Handling Machinery Limited	70
Coperion GmbH	24	Rhenus Midgard GmbH & Co. KG	162
CST COVERS	112	Rotterdam Bulk Terminal (R.B.T.) B.V.	204
DOMTEC International LLC	26	Royal Haskoning DHV	71
DSH Systems Ltd.	30	RTA ALESA Ltd.	72
Duisburger Hafen AG	160	Sandvik Mining	76
Dust Control Technology	31	Scantech International	78
E-Crane World Wide / E-Crane International USA	32	Schade Lagertechnik GmbH	75
Edge Innovate	113	Schenck Process GmbH	80
EMS-TECH Inc	28	SEA-Invest	138
ESI Eurosil BV	33	Seabulk Inc	82
European Bulk Services (EBS) BV	194	Sept-Îles Port Authority	144
Europees-Massagoed Overslagbedrijf (EMO) BV	198, 199	SIBRE - Siegerland Bremsen GmbH	83
FLSmidth Inc.	34	SIG Società Italiana Gomma Spa	81
FLSmidth Wadgassen GmbH	36	Siwertell – a Cargotec brand	85
Gans Cargo Operations	201	SMB International GmbH	87
Grindrod Management Services (Pty) Ltd	3, 186	Starlinger & Co. GmbH	128
HAVER & BOECKER OHG, Machinery Division	38	Stema SA	176
Heyl & Patterson Inc	40	Stevenel OY	89
Hitachi Construction Machinery (Europe) NV	41	Superior Industries, Inc.	90
Hudig & Veder BV	193	Swire CTM	91
IHI Transport Machinery Co., Ltd. (IUK)	42	TAKRAF GmbH	88
Indexator Rotator Systems AB	43	Telestack Limited	82
iSAM AG Gesellschaft fuer angewandte Kybernetik	44	Terex Fuchs GmbH	94
J & B Grabs b.v.	Inside Back Cover	Terminales Portuarias Del Pacifico, S A P I de C V	174
Laidig Systems Inc	46	The Pasha Group	223
Liebherr-Werk Nenzing GmbH	Back Cover	Thiele GmbH & Co KG	96
Listenow GmbH & Co.	49	Thunder Bay Port Authority	146
Logmarin Advisors Srl	49	TMSA Tecnologia em Movimentação S/A	98
Loibl Allen-Sherman-Hoff GmbH	50	Toledo-Lucas County Port Authority	221
Mack Manufacturing Inc	50	Tramco, Inc	100
Mantsinen Group Ltd Oy	118	Van Aalst Bulk Handling BV	102
Marcor Stevedoring BV Rotterdam	197	Verbrugge Terneuzen Terminals	202
Maritime Bulk Terminal Gdynia Ltd	180	Verstegen Grijpers BV	Inside Front Cover
Martin Engineering	52	Vibrafloor	104
Maschinen und Mühlenbau Erhard Muhr GmbH	53	VIGAN	106
Metso Minerals Industries, Inc.	54	Vossloh Kiepe GmbH	107
MRS Greifer GmbH	55	Zeeland Seaports	203
Negrini Srl	57		





# J&B GRABS

*With more than 60 years' experience, J&B Grabs is the name you can rely on*



Hydraulic High Volume Grabs



45 m<sup>3</sup> Hydraulic Grab



High Volume Rope Grabs  
31.5m<sup>3</sup>



Hydraulic Rehandling Grab



Hydraulic Cactus Grab (1.6m<sup>3</sup>)

Rope Cactus Grab (10m<sup>3</sup>)

## J&B GRABS FOR ALL KINDS OF BULK HANDLING

Products:

- Cactus Rope Grabs
- Rehandling Rope Grabs
- Hydraulic Cactus Grabs
- Hydraulic Rehandling Grabs
- Hydraulic Wood Grabs
- Hydraulic Demolition & Sorting Grabs
- Quick Change System
- Multipurpose Spreader

New Products:

- Big Bag Frame
- Cellulose Frame

All our grabs are custom made, designed and produced to our customers requirements.

J&B Grabs are highly efficient for large volume and low deadweight handling.



**J&B Grabs**

PO Box 176, 3454 ZK De Meern  
Netherlands  
Tel: +31 30 662 1616  
Fax: +31 30 666 3765  
E-mail: [info@jb-grabs.com](mailto:info@jb-grabs.com)  
Website: [www.jb-grabs.com](http://www.jb-grabs.com)



# Experience the progress.



**Liebherr-Werk Nenzing GmbH**  
P.O. Box 10, 6710 Nenzing/Austria  
Tel.: +43 50809 41-725  
Fax: +43 50809 41-447  
mobile.harbour.crane@liebherr.com  
www.liebherr.com

# LIEBHERR

**The Group**