



# DRY CARGO

*handling directory*



# 2 0 1 3

*The industry's only complete fully comprehensive listing for:*

■ Bulk Ports, Terminals

■ Equipment Manufacturers

■ Engineering Consultants

■ Inspection Companies

■ FIBC & Big Bag Manufacturers

■ Inland Transportation Operators



# VERSTEGEN

The Grab Specialist



GRAB  
MORE  
MORE  
GRAB



Verstegen Grippers B.V. • P.O. Box 1014 • 3430 BA Nieuwegein • The Netherlands  
tel: +31-30-6062222 • fax: +31-30-6060657  
email: [info@verstegen.net](mailto:info@verstegen.net) • website: [www.verstegen.net](http://www.verstegen.net)

# DC DRY CARGO

handling directory

2013

## DEFYING THE ODDS

*Singapore's Rocktree Logistics has ambitions of becoming a worldwide logistics solutions provider. Having already made its mark in Southeast Asia, can the company defy the odds and compete on a global scale?*

*For company details, please see p76, and look out for our article in the January issue of Dry Cargo International.*

*Rocktree Logistics Pte Ltd.  
3 Church Street #24-01/02 Samsung Hub  
Singapore 049483  
T: +65 6622 6500 F: +65 6622 6511  
E: info@rocktree.sg*

## PUBLISHERS

**Jason Chinnock**  
jason@dc-int.com  
**Andrew Hucker-Brown**  
andrew@dc-int.com

## EDITORIAL

**Louise Dodds-Ely** Editor  
louise@dc-int.com  
**Jay Venter** Deputy Editor  
editorial@dc-int.com  
**Samantha Smith** Directories  
directories@dc-int.com  
**Stephanie Hodgkins** Office Manager  
accounts@dc-int.com

## SALES

**Lourens van Emmenis** Sales Director  
sales@dc-int.com  
**Matthew Currin** Senior Sales Executive  
sales2@dc-int.com  
**Carmen Bester** Project Sales Executive  
carmen@dc-int.com

## CORRESPONDENTS

Brazil **Patrick Knight**  
Canada **Ray Dykes**  
India **Kunal Bose**  
Asia **David Hayes**  
Europe **Barry Cross**  
Malaysia **Wira Sulaiman**  
Philippines **Fred Pundol**  
South Africa **Iain McIntosh**  
Thailand **David Turner**  
UK **Maria Cappuccio**  
UK **Michael King**  
UK **Richard Scott**  
USA **Colby Haines**  
USA **Walter Mitchell**

## ADMINISTRATIVE OFFICE

Business Publishing International  
Corporate House, 11 Sinembe Crescent  
La Lucia Ridge, South Africa, 4051  
Tel: +27 31 583 4360  
Fax: +27 31 566 4502  
Email: info@dc-int.com

## HEAD OFFICE

Trade Publishing International Limited  
Clover House, 24 Drury Road,  
Colchester, Essex CO2 7UX, UK  
Tel: +44 (0)1206 562560  
Fax: +44 (0)1206 562566  
Email: info@dc-int.com  
Website: www.dc-int.com  
ISSN 1466-3643

*Trade Publishing International Ltd does not guarantee the information contained in Dry Cargo International, nor does it accept responsibility for errors or omissions or their consequences. Opinions expressed herein are not necessarily those of Trade Publishing International Ltd*



## Contents

### BULK HANDLING EQUIPMENT

COMPANY PROFILES	2
TABLE — COMMODITIES HANDLED	107

### INLAND TRANSPORT

BARGE HANDLING COMPANIES	119
RAIL HANDLING COMPANIES	121

### BAGGING

FIBC AND BAG MANUFACTURING COMPANIES	125
--------------------------------------	-----

### PORTS & TERMINALS

PORTS AND TERMINALS WORLDWIDE — BY COUNTRY	129
TABLE — COMMODITIES HANDLED	232



# The **Safer** option for hazard monitoring

Complete monitoring systems for bucket elevators and conveyors

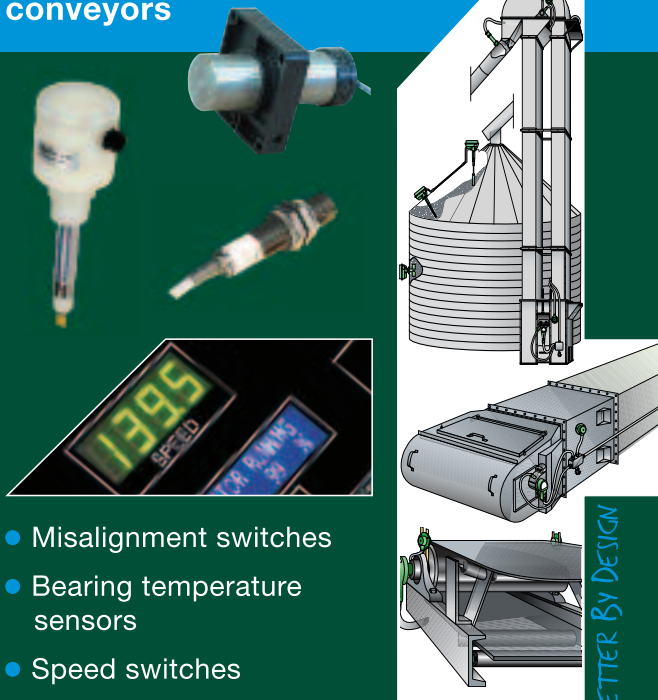

- Misalignment switches
- Bearing temperature sensors
- Speed switches
- Level indicators
- Inductive sensors



BETTER BY DESIGN

## Watchdog Elite

Complete Hazard Monitoring System for Bucket Elevators and Conveyors!

- Bearing Temperature, Belt Misalignment, Underspeed, Belt Slippage, Blockage Detection
- Fully programmable to optimize elevator operation
- LED displays for speed and set-up
- Simple, reliable, consistent



## Bulldog

Conveyor Belt Misalignment & Rip Detection System

- Triggers an alarm at 15° and a shutdown of the machine at 30°
- Easy installation; no calibration required
- Robust design
- ATEX & IECEX certified

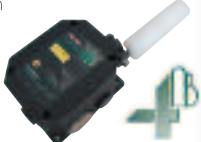

[www.go4b.com](http://www.go4b.com)  
4b-uk@go4b.com

Perfectly covered  
- with our hoods.

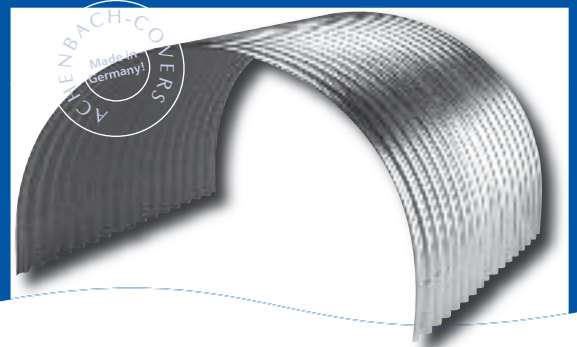

Achenbach metal hoods for conveyor belts

- The modern classic – in worldwide use
- Steel, aluminium, stainless – the appropriate material at any time
- Four corrugation profiles – suitable and cost-effective

Sale of organit-hard-PVC covers made in EU



Achenbach GmbH Metalltechnik  
Lindestraße 10 · D-57234 Wilnsdorf · Phone +49 (0) 2737/9863-0  
Fax: +49 (0) 2737/9863-10 · [www.achenbach-siegen.de](http://www.achenbach-siegen.de)

**“A MAN WHO STOPS  
ADVERTISING TO  
SAVE MONEY IS LIKE  
A MAN WHO STOPS A  
CLOCK TO SAVE  
TIME”**

- Henry Ford



To find out how you can benefit from advertising in the world's only monthly dry bulk publication contact Jason Chinnock or Andrew Hucker-Brown on:  
Tel: +44 (0)1206 562560  
Fax: +44 (0)1206 562566 Email: [info@dc-int.com](mailto:info@dc-int.com)



**A/S Cimbria**



Fårtoftevej 22  
Thisted 7700  
Denmark  
Contact: Mr Lars Noergaard  
Job Title: Sales Director  
T: + 45 7242 2420  
F: + 45 7242 2499  
E: lno@cimbria.com  
W: www.cimbria.com  
Cimbria is one of the world's leading producers within processing, handling and storage of grain and seed and other bulk products. We offer projecting and process control - as well as the development, manufacture and installation of individual machines.

**4B BRAIME Elevator Components**



Hunslet Road  
Leeds  
West Yorkshire  
LS10 1JZ  
UK  
Contact: Mrs Simone Block  
Job Title: Marketing Manager

T: + 44 113 246 1800  
F: + 44 113 243 5021  
E: 4b-uk@go4b.com  
W: www.go4b.com  
With over 120 years experience, 4B is the world's leading supplier of high quality Components for Bucket Elevators & Conveyors. 4B offers Mechanical Components (Elevator Buckets & Bolts, Belting & Fasteners, Forged Conveyor Chains...) as well as Electronic Components (Level Sensors, Belt Alignment Sensors, Bearing Temperature Sensors, Speed Sensors...).

**A. Friedr Flender AG**

Alfred Flender Strasse 77  
Bocholt D- 46395  
Germany  
Contact: Mr Matthias Wenning  
Job Title: Marketing  
T: + 49 2871 922 780 / + 49 2871 920  
F: + 49 2871 921 602  
E: matthias.wenning@flender.com  
W: www.flender.com  
Flender is a leading international manufacturer of mechanical and electrical components for power transmission equipment. Its diversified product range covers individual components and also complete drive systems for nearly all industrial applications. The company's history dates back over 100 years and it is continuously striving to achieve the best solutions for the future.

**AAF Ltd**

Bassington Lane  
Cramington  
Northumberland  
NE23 8AF  
UK  
Contact: Mr Jeremy Thompson  
Job Title: Air Pollution Control

Equipment Manager  
T: + 44 1670 566177  
F: + 44 1670 566312  
E: apc@aafgb.com  
W: www.apcaafgab.com  
Designs and manufactures dust extraction systems - plus aftermarket sales and service for all makes of dust collectors.

**ABB Engineering (Shanghai) Ltd.**

No.5 Lane 369  
Chuangye Road  
Pudong  
Shanghai 201319  
China  
Contact: Ms Cherie-Sile Hu  
Job Title: Marketing and Communication  
T: + 86 21 2328 8289  
F: + 86 21 2328 8290  
E: cherie-sile.hu@cn.abb.com  
W: www.abb.com/cranes  
ABB offers reliable automation solutions and electrical equipment that enable terminals to move, e.g. bulk material fast and cost efficiently. Already hundreds of various types of cranes in bulk and container terminals as well as industrial plants are equipped with our solutions and deliver to the highest productivity requirements every day.

**ABB Switzerland Ltd**

Local Business Unit Minerals  
Segelhofstrasse 9P  
Baden 5 Dättwil  
CH 5405  
Switzerland  
Contact: Mrs Marion Hug  
Job Title: Manager Marketing Communications  
T: + 41 58 586 7133  
F: + 41 58 586 7333

**BULK HANDLING EQUIPMENT COMPANY PROFILES**

E: minerals@ch.abb.com  
W: www.abb.com/minerals  
ABB delivers integrated process control, optimization and information systems, drives and power distribution equipment as well as service and support for the complete primary production chain in the mining, mineral processing and cement industry. With its global network, ABB provides local support and engineering facilities that are never far from you.

**Abbey Rollers Limited**

Togher Industrial Estate No. 2  
Pouladuff Road  
Cork  
Ireland  
Contact: Mrs Martha Murphy  
Job Title: Sales and Marketing  
T: + 353 21 496 2745  
F: + 353 21 431 4898  
E: sales@abbeyrollers.ie  
W: www.abbeyrollers.ie

**A-C Compressor Corporation**

401 E South Island Street  
Appleton  
Wisconsin 54915  
USA  
Contact: Ms Deirdre Latour  
Job Title: Marketing, Brand & Advertising

T: + 1 203 373 2145  
E: deirdre.latour@ge.com  
W: www.accompressor.com

**AC Robinson & Associates**

3rd Floor  
Lakeside Building  
Alexandra Park  
Prescot Road  
St Helens WA10 3TT  
UK  
Contact: Mr Simon Robinson  
Job Title: Manager  
T: + 44 1744 621 669  
F: + 44 1744 454 040  
E: info@acr.org.uk  
W: www.acr.org.uk/

**Achenbach GmbH Metalltechnik**

Lindstrasse 10  
Wilnsdorf D-57234  
Germany  
Contact: Mr Uwe Achenbach  
Job Title:  
T: + 49 2737 98 63 0  
F: + 49 2737 98 63 10  
E: u.achenbach@achenbach-siegen.de  
W: www.achenbach-siegen.de  
Conveyor covers - Achenbach



**MINE OVER MATTER**

Mine our rich vein of experience in the provision of comprehensive freight logistics solutions, shipping and trading for minerals, coal and ore. Our network of terminals strategically situated across southern Africa provides services which include cargo flow management from pit to port, storage, shiploading or discharging, stevedoring, clearing and forwarding, and stock management. Our Corridor Management facility offers expert assistance in moving cargo by rail and road. Our subsidiary Island View Shipping owns, operates and charters a large modern fleet of dry bulk carriers worldwide. Oreport, a 100% owned subsidiary within Grindrod Trading, specialises in the worldwide procurement, physical movement and distribution of industrial raw materials.

**Freight • Trading • Shipping • Financial | www.grindrod.co.za**



info@grindrod.co.za



# ARE YOU READY...

## For Post Panamax?

In 2014 the Panama Canal expansion completes, allowing LARGER vessels through the Canal. Terminals around the world are preparing now for these LARGER vessels.

### Maximum Panamax Ship Size:

	Current	New
Length	296.5m	366m
Beam	32.3m	49m
Draft	12.6m	15.2m

**Agrico loaders can load any size ship at any loading rate!**



**Agrico shiploaders can take you into the future!**

**AGRICO  
SALES**

Agrico Sales, Inc.  
14900 Intracoastal Dr.  
New Orleans, Louisiana 70129  
Phone 504 436 9400  
Email: [briek@agricosales.com](mailto:briek@agricosales.com)  
Website: [www.agricosales.com](http://www.agricosales.com)



manufactures hoods made of metal (steel, aluminium, stainless) for covering standard or special belts. Hoods made of hard-PVC and fixings round up the Achenbach range.

**Advance Automated Systems Ltd**

12 Enterprise City  
Spennymoor  
Durham DL16 6JF  
United Kingdom  
Contact: Ms Amy Redhead  
Job Title: Sales Admin.  
T: + 44 1388 811 122  
F: + 44 1388 811 133  
E: AmyRedhead@  
advanceautomation.co.uk  
W: www.advanceautomation.co.uk

**AE AntiEmission GmbH**

Nordhang 74  
Gevelsberg 58285  
Germany  
Contact: Dipl.-Ing A Eskandani  
Job Title: President  
T: + 49 2332 66 49 92 0  
F: + 49 2332 66 49 92 5  
E: Info@AntiEmission.de  
W: www.AntiEmission.de  
Serving coal and biomass power plants, the construction, demolition and recycling, raw & bulk material and mining industry. Our products and services: Spraying systems, fog cannons, fog cannon pole systems, dust binders, pile/slope/haul road stabilizers, ash treatment products, dust & ash mixers, air cannons, dust management & consultancy.

**AE Automation (M) Sdn bhd**

10-12, Jalan Mas 6  
Taman Cheras Mas  
Cheras, Selangor D.E.  
43200  
Malaysia  
Contact: Mr Ken Lim



Job Title: Managing Director  
T: + 60 7 455 6333  
F: + 60 7 455 6666  
E: ken@aeauto.com.my  
W: www.ae.com.my  
Specialized in Bulk material handling system, turnkey solutions in coal mining, power plants, cement plants, fertilizer plants, port projects.

**Aeromaster International Ltd**

Fairport House  
28 Charles Street  
Higher Hillgate  
Stockport SK1 3JR  
UK  
Contact: Mr James Horner  
Job Title: Sales Manager  
T: + 44 161 4774775  
F: + 44 161 4740257  
E: info@aeromaster-int.com  
W: www.fairport.co.uk/

As part of the Fairport Group of Companies including Flomat Bagfilla (FIBC big bag discharging & filling specialists), Fairport NEU Solutions (pneumatic conveying experts) and Fairport Process Equipment, we can offer a variety of materials handling solutions.

**AFM Industries**

828 Ritson Road  
Oshawa  
Ontario L1H 5L4  
Canada  
Contact: Mr Rob Butterworth  
Job Title: President  
T: + 1 905 443 0150  
F: + 1 905 443 0155  
E: rbutterworth@afmindustries.com  
W: www.afmindustries.com  
Supplier-fabricator of conveyor belting. Textile belting (polyester-

nylon-aramid) - Enduraply Textile belting with steelcord breakers - Enduraply-Plus Steelcord belting - Endurasteel Steelcord belting with steelcord breakers - Endurasteel-Plus Corrugated sidewall belting (1.5-16 inches) - Endurawall Extreme high heat belting - Enduratherm Complete installation-field splicing-jointing services.

**AgGrowth International Inc.**

1301 Kenaston Blvd  
Winnipeg MB  
R3P 2P2  
Canada  
Contact: Dr Joerg Zimmermann  
T: +1 204 489 1855  
F: + 1 204 488 6929  
E: joerg.zimmermann@aggrowth.com  
W: www.aggrowth.com

**Agora Services**

Telford Way  
Kettering  
Northants  
NN16 8YZ  
UK  
Contact: Mr Shaun Haycock  
T: + 44 1536 481629  
F: + 44 1536 410193  
E: sales@agoraservices.co.uk  
W: www.agoraservices.co.uk  
Engineers for powders and granules bulk material handling. Product range - hoppers, feeders, exciters and pneumatic, mechanical and screw conveying systems.

**Agrico Sales, Inc.**



14900 Intracoastal Drive  
New Orleans  
Louisiana  
70129  
USA  
Contact: Mr Bob Rieck  
Job Title: Vice President - Sales  
T: + 1 504 436 9400  
F: + 1 504 754 7732  
E: brieck@agricosales.com  
W: www.agricosales.com  
Agrico Sales is an equipment manufacturer and construction company specializing in turkey design/build projects for dry bulk commodities. Agrico builds: ship and barge loaders, conveyor systems, covered and open storage, rail and truck loading and unloading as well as jobs that include several of these components. Agrico is price competitive on a worldwide basis.



**TERMINAL VELOCITY**

With expanded terminal capacities and full infrastructure support for the key trade corridors throughout southern Africa – Grindrod Terminals is creating world-class logistics and terminal solutions that will optimise your cargo's delivery to and from local and international markets.





## Agromatic AG



Goldingenstrasse 30  
Laupen  
CH-8637  
Switzerland

Contact: Mr Tobias Diener  
T: + 41 55 256 21 00  
F: + 41 55 256 21 11  
E: info@agromatic.com

W: www.agromatic.com  
Specialises in bulk handling systems components, safety devices for mills, silos and storages and feed mill industries especially silo temperature monitoring equipment, level control, speed & alignment monitoring, automatic sampling, flow control, dampening systems and laboratory devices, metal detectors and separators, magnets.

## AJ Sackett & Sons Company

1701 South Highland Ave  
Baltimore  
Maryland  
21224  
USA

Contact: Mr Larry Taylor  
T: + 1 410 276 4466  
F: + 1 410 276 0241  
E: larryt@ajsackett.com  
W: www.ajsackett.com  
Designers and manufacturers of dry

bulk material handling systems, including conveying systems, blending, granulation, bagging and compaction systems.

## Akerbergs Maskiner AS

Marsallé 40  
Horsens  
8700  
Denmark

Contact: Mr Steen Lauge Jensen  
Job Title: Sales Manager - Port Equipment  
T: + 45 76 281 841  
F: + 45 75 641 774  
E: slj@akerbergs.dk  
W: www.akerbergs.dk

International trader and repairer of new and used mobile cranes. Scandinavia's largest repair facility. Suppliers include Mannesmann Dematic Gottwald, Wylie and PLM. Akerbergs owns Jones Cranes Division and bought the world rights to manufacture Jones's mobile cranes in the early 1990s.

## AKJ Industries

PO Box 588  
Pewee Valley  
Kentucky  
40056  
USA

Contact: Mr Jack Cranfill  
Job Title: Vice President  
T: + 1 502 241 6932  
F: + 1 502 241 6766  
E: jackcranfill@yahoo.com  
W: www.akjindustries.com  
Provides dust control, belt de-icing and freeze conditioning chemicals equipment and service to the material handling industries.



# Wireless and wired transmission of temperature values

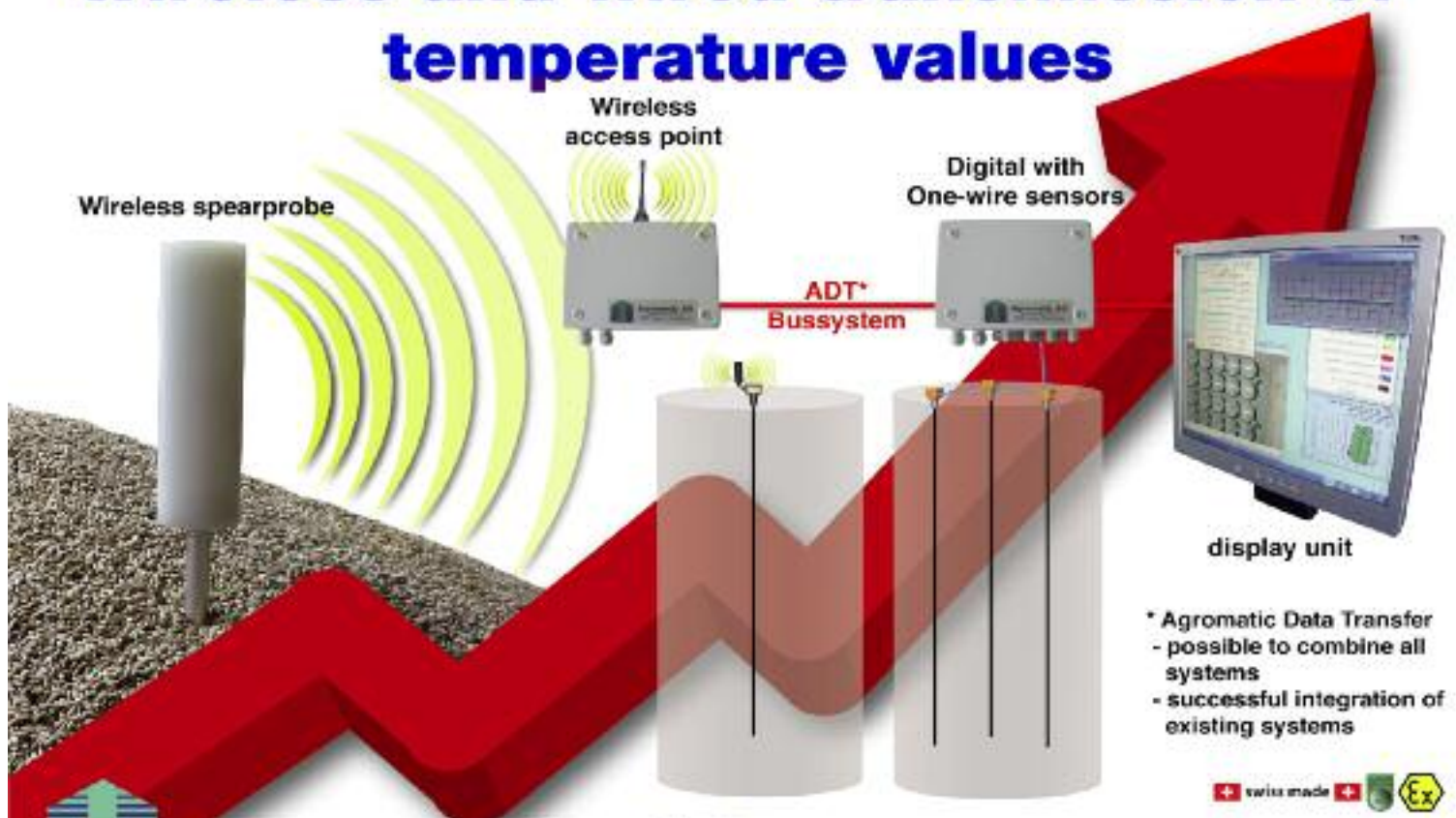

# Agromatic AG

CH-8637 Laupen / Switzerland / Tel: +41 55256 2100  
www.agromatic.com / info@agromatic.com



## Alcan Alesa Technologies Ltd

150 Rockland Rd  
Town of Mount Royal  
Quebec  
H3P 2V9  
Canada

Contact: Mr Rudy Keller  
T: + 1 514 937 9105  
F: + 1 514 937 0473

E: rudy.keller@riotinto.com  
W: www.alcanalesa.com

ALCAN ALESA is specialized in turnkey projects featuring systems emphasizing low energy consumption, operations efficiency, environmental protection and automation that ensure competitive advantages for the client. Innovative skills and experience in solving client's problems have characterised ALCAN ALESA projects worldwide for nearly 40 years.

## Alex Stewart (International) Corporation

20 Sefton Business Park  
Netherton  
Liverpool  
Merseyside  
L30 1RD  
UK

Contact: Mr Alex Stewart  
Job Title: MD

T: + 44 151 523 5438  
F: + 44 151 523 3760

E: alex.stewart@alexstewartinternational.com  
W: www.alexstewartinternational.com

## Alex Stewart Agriculture Ltd

21 Sefton Business Park  
Netherton  
Liverpool  
Merseyside  
L30 1RD  
UK

Contact: Mr Glenn Forbes  
Job Title: Agriculture Manager

T: + 44 151 525 1488

F: + 44 151 530 1563

E: Glenn.forbes@alexstewartagriculture.com

W: www.alexstewartagriculture.com

Offers a complete range of agricultural analytical, inspection and certification services for the facilitation of the international trading of soft commodities including raw & refined sugar, oils & fats, bio diesel, cereals, fertilisers and other food products.

## Alex Stewart International

21 Sefton Business Park  
Netherton  
Liverpool  
Merseyside  
L30 1RD  
UK

Contact: Mr Stephen Russell

T: + 44 151 525 1499

E: analysis@alexstewartinternational.com

W: www.alexstewartinternational.com

## Alfredo Brand P.

Casilla 16871  
Santiago  
Región Metropolitana  
7510147  
Chile

Contact: Mr Alfredo Brand

T: + 5622238968

F: + 5623440817

E: abrandp.gm@gmail.com

W: www.abrandp.com

## All-Fill International Ltd

5 Gateshead Close  
Sunderland Road  
Sandy  
Beds  
SG19 1RS  
UK

Contact: Mr Mike Warmington

Job Title: Sales Director

T: + 44 1767 691100

F: + 44 1767 681406

E: info@allfill.co.uk

W: www.allfill.co.uk

Manufacturer of powder filling systems and ancillary equipment.

## ALS Inspection

Caddick Road  
Knowsley Business Park  
Prescott  
Merseyside  
L34 9HP  
UK

Contact: Mr Christopher Walker

Job Title: Commercial Manager

T: + 44 151 548 7777

F: + 44 151 548 0714

E: info@alexstewart.com

W: www.alexstewart.com

Alex Stewart are suppliers of quality commodity inspection and laboratory analysis offering cargo supervision, quality and quantity inspection, weighing, sampling, assaying, testing, verification and certification services for the facilitation of international trade.

## AMECO SA

43, Rue du 21 Novembre  
Illfurth

F-68720

France

Contact: Mr Stephane Killian

Job Title: CEO

T: + 33 389 255969

F: + 33 389 255968

E: info@ameco-fr.com

W: www.ameco-fr.com

Manufactures mechanical loaders/unloaders complete with belt stackers, scraper reclaimers, bucket wheel reclaimers, enclosed storage systems and other storage systems, automation/computer/electrical and conveyors/components.

## Anker-Flexco GmbH

Leidringer Strasse 40-42  
Rosenfeld  
D-72348  
Germany

Contact: Mr Walther Sülzle

Job Title: Managing Director

T: + 49 7428 94060

F: + 49 7428 9406260

E: info@anker-flexco.de

W: www.anker-flexco.de

Mechanical belt fastening systems, installation tools, maintenance tools, ceramic lagging and cleaners.

## Antar@Pressvess

Stallings House  
Stallings Lane  
Kingswinford

West Midlands

DY6 7LG

UK

Contact: Mr John Moore

Job Title: Commercial Manager

T: + 44 1384 400088

F: + 44 1384 296268

W: www.pressvess.co.uk

## ANUPAM INDUSTRIES LIMITED

138, G.I.D.C. Vitthal Udyog Nagar  
Via. Anand  
Gujarat

388121

India

Contact: Mr Mehul Patel

Job Title: Managing Director

T: + 91 2692 235210

F: + 91 2692 236324

E: sales@anupamgroup.com

W: http://www.anupamgroup.com/

**SOME THINK  
LONG-DISTANCE  
TRANSPORT IS  
INFRASTRUCTURE-  
INTENSIVE.  
WE THINK  
DIFFERENT.**

Transporting materials from remote locations has traditionally required significant infrastructure investments in road or rail links, vehicles, personnel and fuel. BEUMER offers an economical, efficient and environmental alternative – long-distance overland conveying. This gives you a dedicated, around-the-clock transport link at the fraction of the cost of infrastructure development. The reduced noise and air pollution minimises environmental impact and improves personnel safety. Add to that a high degree of design flexibility and customisation and you can see why overland conveying makes a big difference to operational efficiency and environmental protection.

For more information, visit [www.beumergroup.com](http://www.beumergroup.com)



**BEUMER**

**ENEXCO**

BEUMERGROUP

**MADE  
DIFFERENT**



PRODUCT • QUALITY • EXPERIENCE • SERVICE

# GET THE SCOOP...

on why ANVIL has the best buckets in the market. ANVIL has a wide variety of performance engineered buckets in many sizes to fit all your needs.

***See why Anvil Buckets are built to last.***



225.654.8222 | 261 HWY 19 | SLAUGHTER, LA 70777

**[ANVILATTACHMENTS.COM](http://ANVILATTACHMENTS.COM)**



Round Nose Dredging  
Bucket - Model RN



4 Rope Gantry Style Coke  
Bucket - Model 4RD



Single Line Clamshell  
Bucket - Model PLSLR-1



## Anvil Attachments



PO Box 216  
261 Highway 19  
Slaughter  
Louisiana  
70777  
USA  
Contact: Mr Shane Toncrey  
Job Title: Marketing Director  
T: + 1 225 654 8223  
T: + 1 800 335 4722  
F: + 1 225 654 3125  
E: Sales@AnvilAttachments.com  
W: www.AnvilAttachments.com  
Manufacturer of grabs, grapples and clamshell buckets for cable, hydraulic and electro-hydraulic operation. Models for ships-gear, gantry, excavators, crawler cranes and hydraulic equilibrium cranes. Brands include Anvil, Hawco, Pro-line, Owen, Yaun, Williams & Drott. New, used, rentals, rebuilds, repairs, parts and service, since 1969.

## Arlona Engineering

PO Box 41125  
Rossburgh  
Durban  
KZN 4072  
South Africa  
Contact: Mr Steve Christy  
Job Title: Managing Director  
T: + 27 31 205 95 90  
F: + 27 31 205 98 35  
E: steve@arlon.co.za  
W: www.arlon.co.za  
Manufactures a range of bulk handling equipment, including radio remote control grabs and mobile bulk

hopper / conveyor systems for bulk carrier unloading.

## ATIC Services

91bis, rue du Cherche Midi  
Paris  
75006  
France  
Contact: Ms Marie-Pierre Lachaud  
T: + 33 1 536 338 63  
F: + 33 1 536 338 58  
E: info@atics.fr  
W: www.atics.fr

## ATIC Services

Level 20 - St Martin's Tower  
31 Market Street  
Sydney  
NSW  
2000  
Australia  
Contact: Ms Julie Forster  
Job Title: Agency Manager  
T: + 61 292 690 020  
F: + 61 292 618 241  
E: atics@atics.com.au  
W: www.atics.fr

## Atlas Manufacturing Co. Inc

PO Box 1969  
Monticello  
MS 39654  
USA  
Contact: Mr Ashley Watson  
Job Title: Sales Manager  
T: + 1 601 587 4511  
F: + 1 601 587 5393  
E: ashley@atlasmanufacturing.net  
W: www.atlasmanufacturing.net  
Atlas Manufacturing Company designs and builds high performance industrial clamshell buckets and grapples that meet and exceed strict

industry demands. Atlas is comprised of the most experienced staff in the industry, and committed to producing the finest, most reliable products in the business.

## AUMUND Foerdertechnik GmbH

Saalhoffer Strasse 17  
Rheinberg  
D-47495  
Germany  
Contact: Mr Heinrich Höse  
T: + 49 2843 720  
F: + 49 2843 60270  
E: info@aumund.de  
W: www.aumund.com  
The comprehensive product portfolio of AUMUND Foerdertechnik covers all bulk material handling and storage applications for the cement, lime and gypsum industry, mineral processing and mining, metallurgical plants and the power industry. Pan conveyors, Apron Feeders, Weigh Feeders, Bucket Elevators, Chain Conveyors, Surface Feeders, hopper and silo discharge equipment.

## Aurecon

PT Aurecon Indonesia  
Artha Graha Building 7th Floor  
Sudirman Central Business District - Lot 25  
Jl. Jend. Sudirman No 52 - 53  
Jakarta  
12190  
Indonesia  
Contact: Mr Jeff Tutticci  
T: + 62 21 5140 2470 ext 5000  
F: + 62 21 5140 2473  
E: tutticcij@ap.aurecongroup.com  
W: http://www.aurecongroup.com  
Multidiscipline Consulting Engineers specialising in the design of

infrastructure for efficient and innovative pit to port solutions.

## Aurecon

L10 - 55 Grenfell Street  
Adelaide  
South Australia  
5000  
Australia  
Contact: Mr Stephen Symons  
Job Title: Development Manager  
T: + 61 8 8237 9905  
F: + 61 8 8237 9778  
E: SymonsS@ap.aurecongroup.com  
W: www.aurecongroup.com

## Aurecon Hatch

L4, 152 Wharf Street  
Spring Hill  
Brisbane  
Queensland  
4000  
Australia  
Contact: Mr Graham Moody  
Job Title: Market Leader Coal Transport  
T: + 61 7 3173 8000  
F: + 61 7 3173 8001  
E: moodyg@aureconhatch.com  
W: www.aureconhatch.com

## Ausenco Sandwell

855 Homer Street  
Vancouver  
British Columbia  
V6B 2W2  
Canada  
Contact: Mr Joel A Cawker  
Job Title: VP International, Process Infrastructure  
T: + 1 604 638 4740 (direct)  
F: + 1 604 688 5913  
E: joel.cawker@ausenco.com

W: www.ausenco.com  
Ausenco Sandwell has planned and engineered port terminals and bulk systems for rates up to 16,000 t/h and vessels up to 500,000 dwt. EPCM services related to terminal design, truck dumping, crushing, screening, sampling, rail loadout, rail transportation, shiploaders, shipunloaders, railcar dumpers, conveyors, overland belt conveyors, transfers, storage, stackers, stacker/reclaimers and sophisticated simulation modelling are supplemented by the Company's ability to custom design materials handling facilities and equipment.

## AusGroup Limited

Head Office  
Level 2, 251 St Georges Terrace  
Perth  
WA  
6000  
Australia  
Contact: Laurie Barlow  
Job Title: CEO  
T: + 61 8 6210 4500  
F: + 61 8 6210 4501  
E: info@agc-ausgroup.com  
W: www.agc-ausgroup.com

## Avery Weigh-Tronix

Foundry Lane  
Smethwick  
West Midlands  
B66 2LP  
UK  
Contact: Ms Tory Manning  
T: + 44 870 903 4343  
F: + 44 870 920 0366  
E: info@awtxglobal.com  
W: www.averyweigh-tronix.com







# BEDESCHI

MACHINERY AND PLANTS FOR BRICK AND TILE FACTORIES AND THE CEMENT INDUSTRY. CRUSHING GROUPS AND BULK HANDLING EQUIPMENT. DRY BULK CARGO HANDLING TERMINALS



**BEDESCHI spa**

Via Praimbole, 38 - Limena (Padova) - Italy -  
Phone +39.049.7663100 - Fax +39.049.8848006 - [sales@bedeschi.it](mailto:sales@bedeschi.it) - [www.bedeschi.it](http://www.bedeschi.it)

**BEDESCHI AMERICA Inc.**

3275 W. Hillsboro Boulevard, Suite 312, Deerfield Beach - FL 33442 - USA  
Phone +1.954.6022175 - Fax +1.954.6025390 [info@bedeschiamerica.com](mailto:info@bedeschiamerica.com)



**Avplast Dis Tic. Ve Paz. Ltd. Sti.**

Egitim Mah. Kasap Ismail Sok.  
Avrasya Is Merkezi No:14 Kat:1  
D:24-  
34722 Hasanpasa / Kadikoy  
Istanbul  
81080  
Turkey  
Contact: Mr Hakan Avci  
T: + 90 216 338 32 31 - 347 38 54  
F: + 90 216 348 88 95  
E: sales@avplast.com.tr  
W: www.avplast.com.tr

**B & W Mechanical Handling Ltd**

Gemini House  
Cambridgeshire Business Park  
1 Bartholomew's Walk  
Ely  
Cambridgeshire  
CB7 4EA  
UK  
Contact: Mr Andy Blythe  
Job Title: Managing Director  
T: + 44 1353 665001  
F: + 44 1353 666734  
E: sales@bwmec.co.uk  
W: www.bwmec.co.uk  
B&W specializes in the design and manufacture of mobile equipment for surface installation. We offer a comprehensive range of Mobile Stackers and Shiploaders, along with the unique Samson receiving unit, designed to receive material fed by Tipper trucks and front loaders. The dust controlled B&W Eco-Hopper offers an eco-friendly and economical solution for material discharged from ship by grab cranes.

**B. A. G. Corp.**

11510 Data Drive  
Dallas  
Texas 75218  
USA  
Contact: Mr Matthew Simons  
Job Title: Marketing Director  
T: + 1 214 340 7060 ext 832  
F: + 1 214 340 7060  
E: matt@bagcorp.com  
W: www.bagcorp.com  
B.A.G. Corp. manufactures Super Sack® containers, woven polypropylene flexible intermediate bulk containers (FIBCs) for shipping, handling and storing of dry, flowable products. The B.A.G. Corp. family also includes: FIBC Recycling, Inc., reconditioning FIBCs in a closed-loop system, and Winzen Film and Fiber, Inc., manufacturing and distributing film, fiber and webbing.

**B+W Gesellschaft für Innovative**

**Produkte GmbH**

Musfeld str 120-122  
Duisburg D-47053  
Germany  
Contact: Mrs Dierkes  
T: + 49 203 552 1500  
F: + 49 203 552 1502  
E: export@buwip.de  
W: www.buwip.de

**Bagfilla SA Pty Ltd**

PO Box 34251  
Jeppestown  
Gauteng 2043  
South Africa  
Contact: Mr Alan Mason  
T: + 27 11 613 8024  
F: + 27 11 613 1080  
E: info@bucklepack.co.za  
W: www.bucklepack.co.za  
Suppliers of Bag Sewing and Heat sealing machines to close open mouth bags.

**Bayards Aluminium**

**Constructions**  
PO Box 9  
Nieuw-Lekkerland  
ZH 2957 ZG  
The Netherlands  
Contact: Mr Dick de Kluijver  
Job Title: Commercial Director  
T: + 31 184 683000  
F: + 31 184 684345  
E: dick.dekluijver@bayards.nl  
W: www.bayards.nl  
Bulk containers.

**Bedeschi SpA**

**BEDESCHI**  
Via Praitbole  
38 Limena  
Padova 35010  
Italy  
Contact: Mr Pietro De Michieli  
Job Title: Sales & Project Director  
T: + 39 049 766 3100  
F: + 39 049 884 8006  
E: sales@bedeschi.it  
W: www.bedeschi.it  
Material handling solutions such as stackers, reclaimers, ship loaders and ship unloaders plus crushing equipment.

**BEHN + BATES  
Maschinenfabrik GmbH & Co.  
KG**

Robert-Bosch-Strasse 6  
Munster D-48153  
Germany  
Contact: Ms Gabriele Buss  
T: + 49 251 9796 0  
F: + 49 251 9796 260  
E: sales@behnates.com  
W: www.behnates.com  
For more than 75 years we have specialised in the manufacture of packing machines for filling all kind of bulk products, especially food and pet food, into valve and open-mouth bags with filled weights of 1.5 up to 50 kg and big bags of up to 1,800 kg.

**Bekaert NV**

Product Group Steelcord  
Bekaert Street 2  
Zwevegem B-8550  
Belgium  
Contact: Mr Hans Desmet  
Job Title: Marketing  
T: + 32 9 3749 148  
F: + 32 9 3749 292  
E: hans.desmet@bekaert.com  
W: www.bekaert.com  
Bekaert is a leader in manufacturing of wire and wire products for a wide range of industrial and household applications. Steel cord is the best way to reinforce a tire, a conveyor belt. Bekaert produces conveyor belt cords and woven steel cord fabrics for conveyor belt reinforcement.

**Belt Equipment Supplies Sdn  
Bhd**

11-0-8  
Jalan 3/109F  
Danau Business Centre  
Taman Danau Desa  
Kuala Lumpur 58100  
Malaysia  
Contact: Mr K H Low  
Job Title: Managing Director  
T: + 60 3 7984 6099  
F: + 60 3 7984 6097  
E: belt@pc.jaring.my  
W: http://beltequipment.com.my  
Solutions for Bulk Handling, vacuum cleaning and logistic transportation.

**BELTANA Trading EK**

Sorenfeldring 27  
Hamburg 22359  
Germany  
Contact: Mr Jörg Heyenga  
T: + 49 40 6037456  
F: + 49 40 6037457  
E: info@beltana.de  
W: www.beltana.de  
Specialists in the supply of high-quality fabric and steelcord conveyor belts for handling bulk materials on horizontal, inclined and vertical conveyors. Flame retardant belts for coal mines and power plants. Interesting stocklots of new and second-hand belts.

**Bemo Rail BV**

Debbemeerweg 59  
Warmenhuizen 1749 DK  
The Netherlands  
Contact: Mr Theo Druif  
T: + 31 226 425 300  
F: + 31 226 421 916  
E: info@demorail.nl

**Benetech GmbH**

Karl Liebkrecht Str 27  
b. Leipzig  
Deuben DE-06682  
Germany  
Contact: Mr Frank Lippert  
Job Title: Managing Director  
T: + 49 34441 445 0  
F: + 49 34441 445 20  
E: benetech@gmx.de

**Benetech, Inc.**

1851 Albright Rd  
Montgomery IL 60538  
USA  
Contact: Mr Christopher F Blazek  
Job Title: Vice President, Marketing  
T: + 1 630 844 1300 x214  
F: + 1 630 844 0064  
E: blazeko@benetechusa.com  
W: www.benetechusa.com  
Benetech offers a range of engineering, equipment, and field services supporting your bulk-material handling and dust control needs. Benetech's equipment or turnkey solutions are geared to reducing risk and operating costs. Our Plant Professionals division provides operations consulting support.

**Bergu International AB**

Nygata 30  
Box 5006  
Helsingborg S-250 05  
Sweden  
Contact: Mr Conny Simonsson  
T: + 46 42 12 7970  
F: + 46 42 12 8002  
E: bergu@telia.com  
W: www.bergu.com  
Produces components for pneumatic conveying equipment.

**Beumer Group GmbH & Co KG**

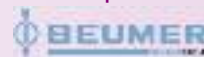

Oelder Strasse 40  
Beckum  
North-Rhine Westphalia  
59269  
Germany  
Contact: Dipl. Ing. Ulrich Hock  
Job Title: Director Sales  
T: + 49 2521 24 0  
F: + 49 2521 24 280  
E: BEUMER@BEUMER.com  
W: www.BEUMER.com  
The BEUMER group is a leading international manufacturer of intralogistic systems specializing in conveying, loading, palletizing and packaging technology as well as in sortation and distribution systems. Having approx. 750 employees and a turnover of around EUR 150 million, BEUMER has, with subsidiaries and representations, a worldwide presence for various industries.

**BGS Holland**

Hoogveeneweg 5  
Nieuwerkerk ad IJssel 2913 LV  
The Netherlands  
Contact: Ms Martina Hermans  
T: + 31 180 317838  
F: + 31 180 315538  
E: info@bgsholland.nl

W: www.bgsholland.nl  
Produces 'Choke Feed Scavenger' fittings for loadspouts to remove dust while loading bulk materials into ships, trucks or rail cars. Capacities range from 50 to 2000m3 per hour.

**Binder + Co AG**

Grazer Strasse 19-25  
Gleisdorf A-8200  
Austria  
Contact: Ms Almut Schnehen  
T: + 43 31 12 800 0  
F: + 43 3 112 800 300  
E: office@binder-co.at  
W: www.binder-co.com

**Birrus International Pty Ltd**

10 Dandenang Street  
Dandenong  
Victoria 3175  
Australia  
Contact: Mr Paul Shultz  
Job Title: Engineering Manager  
T: + 613 9769 2646  
F: + 613 9769 2535  
E: pshultz@birrus.com.au  
W: www.birrus.com.au

**BLUG Credeblug S.L.**



Juan XXIII - 9  
Azpetia  
Guipuzcoa 20730  
Spain  
Contact: Mr JR Zubeldia  
Job Title: Commercial Manager  
T: + 34 943 810 150  
F: + 34 943 815 665  
E: jrzubeldia@blug.es  
W: www.blug.es  
BLUG product range fits what the

Handling solutions  
CRANES & TENDERS

**BLUG**  
Credeblug, s.l.

AZPETIA (SPAIN)  
Tel: 0034-943810150  
Email: info@blug.es  
www.blug.es



**Strong partner in Grain Management.** One of the big challenges of our age is to supply all the people worldwide with food. Every year, millions of tons of grain are collected, stored, and handled around the globe – and the upward trend is unbroken. Only the most up-to-date plant and equipment can guarantee rapidity and quality while minimizing raw material losses. In order to meet the increasingly stringent challenges, Bühler Grain Logistics provides with its capabilities the best possible solution – for conveying, cleaning, drying, storing, dedusting or loading and unloading the most important commodity on earth.

Bühler AG, Grain Logistics, CH-9240 Uzwil, Switzerland  
T +41 71 955 11 11, F +41 71 955 3949  
grain-logistics@buhlergroup.com, www.buhlergroup.com



**Innovations for a better world.**







maritime bulk handling sector requires. Our handling solutions can be adapted to any kind of existing harbour crane. BLUG solutions go from automatic grabs, to 4-rope or electro-hydraulic high volume grabs that fit any crane, material and production requirements.

**BMT De Beer**

Guldenwaard 141  
Rotterdam  
3078 AJ  
The Netherlands  
Contact: Mr Jeroen de Haas  
Job Title: Managing Director  
T: + 31 10 479 0311  
F: + 31 10 479 1466

E: surveyors@bmtdebeer.com  
W: www.bmtdebeer.com  
BMT De Beer is one of the world's leading independent marine surveying companies, providing a wide portfolio of services in cargo, nautical and technical matters. The company offers a comprehensive array of marine services and brings an unprecedented level of expertise to every aspect of marine surveying.

**BMT Transport Solutions GmbH**

Karpfangerstr. 14  
Hamburg  
D 20459  
Germany  
Contact: Mr Tobias Merten  
Job Title: Logistics Consultant  
T: + 49 40 36 00 664 23  
F: + 49 40 36 00 664 29  
E: tm@bmt-ts.com  
W: www.bmt-ts.com

**Bogaert Transmission (GEHA)**

Industriepark  
Neringstraat 5

Londerzeel  
B-1840  
Belgium  
Contact: Mr Luc Vlieminckx  
T: + 32 52 31 23 55  
F: + 32 52 30 01 98  
E: info@bogaert-transmission.com  
W: www.bogaert-transmission.com  
Supply conveyor-chains and sprockets for the heavy industries eg cement, fertiliser, ore, coal, gypsum etc. Chains with breaking load of 300 tons. Manufacture sprockets to a diameter of 2 metres. Consult for replacement chains for bucket-elevators and en-masse scraperchains etc.

**Bonfanti srl**

Highway Briantea 4  
Ambivere  
24030  
Italy  
Contact: Mr Riccardo Losa  
T: + 39 035 908 911  
F: + 39 035 493 7049  
E: com@bonfanti.it  
W: www.bonfanti.it

**Bosch Rexroth AG**

Zum Eisengießer 1  
Lohr am Main  
97816  
Germany  
Contact: Mrs Julia-Jacqueline Klein  
T: + 49 9352 18 5519  
F: + 49 9352 40 4885  
E: Julia.Jacqueline.Klein@boschrexroth.de  
W: www.boschrexroth.com

**Bosch Rexroth B.V.**

Kruisbroeksestraat 1  
Boxtel  
Noord-Brabant

5281 RV  
The Netherlands  
Contact: Mr Edwin Doedee  
Job Title: Sales Manager, Materials Handling & Mining  
T: + 31 411 65 19 51  
F: + 31 411 65 14 83  
E: cylinders@boschrexroth.nl  
W: www.boschrexroth.nl  
Has a worldwide responsibility for turnkey projects and the development and production of Hydraulic Cylinders. Core competence is the development of engineered-to-order products, mostly one-off solutions for specific applications.

**Boyne Area Manufacturing (BAM)**

1 Altair Drive  
Boyne City  
MI  
49712  
USA  
Contact: Mr John Laursen  
Job Title: Director of Sales & Marketing  
T: + 1 231 459 4242  
F: + 1 231 459 4243  
E: jlaursen@boynearea-mfg.com  
W: www.boynearea-mfg.com  
Boyne Area Manufacturing (BAM) began in 2008 with over 40 yrs. in sales, design and engineering experience in bulk material handling. We have built loading equipment for trucks and trailers, railcars, barges and ships, and stockpiling. Our spouts, positioners, gates, wet&dry dust collectors, and air slides are the best value in the industry. Call us!

**Brelko Conveyor Products**

PO Box 62392  
Marshalltown

Johannesburg  
Gauteng 2107  
South Africa  
Contact: Mr Peter Ellis  
Job Title: Sales & Marketing Director  
T: +27 11 013 4000  
F: +27 11 013 4150  
E: peter@brelko.com  
W: www.brelko.com  
BRELKO develops, produces and markets a range of products for the bulk materials handling industry and provides an installation and maintenance service, including a 24-hour call out service. BRELKO products are intended to assist in the control of spillage, carryback and dust, as well as promoting trouble free flow of material at belt conveyor transfer and load points.

**Bretby Gammatech Ltd.**

Unit 4 Station Yard  
Station Road  
Melbourne  
Derbyshire  
DE73 8HJ  
UK  
Contact: Mr Paul Taylor  
Job Title: Managing Director  
T: + 44 1332 694594  
F: + 44 1332 865860  
E: Paul@BretbyGammatech.com  
W: www.bretbygammatech.com

**Bridgestone Industrial Limited**

Berliner Ring 89  
Bensheim  
64625  
Germany  
Contact: Mr John Hanson  
T: + 49 6251 690 396  
F: + 49 6251 690 397  
E: hanson.j@bridgestone-industrial.de  
W: www.bridgestoneindustrial.com

**Bridon International Ltd**

Balby Carr Bank  
Doncaster  
South Yorkshire  
DN4 5JQ  
UK  
Contact: Ms Jenny Ferguson  
Job Title: Marketing Assistant  
T: + 44 1302 309 265  
F: + 44 1302 382 263  
E: fergusonj@bridon.com  
W: www.bridon.com  
A world leader in the manufacture of high performance steel wire ropes for the industrial, mining, energy, marine and fishing markets. Bridon's strength and consistently superior quality products provide our customers with reliable and cost effective solutions in addition to the peace of mind of working with the world leader.

**Brock Grain Systems**

A Division of CTB, Inc  
611 N. Higbee Street  
PO Box 2000  
Milford  
Indiana  
46542-2000  
USA  
Contact:  
Job Title: Managing Director  
T: + 1 574 658 4191  
F: + 1 574 658 4133  
E: brock@ctbinc.com  
W: www.brockgrain.com

**BRUKS Klöckner GmbH**

Grabenstrasse 1  
Hirtscheid  
Nistertal  
D - 57647  
Germany  
Contact: Mr Markus Schwarz

T: + 49 26 61 28 167 +49 (0) 26 61 / 280  
F: + 49 26 61 28 180  
E: msz@bruks.com  
W: www.bruks.com

**BRUKS Rockwood Incorporation**

5975 Shiloh Road  
Suite 109  
Alpharetta  
GA  
30005  
USA  
Contact: Mr Ken Upchurch  
Job Title: Vice President of Sales & Marketing  
T: + 1 770 849 0100 x109  
E: kuh@bruks.com  
W: www.bruks.com

**BSG Resources**

36 Fricker Road  
Illovo Boulevard  
Illovo  
Johannesburg  
Gauteng  
2196  
South Africa  
Contact: Mr Frank Eagar  
Job Title: New Business Development  
T: + 27 11 3271 070  
F: + 27 11 3271 011  
E: frank@bsgresources.com  
W: www.bsgresources.com

**Bucket Mart Inc.**

PO Box 1240  
Marion  
Illinois 62959  
USA  
Contact: Mr Jack Johnson  
Job Title: President/CEO  
T: + 1 813 390 8626  
F: + 1 813 908 9474  
E: salesbucketmart@aol.com  
W: www.bucketmart.net  
New/Used All sizes/Types/Brands  
Clamshell Buckets/Grabs, Grapple Buckets/Grabs, HYD Buckets/Grabs, Radio Controlled Buckets/Grabs Buckets/Grabs

**Bühler AG, Grain Logistics**

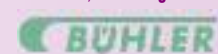

Gupfenstrasse 5  
Uzwil  
CH-9240  
Switzerland  
Contact: Mr Martin Stöckling  
Job Title: Head of Market Segment  
Terminals, GLTE1  
T: + 41 71 955 3290  
F: + 41 79 657 8920  
E: martin.stoeckling@buhlergroup.com  
W: www.buhlergroup.com/ch  
Customized solutions for grain handling. Bühler Grain Logistics Terminals is the ideal partner when it comes to reliable solutions in the area of grain handling and storage. The company's wide range of offerings includes ship loading and unloading solutions, conveying systems and silos as well as storage equipment.

**Buhler Grain Logistics**

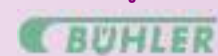

Eichstaetter Strasse 49  
Beilngries  
92339  
Germany  
Contact: Mr Tobias Daniel  
T: + 49 8461 701 324  
W: www.schmidt-seeger.com





# Beco Grabs

## Bulk Grabs



We are one of the world's leading specialists in grabs for the bulk-market and are certified in accordance with ISO 9001:2008. This fact of course is, largely due to our grab construction experience, innovation and world-wide supply through matching the bulk,- and dredging requirements. Let us prove that our solutions meet your highest demands.

#### OUR PROGRAM OF GRABS:

- Mechanical clamshells
- Electro-hydraulic clamshells
- Booms and Fronts
- Hydraulic clamshells
- Orange Peel grabs

From within our group of companies we can supply



Dump trailers  
Earth moving  
machine-equipment

**bulscar**  
CARGO SOLUTIONS



Beco Grabs \* P.O. Box 158 \* 4130 ED \* Vianen \* De Limiet 18 \* 4131 NR \* Vianen \* The Netherlands  
Telephone +31 (0)347-323100 \* Fax +31 (0)347-377780 \* E-mail: [info@becograbs.com](mailto:info@becograbs.com) \* Internet: [www.becograbs.com](http://www.becograbs.com)



## BULK JD

Oude Kassei 16  
Waregem B-8791  
Belgium  
Contact: Mr Xavier Goarnisson  
Job Title: Senior Sales Engineer  
T: + 32 479 40 49 75  
F: + 32 56 75 62 13  
E: xavier.goarnisson@bulkjd.be  
W: www.bulkjd.be

## Bulk Cargo Handling BVBA

Nijverheidskaai 28  
Bus 9  
Brussels 1080  
Belgium  
Contact: Mr Nicola Samyn  
Job Title: CEO  
T: + 32 477 44 98 81  
E: bch.belgium@gmail.com

## Bulk Lift International

1013 Tamarac Drive  
Carpentersville  
IL 60110  
USA  
Contact: Mr Brian Kelly  
Job Title: National Sales Manager  
T: + 1 847 428 6059 x 215  
F: + 1 847 428 7180  
E: brian@bulklift.com  
W: www.bulklift.com

## Bulk Logistic Landmark

403 Obaidulla Building  
Murraqqabad Road  
Deira  
Dubai  
UAE  
Contact: Mr Sanjeev Mathur  
Job Title: Country Manager  
T: + 971 4 224 9510  
F: + 971 5 541 5085  
W: www.bulklogisticlandmark.com

## BV Beco



De Limiet 18  
Vianen  
Utrecht  
4131 - NR  
The Netherlands  
Contact: Mr Henk van Vuren  
Job Title: Managing Director  
T: + 31 347 323 100  
F: + 31 347 377 780  
E: h.vanvuren@beco-vianen.nl  
W: www.becograbs.com  
Beco Grabs is one of the world's leading specialists for grab-equipment and is certified in accordance with ISO 9001:2008. We are able to fulfil the still growing demands for custom made grabs and/or specials as well as in the field of bulk material handling as in the field of dredging.

## ByM Agencia Martima

Coronel Pereira 72  
OF 1002  
Las Condes  
Santiago 1002  
Chile  
Contact: Mr Anogar Muschen V  
Job Title: Manager  
T: + 56 2 365 1197  
F: + 56 2 366 1267

## C. Christophel GmbH

Taschenmacherstr. 31-33  
Lübeck SH 23556  
Germany  
Contact: Mr Matthias Dammer  
Job Title: Sales  
T: + 49 43 66 88 48 20  
F: + 49 43 66 88 88 75  
E: mail@christophel.com  
W: www.christophel.com

## Cable Arm Inc

3452 W Jefferson Avenue  
Trenton  
Michigan  
48183 2939  
USA  
Contact: Mr Ray Bergeron  
Job Title: President  
T: + 1 734 676 6108  
F: + 1 734 676 1345  
E: info@cablearm.com  
W: www.cablearm.com  
Produces environmental and bulk handling grabs. These are available in double rope design for mobile cranes and in four rope versions for portal dockside cranes and gantries.

## Cachapuz Bilanciai Group

Parque Industrial de Sobreposta  
Apartado 2012  
Braga  
Braga  
4701-952  
Portugal  
Contact: Mr Nuno Matos  
Job Title: International Business Developer  
T: + 351 253 603 480  
F: + 351 253 603 485  
E: info@cachapuz.com  
W: www.cachapuz.com

## Calim Grab Industry

Piri Reis Cad  
Çınar San.  
Sitesi No:46 Maltepe  
Istanbul  
81540  
Turkey  
Contact: Mr Murat Calim  
T: + 90 533 226 4923  
F: + 90 216 399 79 71  
E: info@calimkepce.com  
W: www.calimkepce.com  
Calim Grabs is a manufacturer of mechanical, electro-hydraulic and remote controlled grabs. Other:

Lifting equipments C Hooks

## Camar Mill Systems Ltd

P.O. Box 419  
1600 King St N  
St. Jacobs  
Ontario  
N0B 2N0  
Canada  
Contact: Mr Rick Weber  
Job Title: President  
T: +1 519 664 3709  
F: +1 519 664 3700  
E: rick@camar.ca  
W: www.camar.ca  
Camar is an engineering leader, providing Total Project Engineering, Project Management and Process Automation. Marine grain terminals, feed mills and related process design and construction, from initial plan development through engineering, construction management and final commissioning.

## Cambelt International Corp

2820 West. 1100 South  
Salt Lake City  
Utah  
84104  
USA  
Contact: Mr Dave Hansen  
Job Title: VP, Sales  
T: + 1 801 972 5511 ext 205  
F: + 1 801 972 5522  
E: info@cambelt.com  
W: www.cambelt.com  
Manufacturer of high incline belt conveyor and mechanical bulk materials handling systems. Also produces 'Cambelt' automated reclaim systems for large volume dome storage systems.

## Capotex

Colombia 1  
Majadahonda  
Madrid  
28220  
Spain  
Contact: Mr Compere Benoit-Hervé  
Job Title: Export Manager  
T: + 34 91 634 71 92  
F: + 34 91 636 21 15  
E: export@capotex.com  
W: www.capotex.com  
CAPOTEX is the only company on a world level that exclusively specialises in covering belt conveyors. Our experience enables us to provide the market with a wide series of standard solutions, together with customised designs at very competitive prices.

## Carbonser, S. A. DE C. V.

Guillermo Gonzalez Camarena  
No. 1200 Piso 7  
Centro Ciudad Santa Fe  
DF  
01210  
Mexico  
Contact: Ing. Thomas Cortes  
Petersen  
Job Title: Director  
T: + 52 55 5246 7360  
F: + 52 55 5246 7391  
E: tcortes@techint.com.mx  
W: www.techint.com.mx  
Techint is the leader of the Consortium Carbonser for executing the BOT contract to handle up to 6 million tons of coal annually. Techint is a leading engineering and construction company operating worldwide. The services provided included the design, construction and operation of the coal terminal for 30 years starting from 1999.

**BLL** takes care of handling your bulk materials from production to consumption, including:

- Project feasibility study
- Consulting, design and engineering
- Equipment procurement and supply
- Supervision and technical assistance
- Technology transfer and implementation
- Training, performance monitoring

...and more

**BLL ... A sea of knowledge and expertise !**

www.bulklogisticlandmark.com • info@bulklogisticlandmark.com

**Your dry bulk material is our concern**

**Bulk Logistic Landmark** specializes in:

**Offshore:** floating cranes, floating terminal, self-discharging vessels and barges

**Onshore:** cranes, hoppers, grabs, conveyor belts, crushers, stackers, reclaimers, storage facilities, shiploaders



## CargoSpotter AS

Rådhusgaten 25  
Oslo  
0158  
Norway  
Contact: Mr Dagfinn A Mork  
Job Title: COO  
T: + 472 389 1053  
F: + 472 389 1054  
E: dagfinn@cargospotter.no  
W: www.cargospotter.no

## Cargotec Sweden AB, Marine Selfloaders



PO Box 914  
SE-745 25 Enköping  
Sweden  
Contact: Mats Sjöstedt  
Job Title: Sales Director  
T: + 46 171 232 00  
F: + 46 171 232 99  
E: susales.enk@cargotec.com  
W: www.cargotec.com  
Cargotec offers dry bulk handling systems for ship operators worldwide. Through the MacGregor brand, we provide complete self-unloading/loading systems for dry bulk carriers, integrated transloading solutions and bulk handling systems for offshore supply vessels - all designed to ensure efficient, flexible and environmentally-friendly

operation. The systems are tailor-made for each customer's particular requirements. Virtually any dry bulk material can be handled.

## Cargotec Sweden Bulk Handling AB



PO Box 566 Gunnarstorp  
SE-267 25 Bjuv  
Sweden  
Contact: Ms Emily Cueva  
Job Title: Communications Manager  
T: + 46 42 858 00  
F: + 46 42 858 99  
E: blksales@cargotec.com  
W: www.siwertell.com  
Cargotec offers efficient and environment-friendly ship unloaders, road-mobile unloaders, ship loaders and terminal conveying/reclaiming systems under the brand name Siwertell. All conveying systems are totally enclosed, reducing dust emission to a minimum.

## Carlsen

Van Polanenweg 2  
Krimpen aan de IJssel  
2921 LT  
The Netherlands  
Contact: Mr Cornelius Schouten  
T: + 31 180 440 720  
E: cs@carlsengroup.com  
W: www.carlsengroup.com

A leading expert in marine, offshore and onshore bulk handling systems. 50 years of design and engineering experience in equipping dry bulk ships, barges, supply vessels, harbor loading and unloading equipment, drilling rigs and floating terminals.

## Carmatec AB

Sporregatan 16  
Malmö  
Malmö  
S-213 77  
Sweden  
Contact: Mrs Carina Thern  
Job Title: Managing Director  
T: + 46 4014 07 90  
F: + 46 4014 07 99  
E: carina.thern@carmatec.se  
W: www.carmatec.se  
Our mission is to; - guide and partner you in the self unloading market for cement handling business - develop efficient and practical systems/ways to handle bulk materials - find new solutions for existing equipment - offer advice and service - develop and refine components and solutions for special services and applications.

## Carsurin

Sarana Penjaminan Building - 7th Floor  
LI Angkasa Blok B-9 Kav 6  
Kemayoran  
Jakarta  
10720

Indonesia  
Contact: Mr Tomtom Sukanto  
Job Title: Director Coal & Minerals  
T: + 62 61 661 8272  
F: + 62 21 654 0346  
E: dadan.hermawan@carsurin.com  
W: www.carsurin.com

## Caterpillar Belgium

Ave des Etats Unis  
Charleroi  
B6041  
Belguim  
Contact: Mr Philippe Michaux  
Job Title: Marketing  
F: + 32 71 25 29 56  
E: michaux\_philippe@cat.com

## Caterpillar Commercial Northern

### Europe

Phoenix Building  
Central Boulevard  
Solihull  
B90 8BG  
UK  
Contact: Mr William Spielmann  
Job Title: Industry Sales Representative  
T: + 44 1564 786466  
F: + 44 1564 786451  
E: Spielmann\_William@cat.com  
W: www.cat.com  
With 2011 sales and revenues of \$60.138 billion, Caterpillar is the world's leading manufacturer of construction and mining equipment, diesel and natural gas engines,

industrial gas turbines and diesel-electric locomotives. The company also is a leading services provider through Caterpillar Financial Services, Caterpillar Remanufacturing Services and Progress Rail Services.  
http://www.caterpillar.com

## Caterpillar Inc

100 NE Adams Street  
Peoria  
IL  
616-6335  
USA  
Contact: Mrs Sharon Holling  
Job Title: PR  
T: + 1 309 675 8995  
F: + 1 309 675 4757  
E: Holling\_Sharon\_L@Cat.com  
W: www.cat.com  
Caterpillar equipment product line, consisting of more than 300 machines, sets the standard for the construction industry. The company is also the world's largest manufacturer of medium-speed engines and high-speed diesel engines. The parts distribution network features 23 centres in 11 countries and 13 centres in the United States.

## Caterpillar SARL

Industrial Markets  
76, Route de Frontenex  
Geneva  
1206  
Switzerland





Siwertell 15 000 S road-mobile unloader discharging cement at 500tph in Spain



Unloader transported on trailer



Double bellows for efficient unloading



## Dry bulk handling. It's our expertise.

Siwertell **road-mobile ship unloaders** can easily be transported between different ports and it takes no more than 30-45 minutes to complete the folding and unfolding operation. Alternatively, road-mobile unloaders can be mounted on either a gantry or a stationary foundation turret in port. Cargotec offers three different sizes of road-mobile unloaders, with unloading capacities up to 550 tph.

Cargotec's Siwertell dry bulk handling systems use unique enclosed screw conveyor technology to ensure that dry bulk cargo operations are environmentally-friendly and efficient. All solutions are tailor made to suit the needs in each port or terminal.



# Dust Free Pneumatic Ship & Barge Unloading

- Grain
- Soybeans
- Small Seeds
- Corn
- Wheat
- Palm Kernel
- Barley
- Meal
- Urea

**Ship and Barge  
Unloading  
150-600 MTPH**



Christianson Systems offers flexible solutions for a wide range of material handling applications. State-of-the-art technology backed by over 50 years of experience assure that each machine is built with superior quality, construction, and design. Equipment recommendations are based on the customer's product, vessel size, capacity requirements, and power sources. By making the right choice, the customer will make the most of his money!



**Christianson Systems, Inc.**  
20421 - 15th Street SE  
PO Box 138  
Blomkest, Minnesota 56216 USA  
+1-320-995-6141 Telephone  
sales@christianson.com





Contact: Mr Nicolas Gomez  
 Job Title: Segment Specialist  
 T: + 41 22 849 4085  
 F: + 41 22 849 4986  
 E: gomez\_nicolas@cat.com

### Cavotec Deutschland GmbH

Ludwig-Erhard Strasse 1a  
 Eschborn  
 D-65760  
 Germany  
 Contact: Dipl.-Ing. Dirk Moll  
 Job Title: Managing Director  
 T: + 49 6196 50950 12  
 F: + 49 6196 50950 22  
 E: dirk.moll@cavotec.com  
 W: www.cavotec.com

### Cavotec Inc

124 Hatfield Road  
 Statesville  
 NC 28625  
 USA  
 Contact: Mr Erik Wilhelmson  
 Job Title: President  
 T: + 1 704 873 3009  
 F: + 1 704 873 3093  
 E: erik.wilhelmson@cavotec.com  
 W: www.cavotec.com

### Cavotec SA

Via S. Balestra 27  
 Lugano  
 CH-6900  
 Switzerland  
 Contact: Mr Michael Scheepers  
 Job Title: Director, Investor  
 Relations & PR  
 T: + 41 91 911 4010  
 F: + 41 91 922 54 00  
 E: michael.scheepers@cavotec.com  
 W: www.cavotec.com  
 Cavotec Group is a global leader in "Connecting mobile equipment".  
 Products from the Cavotec Group

manufacturing units include; EEX radio remote controls, electrical connectors up to 15kV, flexible cables, cable reels, slipring units. Distribution is supported by 29 Cavotec sales and service companies around the world.

### CDM Systems, Inc

430 Main Street  
 Elk River  
 MN  
 55330  
 USA  
 Contact: Mr Steve W Parker  
 T: + 1 763 428 9700  
 F: + 1 763 428 9701  
 E: steve@cdmsys.com  
 W: www.cdmsys.com  
 CDM Systems, Inc. offers a complete line of Mechanical Marine Leg Unloaders with mobile single leg capacities from 150 to 500 TPH (Stationary installations up to 1500 TPH.)

### Certex UK

Unit C1, Harworth Industrial Estate  
 Bryans Close  
 Harworth  
 Doncaster  
 DN11 8RY  
 UK  
 Contact: Mr. John Briggs  
 Job Title: Sales Director  
 T: + 44 845 230 7475  
 F: + 44 845 230 7476  
 E: sales@certex.co.uk  
 W: www.certex.co.uk

### Cesur Packaging Corporation

Yakacak Yanyol  
 Senem Sokak No:11  
 Kartal  
 Istanbul  
 34876

Turkey  
 Contact: Ms Cengiz Cesur  
 Job Title: General Manager  
 T: + 90 216 377 2855  
 F: + 90 216 377 1189  
 E: info@cesurpack.com  
 W: www.cesur.com

### CFS srl.

Unità Operativa  
 Via Sigalina a Mattina, 12/14  
 Montichiari  
 BS  
 25018  
 Italy  
 Contact: Mr Italo Civettini  
 Job Title: CEO  
 T: + 39 0309 64199  
 F: + 39 0302 072026  
 E: sales@cfshandling.it  
 W: www.cfshandling.it

### CH2M Hill

1100 112th Avenue NE  
 Suite 400  
 Bellevue  
 WA 98004  
 USA  
 Contact: Mr J Michael Zachary  
 Job Title: VP Dir of Ports & Intermodal  
 T: + 1 425 453 5000  
 F: + 1 425 462 5957  
 E: feedback@ch2m.com  
 Provides marine terminal engineering and planning as well as economic feasibility studies, environmental planning and construction management for the transportation industry.

### Changsha Kaiyan Instruments Co. Ltd

172 Kaiyuan Road  
 Changsha Economic &

Technological Development Zone  
 Changsha  
 410100  
 China  
 Contact: Ms Susan Wang  
 T: + 86 731 4012074 / + 86-731-84021617  
 F: + 86 731 4012074  
 E: susanky@chs5e.com  
 W: www.ckcic.net

### Chief Industries UK Ltd.

Beckingham Business Park  
 Tolleshunt Major  
 Maldon  
 Essex  
 CM9 8LZ  
 UK  
 Contact: Mr Geoff Freed  
 T: + 44 1621 868944  
 F: + 44 1621 868955  
 E: info@chief.co.uk  
 W: www.chief.co.uk  
 Chief Industries is an international company supplying grain storage systems throughout the world. Sizes of individual silo tanks range up to 30,000tons, with multiple silo complex sizes of several hundreds of thousand tons. Conveyors and ancillary equipment range up to 1600tph or more.

### China Huadian Engineering Co., Ltd.(CHEC)

South Gate, No 91  
 North Road  
 Xi San Huan  
 Beijing  
 100044  
 China  
 Contact: Mr Zheng Liu  
 Job Title: Director of Int. Mktg,  
 Material Handling Division  
 T: + 86 10 51 966647

F: + 86 10 68 710553  
 E: chec@chec.com.cn  
 W: www.chec.com.cn  
 Material Handling Division (MHD) is a core business unit of CHEC with over 200 qualified employees and over ten years experience. CHEC MHD is continuously expanding the application of bulk materials handling technologies (equipment and systems) for the market. MHD is ready to supply the optimized solution to your bulk materials handling project.

### China Sonangol International (S) Pte Ltd

9 Temasek Boulevard #42-01  
 Suntec Tower 2  
 Singapore  
 038989  
 Singapore  
 Contact: Mr Eugene Tan  
 T: + 65 6808 1880  
 F: + 65 6808 1881  
 E: sg@chinasonangol.com  
 W: www.chinasonangol.com

### CHL Equipment Ltd (incorp. Versteegen Grabs UK)

24 Solihull Road  
 Shirley  
 Solihull  
 West Midlands  
 B90 3HD  
 UK  
 Contact: Mr John Hinder  
 Job Title: General Manager  
 T: + 44 121 733 8100  
 F: + 44 121 733 2796  
 E: sales@chlequipment.com  
 W: www.chlequipment.com  
 CHL are the U.K. agents for the leading European manufacturers of material handling equipment. Whether your need is for ship unloading, moving concrete products, handling steel coils or scrap metal, we can provide the solution. We supply only the highest quality products to ensure durability, productivity, and economy for the lifetime of the equipment.

### Christianson Systems Inc.



20421 15th Street Southeast  
 Blomkest  
 Minnesota  
 56216  
 USA  
 Contact: Mr Mike Schow  
 Job Title: Sales Manager  
 T: + 1 320 995 6141  
 F: + 1 320 995 6145  
 E: sales@christianson.com  
 W: www.christianson.com  
 Builds pneumatic grain vacs for bulk grains and feeds. Full service supplier from design and manufacturing to installation and training. Christianson shipunloaders are installed in over 90 countries worldwide.  
 Trademarks/Brandnames include SuperTower, SuperPortable, Handlair, Vac-U-Vator, Chem-Vac, Seed Vac, VacBoss, Push Pac, AugerVac, Dunbar Kapple.





# Moduflex

- Dust free loading solutions
- Clean environment and working safety in one product



Chutes for loading any dry bulk material into tanker trucks, open trucks, rail wagons, ships and for stock piling. Loading chutes both with and without integrated filter.

Full ATEX-approval.



Cimbria Bulk Equipment A/S  
Drejervej 10  
DK-7451 Sunds  
Denmark

Tel: +45 72 42 24 00  
Fax: +45 72 42 24 99

E-mail: [cbe@cimbria.com](mailto:cbe@cimbria.com)

[www.cimbria.com](http://www.cimbria.com)



## Chronos BTH

Unit 1, Centurion Business Park  
Blenheim Industrial Estate  
Nottingham  
Notts NG6 8WN  
UK

Contact: Mr Mike Simmonds  
Job Title: Sales Director  
T: + 44 115 9351351  
F: + 44 115 9606941  
E: [info@chronosbth.com](mailto:info@chronosbth.com)  
W: [www.chronosbth.com](http://www.chronosbth.com)

Chronos BTH supply bulk weighers and controllers for intake / outloading free-flowing bulk materials. Complementing these is a range of material handling, bagging and palletising systems, and the Containerpak mobile bagging unit. Chronos BTH incorporates Richard Simon, BTH, Verville and Premier Tech Systems for European spares, refurbishments, service, installation / commissioning.

## Chronos BTH B V

Meerheide 40  
Eersel  
5521 DZ  
The Netherlands  
Contact: Mr Ingo Jonas  
Job Title: Managing Director  
T: + 31 497 51 49 88  
F: + 31 497 51 49 53  
E: [info@chronosbth.com](mailto:info@chronosbth.com)  
W: [www.chronosbth.com](http://www.chronosbth.com)

Chronos BTH supply bulk weighers and controllers for intake / outloading free-flowing bulk materials. Complementing these is a range of material handling, bagging and palletising systems, and the Containerpak™ mobile bagging unit. Chronos BTH incorporates Richard Simon, BTH, Verville and Premier Tech Systems for European spares, refurbishments, service, installation / commissioning.

## Chronos BTH GmbH

Löhestrasse 18  
Post Fach 1155  
Hennef  
D53773  
Germany  
Contact: Mr Ingo Jonas  
Job Title: Managing Director  
T: + 49 2242 9335 0  
F: + 49 2242 9335 186  
E: [info@chronosbth.com](mailto:info@chronosbth.com)  
W: [www.chronosbth.com](http://www.chronosbth.com)

Chronos BTH supply bulk weighers and controllers for intake / outloading free-flowing bulk materials. Complementing these is a range of material handling, bagging and palletising systems, and the Containerpak mobile bagging unit. Chronos BTH incorporates Richard Simon, BTH, Verville and Premier Tech Systems for European spares, refurbishments, service, installation / commissioning.

## CICSA & MCV s.r.l.

Via dell'Industria, 2  
Beverate di Brivio (LC)  
23883  
Italy  
Contact: Mrs Luisa  
T: + 39 0399 2732 12  
F: + 39 0399 2732 20  
E: [sales@cicsa.it](mailto:sales@cicsa.it)  
W: [www.cicsa-mcv.com](http://www.cicsa-mcv.com)

## Cimbria Bulk Equipment



Drejervej 10  
Sunds  
DK- 7451  
Denmark  
Contact: Mr Lars Noergaard  
Job Title: Managing Director  
T: + 45 72 42 24 00  
F: + 45 72 42 24 99  
E: [cbe@cimbria.com](mailto:cbe@cimbria.com)  
W: [www.cimbria.com](http://www.cimbria.com)

More than 30 years experience within developing and marketing Moduflex loading chutes and Contec screw conveyors for dustfree outloading and conveying of dry bulk material. The product programme covers all branches from agriculture to industry and solutions can be delivered for all applications within road & rail, shiploading & stockpiling.

## Clarke Chapman Manufacturing Ltd

P O Box 9  
Saltmeadows Road  
Gateshead  
Tyne & Wear  
Newcastle  
NE8 1SW  
UK  
Contact: Mr Nicholas Hancock  
Job Title: General Manager  
T: + 44 191 477 2271  
F: + 44 1225 332529  
E: [info@clarkechapman.co.uk](mailto:info@clarkechapman.co.uk)  
W: [www.clarkechapman.co.uk/](http://www.clarkechapman.co.uk/)

## Claudius Peters Technologies GmbH

Schanzenstrasse 40  
Buxtehude  
D-21614  
Germany  
Contact: Mr Matthias Raabe  
Job Title: Head of Sales, Projects & Marketing  
T: + 49 4161 706 349  
F: + 49 4161 706 270  
E: [mail@bmhclaudiuspeters.com](mailto:mail@bmhclaudiuspeters.com)  
W: [www.claudiuspeters.com](http://www.claudiuspeters.com)  
Product lines include grinding systems,

cement clinker coolers, storage and mixing silos, pneumatic conveying systems, ash removal systems, self-unloading vessels, packing and palletising systems, pulverised coal injection systems for blast furnaces. Building material product lines include natural and by-product gypsum processing systems for plants, wallboard production plaster and ceilingboard plants.

**Claudius Peters Technologies S.A.S**

34 Avenue de Suisse  
BP 269  
Illzach  
Cedex F-68316  
France  
Contact: Mr Jean Gaffet  
T: + 33 389 313 300  
F: + 33 389 313 339  
E: [technologiessa@claudiuspeters.com](mailto:technologiessa@claudiuspeters.com)  
W: [www.claudiuspeters.com](http://www.claudiuspeters.com)  
Product lines of stackers/reclaimers, blending beds, grab gantry cranes, shiploaders for bulk, shiploaders for bags, combined bulk/bag shiploaders, pneumatic ship-unloaders

**Cleveland Cascades Ltd**



Unit 22 Dukeway  
Teesside Industrial Estate  
Thornaby  
Stockton on Tees  
TS17 9LT

UK  
Contact: Mr Ian Barnard  
Job Title: Managing Director  
T: + 44 1642 753260  
F: + 44 1642 753270  
E: [enquiries@clevelandcascades.co.uk](mailto:enquiries@clevelandcascades.co.uk)  
W: [www.clevelandcascades.co.uk](http://www.clevelandcascades.co.uk)  
Has developed a new dustless shiploading chute that can operate without additional dust extraction systems. Suitable for most types of bulk material including highly dusty products such as cement clinker, alumina, phosphate and apatite.

**Clime SA**

c/- Castilla 52-54  
Barcelona  
08018  
Spain  
Contact: Mr John Climent  
T: + 34 93 307 6362  
F: + 34 93 308 5649  
E: [climesa@fibcnet.com](mailto:climesa@fibcnet.com)  
W: [www.fibcnet.com](http://www.fibcnet.com)

**Clough Limited**

6th Floor  
251 St Georges Terrace  
Perth  
Western Australia  
6000  
Australia  
Contact: Mr Max Bergomi  
Job Title: Executive General Manager – Business Acquisition  
T: + 61 8 92819281  
F: + 61 8 94816699  
E: [clough@clough.com.au](mailto:clough@clough.com.au)  
W: [www.clough.com.au](http://www.clough.com.au)  
A service provider of Project Management, Engineering and Construction Contracting services in the oil and gas (onshore and

offshore), petrochemicals, mining and minerals processing industries, infrastructure (including power and harbour works) and manufacturing sectors.

**CNBM International Engineering Co., Ltd.**

19th Floor, Building 4  
Interwest Business Center  
NO.9 Shouti South Road  
Beijing  
100044  
China  
Contact: Mr Wang Lin  
Job Title: Bulk Handling Division Manager  
T: + 86 10 68796130  
F: + 86 10 68796029  
E: [wanglin@cnmie.com](mailto:wanglin@cnmie.com)  
W: [www.cnbmengineering.com](http://www.cnbmengineering.com)  
CNBM Bulk Handling consists of unloading/loading (barge, railway car, truck), conveying, storing (silo, dome, stacker & reclaimer etc.) and optional systems. Both pneumatic and mechanical working principles are integrated into a customer-oriented solution upon specific situation. It can help you with either your in-plant transportation or your terminal establishment.

**CNK INTERNATIONAL LIMITED**

No.29 Building  
North Gongren Xincun  
Jinan City  
China  
Contact: Mr Kevin  
T: + 86 531 6880 0516  
F: + 86 531 6880 0516  
E: [sales@cnkcorporation.com](mailto:sales@cnkcorporation.com)  
W: [www.cnkcorporation.com](http://www.cnkcorporation.com)

**Coal & Mineral Technologies (SABS)**

1 Dr Lategan Road  
Groenkloof  
Pretoria  
Gauteng  
0001  
South Africa  
Contact: Mr Heinrich Williams  
Job Title: General Manager  
T: + 27 12 428 6328  
F: + 27 12 428 7795  
E: [heinrich.williams@sabs.co.za](mailto:heinrich.williams@sabs.co.za)  
W: [www.sabs.co.za](http://www.sabs.co.za)

**COBRA Europe SA**

12 rue Henry Guy  
BP 40081  
LUXEUIL les Bains Cedex  
70300  
France  
Contact: Mr E Mansour  
Job Title: President  
T: + 33 671 58 72 56  
F: + 33 384 40 44 92  
E: [emphone@cobra-cs.com](mailto:emphone@cobra-cs.com)  
W: [www.cobra-cs.com](http://www.cobra-cs.com)

**Coeclerici Logistics S.p.A.**

Piazza A. Diaz, 7  
Milan  
20123  
Italy  
Contact: Mr Andrea Clavarino  
Job Title: CEO of Coeclerici Logistics Spa  
T: + 39 02 6246 9451  
F: + 39 02 6246 9444  
E: [newprojects@coeclerici.com](mailto:newprojects@coeclerici.com)  
W: [www.coeclerici.com](http://www.coeclerici.com)  
One of the best known and most reputed companies in the field of offshore transloading operations. This achievement is based on the

dedication and commitment of the company towards its clients as well as being an integral part of their production chain with a view to long term relationships.

**Cofely Experts BV**

Computerweg 21  
PO Box 34  
Amsterdam  
1000 AA  
The Netherlands  
Contact: Mr John Visser  
Job Title: General Manager  
T: + 31 88 484 90 00  
E: [john.visser@cofely-gdfsuez.nl](mailto:john.visser@cofely-gdfsuez.nl)  
W: [www.cofely-gdfsuez.nl](http://www.cofely-gdfsuez.nl)

**Coles Associates**

PO Box 5096  
Dalkeith  
Western Australia  
6009  
Australia  
Contact: Mr Richard Coles  
Job Title: Manager Business Development  
T: + 61 8 9389 8484  
F: + 61 8 9386 5700  
E: [rcoles@colesassociates.com.au](mailto:rcoles@colesassociates.com.au)  
W: [www.shiploader.com.au](http://www.shiploader.com.au)

**Condepols**

Pozuelo de Alarcón  
Madrid  
28037  
Spain  
Contact: Mr Ignacio Baillo  
Job Title: Commercial Director  
T: + 34 91 337 7048 / +34 91 337 7040  
F: + 34 91 515 3172  
E: [ignacio.i.baillo@condepols.es](mailto:ignacio.i.baillo@condepols.es)  
W: [www.condepols.es](http://www.condepols.es)

**Cleveland Cascades Ltd**  
Setting the industry standard for loading solutions



**World Leader in the design & manufacture of bespoke retractable loading chutes for the handling of dry bulk materials.**

- Based in the UK, Cleveland Cascades Ltd has a dedicated team of experts in the design, assembly and commissioning of loading chutes and materials handling equipment.
- With a growing range of bespoke solutions for the handling of difficult dry bulk materials, our product range includes the unique 'cascade' concept, dust-controlled conveyor transfer points and dust-controlled hoppers.
- With over 500 reference installations operating worldwide, with applications in ship, silo, road, rail & tanker loading, the company's key to success is its proven ability to provide a well-engineered solution with professional and committed support.
- Winners of prestigious Queens Awards for Environmental Achievement, Export Achievement, and Enterprise in International Trades.



**Contact Cleveland Cascades Ltd**

Unit 22, Dukeway, Teesside Industrial Estate, Thornaby, Stockton-on-Tees, Cleveland, TS17 9LT, United Kingdom  
Tel: +44 1642 753260 | Fax: +44 1642 753270  
E-mail: [enquiries@clevelandcascades.co.uk](mailto:enquiries@clevelandcascades.co.uk) | Website: [www.clevelandcascades.co.uk](http://www.clevelandcascades.co.uk)



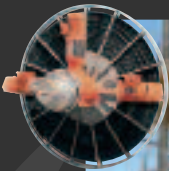

#### Motor Driven Reels

- Monospiral and Level-Wind configurations
- Rugged and dependable magnetic coupler for dusty environments



#### Cable Festoon

- Corrosion-resistant, long-life rollers; precision sealed bearings
- Systems customized for the application
- Preassembled option, for easy installation



#### Cable Chain

- Rugged design for demanding environments
- Long operating life
- Custom-configured

## Rugged Energy & Data Transmission Systems

Conductix-Wampfler has one critical mission: To keep your bulk material handling operations running 24 / 7 / 365. You need proven, worry-free energy solutions - and Conductix-Wampfler has them. Our systems provide reliable electric power and water to stacker/reclaimers, barge and ship loaders/unloaders, bulk conveyors, tripper systems, and gantry cranes. Conductix-Wampfler systems are rugged, low maintenance, and time-tested in tough, dusty environments. All products are backed by the largest sales and service network worldwide!

[www.conductix.com](http://www.conductix.com)



Condepols, Spanish Manufacturer of big-bags made of polypropylene to store or transport merchandise from 500 to 2000 kg and liners for maritime containers to transport merchandise in bulk.

## CONDUCTIX (Delachaux)

30 Avenue Brillat Savarin  
Belley  
01300  
France  
Contact: Mr Rene Ange  
T: + 33 4 79 42 50 00 / 71  
F: + 33 4 79 42 50 05  
E: range@delachaux.fr  
W: www.delachaux.fr

## Conductix-Wampfler Australia

14 England St  
Dandenong  
VIC  
3175  
Australia  
Contact: Mr Mark Howlett  
Job Title: Managing Director  
T: + 61 3 9706 8844  
F: + 61 3 9794 9298  
E: sales-australia@conductix.com  
W: www.conductix.com  
Previously named Insul-8 & now incorporating Wampfler. Designing & manufacturing in Australia for over 40 years. Products include conductor bars, cable festoon systems, cable and hose reels, slip rings, Kabelschlepp energy chain, push button pendants, radio controls, flexible cable, industrial buffers, Kiepe conveyor monitoring equipment and UEE high voltage couplers.

## Conductix-Wampfler AG

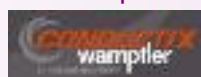

Rheinstrasse 27 + 33  
Weil am Rhein  
79576  
Germany  
Contact:  
T: + 49 7621 662 0  
F: + 49 7621 662 144  
E: info.de@conductix.com  
W: www.conductix.com  
Conductix-Wampfler is the world's leading supplier of energy supply and data transmission systems for moving machinery. All typical technologies for the transmission of energy and data are combined under one roof. Festoon systems, conductor rails, cable chains, spring cable reels, motorized cable reels, slip ring assemblies and contactless power transmission systems.

## Conductix-Wampfler Americas

10102 F Street  
Omaha  
Nebraska  
NE 68127  
USA  
Contact: Mr Mark Zuroske  
Job Title: Market Development Manager  
T: + 1 402 339 9300  
F: + 1 402 339 9627  
E: mark.zuroske@conductix.com  
W: www.conductix.us  
The leading global manufacturer of energy/data transfer systems for bulk material handling and mining equipment at mines, bulk terminals, and bulk storage facilities. Products include motorized cable reels, heavy

duty festoon systems, conductor bars, spring reels, radios and pendants.

## Conservatek Industries, Inc.

498 North Loop 336 East  
Conroe  
Texas  
77301  
USA  
Contact: Ms Nita Bailey  
T: + 1 936 539 1747  
F: + 1 936 539 5355  
E: nbailey@conservatek.com  
W: www.conservatek.com  
Conservatek engineers, fabricates and installs clear-span structural aluminum framing systems to which we attach glass, aluminum panels, translucent systems and standard roofing products. All have unique design characteristics that maximize interior and exterior usage of space by eliminating secondary structural support systems. We offer complete installed systems that allow architects unmatched design flexibility while utilizing a low-density aluminum grid framework.

## Continental Construction (Memphis)

5646 Shelby Oaks Drive  
Memphis  
Tennessee  
38134  
USA  
Contact: Mr Brian Morphis  
Job Title: Marketing  
T: + 1 901 382 4070  
F: + 1 901 388 2534  
E: mail@continentalconst.com  
W: www.continentalconst.com  
General Contractor specializing in Heavy Industrial construction. Marine

construction, driven pile foundations, and slip form concrete construction are just a few of the services that we offer. We have an impressive array of projects throughout our 30 years of experience.

## Continental Conveyor & Equipment Co Inc

PO Box 400  
438 Industrial Drive  
Winfield  
Alabama  
35594  
USA  
Contact: Mr Mike Roberts  
Job Title: Group Manager/Engineered Systems  
T: + 1 205 487 6492  
F: + 1 205 487 4233  
E: info@continentalconveyor.com  
W: www.continentalconveyor.com  
The Continental High Angle Conveyor (HAC) employs standard conveyor components and belts to utilise a simple but unique 'sandwich belt' approach to elevating and lowering materials at any angle, up to and including 90 degrees (vertical). The HAC® system can be located on a ship or in a loading area.

## ContiTech Transportbandsysteme GmbH

Breslauer Strasse 14  
Northheim  
D-37154  
Germany  
Contact:  
T: + 49 5551 702 0  
E: transportbandsysteme@cbg.contitech.de  
W: www.contitech.de/conveyorbelt  
As a technology leader, we are the

mining industry's development partner and original equipment supplier. Our conveyor belts around the world run reliably and economically, with respect for the environment. As systems supplier, we offer a full range of equipment and comprehensive service, from installation through to start-up.

## Control Systems Technology Pty Ltd

PO Box 249  
Revesby  
NSW  
2212  
Australia  
Contact: Mr Leonard Ian Burrell  
T: + 612 8708 0200  
F: + 612 8708 0280  
E: lburrell@controlsystems.com.au  
W: www.controlsystems.com.au  
Other Equipment: Specialist Ship Loading Belt Scales

## Coperion GmbH

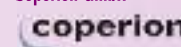

Niederbieger Straße 9  
Weingarten  
88250  
Germany  
Contact: Mrs Andrea Trautmann  
Job Title: Marketing Manager  
T: + 49 751 408 578  
F: + 49 751 408 99578  
E: andrea.trautmann@coperion.com  
W: www.coperion.com  
Coperion GmbH is the competent partner for all bulk materials handling solutions around and within the smelter. The company offers solutions to the aluminium producing industry

>compounding & extrusion >materials handling >service

>>Why we enjoy an unloading challenge. Because time is money and this is also very true when it comes to alumina and petcoke unloading. With our Vacuum Ship Unloader VSU, featuring leading-edge technology and our deep process know-how, we can guarantee short ship lay times and ensure gentle and reliable unloading of your product. That's what we mean when we say „confidence through partnership“ . >>www.coperion.com



> For unloading capacities up to 1.000 t/hr

> Double or single boom technology



INTRODUCING THE GLOBAL LEADER IN COVER SOLUTIONS.

# CST COVERS

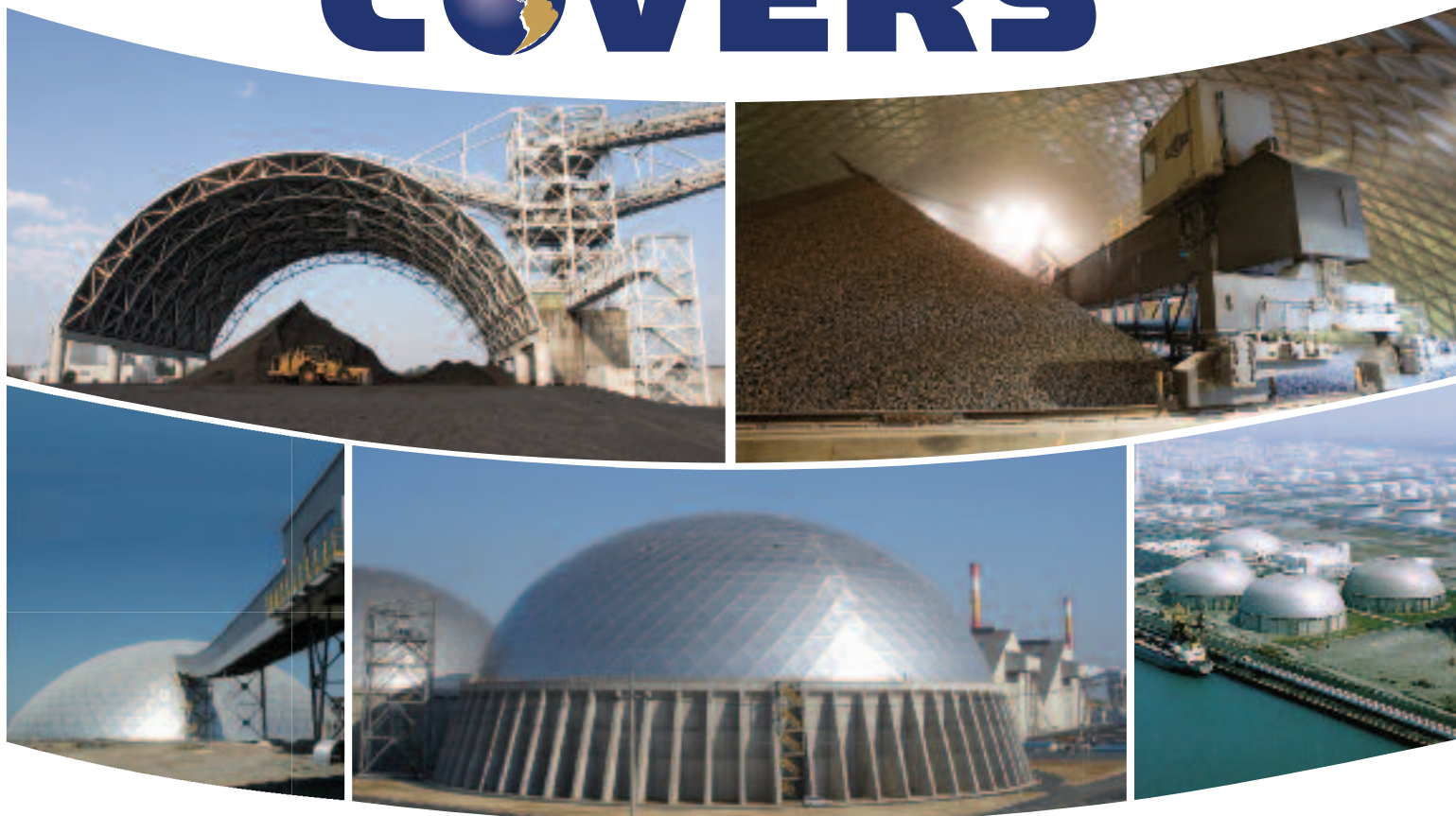

**TEMCOR** **CONSERVATEK**

**SINCE 1964 • OVER 16,000 INSTALLED • OVER 90 COUNTRIES**

### **Dry Bulk Storage Solutions**

- All-aluminum clear-span structures
- High strength-to-weight ratio
- Maintenance free – never rusts, rots, chips or solar degrades
- Economical installation – light weight translates to faster erection times and reduced erection costs
- Project support around the world

**[www.cstcovers.com](http://www.cstcovers.com)**

CST Covers | 498 N Loop 336 E | Conroe, TX 77301 USA | p: 936-539-1747 | f: 936-539-5355



that have proven to be extremely efficient and reliable. Coperion has the necessary expertise for every process stage along the entire process chain in manufacturing of primary alumina. In each process step, the challenges demand plenty of experience, specialist competence and flexibility.

**Cornell & Co Inc**

PO Box 807  
Woodbury  
New Jersey  
08096  
USA  
Contact: Mr B O Donnell  
Job Title: Equipment Sales  
T: + 1 856 742 1900  
F: + 1 856 742 8186  
E: bodonnell@cornell-co.com  
W: www.cornellcraneandsteel.com

**Cotesi SA**

Av. Mosteiro, 486  
Grijó  
4415-493  
Portugal  
Contact: Mr Ricardo Soares  
T: + 351 227 476 500  
F: + 351 227 646 575  
E: ricardo.soares@cotesi.com  
W: www.cotesi.com

**CPS Projects (Pty) Ltd**

PO Box 47261  
Greyville  
KZN  
4023  
South Africa  
Contact: Mr Banzi Majola  
Job Title: Managing Director  
T: + 27 31 466 4396  
F: + 27 31 466 4399  
E: banzi@cpsprojects.co.za  
Distributor supplies and services ship loaders and unloaders, stackers/reclaimers and grabs.

**Crippen Manufacturing Company**

400 Woodside Drive  
St Louis  
MI  
48880  
USA  
Contact: Mr Darren Losey  
Job Title: Manufacturing & Production  
T: + 1 989 681 4323  
F: + 1 989 681 3818  
E: info@crippenmfg.com

**CST Covers**



CST Industries  
9701 Renner Boulevard - Suite 150  
Lenexa  
Kansas  
66219  
USA  
Contact: Mr Tony Thill  
Job Title: Corporate Vice President  
T: + 1 913 748 4559  
F: + 1 913 621 2145  
E: tthill@cstindustries.com  
W: www.cstcovers.com  
Producers of corrosion-resistant aluminum dome storage facilities...over 8,000 domes have been completed in spans from 8m to over 135m world wide.

**CST Storage**

9701 Renner Blvd, Suite 150  
Lenexa

KS  
66110-2907  
USA  
Contact: Mr David Wheat  
Job Title: Director  
T: + 1 913 621 3700  
F: + 1 913 621 2145  
E: sales@cst-storage.com  
W: www.cstindustries.com  
Leading manufacturer of bolted and factory welded silos for dry bulk storage. Each silo, large or small, is individually engineered for its application. Custom engineering enables the selection of drive-through skirts, speciality hoppers, spread legs, passive flow control devices, tanks on load cells, peripheral conveyor supports, internal blending and interior maintenance platforms.

**CTI Group Inc**

Amman Regional Office  
Shmaisani, Layla Al-Akhyalieh  
Street  
Adli Commerical Center, 5th Floor  
P.O.BOX (7676)  
Amman  
11118  
Jordan  
Contact: Mr Nidal Miihyar  
Job Title: Senior Vice President  
Commercial  
T: + 962 6 5685 115  
F: + 962 6 5676 939  
E: nmiihyar@cti-grp.com  
W: www.cti-grp.com  
Established in 1990, our success has been achieved by hard work, professionalism, integrity, and long-term global partnerships. Current involvement includes: - Cement and Clinker Trading - Product Handling - Land and Sea Transportation - Terminal Construction and Operation (Shore or Floating) - Ship Owning and Ship Operating - Ship Management - Chartering

**CTP Team Srl**

Via Santa Maria in Campo, 1  
Cavenago di Brianza

Milano  
20040  
Italy  
Contact: Mr Antonio Zocche  
Job Title: Sales Director  
T: + 39 04 9766 3100  
F: + 39 04 9884 8006  
E: info@ctp.mi.it  
CTP Team, a Bedeschi Company, is a leading provider of gas cleaning and dedusting equipment and services, including filtration systems, electrostatic precipitators, heat exchangers and conditioning towers. We focus on process design, obsolete equipment upgrades and turkey projects.

**Cullen Grummitt & Roe**

126 Wickham Street  
Fortitude Valley  
Queensland  
QLD 4006  
Australia  
Contact: Mr Marco Necchi  
T: + 61 7 3252 8400 / +61 39 533 3208  
F: + 61 7 3252 5775  
E: cgrjld@cgrgroup.com  
W: www.cgrgroup.com  
Established in Brisbane, Australia in 1924 and provides consulting engineering services in the fields of civil and structural engineering, specialising in ports and harbour facilities, cold storage and mining infrastructure.

**Custom Equipment Design, Inc.**

1057 Highway 80 E  
Monroe  
LA  
71203  
USA  
Contact: Mr Fred H Moore  
Job Title: Sales Manager  
T: + 1 318 345 2222  
F: + 1 318 343 0452  
E: fmoore@cedpackaging.com  
W: www.cedpackaging.com  
Manufactures and distributes dry semi bulk packaging systems for bulk bags

(FIBC), drums, and big boxes. Associated equipment such as bulk bag (FIBC) Unloaders, Drum Dumpers, Pallet dispensers, conveyors and turntable conveyors are integrated together in systems complete with PLC Controllers or as independent stand alone components.

**Dalian Huarui Heavy Industry Group Co. Ltd**

No169 Bayi Road  
Dalian  
Liaoning  
China  
Contact: Mrs Yuli  
T: + 86 411 86852376  
F: + 86 411 86852398  
E: gmgs@dhdicw.com  
W: www.dhdicw.com.cn  
Dalian Huarui Heavy Industry Group Co., Ltd. (DHHI) is the holding subsidiary company of DHI-DCW Group, and the large and key leading enterprise in the heavy industry in China with leading products port machinery, hosting machinery, bulk materials handling machinery.

**Dantherm Filtration Ltd**

Limewood Approach  
Seacroft  
Leeds  
LS14 1NG  
UK  
Contact: Ms Karolina Szymanska  
T: + 44 113 2739 461  
F: + 44 113 265 0735  
E: kabo@danthermfiltration.com  
W: www.danthermfiltration.co.uk  
Dantherm Filtration designs, manufactures installs and services dust and fume extraction equipment worldwide, with production centres throughout Europe, in USA, Thailand and China. Installations include extraction for dockside hoppers, ship unloaders, conveying storage and outloading facilities. Filters, cyclones, silos, fans, discharge devices.  
ISO9001:2008, ATEX EN13980:2002.

**David Osborne Engineering Ltd**

Nene House, Drayton Way  
Drayton Fields  
Daventry  
Northamptonshire  
NN11 8EA  
UK  
Contact: Mr David Osborne  
T: + 44 1327 301199  
F: + 44 1327 300681  
E: david@doeng.co.uk  
W: www.doengineering.co.uk

**dbis**

9 Station Road  
Adwick-le-Street  
Doncaster  
South Yorkshire  
DN6 7BB  
UK  
Contact: Mr David Trueman  
Job Title: Sales Director  
T: + 44 1302 330 888  
F: + 44 1302 724 731  
E: david.trueman@dbis.biz  
W: www.dbis.biz

**DCC Grabs**

Markerkant 14-30  
Almere  
Flevoland  
1314AS  
The Netherlands  
Contact: Mr Rudy van Leeuwen  
Job Title: Director  
T: + 31 36 533 12 49  
F: + 31 36 529 85 94  
E: Info@dcc-grabs.nl  
W: www.dcc-grabs.nl  
DCC-Grabs designs, develops and manufactures grabs for the dry bulk cargo-, dredging- and recycling industry. DCC's main objective is to ensure that their grabs underscore added value for the client. Innovative design and product development are guaranteed at DCC-Grabs.





DCL

# LOAD WITH A LEADER



DUST CONTROL AND LOADING SYSTEMS, INC.

[WWW.DCLINC.COM](http://WWW.DCLINC.COM)



DCL, INC. • P.O. BOX 125 • CHARLEVOIX, MI 49720 • USA • 231-547-5600



**DCL, Incorporated**



PO Box 125  
 Charlevoix  
 MI 49720  
 USA  
 Contact: Mr Kyle Smith  
 T: + 1 231 547 5600 Ext 3124  
 F: + 1 231 547 3343  
 E: sales@dclinc.com  
 W: www.dclinc.com  
 DCL provides full dust control loading systems as well as partial components to the bulk material handling industry. Seasoned veterans in Technical Sales, Engineering and Manufacturing give DCL the capabilities of designing custom equipment to meet and understand all field applications. Product lines include Loading Spouts, Dust Collectors, Gates, Valves, and Air Conveyors.

**DCW Group Co**

350 Zhong Nan Road  
 Zhongshan District  
 Dalian  
 116022  
 China  
 Contact: Mr Lu Kaili  
 T: + 86 411 289 3900  
 F: + 86 411 289 1756  
 E: info@dalian-gov.net  
 Manufactures specialist 'Deadfall Discharge' ship loading systems fitted with dust control equipment, plugged spout relief doors and no moving parts.

**De Regt Conveyor Systems**

Ijzendijkseweg 5  
 Biervliet  
 Zeeland  
 4521 GX  
 The Netherlands  
 Contact: Mr Peter De Regt  
 Job Title: Director  
 T: + 31 115 481238  
 F: + 31 115 481234  
 E: peter@dereg.com  
 W: www.dereg.com  
 De Regt is a company specialized in developing, building and installing conveyor systems and structures needed to achieve a partial or total project.

**Dearborn MidWest Conveyor Co.**

4220 Shawnee Mission Pkwy  
 Suite 301B  
 Kansas City  
 Kansas 66205-2513  
 USA  
 Contact: Mr Sudy L Vohra  
 Job Title: Executive Vice President & General Manager  
 T: + 1 913 261 2406  
 F: + 1 913 261 2470  
 E: sudyv@dmwcc.com  
 W: www.dmwcc.com  
 Manufacturer of turnkey Bulk Materials Handling Systems for Terminals, Power Plants, Mines, Cement Plants, Iron Oxide and DRI handling. Latest products include Pipe Conveyors, Curved Conveyors Stackers And Reclaimers including Travelling Rotary Plow Feeders under piles and for Silo Reclaim Systems. Other Equipment includes Trippers, Belt Feeders and Telescopic Chutes. Complete materials handling for Gassification projects.

**Demag Cranes & Components GmbH**

Benefit recipient: Gottwald Port Technology  
 Forststrasse 16  
 Düsseldorf D-40597  
 Germany  
 Contact: Mr Reiner Derhardt  
 Job Title: Project Manager  
 T: + 49 2335 92 7442  
 F: + 49 2335 92 3812  
 E: reiner.derhardt@demagcranes.com  
 W: www.demagcranes-ag.com  
 Demag Cranes & Components GmbH - a subsidiary of Demag AG - is a supplier of industrial cranes and crane components for material flow, logistics and industrial drive applications. It also offers spare parts, maintenance and refurbishment services. Represented globally by approx 5,000 employees in 22 foreign subsidiaries and agencies in 46 countries. With more than 650,000 Demag brand cranes and hoists for industrial applications in operation, the company has the largest installed base worldwide.

**DeMarco Industrial Vacuum Corporation**  
 PO Box 1138  
 Crystal Lake

IL 60039-1138  
 USA  
 Contact: Mr Thomas DeMarco  
 Job Title: President  
 T: + 1 815 344 2222  
 F: + 1 815 344 2223  
 E: Sales@DeMarcoVacuums.com  
 W: www.DeMarcoVacuums.com  
 Manufacturers of MAX VAC industrial vacuuming and pneumatic conveying systems for the worldwide bulk handling industry. 5-300 hp.

**DemcoTECH Engineering**

Modderhouse  
 Moddercrest Office Park  
 1 High Street  
 Modderfontein  
 Gauteng  
 1645  
 South Africa  
 Contact: Mr Paul van de Vyver  
 Job Title: General Manager  
 T: + 27 11 608 4355  
 F: + 27 11 608 4251  
 E: info@demcotech.com  
 W: www.demcotech.com  
 DemcoTECH specialises in Bulk Material Handling and Conveyor Design, Niche Process Plants and Engineering Project Management. Servicing the Power Generation, Cement, Mining, Metallurgical, Food, Manufacturing and Port Industries. Providing the full range of services from Conceptual Design, through Feasibility Studies, Design, Engineering, Procurement, Expediting, Construction, Commissioning and After Sales Support.

**Dinnissen BV**

Horsterweg 66  
 Sevenum  
 NL-5975 NB  
 The Netherlands  
 Contact: Mr Henri A J M Michiels  
 Job Title: Director  
 T: + 31 77 467 35 55  
 F: + 31 77 467 37 85  
 E: powtech@dinnissen.nl  
 W: www.dinnissen.nl  
 Specialising in bulk transfer equipment. Product range includes batch weigh systems for powders, big bag emptying stations, big bag filling lines, powder mixers.

**DMN-WESTINGHOUSE**

Gieterij 3  
 PO Box 6  
 Noordwijkerhout  
 Zuid-Holland  
 NL-2210 AA  
 The Netherlands  
 Contact: Mrs Tonneke Krepel  
 Job Title: Manager Marketing Services and PR  
 T: + 31 252 361 800  
 F: + 31 252 375 934  
 E: dmn@dmn-nwh.nl  
 W: www.dmnwestinghouse.com  
 Design and manufacture of rotary valves, diverters and other components for the bulksolids handling industry. Besides an extensive range of standard versions, DMN-Westinghouse supply components that are pressure shock resistant to 10 bar, flame proof or ATEX compliant to Directive 94/9/EC.

**Dome Corp of North America**

5450 East Street  
 Saginaw  
 Michigan  
 48601  
 USA  
 Contact: Mr Ross Lake  
 Job Title: President  
 T: + 1 989 777 2050  
 F: + 1 517 777 3477  
 E: sales@dome-corp-na.com  
 W: www.dome-corp-na.com

**Dome Technology**

3007 East 49th Street North  
 Idaho Falls  
 Idaho  
 83401  
 USA  
 Contact: Mr Lane Roberts  
 Job Title: Sales Manager  
 T: + 1 208 533 6669  
 F: + 1 208 529 0854  
 E: lane@dometech.com  
 W: www.dometech.com  
 Provides a design build solution for all bulk storage products, for both industrial and commercial applications. We design reclaim tunnels, analyze and recommend deep foundation and soil solutions, material handling systems and coordination with the owner's engineers and suppliers. Products commonly stored include fertilizer, cement, clinker, gypsum, fly ash, coal, alumina, grains and mining ores. Inventors of the insulated thin shell concrete dome.

**DOMTEC International LLC**

4355 N Haroldsen Drive  
 Idaho Falls  
 Idaho  
 83401  
 USA  
 Contact: Mr Mike Hunter  
 Job Title: General Manager  
 T: + 1 208 522 5520  
 F: + 1 208 522 5344  
 E: domtec@domtec.com  
 W: www.domtec.com  
 Design and constructs concrete domes to store a multitude of products. Projects are delivered on time and within budget. Broad experience with a variety of reclaim systems, both mechanical and pneumatic, depending on clients' needs.

**Don Valley Engineering Co Ltd**

Sandall Stones Road  
 Doncaster  
 DN3 1QR  
 UK  
 Contact: Mr Roger Allen  
 Job Title: Managing Director

T: + 44 1302 881188  
 F: + 44 1302 881000  
 E: sales@donvalleyeng.com  
 W: www.donvalleyeng.com  
 Over 60 years of experience in all aspects of engineering, particularly the processing and handling of bulk materials, and the building of specialist screening, centrifuging and milling plant equipment. We are UK and global leaders in our fields, and a preferred supplier to all major producers and users of minerals, iron and steel, coal, sugar, potash and more.

**Donaldson Filtration (GB) Ltd**

Humberstone Lane  
 Thurmarston  
 Leicester  
 LE4 8HP  
 UK  
 Contact: Mr Geoff Hodgson  
 Job Title: Territory Manager  
 T: + 44 116 269 6161  
 F: + 44 116 269 3028  
 E: IAF-uk@donaldson.com  
 W: www.donaldson.com  
 Donaldson is a leading worldwide provider of filtration systems that improve people's lives, enhance our Customers' equipment performance, and protect our environment. We are a technology-driven company committed to satisfying our Customers' needs for filtration solutions through innovative research and development, application expertise, and global presence.

**Donaldson Filtration**

**Deutschland GmbH**  
 Büssingstraße 1  
 Haan  
 42781  
 Germany  
 Contact: Mrs Susanne Fulko  
 Job Title: Marketing Manager  
 T: + 49 21 29 569 0  
 F: + 49 21 29 569 100  
 E: IFS-de@donaldson.com  
 W: www.donaldson.com

**Doosan Benelux SA**

Drève Richelle 167  
 Waterloo  
 B-1410  
 Belgium  
 Contact: Ms Nancy De Sy  
 Job Title: Corporate and Public Communication Manager  
 T: + 32 2 371 6811  
 F: + 32 2 371 6900  
 E: nancy.desy@doosan.com  
 W: www.bobcat.eu;  
 www.doosanequipment.eu  
 Skid-steer loaders, compact tracked loaders; wheel loaders; excavators; rigid-frame and rotary telehandlers; attachments.

**Doppelmayr Transport Technology GmbH**

Holzriedstrasse 29  
 Wolfurt  
 6922  
 Austria  
 Contact: Mrs Stefanie Reis  
 T: + 43 5574 604 1206  
 F: + 43 5574 604 1209  
 E: dtt@doppelmayr.com  
 W: www.doppelmayr-mts.com  
 Doppelmayr Transport Technology solves all transport issues in the field of bulk materials and unit loads with a range of sophisticated material transport systems - from well-proven material ropeways to innovative long-distance conveyor systems for high capacities.



# THINK THIS IS NEW TECHNOLOGY? THINK AGAIN..



Australia  
Titanium Ore – 50°  
Mobile shiploader – 1000 t/h



Canada  
Diamond ore – 50°  
3 units – small footprint



Spain  
Green Pet Coke – 90°  
"S"- Shape



Canada  
Pebble Ore – 90°  
Ability to fit in tight space



DSI Snake Sandwich High Angle Conveyor elevating coal at a 75° angle for a steel plant in Northern Spain.

**Dos Santos International** is the world's foremost authority on high angle conveyor applications and design of sandwich belt high angle conveyors. With more than thirty years of materials handling and engineering experience, we offer the most advanced high tech conveying solutions. **BUT THE TECHNOLOGY ISN'T NEW.** DSI's high angle solutions have been proven time and time again to be the most reliable and economical solution in the industry.

The DSI Sandwich Belt High Angle Conveyor offers many advantages. It's **PROVEN** in over 100 installations worldwide. It's **RELIABLE** for rugged mining conditions, yet gentle enough for friable materials. It's **ECONOMICAL**, fitting into tight spaces and small footprints. Elevating millions of tons of material at various installations all around the world, users have agreed it's the most reliable, low cost and low maintenance conveyor system available. **Let us prove it to you.**

- **THE GREATER THE LOAD •**
- **THE HIGHER THE LIFT •**
- **THE BETTER WE LOOK •**

Dos Santos International  
531 Roselane Street NW Suite 810  
Marietta, Georgia 30060 USA  
T: +1 770 423 9895  
F: +1 866 473 2252  
<http://www.dossantosintl.com>



## DSH SYSTEMS – WE CARE ABOUT YOUR AIR!

Solve the world-wide industrial material handling problem – dust fallout while transferring dry, granular goods.

At the loading point, the DSH System concentrates the discharge of dry goods as a solid column through free air into any target repository including trucks, rail wagons, storage containers, bags or stockpiles.

The standard DSH Dust Suppression System uses no utilities and has no internal moving parts. PFC (computer controlled) model available.

Winner (joint) of the Inaugural Innovative Technology Award at BulkEx 2006.

Winner of the Dust Control Technology "Application or Practice" at BulkEx 2007.

The DSH System gives you:

- Cleaner, safer working environments
- Dust explosion risk mitigation
- Reduced maintenance, cleaning and dust handling
- Faster, continuous, cleaner loading of trucks and rail wagons
- Enables operation in closer proximity to urban areas
- Reduced product shrinkage.
- Reduced environmental agency concerns

Clients include companies handling fertilizers, grains, stock-foods, salt, sugar, sand, etc in Australasia, USA, Canada, South Africa, South America, and France.



ENQUIRIES  
**DSH SYSTEMS LTD**  
E: [info@dshsystems.com](mailto:info@dshsystems.com)  
T: +64 (0) 6 844 6894  
W: [www.dshsystems.com](http://www.dshsystems.com)

# Thank you

**...for proving us right. Advertising does work.**

To find out how you can benefit from advertising in the world's only monthly dry bulk publication contact Jason Chinnock or Andrew Hucker-Brown on Tel: +44 (0)1206 562560  
Fax: +44 (0)1206 562566 Email: [info@dc-int.com](mailto:info@dc-int.com)





**Dos Santos International, LLC**



531 Roselane Street  
Suite 810  
Marietta  
Georgia  
30060  
USA

Contact: Mrs Amy D. Duncan  
Job Title: Marketing Manager  
T: + 1 770 423 9895  
F: + 1 866 473 2252  
E: info@dossantosintl.com  
W: www.dossantosintl.com  
Materials handling and engineering specialists specialising in high-angle conveyors. We offer the DSI Snake Sandwich conveyor, the most reliable and economical solution for your high-angle and vertical, high tonnage requirements. Additionally we offer high-tech solutions. Our in-house proprietary software facilitates complete analysis of the most complicated conveying systems.

**Dosco Overseas Engineering Ltd**

Ollerton Road  
Tuxford  
Newark  
Nottinghamshire  
NG22 0PQ  
UK

Contact: Mr Phillip Adrych  
Job Title: Export Sales  
T: + 44 1777 870 621  
F: + 44 1777 871 580  
E: padrych@dosco.co.uk  
W: www.dosco.co.uk  
Manufacturers of an extensive range of pipe conveyors that transport materials in a totally enclosed environment eliminating any spillage and contamination of the surrounding area. Also manufactured are high torque, slow speed, twin roll crushers, incorporating picks or manganese teeth.

**Dosetec Exact Oy**

Vaakatie 37  
Nastola  
15560  
Finland  
Contact: Mr Pertti Hännikäinen  
T: + 358 3 871540  
F: + 358 3 8715410  
E: pertti.hannikainen@dosetec.fi  
W: www.dosetec.fi  
Dosing systems, sack filling and big bag FIBS filling system for food, chemical and building material industry.

**Doubrava Ges GmbH**

Industriestrasse 17-20  
Attnang-Puchheim  
A-4600  
Austria  
Contact: Mr Dietmar Holezius  
T: + 43 7674 6010  
F: + 43 7674 601499  
E: office@doubrava.at  
W: www.doubrava.at  
Specialises in batching, weighing and mixing plants, classifying and dressing plants, plants for ready mixed plaster and concrete; mechanical conveyors and ship-to-shore conveying systems.

**Doyle Manufacturing Co**

PO Box 3024  
Quincy  
Illinois  
62305  
USA  
Contact: Mr Monty Doyle



T: + 1 217 222 1592  
F: + 1 217 223 3655  
E: doyle@doylemfg.com  
W: www.4doyle.com

**Draka Automotive GmbH**

Dickestrasse 23  
Wuppertal  
42369  
Germany  
Contact: Mr Heribert Hoepfner  
T: + 49 20 22 960  
F: + 49 20 22 96 20 00  
E: automotive@draka.com  
W: www.draka-automotive.com

**DRC Engineering**

Srednegavansky 9-31  
Saint-Petersburg  
199226  
Russian Federation  
Contact: Mrs Mescherikova  
Nadezda  
Job Title: Director  
T: + 7 812 740 7426  
F: + 7 812 740 7429  
E: vyoukhnoe1@yahoo.com

**Dry Bulk Solutions**

Moezel Weg 110  
Harbour 5596  
Europoort - Rotterdam  
Zuid-Holland  
3198 LS  
The Netherlands  
Contact: Mr Gerrit Jan Gerritsen  
Job Title: Technical & Commercial Manager  
T: + 31 181 250 050  
F: + 31 181 261 466  
E: G.Gerritsen@elivesto.com  
W: www.drybulksolutions.com  
Dry Bulk Solutions offer products such as steelwiropees with special grab operation developed end connections. Furthermore we supply the High Performance Unloader, a machine to ease the tremming of rafters and stairs. Main benefit for our customers is cost reductions and safer work conditions!

**DS SM a/s**

Sonderjyllands Maskinfabrik  
Vaerksvej 5  
Roedekro  
6230  
Denmark  
Contact: Mr Martin N Nielsen  
Job Title: Project Manager  
T: + 45 74 39 33 33  
F: + 45 74 39 33 39  
E: mani@ds-sm.dk  
W: www.ds-sm.dk  
Manufactures conveyor plants for coal processing, including hoppers.

**DSH Systems Ltd.**



PO Box 5074  
Napier  
4145  
New Zealand  
Contact: Mrs Judi Schwass  
Job Title: Admin/Marketing  
T: + 64 274 955 754  
F: + 64 6 844 6894  
E: info@dshsystems.com  
W: www.dshsystems.com  
DSH Systems produce unique loading spouts for dry, granular, free-running goods. Dust is contained within a tight solid column through free air into any target repository. The DSH System requires no utilities, has no internal moving parts and provides Health & Safety, Environmental and commercial benefits.

**Dulevo International S.p.A.**

Via Giovannino Guareschi 1  
Fontanellato  
Parma  
43012  
Italy  
Contact: Mr Stefano Battistini  
T: + 39 0521 827733  
E: info@dulevo.com  
W: www.dulevo.com

**Dunlop Conveyor Belting**

Oliemolenstraat 2  
PO Box 14  
Drachten  
9200 AA  
The Netherlands  
Contact: Mr Andries Smilda  
Job Title: Sales & Marketing Director  
T: + 31 512 525555  
F: + 31 512 524599  
E: marketing.drachten@dunlopbc.com  
W: www.dunlopconveyorbelting.com  
Dunlop have both the largest range and biggest stock of cargo handling belts. The range includes belts with outstanding qualities of abrasion, tear and impact resistance. The unique Dunlop EBS closed conveyor belting system allows flexible routing and excellent dust control. Unrivalled technical support. 24 hour helpline + 31 620 498831.

**Duro Felguera Plantas Industriales, S.A.**

Centro de Ingeniería, I+D+i y calidad  
Parque Científico Tecnológico  
C/ Ada Byron 90  
Gijón  
Asturias  
33203  
Spain  
Contact: Mr Angel Pelegry  
Job Title: Ph. D. Mining Engineer.  
Sales Manager  
T: + 34 985 199 201  
F: + 34 985 199 059  
E: dfpi@durofelguera.com  
W: www.durofelguera.com  
A one hundred-year-old company specialised in turn-key projects for the bulk handling sector. Its great experience enables the company to develop state of the art designs and achieve high performance as well as run all the projects based on environmentally friendly solutions and competitive costs.

**Dust Control Technology**

1607 W. Chanute Rd.  
Peoria  
IL  
61615  
USA  
Contact: Mr Rick Felde  
Job Title: Marketing Manager  
T: + 1 309 693 8600  
F: + 1 309 693 8605  
E: info@dustboss.com  
W: www.dustboss.com  
DustBoss® dust suppression equipment combines an oscillating ducted fan with proprietary atomized misting technology to create a powerful, yet customizable dust control tool. DCT delivers superior results by specializing in open-area dust management. Largest model can blanket 280,000 SF (26,000 SM) with millions of droplets optimized for trapping dust particles.

**Dust Solutions Inc.**

14300 N.E. 20th Ave.  
D102-185  
Vancouver  
Washington  
98686  
USA  
Contact: Mr David Gilroy  
Job Title: Sales Manager  
T: + 1 360 546 0072  
F: + 1 360 546 0073  
E: d.gilroy@nodust.com  
W: www.nodust.com  
D.S.I manufactures Dry Fog Dust Suppression Systems. For ship loaders/unloaders, conveyor transfer points, truck & rail dump/fill stations, feeders & crushers. Modular System, No Chemicals, No Product Wetting, No Freezing. Ideal for Coal, Coke, Copper & Iron Ore, Woodchips, Cement, Clinker. DustTamer™ Wind Fence Systems to protect storage piles/load points.



“Unloading your coal  
up to 2,500 TPH  
for the lowest cost per  
ton in the industry.”



[www.e-crane.com](http://www.e-crane.com)

**E-CRANE**<sup>®</sup>  
EQUILIBRIUM  
Worldwide



**E Buttimer & Co. Ltd**



Carrigeen Industrial Estate  
Cahir  
Co. Tipperary  
Republic of Ireland  
Contact: Mr Eddie Buttimer  
Job Title: Director  
T: + 353 52 744 1377  
F: + 353 52 744 1087  
E: info@buttimer.ie  
W: www.buttimer.ie  
Engineers and manufacturers of purpose built equipment for environmental control, handling and storage of cereals, grains, fertilizer and mined materials.

**E-Crane World Wide**



Koekoeklaan 53  
Adegem  
B-9991  
Belgium  
Contact: Mr Bas Tolhuizen  
Job Title: International Sales Manager  
T: + 31 165 320100  
F: + 31 165 320759  
E: bas.tolhuizen@e-crane.com  
W: www.e-crane.com  
E-Crane@ Worldwide designs and builds high volume bulk material and scrap handling balance cranes ideal for (un)loading barges and seagoing vessels in the most economical way.

**E-Crane World Wide / E-Crane International USA**



1332 Freese Works Place  
Galion  
Ohio  
44833  
USA  
Contact: Mr Mark W Osborne  
Job Title: President  
T: + 1 419 468 0090  
F: + 1 419 468 0074  
E: mark.osborne@e-crane.com  
W: www.ecrane-usa.com  
Hydraulic, balanced, bulk material handling cranes from 5.5 to 43 tons, 19 meters to 45 meters reach. ECI imports, markets and supports the E-Crane in the Americas. ECI offers complete material handling solutions including the E-Crane.

**E-Crane Worldwide-Indusign NV**



Koekoeklaan 53  
Adegem  
B-9991  
Belgium  
Contact: Mr Lieven Bauwens  
Job Title: Managing Director  
T: + 32 9378 0444  
F: + 32 9378 0645  
E: lieven.bauwens@indusign.be  
W: www.e-crane.com  
E-Crane@ Worldwide provides design services as well as complete machine

production, erection, support, and training with on-going service for the heavy equipment industry. E-Crane® is a modern, state-of-the-art engineering and heavy equipment construction company, located at Adegem, Belgium. E-Crane® is the world leader for large scrap handling machines with an outreach from 24 to 50 meters

**ECS Eurocargo Services AS**

Tongavej 19  
Arhus C  
DK-8000  
Denmark  
Contact: Mr Peterson  
T: + 45 86 20 82 20  
E: ecs@eurocargoservices.dk  
W: www.eurocargoservices.dk

**EIFFEL Etablissement SOMDEL**

80 bis rue Jean Jaurès  
Quievrechain  
F-59920  
France  
Contact: Mr Gérard Pellez  
Job Title: (see ed notes)  
T: + 33 32 714 1516  
F: + 33 32 714 1515  
E: contact.somdel.eiffel@eiffage.com  
W: www.eiffel.fr  
Specialised in the provision of tailor made lifting and handling equipment. The range of products extends from EOT for steel plants, nuclear power plants and gantry cranes to ship loaders, ship unloaders, stackers and reclaimers, conveying systems and turnkey installations.

**Elecon Engineering Company**

**Ltd**  
Post Box # 6  
Anand Sojitra Road  
Vallabh Vidyanagar  
Gujarat  
388 120  
India  
Contact: Mr H S Patel  
Job Title: General Manager (Projects & Marketing)  
T: + 91 2692 237016 / 227131  
F: + 91 2692 236457  
E: hspatel@mhe.elecon.com  
W: www.elecon.com  
Elecon since established in 1951, apart from Power Transmission Products, provides engineered solutions, manufactures and supplies Bulk Material Handling Plants, Stockyard Equipments and Pipe Conveyor for the core sector industries which include power, steel, cement, fertilizer, port mechanisation and open cast mines in India and abroad.

**Elecon Singapore PTE Ltd.**

10, Anson Road  
#24-03  
International Plaza  
Singapore  
079903  
Singapore  
Contact: Mr Keyur Parikh  
Job Title: Director - VP  
T: + 65 6227 8258  
F: + 65 6227 8942  
E: keyur@singapore.elecon.com  
W: www.elecon.com

**Electro-Motive Diesel (EMD)**

**Inc**  
9301 West 55th Street  
La Grange  
IL 60525  
USA  
Contact: Mr Scott Garmin  
T: + 1 708 387 3938  
F: + 1 708 387 6626  
E: frank.w.ward@EMDiesels.com  
W: www.EMDiesels.com

**Elgin Engineering and Construction**

Suite 1800  
222 South Riverside Plaza  
Chicago  
Illinois  
60606  
USA  
Contact: Mr Bob Williams  
Job Title: Marketing Director  
T: + 1 312 236 8100 ext: 340  
F: + 1 312 726 2872  
E: soros@elginindustries.com  
W: www.elginindustries.com  
Designs, rehabilitates and upgrades port and harbour facilities, bulk and general cargo handling systems and equipment.

**Emaq-Verolme Estaleiros SA**

Rua Quatis 426  
426 liha do Governador  
Rio de Janeiro  
RJ 21920  
Brazil  
Contact: Mr I Fonseca  
Job Title: Sales Dept  
T: + 55 21 392 8029  
F: + 55 21 396 4126



- **Dockside Unloading Hoppers**
  - Mobile (DML), Rail (RML), Stationary (SML)
  - Full range of dust control options
  - Mobile units complete with hydraulic suspension units
- **Port Engineering/Design**
- **Ship Loaders/Product Stackers**
- **Intake Systems**
- **Conveyors**
- **Storage**



Contact **Buttimer Ireland...**

Carrigeen Industrial Estate,  
Cahir, County Tipperary, Ireland  
www.buttimer.ie e-mail: info@buttimer.ie  
Tel: +353 52 7441377 Fax: +353 52 7441087



# EUROMECC

s.r.l.



EUROHYDROMECC

fSOMMECC



[www.euromecsr.info](http://www.euromecsr.info)

**ELECTROHYDRAULIC**  
and **MECHANICAL**  
grabs & buckets

Via Visano, 78/80 - 25010 ISORELLA (Brescia) Italy Sales Dept: Tel: +39 030 9958151 na. - Fax +39 030 9952223  
E-mail: [info@euromecsr.info](mailto:info@euromecsr.info) - [sales@euromecsr.info](mailto:sales@euromecsr.info)

## If you're reading this....

...then so, very probably, are your customers!

To find out how you can benefit from advertising in the world's only monthly dry bulk publication contact Jason Chinnock or Andrew Hucker-Brown on Tel: +44 (0)1206 562560 Fax: +44 (0)1206 562566 Email: [info@dc-int.com](mailto:info@dc-int.com)

**DCI** **DRY CARGO**  
*international*



## EMDE INDUSTRIE-TECHNIK

PO Box 1339 Koppelheck  
Nassau-Lahn  
56377

Germany

Contact: Mr Hansjürg Emde  
Job Title: Managing Director  
T: + 49 2604 97030  
F: + 49 2604 970333  
E: info@emde.de  
W: www.emde.de

Produces a wide range of material handling systems, including control systems, process automation equipment and FIBC emptying and filling equipment.

## EMS-TECH Inc

699 Dundas Street West  
Belleville  
Ontario  
K8N 4Z2  
Canada

Contact: Ms Gail Carl  
Job Title: Executive Assistant,  
Sales & Marketing  
T: + 1 613 966 6611  
F: + 1 613 966 6710  
E: sales@ems-tech.net  
W: www.ems-techinc.com

A multi-task, multi-discipline company specialising in design and supply of dry bulk material handling equipment, both mobile and stationary; including custom designed conveyors; elevators; receiving hoppers; storage/loadout systems; environmental controls; shiploaders; stackers and reclaimers; self-unloading ships.

## EMS-TECH Inc.

Robijnstraat 92  
Alkmaar  
1812RB

The Netherlands

Contact: Mr Luke Huitema  
T: + 31 251 291 340  
F: + 31 251 291 344

E: europe@ems-tech.net  
W: www.ems-techinc.com  
A Multi-task, multi-discipline company specializing in design and supply of dry bulk material handling equipment, both mobile and stationary; including conveyors, belt elevators, receiving hoppers, storage/loadout systems, environmental controls, shiploaders, stackers and reclaimers, self-unloading ships.

## EMTICI Engineering Co Ltd

68 Sarat Bose Road  
Calcutta  
West Bengal

700025  
India

Contact: Mr D Sen  
T: + 91 33 24761861  
F: + 91 33 24761831

E: dsen@calemtici.elecon.com  
W: www.elecon.com

## Enclosed Bulk Systems BV

Wijkemeer Weg 72  
Beverwijk  
1948 NX

The Netherlands

Contact: Mr Van der Zee  
T: +31 85 877 4026  
E: info@enclosedbulk.nl  
W: www.enclosedbulk.com

## Enco Engineering Inc

4410 13th Street  
Wyandotte  
MI

48192  
USA

Contact: Ms Bobbi Lang

T: + 1 734 407 2400 x 202  
F: + 1 734 676 3436  
E: enco@encoeng.com  
W: www.encoeng.com

Specialises in the custom design of material handling systems to fit the unique characteristics of bulk material handling application. Experienced staff and engineering are dedicated in helping to meet the demands of an increasingly competitive world market.

## Endress + Hauser Inc

2350 Endress Place  
Greenwood  
IN  
46143  
USA

Contact: Mr Victor Wolowec  
T: + 1 317 535 1410  
F: + 1 317 353 1481  
E: info@us.endress.com  
W: www.us.endress.com

Offers process control devices and measurement systems for industrial applications including level, flow, pressure, tank gauging, temperature and liquid analysis.

## Engicon nv

Broelstraat 20  
Harelbeke  
B-8530  
Belgium

Contact: Mr Pieter Van Acker  
Job Title: Sales & Marketing  
Director

T: + 32 56 73 21 21  
F: + 32 56 73 40 40  
E: sales@geldof.be  
W: www.geldof.be

Offers complete solutions in bulk handling systems. Product range includes silos with extraction systems, discharge hoppers, pressure vessels and storage tanks, conveyor belts, screw conveyors, chain conveyors, bucket elevators.

## Engineering System Solutions

4943 North 29th East, Suite A  
Idaho Falls  
ID 83401  
USA

Contact: Mr Jason South  
T: + 1 208 552 9874  
F: + 1 208 552 9302  
E: jason@es2eng.com

## Enso-Gutzeit Oy

Logistic Services  
PO Box 62-63  
Kotka

48101  
Finland

Contact: Mr Alexandre Nicolini  
Job Title: Senior VP Sales and  
Marketing

T: + 358 2046 112  
F: + 358 2046 254 87  
E: vesa.sarkinen@storaenso.com  
W: www.storaenso.com/

## Entecon UK Ltd

8 Lawrence Way  
Camberley  
Surrey

GU15 3DL  
UK

Contact: Mr Kees Wilschut  
Job Title: Managing Director  
T: + 44 1276 414 540  
F: + 44 1276 414 541

E: entecon@entecon.co.uk  
W: www.entecon.co.uk

## Enviro Abrasion Resistant

### Engineers Pvt. Ltd

"ENVIRO HOUSE", Sector-27  
Plot No. F/12

Near Sambhaji Chowk  
Pradhikaran  
Pune

411044  
India

Contact: Mr Milind Dixit  
T: + 91 20 27641757  
F: + 91 20 27650316  
E: info@enviroabrasion.com  
W: www.enviro-abrasion.com

## EPMC Europe BV

Nieuw Zeelandweg 20  
Amsterdam  
1045 AL

The Netherlands

Contact: Ms Yolanda Los  
Job Title: PA to CEO  
T: + 31 20 6069900  
F: + 31 20 6069911

E: y.los@ZPMceurope.com  
W: www.epmceurope.com  
European crane parts agent for ZPMC  
Shanghai. Service and maintenance  
harbour cranes.

## EQ Trade

Rijsdijk Equipment Trade BV  
Droogdweg  
Waalhaven Oostzijde 119  
Rotterdam

BM  
3087

The Netherlands

Contact: Mr Kees Keetels  
T: + 31 62182 36 79  
F: + 31 10 487 3477  
E: keetels@eq-trade.com

## EQUIPO LLC

Salahudeen Road  
Dubai  
64624  
UAE

Contact: Mr Mohamad Yasar  
Aboobackar  
Job Title: Operations & Sales  
Manager

T: + 971 506 408 626  
F: + 971 426 822 17  
E: yasararafat@gmail.com  
W: www.equipo.ae

## Eriez Magnetics Europe Limited

Bedwas House Industrial Estate  
Bedwas  
Caerphilly

CF83 8YG  
UK

Contact: Ms Danielle Lloyd  
Job Title: Marketing Executive  
T: + 44 29 20 868 501  
F: + 44 29 20 851 314  
E: danielle.lloyd@eriezeurope.co.uk  
W: http://en-gb.eriez.com

Magnetic separators (dry and wet process) for separation and recovery of ferrous and non-ferrous metals, metal detectors (underbelt and aperture types as well as vertical feed/pipeline systems), automatic sampling systems for dry bulk materials and slurries, vibratory feeders for light bulk and heavy duty applications.

## Esch Engineering Service Centre

& Handle GmbH  
Maxhuetten Strasse 19  
Unterwellenborn

7333  
Germany

Contact: Dr Jens Lahr  
T: + 49 36 71 67 40 14  
F: + 49 36 71 67 40 80  
E: j.lahr@esch-online.de  
W: www.esch-online.de

A pneumatic conveyor manufacturer, also producing metering equipment for dense flow conveying.

## ESI Eurosilos BV

Newtonstraat 26-28  
Purmerend  
1446 VR

The Netherlands

Contact: Mr Jaap P J Ruijgrok  
Job Title: Managing Director  
T: + 31 299 630 730  
F: + 31 229 630 737  
E: esi@eurosilos.com  
W: www.eurosilos.com

Involved in the design, fabrication and installation of storage equipment and bulk materials handling systems, including the 'Eurosilos' storage silo fitted with 'core-flow' and 'slotted column' reclaiming systems consisting of a rotating screw conveyor mounted on a central column.

## Euromec Srl



Via Visano  
78/80 Isorella  
Brescia  
25010  
Italy

Contact: Mr Ricardo Segala  
Job Title: Sales and Marketing

T: + 39 030 9958 151  
F: + 39 030 995 2223  
E: sales@euromecsr.info  
W: www.euromecsr.com

EUROMEC, born from the merger of companies Eurohydromec and Isomec, has years of experience in the material handling field and the production of products such as lifting equipment, electrohydraulic and mechanical grabs and buckets.

## Eurotech Corporation

195 23rd Street  
Pittsburgh  
PA

15215  
USA

Contact: Mr Richard W. Theobald  
T: + 1 412 782 0600  
F: + 1 412 782 6200  
E: sales@eurotechcorporation.com  
W: www.eurotechcorporation.com

## Euro-Tramco BV

Space-shuttle 8G  
Amersfoort  
3824 ML

The Netherlands

Contact: Mr Hans Plekkenpol  
T: + 31 33 4567033  
F: + 31 33 4558149  
E: hans@tramco-europe.com  
W: www.tramcoinc.com

Manufactures chain, screw and bucket conveyors and 'Aerobel' air-supported belt conveyor systems.

## F E Schulte Strathaus GmbH & Co KG

Runtestrasse 42  
Werl  
D-59457

Germany

Contact: Mr Andre Hanke  
T: + 49 2922 9775 0  
F: + 49 2922 9775 75  
E: ha@schulte-strathaus.de  
W: www.schulte-strathaus.de

## F L Smidth A/S

Vigerslev Alle 77  
Valby  
DK-2500

Denmark

Contact: Mrs Camilla Travis  
T: + 45 3618 1000  
F: + 45 3645 4427  
E: ctr@flsmidth.com

W: www.flsmidth.com  
FLSmidth offers a portfolio of products and solutions to handle any type of bulk materials. Our full range of materials handling products includes complete crusher installations and silos, stackers/reclaimers and ship unloaders. We supply process design and equipment for all materials handling applications for the cement industry and related industries.

## Failure Control Ltd

Unit 4, The Barton Courtyard  
Duncheideock  
Exeter

Devon

EX2 9UA  
UK

Contact: Dr Roger King  
Job Title: Managing Director  
T: + 44 1392 832883  
F: + 44 1392 692883  
E: roger.king@failurecontrol.com  
W: www.failurecontrol.com

Specialist engineers undertaking failure investigations in the marine industries. Expert witness reports and technical assistance to loss adjusters, claims managers and lawyers.

## Fairport Engineering

Market Place  
Adlington  
Lancashire

PR7 2QP  
UK

Contact: Mrs Linda White  
Job Title: Communications Manager  
T: + 44 1257 484000  
F: + 44 1257 483312  
E: info@airport.co.uk  
W: www.fairport.co.uk

Produces a wide range of vibratory screw and belt conveyors for the food, coal and other industries.

## FAM Canada Inc

Bankers Hall West Tower  
1000, 888-3rd Street, SW  
Calgary  
Alberta

T2P 6C5  
Canada

Contact: Mr David Chomik  
T: + 1 403 444-5510  
F: + 1 403 444-6671  
E: melanie.miranda@famcanada.com  
W: www.fam.de/

## FAM Foerderanlagen Magdeburg

Sudenburger Wuhne 47  
Magdeburg  
D-39112

Germany

Contact: Mr Ulrich Schneider  
Job Title: Director Sales and  
Marketing  
T: + 49 391 6380 10 1 01  
F: + 49 391 6380 10 1 99  
E: sales@fam.de

W: www.fam.de  
FAM Foerderanlagen Magdeburg is an independent company with the head office in Germany, with a long tradition as a manufacturer of materials handling systems.

## Famak SA

Machinery and Equipment  
Company  
Fabryczna Street 5  
Kluczbork

PL 46-200  
Poland

Contact: Mr Wojciech Staszak  
Job Title: President and CEO  
T: + 48 77 40 70 100  
F: + 48 77 418 15 45  
E: famak@famak.pl  
W: www.famak.pl

One Source



# High-performance vacuum unloading standard

KOVAKO™ Pneumatic Unloaders are offered as standard models that match optimal unloading capacity with typical vessel sizes –

diesel-power and multiple mobility options, there's a model to suit every terminal application.

KOVAKO Pneumatic Unloaders are built with FLSmidth's superior engineering and backed by our unequalled customer service.

No other unloader offers our unique combination of practicality, efficiency, performance and dependability!

Find out more at [www.flsmidth.com](http://www.flsmidth.com)

© 2010 FLSmidth A/S. KOVAKO is a trademark owned by FLSmidth A/S.

**FLSMIDTH**





Manufacturer of grabs & hooks cranes, stackers & reclaimers, portal scraper loaders and belt conveyors systems.

**Fantuzzi Reggiane S.p.a**

Via Cisa Ligure 51/A  
Lentigione di Brescello (RE)  
42040  
Italy  
Contact: Mrs Rosanna Gennari  
Job Title: Marketing  
T: + 39 0522 5881  
F: + 39 0522 588243  
W: www.fantuzzi.com  
Manufactures a wide range of port loading and unloading equipment, including mobile harbour cranes with maximum lifting capacities of up to 100 tonnes.

**FELD Maschinen-und  
Industriebau GmbH**

Winkeltefeld 3  
Oer-Erkenschwick  
D-45739  
Germany  
Contact: Mr Andre Stueckradt  
T: + 49 2368 98890  
F: + 49 2368 9889 27  
W: www.maschinenbau-feld.de

**FEMADIGIPACK S.r.l**

Via San Giovanni Bosco, 60  
Bergamo  
Bergamo  
24126  
Italy  
Contact: Mr Tiengo Giorgio  
Job Title: General Manager  
T: + 39 036 391 0453  
F: + 39 036 390 2466  
E: commerciale@femadigipack.it  
W: www.femagroup.net  
Packing machines for cement and other materials in powder.

**Fenner Dunlop Conveyor Belting**

**Europe**  
Marfleet  
Hull  
Yorkshire  
HU9 5RA  
UK  
Contact: Mr Jim Jones  
T: + 44 1482 785450  
F: + 44 1482 785438  
E: jim.jones@fennerdunlop.com  
W: www.fennerdunlop.com

**Fenner plc**

Hesslewood Country Office Park  
Hessle  
East Yorks  
HU13 0PW  
UK  
Contact: Ms. Michelle Madden  
Job Title: Studio Manager  
T: + 44 1482 626 500 / 523  
F: + 44 1482 626522  
E: eprismuk@fenner.com  
W: www.fennerdunlop.com/

**Figeo Crane Services BV**

PO Box 235  
Zaandam 1500 EE  
The Netherlands  
Contact: Mr Henk van Til  
Job Title: Business Manager,  
Harbour Cranes  
T: + 31 75 6810 413  
F: + 31 75 6315 996  
E: h.vantil@figeo.com  
W: www.kenz-figeo.com  
Merger of Kenz offshore cranes and Figeo harbour cranes. Founded in 1836, Figeo designs and manufactures a complete range of bulk handling cranes including the unique and well proven Lemniscate floating grab cranes with capacities from 16-50t, gantry grab unloaders, single- and double boom cranes, kangaroo cranes.

**Flexco**

2525 Wisconsin Avenue  
Downers Grove  
IL  
60515-4200  
USA  
Contact: Ms Kelly Clancy  
Job Title: Public Relations  
Specialist  
T: + 1 630 971 0150  
F: + 1 630 971 1180  
E: kclancy@flexco.com  
W: www.flexco.com  
Flexible Steel Lacing Company (Flexco), headquartered near Chicago IL/USA, provides the world's belt conveyors with efficient, safe products, services and solutions for mechanical splicing, slippage, belt tracking and cleaning. The company operates subsidiaries in California, Michigan, Mexico, England, Germany, Australia and South Africa. Their products are distributed under the brand names: Flexco Rockline, Minline and Eliminator.

**Flexoveyor Conveyer**

3795 Paris St., Unit D  
Denver  
Colorado  
80239  
USA  
Contact: Mr Bill Priday  
T: + 1 303 375 0200  
F: + 1 303 373 5149  
E: billpriday@conveyind.com  
W: www.flexoveyor.com

**Flomat Bagfilla International  
Limited**

Fairport House  
28 Charles Street  
Higher Hillgate  
Stockport  
Cheshire  
SK1 3JR  
UK

Contact: Mr Mal Sharpley  
Job Title: Group Sales Director  
T: + 44 161 477 4775  
F: + 44 161 474 0257  
E: msharpley@fpeglobal.co.uk  
W: www.fpeglobal.com  
As part of the FPE Global Group of Companies including Aeromaster (Aero-mechanical conveying specialists), NEU Solutions (Pneumatic conveying experts), Process Equipment and Site Operations, we can offer a variety of materials handling solutions.

**FLSmidth GmbH**

Alfred Leiner Strasse 3  
Lanzendorf  
A-2326  
Austria  
Contact: Mr Patrick Schwarz  
T: + 49 6834 470 175  
F: + 43 2235 47568  
E: patrick.schwarz@flsmidth.com  
W: www.flsmidth.com  
Leading Pipe Conveyor Technology - More than 200 Pipe Conveyor installations worldwide.

**FLSmidth Inc.**



2040 Avenue C  
Bethlehem  
PA  
18017-2188  
USA

Contact: Mr David Bergenstock  
Job Title: Sales Manager  
T: + 1 610 264 6988  
F: + 1 610 264 6307  
E: david.bergenstock@flsmidth.com  
W: www.flsmidth.com  
FLSmidth specializes in terminal equipment for dry bulk products, primarily cement. In addition to ship and barge unloading/loading

equipment we also specialize in pneumatic reclaim and transfer systems for storage silos and domes.

**FLSmidth Minerals Pvt. Ltd**

FLSmidth House  
34 Egatoor  
Kelambakkam  
Old Mahabalipuram Road  
Chennai  
Tamil Nadu  
603 103  
India  
Contact: Mr Sivalingam  
Santhakumar  
Job Title: Library  
T: + 91 44 47484795  
F: + 91 44 27470301  
E: indiainfo@flsmidth.com  
W: www.flsmidth.com

**FLSmidth Spokane, Inc.**

605 E Holland Ave  
Suite 300  
Spokane  
WA  
99218  
USA  
Contact: Mr Dennis Medina  
Job Title: Sales and Marketing  
Manager  
T: + 1 509 467 0770  
F: + 1 509 466 0212  
E: Dennis.medina@flsmidth.com  
W: www.flsmidth.com  
Over 50 years in the bulk materials handling industry, providing solutions for some of the world's most complex materials handling problems. Designers of stackers; mobile, fixed and portable conveyors and stackers; and reclaiming systems with capacities from 200-10,000 metric tonnes per hour. Specialists in developing, designing and fabricating materials handling equipment for specific applications.

One Source



# One Source many solutions

FLSmidth is the leading supplier to the global cement and minerals industries for equipment and services such as:

- Stackers/Reclaimers including unmanned operation
- Loading and unloading systems for bulk materials, packed goods and bags at inland ports and seaports
- KOCH Pipe Conveyor®
- Feeders / KOCH Drag chain conveyors
- In-pit crushing & conveying systems
- Silo systems and silo discharging systems
- power industries as well as harbours

**For more information, contact us at**  
FLSmidth Wadgassen GmbH

Tel: +49 (0) 6834 470-0 • Fax: +49 (0) 6834 470-339  
wadgassen@flsmidth.com

[www.flsmidth.com](http://www.flsmidth.com)

**FLSMIDTH**



**FLSmith Wadgassen GmbH**

Karl-Koch-Strasse 1  
Wadgassen  
Saarland  
66787  
Germany  
Contact: Mr Romuald Hartmann  
Job Title: CEO  
T: + 49 6834 470 0  
F: + 49 6834 470 339  
E: wadgassen@flsmith.com  
W: www.flsmith.com  
FLSmith designs, manufactures, and services a broad range of materials handling equipment and systems for various industries, from minerals and cement to pulp and paper. Products include stacker/reclaimer systems, bulk material and bag loading and unloading systems for barges and ships, conveying solutions, including KOCH Pipe Conveyor®, and complete materials handling facilities.

**FMC Corporation**

PO Box 1370  
1 Link Belt Drive  
Tupelo  
MS 38802  
USA  
Contact: Mr Randy Webb  
T: + 1 507 243 3185  
F: + 1 601 869 7402  
W: www.fmc.com

**Fortum Power and Heat OY**

PO Box 1  
Fortum 00048  
Finland  
Contact: Ms Jonn Paakkonen  
Job Title: Marketing Manager  
T: + 358 10 4511  
F: + 358 10 45 24447  
E: communications@fortum.com

**FPS Mustang**

Filtermech Plant Sales Ltd  
Unit 6-2  
Seckar Wood Industrial Park  
Barnsley Road, Newmillerdam  
Wakefield WF2 6QW  
UK  
Contact: Mr Mick Maxfield  
T: + 44 1924 252252  
F: + 44 1924 252565  
E: sales@fpsmustang.co.uk  
W: www.fpsmustang.co.uk  
Importers and distributors for Mustang Skid Steer Loaders and attachments for the UK and Ireland. Mustang Skid Steer Loaders are manufactured to industrial specifications and are ideal for use in arduous applications such as ship trimming and stevedore work.

**Gama Endustri Tesisleri Imalat Ve Montaj AS**

Narcissus Street No: 9, 06 520  
Söğütözü  
Ankara  
06540  
Turkey  
Contact: Mr Mehmet Artun  
Job Title: General Manager  
T: + 90 312 248 42 00  
F: + 90 312 4094360  
E: industry@gama.com.tr  
W: www.gama.com.tr

**Gambarotta Gschwendt**

Viale Verona 200  
Trento  
38123  
Italy  
Contact: Mr Luca Mastrococo & Christian Jezek

Job Title: Sales Managers  
T: + 39 0461 920403  
F: + 39 0461 933391  
E: gambarotta@gambarotta.it  
W: www.gambarotta.it  
Designer and Manufacturer of Bucket Elevators, Apron Feeders, Truck Discharge Feeders, Steel Pan Conveyors, Chain Conveyors, Screw Conveyors, Bulk Unloader Chutes applicable for Cement, Coal, Mineral, Petrochemical and Power Plants Industries.

**Gantrex Inc.**

2000 Oxford Drive-Suite 400  
Pittsburgh  
PA  
PA 15102  
USA  
Contact: Mr Tom Berringer  
Job Title: VP Sales & Marketing  
T: + 1 412 655 1400  
F: + 1 412 655 3814  
E: sales@gantrex.com  
W: www.gantrex.com/  
Gantrex provides solutions for rail mounted material handling systems including crane rail, rail clips and hydraulic bumpers. Call Toll Free at 1-800-242-6873 or visit www.Gantrex.com.

**Ganz Danubius Trading Co Ltd**

PO Box 1138  
Budapest  
H1325  
Hungary  
Contact: Mr Karol Bayus  
Job Title: Director  
T: + 36 1 350 5570  
F: + 36 1 329 8041  
E: gdtco@hu.inter.net  
W: www.ganztrading.hu  
Manufactures shiploaders/unloaders, mechanical level luffing slewing harbour portal cranes 16-50 tonnes capacity, floating cranes 16-150 tonnes capacity, barges, river-seagoing vessels, steel construction for special shiploaders and unloaders, stackers/reclaimers, cranes.

**Garwood Consulting Ltd**

Garwood Lodge  
Wentworth  
Ely  
Cambridgeshire  
CB6 3QG  
UK  
Contact: Mr Barry Woodbine  
T: + 44 780 102 4583  
F: + 44 1353 777315  
E: barry@garwoodconsulting.com

**GEC Alstom Engineering Systems**

Handling Systems Division  
Cambridge Road  
Wheatstone  
Leicester  
LE8 6LH  
UK  
Contact: Mr John Killip  
Job Title: Commercial Manager  
T: + 44 116 284 5696  
F: + 44 116 284 5463  
E: info@power.alstom.com  
W: www.techcentreuk.power.alstom.com/

**General Bridge Engineering Ltd**

PO Box 110  
Peterborough  
PE2 7ZZ  
UK  
Contact: Mr Jack Wild  
T: + 44 1733 231207  
F: + 44 1733 231207  
E: sales@generalbridge.co.uk  
An engineering design consultancy for

the materials handling, recycling and quarry industries. The chief activities are the design of bulk port handling and storage plus individual items designed for the quarry and recycling installations.

**General Kinematics Corp.**

5050 Rickert Rd.  
Crystal Lake  
IL 60014  
USA  
Contact: Mr Thomas Musschoot  
T: + 1 815 455 3222  
F: + 1 815 455 2285  
E: tmusschoot@generalkinematics.com  
W: www.generalkinematics.com  
General Kinematics specializes in vibrating and rotary equipment and solutions for bulk processing of material in the foundry, recycling, scrap, mining, minerals, food, chemical, and wood industries. Each piece of GK equipment is custom engineered to your specifications to meet your process objectives.

**Genivar Inc**

1166 Laure Blvd  
Sept-Îles  
Quebec  
G4S 1C4  
Canada  
Contact: Mr Denis Blouin  
Job Title: Regional Director  
T: + 1 418 962 2241  
F: + 1 418 962 3641  
E: info@genivar.com  
W: www.genivar.com

**Geométrica de México, S.A. de C.V.**

Puerto Vallarta # 801  
Colonia La Fé  
San Nicolás de los Garza  
N.L.,  
66477  
Mexico  
Contact: Mr Cecilio Zalba  
Job Title: Sales Manager  
T: + 52 81 8882 8300  
F: + 52 81 8882 8301  
E: sales.mexico@geometrica.com  
W: www.geometrica.com/bulk-storage  
Specializes in design, manufacture and installation of long span bulk storage enclosures. Structures can be designed in circular, elliptical, longitudinal and free style configurations that can span distances up to 300m, with no intermediate supports. Galvanized steel/aluminum construction is easy to install, lightweight, strong and maintenance free with low fabrication and installation costs.

**Geometrica Inc**

12300 Dundee Court  
Suite 200  
Cypress  
Texas  
77429  
USA  
Contact: Mr Francisco Castaño  
Job Title: President  
T: + 1 832 220 1200  
F: + 1 832 482 0879  
E: sales@geometrica.com  
W: www.geometrica.com  
Specializes in design, manufacture and installation of long span bulk storage enclosures. Structures can be designed in circular, elliptical, longitudinal and free style configurations that can span distances up to 300m, with no intermediate supports. Galvanized steel/aluminum construction is easy to install, lightweight, strong and maintenance

free with low fabrication and installation costs.

**Geroldinger GmbH & Co KG**

Au-Strasse 9  
Sigharting  
A-4771  
Austria  
Contact: Mr Walter Geroldinger  
Job Title: General Manager  
T: + 43 7766 24370  
F: + 43 7766 243724  
E: office@geroldinger.com  
W: www.geroldinger.com  
Specialises in design and installation of bulk handling systems and processes, including hoppers and storage silos.

**Gertech Handling Systems cc**

PO Box 4014  
Durbanville  
Cape Town  
Western Cape  
7551  
South Africa  
Contact: Mr Gerrit De Hoog  
T: + 27 21 914 5333  
F: + 27 21 914 5666  
E: gdh@gertech.co.za  
W: www.gertech.co.za  
Design and manufacturing of handling and storage systems for bulk handling of dry materials. Steel Silos, mechanical conveyors and pneumatic conveying.

**GF Material Handling System Srl**

Via Guido Rossa, 11  
Paderno Dugnano (MI)  
Milan  
20037  
Italy  
Contact: Mr Francesco Tummillo  
Job Title: Managing Director  
T: + 39 0 2 91 08 20 02  
F: + 39 0 2 91 84 31 47  
E: info@gfmhs.it  
W: www.gfmhs.it  
...we are your starting point of your project.

**GGT Goldengrain Trading SA**

Via Capelli 28  
Lugano  
6900  
Switzerland  
Contact: Ms Cornelia Riep  
Job Title: Manager  
T: + 41 91 971 40 20  
F: + 41 91 971 40 21  
E: cgriep@ggt.ch

**Golden West Industries**

332 West Railroad Ave  
Price  
UT  
84501  
USA  
Contact: Mr Ellis Pierce  
Job Title: Advertising  
T: + 1 435 637 3211  
F: + 1 435 637 6628  
E: pwynny@gbis.com  
W: www.goldenwest-industries.com  
Golden West Industries provides dust suppression and freeze control products to the mining and material handling industries.

**Golfetto Sangati S.r.l.****GOLFETTO SANGATI**

Via Monte Grappa, 8  
35015 Galliera Veneta PD  
Italy  
Contact: Mrs Monica Giantin  
T: + 39 0422 476700  
F: + 39 0422 476800  
E: info@golfettosangati.com  
W: www.golfettosangati.com  
Designs, constructs and installs complete grain terminals for ship loading and unloading. The range of grain terminals covers any possible technology: fixed or mobile, on rails or tyres, for loading and unloading or the combined type in the same structure. Two types of unloaders are produced - pneumatic and mechanical. Special designed unloaders for no-free flowing commodities.

**Goodman Conveyor Company**

U.S. Route 178 South  
PO Box 866  
Belton  
South Carolina 29627  
USA  
Contact: Mr Carter Matthews  
Job Title: VP Sales & Marketing  
T: + 1 864 338 7793 x 102  
F: + 1 864 338 8732  
E: info@goodmanconveyor.com  
W: www.goodmanconveyor.com  
Recognised as a leading designer and manufacturer of high quality bulk conveyor equipment, components and structures, including screw conveyors, multi-flow round bottom drag conveyors and flat bottom en-masse drag conveyors.

**Goodtech Solutions AS**

Bjoernslettveien 2  
Porsgrunn N-3917  
Norway  
Contact: Mr Knut Halvorsen  
Job Title: Group Commercial Manager  
T: + 47 90 08 74 08  
F: + 47 35 93 05 60  
E: knut.halvorsen@goodtech.no  
W: www.portabulk.com or www.goodtech.no  
The company provides specialised technology for filling, handling, storing, tracing and distributing packaged bulk products for customers throughout the world. We supply purpose-designed and cost-effective systems, materials, equipment and software.

**Goodyear Tyre & Rubber Co**

1144 East Market Street  
Akron  
Ohio 44316-0001  
USA  
Contact: Mr Jeff Mathers  
Job Title: Marketing  
T: + 1 330 796 3881  
F: + 1 330 796 2222  
W: www.goodyear.com

**Gordinne & Co NV/SA**

Belgian Ports Operation  
Leegstraat 1  
Zelzate B-9060  
Belgium  
Contact: Mr Patrick Bosschaert  
Job Title: Operation Manager  
T: + 32 9 342 3333  
F: + 32 9 342 3331  
E: patrick.bosschaert@stewartgroupglobal.com  
W: www.gordinne.be  
Based in Belgium, the Netherlands and Venezuela. Established in 1947

**HAYER & BOECKER**



THE ENGINEER

# HAYER & BOECKER THE FULL-LINER



## THE HAYER® GROUP YOUR PARTNER IN

- Storage
- Handling
- Packaging
- Pallatizing
- Loading
- Service

HAYER & BOECKER, Germany  
Phone: +49 2522 30-0 · Fax: +49 2522 30-403  
E-mail: [haver@haverboecker.com](mailto:haver@haverboecker.com)

[www.haverboecker.com](http://www.haverboecker.com)

The designation ® indicates a registered trademark of HAYER & BOECKER OHG in Germany. Several indicated designations are registered trademarks also in other countries worldwide. M 939-E4

and specialises in the controlling, sampling and analysing of solid bulk commodities (coal, coke and petroleum coke, ores and minerals), the draft survey of ships and the topographic surveys of stockpiled materials. An ISO 9002 certified company.

### Gottwald Port Technology GmbH

Postfach 180343  
Düsseldorf D-40570  
Germany  
Contact: Mr Marcus Mensel  
Job Title: Marketing Port Solutions  
T: + 49 211 7102 3017  
F: + 49 211 7102 53017  
E: [marcus.mensel@gottwald.com](mailto:marcus.mensel@gottwald.com)  
W: [www.gottwald.com](http://www.gottwald.com)

Suppliers of a range of harbour cranes including Mobile Harbour Cranes, Portal Harbour Cranes and Floating Cranes. All available as four-rope variants and having grab curves of up to 63t. The cranes have long service lives even in continuous handling of products like coal, ores, agribulk and fertilisers. Depending on operating conditions, handling capacities can exceed 1,500 t/h.

### Gottwald Port Technology USA

Demag Cranes and Components Corp  
3502 Riga Blvd., Suite C  
Tampa  
Florida FL 33619  
USA  
Contact: Mr Bob Histon  
Job Title: General Manager, North America  
T: + 1 813 490 0990 ext 19  
F: + 1 813 490 0994  
E: [bob.histon@gottwald-us.com](mailto:bob.histon@gottwald-us.com)  
W: [www.gottwald-us.com](http://www.gottwald-us.com)

### Greiferbau-Und Verschleisstechnik GmbH

Hullerser Landstrasse 12A  
Einbeck  
D-37574  
Germany  
Contact: Mr Bernd Brockmeyer  
Job Title: Marketing Manager  
T: + 49 5561 947211  
F: + 49 5561 947222  
E: [info@gve-einbeck.de](mailto:info@gve-einbeck.de)  
W: [www.gve-einbeck.de](http://www.gve-einbeck.de)  
Manufactures grabs, including 'Laudi' rope, motor, hydraulic and specialty grabs. The company also offers repairs and regeneration of load lifting equipment.

### GREIF-VELOX

Kronsfordter Landstraße 177  
Lübeck  
D-23560  
Germany  
Contact: Mr D M Wassenberg  
T: + 49 451 5303 0  
F: + 49 451 5303 233  
E: [dm.wassenberg@greif-velox.de](mailto:dm.wassenberg@greif-velox.de)  
W: [www.greif-velox.de](http://www.greif-velox.de)  
Manufactures special FIBC filling and discharge equipment that allows FIBCs to be transported in interchange racks and unloaded in controlled doses into a production process.

### Greystones Cargo Systems (Pty) Ltd

PO Box 22034  
Glenashley  
Durban  
4022  
South Africa  
Contact: Mr Bruce Poucher  
T: + 27 31 274 2600  
F: + 27 31 569 2626  
E: [paul@cargo.greystones.co.za](mailto:paul@cargo.greystones.co.za)  
W: [www.greystones.co.za](http://www.greystones.co.za)

### Gubre Fabrikalari TAS

Kasap Sokak No 22  
Esentepe

Istanbul  
34394  
Turkey  
Contact: Mr M Kürsat Akin  
Job Title: Trade Manager  
T: + 90 212 3765050  
F: + 90 212 2741201  
E: [kakin@gubretas.com.tr](mailto:kakin@gubretas.com.tr)  
W: [www.gubretas.com.tr](http://www.gubretas.com.tr)  
Producer of NP,NPK and importer fertilizer .

### Gulsan A.p.

Organize Sanayi Bolgesi 2 Cad. No: 18  
Gaziantep  
27180  
Turkey  
Contact: Ms Gülden Saka  
Job Title: Marketing Manager  
T: + 90 342 337 1180  
F: + 90 342 337 2528  
E: [info@gulsan-group.com](mailto:info@gulsan-group.com)  
W: [www.gulsan-group.com](http://www.gulsan-group.com)

### Guttridge Ltd

Wardentree Park  
Pinchbeck  
Spalding  
Lincolnshire  
PE11 3UU  
UK  
Contact: Mr Peter Lambert  
Job Title: Sales Manager  
T: + 44 1775 765300  
F: + 44 1775 765304  
E: [sales@guttridge.co.uk](mailto:sales@guttridge.co.uk)  
W: [www.guttridge.co.uk](http://www.guttridge.co.uk)  
Manufactures a range of bulk conveying and elevating equipment, as well as storage facilities.

### Güven Grab and Machine Ltd. Co

Nazim Hikmet Cad 536. sk. No: 9  
Aske Köyü  
Cayirova  
Kocaeli  
41420  
Turkey  
Contact: Mr Engin Demir  
Job Title: Sales & Export Manager  
T: + 90 262 743 8858  
F: + 90 262 743 1141  
E: [info@guvengrab.com](mailto:info@guvengrab.com)  
W: [www.guvengrab.com](http://www.guvengrab.com)  
Established in 1984, Güven Grab & Machine (Güven Kepçe Makine) has its own manufacturing facilities. Its product range includes radio remote control grabs, electro hydraulic clamshell/orange peel grabs, mechanical clamshell orange peel touch down grabs and mechanical double wired grabs. It has supplied its units to countries around the world.

### H J Wiefferink BV

PO Box 335  
Oldenzaal  
7570 AH  
The Netherlands  
Contact:  
Job Title: Advertising  
T: + 31 5415 71616  
F: + 31 5415 12499  
W: [www.wiefferink.nl](http://www.wiefferink.nl)

### H Noorman BV

Breedstraat 2  
Vreeland  
3633 AX  
The Netherlands  
Contact: Mr H Noorman  
T: + 31 294 236161  
F: + 31 294 232181  
E: [info@hnoorman.com](mailto:info@hnoorman.com)

### Hagglunds Drives AB

Vasterselevägen 12  
Mellansel  
890 42  
Sweden  
Contact: Mr Uno Sundelin  
Job Title: Business Area Manager



T: + 46 660 87000  
 F: + 46 660 87160  
 E: info@hagglunds.se  
 W: www.hagglunds.com  
 Hägglunds Drives manufactures and markets drive system solutions for applications requiring high torque, low speeds and variable speeds. The drive systems are used in a wide range of industries, such as Mining and materials handling

#### Halcrow

Burderop Park  
 Swindon  
 Wiltshire  
 SN4 0QD  
 UK  
 Contact: Mr Daniel Cross  
 Job Title: Ports Design Engineer  
 T: + 44 1793 812 479  
 F: + 44 1793 812 089  
 E: crossd@halcrow.com  
 W: www.halcrow.com

#### Halcrow Group Ltd

Vineyard House  
 44 Brook Green  
 London  
 W6 7BY  
 UK  
 Contact: Mr Richard Clarke  
 T: + 44 207 348 3152  
 F: + 44 207 603 0095  
 E: clarkerj@halcrow.com  
 W: www.halcrow.com

#### Hans Turck GmbH & Co. KG

Witzlebenstraße 7  
 Mülheim an der Ruhr  
 D-45472  
 Germany  
 Contact: Mr Klaus Albers  
 Job Title: PR Manager  
 T: + 49 208 495249  
 F: + 49 160 93950359

E: klaus.albers@turck.com  
 W: www.turck.com

#### Hansen Industrial Transmissions

**NV**  
 Leonardo da Vincilaan 1-3  
 Edegem  
 Antwerpen  
 B-2650  
 Belgium  
 Contact:  
 T: + 32 345 12 11  
 F: + 32 345 12 20  
 E: info@hansenindustrialgearboxes.com  
 W: www.hansenindustrialgearboxes.com

Innovative and durable drives for a wide range of industrial applications throughout the world, especially in sectors where low noise levels, minimum weight and high reliability are essential (including material, cooling towers, handling, water treatment, etc.).

#### Hansen Transmissions Ltd

Nile Street  
 Huddersfield  
 West Yorkshire  
 HD1 3LW  
 UK  
 Contact: Mr Terry Drayton  
 T: + 44 1484 431414  
 F: + 44 1484 431426  
 E: info.uk@hansentransmissions.com  
 W: www.hansentransmissions.net  
 Gearbox refurbishment 24/7, 365 days a year. Full design, spares and on-site service facilities available. Gear units spanning from 80 Nm to 800 KNm (0.12 KW to 12MW). Hansen Transmissions operate successfully in thousands of diverse industrial installations worldwide, and are available in many configurations

and drive packages.

#### Hanson Silo Company

11587 County Rd  
 8 SE  
 Lake Lillian  
 MN  
 56253  
 USA  
 Contact: Mr Mike Hanson  
 Job Title: Director of Business Development  
 T: + 1 800 843 7456  
 E: hscinfo@hansonsilo.com  
 W: www.hansonsilo.com

#### Hapman

6002 East N Ave.  
 PO Box 2321  
 Kalamazoo  
 MI  
 49048  
 USA  
 Contact: Mr Greg Patterson  
 Job Title: Vice President  
 T: + 1 269 343 1675  
 F: + 1 269 349 2477  
 E: greg.patterson@hapman.com  
 W: www.hapman.com  
 Produces bulk material handling conveyors, bulk bag handling equipment and systems for the handling of materials for the chemical, food, minerals and related industries.

#### Hasel Machinery Inc

Cumhuriyet Mh. Nr 15 E5 Karayolu  
 Uzeri  
 Yakacik Kartal  
 Istanbul  
 81100  
 Turkey  
 Contact: Mr Osman Nuri Mete  
 Job Title: Manager  
 T: + 90 216 452 9787  
 F: + 90 216 452 9790

E: osman.mete@hasel.com  
 W: www.hasel.com

#### Hasler International SA

Z.I. De l'Abbaye  
 Pont-Evêque  
 38780  
 France  
 Contact: Mr Michel Jamey  
 Job Title: President and Sales Director  
 T: + 33 474 161151  
 F: + 33 474 161155  
 E: sales.fr@hasler-int.com  
 W: www.hasler-int.com

#### HAUGEN System AB

Fersens väg 12  
 Malmö  
 211 42  
 Sweden  
 Contact: Mr Karl T. Haugen  
 Job Title: Managing Director  
 T: + 46 40 30 64 00  
 F: + 46 40 30 63 30  
 E: karl.haugen@haugensystem.com  
 W: www.haugensystem.com  
 SPILLAGE MANAGEMENT: Spillage in your plant means: - Loss of valuable raw material and finished products. - Internal and external environmental problems. - Increased maintenance cost. - Lower production efficiency. Heavy duty vacuum loaders and stationary vacuum systems can recover spillage, clean your plant and create a better environment.

#### HAVER & BOECKER OHG, Machinery Division



P O Box 3320  
 Oelde  
 59282  
 Germany  
 Contact: Mr Bernhard Pagenkemper  
 Job Title: Director Sales  
 T: + 49 2522 30 272  
 F: + 49 2522 30 627  
 E: b.pagenkemper@haverboecker.com  
 W: www.haverboecker.com  
 HAVER & BOECKER product range: Packing plants for bulk products in valve bags and open-mouth bags for semi-automatic or fully automatic operation. Capacities 100-5,000 bags/hour, weight range 5-2,000 kg, Form-Fill-Seal bagging systems, big bag weighers and container weighers, complete silo and bag loading plants as well as screening plants for dry and wet products.

#### Haver & Boecker Wire Weaving Division

Ennigerloher Strasse 64  
 Oelde  
 59302  
 Germany  
 Contact: Mr N Alberntst  
 T: + 49 2522 300  
 F: + 49 2522 30404  
 E: dw@haverboecker.com  
 W: www.weavingideas.com

# PROTECT YOUR INVESTMENT

## The Difference Between Damaged and Undamaged Cargo



You cannot always predict the weather. You can, however, predict the protection your cargo will get from Henry hatch cover tapes. These products have been protecting cargoes for more than three decades and are available through a worldwide network of stocking distributors. When you specify **Henry RAM-NEK® Premium Heavy Duty** you will experience the difference between damaged and undamaged cargo — **Henry Diplomatic Marine Products** are the difference.



**Henry Company Diplomatic Marine Products**

Phone: (610) 933-8888 • E-Mail: cshenry@henry.com • Website: www.henry.com

# New ZW250-5

## Tough on any terrain



Quick  
power switch

MP3 dock



up to  
**10%**  
less fuel  
consumption

The power of advanced technology has developed a new high-quality range of Hitachi construction machinery. The ZW-5 wheel loaders are tough on any terrain, reinforcing their market-leading reputation for reliability and durability. Designed for the most challenging job sites and with operator comfort firmly in mind, the Hitachi ZW250-5 delivers increased productivity, and offers a safe and spacious working environment.

# HITACHI



State-of-the-art machinery and a team of qualified experts manufacture wire cloth and wire cloth products suitable for all applications. Rolls, pieces, strips, discs, fabricated parts, filters, screen sections, test sieves, test sieve shakers, and photo-optical particle analyser.

### Hebei Xinrong Rubber Products Co., Ltd

Beijing International Marketing Dept  
21st Floor,  
Wanda Plaza  
Shijingshan District,  
Beijing  
100043  
China  
Contact: Ms Roxy Yang  
Job Title: Sales Manager  
T: + 86 10 886 96 189  
F: + 86 10 88 696 185  
W: www.bjxinrongrubber.com

### Heinrich Schwacke GmbH & Co KG

Hölscherstr. 6a,  
Duisburg  
D-47167  
Germany  
Contact: Mrs Schacke  
T: + 49 203 995 290  
F: + 49 203 586 058  
E: info@schacke.de  
W: www.schwacke.de

### Henry International Diplomatic Marine



27502 Vilna Avenue  
Santa Clarita

CA  
91351  
USA  
Contact: Mr Jim Hill  
Job Title: International Sales Manager  
T: + 1 713 676 2400  
F: + 1 713 673 5805  
E: jhill@henry.com  
W: www.henry.com  
Products include: RAM-NEK - Premium heavy duty hatch cover tape. GULF-SEAL - Heavy duty hatch cover tape. MARITAPE-60 - Hatch cover tape. MARITAPE-40 - Hatch cover tape. KOAMING-AIDE - Coaming joint sealant. RAM-WRAP - Pipe repair system

### Hethon Nederland BV

Granaatstraat 50  
Hengelo  
7554 TR  
The Netherlands  
Contact: Ms Brenda Hykens  
Job Title: Managing Director  
T: + 31 74 250 0555  
F: + 31 74 250 0595  
E: info@hethon.nl  
W: www.hethon.nl  
Produces pneumatic conveyors, feeders/excisters and control equipment.

### Heyl & Patterson Inc



PO Box 36  
Pittsburgh  
PA  
15230  
USA  
Contact: Mr Harry Edelman  
Job Title: Executive Vice President  
T: + 1 412 788 9810  
F: + 1 412 788 9822

E: info@heylpatterson.com  
W: www.heylopatterson.com  
Produces railcar dumpers, wagon tipplers, railcar indexers, train positioners, railcar movers, side arm chargers, grabs, bucket unloaders, barge loaders and unloaders and continuous barge unloaders.

### Hitachi Construction Machinery (Europe) NV



Sicliëweg 5  
Amsterdam  
1045 AT  
The Netherlands  
Contact: Ms Ghislaine Jonker  
Job Title: External Communications Coordinator  
T: + 31 20 44 76 711  
F: + 31 20 44 76 750  
E: marketing@hcme.com  
W: www.hcme.com  
Hitachi Construction Machinery (Europe) NV's main products are hydraulic excavators, crawler cranes, wheel loaders and rigid dump trucks. HCME provides a product line-up that distinguishes itself by its depth and width and that has earned an excellent reputation for performance, reliability and safety.

### Horizon Conveyor Equipment

Unit 1, Haysech Road  
Halesowen  
West Midlands  
B63 3PD  
UK  
Contact: Mr Alan Bowler  
Job Title: Managing Director  
T: + 44 121 550 2218  
F: + 44 121 550 2243  
E: info@horizonconveyors.co.uk

W: www.horizonconveyors.co.uk  
Horizon Conveyor Equipment design and manufacture a comprehensive range of conveyor bulk handling equipment which includes: Medium & Heavy-Duty Steel & Polymer Idlers, Steel & Polymer Conveyor Rollers, Primary, Secondary & Plough Belt Scrapers, Impact Sections & Skirts.

### HOSCH-Fördertechnik Recklinghausen GmbH

Am Stadion 36  
Recklinghausen  
D-45659  
Germany  
Contact: Mr Giancarlo Leombruno  
Job Title: Export Manager  
T: + 49 2361 5898 0  
F: + 49 2361 5898 40  
E: sales@hosch.de  
W: www.hosch.de  
Hosch has been manufacturing and distributing Sprung Blade Scrapers and accessories for high-precision belt cleaning for 35 years now. The innovative design principle of the C-series, which is patented world-wide, utilises modular components and guarantees total belt cleaning efficiency for all types of installation.

### HPC Hamburg Port Consulting GmbH

Container Terminal Altenwerder  
Am Ballinkai 1  
Hamburg  
21129  
Germany  
Contact: Mr Dierk Reumann  
Job Title: Managing Director  
T: + 49 40 74008 100  
F: + 49 40 74008 164  
E: d.reumann@hpc-hamburg.de  
W: www.hpc-hamburg.de  
Offers a comprehensive range of

services in the fields of port and transport management, port planning and operation, systems engineering, IT-Systems development, research and development, hydrography and training.

### Huadian Heavy Industries Co., Ltd.

12th Floor, China Overseas Property Plaza  
Wing East  
No.8 Xibinhe Road  
Yongdingmen, Dongcheng District  
Beijing  
China  
Contact: Mr Liu Zheng  
Job Title: Deputy Managing Director  
T: + 86 10 5196 6647  
F: + 86 10 6873 0551  
E: Liuzheng-dlbj@hotmail.com  
W: www.HHI.com.cn

### Hycontrol Limited

Larchwood House  
Orchard Street  
Redditch  
B98 7DP  
UK  
Contact: Mr Nigel Allen  
Job Title: Marketing  
T: + 44 1527 406800  
F: + 44 1527 406810  
E: nallen@hycontrol.com  
W: www.hycontrol.com

### Hyundai Heavy Industries Co

1000 Bangeojinsunhwan-doro  
Dong-Gu  
Ulsan  
682-792  
South Korea  
Contact: Mr J.M. Roh  
Job Title: General Manager  
T: + 82 52 202 2429  
F: + 82 52 202 3315

# Engineered for Life



Heyl & Patterson doesn't just engineer railcar dumping systems... We become a real partner in your operations for the life of your equipment, with:

- High-speed, semi-automatic unloading
- Various designs – Single, Tandem, Rotary, Wagon Tippler, Turnover, C-Shaped
- Rotation as fast as 35 seconds per car
- Rotate drive – Rack & Pinion or Chain
- Random car or unit train applications
- Inspections, upgrades and field service

Since 1887, the bulk materials handling industry has trusted Heyl & Patterson for innovative designs and reliable equipment.



**HEYL & PATTERSON INC**  
Trusted Since 1887

CELEBRATING  
**125**  
YEARS  
1887 - 2012

412-788-9810  
info@heylpatterson.com  
info.heylopatterson.com/dci

# IBAU HAMBURG:

**COMPANY ACTIVITIES: Cement Industry.**

# 1

## **Cement Industry**

Raw Meal Silos  
Cement Silos  
Multicompartment Silos  
Terminals  
Cement Carriers  
Ship unloaders



# 2

## **Coal-fired Power Plants**

Fly Ash Silos  
Lime and pulverised  
Limestone Silos  
Conveying Systems  
FGD Product Handling  
Dried Gypsum Handling  
Ship unloaders



# 3

## **Alumina Industry**

Alumina Silos  
Conveying Systems  
Loading Stations  
In-Plant Storage  
In-Plant Conveying  
Ship unloaders



**IBAU  
HAMBURG**



# The solution provider

**Coal-fired Power Plants. Alumina Industry.**



**Plant design.  
Engineering.  
EPC-Contracting.**

# LIFT YOUR PROFITS WITH THE FLOATING POWER OF NKMNOELL

Winner of the IBJ Innovative Technology Award

Tranship more tons an hour of any bulk commodity, at lower costs per ton, anywhere in a port area, even with low waters or no quay facilities, from ship-to-ship, ship-to-shore, and even on open sea with full work comfort and safety...

OPERATIONAL HIGHLIGHTS:  
CAPACITY UP TO 2,000 TONS PER HOUR  
OPTIMAL MOBILITY  
LOW FUEL CONSUMPTION  
LOW EMISSIONS  
LOW COST PER TON

Discover the power behind economic bulk transhipment and lift your profit with NKMNoell's new generation Floating Grab Cranes...



Contact us for custom new build or retrofit, refurbishment and full upgrade of existing cranes. Our wide experience with harbour cranes means we always have the best solutions.

**NKMNOELL**  
SPECIAL CRANES

NKM Noell Special Cranes GmbH  
Kruisweg 643, 2132 NC Hoofddorp, Netherlands  
Tel: +31 20 655 0030 • Fax: +31 20 655 0040  
info@nkmnoell.com • www.nkmnoell.com



W: www.hhi.co.kr/  
 Produces a range of cranes and bulk-handling equipment, including gantry bulk unloaders and rail-mounted grab cranes.

**IBAU HAMBURG**



Roedingsmarkt 39  
 4th Floor  
 Hamburg  
 20459  
 Germany  
 Contact: Mr Mario Raemmele  
 Job Title: Sales Director  
 T: + 49 40 361 309 24  
 F: + 49 40 369 019 62  
 E: mraemmele@ibauhamburg.de  
 W: www.ibauhamburg.de  
 IBAU HAMBURG operates in the field of silo technology for the cement, lime and gypsum industries and for power plants throughout the world. IBAU supplies the marine handling industry, ranging from shore-based terminals to self-unloading cement ships and barges, ship unloaders and loaders and floating terminals, with individual parts to entire turn-key plants, including design and planning, building, start-up and maintenance.

**IBC International Handling AB**

Hamnv. 1  
 Falkenberg  
 S-311 32  
 Sweden  
 Contact: Ms Maria Penca  
 Job Title: Marketing Manager  
 T: + 46 346 569 10  
 F: + 46 346 569 18  
 E: sales@ibc-international.se  
 W: www.ibc-international.se  
 Supplies complete customised bagging systems, including dust-free, filling, emptying /discharging, de-aeration and vibration facilities.

**Igus GmbH**

Spicher Str. 1a  
 Köln  
 D-51147  
 Germany  
 Contact: Mr Theo Diehl  
 Job Title: Head of Intl. Cranes & Materialhandling  
 T: + 49 2203 9649 0  
 F: + 49 2203 9649 222  
 E: cranes@igus.de  
 W: www.igus-cranes.com  
 Products include E-ChainSystems - in operation on Bulkhandling Cranes, Ship to Shore Cranes, RTGs, RMGs, Goliath Cranes, Spreaders, Reach Stacker etc. More than 5.000 port equipment applications are running world-wide with igus® E-Chain Systems.

**IHI Transport Machinery Co., Ltd. (IUK)**



8-1 Seiroka Tower  
 Akashi Cho  
 Chuo-Ku  
 Tokyo  
 104-0044 MZ  
 Japan  
 Contact: Mr Tsutomu Sudo  
 Job Title: Deputy General Manager, Overseas Sales Dept  
 T: + 81 3 5550 5375  
 F: + 81 3 5550 5366  
 E: tsutomu.sudou@iuk.co.jp  
 W: www.iuk.co.jp  
 IUK is a leading supplier of material handling equipment and designs, supplies, and gives specialized services of machinery for loading, unloading, transport and storage of a wide range of materials such as containers, coal, iron ore, coke, bauxite, etc.

**IMASA**

Palacio Valdes 1  
 Oviedo (Asturias)  
 33002  
 Spain  
 Contact: Mr Amancio Garcia  
 T: + 34 985 22 71 78  
 F: + 34 985 22 25 98  
 E: amancio.garcia@imasa.com  
 W: www.imasa.com

**Imperial Technologies, Inc.**

4155 Martindale Rd., NE  
 Canton  
 OH  
 44705  
 USA  
 Contact: Mr Ron Tschantz  
 Job Title: VP Gen Sales & Marketing  
 T: + 1 330 491 3200  
 F: + 1 330 491 3204  
 E: rontschantz@imperial-technologies.com  
 W: www.imperial-technologies.com  
 Has a unique 'Multi-Fold' system that allows belt cover flaps to fold over and enclose the product. This system eliminates spillage and blow-off and can operate at steep angles.

**Impsa - Industrias Metalurgicas Pescarmana**

Carril Rodriguez Pena 2451  
 San Francisco del Monte  
 Godoy Cruz  
 Mendoza  
 5501  
 Argentina  
 Contact: Mr Antonio Urbano  
 T: + 54 261 413 1394  
 F: + 54 261 413 1335  
 E: antonio.urbano@impsa.com  
 W: www.impsa.com  
 Produces Panamax and post-Panamax ship-to-shore bulk cranes and unloaders.

**Incolab**

PO Box 1561  
 Oud-Beijerland  
 BB  
 3260  
 The Netherlands  
 Contact: Mr Leo Van Tour  
 Job Title: Managing Director  
 T: + 31 1866 10355  
 F: + 31 1866 10552  
 E: leo@incolab.com  
 W: www.incolab.com  
 Quality and quantity control in major coal ports worldwide.



**Indexator AB**



Box 11  
 Vindeln  
 SE-922 21  
 Sweden  
 Contact: Ms Camilla Waara  
 T: + 46 933 149 15  
 F: + 46 933 14899  
 E: rotator@indexator.se  
 W: www.indexator.se  
 The wide range of Indexator rotators are suitable for the most demanding materials handling tasks. Our rotators are used worldwide in many industries from forestry to scrap metal, general cargo to materials recycling. The compact, robust and low profile design, combined with the high quality

materials used in construction, ensure a long working life.

**Industrial Netting (Pty) Ltd**

PO Box 39624  
 Bramley  
 Transvaal  
 2018  
 South Africa  
 Contact: Mr Ian Campbell  
 Job Title: Managing Director  
 T: + 27 11 6084686  
 F: + 27 11 6084690  
 E: info@industrialnetting.co.za  
 W: www.industrialnetting.co.za

08403  
 Spain  
 Contact: Mr Xhabby Franco  
 Job Title: Sales Manager  
 T: + 34 93 846 7200  
 F: + 34 93 846 5956  
 E: murtra@murtra.com  
 W: www.murtra.com

**Inman SA**

Av Hermilo Mena N 10  
 San Juan Ixhuatpec  
 Edo de Mexico  
 54180 Mexico  
 Contact: Mr Oscar Calderon  
 T: + 52 55 5718 3036/4536  
 F: + 52 55 5718 3432  
 E: inman@inman.com.mx  
 W: www.inman.com.mx  
 Manufacturer of solid material handling equipment.

**Industrias Murtra**

Jordi Camp 94  
 Apartado 278  
 Granollers  
 Barcelona

## The complete rotator solution

**ELIMINATE DISTRIBUTION VALVE** | Eliminates the need for distribution valve to grapple cylinders.

**COMPLETE SOLUTION** | Swivel, bearings and motor packaged in one well protected rotator.

**HIGH TORQUE VANE MOTORS**  
 The modular design together with few moving parts make these rotators durable and easy to service. Documented long lifetime.

www.indexator.com



**World's No.1 CSU Supplier**



## Best Solution of Bulk Handling

IHI has supported Bulk Handling in the world over a century and continues to do in next 100 years.



### **IHI Product Line up**

- **Continuous Ship Unloader(CSU)**
- **Bridge Type Ship Unloader**
- **Mobile Multi-Purpose Crane**
- **Stacker**
- **Reclaimer**
- **Stacker-Reclaimer**
- **Conveyor**
- **Ship Loader**

**IHI**

**IHI Transport Machinery Co., Ltd.**

8-1, Akashicho, Chuo-ku, Tokyo 104-0044 JAPAN

Website: <http://www.iuk.co.jp/english/index.html>



**Inspectorate America Corporation**



**INSPECTORATE**

12000 Aerospace Avenue  
Suite 200  
Houston  
Texas  
77034  
USA  
Contact: Mr Trace Griglione  
Job Title: Operations Manager  
T: + 1 504 392 7660  
F: + 1 504 393 5248  
E: trace.griglione@inspectorate.com  
W: www.inspectorate.com

**Inspectorate International Ltd**



**INSPECTORATE**

2 Perry Road  
Witham  
Essex  
CM8 3TU  
UK  
Contact: Mr Julian Sowry  
Job Title: Sales & Mktng Mngr,  
Steel & Energy Products  
T: + 44 1376 536849  
F: + 44 1376 520819  
E: client.services@inspectorate.com  
W: www.inspectorate.com



Inspectorate, part of the Bureau Veritas Commodity Division, is one of the world's leading independent inspection companies. We provide services for a full range of metals & minerals commodities including draft surveys, weighing and sampling. Analysis & testing is undertaken through our network of key and specialist laboratory facilities, accredited to ISO 17025.

**Interjute BV**

PO Box 154  
Hulst  
4560 AD  
The Netherlands  
Contact: Mr Ed Wessels  
Job Title: International Sales Manager  
T: + 31 114 311208  
F: + 31 114 311512  
E: ewessels@interjute.nl  
W: www.interjute.com  
50 kg. bags and FIBC's for all purposes. Fast deliveries all over the world.

**International Bulk Handling Technology BV**

PO Box 47  
Mierlo 5730 AA  
The Netherlands  
Contact: Mr Johan M.A.M. Brands  
Job Title: Technical Manager

T: + 31 492 664 885  
F: + 31 492 664 695  
E: info@ibtbulk.nl  
W: www.ibtbulk.nl  
IBT is specialized in designing and turn-key supply of bulk handling systems like troughed belt conveyors, pipe conveyors and beltwall conveyors. With capacities of product conveyed up to 6000 tph major systems in harbors etc. have been supplied by IBT.

**Interstate Equipment Corporation**

929 Park Avenue  
Pittsburgh  
Pennsylvania  
15234  
USA  
Contact: Mr Joe Vogel  
Job Title: Sales Manager  
T: + 1 412 563 5556  
F: + 1 412 563 6741  
E: joevogel@go-iec.com

**Intersystems**

9575 N 109th Ave  
Omaha  
NE  
68142  
USA  
Contact: Mr Ray Vrtiska  
Job Title: VP Sales, Bulk Material Handling

T: + 1 402 330 1500  
F: + 1 402 330 3350  
E: bulkmatl@intersystems.net  
W: www.intersystems.net  
Intersystems has expertise in the engineer and manufacture of bulk weighers, bucket elevators, enclosed belt and en-masse conveyors, gravity screeners, automatic samplers and truck probes, micro ingredient systems, bolted bins and distributors.

**Invicta Vibrators**

Harlaxton Road  
Grantham  
Lincolnshire  
NG31 7SF  
UK  
Contact: Mr Mike Caldwell  
Job Title: Sales Manager  
T: + 44 1476 566301  
F: + 44 1476 590145  
E: mike.caldwell@invictavibrators.co.uk

**iSAM AG Gesellschaft fuer angewandte Kybernetik**

Alexanderstrasse 46  
Mülheim an der Ruhr  
45472  
Germany  
Contact: Dr Juergen Hellmich  
Job Title: Chief Executive Officer  
T: + 49 208 49 585 61  
F: + 49 208 49 585 62  
E: info@isam-ag.de  
W: www.isam-ag.de  
iSAM AG delivers the full range of products and services for advanced automation of bulk material handling and port operations. We handle turn-key solutions for new automation projects as well as the upgrading of existing equipment including project management, electrical engineering and commissioning.

**Isbir Sentetik Dokuma San A.S.**

Izmir Yolu  
Cayirhisar Mevkii  
Balikesir  
10034  
Turkey  
Contact: Mr Tanin Guven  
Job Title: Marketing Manager/Sales Director  
T: + 90 266 283 0000  
F: + 90 266 283 0001  
E: taninguven@isbirsentetik.com  
W: www.isbirsentetik.com

**Isomonte SA**

Rua Cristiano Franca Teixeira  
Guimaraes  
265 Bairro  
Cinco  
Contagem MG  
Minas Gerais  
CEP 32010-130  
Brazil  
Contact: Mr Jose Rubem Almeida  
T: + 55 31 2128 2600 / 2641  
F: + 55 31 3351 4093  
W: www.isomonte.com  
Specialises in the design and construction of turnkey systems for materials handling, including shiploaders/unloaders, mechanical grabs, stackers/reclaimers, shield, belt conveyors and steel structures for handling equipment.

**Italgru S.r.l**

Statale Briantea, 4  
Ambivere  
(BG)  
24030  
Italy  
Contact: Mr Fabrizio Bonfanti  
T: + 39 35 49 32 411  
F: + 39 35 49 32 409  
E: fabrizio.bonfanti@italgru.it  
W: www.italgru.com

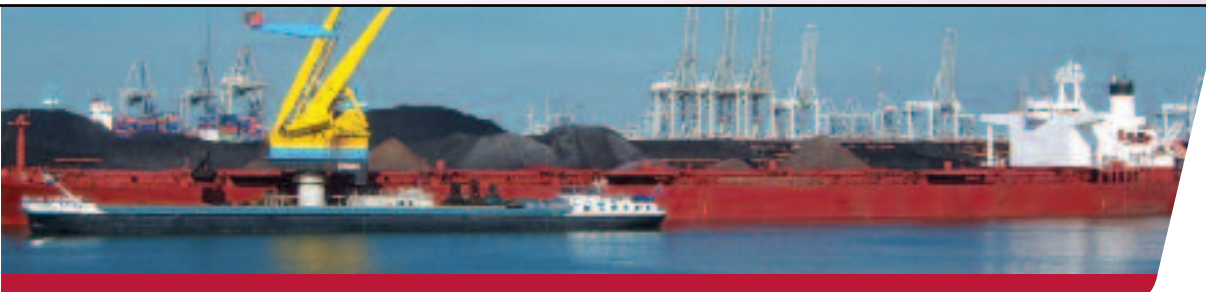

**INSPECTORATE**

At a highly significant time for the world economy, all parts of the mining and trading industries are looking to reduce their risk. Inspectorate's service, therefore, is of paramount importance.

**Bulk Commodities Inspection and Testing**

- We have a presence in all of the world's major metals and minerals importing and exporting countries and undertake independent inspection and testing.
- Our locally based expertise will provide full-service inspection, representative sampling and testing through our network of ISO 17025 accredited laboratories.
- Our clients have the assurance of knowing Inspectorate complies with the highest standards of health, safety and business ethics – we won't let you down.



Bureau Veritas Commodities Division (Inspectorate International Limited)

2 Perry Road, Witham, Essex CM8 3TU, UK

T: +44 1376 536800 E: Client.Services@inspectorate.com www.inspectorate.com/minerals



# J&B GRABS

*With more than 60 years' experience, J&B Grabs is the name you can rely on*



Hydraulic High Volume Grabs



45 m<sup>3</sup> Hydraulic Grab



High Volume Rope Grabs  
31.5m<sup>3</sup>



Hydraulic Rehandling Grab



Hydraulic Cactus Grab (1.6m<sup>3</sup>)

Rope Cactus Grab (10m<sup>3</sup>)

## J&B GRABS FOR ALL KINDS OF BULK HANDLING

### Products:

- Cactus Rope Grabs
- Rehandling Rope Grabs
- Hydraulic Cactus Grabs
- Hydraulic Rehandling Grabs
- Hydraulic Wood Grabs
- Hydraulic Demolition & Sorting Grabs
- Quick Change System
- Multipurpose Spreader

### New Products:

- Big Bag Frame
- Cellulose Frame

All our grabs are custom made, designed and produced to our customers requirements.

J&B Grabs are highly efficient for large volume and low deadweight handling.



### J&B Grabs

PO Box 176, 3454 ZK De Meern  
Netherlands  
Tel: +31 30 662 1616  
Fax: +31 30 666 3765  
E-mail: [info@jb-grabs.com](mailto:info@jb-grabs.com)  
Website: [www.jb-grabs.com](http://www.jb-grabs.com)



**J & B Grabs b.v.**



PO Box 176  
De Meern  
Utrecht  
3454 ZK  
The Netherlands  
Contact: Mr Edgar Joustra  
Job Title: Director  
T: + 31 3066 21616  
F: + 31 3066 63765  
E: info@jb-grabs.com  
W: www.jb-grabs.com  
Designs, engineers and manufactures mechanical and hydraulic grabs for all kinds of bulk material.

**J C Steele & Sons Inc**

710 South Mulberry Street  
Statesville  
NC  
28687  
USA  
Contact: Mr Rick Steele  
Job Title: Marketing Manager  
T: + 1 704 872 3681  
F: + 1 704 878 0789  
E: ricksteele@jcsteele.com  
W: www.jcsteele.com  
Established in 1889, J. C. Steele is the largest producer of heavy clay machinery in the United States. Export sales to many parts of the world make up a large part of total business.

**Jansens & Dieperink BV**

PO Box 436  
Zaandam  
1500 EK  
The Netherlands  
Contact:  
Job Title: Sales Department  
T: + 31 75 616 8555  
F: + 31 75 6168569  
E: info@jansensanddieperink.com  
W: www.jansensanddieperink.com  
Engineering, fabrication and assembly of stainless and aluminium silos and gravity blenders. Dry bulk container with aluminium liner.

**Jem International & Express Scale Parts**

6873 Martindale  
Shawnee  
Kansas  
66218  
USA  
Contact: Mr James Mattson  
T: + 1 913 441 4787 Ext 228  
F: + 1 913 441 1711  
E: info@jemesp.com  
W: www.jemesp.com  
Open-mouth baggings scales.

**Jenike & Johanson Inc.**

400 Business Park Drive  
Tyngsboro  
MA  
01879  
USA  
Contact: Mr Roderick J. Hossfeld  
Job Title: Senior Engineer  
T: + 1 978 649 3300  
F: + 1 978 649 3399  
E: mail10@jenike.com  
W: www.jenike.com  
Our engineering services focus on material flow properties and your

operating conditions to assist you in selecting the right process equipment, or troubleshooting existing equipment. For 50 years, we have tested over 8,000 materials and successfully serviced over 3,500 companies.

**Jim Way Enterprise Co Ltd**

No 17 Chang Tai Street  
Lin Hai Industrial District  
Hsiao Kang  
Kaohsiung  
812  
Taiwan  
Contact: Mr Danny Yang  
Job Title: General Manager  
T: + 886 7 8718126  
F: + 886 7 8718128  
E: jw@roller.com.tw  
W: www.roller.com.tw  
Professional manufacturer established in 1980. Specialize in fabrication of belt conveyor component parts, idler, pulley, belt cleaner, skirtings, impact & wear-resistant products. Has passed ISO 9001 certification, and have more than 22 years' experience devoted to operation international business.

**Johannes Hübner Fabrik Elektrischer Maschinen GmbH**

Siemens Strasse 7  
Giessen  
D-35394  
Germany  
Contact: Mr Matthias Schmidt  
T: + 49 641 79 69 69  
E: matthias.schmidt@huebner-giessen.com  
W: www.huebner-giessen.com

**John R Boone Ltd**

18 Silk Street  
Congleton  
Cheshire  
CW12 4DH  
UK  
Contact: Mr C R Boone  
T: + 44 1260 272894  
F: + 44 1260 281128  
E: sales@jrboone.com  
W: www.jrboone.com

**Joy Mining Machinery**

West Quay Road  
Sunderland Enterprise Park East  
Sunderland  
Tyne & Wear  
SR5 2TD  
UK  
Contact: Mr Paul Bancroft  
Job Title: Sales & Marketing Director  
T: + 44 191 516 5353  
F: + 44 191 516 5399  
E: sales@continental-conveyor.co.uk  
W: www.continental-conveyor.co.uk  
Complete conveyor systems for bulk mineral handling at ports, mines, quarries, process plants. Belt conveyor component manufacturer of idlers, rollers, pulleys, drums and structures. Full range of compact conveyor drives from 20kw to 1000kw.

**JSC Tehnoros**

Gzhatskaya st, 21, liter A  
Saint-Petersburg  
195220  
Russia  
Contact: Mr Maxim Akhmetov  
T: + 7 812 718 82 28 (429)  
E: akhmetov@tehnoros.ru

**Jumbo Shipping**

PO Box 23016  
Rotterdam  
3001 KA  
The Netherlands  
Contact: Ms Dorrie Dijsselbloem  
Job Title: Senior Communications Advisor  
T: + 31 10 7900300  
F: + 31 10 4334624  
E: ddijsselbloem@jumbogroup.nl  
W: www.jumbogroup.nl  
Jumbo is a leading heavy lift shipping company that develops pioneering solutions for ocean transportation. We operate a fleet of 12 specialised heavy lift vessels with a lifting capacity varying from 500t to 1,800t. To cater for ever increasing industry demand two new vessels, with a lifting capacity of 3,000t and built to a Finnish-Swedish ice class 1A, will complement the fleet in 2013.

**KABELSCHLEPP GmbH**

Daimlerstr. 2  
Wenden-Gerlingen  
D-57482  
Germany  
Contact: Mr Frank Springer  
T: + 49 2762 4003 0  
F: + 49 2762 4003 220  
E: info@kabelschlepp.de  
W: www.kabelschlepp.de  
Plastic and Steel Cable Carrier Systems, LIFE-LINE Cables.

**Kalenborn Kalprotect GmbH & Co. KG**

Asbacher Str 50  
Vettelschoss  
D-53560  
Germany  
Contact: Mr Michael Rokitta



Job Title: Managing Director  
T: + 49 26 45 18 196  
F: + 49 26 45 18 180  
E: michael.rokitta@kalenborn.de  
W: www.kalenborn.de

One of the world's leading manufacturers and suppliers for wear resistant linings. Kalenborn provides tailor-made solutions starting from advice to design and manufacturing through to construction and on-site assembly using a wide range of mineral, ceramic, metallic, plastic or rubber materials. The scope of supply covers pneumatic, hydraulic and mechanical conveying including storage in silos and bunkers.

## Kardesler Grab & Machine

Sultan Orhan Mah  
Hasköy Sanayi Sitesi 11/B Blok  
No:24  
Gebze  
KOCAELI  
41400  
Turkey

Contact: Mr Huseyin Isikoglu  
Job Title: Export Manager  
T: + 90 262 6445018  
F: + 90 262 6445017  
E: kardesler@kardeslerkepce.com

W: www.kardeslerkepce.com and  
www.kardeslergrab.com  
Established in Istanbul/Maltepe in 1985, KARDESLER GRAB AND MACHINE first produced grabs for sand. Now products are produced suitable for the needs of the modern age. The company considers quality service and customer satisfaction vital and happily serves clients both in Turkey and foreign countries. Today, to provide better service, clients are served out of its factory in Kocaeli/Gebze Hasköy.

## KCT Grab Industry

Agva cad. yeni sanayi sitesi  
No:3-5  
Sile  
Istanbul  
34980  
Turkey

Contact: Cpt Atilla Kocatas  
Job Title: General Manager  
T: + 90 216 739 59 60  
F: + 90 216 739 59 83  
E: info@kctgrab.com  
W: www.kctgrab.com

We are grab manufacturers, established in 1992. We produce all kinds of mechanical, hydraulic, electro hydraulic clamshell grabs and orange peel grabs, remote control grabs. We have capacity from 0.5 cbm up to 40 cbm. Worldwide sales.

## Kinergy Corporation

7310 Grade Lane  
Louisville  
Kentucky  
40219  
USA

Contact: Mr Bill Ware  
Job Title: Project Manager  
T: + 1 502 366 5685  
F: + 1 502 366 3701  
E: bware@kinergy.com  
W: www.kinergy.com

Kinergy Corporation is a vibratory equipment manufacturer, which includes vibrating screens, feeders, conveyors, bin activators, dryers and coolers, railcar densifiers and dischargers, storage pile dischargers.

## King Bag & Manufacturing Co

1500 Spring Lawn Avenue  
Cincinnati  
OH  
45223  
USA

Contact: Mr Mike Jennings  
T: + 1 513 541 5440 ext 306  
F: + 1 513 541 6555  
E: mike@kingbag.com  
W: www.kingbag.com

## Kingfisher Industrial Ltd

Cradley Business Park  
Overend Road  
Cradley Heath  
West Midlands  
B64 7DW  
UK

Contact: Ms Anita Chumber  
Job Title: Sales & Marketing  
Executive  
T: + 44 1384 410777  
F: + 44 1384 410877  
E: achumber@kingfisher-industrial.co.uk

W: www.kingfisher-industrial.co.uk  
Kingfisher specialises in solving the problems industries encounter when processing bulk solid materials. We offer solution-driven, tailored concepts to counter the detrimental effects of handling and processing abrasive minerals, by employing our extensive expertise in the design, manufacture, wear protection and installation of process plant and equipment used to convey, store or process these materials.

## KINSHOFER GmbH

Hauptstrasse 76  
Waakirchen  
83666  
Germany

Contact: Mr Martin Locher  
T: + 49 8021 8899 0  
F: + 49 8021 8899 37  
E: m.locher@kinshofer.com  
W: www.kinshofer.com

## KIROW ARDELT GmbH

Heegermühler Straße 64  
Eberswalde  
Brandenburg  
16225  
Germany

Contact: Mr Heinz Lindecke  
Job Title: General Manager  
T: + 49 33 3462 2273  
F: + 49 33 3462 2121  
E: Heinz.lindecke@ardelt.de  
W: www.ardelt.de

Produces slewing cranes (double jib, single jib, mobile, balancer cranes) for handling containers, general cargo, bulk and scrap.

## Kleemann GmbH

Hildenbrandstr.18  
Goppingen-Faumdau  
D-73035  
Germany

Contact: Mr Mark Hezinger  
Job Title: Marketing  
T: + 49 7161 206 0  
F: + 49 7161 206 100  
E: info@kleemann.info  
W: www.kleeman.info

## Kocks Krane International GmbH

Weserstrasse 64  
Bremen  
D-28757  
Germany

Contact: Mr Johannes Mosch  
T: + 49 421 6601 311  
F: + 49 421 6601 367  
E: johannes.mosch@kockskrane.de  
W: www.kockskrane.de

Supplies mechanical ship unloaders with grabs and gantry bulk unloaders. The grab-type ship unloaders incorporate a hopper with a dust chamber and an integral water spraying system.

## Konecranes (France)

**KONECRANES**  
L'Équipement des Ports

47 bis Boulevard de Gravelle  
B.P. 727  
Le Havre  
Cedex  
76060  
France

Contact: Mr Gerard Lesueur  
T: + 33 2 35 25 95 14  
F: + 33 2 35 25 95 82  
E: gerard.lesueur@konecranes.com  
W: www.konecranes.com

## Konecranes B.V. - The Netherlands

**KONECRANES**  
L'Équipement des Ports

Eikenburglaan 7d  
Rosmalen  
5248 BJ  
The Netherlands

Contact: Mr A M Versteden  
Job Title: Manager Special Cranes  
T: + 31 735 217 279  
F: + 31 735 217 438  
E: info.nl@konecranes.com

## Konecranes Finland Corporation

**KONECRANES**  
L'Équipement des Ports

PO Box 662  
(Koneenkatu 8)  
Hyvinkää  
FIN-05801  
Finland

Contact: Mr Kimmo Nyman  
Job Title: General Manager, Bulk  
Handling Cranes  
T: + 358 20 427 2740  
F: + 358 20 427 2599  
E: kimmo.nyman@konecranes.com

Specialises in the design, manufacture and delivery of large cranes for ports, terminals and shipyards. Konecranes AGD Grab Unloader features simple rope reeving and standard components with less maintenance. Unloading capacities from 1000tph to 4000tph.

## Konecranes Hafentechnik GmbH

Mühlenfeld 20  
Langenhagen D-30853  
Germany

Contact: Mr Dirk Groth  
Job Title: Manager Marketing &  
Sales Support  
T: + 49 511 7704 418  
F: + 49 511 7704 477  
E: info-hafentechnik@konecranes.com

W: www.konecranes.de  
Services all types of cranes and port handling equipment regardless of manufacturer.

## Kornylak Corporation

400 Heaton Street  
Hamilton  
OH 45011  
USA

Contact: Ms Anne G McAdams  
Job Title: Marketing Manager  
T: + 1 513 863 1277 ext35  
F: + 1 513 863 7644  
E: kornylak@kornylak.com  
W: www.kornylak.com

Produces a variety of freight loading and unloading systems, including roller and conveyor loaders for dry bulk cargoes.

## KPI-JCI

700 West 21st Street  
Yankton  
South Dakota  
57078





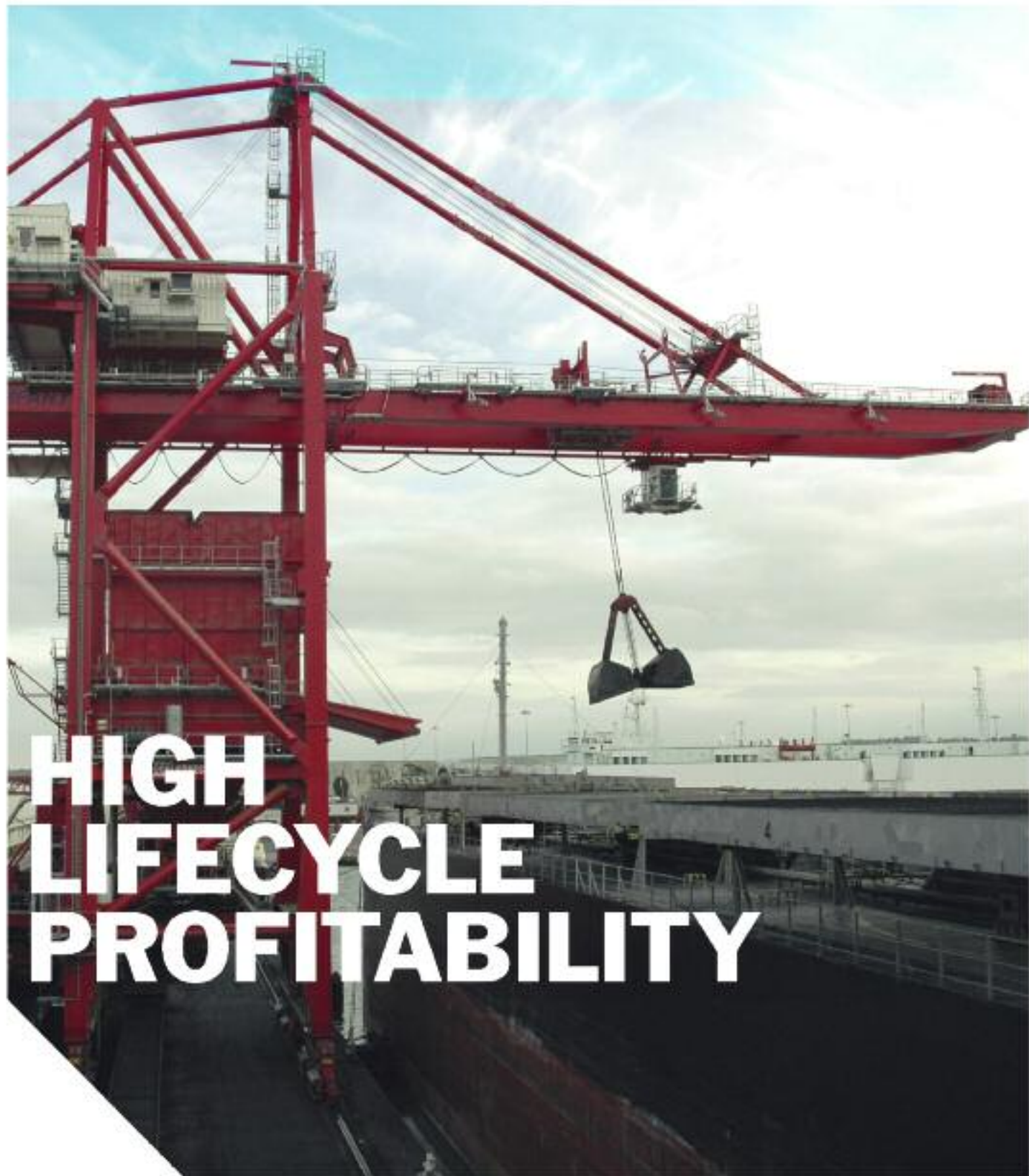

# HIGH LIFECYCLE PROFITABILITY

Konecranes AGD Grab Unloader offers the best lifetime value to you. Simple rope reeving design and use of standard components result in high operational reliability and less maintenance. Your drivers will enjoy the good response time of the modern AGD control system.





PIONEERING RECLAIM  
SOLUTIONS FOR 50 YEARS

**Laidig's success is built on a 50 year history pioneering world class, fully-automated storage and reclaim solutions for hard-to-handle materials. A Laidig system is more than welded steel, it's the product of our highly skilled and dedicated team members, a commitment to lifetime service and support, and our industry leading guarantee...**

***"If we design, and install your storage & reclaim system, we guarantee it will work."***



#### **DOMINATOR™**

TRACK DRIVEN RECLAIM SYSTEM FOR  
DOMES & SUPER SILOS. COST EFFECTIVE  
SOLUTION FOR HIGH VOLUME,  
HARD-TO-HANDLE APPLICATIONS.  
UP TO 120'



#### **FLUIDIZED SCREW™**

HYBRID TECHNOLOGY  
COMBINING AIR SLIDES AND  
MECHANICAL SCREW CONVEYING  
FOR FLUIDIZABLE MATERIALS.  
UP TO 160'



#### **X-TRAKTOR™**

Laidig's largest and most  
rugged reclaim system  
DESIGNED TO START UNDER A  
FULLY LOADED SILOS OR DOMES.  
UP TO 160'



**TOUGH MACHINES FOR  
TOUGH MATERIALS**



Laidig Systems, Inc. 14535 Dragoon Trail, Mishawaka, IN 46544 USA  
+1 574-256-0204 sales@laidig.com

FIND OUT MORE  
[www.Laidig.com](http://www.Laidig.com)



## USA

Contact: Ms Jodi Heirigs  
Job Title: Product Manager,  
Material Handling  
T: + 1 605 668 2590 / + 1 605 665 8771

F: + 1 605 665 8858  
E: jodiheirigs@kolberpioneer.com  
W: www.kpijci.com  
KPI-JCI and Astec Mobile Screens, Astec companies (NASDAQ: ASTE), is a world-wide leader in manufacturing equipment for the aggregate, construction, paving and recycling industries. As an innovative, high integrity manufacturer, KPI-JCI develops quality, state-of-the-art products and has the ability to engineer custom products because of a highly qualified engineering staff. For more information, call (605) 668-2524 or visit the Web site at www.kpijci.com.

## Kramer & Duyvis BV

Mauritsstraat 4  
Zaandam  
1506 TZ  
The Netherlands  
Contact: Mr Rene Blom  
Job Title: Director

T: + 31 75 612 33 49  
F: + 31 75 612 30 06  
E: info@kramer-duyvis.nl  
W: www.kramer-duyvis.nl  
Over 30 years leading in engineering and manufacturing reliable and economical weighing- and dosing systems for high quality dry bulk materials. For user friendly filling your big-bag, FIBC, tote bin, box or drum. Kramer and Duyvis beltconveyors shall change the direction of your general cargo.

## Kranunion

Spinnereistraße 13  
Leipzig  
04179  
Germany  
Contact: Ms Gabriela Schilk  
T: + 49 3 41 49 53 212  
F: + 49 3 41 49 53 125  
E: juergen.kuehn@kirow.de  
W: www.kranunion.de

## Kröger Greifertechnik GmbH & Co. KG

Steinheide 1-9  
Sonsbeck  
D-47665  
Germany  
Contact: Dr Philipp Diekmann  
Job Title: Managing Director  
T: + 49 2838 3750  
F: + 49 2838 3729  
E: info@kroeger-greifertechnik.de  
W: www.kroeger-greifertechnik.de  
Manufacturer of grabs. Main products include two rope grabs, four rope grabs, electro-hydraulic grabs and electro hydraulic grabs from 0.5m3 to 26m3.

## K-T Bulk

27920 Osbourn Road  
Bay Village  
Ohio  
44140  
USA  
Contact: Mr Cornel Muhoray  
Job Title: Director  
T: + 1 216 621 9934  
F: + 1 216 835 3981  
E: cmuhoray@ameritech.net

## Lachenmeier Monsun A/S

Grundtvigs Allé 176  
Sønderborg  
6400  
Denmark

Contact: Mr Chrisitan Petersen  
Job Title: Sales Director  
T: + 45 74 42 24 64  
F: + 45 74 43 04 04  
E: mail@lachenmeier-monsun.com  
W: www.lachenmeier-monsun.com  
Designs and supplies complete plants for the handling of grain and feedstuffs. The product programme includes chain conveyors, belt conveyors and bucket elevators for capacities up to 800tph; compressed-air cleaned filters and drying plants for capacities up to 200tph.

## Laidig Systems Inc



14535 Dragoon Trail  
Mishawaka  
IN 46544  
USA

Contact: Mr Mike Schuster  
Job Title: Vice President  
T: + 1 574 256 0204  
F: + 1 574 256 5575  
E: sales@laidig.com  
W: www.laidig.com  
Laidig Systems, Inc. provides custom-engineered bulk storage silos and automated unloading reclaim systems which offer proven performance and reliability. Known throughout the industry for their rugged, high-quality systems, Laidig excels in innovative, effective designs customized to store and reclaim materials with special handling requirements. Materials meals, wood chips, sawdust, recycled materials, coal, and other industrial materials.

## Laing O'Rourke

973 Fairfield Road  
Private Bag 3  
Mooroooka  
Qld  
4105  
Australia  
Contact: Mr Josh Murray  
T: + 61 7 3308 7619  
F: + 61 7 3892 4371  
E: rlayton@laingorourke.com.au  
W: www.laingorourke.com.au

## Langston Companies Inc

401 East Clay Street  
PO Drawer 350  
Crowley  
LA  
70527-0350  
USA  
Contact: Ms Carla Lormond  
Job Title: Bulk Bag Division Site  
Manager  
T: + 1 337 783 2010  
F: + 1 337 788 1000  
E: clormond@langstonbag.com  
W: www.langstonbag.com

## Lanier & Associates

4101 Magazine Street  
New Orleans  
Louisiana  
70115  
USA  
Contact: Mr E Sorrell Lanier  
T: + 1 504 895 0368  
F: + 1 504 895 0566  
E: info@lanier-engineers.com  
W: www.lanier-engineers.com  
Consulting and design engineers; construction managers for marine terminals worldwide.

## Larox Flowsys Oy

Marssitie 1  
PO Box 338  
Lappeenranta

FIN-53101  
Finland  
Contact: Ms Marjatta Kupias  
Job Title: VP, Marketing  
T: + 358 201 113 323  
F: + 358 201 113 300  
E: marjatta.kupias@larox.fi  
W: www.larox.fi  
Pinch valve and hose pump manufacturer providing solutions for abrasive and aggressive applications in various industries all over the world.

## Larsen & Toubro Limited

Monunt Poonamallee Road  
Manapakkam  
PB No.979  
Chennai  
600089  
India  
Contact: Mr Kumar Vikram  
Job Title: ECC Division  
T: + 91 44 2252 6250  
F: + 91 44 22526993  
E: kvikram@intecc.com

## Larsen & Toubro Limited

Bldg. 'C'  
Powai Campus  
Gate No. 1  
Saki Vihar Road  
Mumbai  
400072  
India  
Contact: Mr Tapan Sen  
T: + 91 22 67050505 x 3385  
F: + 91 22 67051462  
E: Tapan\_Sen@intenc.com

## Lassing Dibben Consulting Engineers Ltd

PO Box 472  
149 North Murray Street  
Trenton  
Ontario  
K8V 5R6  
Canada  
Contact: Mr Harold Dibben  
T: + 1 613 392 9287  
F: + 1 613 394 4173  
E: info@lassingdibben.com  
W: www.lassingdibben.com  
Lassing Dibben specializes in the field of bulk material handling and extensive experience in this field has given Lassing Dibben the capacity to handle all aspects of system design. The highly qualified engineers and technologists work together to design advanced equipment installations meeting specific customer requirements.

## LB Officine Meccaniche S.p.A.

Via Ghiarola Nuova 118/E-F-G  
Fiorano Modenese  
41042  
Italy  
Contact: Mr Erminio Guiducci  
T: + 39 0536 995111  
F: + 39 0536 832812  
W: www.lb-technology.eu

## LC Packaging

Vaartkom 35  
Leuven  
3000  
Belgium  
Contact: Mr Patrick Swinnen  
T: + 32 16 844274  
F: + 32 16 844290  
E: pswinnen@lcpackaging.be  
W: www.lcpackaging.com

## Les Consultants LBCE inc.

40, Rue Ste-Cecile  
Salaberry-de-Valleyfield  
Quebec  
J6T 1L7  
Canada

Contact: Mr François Giguère  
Job Title: Project Manager  
T: + 1 450 371 5722  
F: + 1 450 371 6955  
E: f.giguere@lbcd.org  
W: www.teknika-hba.com  
Multi-disciplinary engineering consultants with emphasis on potable and waste water treatment and material handling.

## Libran Engineering and Services

C-33, First Floor  
Malviya Nagar  
New Delhi  
110 017  
India  
Contact: Mr Anil Seth  
Job Title: Director  
T: + 91 11 266 71658  
E: libranengineering@gmail.com  
W: www.libranengineering.com

## Librawerk Maschinenfabrik GmbH

Vossenkamp 1  
Braunschweig  
Lower Saxony  
D-38104  
Germany  
Contact: Mr Klein  
T: + 49 531 370980  
F: + 49 531 3709888  
E: info@librawerk.de  
W: www.librawerk.de  
Fully automatic and semi automatic bagging units for open mouth and valve bags for almost all kinds of bulk goods. Big bag filling machines with a weighing range of up to 2,000kg, with capacities from 5 to 60 bags/hour. Fully automatic and semi automatic bagging units for open mouth and valve bags for almost all kinds of bulk goods. Big bag filling machines with a weighing range of up to 2,000kg, with capacities from 5 to 60 bags/hour.

## Liebherr Brasil - Port Equipment

Latin America  
Rua do Rocio, 288  
Salas 81/82  
Vila Olimpia  
Sao Paulo

SP  
04552-000  
Brazil  
Contact: Mr Joao Cagnoni  
Job Title: Sales Manager  
F: + 55 11 3845 7268  
W: www.liebherr.com

## Liebherr-Hydraulikbagger GmbH

Liebherrstrasse 12  
Kirchdorf  
88457  
Germany  
Contact: Mr Thomas Baeuerle  
T: + 49 7354 80 0  
F: + 49 7354 80 7294  
E: info@ihb.liebherr.com

## Liebherr-Singapore Pte Ltd

No. 8 Pandan Avenue  
Singapore  
609384  
Singapore  
Contact: Mr Yong Soon-Huatt  
Job Title: General Manager  
T: + 65 6265 2305 ext 218  
F: + 65 6261 6485  
E: soonhuat.yong@liebherr.com  
W: www.liebherr.com

## Liebherr-Werk Nenzing GmbH



Dr. Hans Liebherr Str. 1  
Nenzing  
A-6710  
Austria  
Contact: Mr Leopold Berthold  
Job Title: Sales Director  
T: + 43 50809 41725  
F: + 43 50809 41447  
E: mobile.harbour.crane@liebherr.com  
W: www.liebherr.com  
The Liebherr-Werk Nenzing GmbH manufactures and markets an extensive range of product lines including ship cranes, offshore cranes, mobile harbour cranes and reachstackers. On the international building machinery market Liebherr is the leading producer of universal duty cycle crawler cranes, lift cranes as well as deep foundation equipment.







Hopper cars for ship unloading



## Experience and Know How

Planning,  
manufacturing  
and assembling

Loibl Allen-Sherman-Hoff GmbH  
Arberstr. 40  
D 94315 Straubing Germany  
Phone +49 9421 9256 0  
Fax +49 9421 9256 25

[mail@loibl.biz](mailto:mail@loibl.biz)  
[www.loibl.biz](http://www.loibl.biz)

Always the right  
solution for  
your material!



Ship loading systems



Conveying systems at the harbor

**Plant  
engineering  
and material  
handling  
technologies**

# Mack

## Manufacturing Grapples & Buckets

### “Quality First”

### Since 1942



[www.mackmfg.com](http://www.mackmfg.com)



7205 Bellingrath Road, P.O. Box 1559, Theodore, Alabama 36590, USA  
Fax: +1-251-653-1365

Email: [sales@mackmfg.com](mailto:sales@mackmfg.com)

Telephone: +1-251-653-9999  
Website: [www.MackMfg.com](http://www.MackMfg.com)



## Listenow GmbH & Co.



Dieselstrasse 21  
Rutesheim  
71277  
Germany  
Contact: Mr Carsten Lohr  
T: + 49 7152 50900  
F: + 49 7152 509050  
E: c.lohr@listenow.com  
W: www.listenow.com  
Products manufactured include: -  
Loading Systems - Loading Hoses  
(PU-flex, an own brand) - Filters,  
Positioning Aids (LIS-pos), Folding  
Steps (LIS-klapp) - Winches

## Lochtec ApS

Bregnerødvej 157 Agervang 7  
Kr. Hyllinge  
4070  
Denmark  
Contact: Mr Thomas Locht  
T: + 45 4581 6942  
E: lochtec@lochtec.dk  
W: www.lochtec.dk  
Danish agency representing leading  
European producers at the Danish  
marked.

## Logmarin Advisors Srl



Via Ilva, 2/9  
Genova  
16128  
Italy  
Contact: Mr Mario Terenzio  
Job Title: Managing Director  
T: + 39 010 538 5723  
F: + 39 335 5828054  
E: mario.terenzio@logmarin.net  
W: www.logmarin.net  
Scope of business is to provide an  
integrated and comprehensive  
advisory service for marine terminals  
and associated handling  
infrastructures both off-shore and on-  
shore. Logmarin individuals and its  
associates have pioneered dry-bulk  
shipping logistics off-shore devising  
and designing innovative floating  
terminals, self unloading vessels and  
floating cranes.

## LogSys NV

Land Van Waaslaan 5  
Haven 1213  
Kallo  
B-9130  
Belgium  
Contact: Mr Etienne Leneveu  
Job Title: General Manager  
T: + 32 3 540 5670  
F: + 32 3 755 89 61  
E: hdehondt@logsys.eu  
W: www.logsys.eu  
LogSys has developed  
LGS.Stevedore, a terminal operating  
system perfectly suited for dry bulk  
and multipurpose terminals. Together  
with other modules for road transport,  
forwarding, maintenance and repairs,  
LGS.Stevedore forms the LogSys  
Global Solution, a full range  
management system for port logistics.

## Loibl Allen-Sherman-Hoff GmbH



Anlagenbau und Foerdertechnik  
Arberstrasse 40  
Straubing  
D-94315  
Germany  
Contact: Mr Arthur Joseph Loibl  
Job Title: Managing Director

T: + 49 9421 92560  
F: + 49 9421 925625  
E: arthur.loibl@loibl.biz  
W: www.loibl.biz  
For more than 42 years the Plant  
Engineering and Materials Handling  
Technology Arthur Loibl GmbH has  
made conveying and recycling plants  
for bulk material of all types e.g. ship  
loading plants; troughed belt, sidewall  
belt, belt and chain, apron, scraper  
and troughed chain conveyors; wet  
slag dischargers, charging boxes;  
screening and crushing plants.

## Macawber Engineering, Inc

1829 Clydesdale Street  
Maryville  
TN  
37801-3796  
USA  
Contact: Mr John Bell  
Job Title: Process Automation  
T: + 1 865 984 5286  
F: + 1 865 977 4131  
E: macawber@macawber.com  
W: www.macawberengineering.com  
Specializing in low-velocity, dense-  
phase pneumatic conveying  
solutions and installations worldwide  
for over 30 years.

## MacGREGOR Group AB

PO Box 4114  
Gothenburg  
40040  
Sweden  
Contact: Mr Hans Ohlsson  
Job Title: Sales Manager  
T: + 46 318 50900  
F: + 46 318 50901  
E: hans.ohlsson@macgregor-  
group.com  
W: www.macgregor-group.com

## Machinefabriek Stramproy SA

Industrieweg 20  
Stramproy  
AP  
6039  
The Netherlands  
Contact: Mr Roel Lebens  
T: + 31 495 56 1532  
F: + 31 495 56 2942  
E: r.lebens@stramproy.nl  
Suppliers of silos.

## Mack Manufacturing Inc



PO Box 1559  
7205 Bellingrath Road  
Theodore  
Alabama  
36582  
USA  
Contact: Mr Matthew A. Davidson  
Job Title: Vice President -  
Marketing  
T: +1 251 653 9999  
F: +1 251 653 1365  
E: sales@MackMfg.com  
W: www.mackmfg.com  
Manufacturing all sizes and styles of  
grapples and clamshell buckets.  
Specializing in customized electro-  
hydraulic, diesel powered, and remote  
controlled crane attachments.

## Mactenn Systems Ltd.

One Bull Lane  
Acton  
Sudbury  
Suffolk  
CO10 0BD  
UK  
Contact: Mr Lee Suckling



Job Title: Director, Sales &  
Application Engineering  
T: + 44 1787 882 422  
F: + 44 1787 882 433  
E: sales@mactenn.com  
W: www.mactenn.com  
Mactenn Systems designs and  
manufactures dense phase pneumatic  
conveying systems. As a company we  
have over 35 years of experience with  
the conveying of a wide range of bulk  
materials within our specialist areas  
of: The Power, Minerals, Chemicals,  
Food, Biomass, Metals and Plastics  
industries.

## Mahr GmbH Anlagentechnik fur Schuttguter

Rheingastrasse 100  
Wiesbaden  
D-65203  
Germany  
Contact: Herr Dipl.-Ing. Dieter Bee  
Job Title: Marketing Manager  
T: + 49 611 967 64 0  
F: + 49 611 967 64 19  
E: Mahr.Anlagentechnik@t-online.de  
W: www.mahr-gmbh.de

## Manitowoc Engineering

500 South 15 Street  
Manitowoc  
WI  
54220  
USA  
Contact:  
T: + 1 920 683 6510  
F: + 1 920 683 6277  
E: tcioni@manitowoccranes.com  
W: www.manitowoccranes.com  
Manufacturer of lattice-boom cranes  
and attachments with lifting capacities  
from 73 to 1300 tonnes and excavator  
capacities from 9 to 22.6 tonnes.

**LISTENOW**  
VERLADESYSTEME FÜR SCHÜTTGÜTER

**Stop spillage when loading bulk goods!**

Load all your bulk goods efficiently and without harming the environment.  
From A for ash to Z for zinc.

- **Tailor-made** Designed to match the product
- **Effective** Dedusting system
- **Economic** Robust system design
- **Flexible** After-sales service
- **Loading hoses** Made in-house with fast turnarounds

**www.listenow.com**

Listenow GmbH & Co.  
Dieselstrasse 21 • D-71277 Rutesheim  
Tel: +49 (0) 71 52 / 50 90-0 • Fax: +50  
E-Mail: listenow@listenow.com



2006

HybriLift®

Testing and Development

2008

200 HybriLift® into  
Production and Operation

2010

120 HybriLift® into  
Production and Operation

2011

160 HybriLift® into  
Production and Operation

2012

Brand new 90 HybriLift® is  
Launched and in Operation

MANTSINEN HybriLift®

Increases  
Energy Efficiency  
by up to

35%

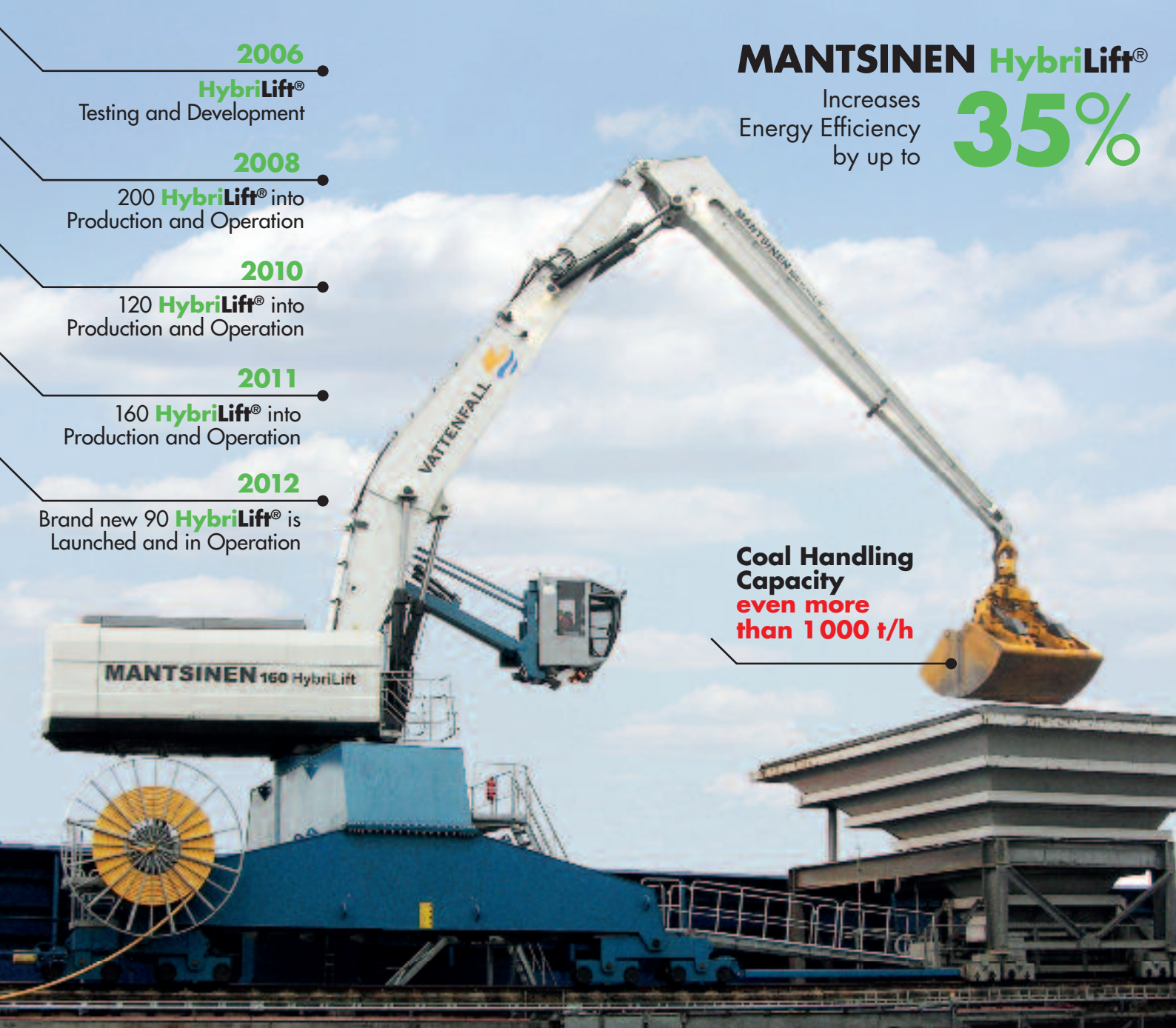

Coal Handling  
Capacity  
even more  
than 1 000 t/h

MANTSINEN HybriLift® lifts your efficiency to the next level with hydraulic precision

**OUR HYBRID EVOLUTION IN ACTION**



**More load, less energy**

[www.mantsinen.com](http://www.mantsinen.com)



**Mantsinen Group Ltd Oy**



Valikankaantie 3  
Ylamylly  
FIN-80400  
Finland  
Contact: Mr Tapio Ingervo  
Job Title: Sales and Marketing  
Director  
T: + 358 20 755 1230  
F: + 358 13 252 5555  
E: tapio.ingervo@mantsinen.com  
W: www.mantsinen.com  
Mantsinen is a forerunner of material handling and logistics in ports, terminals and industry. Mantsinen material handling machines can be tailored to best suit each application. Mantsinen HybrILift® energy saving system and wide range of attachments makes the cranes economical, efficient and universal tools for stevedoring companies and harbour operators.

**Maquinas Condor SA**

Av Dos Estados 1383  
Porte Alegre  
RS  
90200-001  
Brazil  
Contact: Mr Carlos Roberto Fritsch  
Job Title: Director  
T: + 55 51 2104 3388  
F: + 55 51 2104 3345  
E: condor@maquinascondor.com.br  
W: www.maquinascondor.com.br  
Founded 1959. Engineers and manufactures complete systems for solid bulk materials handling ports and terminals. Equipment range includes pneumatic grain unloading, continuous shiploading, bulk stacking, reclaiming, belt conveyor, bucket elevator and mechanical conveyor. Operating from barges up to capesize ships, to 3000 tph. Shipunloaders and shiploaders operating successfully in ports around the world.

**Marine Inspection and Logistics**

408 Richmond Avenue  
Point Pleasant Beach  
New Jersey  
08742  
USA  
Contact: Ms Marylon Cresitelli  
Job Title: inspection Advertiser  
T: + 1 732 899 0500  
F: + 1 732 899 0518  
E: mpl@midship.com  
W: www.midship.com

**Marsden Weighing Machine Group Ltd**

Anvil House  
Tuns Lane  
Henley-on-Thames  
Oxfordshire  
RG9 1SA  
UK  
Contact: Ms Sally Toohar  
Job Title: Marketing Manager  
T: + 44 845 130 7330  
F: + 44 845 130 7440  
E: sallytoohar@marsdengroup.demon.co.uk  
W: www.marsden-weighing.co.uk

**Martin Engineering**



One Martin Place  
Neponset  
Illinois  
IL 61345  
USA  
Contact: Ms Elizabeth Allen  
Job Title: Senior Global Marketing  
Analyst  
T: + 1 309 852 2384  
F: + 1 800 814 1533  
E: info@martin-eng.com  
W: www.martin-eng.com  
Established in 1944, Martin Engineering is the leading international developer, manufacturer and supplier of innovations to make the handling of bulk materials cleaner, safer and more productive. Martin offers technologies that boost flow, reduce dust and spillage, extend component life and reduce downtime, resulting in improved environments and increased profitability.

**Martin Engineering c/o GSFA Consulting**

115 Etna Road, Suite E  
Lebanon  
NH  
03766  
USA  
Contact: Ms Bonnie Govin  
Job Title: Research Analyst  
T: + 1 603 443 9600  
F: + 1 603 443 9911  
E: bgobin@gsfa-consulting.com

**Martin Engineering GmbH**

In der Rehbach 14  
Walluf  
D-65396  
Germany  
Contact: Mr Michael Hengl  
Job Title: General Manager  
T: + 49 6123 978 20  
F: + 49 6123 755 33  
E: info@martin-eng.de  
W: www.martin-eng.de  
Equipment for Bulk Material Handling.  
We make your bulk material handling cleaner, safer and more productive.



**Martin Engineering South Africa**

PO Box 12696  
Leraatsfontein  
1038  
South Africa  
Contact: Mr Hannes Kotze  
Job Title: Managing Director  
T: + 27 13 656 5135  
F: + 27 13 656 5129

E: hannesk@martin-eng.co.za  
W: www.martin-eng.co.za  
Installation & Maintenance of belt cleaners, sealing systems, impact support, belt tracking, air-cannons, screen vibrators, silo cleaning, service contracts, Martin Engineering Service Group - MESH S Class air supported conveyors, Inertial Flow chutes.

**Mining isn't about handling material. It's about HAULING MASS.**

**And it requires bigger, stronger & tougher equipment.**

**When you need to HAUL MASS turn to Martin Engineering.**

Introducing the all new EVO® Heavy Duty product line from Martin Engineering specifically designed for mine duty applications. Our EVO® product line has been expanded for high speed, high impact applications like mining, with the same modularity, serviceability and ergonomic design as all our other EVO® products.

**Problem Solved™**

call **800-544-2947** | email **info@martin-eng.com**  
visit **HAULMASS.com**

© Registered trademark of Martin Engineering Company in the US and other select locations.  
© 2012 Martin Engineering Company. Additional information can be obtained at www.martin-eng.com/trademarks. A global company.





## Solid track record

Metso railcar dumpers keep you moving in the right direction

For over a century, Metso's rotary railcar dumpers have set industry standards worldwide. Our custom-designed systems can service trains of any length or style. Single, tandem and triple dumpers are engineered to provide long life and low maintenance in dumping all manner of bulk materials.

Additionally, Metso's railcar positioners are designed to move individual cuts of 1-10 cars, up to entire unit trains in excess of 200 railcars. When combined with our dumpers, the complete railcar system provides fast, dependable train turnaround requiring only one operator; yet another reason you can rely on Metso's equipment and reputation. **They're both rock solid.**



**Maschinen und Mühlenbau  
Erhard Muhr GmbH**



Grafenstraße 27  
Brannenburg  
D-83098  
Germany  
Contact: Mr Roland Muhr  
Job Title: Managing Director  
T: + 49 8034 9072 26  
F: + 49 8034 9072 526  
E: info@muhr.com  
W: www.muhr.com  
MUHR offers a wide range of high quality Bulk Loading Systems (for open and closed, dust-free loading), Loading Spout Positioners, Pneumatical Docking Devices and even Railcar Dumping Systems for economical unloading of trains with open railcars.

**Matador as**

Terézie Vansovej 1054/45  
Puchov  
020 32  
Slovakia  
Contact: Mr Dusan Michalko  
Job Title: Marketing Manager  
T: + 421 42 461 3192  
F: + 421 42 461 3232  
E: dusan.michalko@matador.sk  
W: www.matador.sk  
Producer and supplier of textile and steel cord conveyor belts for the mining and construction industries. Innovative products include the shockbelt with carcass EPP, the firebelt - fireproof conveyor belt and the thermbelt with cover rubber 'T+' resistance of higher temperatures.

**Matcon**

Matcon House  
London Road  
Morton in Marsh  
Gloustershire  
GL56 08J  
UK  
Contact: Mr Simon Gibson  
T: + 44 1608 651666  
F: + 44 1608 651635  
E: s.gibson@matcon.co.uk  
W: www.matcon-cone.com  
Specialises in powder handling and processing systems for the chemical industry. Manufactures metal powder silos and IBCs.

**MATEC massagoed techniek BV**

PO Box 707  
Amersfoort  
3800 AS  
The Netherlands  
Contact: Mr Marc Fischer  
T: + 31 33 475 2653  
F: + 31 33 472 9724  
E: info@matec.nl  
W: www.matec.nl  
An independent distributor. Offers a wide range of bulk handling equipment and components. Bulk-bag handling, tubular chain conveyors, vibrating feeders, sieves, rotary valves, also for high temperature.

**Material Handling Asia**

2/70 Tossapol Land 4 Floor  
14 Bangna-Trad road  
Bangkok  
Bangna  
10260  
Thailand  
Contact: Miss Witchanee Namthip  
T: + 66 027443180

F: + 66 027443177  
W: www.j-tecasia.com/

**Mentor Dynamics**

170 Penrod Court  
Glen Burnie  
Maryland  
21061  
USA  
Contact: Mr Don Watts  
Job Title: President  
T: + 1 410 760 6349  
F: + 1 410 760 8284  
E: don.watts@MentorDynamics.com  
W: www.mentordynamics.com  
Company designs, fabricates, and installs high performance polymer liners for ships, barges and docking facilities.

**Merius OY**

BOX 17 / Satamatie 330  
Kokkola 67101  
Finland  
Contact: Mr Hannu Sarja  
Job Title: Managing Director  
T: + 358 6822 4882  
F: + 358 6822 4883  
E: hannu.sarja@merius.fi  
W: www.merius.fi  
Merius Ltd. is a mechanical design & engineering company from Kokkola, Finland. We provide conceptual & detailed design, cost calculation and project management services. Our field of expertise consists from technical, steel structure, plant and product design. Our clients are from various fields of industry.

**Merrick Industries**

10 Arthur Drive  
Lynn Haven  
FL 32444

USA  
Contact: Mr Ron Selbe  
Job Title: Sales Manager  
T: + 1 850 265 3611  
F: + 1 850 265 9768  
E: info@merrick-inc.com  
W: www.merrick-inc.com  
Merrick Industries is the leader in continuous weighing and feeding solutions since 1908. Merrick designs, manufactures, and supports all of our products at our Lynn Haven, Florida, plant for the Cement, Mining, Lime, Gypsum, Steel, and Aggregates industries. Products include belt conveyor scales, weighbelt feeders, impact flowmeters and apron feeders.

**METSO**



Bulk Materials Handling  
4000 Town Center Boulevard  
Suite 400  
Canonsburg  
PA 15317  
USA  
Contact: Mr Tom Lippencott  
Job Title: VP Mining Capital Sales,  
USA & Canada  
T: + 1 412 269 5137  
F: + 1 412 269 5212  
E: Tom.Lippencott@metso.com  
W: www.metso.com  
Manufacturer of large-scale equipment and systems for the handling of minerals and bulk materials in the mining, power, shipping and heavy industrial markets. Along with its products, the company provides field service and

replacement parts. Metso Mining & Construction Technology business line.

**Metso Minerals (UK) Ltd**

Parkfield Road  
Rugby  
Warks  
CV21 1QJ  
UK  
Contact: Mr Nick Smith  
Job Title: Business Development  
Manager  
T: + 44 117 978 6211  
F: + 44 117 923 1603  
E: nick.smith@metso.com  
W: www.metsominerals.com  
Metso is a specialist leader of bulk materials handling equipment, from standard products through to bespoke solutions. Operating on a global basis with design and project offices in key locations, involved in projects worldwide.

**MH Automation International  
Ltd**

13 Swift Business Centre  
East Moors  
Keen Road  
Cardiff  
CF24 5JR  
UK  
Contact: Mr Robin Evans  
Job Title: Managing Director  
T: + 44 2920 253300  
F: + 44 2920 253303  
E: mail@mhai.co.uk  
W: www.mhai.co.uk

Loaders



Railcar dumpers



www.muhr.com



# Flexicient.

More flexible. More efficient.

**Muhr bulk loading systems**  
MVS | MBG | MBO

The flexible and world-wide largest product range. Closed, open, combined. Of course dust-free. With individual adaptation modules. More efficiency due to a reduction of operating costs by up to 50 %.

**Muhr railcar dumpers**  
L-Tec | L-high Tec

Dumps up to ten railcars at the same time without a height limit. Space-saving due to the unique Muhr compact design. More flexible and more efficient.

For more information  
please call now:  
+49 (0)8034 9072-0

Muhr GmbH  
Grafenstraße 27  
83098 Brannenburg/Germany

info@muhr.com  
www.muhr.com

**4E** Experienced. Esprit.  
Efficient. Exact.  
The Muhr 4E Concept.

## Midwest Industrial Supply Inc

PO Box 8431  
Canton  
OH 44711  
USA  
Contact: Ms Julie Mamula  
Job Title: Marketing  
T: + 1 330 456 3121  
F: + 1 330 456 3247  
E: julie.mamula@midwestind.com  
W: www.midwestind.com

A complete line of dust control, erosion control, soil stabilization, lubrication, anti-icing and de-icing products that are developed by their staff of chemists, manufactured in its plants across the US and backed by a complete range of services, equipment, expertise and technical support.

## Midwest International Standard Products, Inc.

105 Stover Road/ PO Box 438  
Charlevoix  
MI 49720  
USA

Contact: Mr Walter Pair  
Job Title: Director of Operations  
T: + 1 231 547 4000  
F: + 1 231 547 9453

E: sales@midwestinternational.com  
W: www.midwestmagic.com  
Founded in 1967. Focuses on dust free loading and stockpiling of dry bulk products. The pre-engineered product line has throughput capacities to 1400 STPH and useful vertical travels to 45 feet. The engineered systems product line has capacities to 6000 STPH and vertical travels to 100 feet. The dust free shiploading systems are used by governments and industries in over 50 countries.

## Mitchell Consulting Group, Inc

Green Spring Station  
PO Box 1116  
Brooklandville  
MD  
21022-1116  
USA  
Contact: Mr Walter Mitchell  
T: + 1 410 828 9371  
F: + 1 410 828 9372  
E: mitgroup@verizon.net  
W: www.mitchellonline.org

Mitchell Consulting conducts rigorous research, analysis and advisory into strategic and economic issues relating to marine transportation of all seaborne commodities. Since 1995, our clientele has benefited from keen insight into the markets surrounding local, regional and global seaborne transport of liquids and dry bulk commodities.

## Mitsubishi Heavy Industries

Steel Structure Systems  
International Ops Dept.  
5-1 Marunouchi  
2-Chome  
Chiyoda-ku  
Tokyo  
100-8315  
Japan

Contact: Mr Naochika Nanba  
Job Title: Managing Director  
T: + 81 3 3212 3111  
F: + 81 3 3212 9823  
E: naochika-nanba@hq.mh.co.jp  
W: www.mhi.co.jp

Produces mechanical and pneumatic ship loaders and unloaders, ship-mounted equipment, conveyors and components, stackers and reclaimers, weighing systems and automation equipment.

## Mitsubishi Nagasaki Machinery

1-2-1 Fukahorimarchi  
Nagasaki  
Japan  
Contact: Mr Kazuhiro Aritsuka  
Job Title: Export Department  
T: + 81 958 71 6106  
F: + 81 958 71 3576  
E: aritsuka@mnm.co.jp  
W: www.mnm.co.jp

## Mitsui Engineering & Shipbuilding Co

6-4 Tsukiji  
5-Chome  
Chou-ku  
Tokyo  
104  
Japan  
Contact: Mr Nakajo  
Job Title: General Manager  
T: + 81 3 3544 3398  
F: + 81 3 3544 3031  
E: shipsale@mes.co.jp  
W: www.mes.co.jp

## Mitsui Miike Machinery Co., Ltd.

Nihonbashi-Muromachi 2-1-1  
Chuo-ku  
Tokyo  
103-0022  
Japan  
Contact: Mr Hachiro Naito  
Job Title: General Manager,  
Material Handling Machinery  
T: + 81 3 3270 2001  
F: + 81 3 3245 0203  
E: soumu@mitsuimiike.co.jp  
W: www.mitsuimiike.co.jp

## Mitsui Zosen Europe Limited

Level 16, City Tower  
40 Basinghall Street,  
London  
EC2V 5DE  
UK  
Contact: Mr M Higashino  
T: + 44 20 7256 7171  
F: + 44-20 7256 7272  
E: info@dg.mitsui.com  
W: www.mes.co.jp/english/

## Mogensen Sizers

Haraxton Road  
Grantham  
Lincolnshire  
NG31 7FF  
UK  
Contact: Mr James Hornsey  
Job Title: Sales Manager  
T: + 44 1476 566301  
F: + 44 1476 590145  
E: james.hornsey@mogensen.co.uk  
W: www.mogensen.co.uk

## Mole-Master Services Corporation™

27815 State Route 7  
Marietta  
Ohio  
45750  
USA  
Contact: Mr David Laing  
Job Title: General Manager  
T: + 1 740 374 6726  
F: + 1 740 374 5908  
E: contact@molemaster.com  
W: www.molemaster.com  
Silo, Bin, Bunker, Transport and Process Vessel clearing, cleanout, cleaning and unlogging services or equipment. Mole-Master™ has over two decades of experience solving material build up problems in over 33 countries. Safely return any storage vessel to original capacity fast!

## Möllers Maschinenfabrik GmbH

Sudhoferweg 93-97  
Beckum  
D 59269  
Germany  
Contact: Mrs Nadine Kipphardt  
Job Title: Head of Marketing  
T: + 49 2521 88 152  
F: + 49 2521 88 100  
E: info@moellers.de  
W: www.moellers.com  
Möllers is a worldwide leading manufacturer of machines and plants for the automatic filling of bulk materials, palletizing and loading of bags and other lots as well as for the packaging of pallets and other dispatch units in shrink and stretch films.

## Motherwell Automation

10 Sangiorgio Court  
Osborne Park  
West Perth  
WA  
6017  
Australia  
Contact: Mr Chris Watson  
Job Title: Marketing Manager  
T: + 61 8 9212 4444  
F: + 61 8 9212 4479  
E: ttownsend@motherwell.net.au  
W: www.motherwell.net.au  
Specialises in industrial control and automation equipment, including PLCs, MMIs and computers. Recent contracts have included automation of grain terminals.

## Motridal SpA

Via Pietro Bubba 17  
Piacenza  
Piacenza

29100  
Italy  
Contact: Mr Giampietro Calvi  
Job Title: Sales Manager  
T: + 39 0523 59 66 11  
F: + 39 0523 59 01 28  
E: motridal@motridal.com  
W: www.motridal.com

Specialist, with over 50 years experience, in heavy duty, high capacity machines, intended for operating under severe condition in cement factory, harbour terminal, steel works, power plant, aluminium smelter. Product line includes screw, chain, belt and pipe conveyors, bucket elevators, stackers. Worldwide operation.

## MRS Greifer GmbH



Talweg 15-17  
Helmstadt-Bargen  
D-74921  
Germany  
Contact: Mrs Karin Greulich  
Job Title: Export Manager  
T: + 49 7263 912 915  
F: + 49 7263 912 912  
E: export@mrs-greifer.de  
W: www.mrs-greifer.de  
Approaching more than 40 years experience in producing all types of grabs. The company's product range extends from mechanical grabs, also radio-controlled, to hydraulic and electro-hydraulic grabs. MRS has an excellent after-sales and repair service, provide spare parts from stock and supply parts for a long period after delivery.

## Mühlen Sohn GmbH & Co. KG

P.O. Box 1165  
Blaustein  
D-89130  
Germany  
Contact: Mrs Karin Albrecht  
Job Title: Sales Manager Fluitex  
T: + 49 7304 801 33  
F: + 49 7304 801 23  
E: albrecht.karin@muehlen-sohn.de  
W: www.muehlen-sohn.de  
Mühlen Sohn GmbH & Co. KG is one of the leading suppliers of fluidising fabrics and looks back to a success story since 1880 which means more than 130 years of weaving experience. Fluitex® air slide fabrics for pneumatic loading and unloading systems, airslides for pneumatic conveying, storage and homogenising silos, discharging cones, fly ash handling systems.

## Muller Beltex BV

Ambachtsweg 28A  
Pijnacker  
2641 KS  
The Netherlands  
Contact: Mr Frits Muller  
T: + 31 15369 5444  
F: + 31 15369 7864  
E: info@mullerbeltex.com  
W: www.mullerbeltex.com  
Produces conveyors and conveyor components, including elevator belting.

## MUT - Maschinen-

Umwelttechnik Transportanlagen  
Schiesstaltgasse 49  
Stockerau  
2000  
Austria

**ROPE GRABS**  
**MOTOR GRABS**  
**HYDRAULIC GRABS**

**in all executions for each handling**

The perfect grabs with unbeatable handling  
The most economic solution in grab construction.

**MRS Greifer GmbH**  
Talweg 15-17 · 74921 Helmstadt/Germany  
Tel. +49-72 63-91 29-0 · Fax +49-72 63-91 29 12  
email: info@mrs-greifer.de · www.mrs-greifer.de





77240-0563  
USA  
Contact: Mr Ann Hutchinson  
T: + 1 832 467 3636  
F: + 1 832 467 3800  
E: ben@navco.us  
W: www.navco.us

**Nectar Group Ltd**

No 1 Ashton Gate  
Ashton Road  
Harold Hill  
Romford  
Essex  
RM3 8UF  
UK  
Contact: Mr Chris Leonard  
Job Title: Commercial Manager  
T: + 44 1708 386 555  
F: + 44 1708 386 665  
E: nectar.uk@nectargroup.net  
W: www.nectargroup.net  
Nectar Group is involved in handling and bagging of bulk commodities such as wheat, rice, sugar and fertilizers in ports and at inland locations. The Group's main activity includes positioning of its own mobile bagging equipment for handling one-off discharge and bagging contracts, Period Leases or Sales of bagging equipment. Nectar also provides lightening, expediting as well as bulk terminal management and consultancy services.

**Negrini Srl**

via E. Torricelli n.4  
Castelfranco Emilia  
Modena  
41013  
Italy  
Contact: Mr Rossetti Alessandro  
T: + 39 059 923110  
F: + 39 059 920378  
E: info@negrini.org  
W: www.negrini.org  
Negrini srl considers the attainment of

client satisfaction our primary objective, through a continuous and effective process of study and collaboration with both clients and suppliers. Professionalism and versatility towards different customer demands: this is the business philosophy of Negrini srl.

**Nemag BV**

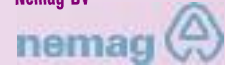

Deltastraat 15  
PO Box 110  
Zierikzee  
4300 AC  
The Netherlands  
Contact: Mr Riny Stoutjesdijk  
Job Title: Sales Manager  
T: + 31 111 418 900  
F: + 31 111 416 154  
E: sales@nemag.com  
W: www.nemag.com  
NEMAG specializes in high performance four rope grabs for medium and large scale bulk handling, "lowest handling costs per tonne material transferred" are the key words in NEMAG's philosophy. Also: NEMAG Quick Release Links and Rope Pear Sockets for fast and safe connection of a grab to a crane.

**NERAK GmbH Fördertechnik**

Brigitta 5  
Hambühren  
D-29313  
Germany  
Contact: Mr Edgar Bleeker  
Job Title: Marketing  
T: + 49 50 84 944 0  
F: + 49 50 84 944 222  
E: bleeker@nerak.de  
W: www.nerak.com

Contact: Mr Alfred Schuh  
T: + 43 22 66 6030  
F: + 43 22 66 603202  
E: office@m-u-t.at  
W: www.m-u-t.at  
Plans, designs and manufactures complete bulk handling plants, including conveyor bridges, troughed chain conveyors and screw conveyors. Manufactures belt- and chain bucket elevators, belt conveyors, trough chain conveyors,

bin emptying equipment, rotary feeders, drag chain conveyors, coal feeders and wetslag extractors.

**National Bulk Equipment Inc**

12838 Stainless Drive  
Holland  
Michigan  
49424  
USA  
Contact: Mr Dave Denhof

Job Title: Marketing Manager  
T: + 1 616 399 2220  
F: + 1 616 399 7360  
E: sales@nbe-inc.com  
W: National Bulk Equipment Inc

**NAVCO (National Air Vibrator**

**Co)**  
PO Box 40563  
Houston  
TX

 **innovative**

always researching and innovating to optimise our current products and develop new ones



We produce a full range of four rope grabs for medium and large lifting capacities, an assortment of Quick Release Links and Rope Pear Sockets. Without exception, these are top-quality, excellent performing products for the lowest costs per ton of cargo handled.

**nemag**  handles your bulk

## Neuro Corporation

1201 W Hawthorne Lane  
West Chicago  
IL  
60185-1894  
USA

Contact: Mr Jack Fox  
Job Title: Sales  
T: + 1 630 231 9020  
F: + 1 630 231 6120  
E: [neuro@neuro.com](mailto:neuro@neuro.com)  
W: [www.neuro.com](http://www.neuro.com)

A full service supplier taking projects from the concept stage into design and engineering, manufacturing, on site erection, commissioning, after sales service and maintenance programmes. Mechanical systems with capacities in excess of 3,000 mtph and pneumatic systems with capacities of 1.000 mtph.

## Neuro Industrietechnik GmbH **NEUERO**

Neurostrasse 1  
Melle  
D-49324  
Germany

Contact: Eng Andreas Haeuser  
Job Title: Sales & ProjectManager  
T: + 49 5422 9503 26  
F: + 49 5422 9503 50  
E: [ha@neuro.de](mailto:ha@neuro.de)  
W: [www.neuro.com](http://www.neuro.com)

NEUERO designs and manufactures pneumatic and mechanical ship/barge unloaders and ship/barge loaders, mobile pneumatic conveyors. Capacity range of 30t/h to 2.000t/h. Products: mainly grain, meals, biomass, alumina pet coke, fly ash and others.

## Nilfisk-CFM SpA

Via Porrettana 1991  
Zocca  
Modena

41059  
Italy

Contact: Dr Leonardo Bianco  
Job Title: Marketing Manager  
T: + 39 059 973 00 31  
F: + 39 059 973 00 99  
E: [info@nilfisk-cfm.com](mailto:info@nilfisk-cfm.com)  
W: <http://www.cfm.it/>

Leader in the production of industrial vacuums, centralized vacuum systems, high power vacuums and pneumatic conveyors for powders and granules.

## NILOS GmbH & Co KG

Reisholzstrasse 15  
PO Box 970  
Hilden  
40709  
Germany

Contact: Mr Jens Hamacher  
Job Title: Export Manager  
T: + 49 2103 9510  
F: + 49 2103 951 209  
E: [jens.hamacher@nilos.de](mailto:jens.hamacher@nilos.de)  
W: [www.nilos.com](http://www.nilos.com)

## NKM Noell Special Cranes GmbH

Postbus 638  
Hoofddorp  
2130AP  
The Netherlands

Contact: Mr Enno Kramer  
Job Title: Director Product Unit  
Offshore Cranes  
T: + 31 20 655 0030  
F: + 31 20 655 0040  
E: [enno.kramer@nkmmoell.com](mailto:enno.kramer@nkmmoell.com)  
W: [www.nkmmoellspecialcranes.com](http://www.nkmmoellspecialcranes.com)



## NM Heilig BV



Newtonstraat 17  
Heerhugowaard  
1704 SB  
The Netherlands

Contact: Mr Peter Fontein  
T: + 31 72 571 6688  
F: + 31 72 571 6020  
E: [info@heilighbv.com](mailto:info@heilighbv.com)  
W: [www.heilighbv.com](http://www.heilighbv.com)  
For more than 30 years N.M. Heilig B.V. have specialised in designing, developing, producing and installing bulk-handling and recycling installations worldwide. Our key values are quality, durability and service.

## Noell Crane Systems (China) Ltd

China Merchants  
Zhangzhou Development Zone  
Fujian 363105  
China

Contact:  
T: + 86 596 6851 888  
F: + 86 596 6851 889  
W: [www.noellchina.com](http://www.noellchina.com)

## Nordströms Konstruktionsbyrå

Storgatan 58  
Umeå SE-903 30  
Sweden

Contact: Mr Peter Vedin  
Job Title: Marketing  
T: + 46 90 1136 4500  
F: + 46 90 1330 69  
E: [arletun@nordstroems.se](mailto:arletun@nordstroems.se)  
W: [www.nordstroems.se](http://www.nordstroems.se)  
Dry bulk vehicle loading spouts.

## Nordstrong Equipment Ltd

400 Ambassador Drive  
Mississauga  
Ontario  
L5T 2J3  
Canada

Contact: Mr Bill Van Duyn  
Job Title: Sales Manager  
T: + 1 289 562 6402  
F: + 1 289 562 6445

E: [wmvanduy@nordstrongequipment.com](mailto:wmvanduy@nordstrongequipment.com)  
W: [www.nordstrongequipment.com](http://www.nordstrongequipment.com)  
Designs and manufactures bulk material handling equipment and systems, including belt conveyors, screw conveyors, drag conveyors, bucket elevators and pipe conveyors.

- Bulk Handling
- Recycling installations
- Crushing/screening plant
- RDF preparation plant
- Transport systems
- Coal washing plants

*N.M. Heilig B.V. is the ideal partner to go through the process:  
"From concept to installation".*



**N.M. HEILIG B.V.**  
FROM CONCEPT TO INSTALLATION

NEWTONSTRAAT 17  
1704 SB HEERHUGOWAARD  
THE NETHERLANDS

T +31 (0) 72 571 66 88  
INFO@HEILIGBV.COM

**WWW.HEILIGBV.COM**



## MOBILE PORT EQUIPMENT - EXAMPLES OF USE

Unloading a ship or barge and loading trucks



Ship unloading direct to a truck



Using a mobile hopper



Using a pressure cyclone



Unloading Wagon and loading a ship



Transshipment from barge to ship

Flexible, reliable, multiple use

- can be moved quickly to new location
- fast delivery and installation

More information at [www.neuero.de/en/gsd](http://www.neuero.de/en/gsd)





# Orthos Projects Ltd.

## E&F Dockside Mobile Loaders

Following the acquisition of the intellectual property rights and engineering designs Orthos Projects are now offering the full range of aspirated and non-aspirated DML's pioneered by E&F Services

For the grab unloading of bulk dusty cargoes

Proven environmental emission levels

Ability to handle a variety of products

Self contained onboard power source

Proven manoeuvrability in restricted dock space

Various discharge options:

Clamshell discharge to lorries

Loading spout discharge to tanker

Discharge to dock conveying systems

Orthos Projects Ltd.

Fernie Road

Market Harborough

Leicestershire LE16 7PH

United Kingdom

Tel: +44(0)1858 462806

Fax: +44(0)1858 464403

[info@orthosprojects.com](mailto:info@orthosprojects.com)

[www.orthosprojects.com](http://www.orthosprojects.com)

[www.eandfservices.com](http://www.eandfservices.com)





**North American Crushing & Screening, LLC**

322 Lafayette Street  
New Orleans  
Louisiana LA 70130  
USA  
Contact: Mr Gilbert Wright  
T: + 1 504 866 0014  
F: + 1 504 866 0016  
E: gwright@nacslc.com  
W: www.nacslc.com  
Based in New Orleans, North American Crushing & Screening, LLC (NACS) conducts specialized services for various parties involved with the trading, transportation and handling of commodities. NACS provides portable processing alternatives for bulk cargo. NACS also recycles C&D materials (Asphalt & Concrete) for the construction industry.

**Northern Conveyors**

8 Einstein Drive  
Golden Grove SA 5125  
Australia  
Contact: Mr Colin Northey  
Job Title: Engineering Manager  
T: + 61 8 8289 1600  
F: + 61 8 8251 4944

E: enquiries@northernconveyors.com.au  
W: www.northernconveyors.com.au  
Northern Conveyors is a South Australian materials handling company, specialising in design, manufacture and distribution of conveyor products & equipment, including belt & roller conveyors, and all conveyor spares, including rollers, conveyor belts, drives and belt scrapers. Other conveyor services include conveyor design assistance, on-site trouble-shooting and custom conveyor manufacturing.

**O B Wiik**

Industriveien 13  
Skedsmokorset  
2020  
Norway  
Contact: Mr Ole Gregersen  
Job Title: Export Director  
T: + 47 64 83 55 00  
F: + 47 64 83 55 01  
E: ole.gregersen@obwiik.no  
W: www.obwiik.no  
O. B. Wiik is a supplier of relocatable warehouses. Durable PVC coated fabric covers on clear span steel or aluminium frames 9 – 40 meter.

WiikHalls are installed in more than 70 countries.

**Oceanport Shiploaders Ltd**

11 Cygnet Crescent  
Dalkeith 6009  
Australia  
Contact: Mr Stewart Graham  
Job Title: Managing Director  
T: + 61 8 9389 6490  
E: sg@grahamgroup.net.au

**Odt S.r.l.**

Via Principe Tommaso, 35  
Torino 10125  
Italy  
Contact: Ms Nadia Crivellari  
T: + 39 0522 683899  
F: + 39 011 658 936  
E: nadia@verdispa.com  
W: www.odtsrl.com

**OMIC Perth**

3/22 Rosco Turn  
Rockingham  
Western Australia 6168  
Australia  
Contact: Mr Takuyu Ajiro  
T: + 61 8 9592 2281  
E: uyukuta@hotmail.com

**Onestone Consulting Group GmbH**

Alte Trift 19  
Buxtehude  
D-216 14  
Germany  
Contact: Dr Ing. Joachim Harder  
Job Title: Management Consultant  
T: + 49 4161 5568 17  
F: + 49 4161 5568 27  
E: consult@onestone.de  
W: www.onestone.de  
Product, market and strategy consulting.

**Orthos Projects Ltd.**



Fernie Road  
Market Harborough  
Leicestershire  
LE16 7PH  
UK  
Contact: Mr Nick Hall  
Job Title: Director



T: + 44 1858 462806  
F: + 44 1858 464403  
E: nick.hall@orthosprojects.com  
W: www.eandfserives.com;  
www.orthosprojects.com  
Since 1977 Orthos Projects have designed, manufactured and installed bulk solids raw materials handling plant to the highest specification. Best qualified to serve the Port, Bulk Handling, Quarry, Foundry, Recycling and related industries. Special purpose machine design, conveyor systems to ISO 9001 (2008).







[www.orts-grabs.de](http://www.orts-grabs.de)

Orts GmbH Maschinenfabrik • Schwartauer Str. 99  
23611 Sereetz • Germany

Tel: +49 451 398 850 • Fax: +49 451 392 374  
Email: [sigvard.orts-jun@orts-gmbh.de](mailto:sigvard.orts-jun@orts-gmbh.de)



**ORTS** GmbH



## ORTS GmbH Maschinenfabrik



Schwartauer Strasse 99  
Sereetz  
D-23611  
Germany  
Contact: Herr Sigvard Orts  
T: + 49 451 398850  
F: + 49 451 392374  
E: sigvard.orts-jun@orts-gmbh.de  
W: www.orts-greifer.de

Mechanical single- rope, 2- rope and 4-rope grabs, electro- hydraulic grabs, radio controlled diesel- hydraulic grabs. Belonging crane equipment. All clamshell designs and sizes. TAILOR made! Constructed and manufactured in Germany. 40 years of experience.

### PAGE MACRAE ENGINEERING

61 Aerodrome Road  
Mount Maunganui  
Tauranga  
New Zealand  
Contact: Mr Bruce Ennis  
Job Title: Cargo Handling  
Equipment Manager  
T: + 64 7 575 5079 Ext 810  
F: + 64 7 574 4407  
E: brucee@page-macrae.co.nz  
W: www.page-macrae.co.nz  
Bulk cargo operators require

equipment, solutions and expertise to help reduce dust emissions at discharge, whilst maintaining maximum unloading productivity. Page Macrae provides that technology and expertise. 50 years of experience of designing and manufacturing cargo handling equipment make Page Macrae a leader - offering a combination of loading and unloading solutions that will protect the environment without compromising bulk discharge productivity.

### PAM Poul Andersen Maskinfabrik A/S

Vejlevangen 5  
Kerteminde  
DK - 5300

Denmark  
Contact: Mr Erik Andersen  
Job Title: Director  
T: + 45 65 32 12 41  
F: + 45 65 32 43 53  
E: pam@pam.dk  
W: www.pam.dk  
Produces 'PAM' suction/blowing mobile pneumatic units for loading and unloading of grain and other free-flowing granular materials. Produces diesel and electrically driven units with capacities of 20 to 150 tph.

### Parker Plant Ltd

Viaduct Works  
Canon Street  
Leicester  
Leicestershire  
LE4 6GH  
UK

Contact: Mr Richard Fothergill  
Job Title: Marketing Manager  
T: + 44 116 266 5999  
F: + 44 116 261 0812  
E: sales@parkerplant.com  
W: www.parkerplant.com

### Paul Hedfeld GmbH

Hundeicker Strasse 20  
Gevelsberg  
58285  
Germany  
Contact: Mr Burkhard Hedfeld  
T: + 49 2332 6371  
F: + 49 2332 61167  
E: hedfeld@hedfeld.com  
W: www.hedfeld.com  
Manufacturer of elevator buckets and screw flights.





## Technology to feed a growing world

Technology as an integration of manufacturing know-how with the expertise in evaluating the quality of the finished product. Technology as a result of the integration and

co-operation of a group of companies that are now fully integrated and synergistic, covering the entire supply chain from cereals delivery to the packed product on the shelf.

Technology allowing to set up in strict co-operation with our customers a manufacturing system tailored to their specific needs. Technology to feed a constantly evolving world.



## Pavan Group



Via Monte Grappa, 8  
Galliera Veneta (PD)  
35015  
Italy  
Contact: Ms Monica Giantin  
T: + 39 049 942 3111  
F: + 39 049 942 3303  
E: marketing02@pavan.com  
W: www.pavan.com

Specialized leaders with 60 years experience in the design and engineering of technologies for the food industry. They provide industrial solutions for flour milling and grain handling; grain handling, cereal milling plants, rice milling plants, animal feed milling plants, mechanical and pneumatic ship unloaders, ship loaders, grain handling and storage.

## PEBCO®

PO Box 7506  
225 North 4th Street (42001)  
Paducah  
KY  
42002-7506  
USA

Contact: Mr Mark Kettler  
Job Title: Director of Sales and Marketing  
T: + 1 270 442 1996 ext 202  
F: + 1 270 442 5214  
E: sales@pebco.com  
W: www.pebco.com

PEBCO® is acknowledged throughout the world in the field of moving, controlling and loading dry bulk materials. PEBCO®'s resources and responsibilities include customized gates, valves, mass flow feeders, dustless loading spouts, telescopic

chutes, and truck, ship and railcar loadouts. (Owner of North American Patent for Cleveland Cascade® Chute.)

## PEMA Verpackung

Carl Zeiss Strasse 10  
Syke  
28857  
Germany  
Contact: Mr Raake  
T: + 49 42 42 53 93 0  
F: + 49 42 425 02 09  
E: raake@pema-verpackung.de

## Peterson Agricare & Bulk Logistics BV

Boompjes 270  
Rotterdam  
3011 XZ  
The Netherlands  
Contact: Mr Arno Maehlimann  
T: + 31 10 282 3333  
F: + 31 10 282 3282  
E: info@peterson.nl  
W: www.peterson.nl  
Specialists in supply chain services for all kinds of bulk materials and offers: inspection, gauging barges, draft surveys, bunker surveys, on/off hire surveys, stockpile control, sampling, preparation, analyses, testing and verification, bias testing of mechanical samplers and management of JIT supplies

## Pfister Waagen Bilanciai GmbH

Linker Kreuthweg 9  
Affing-Mühlhausen  
D-86444  
Germany  
Contact: Ms Susanne Geller-Dürr  
Job Title: Marketing Manager  
T: + 49 82 07 9 58 99 28

F: + 49 82 07 9 58 99 29  
E: marketing@pfisterwaagen.de  
W: www.pfisterwaagen.de  
Suppliers of innovative, high quality, fully electronic weighing systems, incorporated in data networks, capturing and processing weighing data in cost-efficient control systems. Truck weighbridges, railway scales, platform scales, weighing indicators, weighing data software, load cells and load cell units, crane scales.

## PHB Weserhütte, S.A.

Parque Científico y Tecnológico de Gijón  
C/Luis Moya Blanco 82  
Gijón  
Asturias  
33203  
Spain  
Contact: Dr Jose Ramón Prado  
Job Title: Technical Commercial Director  
T: + 34 985 13 41 71  
F: + 34 985 13 42 22  
E: joseraimon.prado@pwh.es  
W: www.pwh.es  
Engineering Company an EPC Contractor with more than 60 years of experience in material handling installations. In the last 5 years has developed more than 50 projects around the World in countries such as México, USA, Spain, India, Morocco, Libya, Dominican Republic, Brasil, Turkey.

## Phelps Industries

PO Box 1093  
Little Rock  
Arkansas  
72203  
USA  
Contact: Mr John Phelps



Job Title: Sales  
T: + 1 501 375 1141  
F: + 1 501 375 6568  
E: jpsales@phelpsindustries.com

## Phenix Rousies Industries

Rue de Maubeuge  
59131  
France  
Contact: Mr Frederic Lepretre  
Job Title: Export Sales Manager  
T: + 33 03 27 69 42 42  
F: + 33 3 27 64 95 85  
E: lepretre.export@silos-phenix.com  
W: www.silos-phenix.com  
Produces dust controlling covers for belt conveyors and steel storage silos ranging from 25m3 to 9610m3. Each silo is fitted with an integrated gantry and an aeration system.

## PHOENIX Conveyor Belt Systems GmbH

Hannoversche Strasse 88  
Hamburg  
21079  
Germany  
Contact: Mr Bernd Kuesel  
T: + 49 40 7667 2205  
F: + 49 40 7667 2773  
E: info@phoenix-cbs.com  
W: www.phoenix-conveyor-belts.com

PHOENIX serves the worldwide bulk handling industry with textile and steel cord conveyor belts. Technological masterpieces in combination with 110 years of experience in conveyor belt production make PHOENIX conveyor belts the first choice for highest reliability and performance.

## PINTSCH BUBENZER GmbH



Friedrichshüttenstraße 1  
Kirchen-Wehbach  
RLP  
57548  
Germany  
Contact: Mr Arno Weil  
Job Title: Director of Sales  
T: + 49 27 41 9488480  
F: + 49 27 41 948844  
E: arno.weil@pintschbubenz.de  
W: www.pintschbubenz.de  
PINTSCH BUBENZER is focused on the design, production and service of high quality braking systems for both static and dynamic applications which involve the precise control of small to very large amounts of kinetic energy. The challenge is to control that energy in the most efficient, cost-effective way.

## Emergency stop?

Don't worry.







**Agridôme®**

# Concrete Bulk Storage

Grain - Fertilizer - Sugar - Alumina - Clinker - Fly Ash - Cement



**WATERPROOFED  
FROM THE BEGINNING**

**THERMALLY INSULATED**  
Best preservation of products  
No thermal shock to the structure  
No crack in the structure  
Consolidate the waterproofing

**QUICKLY ERECTED**

**COST EFFICIENT**  
Building  
Maintenance  
Operation

**VERSATILITY**

**PIRS SA**

ZI St. Hermentaire  
281, Avenue de l'Europe  
83300 Draguignan - France  
Phone: +33 4 98 10 67 67  
Fax: +33 4 98 10 67 68  
[www.domepirs.com](http://www.domepirs.com)  
[info@domepirs.com](mailto:info@domepirs.com)





**Pirs SA**



ZI St Hermentaire  
309, Avenue de l'Europe  
Draguignan  
Var  
83300  
France  
Contact: Mr Fikri El Mourabet  
Job Title: International Sales  
Manager  
T: + 33 4 98 10 6767  
F: + 33 4 98 10 6768  
E: info@domepirs.com  
W: www.domepirs.com  
Storage solutions for dry bulk  
commodities.

**PIV Drives GmbH - a Brevini  
Power Transmission Co.**



Justus-von-Liebig-Straße 3  
Bad Homburg  
D-61352  
Germany  
Contact: Mr Bernard Rensinghoff  
Job Title: Marketing Manager  
T: + 49 6172 102 648  
F: + 49 6172 102 380  
E: bernard.rensinghoff@brevini.com  
W: www.piv-drives.com or  
www.brevini.com  
PIV Drives, a company of Brevini

Power Transmission, has over 80 years experience in providing quality power transmission solutions for every industry sector. PIV Drives developed modular concepts for its comprehensive product range, providing the flexibility to deliver high-quality optimised solutions, both standard and bespoke, quickly and at competitive cost.

**Plantragg Developments**

4 Wold View  
Caistor  
Lincoln  
Lincolnshire  
LN7 6UU  
UK  
Contact: Mr Bob Harrison  
Job Title: Director  
T: + 44 1472 852 498 or + 44 7973

832 741  
F: + 44 1472 852 498  
E: ptag.dev@talktalk.net  
W: www.plantragg.co.uk  
Manufacturers and suppliers of patented 'Vibrong' vibratory equipment used to free 'hung' cargo from ships frames or ribs. The Company has been supplying this market for twenty years and has a number of satisfied 'repeat' clients who now have reduced their ship turnaround time.

**Plastruct Canada Inc.**

4305 Springcreek Road  
Vineland  
Ontario  
L0R 2C0  
Canada  
Contact: Mr Nick Koppelaar

Job Title: CEO  
T: + 1 905 563 4000  
F: + 1 905 563 0228  
E: nick@polyzone.com  
W: www.polyzone.com  
Designer, manufacturer and professional installer of lining systems for the toughest bulk material flow issues for hoppers, bins, conveying, classifiers chutes, fluidizing beds. Specialists in providing flow, abrasion, impact and corrosion solutions for bulk solids.



The PLM 40305 (40 ton on 30 meter) with PLM gantry based on its own pontoon. The pontoon can be moved to surrounding parts or can be used for "Mid-stream operations".



The bucket wheel unloader allows to unload an entire hopper to shore in only two hours (up to 3000 m<sup>3</sup>/hour). The ten-meter wide bucketwheel is moved fore-aft on a trolley over rails and then lowered a bit after each fore-aft pass. The bucketwheel discharges onto a hydraulically driven conveyor belt system, ending with a 46 meter long shore belt.

#### PLM products:

- Shipboard cranes
- Mobile cranes
- Harbor cranes
- Special equipment

#### Equipment applications:

- Dredging
- Transshipping
- Hoisting
- Pile-driving

#### Types:

- Diesel-hydraulic
- Electric-hydraulic
- Full electric

#### Capacities:

- Up to 8000 tm and 5000 ton/hour



## Designs and Constructions to all your demands

Visit our webpage and feel free to contact us >

[www.plmcranes.com](http://www.plmcranes.com)

[info@plmcranes.com](mailto:info@plmcranes.com)

+31 (0) 167 - 52 58 10



**PLM Cranes B.V.**



Sluisweg 21-25  
Heijningen  
4794 SW  
The Netherlands  
Contact: Mr Pieter Pulleman  
Job Title: Managing Director  
T: + 31 167 528510  
F: + 31 167 524444  
E: info@plmcranes.com  
W: www.plmcranes.com  
We build hydraulic and electric cranes from 50 to 2000 tm with a transhipment capacity up to approx. 2000 ton/hour. We are specialized in shipboard cranes, mobile cranes and harbour cranes for dredging, transhipping, hoisting and pile-driving.

**Polymer Industries - Ultrapolym Division**

2404 Center Street  
Tacoma  
WA  
98409-7638  
USA  
Contact: Mr Bryan Olin  
T: + 1 253 272 1217  
F: + 1 253 272 1457  
E: bryan.olin@polymerindustries.com  
W: www.polymerindustries.com  
Tough, self-lubricating Ultra Poly Ultra High Molecular Weight polyethylene provides durable protection for metal surfaces and eliminates noise associated with metal-on-metal contact. And its slick, nonstick properties assure unimpeded flow of materials, even under wet, sticky or freezing conditions.

**Portasilo Ltd**

New Lane  
Huntington  
York  
YO3 9PR  
UK  
Contact: Mr Paul Scott  
Job Title: Business Development Manager  
T: + 44 1904 624 872  
F: + 44 1904 611 760  
E: bulk@portasilo.co.uk  
W: www.portasilo.co.uk  
The Bulk Handling Division manufactures a range of silo discharge products, including 'Rotoflo', 'VibroFlo', 'Osciflo' and 'Augerflo' discharge valves as 'SiloFlo' aeration devices

**Port-Trade ApS**



Karelmagervej 9  
Fredericia  
DK 7000  
Denmark  
Contact: Mr Peter J Muller  
Job Title: Sales Manager  
T: + 45 7628 0102  
F: + 45 7628 0103  
E: peter.muller@port-trade.com  
W: www.port-trade.com  
Port-Trade is a Danish company with more than twenty years of experience with cargo handling systems, including mobile harbour cranes, container spreaders, bulk handling grabs, and loading equipment. Port-Trade provides analyses of customer requirements and proposes and delivers complete equipment solutions.

**Powerscreen International**

200 Coalisland Road  
Dungannon  
Co Tyrone  
BT71 4DR  
UK  
Contact: Mrs Michelle Killen  
Job Title: Marketing  
T: + 44 288 77 18500  
F: + 44 288 77 47231  
E: sales@powerscreen.com  
W: www.powerscreen.com

**Powertex Inc**

1 Lincoln Boulevard  
New York  
New York  
12979  
USA  
Contact: Mr George Bombardier  
Job Title: Vice President Sales and Marketing  
T: + 1 518 297 4000  
F: + 1 518 297 2634 / 2242  
E: georgebombardier@powertex.com  
W: www.powertex.com  
Manufacturer: Seabulk liners for 20' and 40' ocean containers, using woven, virgin grade PE film, and foil for moisture sensitive products, aeration and fluidizing liners for stubborn flowing products. Manufacturing facilities in U.S., China and India.

**Precia-Molen BV**

Frans Akker 1  
Breda  
4824 AL  
The Netherlands  
Contact: Mr Frédéric Felton  
Job Title: Export Manager  
T: + 31 76 524 2510  
F: + 31 76 522 8039  
E: frederic.felton@preciamolen.nl  
W: www.preciamolen.nl

Has provided weighing solutions to industry for more than 145 years. World wide reputation for quality and reliability. After-sales service and preventative maintenance programmes ensure customers have complete confidence in the accuracy and reliability of installations.

**Precia-Molen UK Ltd**

Walkers Road  
North Moons Moat  
Redditch  
Worcs  
B98 9HE  
UK  
Contact: Mr John Swinburne  
Job Title: Managing Director  
T: + 44 1527 590 300  
E: john.swinburne@preciamolen.co.uk

**Primasonics International Limited**

North Lakes Business Park  
Flusco  
Penrith  
Cumbria  
CA11 0JG  
UK  
Contact: Mr Donald Cameron  
Job Title: Managing Director  
T: + 44 17684 80372  
F: + 44 17684 80374  
E: sound@primasonics.com  
W: www.primasonics.com;  
www.quattrosonics.com  
Acoustic cleaners and silo cleaning systems.

**Procon Engineering Limited**

Vestry Estate  
Otford Road  
Sevenoaks  
Kent  
TN14 5EL

UK  
Contact: Mr Joe Naylor  
Job Title: Sales Manager - Beltweighers  
T: + 44 1732 781 300  
F: + 44 1732 781 311  
E: joe.naylor@proconeng.com  
W: www.proconeng.com

**PSTek LLC**

Thorwesten Vent GmbH  
2409 Traci Drive  
Pittsburgh  
PA  
15237  
USA  
Contact: Mr Scott Larkin  
T: + 1 412 366 6303  
F: + 1 412 366 6303  
E: Scot.Larkin@aol.com  
W: www.thorwesten.com  
PSTek is the exclusive US and Canadian sales representative and aftermarket service provider for Thorwesten Vent of Beckum, Germany.

**PT Bajra Mandalasakti**

Graha Mobisel, 2nd Floor  
Jl. Buncit Raya No. 139  
Jakarta  
Selatan  
12075  
Indonesia  
Contact:  
T: + 62 21 799 1323  
F: + 62 21 799 1308  
W: www.ptbms.net

**PT Bukaka Teknik Utama**

Jl. Raya Bekasi Narogong Km  
19,5 Cileungsi Bogor  
Jakarta  
16820  
Indonesia  
Contact: Mr Achmad Kalla

**Our Experience – Your Advantage**



Your Partner in Scandinavia



Also for used equipment

www.port-trade.com Tel.: +45 7628 0102

Construction - Earthmoving

Agriculture - Forestry

Mining - Quarrying - Cement

Material Handling - Utilities

Marine - Port Installations

Water - Chemical - Recycling

Energy - Petrochemical

Plastics - Rubber

Pulp - Paper - Print

Food - Beverage - Tobacco

Industrial Equipment



[www.brevini.com](http://www.brevini.com)

[www.piv-drives.com](http://www.piv-drives.com)

## Solutions for ship unloaders

For many years, PIV Drives and Brevini Riduttori have been industry leaders in power transmission solutions for all kinds of marine, port and material handling applications. PIV and Brevini, both part of Brevini Power Transmission, offer a wide range of products: from standard modular gear reducers to custom solutions for special applications. Our unparalleled quality and reliability are acknowledged worldwide. Through a global sales and service network, we are proud to provide prompt delivery and excellent service.

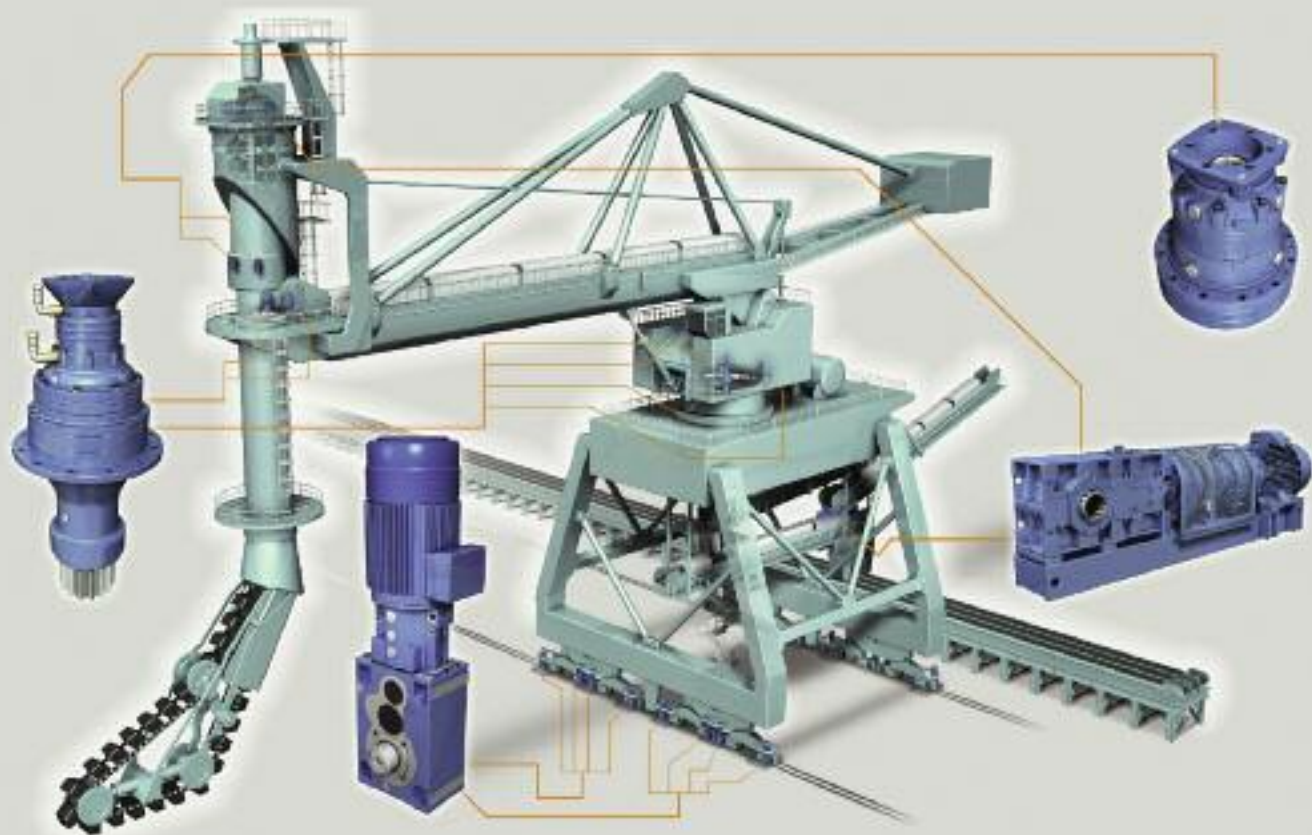

PIV Drives GmbH - Justus-von-Liebig-Straße 3 - 61352 Bad Homburg - Germany  
Tel. +49 (0)6172-102 0 - Fax +49 (0)6172-102 381 - [info@piv-drives.com](mailto:info@piv-drives.com)



Job Title: Director  
T: + 62 21 823 1146  
F: + 62 21 823 2323  
E: bdv@bukaka.com  
W: www.bukaka.com

## PT Jakarta Prima Cranes

Wisma JPC  
Jl. Mampang Prapatan Raya No. 20  
Jakarta  
12760  
Indonesia  
Contact:  
Job Title: Marketing Manager  
T: + 6221 799 2772  
F: + 6221 799 2442  
E: edy-siantur@jpc.co.id  
W: www.jpc.co.id

## PT Pamapersada Nusantara

Jln. Rawagelam I No. 9  
Kawasan Industri Pulogadung  
Jakarta  
13930  
Indonesia  
Contact: Mr. Sudiarso Prasetyo  
Job Title: President Director  
T: + 62 21 460 2015 Ext 211  
F: + 62 21 460 1916  
E: busdev@pamapersada.com  
W: www.pamapersada.com

## PT Thiess Contractors Indonesia

Ratu Prabu 2 Ratu Prabu 2  
Jl. TB. Simatupang Kav. 18  
Jakarta  
12560  
Indonesia  
Contact: Mr. Matahara  
Job Title: Business Development  
Manager  
T: + 62 21 2754 9999  
F: + 62 21 2754 9800  
E: thiess@thiess.co.id  
W: www.thiess.co.id

## PT United Tractors

Jalan Raya Bekasi KM 22  
Jakarta  
13910  
Indonesia  
Contact: Mr Christopher Reeves  
T: + 62 21 489 8014  
F: + 62 21 460 0544

## PT. Bando Indonesia

Wisma Hayam Wuruk, 6th floor,  
Suite 600  
Jln. Hayam Wuruk No. 8  
Jakarta  
10120  
Indonesia  
Contact: Mr Wahyono Wardiman  
Job Title: Conveyor Belt Division  
T: + 62 21 3517590  
F: + 62 21 3517591  
E: conveyor.div@bandoindonesia.com  
W: www.bandoindonesia.com  
PT. Bando, established in 1987, is  
one of the leading automotive and

industrial power transmission belt  
manufacturers in Indonesia. It has  
one main plant located in Tangerang  
and its marketing office located in  
Central Jakarta.

## Quadrant Engineering Plastics

**Products**  
2120 Fairmont Avenue  
Reading  
PA  
19612  
USA  
Contact: Mr Brad Siebt  
T: + 1 260 479 4283  
F: + 1 260 478 1074  
E: bradley.seibt@qplas.com  
W: www.systemtivar.com  
For more than 30 years Quadrant's  
SystemTIVAR Engineering Group has  
been providing flow, abrasion, impact  
and corrosion solutions in the field of  
bulk material handling using TIVAR 88  
to line a wide array of process  
equipment including ship holds, bins,  
bunkers, silos, chutes, railcars, off-  
road trucks, on-road trucks, etc.

## Quadrant PHS

Woodhouse Road  
Tadmorden  
Lancs  
OL14 5TP  
UK  
Contact: Mr Dave Livey  
Job Title: Logistics Department  
T: + 44 1706 811 000  
F: + 44 1706 817 571  
E: dave.livey@qplas.com  
W: www.polyhisolidur.com

## Quality Handling Systems Pty Ltd

6 Metters Place  
Wetherill Park  
Sydney  
NSW  
2164  
Australia  
Contact: Mr Peter Taylor  
Job Title: Project Manager  
T: + 61 2 9756 1921  
F: + 61 2 9756 4212  
E: ptaylor@qhs.com.au  
W: www.qhs.com.au  
Quality Handling Systems Pty Ltd  
(QHS) is an Australian company  
specialising in the design and  
manufacture of sampling systems for  
bulk materials. QHS have experience  
with sampling a wide range of  
materials using the various  
international standards.

## R & S S.r.l.

Via del Cmapo Sportuio 40  
Mezzana  
48123  
Italy  
Contact: Mr Silvio Banzi

Job Title: Head of Advertising  
T: + 39 0535618 205  
F: + 39 0544411 099  
E: s.banzi@wam.it  
W: www.ronuzzi.com  
A great piece of Italian history and  
tradition combined with the most  
accurate and innovative engineering  
in bulk handling and movementation.

## RAP Conveyors Ltd

Conveyor House  
Turner Crescent  
Loomer Road Industrial Estate  
Chesterton  
Newcastle  
Staffordshire  
ST7 7LU  
UK  
Contact: Mr David Southern  
Job Title: Managing Director  
T: + 44 1782 566440  
F: + 44 1782 566835  
E: info@rapconveyors.co.uk  
W: www.rapconveyors.co.uk  
Supplies a wide range of conveyor  
belting, including the complete range  
of 'Starflex', 'Betahete', 'Starhete',  
'Deltahete' and 'FRCDM' oil-resistant  
and chevron belting from Fenner  
Dunlop Belting.

## RBL-REI France

11 Boulevard Brune  
Paris  
Cedex 14  
75682  
France  
Contact: Mr Sébastien Bouhours  
T: + 33 2 41 21 19 40  
F: + 33 2 41 21 19 59  
E: s.bouhours@rbl-france.com  
W: www.rblrei-france.com  
A merger between two French  
companies specialised in bulk  
handling equipment. RBL - a leader  
in handling equipment. REI - known  
worldwide for its expertise in long-  
distance and curved conveyors. REI  
is also specialised in conveyors fitted  
with belt storage for tunnel  
excavation.

## RC Inspection B.V.

Gustoweg 66  
Rotterdam  
NL 3029  
The Netherlands  
Contact: Mr Kees  
Maarschalkerveerd  
T: + 31 10 4250240  
F: + 31 6 20741355  
E: kees.maarschalkerveerd@  
rc-inspection.com  
W: www.rc-inspection.com/  
An independent, privately owned  
inspection company operating in the  
field of dry bulk commodities, metals  
and marine survey related services.  
Main operational centers in  
Rotterdam, Johannesburg and Hong  
Kong, with office and field staff  
operating in more than 40 countries.  
We provide an independent, fast and  
reliable service with a direct people to  
people approach.

## RDS Technology Ltd

Cirencester Road  
Minchinhampton  
Stroud  
Gloucestershire  
GL6 9BH  
UK  
Contact: Mr Mark Evans  
Job Title: Business Development  
Manager  
T: + 44 1453 733300  
F: + 44 1453 733311  
E: info@rdstec.com  
W: www.rdstec.com  
RDS Technology was formed in 1969

and specialises in the design and  
manufacture of a wide range of on-  
board weighing systems to suit any  
application, from Wheeled Loader to  
Telehandler. Products include  
Loadmaster 8000iX with temperature  
and slope compensation as standard  
and the new WEIGHLOG a10.

## REMA TIP TOP GmbH

Business Unit Industrie  
Gruber St. 63  
Poing  
Bavaria  
D-85586  
Germany  
Contact: Mr Andreas Munder  
T: + 49 8121 707 245  
F: + 49 8121 707 222  
E: info@tiptop.de  
W: www.rema-tiptop.com  
REMA TIP TOP Industrie claims to be  
the world leader in high-quality  
conveyor maintenance, wear  
protection and corrosion protection.  
With a worldwide service network of  
more than 190 partners and 15  
subsidiaries very close relationships  
can be maintained with customers.

## Renby Ltd

Tarvin Mill  
Barrow Lane  
Tarvin  
Chester  
CH3 8JF  
UK  
Contact: Mr Robin Travis  
T: + 44 1829 741009  
F: + 44 1829 740 574  
E: sales@traffield.co.uk  
W: www.traffield.co.uk  
Specialist in dust contained and dust  
tight conveying in particular a range of  
conveyor for all types of belt  
conveyors. UK and Ireland agents for  
Schrage Rohrketten-system GmbH  
tube chain conveyors.

## Rexnord Industries Inc

4800 W. Mitchell St  
Milwaukee  
WI  
53214  
USA  
Contact: Mr Ken Piper  
T: + 1 414 643 2365  
F: + 1 414 643 3725  
E: ken.piper@rexnord.com  
W: www.rexnord.com

## Richmond Engineering Works

Pennsylvania Office  
1204 Parkway View Drive  
Pittsburgh  
Pennsylvania  
15205  
USA  
Contact: Mr Daren Fetcko  
Job Title: Sales Manager  
T: + 1 412 767 9640  
E: dfetcko@richmondengineering.com  
W: www.richmondengineering.com

## Risun Technologies

357 West 6160 South  
Murray  
Utah  
84107  
USA  
Contact: Mr Bill Whitney  
Job Title: Vice President, Business  
Development  
T: + 1 801 305 4241  
F: + 1 801 281 8787  
E: andyw@risuntech.com  
W: www.risuntech.com  
Risun Technologies is a multi-  
discipline engineering firm specializing  
in material handling, terminal design  
and broad scope projects requiring

innovative concepts to solve difficult  
problems. Specialty areas include silo  
design, monolithic dome storage with  
automated reclaim systems and  
control packages with system  
integration for projects using several  
different equipment vendors.

## River Consulting

445 Hutchinson Ave  
Suite 740  
Columbus  
OH  
43235  
USA  
Contact: Ms Carli Kessler  
Job Title: Marketing Assistant  
T: + 1 614 890 3456  
F: + 1 614 890 1883  
E: ksmith@riverconsulting.com  
W: www.riverconsulting.com  
River Consulting is a leading Mid-  
Major A/E to Global energy, food,  
process and industrial clients. We  
deliver multidiscipline engineering and  
project management solutions for  
challenges of every size, including  
major capital investments as well as  
facility and process expansions. We  
combine the capability of a full-service  
firm with the responsiveness and  
flexibility of a specialty engineering  
practice.

## RJS Siloclean International Ltd

Crowcroft Road Industrial Estate  
Nedging with Naughton  
Ipswich  
Suffolk  
IP7 7HR  
UK  
Contact: Mr Jason Johnson  
Job Title: Marketing  
T: + 44 1449 740 051  
F: + 44 5600 767 753  
E: info@rjssiloclean.co.uk  
W: www.rjssiloclean.co.uk

## RKR Verdichtertechnik GmbH

Braasstr. 16  
Rinteln  
31737  
Germany  
Contact: Mr Ziegemeier  
T: + 49 57 51 40 04 0  
F: + 49 57 51 40 04 30  
E: info@rkr.de  
W: www.rkr.de

## Roberts & Schaefer Company

222 South Riverside Plaza  
Chicago  
Illinois  
60606-3986  
USA  
Contact: Mr Ike Miller  
Job Title: Business Development  
Mgr  
T: + 1 312 236 7292  
F: + 1 312 726 2872  
E: rs@elginindustries.com  
W: www.r-s.com  
We are a full service engineering &  
construction company specializing in  
designing & erecting bulk material  
handling systems.

## Robson Handling Technology

Geo. Robson & Co. (conveyors)  
Ltd.  
Coleford Road  
Sheffield  
S9 5PA  
UK  
Contact: Mr Ian Atkinson  
Job Title: Sales Director  
T: + 44 114 244 4221  
F: + 44 114 243 3066  
E: atkinson@robson.co.uk  
W: www.robson.co.uk





## RockTree Logistics Pte. Ltd.



3 Church Street  
#24-01/02  
Samsung Hub  
Singapore  
049483  
Singapore

Contact: Mr Daniele Pratalongo  
T: + 65 6622 65 10  
F: + 65 6622 65 11  
E: info@rocktree.sg  
W: www.rocktree.sg  
RockTree Logistics Pte. Ltd. Designs customised logistics that manage the complete transshipment aspect of your supply chain for all dry bulk commodities. Our goal is to get your dry bulk moving on schedule, saving you time and money in the process.

## Ronin GMS

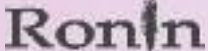

25 High Street  
Modderfontein  
Johannesburg  
1645  
South Africa

Contact: Mr Ferdinand Meyer  
Job Title: Sales and Marketing Manager  
T: + 27 11 608 3666  
F: + 27 11 608 4679  
E: ferdi@roningms.com  
W: www.roningms.com  
Ronin GMS supplies grain management system solutions, analytical grading equipment and grain handling services to the Southern African Grain Handling and



## Inventory at your Fingertips



BINS



BUNKERS



STOCKPILES



### DRY BULK Inventory Management Solutions

*Mitigating your risk and balancing your dry bulk stock to book value has never been this easy!*

# Ronin

Contact RoninGMS for a consultation today.

Office: +27 (0) 11 608 3666

e-Mail: office@roningms.com

www.roningms.com

Storage Industry. This includes: - real time, independent inventory measurement and management systems - transactional software packages - identity tracking solutions - in bin temperature control, management and aeration - Near Infra Red Transmittance devices for measuring protein - Image Analysers for measuring specks and ash content - service & support for analytical instrumentation - Silo Auditing service.

### Royal Haskoning

ROYAL HASKONING  
Enhancing Society

George Hintzenweg 85  
Rotterdam  
3068 AX  
The Netherlands  
Contact: Ms Berte Simons  
Job Title: Director Advisory Group  
T: + 31 10 2865 398  
F: + 31 10 443 3688  
E: info@rotterdam.royalhaskoning.com  
W: www.royalhaskoning.com  
Royal Haskoning harbours the knowledge and practical experience that is indispensable in the development of modern ports and (un)loading, transport and storage systems. Our services cover all stages of project development and we are dedicated to finding solutions aimed at improving and optimising our clients' business activities in the field of dry bulk handling, processing and storage.

### RTA Alesa Ltd. RTA Alesa

Max Hogger-Strasse 6  
Zurich  
CH - 8048  
Switzerland  
Contact: Mr Hanspeter Stahl  
T: + 41 44 435 33 33  
F: + 41 44 435 33 66  
E: hanspeter.stahl@riotinto.com  
W: www.rta-alesa.com  
Specialized in supplying pneumatic unloaders and dense phase conveyors for alumina, cement, chemicals, powders, grain, petroleum coke, rock phosphate and granular materials.

### Rubb Buildings Ltd

Dukesway  
Team Valley Trading Estate  
Gateshead  
Tyne & Wear  
NE11 0QE  
UK  
Contact: Mr Ian Hindmoor  
Job Title: Sales Manager  
T: + 44 191 482 2211  
F: + 44 191 482 2516  
E: info@rubb.co.uk  
W: www.rubb.co.uk  
Builds warehouses, stores and workshops for the storage and handling of bulk cargo.





## Built to deliver more Global Logistic Solutions

Rocktree is a young and dynamic logistics and shipping company offering its clients logistics solutions to enhance their operations worldwide. Rocktree specializes in providing services to companies in the natural and mineral resources sectors, specifically dry bulk commodity producers, end users and international trading companies in emerging markets. Rocktree's fleet of highly specialised offshore floating terminals (OFTs) provides its clients with unique, customized logistics solutions for their operational needs, including transshipment, storage, cargo blending and ship management.



# Built to deliver more

## Global Logistic Solutions

Rocktree is a young and dynamic logistics and shipping company offering its clients logistics solutions to enhance their operations worldwide. Rocktree specializes in providing services to companies in the natural and mineral resources sectors, specifically dry bulk commodity producers, end users and international trading companies in emerging markets. Rocktree's fleet of highly specialised offshore floating terminals (OFTs) provides its clients with unique, customized logistics solutions for their operational needs, including transshipment, storage, cargo blending and ship management.

[www.rocktree.sg](http://www.rocktree.sg)

**Rocktree Logistics Pte. Ltd.**  
3 Church Street #24-01/02 Samsung Hub Singapore 049483

Tel: +65 6622 6500 | Fax: +65 6622 6511  
[info@rocktree.sg](mailto:info@rocktree.sg)





**Rud Kettenfabrik**

Aalen Underkochen  
D-73428 Germany  
Contact: Ms Marina Grupp  
Job Title: Marketing & PR  
T: + 49 7361 504 1463  
F: + 49 7361 504 1288  
E: marina.grupp@rud.com  
W: www.RUD.de

**RULMECA HOLDING S.P.A.**



Via A Toscanini 1  
Almé  
Bergamo 24011

**Italy**

Contact: Mr Carsten Spanggaard  
Job Title: Group Sales Director  
T: + 39 035 430 0111  
F: + 39 035 545 700  
E: rulmeca@rulmeca.it  
W: www.rulmeca.com

Steel rollers, heavy-duty rollers, medium- and light-duty rollers, anticorrosion rollers for salty and chemically aggressive environments; troughing and self-aligning sets manufactured according to all major international standards; garland systems with 2, 3, 4, 5 rollers employed in conveyors loading areas; idler pulleys and drums, with or without bearings for all belt widths.

**SABS - Mining & Minerals**

PO Box 413  
Richards Bay  
KwaZulu Natal  
3900  
South Africa  
Contact: Ms Audrey Ndlovu  
Job Title: Operations Manager  
T: + 27 35 797 7209  
F: + 27 35 797 7212  
E: ndlovua@sabs.co.za

Provides a holistic range of sampling, analytical and product certification services to the solid-fuel and mineral industries. In addition to its core values of Accredited Quality (ISO 17025), integrity, accuracy and speed, also offered is a very competitive pricing structure resulting in product samples for analysis being received from around the world.

**Saiag Industria SpA**

Strade Brandizzo 130  
Volpiano  
I-10088  
Italy  
Contact: Mr Moro Marco  
Job Title: Sales Manager  
T: + 39 0 11 9822111  
F: + 39 0 11 9822301  
E: mmoro@comital.com  
W: www.saiag.it

**Salzgitter Maschinenbau  
AG/PEINER Grabs**



Windmühlenbergstrasse 20-22  
Salzgitter  
D-38259  
Germany

Contact: Mr Amulf Köhnemann  
T: + 49 5341 302 613  
F: + 49 5341 302 424 or 606  
E: amulf.koehnemann@smag.de  
W: www.smag.de

Manufacturer and supplier of a complete range of grabs, i.e., (electro-hydraulic) motor grabs, single-rope grabs, two- and four-rope grabs, hydraulic grabs as well as rotators (slewing units) and special grabs for all kinds of bulk materials for various applications and purposes.

**Sammi**

Via Tuderte, 388  
Narni Scalo  
Terni  
05036  
Italy  
Contact: Mr Daniele Bellezza  
Job Title: Engineer

T: + 39 0744 733832  
F: + 39 335 5313331  
E: daniele.bellezza@sammi.it  
W: www.sammi.it

Making plant and machinery for the bulk handling industry for over 35 years, from designing to material selection, from assembly and implementation to maintenance and after-sales technical assistance. Sammi directly controls the entire business cycle and is strongly oriented towards product development and design. Our team of designers ensures continual technical innovation - a distinguishing feature of the Company.

**Sampling Associates**

**International**

PO Box 338  
Newport News  
Virginia  
23607-0338  
USA

Contact: Mr Paul Reagan  
Job Title: President  
T: + 1 757 928 0484 ext 100  
F: + 1 757 928 0482  
E: preagan@samplingassociates.com  
W: www.samplingassociates.com

**Sandvik Mining**

Sandviken  
SE-81181  
Sweden

Contact: Mr Göran Carlbaum  
Job Title: Sales Support Manager  
T: + 46 26 262000  
F: + 46 26 260230  
E: info.smc@sandvik.com  
W: mining.sandvik.com

Sandvik Mining and Construction is one of the leading suppliers of drilling, crushing and turn-key bulk material handling equipment using continuous material handling technologies (bucket wheel, scraper, conveyor,...)



# Talk to the Royal HaskoningDHV Dry Bulk Port & Terminal Professionals

**STUDIES**

- Master planning
- Feasibility
- Infrastructure
- Logistics
- Environmental Impact
- Due Diligence

**PROJECT SERVICES**

- Study, Design and Engineering
- Supplier and Equipment selection
- Tendering and Contracting
- Project and Contract Management
- Construction Management
- Commissioning

**OUR PROFESSIONALS**

- Dry Bulk Handling Experts
- Port Planners
- Environmental Experts
- Marine Experts
- Civil, Mechanical and Electrical Engineers

Johan Pruisken – Director Advisory Group  
johan.pruisken@rhdhv.com  
+31 62906586 / +31 102865445



### MAIN FEATURES

- Rugged construction for heavy duty
- Hermetically sealed against water and dirt
- Manufactured according to DIN, AFNOR, JIS, CEMA, FEM, BS

### BENEFITS

- Totally safe and controlled roller
- Longer bearing and roller life
- Ability to supply rollers to every market worldwide

# Your rollers for belt conveyors

### Steel rollers - PSV series:

- perfect for mines, quarries, cement works, coal-fired electric utilities, dock installations and all bulk handling conveyors
- shaft ranging from 20 to 40 mm diameter
- tube ranging from 63 to 194 mm diameter
- minimum 30.000 theoretical bearing life
- no need for early replacements
- successful for more than 45 years

Contact your local RULMECA Company to discuss about this or other requirements for Idlers and Motorized Pulleys.



### COMPANIES AROUND THE WORLD

#### Headquarters

RULMECA HOLDING S.P.A.  
Via A. Toscanini, 1  
I-24011 Almè (Bergamo)  
Phone: +39 035 4300 111  
Fax: +39 035 545700  
e-mail: rulmecca@rulmecca.it

#### RULMECA - EUROPE

**Denmark**  
RULMECA A/S  
e-mail: dk@rulmecca.com

**Finland**  
RULMECA OY  
e-mail: kpuhakka@rulmecca.com

**France**  
PRÉCISMÉCA  
Equipements de Manutention  
e-mail: info.france@rulmecca.com

**Germany**  
RULMECA GERMANY GMBH  
Aschersleben  
e-mail: faa@rulmecca.com

**Leipzig**  
e-mail: vertrieb.le@rulmecca.com

**Great Britain**  
RULMECA UK Ltd  
e-mail: uk@rulmecca.com

**Italy**  
RULLI RULMECA S.P.A.  
e-mail: export@rulmecca.it

**Kazakhstan**  
RULMECA GERMANY GMBH  
Representative office  
e-mail: baubakirova@mail.ru

**Portugal**  
RULMECA DE PORTUGAL, LDA  
e-mail: rulmecca@rulmecca-interroll.pt

**Russia**  
RULMECA GERMANY GmbH  
Büro Moskau  
e-mail: faamsk@com2com.ru

**Spain**  
RULMECA ESPAÑA, S.L.U.  
e-mail: espana@rulmecca.com

**Sweden**  
RULMECA A/S  
e-mail: se@rulmecca.com

**Turkey**  
RULMECA Taşıma Aksamları Tic.  
Ltd. Şti.  
e-mail: turkey@rulmecca.com

**RULMECA  
NORTH & SOUTH AMERICA**  
**Canada**  
PRECISMÉCA LIMITED  
e-mail: sales@precismeca.ab.ca

**USA**  
RULMECA CORPORATION  
e-mail: mgawinski@rulmecacorp.com

**MELCO LLC**  
e-mail: stevenb@melco-usa.com

**VENEZUELA**  
INDUSTRIAS RULMECA S.A.  
e-mail: rulmecca@rulmecca.com.ve

[www.rulmecca.com](http://www.rulmecca.com)

#### RULMECA - ASIA

**China**  
RULMECA (TIANJIN) CO. LTD  
e-mail: sales@rulmecca.com.cn

**Indonesia**  
PT. RULMECA INDONESIA  
suwarno.kie@rulmeccaindonesia.com

**Thailand**  
RULMECA (THAILAND) CO., LTD.  
e-mail: th-sales@rulmecca.co.th

**RULMECA - AFRICA**  
MELCO Conveyor Equipment  
conveyors@melco.co.za

**RULMECA - AUSTRALIA**  
RULMECA MELCO AUSTRALIA (PTY) LTD  
e-mail: markr@melco.co.za



to stack, load/reclaim and haul bulk material. Integrated solutions and products are designed to specific customer requirements and engineering, project management and operation services are offered worldwide.

## Sandvik Mining and Construction



Materials Handling GmbH & Co KG  
Vordemberger Strasse 12

Leoben  
A-8700

Austria

Contact: Mr Stefan Dötsch

Job Title: Marketing

Communications Manager - Mining

Systems

T: + 43 3842 2077 230

F: + 43 3842 2077 201

E: stefan.doetsch@sandvik.com

W: www.sandvik.mining.com

A company within the business area Sandvik Mining of the Sandvik Group and a leading global supplier in continuous mining and bulk materials handling in stockyards and ports, offering a wide range of equipment for mechanical excavation, crushing and conveying. Other equipment includes: Bucket wheel excavators, Beltwagons, Spreaders, Fully- and semi-mobile crushing plants, Stationary crushing plants, Transport crawlers.

## Sandvik Mining and Construction (China) Co., Ltd.

No.986, Baota Rd

Jiading District

Shanghai

201821

China

Contact: Mr Zhang Jianyuan

Job Title: Vice President, Surface

Mining

T: + 86 21 6916 6050

F: + 86 21 6916 6025

E: jianyuan.zhang@sandvik.com

W: www.sandvik.com

## Sanwa Commercial Co., Ltd.

13-20 Irieoka - cho, Shimizu - ku,

Shizuoka -city

Shizuoka

424-0839

Japan

Contact: Mr Masao Butsui

Job Title: President

T: + 81 543536 121

F: + 81 54352 6390

E: sccsanwa@blue.ocn.ne.jp

W: http://www.scc-sanwa.jp

## Sartorius Mechatronics T&H

GmbH

Meiendorfer Strasse 205

Hamburg

D-22145

Germany

Contact: Mr Johannes Kratz

Job Title: Marketing Manager

T: + 49 40 67960303

F: + 49 40 67960383

E: info.mechatronics@sartorius.com

W: www.sartorius.com

Designs weighing and batching

equipment for grain handling.

## SCAFCO Corporation

PO Box 11215

6200 East Main

Spokane

Washington

99211-1215

USA

Contact: Mr Bruce Katahira

T: + 1 509 3439000

F: + 1 509 535 9130

E: mail@scafc.com

W: www.scafc.com

## Scantech International

PO Box 1485

Springwood

Queensland

4127

Australia

Contact: Mr Henry Kurth

T: + 61 7 3710 8406

F: + 61 7 3710 8499

E: sales@scantech.com.au

W: www.scantech.com.au

World leader in process control

solutions for conveyed bulk materials.

On-belt analysers with proven

technologies. Reliable, accurate and

dependable ash, moisture and

elemental measurement minute by

minute. Control quality through

blending or monitor specification

compliance. Over 1,000 installations.

## Schade Lagertechnik GmbH

Dorstener Strasse 360

Herne

D-44653

Germany

Contact: Mr Jörg Hoffmann

Job Title: Managing Director

T: + 49 2325 58740

F: + 49 2325 587474

E: info@schade-lagertechnik.de

W: www.schade-lagertechnik.de

Incorporated in 1879, member of the

AUMUND Group since 2001, supplier

of bulk material stockyards and

blending bed technology for all major

industries. Portal and semiportal

reclaimers, bridge-type reclaimers,

cantilever reclaimers, combined

stacker/reclaimers, stackers, tripper

cars, circular stockyards with

cantilever or bridge-type reclaimers,

integrated systems.

## Schenck Process Africa (Pty)

Limited

1 Crusher Road

Crown Ext. 3

Johannesburg

Gauteng

2092

South Africa

Contact: Mr Thabo Khumalo

T: + 27 11 837 9656

F: + 27 11 837 7458

E: tkhumalo@schcnkprocess.co.za

W: www.schcnkprocess.co.za

Supplies a wide variety of bulk

materials weighing equipment,

including static controllers and

loadcells as well as belt weighers and

flow meters.



# PEINER Grabs

by

# SMAG

Salzgitter Maschinenbau

## Access to success! Let's grab it!

Motor Grabs

Rope Grabs

Hydraulic Grabs

Rotators

Specials



Salzgitter Maschinenbau AG

Windmühlenbergstraße 20-22

D-38259 Salzgitter

Tel.: +49 (0) 53 41 / 3 02 - 6 47

Fax: +49 (0) 53 41 / 3 02 - 4 24

E-Mail: peiner@smag.de

Internet: www.peiner.de





# HOW WE OPTIMIZE YOUR MATERIALS HANDLING PROCESS? **THIS WAY!**

Operations everywhere rely on bulk materials handling systems for continuous performance. Sandvik has steadily developed into a technological frontrunner and leading global supplier of some of the world's most impressive machines for stockyards and other operations.

Rely on Sandvik to make your mining business more efficient and more competitive.

**Join the movement towards The Future of Mining.**  
It's This Way: [mining.sandvik.com](http://mining.sandvik.com)





## Schenck Process GmbH



Pallaswiesenstr 100  
Darmstadt  
Hessen  
D-64293  
Germany

Contact: Ms Heike Trautmann  
Job Title: Marketing Communication  
Manager

T: + 49 61 51 1531 0

F: + 49 61 51 1531 66

E: info@schenckprocess.com

W: www.schenckprocess.com

Whether you are planning processing plants, feeding bulk solids, controlling material flow, recording commodity flow, weighing goods or automating manufacturing and transportation operations - Schenck Process is your reliable partner.

## Schenck Process UK Limited

Carolina Court  
Lakeside  
Doncaster  
South Yorkshire  
DN4 5RA  
UK

Contact: Mr Paul Markwell  
Job Title: Marketing Manager  
T: + 44 1302 321 313

F: + 44 1302 554 300  
E: enquiries@schenckprocess.co.uk  
W: www.schenckprocess.co.uk  
Designers, manufacturers and suppliers of materials handling solutions including all forms of pneumatic and mechanical conveying systems and pneumatic process injection systems for fuels or additives.

## Schenck Process UK Ltd T/A Redler

Redler House  
Dudbridge  
Stroud  
Gloucestershire GL5 3EY  
UK

Contact: Mr Andrew Workman  
Job Title: Director - Bulk Materials  
Handling

T: + 44 1453 761 784

F: + 44 1453 763 582

E: sales@redler.com

W: www.redler.com

Leading supplier of plant for handling dry bulk materials. Extensive knowledge of many technologies involved in different materials handling installations enables the offering of complete system solutions. The resources are in place from a single machine through to the supply of a major port and terminal project.

## Schouten Commodities BV

Burgstraat 12 4283 GG Giessen  
4284 GG

The Netherlands  
Contact: Mr Marius van Doorn  
Job Title: Commercial Manager  
T: +31 183-446451  
E: info@schoutenproducts.com  
W: www.schoutenproducts.com

## Scorpio Engineering Pvt. Ltd

Scorpio House  
132 Wheeler Road  
Cox Town  
Bangalore  
560 005  
India

Contact: Mr Jacob P.  
Job Title: VP - Marketing &  
Application

T: + 91 99801 625 39

F: + 91 80 2548119

E: jacob@scorpioengg.com

W: www.scorpioengg.com

Scorpio is a turnkey engineering and manufacturing company in bulk materials handling concentration on ports and port handling systems for dry bulk cargo. A 50000 sqft manufacturing facility on a 5 acre plot augments our core engineering and design capabilities. Experienced service and start up engineers can get projects running in quick time. A

strong design team underscores our technology orientation. At Scorpio, we sell technology.

## Sea Spec International

5 Manor Green  
Nth Frodingham  
Driffield  
East Yorkshire  
YO25 8JH  
UK

Contact: Mr Mike L Coles  
Job Title: Company Proprietor

T: + 44 1262 488 500

F: + 44 1262 481200

E: mikecoles@seaspec.eclipse.co.uk

## Sea Transport Corporation

PO Box 1043  
Southport  
QLD  
4215

Australia

Contact: Mr Ross Ballantyne

Job Title: Chief Executive Officer

T: + 61 7 5529 5777

F: + 61 7 5529 5177

E: ross@seatransport.com

W: www.seatransport.com

## Seabulk Systems Inc



Suite 150  
10271 Shellbridge Way  
Richmond  
British Columbia  
V6X 2W8  
Canada

Contact: Mr Sidney Sridhar  
Job Title: President  
T: + 1 604 273 1378

F: + 1 604 273 1358

E: sbs@seabulk.com

W: www.seabulk.com

Design and build contractors for bulk materials handling ports involving shiploading/unloading and storage systems. Seabulk provides integrated shipping solutions from 'mine to mill' for dry bulk and liquid bulk cargo. Developed World's largest gravity reclaim ore transshipper. Also involved in design/construction of civil and marine structures.





## Increased Safety and Reduced Wear.

The MULTIRAIL® BogieLoad Measurement Device.



Increased safety and reduced wear for metro, tramways, regional and high-speed trains. Only perfectly tuned and serviced bogies can meet these requirements. Therefore, Schenck Process offers state-of-the-art measurement solutions which satisfy all requirements up to DIN 25043-7 including spindle load application, automatic bogie centring and geometric surveying.

**MULTIRAIL® Technology** is the complete solution for measuring, monitoring and checking in the workshop and on the track.

Schenck Process GmbH  
Pallaswiesenstr. 100  
64293 Darmstadt, Germany  
T +49 61 51-15 31 34 31  
transcom@schenckprocess.com  
www.schenckprocess.com

we make processes work







**S-E-G Instrument AB**

Box 111 43  
 Bromma  
 S-161 11  
 Sweden  
 Contact: Ms Eva Söderholm  
 Job Title: Assistant  
 T: + 46 8 764 74 00  
 F: + 46 8 764 75 00  
 E: [inform@s-e-g.com](mailto:inform@s-e-g.com)  
 W: [www.s-e-g.com](http://www.s-e-g.com)  
 Producer of belt scales, massflow meters and other industrial weighing equipment.

**Selpeco Resources Inc.**

14150 NE 20th Street  
 F1, PMB342  
 Bellevue  
 WA

98007

USA  
 Contact: Mr S E (Steve) Laccinole  
 Job Title: President  
 T: + 1 425 952 4463  
 F: + 1 425 822 1235  
 E: [selpeco@selpeco.com](mailto:selpeco@selpeco.com)  
 W: [www.selpeco.com](http://www.selpeco.com)  
 A bulk solids handling engineering and program management consultant serving the cement, pulp and paper, energy, mining and port industries. Selpeco has a partner company, Braco Consultants, in Brazil and a strategic alliance with FLSmidth/Koch/MVT in the U.S. and western hemisphere. Primary service is program management of complex material handling projects, from planning through commissioning.

**Sempertrans France Belting Technology SAS**

Sempertrans Marketing  
 10 rue des charretiers  
 Argenteuil Cedex  
 95104  
 France  
 Contact: Ms. Catherine Flichy  
 T: + 33 1 30 25 72 00  
 F: + 33 2 39 80 46 16  
 E: [contact@sempertrans-france.com](mailto:contact@sempertrans-france.com)  
 W: [www.sempertrans.com](http://www.sempertrans.com)  
 SEMPÉRTRANS has been developing, manufacturing and installing conveyor belts for more than 50 years. Its knowhow, its experience and the quality of its products make SEMPÉRTRANS one of the world's leading companies in its field.

**SENNEBOGEN Maschinenfabrik GmbH**



Hebbelstrasse 30  
 Straubing  
 D-94315  
 Germany  
 Contact: Mr Bernhard Kraus  
 T: + 49 9421 540143  
 F: + 49 9421 43882  
 E: [marketing@sennebogen.de](mailto:marketing@sennebogen.de)  
 W: [www.sennebogen.com](http://www.sennebogen.com)  
 Sennebogen offers a wide range of all kinds of materials handling machines, HD rope excavators/cranes, crawler cranes, telescopic cranes and base carriers.

**Sensor Technology Ltd**

Apollo Park  
 Ironstone Lane  
 Wroxton  
 Banbury  
 Oxon  
 OX15 6AY  
 UK  
 Contact: Mr Mark Ingham  
 Job Title: Sales Manager  
 T: + 44 1869 238400  
 F: + 44 1869 238401  
 E: [info@sensors.co.uk](mailto:info@sensors.co.uk)  
 W: [www.sensors.co.uk](http://www.sensors.co.uk)  
 Suppliers of TORQSENSE & LOADSENSE sensors and transducers, TorqSense, the world's first low cost non-contact rotary torque transducers and LoadSense wireless load transducers.



Cape Size Transshipper, Goa, India



Turnkey Contract at the Port of Quebec



**SEABULK SYSTEMS INC.**

**Integrated Shipping Solutions**

Tel: (604) 273-1378  
Fax: (604) 273-1358

Suite 150 - 10271 Shellbridge Way  
Richmond, B.C. V6X 2W8 Canada

[www.seabulk.com](http://www.seabulk.com)  
[sbs@seabulk.com](mailto:sbs@seabulk.com)



**Sentry Equipment Corporation**

966 Blue Ribbon Circle North  
Oconomowoc  
Wisconsin  
53066  
USA  
Contact: Ms Doris Hoeft  
Job Title: Marketing Director  
T: + 1 262 567 7256 x 157  
F: + 1 262 567 4523  
E: dorish@sentry-equip.com  
W: www.sentry-equip.com  
Supplier of manual and automatic samplers for bulk solids, powders, slurries, liquids and gases.

**Servo Berkel Prior**

Jan Evertsenlaan 4  
Katwijk  
2224 SV  
The Netherlands  
Contact: Mr Erwin van Diest  
Job Title: Managing Director  
T: + 31 71 4030101  
F: + 31 71 4032317  
E: info@servoberkelprior.eu  
W: www.servoberkelprio.eu  
Offers bunker weighers and duplex weighers for in/outtake and bulkloading; automatic net weighers; special weighing equipment; conveyor sets for all conventional weighers.

**SEW-EURODRIVE GmbH & Co KG**

P O Box 3023  
Bruchsal  
D-76652  
Germany  
Contact: Mr Manfred Müller  
T: + 49 7251 75 0  
F: + 49 7251 75 1970  
E: sew@sew-eurodrive.de  
W: www.sew-eurodrive.com

**SGH Equipment Limited**

Estates House  
Alvaston Business Park  
Middlewich Road  
Nantwich  
Cheshire  
CW5 6PF  
UK  
Contact: Mr Stuart Henderson  
Job Title: Director  
T: + 44 1270 619 721  
F: + 44 1270 619 742  
E: sales@sghequipment.co.uk  
W: www.sghequipment.co.uk  
Equipment for conveying and handling Powders and Granular materials.  
EQUIPMENT: Storage Silos & Vessels, Silo Safety Systems, Discharge & Flow Aids, Valves & Actuators, Conveyors & Feeders, Dust Filters & Collectors, Mixers &

Blenders, FIBC / Big Bag - PORTABULK® Representatives – UK  
SERVICES: Fabrication, Mechanical, Electrical \*Design, Manufacture, Installation & Commissioning \*Control & Instrumentation \*Dust & Odour Suppression

**SGS**

Suite 210B  
1919 S. Highland Ave  
Lombard  
Illinois  
60148  
USA  
Contact: Ms MaryLynn Dobush  
T: + 1 630 953 9300  
F: + 1 630 953 9306  
E: info@sgs.com  
W: www.sgs.com

**SGS (Nederland) BV**

Malledijk 18  
Spijkenisse  
AE  
3200  
The Netherlands  
Contact: Mr Rolf Wilting  
T: + 31 181 69 3260  
F: + 31 181 69 3581  
E: rolf.wilting@sgs.com  
W: www.sgs.nl

**SGS Australia Pty Ltd**

Unit 16  
33 Maddox Street  
Alexandria  
NSW  
2015  
Australia  
Contact: Mr Stephen Hemsworth  
Job Title: National Business Manager  
T: + 61 2 8594 0400  
F: + 61 2 8594 0419  
E: stephen.hemsworth@sgs.com  
W: www.au.sgs.com  
SGS is the world's leading inspection, verification, testing and certification company. SGS also designs and supplies mechanical sampling systems for a wide range of bulk materials. SGS has more than 30 years experience in this field with equipment in operation throughout the world.

**SGS Austria Controll-Co GmbH**

Diefenbachgasse 35  
Vienna  
A 1150  
Austria  
Contact: Ms Susann Beyer  
T: + 43 1 512 25 67152 137  
F: + 43 1 512 25 679  
E: sgs\_austria@sgs.com  
W: www.at.sgs.com

**SGS Minerals Services**

1 Place Des Alps  
PO Box 2152  
Geneva  
CH 1211  
Switzerland  
Contact: Mr Richard Lihou  
T: + 41 22 739 9111  
F: + 41 22 739 9815  
E: richard.lihou@sgs.com  
W: www.sgs.com  
The SGS Group is the global leader and innovator in verification, inspection, testing and certification services. Founded in 1878, SGS is recognised as the global benchmark for the highest standards of expertise and integrity. With over 30,000 employees, the Company operates a network of offices and laboratories in over 140 countries around the world.

**SGS Minerals Services**

185 Concession Street  
PO Box 4300  
Lakefield  
ON  
K0L 2H0  
Canada  
Contact: Ms Jean Richardson  
Job Title: Global Director Marketing  
T: + 1 705 652 2000  
F: + 1 705 652 6365  
E: minerals@sgs.com  
W: www.sgs.com/coal  
SGS works hand-in-hand with your operations to provide cost-effective solutions to minimize operational and financial risk. Our global technical leadership and industrial expertise provides an unrivalled global benchmark of experience and value to help you control your coal operations..

**Shanghai Qifan Co., Ltd.**

25F, Baoding Mansion  
Xujiahui Road  
Shanghai  
200025  
China  
Contact: Mr Eric Liu  
T: + 86 21 51029257  
F: + 86 21 51062358  
E: ericsphy@163.com  
W: http://www.qifangrab.com.cn/

**Shanghai Yo-Pi Port Machinery Co. LTD**

Room 603, No 3 Lane 298  
East Wenshui Road  
Shanghai  
PR  
China  
Contact: Miss Avril  
T: + 86 21 552 28716  
F: + 86 21 5522 8739  
E: grab@shyp-pm.com  
W: www.shyp-pm.com/

**Shanghai Zhenhua Port Machinery Co (ZPMC) Ltd**

3470 Pudong Nan Lu  
Shanghai  
PR  
200125  
China  
Contact: Mr Chen Kai  
Job Title: General Manager  
T: + 86 21 5839 6666  
F: + 86 21 5839 9555  
E: mail@zpmc.com  
W: www.zpmc.com  
Shanghai Zhenhua Port Machinery Co Ltd (ZPMC) is a world-famous manufacturer of cranes and large steel structures. Its main products include quayside container cranes, rubber-tyred gantry cranes (RTGs), bulk-material ship loaders and unloaders, bucket wheel stackers and reclaimers, portal cranes, floating cranes, engineering vessels and large steel bridge structures.

**Shanthi International**

21, Center Point  
Indira Gandhi Road  
Jamnagar  
Gujarat  
361008  
India  
Contact: Mr Sanjay Masuria  
Job Title: Director - Marketing - International  
T: + 91 288 255 6671 / +91 288 2555 867  
F: + 91 288 255 4254  
E: sanjay@servoday.in  
W: www.servoday.com  
Manufacturer & Exporter of Radio Remote Control Grabs, capacity from 6CBM to 22 CBM, with the Unique features of Grabs operation counting, with Weight calculation, online Grab monitoring systems etc.

**Shaw Almix Canada**

PO Box 430  
Parry Sound  
Ontario  
P2A 2X4  
Canada  
Contact: Ms Pamela Mc George  
Job Title: Sales Manager  
T: + 1 705 746 5884 / +1 9053317177  
F: + 1 705 746 9484  
E: Pamela\_mcgeorge@almex.com  
W: www.almex.com

**Shering Weighing Ltd**

Pitrevie Business Park  
Dunfermline  
Fife  
KY11 8UL  
UK  
Contact: Mr Douglas Shering  
Job Title: Managing Director  
T: + 44 1383 621 505  
F: + 44 1383 620 262  
E: sales@shering.com  
W: www.shering.com  
Weighbridges, weighing systems, platform scales, load cells available. All bespoke requirements can be handled.





## SIBRE (Siegerland Bremsen)

Auf der Stücke 1-5  
Haiger  
Hessen  
D-35708  
Germany  
Contact: Ms Janine Schmidt  
Job Title: Marketing & Advertising  
T: + 49 2773 9 40019  
E: janine.schmidt@sibre.de  
W: www.sibre.de  
For over 45 years Siegerland-Bremsen has been known worldwide as a manufacturer of industrial disc-, drum- and band-brakes. One of the main applications of SIBRE brakes are harbour cranes and conveyors. SIBRE's product range covers: gantry, trolley, main- and

boom- hoist service and emergency brakes, thrustor wheel chocks as well as storm brakes.

## SIDERAR / TERNIUM

Centro de Informacion  
Ave. Cordoba 320, Piso 4  
Ciudad Autonoma de Buenos Aires  
Buenos Aires  
C1054AAP  
Argentina  
Contact: Mr Ariel Fabrè  
Job Title: Engineer  
T: + 54 11 4018 6538  
F: + 54 11 4018 1005  
E: BAIIFA@techint.net  
W: www.siderar.com

## Siebtechnik GmbH

Platanenallee 46  
Mülheim an der Ruhr  
D-45478  
Germany  
Contact: Mr G Liefke  
T: + 49 208 580 100  
F: + 49 208 580 1300  
E: sales@siebtechnik.com  
W: www.siebtechnik.com

## Siemens AG

Universitätsallee 16  
Bremen  
28359  
Germany  
Contact: Mr Hans-Peter Techau  
Job Title: Sales Manager  
T: + 49 421 364 2452  
F: + 49 421 364 2828  
E: hans-peter.techau@siemens.com

## Siemens AG

Frauenauracherstrasse 80  
Erlangen  
91050  
Germany  
Contact: Mr Hans Hertogh  
Job Title: Marketing Manager  
T: + 31 70 33 33 066  
F: + 31 70 33 33 534  
E: cranes.i@siemens.com  
W: www.siemens.com/cranes  
Safety, reliability and performance of Siemens' cranes drive & control systems is widely recognized. During the last 10 years over 3000 harbour cranes are equipped with Siemens. Simocrane crane-control & -automation technology combined with Siemens' extensive cranes know-how ensure maximum safety, reliability,

efficiency and productivity of your crane.

## Siemens Nederland NV

PO Box 16068  
The Hague  
2500 BB  
The Netherlands  
Contact: Mr Hans Hertogh  
T: + 31 70 33 33 066  
F: + 31 70 333 3534  
E: hans.hertogh@siemens.com  
W: www.siemens.com

## SIG Società Italiana Gomma Spa



Via Colombo 144  
Gorla Minore  
Varese  
21055  
Italy  
Contact: Mr Gerardo Frizzati  
T: + 39 0331 365135  
F: + 39 0331 365215  
E: sig@sig.it  
W: www.sig.it  
The Italian leading producer of rubber conveyor, elevator and tubular belts with textile and steel cord carcass. Primary markets are mines, power stations, iron and steel industries, cement factories and all bulk material handling plants as harbour terminal, grain silos, waste processings.

## Silvan Dis Ve IC Ticaret AS

Akasyali Sok  
Konak Apt.  
5/8-9 Suadiye  
Istanbul  
Turkey  
Contact: Mr Tarik Gursal  
T: + 90 216 380 36 18  
F: + 90 216 416 91 59  
E: info@silvanticaret.com  
W: www.silvanticaret.com

## Sime Industrie

20, allée des érables  
B P 40004  
Roissy  
CDG Cedex  
F-95911  
France  
Contact:  
Job Title: Marketing Manager  
T: + 33 1 49 90 32 20  
F: + 33 1 49 89 06 38

## Simplicity Projects Pvt Ltd

17 Community Centre  
Maya Puri, Phase 1  
New Delhi  
110064  
India  
Contact: Mr R K Makhija  
Job Title: President  
T: + 91 11 2811 5093  
F: + 91 11 2811 6744  
E: sppl@simplicityprojects.com  
W: www.simplicityprojects.com

**WE MANUFACTURE IN ITALY TO  
SUPPLY ALL AROUND THE WORLD**

**CONVEYOR & ELEVATOR BELTS  
STEEL CORD & TEXTILE**

ISO 9001

21055 Gorla Minore (Italy)  
Phone +39 0331 36.51.35  
Fax +39 0331 36.52.15

Via Colombo, 144  
www.sig.it  
E-Mail: sig@sig.it





SENNEBOGEN 60

1952-2012



SAVING\*  
**75%**

**25%**  
OPERATING COSTS

**8130<sub>EQ</sub>**

**NEW!**

**75 % SAVINGS:** Balancer-technology & electric drive

- 1** The EQ principle - constant equilibrium  
low energy consumption and operating costs, very low connection costs
- 2** Large operation range  
2290 m<sup>2</sup> working area with 5 t load at 27 m reach
- 3** Maintenance and service made easy  
accessible engine compartment, easy to service in any weather
- 4** Modular design  
crawlers, rail gantry, stationary, pontoon, crawler gantry
- 5** The largest of its class - the new **MASTERGAB** \*\*  
excellent feeling of spaciousness and all-round view, large floor-window



\* by up to 75% in comparison with conventional diesel motor drive concepts    \*\*optional equipment

## SMB International GmbH



Friedrich List Str 3-5  
Quickborn  
Hamburg  
D- 25451  
Germany  
Contact: Mr Andreas Heckel  
Job Title: Managing Director  
T: + 49 41 06 12388 0  
F: + 49 41 06 12388 19  
E: heckel@smb-group.de  
W: www.smb-shiploading.com  
SMB specializes in 1. Shiploaders for various bulk and bag materials such as fertilizers, sulphur, grains and cement. 2. Reclaimers 3. Conveying systems 4. Bucket Elevators 5. Warehousing systems for pallets 6. Automatic palletizers.

## Smiley Monroe Ltd

23 Ferguson Drive  
Knockmore Hill Industrial Park  
Lisburn  
Co. Antrim  
Northern Ireland  
BT28 2EX  
UK  
Contact: Mr Tim Monroe  
Job Title: Marketing Manager  
T: + 44 28 9267 3777  
F: + 44 28 9266 3666  
E: sales@smileymonroe.com  
W: www.smileymonroe.com  
A leading United Kingdom manufacturer of moulded rubber and PU products, spillage control systems, belt alignment equipment and belt scrapers. The portfolio includes modular products such as impact bars, skid bars and skirt boards for ease of installation and replacement, together with encapsulation systems for conveyors and for screens and feeders.

## SMM-UM Sociedade de Montagens Metalomecnicas SA

Quinta da Fonte  
Edificio D. João I  
Paço de Arcos  
2770-203  
Portugal  
Contact: Ms Ines Goncalves  
T: + 351 21 4697600 / 607  
F: + 351 21 4697612  
E: ines.goncalves@smm.com.pt  
W: www.smm.com.pt  
Maintenance and Revamping of Lifting and Handling Equipments

## Sobemai by IRI nv

Bogaardestraat 168M  
Maldegem  
Oost-Vlaanderen  
B-9990  
Belgium  
Contact: Mr Kilian de Lille  
Job Title: Sales Dept  
T: + 32 50 711801  
F: + 32 50 710402  
E: sales@sobemai.com  
W: www.sobemai.com  
Manufacturer of equilibrated cranes, capable of lifting up to 200 ton. Capacities up to 5000 ton per hour. PLC controlled. For container handling, bulk, scrap and general cargo. Pedestal-, pontoon-, track- or bogie mounted.

## Societe de Tolerie Industrielle Francaise

Artisanal Zone de la Lande



Street Savennieres  
St Georges Sur Loire  
ZI 49170  
France  
Contact: Mr Manuel Burgos  
T: + 33 2 41 72 16 82  
F: + 33 2 41 39 32 12  
E: m.burgos@stifnet.com

## Solimar Pneumatics

8001 Ranchers Road NE  
Minneapolis  
Minnesota  
MN 55432-3103  
USA  
Contact: Mr Jeff Lucke  
Job Title: Director of Sales  
T: + 1 763 574 1820  
F: + 1 763 574 1822  
E: jeff@solimarpne.com  
W: www.solimarpneumatics.com  
Solimar Pneumatics is a leading designer and supplier of aeration systems and engineered components for the dry bulk material handling industry. Solimar is backed by over 40 years of experience specializing in aeration devices and discharge aids that assist the pneumatic flow of dry products like cement and flour.

## Solitec Engineering Ltd

Unit 8  
Gilchrist Thomas Industrial Estate  
Blaenavon  
Gwent  
NP4 9RL  
UK  
Contact: Mr David Woodland  
Job Title: General Manager  
T: + 44 1495 790623  
F: + 44 1495 790666  
E: sales@solitec.co.uk  
W: www.solitec.co.uk

## Sotecma Inc Process Engineers

3126 Bernard-Pilon  
Suite 200  
Saint-Mathieu-de-Beloil

Quebec  
J3G 4S5  
Canada  
Contact: Ms Odette Lecomte  
Job Title: Administrative Assistant  
T: + 1 450 464 4426  
F: + 1 450 464 4534  
E: olecompte@sotecma.com  
W: www.sotecma.com

## Specialised Handling & Eng (Pty) Ltd

PO Box 125  
Featherbrooke Estate  
Mogale  
Gauteng  
1746  
South Africa  
Contact: Mr Derek Albertson  
Job Title: Managing Director  
T: + 27 11 662 1649  
F: + 27 11 662 1049  
E: she@she.co.za  
Specialised Handling are specialists in rail wagon unloading stations and bulk materials handling machinery and systems. Their equipment range includes tipplers, wagon positioning and hauling machinery, wagon unloaders, tilters, wagon movement control devices, stackers, reclaimers, shiploaders, and steep angle conveyors.

## Specimas

Via Galvani Nr 1  
Nova Milanese  
Milan  
20054  
Italy  
Contact: Mr Ottonel Popesco  
T: + 39 036 24 55 101  
F: + 39 036 24 12 33  
E: ottonel.popesco@cavotec.com

## Spiroflow Ltd

Lincoln Way  
Clitheroe  
Lancashire

BB7 1QG  
UK  
Contact: Mr Ben Ayrton  
Job Title: Marketing Assistant  
T: + 44 1200 422525  
F: + 44 1200 429165  
E: sales@spiroflow.com  
W: www.spiroflow.com  
Spiroflow is a leading designer and manufacturer of Bulk Bag (FIBC) Fillers and Dischargers. Their comprehensive range covers the simple filling and emptying of dust-free materials right through to the 'total containment' of hazardous chemicals.

## STAG AG

Industriestrasse 11  
Maienfeld  
7304  
Switzerland  
Contact: Mr Walter Furgler  
Job Title: Sales/Marketing  
T: + 41 81 303 5800/45  
F: + 41 81 303 5899  
E: office@stag.net  
W: www.stag.net  
STAG bulk material technology for mechanical and pneumatic conveying technology as well as ensilage technology. We are also the ideal partner as a general company for complex assignments for nearly all bulk materials in plant construction.

## Standard Industrie (Aircroc)

139 - 141 Rue du Luxembourg  
Roubaix  
59100  
France  
Contact: Mr Paul Brunbrouck  
Job Title: Sales Manager  
T: + 33 320 283 232  
F: + 33 320 685 1162  
E: market@standard-industrie.com  
W: www.standard-industrie.com  
- Silos and hoppers deglugging and cleaning: AIRCHOC-GIRONNET - Optimization of conveyor belts

(LIFTUBE) and belt cleaners - Vacuum cleaning equipment

## Starlinger & Co. GmbH



## Starlinger

Sonnenuhrgasse 4  
Vienna  
A-1060  
Austria  
Contact: Mr Alfred Rufswurm  
Job Title: Marketing Manager  
T: + 43 1 599 55 0  
F: + 43 1 599 55 180  
E: office@starlinger.com  
W: www.starlinger.com  
Starlinger is the world's leading producer of machinery for woven plastic sack production (coated or uncoated sacks, Leno, valve sacks, AD\*STAR® block bottom valve sacks and FIBCs). The product range also includes plastics recycling machines, PET bottle recycling and PET solid staling lines.

## Stas BV

Kathodeweg 4  
Hoom  
1627 LK  
The Netherlands  
Contact: Mr Rob ver Doren  
Job Title: Managing Director  
T: + 31 229 282 940  
F: + 31 229 233 177  
E: info@stasgroup.eu  
W: www.stas-nl.com  
Stas is a manufacturer (production) of transport rollers, drive and tension drums and import bearings and bearing blocks.



# Material Handling Company



## The SMB Group offers complete Solutions

Loading systems  
Level measuring instruments  
Palletizers  
Warehouse systems  
Filling systems  
Conveyor systems  
Shiploader

**SMB** | Group  
best solution



SMB International GmbH  
Friedrich-List-Str. 3-7 · D-25451 Quickborn  
Phone +49 (0)4106/123 88-0  
info@smb-gmbh.de · www.smb-group.de



LOAD, UNLOAD AND  
**STOCKPILE**  
SHIP, BARGE  
AND RAIL



HIGHEST CAPACITIES ON THE PLANET



SAFEST AND MOST STRUCTURALLY SOUND



INSTANT PORTABLE TRUCK UNLOADING

## GO ANYWHERE. DO ANYTHING.

- Highly mobile conveyor designs.
- Functional machines for multiple applications.
- Robust designs withstand demanding work.
- Custom engineered to accommodate job site.

 superiorindustries

 @superiorind

**SUPERIOR**<sup>®</sup>

[www.superior-ind.com](http://www.superior-ind.com)



**Stevenel Oy**



Juhlatalonkatu 6 C 45  
Tampere  
FIN - 33100  
Finland  
Contact: Mr Heikki Hyysalo  
Job Title: Managing Director  
T: + 358 40 5037 616  
F: + 358 3 261 9773  
E: stevenel@stevenel.com  
W: www.stevenel.com  
Stevenel Ltd offers automated and semi-automated cargo handling attachments for fully hydraulic cranes at ports and terminals. We offer lift frames for pulp, sawn timber, steel products, paper reels, big bags, pallet cargo etc...

**Stewart Inspection and Analysis**

**(Pty) Ltd**  
PO Box 267  
Brakpan  
1541  
South Africa  
Contact: Mrs Carol Le Cordeur  
T: + 27 11 740 0621  
F: + 27 11 740 0626  
E: clecordeur@stewartgroupglobal.com  
W: www.stewartgroupglobal.com

**Stock Equipment Company**

16490 Chillicothe Road  
Chagrin Falls  
Ohio 44023-4398  
USA  
Contact: Mr Simon Shipp  
Job Title: Business Development  
T: + 1 800 289 7326 ext: 217  
F: + 1 440 543 5944

E: simon.shipp@stockequipment.com  
W: www.stockequipment.com

**Stockpile Surveying and Protection BVBA**

Bankwegelhof 93C  
Beveren-Waas 9120  
Belgium  
Contact: Mr Joeri Verbraeken  
T: + 31 180 556561  
F: + 31 180 556289  
E: joeri.verbraeken@ssp-belgium.com

**Stokman BV**

Brasem 18  
Raamsdonksveer  
AB 4941 SE  
The Netherlands  
Contact: Mr Jan Stokman  
Job Title: General Manager  
T: + 31 162 516040  
F: + 31 162 517590  
E: stokmanbv@stokmanbv.com  
W: www.stokmanbv.com  
Produces, installs and repairs heavy duty bulk handling systems including ship-mounted equipment for self-unloaders.

**Stora Enso**

PO Box 309  
Helsinki FI-00101  
Finland  
Contact: Mr Lauri Peltola  
Job Title: Head of Group Communications  
T: + 358 2046 21380  
F: + 358 2046 21267  
E: lauri.peltola@storaenso.com  
W: www.storaenso.com

**Strudes Inc**

4700 De La Savane  
Suite 218

Montreal  
Quebec  
H4P 1T7  
Canada  
Contact: Mr Henry Nowodworski  
Job Title: President  
T: + 1 514 731 6951 x 123  
F: + 1 514 737 4146  
E: nowodworski@strudes.ca  
W: www.strudes.ca  
Strudes Inc. is an Engineering Consulting Company, specializing in design for heavy industry in general and Cement Industry in particular. For markets and more information: www.strudes.ca.

**Sub Con Ltd**

20 Shamrock Road  
Erin  
Ontario NOB 1T0  
Canada  
Contact: Mr Don Johnston  
T: + 1 519 833 0054  
F: + 1 519 833 9344  
E: don@bulk-store.ca

**Sucofindo**

Laboratory Strategic Business Unit  
Graha Sucofindo 2nd Floor  
Jl Raya Pasar Minggu Kav.34  
Jakarta 12780  
Indonesia  
Contact: Mr Diding Sudira  
Job Title: Manager  
T: + 62 21 798 6567  
F: + 62 21 798 6878  
E: diding@sucofindo.co.id  
W: www.sucofindo.co.id

**Sumitomo Heavy Industries Eng.**

**& Services Co Ltd**  
ThinkPark Tower  
1-1 Osaki 2-chome

Shinagawa-ku  
Tokyo  
141-6025  
Japan  
Contact: Mr Akihide Ito  
Job Title: Acting General Manager,  
International Sales  
T: + 81 3 6737 2643  
F: + 81 3 6866 5181  
E: Akh\_Itou@shi.co.jp  
W: www.shi.co.jp  
Product range covers not only bulk handling but also cranes of all types. A leader in the field of continuous ship unloading with a long track record and experience with various materials, especially iron ore.

**Suomen Viljava Oy**

Kielotie 5 B  
Vantaa  
01300  
Finland  
Contact: Mr Hannu Korttesmaa  
Job Title: Marketing Manager  
T: + 358 10 3464 204  
F: + 358 01 3464 200  
E: hannu.korttesmaa@suomenviljava.fi  
W: www.suomenviljava.fi  
Suomen Viljava Ltd is Finland's biggest grain handling and storage company. We have stores at 21 locations in south and middle Finland. The total storage capacity is 1.4 million tonnes. Our services comply with ISO 9001 and GTP standards.

**Supercargo, Lda**

Rua Alfredo Cunha, 107  
Monte de Caparica  
2825-056 Caparica  
Portugal  
Contact: Mr Artur Rocha  
Job Title: Director  
T: + 351 212 946 220  
F: + 351 212 946 228

E: mail@supercargo.pt  
W: www.supercargo.pt  
Superintendents for loading / unloading Packing and stowage inspection, report of findings Damages surveys, loss prevention and evaluation Draft survey and complete survey on vessels (Gafa and Fosfa members and ISO 9001:2008 Approved)

**Superior Industries**



315 East State Highway 28  
PO Box 684  
Morris  
Minnesota  
56267  
USA  
Contact: Mr Corey Poppe  
Job Title: Marketing Manager  
T: + 1 320 589 2406  
F: + 1 320 585 5644  
E: info@superior-ind.com  
W: www.superior-ind.com  
Superior Industries has a reputation of engineering and manufacturing groundbreaking, bulk material handling conveyors and cutting-edge components including stacking, transfer and feed conveyors; portable ship loading and unloading conveyors; and conveyor idlers, pulleys, belt scrapers, sealing systems, impact beds and guarding.

**Svendborg Brakes A/S**

Jernbanevej 9  
Vejstrup  
5882  
Denmark



Enhance Your Port operations with fully/semi-automated attachments!

Stevenel for

- pulp units
- sawn timber, plywood, chipboard
- paper reels, big bags
- steel bars
- dry bulk, etc...

Head Office:  
Stevenel Oy, Juhlatalonkatu 6 C 45  
FIN-33100 Tampere, Finland  
Tel: +358 40 5037 616  
Fax: +358 3 2225 939  
stevenel@stevenel.com

www.stevenel.com



*Telestack mobile hoppers feeding Telestack radial telescopic shiploaders loading a Handymax vessel at 1,500tph*



Contact: Ms Yvonne Küttemann  
Job Title: Marketing Manager  
T: + 45 63 255 255  
F: + 45 62 281 058  
E: yak@svendborg-brakes.com  
W: www.svendborg-brakes.com  
A competent end-to-end hydraulic brake systems company, originally founded in 1893. Product range includes Hydraulic Disc Brakes - from 2,000N to 500,000N clamping force, Hydraulic Power Packs and Intelligent Brake Control and Monitoring Systems. Production facilities in Denmark, Germany and Spain. Sales offices in Denmark, Germany, Spain, France, the Czech Republic, Poland, Australia and the USA.

## Swire CTM Bulk Logistics



C Transport Maritime SAM  
Gildo Pastor Centre  
7 Rue du Gabian  
Monaco  
MC 98000  
Monaco  
Contact: Captain Giorgio Vallega  
Job Title: Operation/Commercial Manager  
T: + 377 9798 5981  
F: + 377 9798 2306  
E: gvallega@ctmmc.com  
W: www.swirectmbl.com  
Sums up the experience, know-how and networks of its parent companies in the dry bulk and logistics field, providing a full range of integrated services from the supplier to the end users, including specialised barge services, transshipment, river, coastal and ocean transportation by means of conventional bulk carriers or self-unloading vessels and barge.

## T D Micronic Inc

640 w 26 Ave.  
Vancouver  
BC V5Z 4H6  
Canada  
Contact: Mr David McCormick  
T: + 1 604 594 9191  
F: + 1 604 594 9193  
E: dsawrey@gmail.com  
W: www.tdmicronic.com

## TAIM WESER, S.A.

Carretera de Castellón, km 6,3  
Poligono Industrial La Cartuja  
Zaragoza  
50013  
Spain

Contact: Mr Luis Monge  
T: + 34 976 50 00 06  
F: + 34 976 50 00 28  
E: info@taimweser.com  
W: www.taimweser.com  
TAIM WESER is a World leading company within the fields of bulk materials handling, lifting equipment, waste treatment plants and renewable energy, with more than 100 years of experience and committed to innovation and technology.

## TAKRAF GmbH

Torgauer Str. 336  
Leipzig  
D-04347  
Germany  
Contact: Dr Holger Lieberwirth  
Job Title: Executive Vice President  
T: + 49 341 2423943  
F: + 49 341 2423610  
E: sales@takraf.com  
W: www.takraf.com  
With more than a century of experience and tradition in the field of open cast mining, bulk materials handling, the company is proud of its worldwide standing. Services offered: planning, design, fabrication, erection and after sales service of machines, systems and complete plants.

## TAKRAF India Pvt. Ltd.

94/3, TTK Road  
Alwarpet  
Chennai 600 018  
India  
Contact: Ms Jayanthi Kandhasami  
Job Title: Marketing Executive - Mining & Minerals  
T: + 91 44 24995514  
F: + 91 44 24996451  
E: jayanthi@takraf.com  
W: www.takraf.co.in  
TAKRAF India Pvt. Ltd., a wholly owned subsidiary within Tenova Mining & Minerals Division, a world leader in the mining and bulk handling equipment. TAKRAF as a competent, experienced, capable and reliable partner for our customers offers system solutions within the core areas open-cast mining and bulk material handling technology.

## TAURUS EMERGÉ

Rubber Industrial VII  
Kerpesi ut 17  
Budapest  
1965  
Hungary  
Contact: Mr Viktor Vajda  
T: + 36 62 566 700  
F: + 36 1113 2912

E: marketing@taumrg.u  
W: www.taumrg.u

## TBMA Europe BV

Delfweg 18  
Noordwijkerhout  
NL-2211 VM  
The Netherlands  
Contact: Mr E A J Houben  
Job Title: Managing Director  
T: + 31 252 37 50 68  
F: + 31 252 37 54 36  
E: info@tbma.com  
W: www.tbma.com/engels/  
TBMA manufacture and supply a wide range of FIBC Filling- and FIBC Discharging machines. We are specialists in filling-off fine, aerated powders ensuring volume reduction and a stable FIBC. Our range of automatic bag emptying machines can handle up to 1,500 bags/hour.

## Tebodin Consultants & Engineers

P.O. Box 16029  
The Hague  
2500 BA  
The Netherlands  
Contact: Mr R J Smits van Oyen  
Job Title: Manager Logistics, Asset Management & Maintenance  
T: + 31 70 348 0249  
F: + 31 70 348 0591  
E: info@tebodin.com  
W: www.tebodin.com  
An independent multi-disciplinary engineering and consulting firm, employing some 3,500 employees, located at 40 offices in 26 countries in Europe, the Middle East and Asia. Possessing an extensive international knowledge and experience in providing engineering consultancy services in the field of ports and terminals. Services range from preliminary studies for port development to the detailed design and construction supervision of terminals.

## techNaero aps

Finlandsgade 29  
Haslev  
DK-4690  
Denmark  
Contact: Mr Anders Larsen  
Job Title: CEO  
T: + 45 56314925  
F: + 45 56314555  
E: sales@techNaero.dk  
W: www.techNaero.dk  
We are selling, planning, producing and commissioning filtration systems

for the world market. We have supplied filtration systems to customers in Scandinavia, Russia, Ukraine and Georgia. Huge filter systems shipped in ordinary containers to very competitive prices, worldwide. Standard control system able to communicate directly with the control room.

## Telestack Limited



Omagh  
County Tyrone  
BT79 0NZ  
Northern Ireland  
Contact: Miss Samantha Gant  
Job Title: Marketing Co-Ordinator  
T: + 44 28 82 25 11 00  
F: + 44 28 82 25 22 11  
E: samantha@telestack.com  
W: www.telestack.com  
Specialist manufacturers of Mobile bulk material handling systems for the Ports/Inland terminals, Mines, Quarries, Steel Mills, Cement Plants and Powerstation industries globally. The mobile range of equipment offers unrivalled flexibility for the operator, reducing costs in Cap Ex Investment compared to fixed installations, fuel and labour. We have supplied and support some of the world largest blue chip companies.

## Tema BV

PO Box 3220  
Rijswijk  
GE  
2280  
The Netherlands  
Contact: Mr M P van Delden  
T: + 31 70 390 6555  
F: + 31 70 399 3390  
E: mp.vandelden@tema.nl  
W: www.tema.nl

## TEMA Systems Inc.

7806 Redsky Drive  
Cincinnati  
Ohio  
45249  
USA  
Contact: Mr Mike Mullins  
T: + 1 513 489 7811  
F: + 1 513 489 4817  
E: sales@tema.net  
W: www.tema.net

## TENOVA S.p.A - Tenova Takraf

Italy  
Via Albareto, 31  
Genova  
16153  
Italy  
Contact: Mr Pietro Bibolini  
Job Title: Commercial Director  
T: + 39 010 605 4634  
F: + 39 010 605 4710  
E: pietro.bibolini@it.tenovagroup.com  
W: www.tenovagroup.com  
Key supplier of equipment and systems for open pit mining, bulk and specialized materials handling, milling and crushing, and air pollution control to the global mining and mineral processing industries, and general industry. A comprehensive after sales service is provided.

## TENOVA TAKRAF

(FORMERLY BATEMAN ENGINEERED TECHNOLOGIES)  
P.O. Box 75996  
Gardenview  
2047  
South Africa  
Contact: Mr Peter Cheshire  
OR Mr Alf Pain  
T: + 27 11 201 2300  
F: + 27 11 455 4547  
E: enquiries@bateman.com  
W: www.tenovagroup.com  
GLOBAL LEADERS IN BULK MATERIALS HANDLING  
Tenova is a worldwide supplier of advanced technologies, products, and engineering services for the iron & steel and mining industries providing innovative, integrated solutions for complete process areas.

## Terex Cranes c/o Terex Demag GmbH

Dinglerstr. 24  
Zweibrücken  
66482  
Germany  
Contact:  
Job Title: Global Marketing  
T: + 49 6332 83 0  
F: + 49 6332 83 1602  
E: Info.portequipment@terex.com  
W: www.terexcranes.com  
Terex Cranes is the only construction equipment manufacturer to provide you with a full line of cranes and port equipment. Our offering ranges from Reachstackers to Straddle Carriers or Ship to Shore cranes and from compact City Cranes to the biggest crawler crane ever built.



# Fastest Hatch Change Times



**HATCH  
TO HATCH  
IN  
LESS THAN  
2 MINUTES**



Mobile Hopper directly feeding the Shiploader



Hopper - Link - Shiploader



Silo - Conveyor - Shiploader



Truck - Truck Unloader - Barge

- All Wheel Powered Travel / Steering (Parallel - Radial - Inline)
- Full Dust Containment / Suppression / Extraction
- Fully sealed Feed In / Transfer / Discharge Points
- Cascade, Free-fall, Trimmer Chutes Available
- Load, Discharge & Stockpile with Same System
- System fed from range of Truck Unloaders, Hopper Feeders, Link Conveyors and Fixed / Tripper Conveyors

**THE  
POWER  
TO MOVE  
MATERIALS™**

[info@telestack.com](mailto:info@telestack.com)

[www.telestack.com](http://www.telestack.com)

## Terex Fuchs GmbH



Industrie str. 3  
Bad Schönborn  
76669  
Germany  
Contact: Mrs Bettina Hartlieb  
Job Title: Marketing  
T: + 49 725 384 101  
F: + 49 725 384 212  
E: bettina.hartlieb@fuchs-terex.de  
W: www.terex-fuchs.de  
Established in 1888, Terex Fuchs is a specialist technology provider and global player for loading machines and handling units.

## Teta Mühendislik A. .

Çankırı Yolu 7.km Aselsan Karşısı  
Akyurt  
Ankara  
06950  
Turkey  
Contact: Mr Talat Isik  
Job Title: General Manager  
T: + 90 312 8475361  
F: + 90 312 8475399  
E: teta@tetamuh.com.tr  
W: www.tetamuh.com.tr  
Engineering, manufacturing and supply of grain storage systems, bagging machines and bulk weighers.

## Thames Side Sensors Ltd

Unit 10 io Trade Centre  
Deacon Way  
Reading  
Berkshire  
RG30 6AZ  
UK

Contact: Mrs Maureen Forrester  
Job Title: Marketing Manager  
T: + 44 1189 411387  
F: + 44 1189 458225  
E: mforrester@thames-side.co.uk  
W: www.thames-side.com  
Thames Side Sensors are the UK Market Leaders in load cells and mounting assemblies for Process Weighing, with an un-rivalled reputation for service, flexibility and quality. With over 30 years experience we believe that no-one can match our extensive range and innovative products.

## The ACT Group

14644 El Molino Street  
Fontana  
CA  
92335  
USA  
Contact: Mr Edward Sunseri  
T: + 1 909 350 4703  
F: + 1 909 350 4982  
E: esunseri@groupactinc.com  
W: www.groupact.com  
Specialists in the process, containment and control of dust for all bulk materials. The Group offers full design and engineering, procurement, installation and fabrication and after market service and repair for conveyors, crushers, screens, dust collectors and dust suppression systems.

## The BRUKS Group

PO Box 46  
Vastergatan  
Arbrå  
Gävleborg County

SE-82010  
Sweden  
Contact: Mr Lars Lindvall  
Job Title: Sales Manager  
T: + 46 278 642547  
F: + 46 278 642520  
E: ll@bruks.com  
W: www.bruks.com

## The China Navigation Co. Pte. Ltd

300 Beach road #27-01  
The Concourse  
Singapore  
199555  
Singapore  
Contact: Mr Richard Sell  
Job Title: Commercial Manager  
T: + 65 6603 9429  
E: Richard.Sell@chinanav.com  
W: www.chinavav.com

## The Grab Specialist b.v.

Draaibrugweg 1  
Almere  
1332AA  
The Netherlands  
Contact: Mr Emiel Bleyenbergh  
Job Title: Director  
T: + 31 365 32 88 22  
F: + 31 365 49 99 22  
E: info@tgs-grabs.nl  
W: www.tgs-grabs.nl  
TGS manufactures all types of grabs for sale and rental; we have a stock of approx.60 pc.in all sizes. Also repairs can be done for other grabs. TGS is also certified as ISO 9001.



## The Raring Corporation

12007 NE 95th St  
Vancouver  
WA  
98682  
USA  
Contact: Mr David L Raring  
Job Title: President  
T: + 1 360 892 1659  
F: + 1 360 892 1624  
E: draring@raringcorp.com  
W: www.raringcorp.com

## Thermo Fisher Scientific

501 - 90th Avenue NW  
Minneapolis  
MN  
55433  
USA

Contact: Ms Paula Frisk  
Job Title: Product Manager/Marketing  
T: + 1 800 445 3503  
F: + 1 763 783 2525  
E: Sales.bulk.us@thermofisher.com  
W: www.thermoscientific.com/bulkweighing  
A leading manufacturer of weighing and monitoring products for the bulk material handling and processing industries, the Thermo Scientific product portfolio includes belt scales, conveyor protection switches, continuous and point level measurement, sampling equipment and tramp metal detectors. Contact us today to improve your process, productivity and profitability.



## SWIRE CTM BULK LOGISTICS



## Together Bridging the Gap between Supplier and Industry

### Mission:

To provide reliable customised and cost-effective dry-bulk seaborne supply chain services aimed at bridging the gap between Supplier and Industry

### Services:

- River and coastal specialized feeders
- Self-unloading vessels and barges
- Floating Cranes
- Floating Terminals
- Ship to Ship, Barge to Ship and Ship to Barge operations
- Handy max to Cape size Shipping
- Integrated seaborne logistics "dry-bulk door to door"

Monaco: Ph. +377 9798 5900  
Singapore: Ph. +65 6603 9400  
www.swirectmbl.com  
contacts: bulklogistics@swirectmbl.com

*your partner for progress*



# TEREX<sup>®</sup> FUCHS PORT SOLUTIONS



## The future of bulk handling

### Features

- ▶ Product range from 19 t to 95 t
- ▶ Radius up to 23 m
- ▶ Handling capacity up to 1,000 t/h
- ▶ Diesel or electrical engine
- ▶ On wheels, tracks or rails

### Benefits

- ▶ Fast working speed
- ▶ Independent of weather conditions
- ▶ Flexible operation place
- ▶ Low fuel consumption



thomas.berners@terex.com  
[www.terex-fuchs.com](http://www.terex-fuchs.com)



 **TEREX<sup>®</sup> | FUCHS**

**WORKS FOR YOU.**





## THIELE scraper reclaimer chains for circular salt storages



- High performance and quality
- Extended lifetime
- Safe and reliable

THIELE - More than 75 years experience in the engineering and manufacturing of conveyor chain systems such as round link chains, bushed conveyor chains, forged conveyor chains and cardan chains, including all attachments.

### Your experienced partner for chain technology



Bucket Elevator Chains



Bushed Conveyor Chains



Round Link Chains



Sprockets



Forged Link Chains



**THIELE GmbH & Co. KG**  
 Werkstr. 3, 58640 Iserlohn, Germany  
 bulkmaterial@thiele.de • www.thiele.de



**THIELE**





**THIELE GmbH & Co. KG**



Werkstr. 3  
Iserlohn  
D- 58640  
Germany  
Contact: Mr Matthias Suttrup  
T: + 49 2371 947 296  
F: + 49 2371 947 295  
E: bulkmaterial@thiele.de  
W: www.thiele.de  
THIELE - More than 75 years experience in the engineering and manufacturing of conveyor chain systems such as round steel chains, bushed conveyor chains, forged conveyor chains and cardan chains, including all attachments.

**ThyssenKrupp Canada**

1177-11th Avenue SW  
Suite 500  
Calgary  
Alberta  
2TR 1K9  
Canada  
Contact: Mr Steve Harrington  
Job Title: Vice President Marketing  
T: + 1 403 209 4431  
F: + 1 403 245 5625  
E: infocanada@thyssenkrupp.com  
W: www.krupp.ca  
Krupp Canada, located in Calgary, Alberta, has been involved for many years in the design and supply of turnkey, environmentally sensitive mining and material handling projects. The product line of equipment includes: conveying systems, crushing systems, stackers, ship loaders and unloaders, storage and reclamation

design and supply.

**ThyssenKrupp Fördertechnik GmbH**

Business Unit Materials Handling  
Ernst-Heckel-Strasse 1  
St Ingbert-Rohrbach  
Saarland  
D-66386  
Germany  
Contact:  
T: + 49 6894 599 0  
F: + 49 6894 599 468  
E: Info-mh@thyssenkrupp.com  
W: www.tk-materialshandling.com  
More than 100 years of experience in the design, engineering, supply, erection, supervision of erection and commissioning of material handling equipment and systems for the fertilizer and cement industry, for ports as well as complete coal handling plants for power stations.

**ThyssenKrupp Materials Handling**

71 Nanyuki Road  
Sunninghill  
Johannesburg  
Gauteng  
2191  
South Africa  
Contact: Mr Klaus Peter Müller  
Job Title: Managing Director  
T: + 27 11 236 1243  
F: + 27 11 236 1235  
E: info.tkmh@thyssenkrupp.com  
W: www.thyssenkrupp-materialshandling.co.za  
Leading OEM of bulk materials handling equipment in Southern Africa. The product range: Stockyard equipment, Port handling equipment,

Train/transport systems, Conveyors, Waste disposal solutions, Mining and processing equipment. ThyssenKrupp Materials Handling has a service and spares department that fully supports all of its machines in the field.

**ThyssenKrupp Robins, Inc.**

7730 E. Bellevue Ave  
Suite #404  
Greenwood Village  
Colorado  
80111-5820  
USA  
Contact: Mr Bill Halley  
Job Title: Mechanical Engineer  
T: + 1 303 770 0808  
F: + 1 303 770 4522  
E: bill.halley@thyssenkrupp.com  
W: www.krupprobins.com  
ThyssenKrupp Robins, located in Denver, Colorado, has been involved for many years in the design and supply of turnkey, environmentally sensitive mining and material handling projects. The product line of equipment includes: conveying systems, crushing systems, stackers, ship loaders and unloaders, storage and reclamation design and supply.

**Tideworks Technology - Europe**

Maaswijkweg 7  
Spijkenisse  
3203 LG  
The Netherlands  
Contact: Mr Rik Verspeek  
Job Title: Business Manager  
T: + 31 181 668668  
F: + 31 181 668660  
E: info@tideworks.com  
W: www.tideworks.com

**Timars Svets & Smide AB**

Industrivägen 12  
Falkenberg  
S-311 33  
Sweden  
Contact: Mr Peter Stenbeck  
T: + 46 346 82100  
F: + 46 346 82800  
E: info@timars.se  
W: www.timars.se  
Specialising in container and bulk cargo handling equipment. Products include bulk material measuring scales, loading bellows, discharge cones and 'Empty Boy' bulk material emptiers.

**TMEIC**

1325 Electric Road  
Roanoke  
Virginia  
24018  
USA  
Contact: Mr Don Samsa  
Job Title: Marketing  
T: + 1 540 283 2000  
F: + 1 540 283 2001  
E: don.samsa@tmeic-ge.com  
W: www.tmeic.com  
TMEIC is the leading company supplying variable frequency drives, motors and controls for container cranes, in particular for the automation of rail mounted gantry cranes. Equipment manufacture is in Japan.

**TMSA Tecnologia em Movimentação S/A**

Bernardino Silveira Pastoriza, 710  
Bairro Sarandi  
Porto Alegre  
RS

91160-310  
Brazil  
Contact: Mr Mathias Elter  
Job Title: CEO  
T: + 55 51 2131 3318  
F: + 55 51 2131 3330  
E: mathias.elter@tmsa.ind.br  
W: www.tmsa.ind.br  
TMSA is the leader in South America supplying grain/meal loading terminals, with references in coal, fertilizer, wood, sugar, iron, ore, coal, alumina, kaolin and other heavy duty commodities up to 4,000tph; conveying equipments for minerals up to 20,000tph 3,100Km, coal up to 2,400tph pipe conveyor 6,800Km.

**Tobu Jukogyo Co**

4-12-20, Kitazakae  
Urayasu City  
Chiba Pre  
279  
Japan  
Contact: Mr M Yoshida  
Job Title: Director  
T: + 81 473 525311  
F: + 81 473 525316  
E: info@tobugrab.com  
W: www.tobugrab.com

**Top Lift Int**

21 Teal Ave  
Stormy Creek  
Ontario  
L8E 2P1  
Canada  
Contact: Mr Joel Paikin  
Job Title: Sales Director  
T: + 1 905 662 4137 ext 14  
F: + 1 905 662 8058  
E: jpaikin@toplift.com

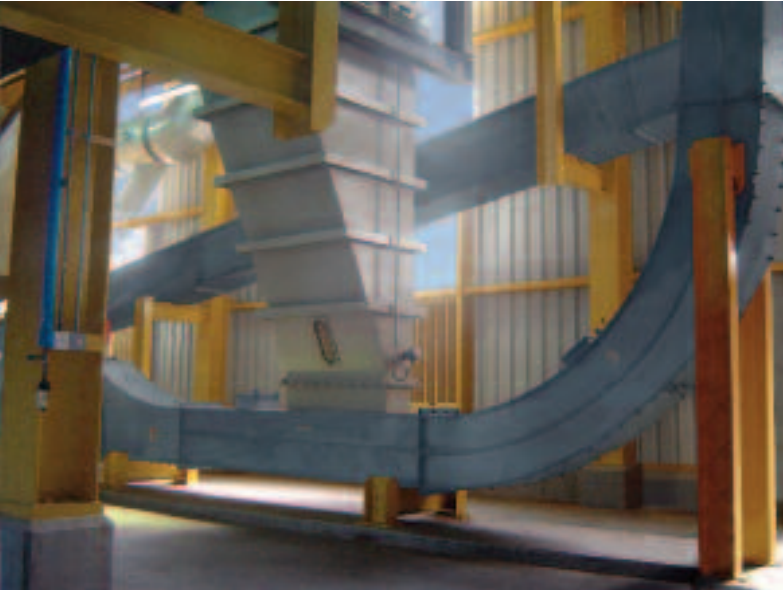

## The World's Most Complete Line of Chain and Enclosed Belt Conveyors.



**TRAMROLL™**  
Enclosed belt conveyor with innovative features such as; self-reloading and self-cleaning tail section, and multiple inlets. The heaviest-duty design in the industry.



**JETBELT™**  
An efficient system requiring less horsepower than other systems. Used for dry bulk handling requirements in a variety of products.



**MODEL RB**  
Designed for self-cleaning and quiet operation with a u-shaped trough for handling soft stock or materials that are easily crumbled or broken.



**BUCKET ELEVATOR**  
Centrifugal Discharge design used for the bulk handling of free-flowing fine and loose materials with small to medium size lumps. Built-to-last for the toughest requirements.

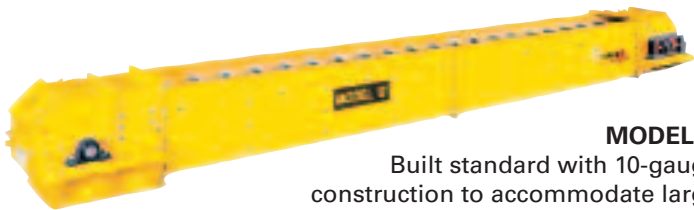

**MODEL G**  
Built standard with 10-gauge construction to accommodate large capacities of free-flowing materials. Provides years of trouble-free service under extreme applications.

**BULK-FLO™**  
The heavy-duty chain conveyor designed specifically for processing applications such as; wet and sticky, varying sizes and densities, and abrasive or corrosive materials.



## Tramco Europe Limited

Mandham Business Park  
Hull Road  
Hull  
HU12 8DZ  
UK  
Contact: Mr Gus Walker  
Job Title: General Manager  
T: + 44 1482 782 666/+44 7813 800251  
F: + 44 1482 793 920  
E: gus@tramcoeurope.karoo.co.uk  
W: www.tramcoinc.com  
Tramco Europe Ltd Design and manufacture chain and belt conveyors that deliver! Our products are all ATEX approved, robust, reliable and designed to handle severe processing applications. Our variety of designs allows flexibility to specify the size of conveyor for your capacity, at the best value.

## Tramco, Inc



1020 East 19th Street  
Wichita  
KS  
67214  
USA  
Contact: Mr Steve Cloud  
Job Title: President  
T: + 1 316 264 4604  
F: + 1 316 264 7965  
E: sales@tramcoinc.com  
W: www.tramcoinc.com  
TRAMCO has been involved in the design, application, engineering and manufacture of the worlds most complete line of chain conveyors, enclosed belt conveyors, specially designed conveyors and conveyor conversions since 1967. The combination of design, engineering, proper component selection, manufacturing, and after-sales service makes TRAMCO the source for consulting and supply in bulk material handling situations.

## Transas Marine

Datavagen 37  
Askim  
Gothenburg  
42632  
Sweden  
Contact: Ms Lidia Selivanova  
T: + 46 31 769 56 00  
F: + 46 31 69 41 84  
E: info@transas.com  
W: www.transas.com  
Transas is a world-leading developer and supplier of a wide range of software and integrated solutions for the transportation industry. The company's range of high-technology products includes onboard navigation systems, a broad range of maritime simulators, vessel traffic solutions.

## Trans-Global Solutions, Inc.

5255 N Twin City Hwy  
Nederland  
TX  
77627  
USA  
Contact: Mr William Scott  
Job Title: Vice President  
T: + 1 409 727 4801  
F: + 1 409 729 1132  
E: wfscott@tsggroup.com  
W: www.tsggroup.com

## Translift Port Equipment

Services Inc  
Building 3  
SRF Area  
Subic Bay

Zambales  
Freeport Zone 2222  
Philippines  
Contact: Mr John Wellington  
Job Title: Managing Director  
T: + 63 47 252 6332/4/5  
F: + 63 47 252 6336  
E: translift@transliftsubic.com

## Transystems Corporation

101 West Main Street, Suite 900  
Norfolk  
Virginia  
VA 23510  
USA  
Contact: Mr Brian Larson  
Job Title: Chairman  
T: + 1 757 627 1112  
F: + 1 757 672 1113  
E: brgarcia@transystems.com  
W: www.transystems.com  
TranSystems Corporation specializes

in condition assessments, maintenance and design of maritime facilities including container terminals, intermodal rail facilities, passenger and cruise terminals, break-bulk and neo bulk terminals and mixed-used developments. TranSystems is recognized in the United States and internationally for their innovative and cost-effective solutions for the maritime industry.

## TRF Limited (TaTa)

11 Station Road  
Burma Mines  
Jamshedpur  
Jharkhand  
831 007  
India  
Contact: Mr Rajen Sahay  
Job Title: Head of Corporate Communications

T: + 91 657 3046 407  
E: rajen.sahay@trf.co.in  
W: www.trfttd.com / www.tata.com/trf  
An engineering company with expertise in the field of bulk material handling and processing. Its products include ship loaders handling iron ore and other bulk products.

## Triodetic

10 Didak St  
Arnprior  
Ontario  
K7S 0C3  
Canada  
Contact: Mr Glenn Kohut  
Job Title: Vice President, Business Development  
T: + 1 613 822 2922  
F: + 1 613 822 1375  
E: info@triodetic.com  
W: www.triodetic.com

Designs, manufactures and constructs stockpile enclosures and roofs for tanks and storage/treatment facilities. Roofing consists of a network of connected steel or aluminium tubes as a space frame or single layer shell in any required geometric configuration. The product is pre-engineered and comes to site with protective coatings appropriate to the service life requirements.

## Triple Point Technology

22 Frith Street  
Mayfield West  
NSW  
2304  
Australia  
Contact: Mr Steve Maxwell  
Job Title: G/Vice President, Mining, APAC Sales  
T: + 61 2 4908 2222



# *Vibra*FLOOR

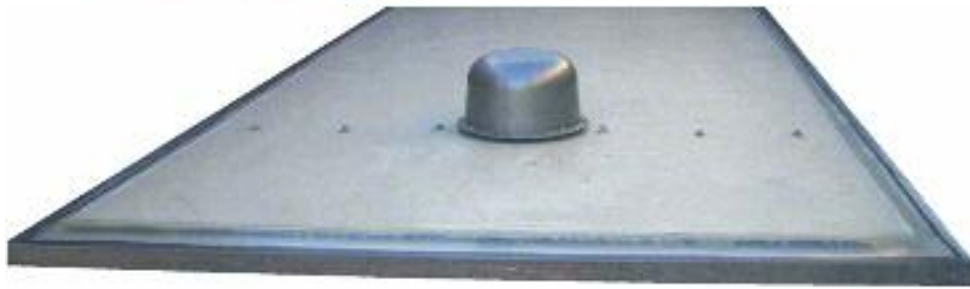

the utmost in bulk reclaiming



Storage domes



Self-unloading ships



Silos



railway cars

simple, maintenance free, automatic, efficient on most bulk products\*, negligible operating costs, *unbeatable reclaim rates*

\* cereals, oil seeds, sugar, flour, soya bean meal, wood pellets, wood chips, fertilizer prills, cotton seeds, fly ash, cement, ores, sulphur, charcoal, RDF etc...

VIBRAFLOOR F-71640 Givry +33(0)385440 678 +33(0)680 964 144

[jc.poncet@vibrafloor.com](mailto:jc.poncet@vibrafloor.com)



F: + 61 2 4968 2043  
E: info@tpt.com  
W: www.tpt.com  
Triple Point Technology® is the leading global provider of cloud and on-premise Commodity Management software. Triple Point's QMASTOR solutions manage the tonnage, quality and value of coal and mineral supply chains from "pit" to the point of export, import, or consumption.

**TSS Systems BV**

PO Box 206  
De Giessen 19  
Dronten  
8253 PR  
The Netherlands  
Contact: Mr Peter Slotjie  
T: + 31 321 33 90 91  
F: + 31 321 33 99 88  
E: info@tssystem.nl  
W: www.tssystem.nl  
European distributor of steel and stainless steel FLOVEYOR Aero-mechanical conveying systems capable of moving up to 50 tonnes per hour.

**ts-systemfilter gmbh**

Gänsäcker 9  
Ahorn Berolzheim  
74744  
Germany  
Contact: Mr H Straub  
T: + 49 6296 880  
F: + 49 6296 8855  
E: info@ts-systemfilter.de  
W: www.ts-systemfilter.de  
Produces filter units with dust separation equipment.

**Tsubakimoto Bulk Systems Corporation**

4-1  
Terauchi 2-Chome  
Toyonaka  
Osaka  
561-0872  
Japan  
Contact: Mr Y. Horii  
Job Title: Manager, Overseas Operations  
T: + 81 6 6862 2329  
F: + 81 6 6862 8516  
E: info@tsubakimoto.com  
W: www.tsubakimoto.com  
Produces bulk handling systems equipment, bucket, flow and pan conveyors.

**Tsuji Heavy Industries (Jiangsu) Co Ltd**

Du Jing Gang, Da Xin Zhen, Zhang Jia Gang  
Along Yang tze river, Economy & Development Zone  
Zhang Jia Gang  
215636  
China  
Contact: Mr Yang Yen Yoong  
Job Title: Dy. General Manager (Marketing & Sales)  
T: + 86 512 58713111  
F: + 81 0512 5873170  
E: yang@tsuji-hi.com.cn  
W: www.tsuji-hi.com.cn

**TTS Group ASA**

Folke Bernadottes vei 38  
Postboks 3577  
Fyllingsdalen  
Bergen  
Bergen  
5845  
Norway  
Contact: Mr. Peter Klasson  
Job Title: Communications & Marketing Coordinator  
T: + 47 55 94 74 08

F: + 47 55 94 74 01  
E: info@tts-marine.no  
W: www.ttsgroup.com

**TTS HuaHai Ships Equipment**

18th Floor  
3255 Zhou Jia Zui Road  
Shanghai  
200093  
China  
Contact: Mr Lian Zhou Yang  
Job Title: Business Development Manager  
T: + 86 21 6539 8257  
F: + 86 21 6539 7400  
E: info@tts-huahai.com

**TTX Corporation**

101 N Wacker Drive  
Chicago  
Illinois  
60606  
USA  
Contact: Mr Peter Wolff  
Job Title: Director - Market Development  
T: + 1 312 984 3722  
F: + 1 312 984 2682  
E: marketing@ttx.com

**Tufbag**

PO Box 155  
Mandini  
KwaZulu Natal  
4490  
South Africa  
Contact: Mr Russell Titmas  
Job Title: National Sales Manager  
T: + 27 32 459 5050  
F: + 27 32 459 2581  
E: russell.titmas@tufbag.com  
W: http://tufbag.com  
Produce woven polypropylene FIBC's and small WPP open mouth and valved sacks, including the Adstar® product with block bottom and valves. Our Polypropylene sacks and bags are currently used for the packaging of commodities such as cement, sugar, rice, wheat, maize flour, salt, fertilisers, animal feeds and cotton seeds.

**Turck B.V.**

Ruiterlaan 7  
Zwolle  
8019 BN  
The Netherlands  
Contact: Mr Frank de Jong  
T: + 31 38 4227750  
F: + 31 38 4227451  
E: frank.dejong@turck.com  
W: www.turck.nl  
Turck is a leading manufacturer in industrial automation. With an enormously versatile range of more than 13,000 sensor, fieldbus, interface and connectivity products, Turck offers highly efficient product solutions for factory and process automation.

**Ulrich Brehme GmbH**

Otto-Hahn-Str. 1  
Hattorf am Harz  
37197  
Germany  
Contact: Mr Bodo Altgeld-Wichmann  
Job Title: Marketing Manager  
T: + 49 5584 94210 0  
F: + 49 5584 94210 99  
E: info@brehme-ubo.com  
W: www.brehme-ubo.com  
For more than 50 years Ulrich Brehme GmbH have been manufacturers of bulk materials equipment and components for all industries.

**United DC**

8947 Market Street  
Houston  
TX 77029  
USA  
Contact: Mr Ben Levine  
Job Title: President  
T: + 1 713 671 8200  
F: + 1 713 671 8224

**V D D B (Pty) Ltd**

PO Box 16985  
Lyttelton  
Gauteng  
0140  
South Africa  
Contact: Mr Leonard van der Dussen  
T: + 27 12 664 2300  
F: + 27 12 644 2902  
E: admin@vddb.co.za  
W: www.vddb.co.za  
Engineering and design of optimised air-supported belt conveyors.

**Van Aalst Bulk Handling BV**

  
Engellandlaan 56  
Hazerswoude Dorp  
2391 PN  
The Netherlands  
Contact: Mr Hans van Est  
Job Title: Sales/Marketing Manager  
T: + 31 172 213 341  
F: + 31 172 232 804  
E: hvest@vanaalstbulkhandling.com  
W: www.vanaalstbulkhandling.com  
BULK CEMENT HANDLING: Supply of pneumatic bulk handling equipment, ship loaders, ship unloaders, storage and reclaim installations for cement, fly ash and other dusty abrasive materials. Spare parts delivery, maintenance engineers and operators world wide.

**Van Aalst Marine & Offshore B.V.**

Baanhoekweg 16  
Dordrecht  
3313 LA  
The Netherlands  
Contact: Ing. Wijnand van Aalst  
Job Title: Managing Director  
T: + 31 78 622 1304  
F: + 31 78 622 9490  
E: info@vanaalstbulkhandling.com  
W: www.vanaalstbulkhandling.com  
Specialist in pneumatic bulk handling equipment for loading, unloading, conveying and storing of powders and dusty or abrasive materials such as cement, fly ash, alumina, etc. A service oriented and flexible organisation with offices all over the world.

**Van Beek bv**

PO Box 168  
Drunen  
5150 AD  
The Netherlands  
Contact: Mr Peter Paul Rutten  
T: + 31 416 375 225  
F: + 31 416 378 350  
E: info@van-beek.nl  
W: www.van-beek.nl  
The bulk car loader, Dino®, is used to load a wide range of bulk goods with divergent specific properties - either packaged in loose bags or big bags. It's capacity of 40 - 80 cubic metres per hour makes it possible to load a silo in an hour.

**Van Tongeren Kennemer BV**

Gooland 8  
Beverdijk  
1948 RC  
The Netherlands  
Contact: Mr Bert Korbeeck  
T: + 31 251 229 160  
F: + 31 251 212 382  
E: email@tongerenkennemer.nl  
W: www.tongerenkennemer.nl

**Veenstra Machinefabriek B.V.**

De Holwert 10  
KC Coevorden  
7741  
The Netherlands  
Contact: Mr Paul Kuiper  
T: + 31 524 599 333  
F: + 31 524 599 330  
E: mach@veenstra-coevorden.nl  
W: www.veenstra-coevorden.nl

**VEMEKEP Deutschland GmbH**

Gebrueder Kerkmann Platz 4  
Ahlen  
D-59229  
Germany  
Contact: Mr Karl-Heinz Fiegenbaum  
Job Title: Managing Director  
T: + 49 2382 9689683  
F: + 49 2382 9689685  
E: info@vemekep-deutschland.de  
W: www.vemekep-deutschland.de  
Specialized in: Bulk Materials Handling Plants, Raw Materials Preparation Plants, Machine Building and Steel Construction, Revamping, Repair, Service, Erection, Commissioning. We are the German independent international sales branch of the 1983 established VEMEKEP, Volos/Greece, who are running own large state-of-the-art workshops. www.vemekep.gr.

**VEN SA**

19 Chemin du Blanc Caillou  
Braine-L'Alleud  
B-1420  
Belgium  
Contact: Mr Roderick Norman  
T: + 32 2 384 20 27  
F: + 32 2 385 15 88  
E: ven@skynet.be

**Ventomatic SPA**

Via G. Marconi, 20  
Valbrembo  
24030  
Italy  
Contact: Mrs Nicolette Cattaneo  
Job Title: Marketing Manager  
T: + 39 035 468 311  
F: + 39 035 528 0277 / + 39 35 4608 38  
E: vento@ventomatic.it  
W: www.ventomatic.it

**Ventyx**

193 Turbot Street  
Brisbane  
Queensland  
4000  
Australia  
Contact: Mr Greg Clark  
Job Title: CEO  
T: + 61 7 3303 3333  
F: + 61 7 3303 3232  
E: info@mincom.com  
W: www.ventyx.com

**Verstegen Grippers BV**

  
PO Box 1014  
Nieuwegein  
3430 BA  
The Netherlands  
Contact: Mr Eric Visser  
Job Title: Managing Director

T: + 31 3060 62222  
F: + 31 3060 60657  
E: info@verstegen.net  
W: www.verstegen.net  
Specialists in developing, designing and manufacturing all kinds of grabs. A leading grab manufacturer with extensive experience whose grabs are in operation all over the world. More than 10,000 grabs have been manufactured for all kinds of materials and applications and delivered to 80 countries worldwide.

**Veson Nautical Corporation**

162 Columbus Ave  
Boston  
MA  
02116  
USA  
Contact: Ms Eva Douzinas  
Job Title: Marketing Director  
T: + 1 617 7232727  
F: + 1 617 9770979  
E: eva@veson.com  
W: www.veson.com  
Veson Nautical - a U.S.-based maritime software developer - delivers technologically advanced, easy to use, highly graphical software solutions to maritime commerce organizations throughout the world. These proven solutions allow users to manage and share information efficiently across Chartering, Operations, Trading, and Accounting departments - streamlining workflow, cutting costs, and optimizing profits.

**Vibco Inc**

PO Box 8  
Stilson Rd  
Wyoming  
RI  
02898  
USA  
Contact: Mr Carl Wadensten  
T: + 1 401 539 2392 x130  
F: + 1 401 539 2584  
E: vibrators@vibco.com

**Vibrafloor**

  
Les Pièces Bourgeoises  
Giury  
71640  
France  
Contact: Mr Jean-Claude Poncet  
Job Title: President  
T: + 33 3 85 44 06 78  
F: + 33 3 85 44 06 79  
E: jc.poncet@vibrafloor.com  
W: www.sillexport.com  
VIBRAFLOOR, the modular vibrating floor, is used in various bulk industries, inside silos, ships and railway cars as a versatile reclaiming using powered gravity.







# POWER IN ACTION

Port equipment - Ship Loaders / Unloaders



With **1,200** machines sold in more than **80** countries over **43** years, **VIGAN** is your experienced partner for loading and unloading the most precious commodity on earth. **Grain deserves reliability**







**VIGAN**



Rue de L'Industrie 16  
Nivelles  
B-1400  
Belgium  
Contact: Mr Nicolas Dechamps  
Job Title: Managing Director  
T: + 32 67 89 50 41  
F: + 32 67 89 50 60  
E: info@vigan.com  
W: www.vigan.com  
VIGAN ENGINEERING designs and manufactures bulk materials handling systems for agribulk cargo (mainly cereals), some chemicals, woodpellets... VIGAN expertise covers complete turnkey solutions - from project engineering to commissioning- for port terminals, including ship unloading & loading, storage facilities and bagging operations. Complete information and references on <http://www.vigan.com>

**Vollert Anlagenbau GmbH**

Stadtseestr. 12  
Weinsberg  
74189  
Germany  
Contact: Mr Juergen Schiemer  
Job Title: Vice President  
T: + 49 7134 52 232  
F: + 49 7134 52 222  
E: juergen.schiemer@vollert.de  
W: www.vollert.com  
For over 80 years Vollert is worldwide acting as competent engineers and supplier of shunting equipment. For each shunting problem Vollert provides robust, low-maintenance and individual system solutions capable of being automated and above all at very

reasonable prices. Vollert provides the perfect solution for moving wagons.

**Volvo Construction Equipment SA**

Hunderenveldlaan 10  
Brussels  
B 1082  
Belgium  
Contact: Mr Bill Law  
Job Title: Director of External Communications  
T: + 32 2 482 5021  
F: + 32 2 675 1777  
E: bill.law@volvo.com  
W: www.volvo.com  
Volvo CE develops, manufactures and markets equipment for construction and related industries. Its products include a range of wheel loaders, motor graders, articulated haulers, excavators and compact equipment. Volvo CE is part of the Volvo Group, the world's largest manufacturer of diesel engines in the 9 to 18 litre category.

**Vossloh Kiepe GmbH**



Kiepe-Platz 1  
Düsseldorf  
D-40599  
Germany  
Contact: Mr Manfred Grünwald  
Job Title: Head of Sales Industrial Components  
T: + 49 211 7497 270  
F: + 49 211 7497 420

E: m.gruenwald@kiepe-elektrik.com  
W: www.kiepe-elektrik.com  
VOSSLOH KIEPE is a leading supplier of pull wire switches, belt drift switches and speed monitoring devices for the control of belt conveyors. The trade mark KIEPE is worldwide a synonym for proven products of highest quality.

**VSR Industrietechnik GmbH**

Am Alten Schacht 6  
Duisburg  
D-47198  
Germany  
Contact: Mr Wolfgang Schliabach  
Job Title: Export Manager  
T: + 49 20 66 99 66 40  
F: + 49 20 66 99 66 62  
E: info@vsr-industrietechnik.de  
W: www.vsr-industrietechnik.de  
VSR Blaster products have been proving themselves in the bulk handling business for more than 35 years and are recognised for their extensive expertise, high effectiveness and dependability. The conveyor belt solutions found in the Dustex, Vibrex, Carex and Linex systems improve the conveying quality and are environmentally friendly.

**Webster Griffin Ltd**

Brooklands Park  
Farningham Road  
Crowborough  
East Sussex  
TN6 2JD  
UK  
Contact: Ms Jo Smith  
T: + 44 1892 664250  
F: + 44 1892 664340  
E: info@webstergiffin.com  
W: www.webstergiffin.com  
Webster Griffin are a leading supplier

of modular bagging machinery. We manufacture modular and mobile bagging systems ideal for high speed 'on-the-spot' dock side filling of fertilizer, grain, sand, sugar, rice into small bags and sacks.

**Wieland Lufttechnik GmbH**

Wetterkreuz 12  
Erlangen  
91058  
Germany  
Contact: Mr Gerhard Borrmann  
Job Title: Export Manager  
T: + 49 9131 60 67 0  
F: + 49 9131 60 67 97  
E: info@wieland-luft.de  
W: www.wieland-luft.de  
One of the leading manufacturers of industrial vacuum cleaning and material handling systems. Portable - stationary - truck or trailer mounted vacuum systems.

**Windmüller & Hölscher KG**

Münsterstr. 50  
Lengerich  
D-49525  
Germany  
Contact: Mrs Elisabeth Braumann  
Job Title: Public Relations  
T: + 49 5481 14 2929  
F: + 49 5481 14 3355  
E: elisabeth.braumann@wuh-group.de  
W: www.wuh-group.com/  
Windmüller & Hölscher - one of the leading machine manufacturers in the world for the flexible packaging industry and the global leader in bag making and bagging equipment.

**Wirtech AG**

Zelgstrasse 86  
Uetendorf  
CH-3661  
Switzerland  
Contact: Mr K Buehler  
Job Title: Marketing  
T: + 41 33 346 5050  
F: + 41 33 346 5059  
E: info@wirtech.ch  
W: www.wirtech.ch

**Worley Parsons Canada**

**(Westmar)**  
400-233 West First Street  
North Vancouver  
BC V7M 1B3  
Canada  
Contact: Mr Richard Malinek  
T: + 1 604 985 6488 ext 5218  
F: + 1 604 985 2581  
E: info@westmar.com  
W: www.westmar.com  
Multi-disciplinary consulting firm with design expertise in the maritime, civil, structural, mechanical and environmental fields associated with bulk materials handling, utilising state-of-the-art computer simulation for the planning and optimisation of bulk terminals and transportation systems.

**WorleyParsons**

2645 Skymark Avenue  
Mississauga  
ON  
L4W 4H2  
Canada  
Contact: Mr Jeremy Okolisan  
Job Title: Director, Business Development  
T: + 1 905 614 1778 ext 2871  
F: + 1 905 614 1780  
E: jeremy.okolisan@worleyparsons.com

W: [www.worleyparsons.com](http://www.worleyparsons.com)  
Additional services include: Ports & Marine Terminal Planning, Transportation Studies and Supply Chain Logistics, Marine Structure Design (inshore and offshore), Coastal Processes, Cold Weather (Arctic) Engineering including Ice Management, Site Development and Civil Infrastructure, Terminal Waste Water Treatment & Management, Environmental Assessment and Management, Contaminated Sites and Waste Management, Condition Inspections and Asset Management

### Yernaux-Pasage

Zone Industrielle Beraaugard PB  
552  
Brive Cedex  
19107  
France  
Contact: Mr Willy Banc  
Job Title: Marketing Department  
T: + 33 475 66 4600  
F: + 33 555 860 563  
E: [willy.banc@preciamolen.fr](mailto:willy.banc@preciamolen.fr)

### Yokohama Rubber Co

MB Overseas Sales Dept  
6-1-11 Shimbashi Minato-Ku  
Tokyo  
105-8656  
Japan  
Contact: Mr Funakoshi  
Job Title: Marketing  
T: + 81 3 5400 4816  
F: + 81 3 5400 4830  
E: [yinfo@mta.yrc.co.jp](mailto:yinfo@mta.yrc.co.jp)

### Young Industries Inc

PO Box 30  
16 Painter Street

Muncy  
PA  
17756  
USA  
Contact: Mr William Mahoney  
T: + 1 570 546 3165  
F: + 1 570 546 1888  
E: [mktinfo@younginds.com](mailto:mktinfo@younginds.com)  
W: [www.younginds.com](http://www.younginds.com)  
Manufacturer of dilute and dense phase pneumatic conveying and bulk materials processing systems and equipment.

### Zakkentrale B.V.

3100 AJ Schiedam  
Cairostraat 50  
Rotterdam  
3047 BC  
The Netherlands  
Contact: Mr Harm Peters  
Job Title: Managing Director  
T: + 31 10 462 3511  
F: + 31 10 462 6939  
E: [exim@zakkentrale.nl](mailto:exim@zakkentrale.nl)  
W: [www.zakkentrale.nl](http://www.zakkentrale.nl)  
Trading and production of Flexible packaging materials made out of woven polypropylene or polyethylene film. 25/50 kg bags, FIBC's (big bags), containerliners, handling and storage systems. The company is ISO certified and our production facilities are working according to the highest norms (ISO, HACCP, AIB, certified).



## KIEPE – Keep a good thing going

### Vossloh Kiepe GmbH

P.O.B. 16 02 51  
D-40565 Düsseldorf (Germany)  
Phone +49 (0) 2 11 74 97-2 80  
Fax +49 (0) 2 11 74 97-4 20  
[info@kiepe-elektrik.com](mailto:info@kiepe-elektrik.com)  
[www.kiepe-elektrik.com](http://www.kiepe-elektrik.com)



### Scope of supply

- Pull Rope Switches
- Accessories
- Belt Misalignment Switches
- Speed Monitors



# BULK HANDLING EQUIPMENT COMPANIES — ALPHABETICAL LISTING

**Key:**

- SL = Shiploaders
- CR = Cranes
- GL/U = Grab Loaders/Unloaders
- MCSU = Mechanical CSUs
- PSU = Pneumatic ship unloaders
- BL/U = Barge loaders/unloaders
- GR = Grabs
- MCN = Mechanical conveyors
- PCN = Pneumatic conveyors
- ST/R = Stackers & reclaimers
- MHE = Mobile harbour equipment
- HP = Hoppers
- CR/S = Crushing & Screening
- WGH = Weighing
- SM/I = Sampling & inspection
- DC = Dust control/suppression
- DV/C = Drives & controls
- STG = Storage systems
- RL/T = Rail & truck handling
- SU = Self unloading shipping equipment
- ENG = Engineering consultants
- BAG = Bag handling
- OTH = Other equipment



	SL	CR	GL/U	MCSU	PSU	BL/U	GR	MCN	PCN	ST/R	MHE	HP	CR/S	WGH	SM/I	DC	DV/C	STG	RL/T	SU	ENG	BAG	OTH
A/S Cimbria	✓					✓		✓			✓	✓		✓		✓	✓	✓	✓		✓		✓
4B BRAIME Elevator Components				✓				✓								✓	✓						✓
A. Friedr Flender AG																✓	✓						
AAF Ltd																✓							
ABB Engineering (Shanghai) Ltd.	✓	✓	✓							✓							✓		✓				
ABB Switzerland Ltd																	✓						✓
Abbey Rollers Limited								✓															
A-C Compressor Corporation																							✓
AC Robinson & Associates																						✓	
Achenbach GmbH Metalltechnik								✓	✓														
Advance Automated Systems Ltd																							
AE AntiEmission GmbH																	✓					✓	✓
AE Automation (M) Sdn bhd	✓							✓		✓		✓	✓	✓	✓	✓	✓	✓		✓	✓		✓
Aeromaster International Ltd								✓	✓			✓											✓
AFM Industries	✓									✓													✓
AgGrowth International Inc.																							
Agora Services								✓	✓			✓											
Agrico Sales, Inc.	✓							✓											✓	✓			✓
Agromatic AG														✓	✓	✓	✓						✓
AJ Sackett & Sons Company	✓							✓				✓								✓			
Akerbergs Maskiner AS			✓								✓												
AKJ Industries																	✓						✓
Alcan Alesa Technologies Ltd	✓				✓	✓		✓	✓			✓		✓					✓	✓		✓	✓
Alex Stewart (International) Corporation																							
Alex Stewart Agriculture Ltd														✓	✓								
Alex Stewart International														✓	✓								
Alfredo Brand P.																							
All-Fill International Ltd																							✓
ALS Inspection														✓	✓								✓
AMECO SA	✓			✓	✓			✓		✓													
Anker-Flexco GmbH																							✓
Antar@Pressvess																							
ANUPAM INDUSTRIES LIMITED	✓	✓																	✓				
Anvil Attachments								✓															
Arlona Engineering								✓															
ATIC Services																							
ATIC Services															✓								
Atlas Manufacturing Co. Inc			✓	✓		✓	✓																
AUMUND Foerdertechnik GmbH				✓				✓		✓	✓	✓							✓				
Aurecon																							✓
Aurecon	✓																						
Aurecon Hatch	✓		✓					✓		✓			✓			✓	✓		✓		✓		

# BULK HANDLING EQUIPMENT

	SL	CR	GL/U	MCSU	PSU	BL/U	GR	MEN	PCN	ST/R	MHE	HP	CR/S	WGH	SM/I	DC	DV/C	STG	RL/T	SU	ENG	BAG	OTH	
Ausenco Sandwell	✓		✓	✓	✓	✓		✓		✓		✓	✓	✓	✓	✓	✓	✓	✓	✓	✓		✓	
AusGroup Limited																								
Avery Weigh-Tronix														✓										
Avplast Dis Tic. Ve Paz. Ltd. Sti.																							✓	✓
B & W Mechanical Handling Ltd	✓					✓		✓		✓	✓						✓	✓					✓	✓
B. A. G. Corp.																							✓	
B+W Gesellschaft fur Innovative Produkte GmbH								✓									✓							
Bagfilla SA Pty Ltd																							✓	
Bayards Aluminium Constructions																			✓					✓
Bedeschi SpA	✓					✓		✓		✓		✓	✓			✓		✓						
BEHN + BATES Maschinenfabrik GmbH & Co. KG																							✓	
Bekaert NV								✓	✓															
Belt Equipment Supplies Sdn Bhd								✓	✓				✓							✓				✓
BELTANA Trading EK								✓																
Bemo Rail BV																				✓				
Benetech GmbH										✓							✓							
Benetech, Inc.								✓	✓								✓		✓	✓		✓		
Bergu International AB																							✓	
Beumer Group GmbH & Co KG	✓				✓			✓	✓														✓	
BGS Holland	✓																✓							
Binder + Co AG				✓																				
Birrus International Pty Ltd								✓																
BLUG Credeblug S.L.	✓		✓	✓		✓	✓				✓						✓			✓				✓
BMT De Beer	✓	✓														✓						✓		✓
BMT Transport Solutions GmbH																						✓		
Bogaert Transmission (GEHA)								✓																
Bonfanti srl		✓												✓			✓							
Bosch Rexroth AG																		✓						
Bosch Rexroth B.V.	✓		✓	✓		✓		✓		✓	✓		✓				✓	✓		✓	✓			
Boyne Area Manufacturing (BAM)	✓			✓		✓		✓	✓			✓					✓	✓	✓	✓	✓	✓	✓	✓
Brelko Conveyor Products								✓																✓
Bretby Gammatech Ltd.																								
Bridgestone Industrial Limited	✓							✓																
Bridon International Ltd		✓																						✓
Brock Grain Systems																				✓				
BRUKS Klöckner GmbH																								
BRUKS Rockwood Incorporation	✓							✓					✓						✓					
BSG Resources													✓											
Bucket Mart Inc.	✓	✓	✓	✓	✓	✓	✓				✓													
Bühler AG, Grain Logistics	✓			✓	✓	✓		✓				✓		✓	✓	✓	✓	✓	✓			✓		
Buhler Grain Logistics																								
BULK .ID																								
Bulk Cargo Handling BVBA	✓					✓																		
Bulk Lift International	✓																			✓				✓
Bulk Logistic Landmark																								
BV Beco							✓																	
ByM Agencia Martima																								✓
C. Christophel GmbH													✓											
Cable Arm Inc							✓																	
Cachapuz Bilanciai Group														✓										
Calim Grab Industry	✓		✓			✓						✓												✓
Camat Mill Systems Ltd																						✓		
Cambelt International Corp								✓		✓										✓				
Capotex								✓									✓							
Carbonser, S. A. DE C. V.								✓																
CargoSpotter AS																								
Cargotec Sweden AB, Marine Selfloaders				✓																	✓			
Cargotec Sweden Bulk Handling AB	✓			✓	✓	✓		✓	✓	✓	✓								✓				✓	
Carlsen	✓			✓	✓	✓		✓	✓												✓			
Carmatec AB	✓			✓	✓	✓		✓	✓		✓								✓		✓	✓		
Carsurin																✓								
Caterpillar Belgium																								
Caterpillar Commercial Northern Europe																								✓
Caterpillar Inc			✓			✓	✓																	✓
Caterpillar SARL	✓										✓													✓
Cavotec Deutschland GmbH	✓	✓								✓	✓	✓	✓									✓		✓
Cavotec Inc																		✓						
Cavotec SA											✓													✓
CDM Systems, Inc	✓			✓		✓		✓											✓	✓		✓		
Certex UK																								
Cesur Packaging Corporation								✓																
CFS srl.			✓																					
CH2M Hill																						✓		



	SL	CR	GL/U	MCSU	PSU	BL/U	GR	MCN	PCN	ST/R	MHE	HP	CR/S	WGH	SM/I	DC	DV/C	STG	RL/T	SU	ENG	BAG	OTH
Changsha Kaiyan Instruments Co. Ltd																	✓						
Chief Industries UK Ltd.								✓											✓				✓
China Huadian Engineering Co., Ltd.(CHEC)	✓		✓	✓		✓		✓				✓					✓	✓	✓		✓		✓
China Sonangol International (S) Pte Ltd																					✓		
CHL Equipment Ltd (incorp. Verstegen Grabs UK)							✓																
Christianson Systems Inc.					✓	✓			✓		✓												
Chronos BTH								✓			✓	✓		✓								✓	✓
Chronos BTH B V								✓			✓	✓										✓	✓
Chronos BTH GmbH								✓			✓	✓		✓								✓	✓
CICSA & MCV s.r.l.								✓			✓	✓											✓
Cimbria Bulk Equipment						✓		✓									✓		✓				
Clarke Chapman Manufacturing Ltd																							
Claudius Peters Technologies GmbH			✓	✓	✓	✓			✓														
Claudius Peters Technologies S.A.S			✓	✓	✓	✓		✓	✓	✓													
Cleveland Cascades Ltd	✓					✓											✓						
Clime SA																							✓
Clough Limited	✓																					✓	
CNBM International Engineering Co., Ltd.	✓	✓	✓	✓	✓	✓	✓	✓	✓	✓	✓	✓	✓	✓			✓	✓	✓	✓	✓	✓	✓
CNK INTERNATIONAL LIMITED																							
Coal & Mineral Technologies (SABS)																✓							
COBRA Europe SA								✓															
Coeclerici Logistics S.p.A.																							✓
Cofely Experts BV	✓	✓			✓						✓												
Coles Associates																							
Condepols																							✓
CONDUCTIX (Delachaux)		✓		✓														✓					
Conductix -Wampfler Australia		✓																					
Conductix-Wampfler AG																		✓					✓
Conductix-Wampfler Americas	✓	✓	✓	✓	✓	✓		✓	✓	✓	✓	✓					✓	✓		✓	✓	✓	✓
Conservatek Industries, Inc.																			✓				
Continental Construction (Memphis)																							✓
Continental Conveyor & Equipment Co Inc	✓							✓															
ContiTech																							
Transportbandsysteme GmbH								✓															
Control Systems Technology Pty Ltd															✓								✓
Coperion GmbH					✓			✓	✓										✓	✓		✓	
Cornell & Co Inc																							✓
Cotesi SA																							✓
CPS Projects (Pty) Ltd	✓		✓	✓	✓		✓			✓													
Crippen Manufacturing Company																							✓
CST Covers																							
CST Storage																							✓
CTI Group Inc	✓			✓		✓	✓	✓	✓			✓		✓			✓	✓	✓			✓	✓
CTP Team Srl																		✓					
Cullen Grummitt & Roe																						✓	
Custom Equipment Design, Inc.								✓				✓											✓
Dalian Huarui Heavy Industry Group Co. Ltd	✓	✓			✓					✓													
Dantherm Filtration Ltd																		✓					
David Osborne Engineering Ltd	✓	✓	✓	✓		✓		✓		✓			✓						✓	✓		✓	✓
dbis														✓								✓	✓
DCC Grabs			✓				✓				✓												
DCL, Incorporated	✓					✓											✓			✓	✓		
DCW Group Co			✓	✓	✓					✓	✓												
De Regt Conveyor Systems								✓															
Dearborn MidWest Conveyor Co.	✓					✓				✓	✓	✓	✓	✓	✓	✓	✓	✓	✓	✓	✓	✓	✓
Demag Cranes & Components GmbH		✓									✓												
DeMarco Industrial Vacuum Corporation	✓		✓	✓	✓	✓			✓	✓		✓											
DemcoTECH Engineering								✓		✓													
Dinnissen BV														✓	✓								✓
DMN-WESTINGHOUSE								✓	✓									✓					✓
Dome Corp of North America										✓								✓					
Dome Technology																							✓

	SL	CR	GL/U	MCSU	PSU	BL/U	GR	MEN	PCN	ST/R	MHE	HP	CR/S	WGH	SM/I	DC	DV/C	STG	RL/T	SU	ENG	BAG	OTH	
DOMTEC International LLC																								✓
Don Valley Engineering Co Ltd								✓		✓		✓	✓						✓	✓			✓	✓
Donaldson Filtration (GB) Ltd																	✓							
Donaldson Filtration																	✓							
Deutschland GmbH																	✓							
Doosan Benelux SA						✓				✓	✓													✓
Doppelmayr Transport																								
Technology GmbH								✓																
Dos Santos International, LLC	✓					✓		✓	✓			✓										✓		
Dosco Overseas Engineering Ltd								✓	✓					✓										
Dosetec Exact Oy														✓									✓	
Doubrava Ges GmbH				✓	✓			✓											✓					
Doyle Manufacturing Co																								✓
Draka Automotive GmbH																								✓
DRC Engineering																								✓
Dry Bulk Solutions			✓				✓				✓										✓	✓		✓
DS SM a/s	✓					✓		✓		✓	✓	✓	✓	✓					✓			✓	✓	✓
DSH Systems Ltd.	✓					✓						✓					✓			✓	✓			✓
Dulevo International S.p.A.																								✓
Dunlop Conveyor Belting			✓					✓		✓				✓		✓			✓					✓
Duro Felguera Plantas																								✓
Industriales, S.A.	✓	✓	✓			✓		✓		✓	✓	✓						✓	✓	✓		✓		✓
Dust Control Technology																								✓
Dust Solutions Inc.																								✓
E Buttmer & Co. Ltd			✓					✓	✓		✓	✓						✓		✓				✓
E-Crane World Wide		✓	✓			✓	✓				✓	✓								✓				✓
E-Crane World Wide /																								✓
E-Crane International USA		✓	✓			✓						✓												✓
E-Crane Worldwide-Indusign NV	✓	✓	✓			✓	✓				✓	✓												✓
ECS Eurocargo Services AS														✓	✓									✓
EIFFEL Etablissement SOMDEL	✓	✓		✓		✓		✓		✓		✓						✓	✓				✓	✓
Elecon Engineering Company Ltd	✓	✓						✓		✓		✓	✓	✓				✓	✓	✓			✓	✓
Elecon Singapore PTE Ltd.	✓							✓				✓	✓					✓	✓	✓			✓	✓
Electro-Motive Diesel (EMD) Inc																		✓		✓		✓	✓	✓
Elgin Engineering																								✓
and Construction			✓			✓														✓		✓		✓
Emaq-Verolme Estaleiros SA																								✓
EMDE INDUSTRIE-TECHNIK									✓					✓	✓			✓					✓	✓
EMS-TECH Inc	✓			✓		✓		✓		✓	✓	✓						✓	✓		✓	✓	✓	✓
EMS-TECH Inc.	✓					✓		✓	✓	✓	✓	✓						✓	✓		✓	✓	✓	✓
EMTICI Engineering Co Ltd								✓			✓													✓
Enclosed Bulk Systems BV																								✓
Enco Engineering Inc	✓			✓		✓		✓				✓						✓	✓		✓	✓		✓
Endress + Hauser Inc														✓	✓			✓						✓
Engicon nv	✓			✓				✓		✓		✓									✓	✓		✓
Engineering System Solutions																								✓
Enso-Gutzeit Oy																								✓
Entecon UK Ltd									✓															✓
Enviro Abrasion																								✓
Resistant Engineers Pvt. Ltd									✓															✓
EPMC Europe BV	✓	✓	✓	✓		✓	✓	✓		✓														✓
EQ Trade																								✓
EQUIPO LLC							✓																	✓
Eriez Magnetics Europe Limited																								✓
Esch Engineering																								✓
Service Centre & Handle GmbH									✓					✓	✓									✓
ESI Eurosilco BV									✓															✓
Eurotec Srl							✓				✓													✓
Eurotech Corporation							✓																	✓
Euro-Tramco BV				✓				✓																✓
F E Schulte Strathaus																								✓
GmbH & Co KG								✓																✓
F L Smidth A/S	✓			✓	✓	✓	✓	✓	✓	✓			✓		✓								✓	✓
Failure Control Ltd																								✓
Fairport Engineering																								✓
FAM Canada Inc																								✓
FAM Foerderanlagen Magdeburg	✓		✓	✓		✓		✓		✓		✓	✓	✓				✓	✓			✓	✓	✓
Famak SA	✓		✓			✓		✓		✓		✓	✓	✓				✓	✓			✓	✓	✓
Fantuzzi Reggiane S.p.a	✓		✓			✓		✓		✓		✓	✓	✓				✓	✓			✓	✓	✓
FELD Maschinen-und																								✓
Industriebau GmbH																								✓
FEMADIGIPACK S.r.l		✓																					✓	✓
Fenner Dunlop Conveyor																								✓
Belting Europe								✓																✓
Fenner plc								✓																✓
Figee Crane Services BV	✓	✓	✓			✓	✓											✓				✓		✓
Flexco																								✓
Flexoveyor Conveyor								✓																✓



	SL	CR	GL/U	MCSU	PSU	BL/U	GR	MCN	PCN	ST/R	MHE	HP	CR/S	WGH	SM/I	DC	DV/C	STG	RL/T	SU	ENG	BAG	OTH	
Flomat Bagfilla International Limited								✓	✓	✓	✓	✓		✓			✓						✓	✓
FLSmith GmbH								✓											✓					
FLSmith Inc.	✓			✓	✓	✓			✓										✓		✓			
FLSmith Minerals Pvt. Ltd	✓																							
FLSmith Spokane, Inc.								✓	✓	✓		✓												
FLSmith Wadgassen GmbH	✓		✓	✓		✓		✓		✓			✓						✓				✓	✓
FMC Corporation								✓																
Fortum Power and Heat OY																								✓
FPS Mustang																								✓
Gama Endustri Tesisleri																								
Imalat Ve Montaj AS	✓																							
Gambarotta Gschwendt	✓							✓																
Gantrex Inc.	✓	✓				✓				✓		✓												
Ganz Danubius Trading Co Ltd	✓		✓	✓	✓		✓																	
Garwood Consulting Ltd	✓		✓	✓		✓		✓		✓		✓					✓	✓	✓	✓	✓	✓		
GEC Alstom Engineering Systems																			✓					
General Bridge Engineering Ltd						✓		✓		✓		✓	✓						✓	✓				
General Kinematics Corp.								✓	✓															
Genivar Inc																							✓	
Geométrica de México, S.A. de C.V.																								
Geometrica Inc																	✓							
Geroldinger GmbH & Co KG									✓			✓						✓						
Gertech Handling Systems cc								✓	✓			✓						✓					✓	
GF Material Handling System Srl	✓							✓	✓	✓	✓	✓	✓	✓	✓	✓	✓	✓	✓	✓	✓	✓	✓	✓
GGT Goldenrain Trading SA															✓									
Golden West Industries																	✓							
Golfetto Sangati S.r.l.				✓	✓			✓	✓		✓	✓								✓				
Goodman Conveyor Company								✓																
Goodtech Solutions AS								✓	✓		✓	✓		✓					✓	✓		✓	✓	✓
Goodyear Tyre & Rubber Co								✓	✓															
Gordinne & Co NV/SA															✓									
Gottwald Port Technology GmbH		✓									✓	✓												
Gottwald Port Technology USA	✓	✓																						
Greiferbau-Und Verschleisstechnik GmbH								✓																
GREIF-VELOX																								✓
Greystones Cargo Systems (Pty) Ltd	✓			✓	✓			✓										✓					✓	
Gubre Fabrikalari TAS	✓	✓						✓			✓	✓												
Gulsan A.p.																								
Guttridge Ltd								✓				✓					✓			✓				✓
Guven Grab and Machine Ltd. Co								✓																
H J Wiefferink BV					✓																			
H Noorman BV																								✓
Hagglunds Drives AB																	✓							
Halcrow																							✓	
Halcrow Group Ltd																								
Hans Turck GmbH & Co. KG																								
Hansen Industrial																								
Transmissions NV																								
Hansen Transmissions Ltd																								
Hanson Silo Company																								
Hapman								✓	✓		✓												✓	
Hasel Machinery Inc																								
Hasler International SA												✓		✓										
HAUGEN System AB											✓			✓										✓
HAVER & BOECKER OHG, Machinery Division													✓	✓						✓		✓	✓	✓
Haver & Boecker Wire Weaving Division													✓		✓								✓	
Hebei Xinrong Rubber Products Co., Ltd								✓																
Heinrich Schwacke GmbH & Co KG		✓																						
Henry International																								
Diplomatic Marine																								✓
Hethon Nederland BV									✓			✓		✓	✓									
Heyl & Patterson Inc			✓	✓		✓	✓			✓										✓				
Hitachi Construction Machinery (Europe) NV		✓																						✓
Horizon Conveyor Equipment								✓																
HOSCH-Fördertechnik																								
Recklinghausen GmbH								✓																✓
HPC Hamburg Port Consulting GmbH																								
Huadian Heavy Industries Co., Ltd.																							✓	

# BULK HANDLING EQUIPMENT

	SL	CR	GL/U	MCSU	PSU	BL/U	GR	MEN	PCN	ST/R	MHE	HP	CR/S	WGH	SM/I	DC	DV/C	STG	RL/T	SU	ENG	BAG	OTH	
Hycontrol Limited																								
Hyundai Heavy Industries Co	✓	✓	✓	✓	✓			✓		✓														
IBAU HAMBURG	✓			✓		✓		✓	✓		✓	✓	✓						✓	✓	✓	✓	✓	
IBC International Handling AB												✓					✓		✓			✓	✓	✓
Igus GmbH		✓																✓						
IHI Transport Machinery Co., Ltd. (IUK)	✓	✓	✓	✓	✓	✓	✓	✓	✓	✓	✓	✓	✓	✓	✓	✓	✓	✓	✓	✓	✓	✓	✓	
IMASA																								
Imperial Technologies, Inc.	✓					✓		✓		✓		✓	✓	✓								✓		
Impsa - Industrias Metalurgicas																								
Pescarmana			✓															✓						
Incolab														✓	✓									
Indexator AB																								✓
Industrial Netting (Pty) Ltd																							✓	
Industrias Murtra																							✓	
Inman SA				✓	✓			✓		✓								✓			✓			
Inspectorate America Corporation																✓								
Inspectorate International Ltd																✓								
Interjute BV																								✓
International Bulk Handling Technology BV	✓					✓		✓		✓	✓	✓						✓	✓			✓		
Interstate Equipment Corporation				✓				✓												✓				
Intersystems									✓				✓	✓	✓				✓					✓
Invicta Vibrators								✓					✓	✓	✓				✓					
iSAM AG Gesellschaft fuer angewandte Kybernetik	✓	✓	✓	✓		✓				✓								✓	✓	✓	✓	✓	✓	✓
Isbir Sentetik Dokuma San .A.S.	✓		✓	✓	✓	✓	✓	✓															✓	
Isomonte SA	✓		✓	✓	✓	✓	✓	✓																
Italgru S.r.l		✓										✓												
J & B Grabs b.v.							✓																✓	
J C Steele & Sons Inc					✓														✓					
Jansens & Dieperink BV												✓							✓					
Jem International & Express Scale Parts														✓										
Jenike & Johanson Inc.												✓							✓			✓		
Jim Way Enterprise Co Ltd								✓																
Johannes Hübner Fabrik Elektrischer Maschinen GmbH		✓																✓						
John R Boone Ltd								✓	✓										✓					
Joy Mining Machinery								✓	✓															
JSC Tehnoros																								
Jumbo Shipping		✓																						
KABELSCHLEPP GmbH	✓	✓																						
Kalenborn Kalprotect GmbH & Co. KG								✓				✓												
Kardesler Grab & Machine		✓	✓	✓	✓		✓																	
KCT Grab Industry			✓				✓				✓	✓												
Kinergy Corporation								✓		✓		✓	✓						✓					
King Bag & Manufacturing Co																			✓				✓	
Kingfisher Industrial Ltd					✓				✓			✓									✓			✓
KINSHOFER GmbH							✓																	
KIROW ARDELTA GmbH		✓	✓								✓	✓												✓
Kleemann GmbH								✓					✓											
Kocks Krane International GmbH			✓	✓							✓													
Konecranes (France)	✓																							
Konecranes B.V. - The Netherlands		✓																						
Konecranes Finland Corporation		✓	✓																✓					
Konecranes Finland Corporation		✓	✓																✓					
Konecranes Hafentechnik GmbH			✓																					
Kornylak Corporation				✓	✓																			
KPI-JCI	✓					✓		✓		✓		✓	✓											✓
Kramer & Duyvis BV								✓						✓									✓	
Kranunion		✓	✓	✓		✓					✓													
Kröger Greifertechnik GmbH & Co. KG							✓																	
K-T Bulk																								
Lachenmeier Monsun A/S								✓				✓		✓	✓	✓			✓					✓
Laidig Systems Inc				✓						✓										✓				
Laing O'Rourke	✓				✓			✓	✓															✓
Langston Companies Inc																							✓	
Lanier & Associates																						✓		
Larox Flowsys Oy																								✓
Larsen & Toubro Limited																						✓		
Larsen & Toubro Limited																						✓		
Lassing Dibben Consulting Engineers Ltd																						✓		
LB Officine Meccaniche S.p.A.													✓						✓					



	SL	CR	GL/U	MCSU	PSU	BL/U	GR	MCN	PCN	ST/R	MHE	HP	CR/S	WGH	SM/I	DC	DV/C	STG	RL/T	SU	ENG	BAG	OTH	
LC Packaging																								
Les Consultants LBCD inc.	✓							✓		✓							✓					✓	✓	✓
Libran Engineering and Services																							✓	
Librawerk Maschinenfabrik GmbH														✓									✓	
Liebherr Brasil - Port Equipment Latin America											✓													
Liebherr-Hydraulikbagger GmbH																								
Liebherr-Singapore Pte Ltd		✓																						
Liebherr-Werk Nenzing GmbH		✓								✓	✓													
Listenow GmbH & Co.	✓																							✓
Lochtec ApS								✓	✓				✓		✓			✓					✓	✓
Logmarin Advisors Srl	✓	✓	✓			✓													✓			✓		
LogSys NV																						✓		✓
Loibl Allen-Sherman-Hoff GmbH	✓					✓		✓	✓				✓				✓							
Macawber Engineering, Inc									✓															
MacGREGOR Group AB	✓	✓		✓	✓	✓		✓				✓									✓		✓	
Machiniefabriek Stramproy SA																			✓			✓		
Mack Manufacturing Inc							✓																	
Mactenn Systems Ltd.									✓															
Mahr GmbH Anlagentechnik für Schuttgüter				✓													✓		✓					
Manitowoc Engineering		✓	✓								✓													
Mantsinen Group Ltd Oy	✓	✓					✓				✓									✓		✓	✓	✓
Maquinas Condor SA	✓			✓	✓	✓		✓	✓	✓	✓			✓	✓							✓	✓	✓
Marine Inspection and Logistics															✓									
Marsden Weighing Machine Group Ltd														✓										
Martin Engineering								✓	✓				✓				✓			✓		✓		✓
Martin Engineering c/o GSFA Consulting																								
Martin Engineering GmbH	✓							✓	✓								✓					✓		
Martin Engineering South Africa								✓									✓							✓
Maschinen und Mühlenbau Erhard Muhr GmbH	✓																			✓				
Matador as								✓																
Matcon																			✓					
MATEC massagoed techniek BV	✓			✓		✓		✓	✓		✓	✓	✓					✓			✓	✓	✓	✓
Material Handling Asia								✓																
Mentor Dynamics																								✓
Merius OY																						✓		✓
Merrick Industries														✓										
METSO	✓	✓	✓	✓		✓	✓	✓		✓			✓							✓		✓		
Metso Minerals (UK) Ltd	✓	✓	✓		✓	✓	✓	✓	✓	✓		✓	✓					✓	✓	✓				
MH Automation International Ltd		✓																						
Midwest Industrial Supply Inc																	✓							
Midwest International Standard Products, Inc.	✓					✓											✓			✓				
Mitchell Consulting Group, Inc	✓		✓	✓		✓															✓	✓		
Mitsubishi Heavy Industries	✓		✓	✓	✓			✓		✓	✓													
Mitsubishi Nagasaki Machinery								✓																
Mitsui Engineering & Shipbuilding Co			✓	✓	✓						✓										✓			
Mitsui Miike Machinery Co., Ltd.	✓				✓					✓	✓										✓			
Mitsui Zosen Europe Limited																								
Mogensen Sizers								✓																✓
Mole•Master Services Corporation™												✓												✓
Möllers Maschinenfabrik GmbH								✓	✓					✓				✓	✓	✓		✓	✓	✓
Motherwell Automation																	✓							
Motridal SpA								✓		✓									✓					
MRS Greifer GmbH			✓				✓																	
Mühlen Sohn GmbH & Co. KG					✓	✓			✓										✓	✓	✓			
Muller Beltex BV								✓									✓							
MUT - Maschinen-Umwelttechnik Transportanlagen								✓		✓														
National Bulk Equipment Inc																								
NAVCO (National Air Vibrator Co)																								
Nectar Group Ltd							✓		✓		✓	✓		✓								✓	✓	
Negrini Srl							✓																	
Nemag BV		✓	✓				✓				✓													✓
NERAK GmbH Fördertechnik								✓	✓					✓					✓	✓		✓	✓	✓
Neuero Corporation	✓		✓	✓	✓	✓		✓	✓	✓	✓										✓		✓	
Neuero Industrietechnik GmbH	✓			✓	✓			✓	✓	✓	✓													
Niifisk-CFM SpA									✓															✓
NILOS GmbH & Co KG								✓					✓									✓		✓
NKM Noell Special Cranes GmbH	✓	✓	✓			✓					✓	✓		✓			✓	✓				✓	✓	✓
NM Heilig BV								✓		✓	✓	✓	✓											
Noell Crane Systems (China) Ltd		✓																						

	SL	CR	GL/U	MCSU	PSU	BL/U	GR	MEN	PCN	ST/R	MHE	HP	CR/S	WGH	SM/I	DC	DV/C	STG	RL/T	SU	ENG	BAG	OTH	
Nordströms Konstruktionsbyrå	✓				✓												✓						✓	
Nordstrong Equipment Ltd	✓							✓		✓	✓									✓				
North American Crushing & Screening, LLC													✓											
Northern Conveyors								✓																
O B Wiik																			✓					
Oceanport Shiploaders Ltd	✓							✓																
OdT S.r.l.								✓																
OMIC Perth															✓									
Onestone Consulting Group GmbH																								
Orthos Projects Ltd.			✓					✓			✓	✓	✓	✓		✓	✓					✓		
ORTS GmbH Maschinenfabrik							✓															✓		
PAGE MACRAE ENGINEERING			✓				✓				✓	✓					✓						✓	
PAM Poul Andersen																								
Maskinfabrik A/S					✓				✓		✓													
Parker Plant Ltd	✓							✓	✓				✓				✓							
Paul Hedfeld GmbH								✓																
Pavan Group	✓			✓	✓													✓						
PEBCO®	✓					✓		✓			✓						✓			✓				✓
PEMA Verpackung																							✓	
Peterson Agricare & Bulk Logistics BV																✓								
Pfister Waagen Bilanciai GmbH														✓										
PHB Weserhütte, S.A.	✓	✓	✓			✓	✓	✓		✓	✓	✓	✓	✓	✓	✓	✓	✓	✓			✓	✓	
Phelps Industries																							✓	✓
Phenix Rousies Industries																	✓		✓					
PHOENIX Conveyor																								
Belt Systems GmbH								✓																
PINTSCH BUBENZER GmbH		✓	✓	✓	✓			✓		✓			✓							✓				
Pirs SA																				✓				
PIV Drives GmbH - a																								
Brevini Power Transmission Co.																		✓						
Plantragg Developments																								✓
Plastruct Canada Inc.												✓												✓
PLM Cranes B.V.		✓	✓			✓	✓														✓			
Polymer Industries - Ultrapoly Division																								✓
Portasilo Ltd																								✓
Port-Trade ApS	✓	✓					✓			✓	✓										✓			
Powerscreen International																								
Powertex Inc																								✓
Precia-Molen BV												✓		✓									✓	
Precia-Molen UK Ltd														✓										✓
Primasonics International Limited												✓								✓				✓
Procon Engineering Limited														✓										✓
PSTek LLC																	✓							✓
PT Bajra Mandalasakti																							✓	
PT Bukaka Teknik Utama		✓																						
PT Jakarta Prima Cranes	✓	✓				✓		✓		✓		✓	✓	✓	✓	✓	✓					✓		
PT Pampersada Nusantara						✓		✓		✓		✓	✓	✓	✓	✓				✓			✓	
PT Thiess Contractors Indonesia																								✓
PT United Tractors																								✓
PT. Bando Indonesia								✓																
Quadrant Engineering																								
Plastics Products												✓								✓	✓			✓
Quadrant PHS				✓																				
Quality Handling Systems Pty Ltd																✓								
R & S S.r.L.	✓		✓	✓	✓	✓		✓	✓	✓	✓			✓	✓	✓	✓	✓	✓	✓	✓	✓	✓	✓
RAP Conveyors Ltd								✓																
RBL-REI France						✓				✓	✓	✓								✓	✓			
RC Inspection B.V																								
RDS Technology Ltd														✓		✓								
REMA TIP TOP GmbH								✓	✓				✓											
Renby Ltd								✓																
Rexnord Industries Inc								✓		✓														
Richmond Engineering Works																								
Risun Technologies	✓			✓		✓		✓		✓		✓						✓	✓			✓		✓
River Consulting																								
RJS Siloclean International Ltd																								
RKR Verdichtertechnik GmbH																								
Roberts & Schaefer Company	✓	✓	✓	✓		✓	✓	✓		✓	✓	✓	✓	✓	✓	✓	✓	✓	✓	✓	✓	✓	✓	✓
Robson Handling Technology														✓						✓				
RockTree Logistics Pte. Ltd.																							✓	✓
Ronin GMS																✓								✓
Royal Haskoning	✓	✓	✓	✓	✓	✓	✓	✓	✓	✓	✓	✓	✓	✓	✓	✓	✓	✓	✓	✓	✓	✓	✓	✓
RTA ALESA Ltd.	✓			✓	✓				✓															
Rubb Buildings Ltd																								



# RTA Alesa

## The market's choice



Sustaining efficiency with RTA Alesa reliable and environmental friendly transport systems to handle your dry bulk cargo.

RTA Alesa, your materials handling partner.  
[www.rta-alesa.com](http://www.rta-alesa.com)

### Switzerland

T +41 (0) 44 435 33 33  
F +41 (0) 44 435 33 66

### France

T +33 (4) 42 65 21 48  
F +33 (4) 42 51 48 33

### Canada

T +1 (514) 937 91 05  
F +1 (514) 937 04 73

### Australia

T +61 (3) 97 69 26 46  
F +61 (3) 97 69 25 35

# Rio Tinto Alcan

	SL	CR	GL/U	MCSU	PSU	BL/U	GR	MEN	PCN	ST/R	MHE	HP	CR/S	WGH	SM/I	DC	DV/C	STG	RL/T	SU	ENG	BAG	OTH	
Rud Kettenfabrik								✓															✓	
RULMECA HOLDING S.P.A.																								✓
SABS - Mining & Minerals															✓									
Saiag Industria SpA																								
Salzgitter Maschinenbau																								
AG/PEINER Grabs							✓																	
Sammi	✓					✓		✓		✓	✓	✓	✓	✓	✓	✓	✓	✓				✓	✓	✓
Sampling Associates International															✓									
Sandvik Mining	✓		✓					✓		✓		✓	✓	✓					✓			✓		
Sandvik Mining and Construction	✓					✓		✓		✓		✓	✓				✓		✓					✓
Sandvik Mining and Construction (China) Co., Ltd.																								
SANWA COMMERCIAL CO., LTD.							✓																	
Sartorius Mechatronics T&H GmbH														✓										
SCAFCO Corporation																								✓
Scantech International															✓									
Schade Lagertechnik GmbH								✓		✓									✓	✓				
Schenck Process Africa (Pty) Limited														✓	✓									
Schenck Process GmbH		✓									✓		✓	✓	✓		✓							
Schenck Process UK Limited								✓	✓				✓	✓			✓		✓				✓	
Schenck Process UK Ltd T/A Redler	✓							✓		✓	✓	✓		✓					✓			✓	✓	✓
Schouten Commodities BV																								✓
Scorpio Engineering Pvt. Ltd	✓				✓	✓		✓	✓	✓	✓	✓		✓			✓	✓	✓	✓		✓	✓	✓
Sea Spec International															✓									
Sea Transport Corporation																								✓
Seabulk Systems Inc	✓			✓	✓			✓		✓												✓	✓	✓
S-E-G Instrument AB														✓										
Selpeco Resources Inc.	✓			✓	✓	✓		✓	✓	✓	✓	✓					✓	✓				✓	✓	✓
Sempertrans France																								
Belting Technology SAS								✓																
SENNEBOGEN Maschinenfabrik GmbH	✓		✓			✓	✓				✓													✓
Sensor Technology Ltd															✓			✓						
Sentry Equipment Corporation															✓									
Servo Berkel Prior														✓										
SEW-EURODRIVE GmbH & Co KG																		✓						
SGH Equipment Limited								✓							✓									✓
SGS															✓									
SGS (Nederland) BV															✓									
SGS Australia Pty Ltd															✓									
SGS Austria Control-Co GmbH															✓									
SGS Minerals Services															✓									
SGS Minerals Services														✓	✓		✓						✓	
Shanghai Qifan Co., Ltd.	✓						✓											✓						
Shanghai Yo-Pi Port Machinery Co. LTD		✓					✓				✓													
Shanghai Zhenhua Port Machinery Co (ZPMC) Ltd	✓		✓	✓																✓	✓			
Shanthi International							✓																	
Shaw Almex Canada								✓																
Shering Weighing Ltd														✓										
SIBRE (Siegerland Bremsen)																			✓					✓
SIDERAR / TERNIUM																								
Siebtechnik GmbH													✓		✓									
Siemens AG	✓	✓	✓			✓				✓								✓	✓	✓		✓	✓	✓
Siemens AG																			✓	✓				
Siemens Nederland NV																			✓	✓				
SIG Società Italiana Gomma Spa								✓																
Silvan Dis Ve IC Ticaret AS																								✓
Sime Industrie																								✓
Simplicity Projects Pvt Ltd					✓																			
SMB International GmbH	✓			✓		✓		✓		✓									✓			✓		
Smiley Monroe Ltd								✓					✓				✓						✓	
SMM-UM Sociedade de Montagens Metalomecnicas SA	✓	✓	✓	✓		✓	✓				✓	✓					✓		✓					✓
Sobemai by IRI nv	✓		✓																					
Societe de Tolerie Industrielle Francaise								✓									✓							
Solimar Pneumatics																								
Solitec Engineering Ltd								✓				✓								✓				
Sotecma Inc Process Engineers																				✓			✓	
Specialised Handling & Eng (Pty) Ltd	✓							✓		✓	✓									✓	✓		✓	✓
Specimas																								✓



	SL	CR	GL/U	MCSU	PSU	BL/U	GR	MCN	PCN	ST/R	MHE	HP	CR/S	WGH	SM/I	DC	DV/C	STG	RL/T	SU	ENG	BAG	OTH	
Spiroflow Ltd								✓	✓														✓	
STAG AG								✓	✓											✓		✓		
Standard Industrie (Airchoc)							✓					✓				✓		✓	✓					✓
Starlinger & Co. GmbH																							✓	
Stas BV																	✓							
Stevenel OY			✓			✓	✓																✓	✓
Stewart Inspection and Analysis (Pty) Ltd															✓									
Stock Equipment Company																		✓						
Stockpile Surveying and Protection BVBA																								
Stokman BV								✓				✓			✓						✓			
Stora Enso																								✓
Strudes Inc																						✓		
Sub Con Ltd																								
Sucofindo																								
Sumitomo Heavy Industries Eng. & Services Co Ltd	✓	✓	✓	✓		✓		✓		✓	✓								✓					
Suomen Viijava Oy																				✓				
Supercargo, Lda															✓									
Superior Industries	✓					✓		✓		✓	✓	✓		✓					✓	✓		✓		✓
Svendborg Brakes A/S	✓							✓	✓	✓							✓							✓
Swire CTM Bulk Logistics	✓	✓	✓			✓	✓	✓		✓	✓	✓									✓			
T D Micronic Inc														✓	✓									✓
TAIM WESER, S.A.	✓	✓	✓			✓		✓		✓														
TAKRAF GmbH	✓					✓							✓											
TAKRAF India Pvt. Ltd.	✓		✓	✓		✓		✓		✓	✓	✓	✓											
TAURUS EMERGÉ																								
TBMA Europe BV									✓					✓	✓							✓	✓	✓
Tebodin Consultants & Engineers	✓				✓	✓	✓	✓				✓	✓	✓	✓	✓	✓	✓	✓	✓	✓	✓	✓	✓
techNaero aps									✓								✓							
Telestack Limited	✓		✓			✓		✓			✓	✓							✓	✓				
Tema BV													✓		✓									
TEMA Systems Inc.													✓		✓									
TENOVA S.p.A - Tenova																								
Takraf Italy	✓		✓	✓		✓		✓		✓		✓							✓	✓		✓	✓	✓
Tenova Takraf								✓	✓	✓			✓				✓		✓	✓		✓	✓	✓
Terex Cranes o/o Terex																								
Demag GmbH		✓									✓													
Terex Fuchs GmbH			✓				✓													✓				
Teta Mühendislik A. .				✓	✓			✓						✓					✓					
Thames Side Sensors Ltd												✓		✓									✓	
The ACT Group								✓	✓	✓		✓	✓				✓	✓		✓		✓		
The BRUKS Group																								
The China Navigation Co. Pte. Ltd				✓		✓																		
The Grab Specialist b.v.							✓																	
The Raring Corporation																	✓							
Thermo Fisher Scientific								✓	✓					✓	✓		✓							✓
Thiele GmbH & Co KG				✓				✓																✓
ThyssenKrupp Canada	✓							✓		✓			✓									✓		✓
ThyssenKrupp																								
Fördertechnik GmbH	✓		✓	✓		✓		✓		✓		✓					✓		✓	✓	✓	✓	✓	✓
ThyssenKrupp Materials Handling	✓	✓	✓	✓		✓		✓		✓	✓	✓	✓	✓	✓				✓	✓				✓
ThyssenKrupp Robins, Inc.	✓							✓		✓		✓	✓									✓		✓
Tideworks Technology - Europe																		✓						
Timars Svets & Smide AB														✓	✓	✓							✓	
TMEIC																		✓						
TMSA Tecnologia em Movimentação S/A	✓	✓	✓	✓	✓	✓	✓	✓	✓	✓	✓	✓	✓	✓	✓	✓	✓			✓				✓
Tobu Jukogyo Co								✓																
Top Lift Int																								
Tramco Europe Limited								✓																
Tramco, Inc						✓		✓																✓
Transas Marine																								✓
Trans-Global Solutions, Inc.								✓																
Translift Port Equipment Services Inc					✓																			
Transystems Corporation																								✓
TRF Limited (TaTa)				✓	✓			✓		✓														
Triodetic																	✓					✓		✓
Triple Point Technology																								✓
TS Systems BV								✓	✓			✓	✓	✓					✓	✓			✓	✓
ts-systemfilter gmbh																	✓							
Tsubakimoto Bulk Systems Corporation								✓																
Tsuji Heavy Industries (Jiangsu) Co Ltd			✓					✓			✓										✓			
TTS Group ASA	✓	✓					✓	✓			✓				✓						✓	✓		✓

# BULK HANDLING EQUIPMENT

	SL	CR	GL/U	MCSU	PSU	BL/U	GR	MCN	PCN	ST/R	MHE	HP	CR/S	WGH	SM/I	DC	DV/C	STG	RL/T	SU	ENG	BAG	OTH	
TTS HuaHai Ships Equipment																							✓	
TTX Corporation																				✓				
Tufbag																								✓
Turck B.V.															✓		✓							✓
Ulrich Brehme GmbH	✓							✓	✓							✓		✓						
United DC																							✓	
V D D B (Pty) Ltd																								
Van Aalst Bulk Handling BV	✓				✓	✓			✓		✓	✓					✓		✓	✓	✓			
Van Aalst Marine & Offshore B.V.				✓															✓	✓				
Van Beek bv																							✓	
Van Tongeren Kennemer BV								✓																
Veenstra Machinefabriek B.V.	✓																✓							
VEMEKEP Deutschland GmbH	✓							✓		✓		✓	✓					✓						
VEN SA																							✓	
Ventomatic SPA																							✓	
Ventyx																								✓
Verstegen Grijpers BV							✓																	✓
Yeson Nautical Corporation																								✓
Vibco Inc								✓																✓
Vibrafloor				✓		✓				✓										✓				
Vigan	✓			✓	✓	✓		✓	✓		✓	✓		✓				✓		✓				
Vollert Anlagenbau GmbH																				✓				✓
Volvo Construction Equipment SA																								✓
Vossloh Kiepe GmbH																								✓
VSR Industrietechnik GmbH																			✓					✓
Webster Griffin Ltd								✓															✓	
Wieland Lufttechnik GmbH									✓										✓					✓
Windmüller & Hölscher KG																							✓	
Wirtech AG								✓																
Worley Parsons Canada (Westmar)																								
WorleyParsons	✓	✓	✓	✓	✓	✓	✓	✓	✓	✓	✓	✓	✓				✓	✓	✓	✓	✓	✓	✓	✓
Yernaux-Passage														✓										
Yokohama Rubber Co								✓																
Young Industries Inc									✓															
Zakkencentrale B.V.																			✓					





## INLAND TRANSPORT

### BARGE COMPANIES

#### BELGIUM

##### Bulk Cargo Handling BVBA

Nijverheidskaai 28  
Bus 9  
Brussels  
1080  
Belgium  
Contact: Mr Nicola Samyn  
T: + 32 477 44 98 81  
E: bch.belgium@gmail.com

#### CANADA

##### Dismar

2615, Notre-Dame Centre  
C.P. 35  
Trois-Rivières  
Quebec  
G9A 5E3  
Canada  
Contact: Mr Eric Verville  
T: + 1 819 374 6203  
F: + 1 819 372 9276  
E: e.verville@eletr.qc.ca  
W: www.dismar.qc.ca

##### Group Prommel

3450 Boul. Gene-H-Kruger  
C.P. 294  
Trois-Rivières  
Quebec  
G9A5G1  
Canada  
Contact: Mr Eric Boifvert  
T: + 1 819 379 3311  
E: lkonrad@grpml.com  
W: www.grpml.com

##### Groupe Desgagnes Inc.

21, Rue du Marche-Champlain  
Quebec  
Quebec  
G1K 8Z8  
Canada  
Contact: Ms Suzanne Lafleche  
T: + 1 418 692 1000  
F: + 1 418 692 6044  
E: suzanne.lafleche@desgagnes.com  
W: www.desgagnes.com

##### McKeil Marine Limited

208 Hillyard Street  
Hamilton  
Ontario  
L8L 6B6  
Canada  
Contact: Mr Tom Paterson  
T: + 1 905 528 4141 ext 298  
F: + 1 905 528 6144  
E: tpaterson@mckeil.com  
W: www.mckeil.com  
Barges up to 11,000 mts available for transshipment within the US/Canada East Coast and St. Lawrence River, Arctic and Gulf of Mexico.

##### Seabulk Systems Inc

Suite 150  
10271 Shellbridge Way  
Richmond  
British Columbia  
V6X 2W8  
Canada



Contact: Mr Sidney Sridhar  
T: + 1 604 273 1378  
F: + 1 604 273 1358  
E: sbs@seabulk.com  
W: www.seabulk.com

Seabulk Systems Inc. is involved with 'Design and Build' projects in the marine bulk transportation industry. Ports, self-unloaders, transshippers developed by Seabulk have improved bulk transportation logistics significantly.

#### EGYPT

##### Egyptian International Shipping Co

PO Box 110  
Orman  
Giza  
Egypt  
Contact: Mr Mohamad Hashish  
T: + 20 2 37481565  
F: + 20 2 37481116  
E: mhashish@eisgroup.com.eg

#### FINLAND

##### ESL Shipping

Lintulahdenkuja 10  
Helsinki  
FIN-00580  
Finland  
Contact: Mr Tom Blomberg  
T: + 358 9 5211  
F: + 358 9 9 521 9999  
E: tom.blomberg@eslshipping.com  
W: www.eslshipping.fi

#### GERMANY

##### HTAG Häfen und Transport AG

Neumarkt 7-11  
Duisburg  
47119  
Germany  
Contact: Mr Joachim Holstein  
T: + 49 203 47989 128  
F: + 49 203 47989 191  
E: joachim.holstein@htag-duisburg.de  
W: www.htag-duisburg.de  
Shipping / Chartering, Ports / Cargo Handling, Contract Logistics, Forwarding, Bunkering, Ocean Shipping Agency. Branches in Rotterdam (NL), Thionville (F), Berlin, Emden, Ginsheim-Gustavsburg, Mannheim, Karlsruhe.

##### Oldendorff Carriers GmbH & Co.

KG  
Willy-Brandt-Allee 6  
Lubeck  
Schleswig Holstein  
D-23554  
Germany  
Contact: Mr Henning Oldendorff  
T: + 49 451 15000  
F: + 49 451 73522  
E: henning@oldendorff.com  
W: www.oldendorff.com

#### INDIA

##### J.M. Baxi & Co

Sapt Building  
2nd Floor  
18 J.N. Heredia Marg  
Ballard Estate  
Mumbai  
400 001  
India  
Contact: Mr John C. Alexander  
T: + 91 22 2270 3779 / 82  
F: + 91 22 2210 3629  
E: jca@jmbaxi.com  
W: www.jmbaxi.com

##### United Shippers Ltd

2nd Floor United India Building  
Sir P M Road  
Fort  
Mumbai  
400 001  
India  
Contact: Mr sajeey gwe  
T: + 91 22 6665 8300 67568400  
F: + 91 22 6665 391  
E: inquiry@unitedshippers.com  
W: www.unitedshippers.com

#### ITALY

##### Vitelli srl

Via del Campone 72/74  
Porto Santo Stefano  
Italy  
Contact: Mr Sergio Vitelli  
T: + 39 0564 814436  
F: + 39 0564 816676  
E: commerciale@vitellisrl.it  
W: www.vitellisrl.it

#### POLAND

##### Gtowna Siedziba SMT w Sopocie

ul. Parkowa 46  
Sopot  
81-727  
Poland  
Contact: Mr Ryszard Dalek  
T: + 48 58 520 72 72  
F: + 48 58 520 72 73  
E: d.stefaniak@smtshipping.com  
W: www.smtgdynia.pl

#### THE

#### NETHERLANDS

##### DAP Barging BV

Wilhelmskade 15 a  
Rotterdam  
3016 DK  
The Netherlands  
Contact: Mr Dirk A van der Plas  
T: + 31 10 282 7788  
F: + 31 10 282 7655  
E: dirk@dap-barging.nl  
W: www.dap-barging.nl

##### Eurobulk Transport

Amstelwijckweg 15  
Dordrecht  
3316 BB  
The Netherlands  
Contact: Mr Zeeg Brasser  
T: + 31 786552400  
E: info@eurobulk.nl  
W: www.eurobulk.nl

## Euro-Rijn International BV

Plaza 6  
Moerdijk  
4782 SK  
The Netherlands  
Contact: Mr van Tooren  
T: + 31168393220  
F: + 31168393260  
E: d.kuijpers@eurorijn.com

## Interrijn BV

Kantoorgebouw Westgate  
Scheepmakerij 130  
Zwijndrecht  
3331 MA  
The Netherlands  
Contact: Ms Ellen Straver  
T: + 31 078 625 9399  
F: + 31 078 619 0775  
E: interrijn@interrijn.com  
W: www.interrijn.nl/

## LBH Marketing Services BV

Rijsdijk 13  
Rhooen  
3161 HK  
The Netherlands  
Contact: Mr Anton Wintermans  
T: + 31 10 506 5000  
F: + 31 10 506 5035  
E: anton@lbhnetherlands.com  
W: www.lbh-group.com

## UK

### Ashmead Maritime

The Old Bams  
The Ham  
Coaley  
GL11 5AS  
UK  
Contact: Mr Peter Ashmead  
T: + 44 1453 860044  
F: + 44 1453 860045

E: ashmead@aship.co.uk  
W: www.aship.co.uk

### J P Knight Group

The Admiral's Offices  
Chatham Historic Dockyard  
Chatham  
Kent  
ME4 4TZ  
UK  
Contact: Mr Richard Knight  
T: + 44 1634 826633  
F: + 44 1634 829093  
E: navigators@jpknight.com  
W: www.jpknight.com  
Berthing a 100,000 tonne tanker in Scotland's Cromarty Firth, salvaging a chemical carrier in mid-Atlantic or pushing thousands of tonnes of ore down a South American river, JP Knight has the specialist knowledge, experience and capability to meet the needs of tomorrow.

## USA

### AEP River Operations

16150 Main Circle Drive  
Suite 400  
Chesterfield  
MO 63017  
USA  
Contact: Mr Mark Stoppel  
T: +1 636 530 2121  
F: +1 636 530 4121  
E: mastoppel@aepriverops.com  
W: www.aepriverops.com  
AEP River Operations offers unparalleled barge transportation service. AEP River Operations, the second-largest barge company, offers an updated fleet with new boats and barges and best-in-class operations. We shipped 68MM tons

of dry commodities along the inland waterways in 2008.

### American Commercial Barge Line

PO Box 610  
Jeffersonville  
IN 47131-0610  
USA  
Contact: Mr David D. Jahnke  
T: + 1 812 2880169  
E: david.jahnke@acbl.net

### ARTCO

4666 Faries Parkway  
Decatur  
IL  
62526  
USA  
Contact: Mr Kevin Van Meter  
T: + 1 217 424 5556  
F: + 1 217 451 4122  
E: kevin.vanmeter@adm.com  
W: www.admworld.com

### Canal Barge Company, Inc

835 Union Street  
New Orleans  
LA 70112-1469  
USA  
Contact: Mr Larry Barbish  
T: + 1 504 584 1535  
F: + 1 504 584 1505  
E: lbarbish@canalbarge.com  
W: www.canalbarge.com

### Cooper/T. Smith Stevedoring

One Canal Place  
365 Canal Street  
Suite 1450  
New Orleans  
LA  
70130  
USA

Contact: Mr Eric Hansen  
T: + 1 504 569 2160  
F: + 1 504 569 2188  
E: eric.hansen@coopertsmith.com  
W: www.coopertsmith.com  
Cooper/Consolidated does midstream transfers of all types of bulk cargoes and Breakbulk cargoes as well. Anchorages, buoy systems, and barge fleetings are located at 2 locations, Mile 134 and 171, Lower MS River.

### Forest Lines Inc

1700 Poydras Centre  
650 Poydras Street  
New Orleans  
LA 70153-3425  
USA  
Contact: Mr Joseph E Zehner  
T: + 1 504 529 1300  
F: + 1 504 593 6401  
W: www.forest-lines.com

### Ingram Barge Co

4400 Harding Road  
Nashville  
TN  
37205-229  
USA  
Contact: Mr Daniel T. Martin  
T: + 1 615 298 8373  
F: + 1 615 695 3373  
E: dan.martin@ingrambarge.com  
W: www.ingrambarge.com

### LoneStar Transportation Inc

3934 Sandshell Drive  
Fort Worth  
Texas  
76137  
USA  
Contact: Mr David Ferebee  
T: + 1 817 306 1000  
F: + 1 817 230 0240

E: david.ferebee@stinc.com

### MBLX Inc

One Canal Place  
Suite 2100  
New Orleans  
LA 70130  
USA  
Contact: Mr David P Schulingkamp  
T: + 1 504 581 2033  
F: + 1 504 581 2035  
E: david.schulingkamp@mblx.com  
W: http://mblxresources.com/

### McDonough Marine Service

1750 Clearview Parkway  
Metairie  
LA 70001-2470  
USA  
Contact: Mr Pat Stant  
T: + 1 504 780 8100  
F: + 1 504 780 8200  
E: pstant@marmac.net

### National Waterways Conference, Inc.

1100 North Glebe Road  
Suite 1010  
Arlington  
VA  
22201  
USA  
Contact: Ms Carole Wright  
T: + 1 703 224 8007  
F: + 1 866 371 1390  
E: carole@waterways.org  
W: www.waterways.org  
Promotes a better understanding of the public value of the American waterways system and to document the importance of far-sighted navigation and water resources policies to a sound economy, industrial and agricultural productivity, regional development, environmental quality, energy conservation, international trade, defense preparedness and the overall national interest.

### Pere Marquette Shipping Company

701 Maritime Drive  
PO Box 708  
Ludington  
MI  
49431  
USA  
Contact: Mr Chuck Leonard  
T: + 1 231 845 7846  
F: + 1 231 843 4558  
E: cleonard@pmship.com  
W: www.pmship.com

### Riverway Co.

8400 Normandale Lake Boulevard  
Suite 920  
Bloomington  
MN 55437  
USA  
Contact: Mr Terry R Becker  
T: + 1 952-921-3994  
E: tbecker@riverway.com  
W: www.riverway.com

### Saint Lawrence Seaway Development Corporation

U.S Department of Transportation  
1200 New Jersey Avenue SE  
Washington  
DC  
20590  
USA  
Contact: Ms Rebecca Spruill  
T: + 1 202 366 0091  
F: + 1 202 366 7147  
E: rebecca.spruill@dot.gov  
W: www.greatlakes-seaway.com





## INLAND TRANSPORT

### RAIL COMPANIES

#### AUSTRALIA

##### Asciano Limited

Level 6  
15 Blue Street  
North Sydney  
NSW 2060  
Australia  
T: + 61 2 8484 8000  
F: + 61 2 8484 8154  
E: info@asciano.com.au  
W: www.asciano.com.au

##### Trans Coal Pty Ltd

Level 11, 225 Wickham Terrace  
Brisbane  
QLD  
4000  
Australia  
Contact: Ms Faith Dempsey  
T: +61 7 3831 8431  
F: +61 7 3831 8432  
E: fdempsey@transcoal.com.au  
W: www.transcoal.com.au

#### CANADA

##### Canadian National Railway

Public Affairs & Advtg Dept.  
2nd Floor 935  
LA Gauchetiere West  
Montreal  
Canada  
Contact: Ms Chantale Despres  
T: + 1 514 399 8753  
F: + 1 514 399 5344  
E: chantale.despres@cn.ca

##### CN Railway

205 5th Avenue SW  
Suite 3070  
Calgary  
AB T2P 2V7  
Canada  
Contact: Gurpreet (GK) Khaira  
T: + 1 403 299 0665  
F: + 1 403 299 0650  
E: Gurpreet.khaira@cn.ca  
W: www.cn.ca

##### Genivar Inc

1166 Laure Blvd  
Sept-Îles  
Quebec G4S 1C4  
Canada  
Contact: Mr Denis Blouin  
T: + 1 418 962 2241  
F: + 1 418 962 3641  
E: info@genivar.com  
W: www.genivar.com

#### GERMANY

##### Deutsche Bahn Gruppe

DB Cargo AG  
Königsstrasse 67-69  
Duisburg  
D-47051  
Germany  
Contact: Mr Hendrek Fiege  
T: + 49 6131 159  
F: + 49 6131 1565975  
E: info@dbschenker.eu  
W: www.dbschenker.de/



##### Geodis Wilson

Hammerbrookstrasse 89  
7th Floor  
Hamburg  
20097  
Germany  
Contact: Mr Michael Zuchold  
T: + 49 40 30120  
F: + 49 40 301245  
E: info@hq.geodiswilson.com  
W: www.geodiswilson.com

##### INFORM GmbH

Pascalstr. 23  
Aachen  
52076  
Germany  
Contact: Mr Udo Niessen  
T: + 49 2408 9456 44  
F: + 49 2408 9456 45  
E: info@inform-software.com

##### Subarnarekha Port Private Ltd

New No.84, Old No.50  
"Dakshin", 1st Ave, Indranagarr  
Adyar  
Chennai  
600020  
India  
Contact: Mr Ramani Ramaswamy  
T: + 914424431900  
F: + 914442607368 - Ext 18  
E: subarnarekha.port@gmail.com  
W: www.creativeports.com

#### MEXICO

##### Servicios Especiales Portuarios

S.A. de C.V.  
Bustamante 173-1  
Fracc Los Pinos  
Veracruz  
C.P. 91870  
Mexico  
Contact: Mr Andrew Gillespie  
T: + 52 229 934 3718  
F: + 52 229 178 2329  
E: direccion@sepsaver.com  
W: www.sepsaver.com

One scale for rail and one scale for trucks into our facility. 4.5 Ha for mineral break bulk cargo stowage.

#### SOUTH

#### AFRICA

##### Transnet Freight Rail

Head Office  
Inyanda House  
13 Giron Road  
Parktown  
Johannesburg  
Gauteng province  
2193  
South Africa  
Contact: Mr Siyabonga Gama  
T: + 27 11 584 0509/10  
F: + 27 11 774 9978  
E: siyabonga.gama@transnet.net  
W: www.spoomet.co.za

#### THE

#### NETHERLANDS

##### Keyrail

Develsingel 11  
Zwijndrecht  
3333 LD  
The Netherlands  
Contact: Mrs Ezra Drost  
T: + 31 78 6777530  
E: e.drost@keyrail.nl

#### UK

##### DB Schenker

Lakeside Business Park Carolina  
Way  
Doncaster  
South Yorkshire DN4 5PN  
UK  
Contact: Mr Graham Meiklejohn  
T: +44 8701405000  
E: graham.meiklejohn@dbschenker.com

##### Don Valley Engineering Co Ltd

Sandall Stones Road  
Doncaster  
DN3 1QR  
UK  
Contact: Mr Roger Allen  
T: + 44 1302 881188  
F: + 44 1302 881000  
E: sales@donvalleyeng.com  
W: www.donvalleyeng.com

##### Freightliner Heavy Haul

Aire Valley Depot  
Stranglands Lane  
Ferrybridge  
West Yorks  
WF11 8RA  
UK  
Contact: Mr Martin Wilks  
T: + 44 1977 466805  
F: + 44 1977 466804  
E: wilksm@freightliner.co.uk  
W: www.freightliner.co.uk  
Freightliner Heavy Haul operates bespoke rail haulage services in the coal, aggregates, cement, waste and minerals markets, establishing an unparalleled reputation for service reliability.

##### Freightliner Heavy Haul

3rd Floor  
The Podium  
1 Eversholt Street  
London  
NW1 2FL  
UK  
Contact: Ms Monica Callus  
T: + 44 207 2003900  
F: + 44 207 2003975  
E: callusm@freightliner.co.uk  
W: www.freightliner.co.uk  
Heavy Haul is a leading player in the coal, aggregates and cement sectors. Also operating trains in the waste, petroleum and minerals markets, the company has carried out Infrastructure work for Network Rail since its inception in 1999.





**GB Railfreight (FirstGBRF)**

15-25 Artillery Lane  
London  
E1 7HA  
UK

Contact: Mr Tim Robinson  
T: + 44 20 7904 3393  
F: + 44 20 7983 5170  
E: gbrinfo@gbraillfreight.com  
W: www.gbraillfreight.com  
GB Railfreight is the United Kingdom's newest freight train operator. The company was created following research that identified the need for further competition in the railfreight market.

**VTG Rail UK Ltd.**

Sir Stanley Clarke House  
7 Ridgeway  
Quinton Business Park  
Birmingham  
B32 1AF  
UK

Contact: Mr Ian Shaw  
T: + 44 121 421 9180  
F: + 44 121 421 9184  
E: ian.shaw@vtg.com  
W: www.vtg.com

**USA****Burlington Northern Railroad**

3701 East Itasca Street  
Superior  
Wisconsin  
54880  
USA

Contact: Mr John O Ambler  
T: + 1 817-867-6407  
F: + 1 817-352-7924  
E: john.ambler@bnsf.com

**CN Railway**

17641 S. Ashland Avenue  
Homewood  
Illinois  
60430  
USA

Contact: Mr Tommy Browning  
T: + 1 708 332 3803  
F: + 1 708 332 3673  
E: Tommy.Browning@cn.ca  
W: www.cn.ca

**CSX Transportation**

CSX- Chesapeake Bay Piers  
1910 Benhill Avenue  
Baltimore  
Maryland  
21226  
USA

Contact: Mr Craig Blinker  
T: + 1 410 355 6302  
F: + 1 410 355 2088  
E: Craig\_Blinker@csx.com

**Duraport Marine & Rail**

**Terminal, LLC**  
PO Box 1009

Bayonne  
New Jersey  
07002  
USA

Contact: Mr Vincent Alessi  
T: + 1 201 437 0703  
F: + 1 201 437 0158

E: vincealessi@aol.com

**Ecofab Maintenance USA Inc.**

1645 Lonsdale Avenue  
North Vancouver  
B.C.  
V7M 2J5  
USA

Contact: Mr Doug Bock  
T: + 1 604 903 2000  
F: + 1 604 903 2025  
E: dbock@ecofab.com

**Electro-Motive Diesel (EMD)****Inc**

9301 West 55th Street  
La Grange  
IL  
60525  
USA

Contact: Mr Scott Garmin  
T: + 1 708 387 3938  
F: + 1 708 387 6626  
E: frank.w.ward@EMDiesels.com  
W: www.EMDiesels.com

**Kansas City Southern**

427 West 12th Street  
Kansas City  
MI  
64105  
USA

Contact: Mr Rich Weigel  
T: + 1 816-983-1303  
F: + 1 800-243-8624  
E: rweigel@kcsouthern.com  
W: www.kcsi.com

**Kinder Morgan Terminals**

3500 N. Causeway Blvd  
Suite 210  
Metairie  
LA  
70002  
USA

Contact: Mr John Vaughn  
T: +1 504 620 4639  
F: +1 504 620 4698  
E: john\_vaughn@kindermorgan.com

**Norfolk Southern Coal Business****Group**

110 Franklin Road  
S.E., Roanoke  
VA  
24042-0026  
USA

Contact: Mr Daniel D Smith  
T: + 1 757 629 2813  
E: Danny.Smith@nscorp.com

**Savage**

Old River Operations  
16800 Greenspoint Park Drive  
Suite 120N  
Houston  
Texas  
77060  
USA

Contact: Mr Joshua Knichel  
T: + 1 281 673 1098  
F: + 1 281 673 1086  
E: Joshknichel@savageservices.com  
W: www.savageservices.com/

**TBS Shipping Services**

612 Grassy Sprain  
Yonkers  
New York  
10710  
USA

Contact: Mr Gregg McNelis  
T: + 1 914 961 1000  
F: + 1 914 961 2286  
E: commercial@nyc.tbsship.com  
W: www.tbsgroup.com/

**Union Pacific Railroad Co**

1416 Dodle Street  
Dodge room 400  
Omaha  
NE  
68179  
USA

Contact: Mr Mark Davis  
T: + 1 402 5445459  
F: + 1 402501 0011  
E: mwdavis@up.com

**Utah Railway Corporation**

4692 North 300 West  
Suite 220  
Provo  
Utah  
UT 84604  
USA

Contact: Mr James M Davis  
T: +1 801 221 7460  
F: +1 801 221 7462  
E: jdavis@gwrr.com  
W: www.gwrr.com





## The strength of experience

Precision quality manufacture, an entire palette of styles and options demand highly advanced FIBC manufacturing technology.

Equipment from the experts makes it possible:

Starlinger leads the world market in machinery for woven flexible bulk packaging and FIBC testing.

Let our experience work for you – [www.starlinger.com](http://www.starlinger.com)

**Visit us at:** ARABPLAST 2013, January 7-10, Hall 6  
Dubai International Convention & Exhibition Centre

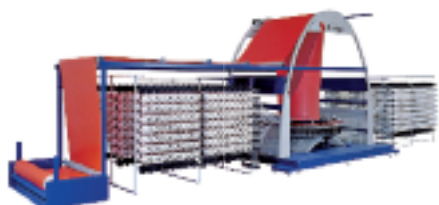

  
**Starlinger**



# FIBC & BAG MANUFACTURING COMPANIES

## AUSTRALIA

### Bulk Handling Australia Pty Ltd

45 Centre Way  
Croydon South  
Victoria  
3136  
Australia

Contact: Mr Paul Gonzales  
Products Manager IBC's  
T: + 61 3 9761 4433  
F: + 61 3 9761 4558  
E: pgonzales@bha.com.au  
W: www.bha.com.au

## AUSTRIA

### Mondi Packaging

Kelsenstrasse 7  
Vienna  
A-1030  
Austria

Contact: Ms Christina Fadier  
Marketing Communications  
Manager  
T: + 43 1 79013 4917  
F: + 43 1 79013 964  
E: info.bags@mondigroup.com  
W: www.mondigroup.com/

Mondi Industrial Bags offers the full range of industrial paper bags. With 37 operations in 27 countries we can serve our clients in the cement & building materials, chemicals, food & feed & seed industries wherever they need us

### Starlinger & Co. GmbH

Sonnenuhrgasse 4  
Vienna  
A-1060  
Austria

Contact: Mr Alfred Rußwurm  
Marketing Manager  
T: + 43 1 599 55 0  
F: + 43 1 599 55 180  
E: office@starlinger.com  
W: www.starlinger.com

Starlinger is the world's leading producer of machinery for woven plastic sack production (coated or uncoated sacks, Leno, valve sacks, AD\*STAR® block bottom valve sacks and FIBCs). The product range also includes plastics recycling machines, PET bottle r

## BELGIUM

### Bekintex NV

Industriepark Kwatrecht -  
Neerhonderd 16  
Wetteren  
9230  
Belgium

Contact: Ms Ilse Veldeman  
Marketing Assisant  
T: + 32 9 365 7111  
F: + 32 9 365 7117  
E: ilse.veldeman@bekaert.com  
W: www.bekaert.com

### C & P Pack

Derbycentrum Industriepark  
West 75  
St Niklaas

B9100  
Belgium  
Contact: Mr Can Sarac  
Managing Director  
T: + 32 3 780 1732  
F: + 32 3 766 5825  
E: secretaariaat@bcwaasland.be  
W: www.debant.com

### LC Packaging

Vaartkom 35  
Leuven 3000  
Belgium  
Contact: Mr Patrick Swinnen  
T: + 32 16 844274  
F: + 32 16 844290  
E: pswinnen@lcpackaging.be  
W: www.lcpackaging.com

## BULGARIA

### Assenova Krepost

2 Ivan Vazov Str  
Blagoevgrad  
4230  
Bulgaria

Contact: Mrs Arnaudo  
T: + 359 331 223 95  
F: + 359 331 263 75  
E: admin@ceebe.com

## CANADA

### Syn-Tex Bag

211 Hutchings Street  
Winnipeg  
Manitoba  
R2X 2R4  
Canada

Contact: Mr Garry Smith  
General Manager  
T: + 1 204 632 5667 ext. 213  
F: + 1 204 633 4125  
E: gsmith@syntexbag.com  
W: www.syntexbag.com

## CHINA

### Changzhou Quick Way FIBC Ltd

Fiat C, 12/F.  
18 Cao Xi Bei Road  
Shanghai  
200030  
China

Contact: Mr Kim Bi  
Sales Manager  
T: + 86 21 5489 2602  
E: sale@czquickway.com  
W: www.czquickway.com

## CZECH

## REPUBLIC

### LANEX Packaging s.r.o.

Hlucinska 93  
Bolatice  
747 23  
Czech Republic  
Contact: Mr Martin Postuka  
Sales Manager

T: + 420 553 751 325  
F: + 420 724 654 151  
E: martin.postulka@lanex.cz  
W: www.lanex.cz

Production, development and sale of flexible containers designed for packaging, handling and transport of particularly bulk and free-flowing products. Efforts on specialization, alcove markets, flexibility, prompt deliveries to measure, in due time and top quality.

## DENMARK

### Anders Bendt A/S

Dalagarde  
Aarhus C  
DK 8000  
Denmark

Contact: Mrs Tine Bendt  
Managing Director  
T: + 45 86 19 0500  
F: + 45 86 19 0577  
E: dry-bag@desiccant.com  
W: www.desiccant.com

## GERMANY

### EFIBCA

Kaiser-Friedrich-Promenade 43  
Bad Homburg  
61348  
Germany

Contact: Ms Kerstin Meggert  
EFIBCA Secretariat  
T: + 49 61 7292 6665  
F: + 49 61 7292 6670  
E: k.meggert@kunststoffverpackungen.de  
W: www.efibca.com  
European Association of FIBC

manufacturers, distributors and suppliers to the manufacturers.

## EMDE INDUSTRIE-TECHNIK

PO Box 1339 Koppelheck  
Nassau-Lahn  
56377  
Germany

Contact: Mr Hansjürg Emde  
Managing Director  
T: + 49 2604 97030  
F: + 49 2604 970333  
E: info@emde.de  
W: www.emde.de

## GREIF-VELOX

Kronsfordter Landstraße 177  
Lübeck  
D-23560  
Germany

Contact: Mr Poppe  
T: + 49 451 530 30  
F: + 49 451 530 233  
E: logdos@logdos.de  
W: www.greif-velox.de

## PEMA Verpackung

Carl Zeiss Strasse 10  
Syke  
28857  
Germany

Contact: Mr Raake  
T: + 49 42 42 53 93 0  
F: + 49 42 425 02 09  
E: raake@pema-verpackung.de

## Schleswiger Tauwerkfabrik

Oellerking GmbH & Co KG  
Margarethenwallstr. 7  
Schleswig  
D-24837  
Germany

Contact: Mr Johannes Jensen



Sales Manager  
T: + 49 4621 3809 40  
F: + 49 4621 3809 99  
E: j.jensen@oellerking.com  
W: http://www.oellerking.com  
Liner bags, thermo liner and  
Sweatknings for standard container.

## INDIA

**Taurian Exim Pvt. Ltd**  
199 / 201 Gold Coin Bldg  
2nd Floor Sheikh Memon Street  
Zaveri Bazaar  
Mumbai  
Maharashtra 400 002  
India  
Contact: Mr Sachin Bajja  
Managing Director  
T: + 91 22 234 53430  
F: + 91 22 234 53589  
E: taurian@vsnl.com

## IRELAND

**Synthetic Packaging**  
Clara  
County Offaly  
Ireland  
Contact: Mr Aiden Devery  
Managing Director  
T: + 353 579 331 282  
F: + 353 579 331 224  
E: aiden.devery@  
syntheticpackaging.com  
W: www.syntheticpackaging.com

## ITALY

**FEMADIGIPACK s.r.l**  
Via Romano, 9  
Cortenuova  
Bergamo  
24050  
Italy  
Contact: Mr Marco Belotti  
Project Engineer  
T: + 39 0363 911 396  
F: + 39 0363 902 466  
E: info@femadigipack.it  
W: www.femagroup.net

**Sa Te In**  
Castell'Arquato (PC) 29014  
Strada Castellana  
KM 7  
Italy  
Contact: Mr Giuseppe Massouda  
Sales Director  
T: + 39 0525 804133  
F: + 39 0523 804338  
E: giuseppe.massouda@italitex.com  
W: www.satein.com

**Saccheria F.Li Franceschetti**  
Spa  
Via Stazione Vecchia 80  
Provaglio d'Iseo  
Brescia  
25050  
Italy  
Contact: Mr Maurizio Bonardi  
Commercial Dept  
T: + 39 030 982 3841  
F: + 39 030 983 9039  
E: comag@saccheriafranceschetti.it  
W: www.saccheriafranceschetti.it

## JAPAN

**Taiyo Kogyo Corporation**  
2-33-16 Ikejiri  
Setagaya-ku  
Tokyo  
154-0001  
Japan

Contact: Mr Daiki Shirai  
Assistant Manager  
T: + 81 3 3714 3311  
F: + 81 3 3791 5558  
E: sd003275@mb.taiyokogyo.co.jp  
W: www.taiyokogyo.com/taicon  
Taiyo Kogyo offers a wide variety of  
FIBCs ranging from single/multi-trip  
PP woven FIBCs to repairable  
heavy-duty FIBCs made of PVC  
and other tarpaulins.

## KENYA

**Raffia Bags Ltd**  
Plot No. MNV 1083  
Mombasa/Nairobi Road  
Miritini  
Mombasa  
Kenya  
Contact: Mr Pieter Nel  
Managing Director  
T: + 254 2020 479 26  
E: pieter.nel@raffiabags.com  
W: www.raffiabags.com

## LUXEMBOURG

**SOLEM S.A.**  
13, Fausermillen  
Mertert  
6689  
Luxembourg  
Contact: Mr Bernd Beeking  
General Manager  
T: + 352 75 07 91 25  
F: + 352 74 96 46  
E: bernd.beeking@solem.lu  
W: www.solem.lu  
Single use and reusable containers  
manufactured to specification for  
individual requirements with various  
top and bottom shapes, filling and  
discharging devices and variety of  
closures. Safety factor (SF): 5  
(disposable) or 6 (reusable); safe  
working load.

## NEW

## ZEALAND

**Donaghys**  
16 Sheffield Crescent  
Harewood  
Christchurch  
New Zealand  
Contact: Mr H N F Ross  
T: + 64 3 983 4100  
F: + 64 3 983 4191  
E: enquiries@donaghys.co.nz  
W: www.donaghys.com/

## NORWAY

**Goodtech Solutions AS**  
Bjoernstetveien 2  
Porsgrunn  
N-3917  
Norway  
Contact: Mr Knut Halvorsen  
Group Commercial Manager  
T: + 47 90 08 74 08  
F: + 47 35 93 05 60  
E: knut.halvorsen@goodtech.no  
W: www.portabulk.com or  
www.goodtech.no  
Based on PORTABULK®  
technology and in close  
cooperation with its international  
marketing and manufacturing  
network, Goodtech Solutions  
delivers superior, cost-effective  
materials handling technology,  
products, systems and services in  
selected markets.

## PORTUGAL

**Cotesi SA**  
Av. Mosteiro, 486  
Grijó  
4415-493  
Portugal  
Contact: Mr Ricardo Soares  
T: + 351 227 476 500  
F: + 351 227 646 575  
E: ricardo.soares@cotesi.com  
W: www.cotesi.com  
Manufacturer of Big Bags, small  
bags and PP woven fabrics since  
1967. Production facilities in  
Europe and Asia. Logistic and sales  
network covering all over  
continental Europe and the UK.

## RUSSIA

**Nekrasovsky**  
Dmitrov District  
Moscow Region  
141760  
Russia  
T: + 7095 578 6452  
F: + 7095 578 4698

**Plastcon**  
Nefyanaya doroga, 1 A  
St Petersburg  
193060  
Russia  
Contact: Ms Anna Starikova  
T: + 7 812 766 5905  
F: + 7 812 766 0370  
E: starikova@plastcon.ru

## SINGAPORE

**Interbulk Enterprise**  
12 Mariam Walk  
Singapore  
507172  
Singapore  
Contact: Mr Michael Lian Soon  
Leong  
T: + 65 654 66335 / 4688  
F: + 65 654 50985  
E: liancom@singnet.com.sg

**Ssangleong Corporation Pte Ltd**  
72 Tuas South Street 5  
Singapore  
637807  
Singapore  
Contact: Mr Soon Beng (Steven)  
Lien  
T: + 65-6265 7377  
F: + 65 6264 7377  
E: info@ssangleong.com  
W: http://ssangleongsingapore.  
tripod.com/

## SOUTH

## AFRICA

**Industrial Netting (Pty) Ltd**  
PO Box 39624  
Bramley  
Transvaal  
2018  
South Africa  
Contact: Mr Ian Campbell  
Managing Director  
T: + 27 11 6084686  
F: + 27 11 6084690  
E: info@industrialnetting.co.za  
W: www.industrialnetting.co.za

**Raffia Bags Ltd**  
26 Yellow Street  
Isithebe

Mandeni  
4090  
South Africa  
Contact: Mr Charles Watson  
T: + 27 39 542 5050  
E: charles.watson@raffiabags.com  
W: http://tufbag.com

**Tufbag**  
PO Box 155  
Mandini  
KwaZulu Natal  
4490  
South Africa  
Contact: Mr Russell Titmas  
National Sales Manager  
T: + 27 32 459 5050  
F: + 27 32 459 2581  
E: russell.titmas@tufbag.com  
W: http://tufbag.com  
Manufacturers of: Flexible  
Intermediate Bulk Containers  
(FIBC), Heavy duty/limited trip and  
single trip (Bulk bags). •Woven  
•Woven polypropylene sacks and  
bags both laminated and unlamina-  
ted all of which can be fitted with  
normal or shaped liners with

## SPAIN

**Beniplast/Benitex**  
Avda Vicente Boluda Polop  
S/N 46830  
Beniganim  
Valencia  
46830  
Spain  
Contact: Mr Vicente Cuquerella  
Managing Director  
T: + 34 96 391 6906  
F: + 34 96 392 1638  
E: valencia.btx@benitex.com  
W: www.benitex.com

**Clime SA**  
c/ Castilla 52-54  
Barcelona  
08018  
Spain  
Contact: Mr John Climent  
T: + 34 93 307 6362  
F: + 34 93 308 5649  
E: climesa@fibcnet.com  
W: www.fibcnet.com

**Condepols**  
Pozuelo de Alarcón  
Madrid  
28037  
Spain  
Contact: Mr Ignacio Baillo  
Commercial Director  
T: + 34 91 337 7048 / +34 91 337  
7040  
F: + 34 91 515 3172  
E: ignacio.l.baillo@condepols.es  
W: www.condepols.es

**Industrias Murtra**  
Jordi Camp 94  
Apartado 278  
Granollers  
Barcelona  
08403  
Spain  
Contact: Mr Xhabby Franco  
Sales Manager  
T: + 34 93 846 7200  
F: + 34 93 846 5956  
E: murtra@murtra.com  
W: www.murtra.com

**Propitex SA**  
Poligono Industrial s/n  
Aioz  
Navarra  
31430  
Spain  
Contact: Mrs Monica Fuentes

Commercial Manager  
T: + 34 948 334 115  
F: + 34 948 334 116  
E: comercial@propitex.com  
W: www.propitex.com

## Rodenas & Rivera S.A.

PO Box 252  
Albacete  
02080  
Spain  
Contact: Ms Maria Galan  
Marketing  
T: + 34 967510270  
F: + 34 967511098  
E: Rodenasrivera@  
rodenasrivera.com  
W: www.rodenasrivera.com

## SWEDEN

**Bergu International AB**  
Nygata 30  
Box 5006  
Helsingborg  
S-250 05  
Sweden  
Contact: Mr Conny Simonsson  
T: + 46 42 12 7970  
F: + 46 42 12 8002  
E: bergu@telia.com  
W: www.bergu.com  
Designs, manufactures, assembles  
and develops products for  
pneumatic conveying and bag  
emptying in order to meet the  
requirements of todays market.

## IBC International Handling AB

Hamnv. 1  
Falkenberg  
S-311 32  
Sweden  
Contact: Ms Maria Penca  
Marketing Manager  
T: + 46 346 56910  
F: + 46 346 56918  
E: sales@ibc-international.se  
W: www.ibc-international.se  
Supplies complete customised  
bagging systems, including dust-  
free, filling, emptying /discharging,  
de-aeration and vibration facilities.

## TANZANIA

**Raffia Bags Ltd**  
Plot no 103/107  
Bagamoyo Road  
Dar-Es-Salaam  
Tanzania  
Contact: Mr Giuseppe Carosini  
Managing Director  
T: + 255 22 265 0371/3/4  
F: + 255 22 265 0375  
E: giuseppe.carosini@  
raffiabags.com  
W: www.raffiabags.com  
Largest WPP bag manufacturer in  
East Africa. Factories: Mombasa,  
Kenya and Dar es Salaam,  
Tanzania. Manufacturer: WPP, 50  
kg. AD\*Star Cement bag.  
Manufacturer: Agricultural bags all  
sizes, printed.

## THE

## NETHERLANDS

**Chronos BTH B V**  
Meerheide 40  
Eersel  
5521 DZ  
The Netherlands  
Contact: Mr Ingo Jonas  
Managing Director



**CorrPakBPS offers a complete range of sea bulk container liners designed to transport your dry bulk products safely, efficiently and cost-effectively.**

### END FILL BULK LINERS

End Fill bulk liners fitted to standard container modified with a temporary bulkhead.

End Fill bulk liner with optional filling and discharge sleeves. Various liner retention systems are available.

End Fill bulk liner with letterbox discharge sleeve.

### TOP FILL BULK LINERS

Top Fill bulk liner fitted to a top fill bulk container.

Top Fill bulk liner with optional tube sleeve discharges. Various liner retention systems are available.

Top Fill bulk liner with letterbox discharge sleeve.

### OPEN TOP BULK LINERS

Open top bulk liners can be fitted to either open top containers or bulk containers.

Open top bulk liners

### WIDE ACCESS BULK LINERS

Perfect for sealing and protecting equipment, materials or palletized goods.

A wide access bulk liner fitted to a standard container. Note the protective carpet which is progressively removed as the cargo is loaded.

After loading the liner is gathered and secured at the neck.

**Bulk Liners are the perfect solution for shipment of dry, free flowable goods such as: PE, PVC, PET, PTA resins, sugar, minerals, grains, malt, and other products in flake, granule, powder or pellet form.**

506 NORTH 31ST STREET,  
SUITE 4, MONROE LA,  
71201, USA



**CORRPAKBPS**

(318) 699-0108  
WWW.CORRPAKBPS.COM

T: + 31 497 51 49 88  
F: + 31 497 51 49 53  
E: info@chronosbth.com  
W: www.chronosbth.com

## Greif Flexibles Benelux B.V.

Jupiterweg 1  
Harbournumber M-389  
Moerdijk  
4761 RW  
The Netherlands  
Contact: Mr Rob Mathijssen  
T: + 31 168 35 99 99  
F: + 31 168 35 99 88  
E: Flexibles.benelux@greif.com  
W: www.greif.com  
Greif's Flexible Products & Services business provides FIBCs, shipping sacks, container liners and other flexible industrial packaging for chemicals, pharmaceuticals, foodstuffs and many other sectors. We also offer a full portfolio of geotextiles, agricut

## Interbulk BV

Nieuwe Haven 125  
Zierikzee  
4301 DL  
The Netherlands  
T: + 31 111 45 1100  
F: + 31 111 45 1010  
E: info@interbulk.nl  
W: www.interbulk.nl

## Interjute BV

PO Box 154  
Hulst  
4560 AD  
The Netherlands  
Contact: Mr Ed Wessels  
International Sales Manager  
T: + 31 114 311208  
F: + 31 114 311512  
E: ewessels@interjute.nl  
W: www.interjute.com  
INTERJUTE is one of Europe's major suppliers of polypropylene sacks and big bags for the packaging of fertilizer, chemicals, animal feed, malt, flour, sugar and many other products.

## Lankhorst Indutech BV

Prinsengracht 2  
Sneek  
8607 AD  
The Netherlands  
Contact: Mr W Stroed  
Managing Director  
T: + 31 515 487 654  
F: + 31 515 422 681  
E: info@lankhorst-touwfabrieken.nl  
W: www.lankhorst-indutech.nl

## Zakkencentrale B.V.

3100 AJ Schiedam  
Cairostraat 50  
Rotterdam  
3047 BC  
The Netherlands  
Contact: Mr Harm Peters  
Managing Director  
T: + 31 10 462 3511  
F: + 31 10 462 6939  
E: exim@zakkencentrale.nl  
W: www.zakkencentrale.nl

## TURKEY

### Avplast Dis Tic. Ve Paz. Ltd. Sti.

Egitim Mah. Kasap Ismail Sok.  
Avrasya Is Merkezi No:14 Kat:1  
D:24-  
34722 Hasanpasa / Kadikoy  
Istanbul  
81080  
Turkey  
Contact: Mr Hakan Avci  
T: + 90 216 338 32 31 - 347 38 54

F: + 90 216 348 88 95  
E: sales@avplast.com.tr  
W: www.avplast.com.tr

## Cesur Packaging Corporation

Yakacak Yanyol  
Senem Sokak No:11  
Kartal  
Istanbul  
34876  
Turkey  
Contact: Mr Cihan Cesur  
Sales & Marketing Director  
T: + 90 216 377 28 55  
F: + 90 216 377 11 90  
E: info@cesur.com  
W: www.cesur.com

## Greif Flexibles Turkey

Fabrika Sokak No.2/8  
Samandira  
Istanbul  
34885  
Turkey  
Contact: Mr Can Sezer  
Business Development Director,  
EMEA  
T: + 90 216 564 0600  
F: + 90 216 311 5013  
E: mail@unsa-tr.com  
W: www.unsa-tr.com

## Gulsan A.p.

Organize Sanayi Bolgesi 2 Cad.  
No: 18  
Gaziantep  
27180  
Turkey  
Contact: Ms Gulden Saka  
Marketing Manager  
T: + 90 342 337 1180  
F: + 90 342 337 2528  
E: info@gulsan-group.com  
W: www.gulsan-group.com

## Isbir Sentetik Dokuma San. A.S.

Izmir Yolu  
Cayirhisar Mevkii  
Balikesir  
10034  
Turkey  
Contact: Mr Tanin Guven  
Marketing Manager/Sales Director  
T: + 90 266 283 0000  
F: + 90 266 283 0001  
E: taninguven@isbirsentetik.com  
W: www.isbirsentetik.com  
One of the world's largest manufacturers of Big Bags (FIBCs) , PP woven bags, container liners , geosynthetics and FIBC components , with a global sales network.

## Tetsa A.S.

Koseilyas Yoyu Yolu 2. km  
Degirmenalti Mevkii  
Tekirdag  
59000  
Turkey  
Contact: Mr Ekrem Edip  
T: + 90 282 293 2222  
F: + 90 282 293 2228  
E: bilgi@tetsa.com.tr  
W: www.tetsa.com.tr

## UK

### Bulkgab Containers Ltd

Old Glamis Factory  
Old Glamis Road  
Dundee  
DD3 8JB  
UK  
Contact: Mr Hamish Milne  
Director  
T: + 44 1382 823824  
F: + 44 1382 823825  
E: sales@bulkgab.co.uk  
W: www.bulkgab.co.uk

We are heavy industrial sewing specialists who have over 20 years experience in the manufacture and development of Flexible Intermediate Bulk Containers (FIBCs). We can supply whatever size and style of bag you require.

## David Osborne Engineering Ltd

Nene House, Drayton Way  
Drayton Fields  
Davenport  
Northamptonshire  
NN11 8EA  
UK  
Contact: Mr David Osborne  
T: + 44 1327 301199  
F: + 44 1327 300681  
E: david@doeng.co.uk  
W: www.doengineering.co.uk

## Industrial Bulk Containers

Newton Business Park  
Talbot Road  
Hyde  
Cheshire  
SK14 4UQ  
UK  
Contact: Ms Judith Kelly  
T: + 44 161 367 8695  
F: + 44 161 367 8685  
E: industrialbulkcontainers@btconnect.com

## Miller Weblift Ltd

Marling Mills  
Nelson Street  
Leek  
Staffordshire  
ST13 6BB  
UK  
Contact: Mr Andrew Clement  
General Manager  
T: + 44 1538 384108  
F: + 44 1538 387350  
E: sales@millerweblift.com  
W: www.millerweblift.com

## Mulox Ltd

Unit 2, High Carr Business Park  
Off Millennium Way  
Newcastle  
Stoke-on-Trent  
Staffordshire  
ST5 7XE  
UK  
Contact: Mr Andrew Reardon  
Operations Director  
T: + 44 1782 565 659  
F: + 44 1782 562 252  
E: andrew.reardon@mulox.co.uk  
W: www.mulox.com  
Manufacturer of FIBCs mainly for the pharmaceutical, chemical and food industries. Specialists in high containment systems

## Structure-Flex Ltd

Peacock Way  
Melton Constable  
Norfolk  
NR24 2A3  
UK  
Contact: Mr Paul Reeve  
T: + 44 1263 863124  
F: + 44 1263 863110  
E: sales@structure-flex.co.uk  
W: www.structure-flex.co.uk

## USA

### B. A. G. Corp.

11510 Data Drive  
Dallas  
Texas  
75218  
USA  
Contact: Mr Matthew Simons  
Marketing Director  
T: + 1 214 340 7060 ext 832

F: + 1 214 340 7060  
E: matt@bagcorp.com  
W: www.bagcorp.com

## Bulk Lift International

1013 Tamarac Drive  
Carpentersville  
IL  
60110  
USA  
Contact: Mr Brian Kelly  
National Sales Manager  
T: + 1 847 428 6059 x 215  
F: + 1 847 428 7180  
E: briank@bulklift.com  
W: www.bulklift.com

## Bulk Sak International, Inc

103 Industrial Drive  
Malvern  
Arkansas  
72104  
USA  
Contact: Mr Grant Patterson  
President  
T: + 1 501 332 8745  
F: + 1 501 332 8438  
E: gpatterson@bulksak.com  
W: www.bulksak.com  
Full Scale FIBC Manufacture in the US and China. U Panned, Circular, Baffled, UN, Type D and Type C available. Specializing in Food and Pharma Grade Bags.

## CorrPak Bulk Packaging

### Systems, LLC

506 North 31st Street  
Suite 4  
Monroe  
LA  
71201  
USA  
Contact: Mr Andy Mintz  
President  
T: + 1 318 699 0108  
F: + 1 318 699 0501  
E: amintz@corrpkbps.com  
W: www.corrpkbps.com  
Specialists in intermodal sea bulk container liners for dry or flowing bulk products. With over 30 years experience in the manufacturing of industrial packaging products, we offer bulk bags (FIBCS) and Woven PP Bags!!!!

## FlexCon & Systems

50 Market Street  
#1A, Suite 331  
South Portland  
Maine 04106  
Lafayette  
LA  
LA 70506  
USA  
Contact: Mr Steve Herd  
Manager  
T: + 1 207 767 5387  
E: info@flexcon.com  
W: www.flex-con.com

## Intertape Polymer

3647 Cortez Road West  
Bradenton  
FL  
34210  
USA  
Contact: Mrs Cindy Wong  
Sales & Marketing  
T: + 1 941 727 5788 x 7594  
F: + 1 941 727 5293  
E: info@tape.com  
W: www.intertapepolymer.com

## King Bag & Manufacturing Co

1500 Spring Lawn Avenue  
Cincinnati  
OH  
45223

USA  
Contact: Mr Ron Kirsch Sr  
President  
T: + 1 513 541 8440  
F: + 1 513 541 6555  
E: ronr@kingbag.com  
W: www.kingbag.com

## Langston Companies Inc

2500 South K Street  
Tulare  
CA 93274  
USA  
Contact: Mr Carlton Truhett  
Managing Director  
T: + 1 559 688 3839  
F: + 1 559 688 1876

## Langston Companies Inc.

PO Box 60  
Memphis  
Tennessee  
38101-0060  
USA  
Contact: Mr Bob Langston  
President  
T: + 1 901 774 4440  
F: + 1 901 942 5402  
E: blangston@langstonbag.com  
W: www.langstonbag.com

## Powertex Inc

1 Lincoln Boulevard  
New York  
New York  
12979  
USA  
Contact: Mr George Bombardier  
Vice President Sales and Marketing  
T: + 1 518 297 4000  
F: + 1 518 297 2634 / 2242  
E: georgebombardier@powertex.com  
W: www.powertex.com  
Powertex is a manufacturer of Liners for 20', 30' and 40' ocean containers, with plants in the US, China and India. They produce using PE film FDA approved, antistatic, woven and foil and have the capability to customize according to customer needs. They also produce 25KG, 1/2 ton and 1 ton totes.

## Semi-Bulk Systems Inc

159 Cassens court  
Fenton  
MO 63026  
USA  
Contact: Mr Bentley  
T: + 1 636 343 4500 x 112  
F: + 1 636 343 2822  
E: rbentley@semi-bulk.com  
W: www.semi-bulk.com

## United DC

8947 Market Street  
Houston  
TX 77029  
USA  
Contact: Mr Ben Levine  
President  
T: + 1 713 671 8200  
F: + 1 713 671 8224





## PORTS &amp; TERMINALS



## ALBANIA

## Durrës

**Port Authority of Durrës**  
Lagja No.1 Rruga Tregtare  
Durrës  
Albania  
Contact: Mr Partizan Osmani  
Marketing  
F: + 355 52 23115  
E: apd@san.com.al  
W: <http://www.apdurrës.com.al/>

## ALGERIA

## Algiers

**Entreprise Portuaire d'Alger**  
2 Rue d'Angkor  
PO Box 259  
Algiers  
Algeria  
Port Director  
T: +213 21 42 36 14 / 16 / 18 / 23 / 42  
F: + 213 21 42 36 06  
E: epal@portalger.com.dz  
W: [www.portalger.com.dz](http://www.portalger.com.dz)

## Annaba

**Entreprise Portuaire de Annaba**  
Môle Cigogne  
Quai Nord  
PO Box 1232  
Annaba  
23000  
Algeria  
Contact: Mr D Salhi  
President Director General  
T: + 213 38 86 31 31/43  
F: + 213 38 86 54 15  
E: epan@annaba-port.com  
W: [www.annaba-port.com](http://www.annaba-port.com)

Location: North East of Algeria  
Equipment & Capacity: Grain silo:  
Two (02) loading/offloading grain  
unloader with a total capacity of  
100&400tph,  
Vigan grain unloader capacity 250tph  
Phosphates: 03 unloader of 1000tph -  
1200tph  
Coke-Iron: 04 unloader of 800-  
1000tph  
05 Electry quay crane 25t  
02 Electry quay crane 40t  
UAN-Phosphoric Acid - Urée en vrac :  
unloader 320tph  
Bulk Berths: Berth12 :Grain Depth:  
9.80m, Length: 155ml  
Berth11: Raw sugar-vegetable oil  
Depth: 9.50m, Length:145ml  
Berth13 Coal - Iron ore Depth: 13m,  
Length: 320ml  
Berth14-15 Steel products Depth:  
9.75m, Length:630ml  
Berth 16-17 et 19 : Phosphates  
Depth: 9.45m to 11m,  
Length:130-220ml  
Berth 18 UAN-Fuel-Tar-Ammonia  
Depth:11m, Length:125ml  
Total uncovered Storage: 163,000sqm  
Total covered Storage: 50,000sqm

## Bejaia

**Entreprise Portuaire de Bejaia**  
13 Avenue of the Amrani Brothers  
Bejaia  
06000  
Algeria  
Contact: Mr Achour Djelloul  
Port Chairman General Manager  
T: + 213 34 21 18 07  
F: + 213 34 20 14 88  
E: portbj@portdebejaia.dz  
W: [www.portdebejaia.dz](http://www.portdebejaia.dz)  
Location: The North East of Algeria at

260 KM. East of Algiers and 460km  
West of Annaba  
Equipment & Capacity: - grain vacu-  
ators (3x 250 tons per hour)  
- 2 cranes (1x 63 tons and 1x 80 tons)  
equipped with 10 t grabs for grain  
handling.  
- 2 cranes (2x 10t)  
- 3 new cranes (3x 64t) equipped with  
12 m3 grabs for grain handling  
Bulk Berths: 4 berths specialized for  
cargo bulk handling. Max length  
210m. Max draft 10.5m

## Beni Saf

**Entreprise Portuaire de Beni Saf**  
Route du Port  
Beni Saf  
Algeria  
T: + 213 43 225 468

## Ghazaouet

**Port Authority of Ghazaouet**  
PO Box 217  
Ghazaouet  
13400  
Algeria  
Contact: Mr K Mehabi  
Manager  
T: + 213 43 323353  
F: + 213 43 323255  
E: [contact@portdeghazaouet.com](mailto:contact@portdeghazaouet.com)  
W: [www.portdeghazaouet.com](http://www.portdeghazaouet.com)

## Mostaganem

**Entreprise Portuaire de Mostaganem**  
PO Box 131  
Mostaganem  
27000  
Algeria  
Contact: Mr Mohamed Bouabida  
Port Director  
T: + 213 45 21 14 11  
F: + 213 45 33-01-15  
E: [epm@port-mostaganem.dz](mailto:epm@port-mostaganem.dz)  
W: <http://www.port-mostaganem.dz/>

## Skikda

**Entreprise Portuaire de Skikda**  
Avenue Rezki Rahal  
PO Box 65  
Skikda  
21000  
Algeria  
Port Director  
T: + 213 38 75 68 50 / 75 22 54  
F: + 213 38 75 20 15  
E: [epskikda@skikda-port.com](mailto:epskikda@skikda-port.com)  
W: [www.skikda-port.com](http://www.skikda-port.com)

## ANGOLA

## Lobito

**Porto do Lobito E.P.**  
Largo Restoration 4  
Customs Building  
Lobito  
Benguela  
16  
Angola  
Contact: Mr José Carlos Gomes  
Manager Director  
T: +244 272 224 686  
F: +244 272 224 971  
E: [ops.lob@orey.co.ao](mailto:ops.lob@orey.co.ao)  
W: [www.portolobito.com](http://www.portolobito.com)  
Total uncovered Storage: 100,000  
sqm  
Total covered Storage: 25.853sqm  
Silos with 20,000t capacity

## Luanda

**Porto de Luanda**  
Administracao do Porto de Luanda  
Largo 4 de Fevereiro  
Luanda  
1229  
Angola  
T: + 244 2 335 975

F: + 244 2 840 535  
E: [portoluanda@snet.co.ao](mailto:portoluanda@snet.co.ao)  
W: [www.otal.com/angola](http://www.otal.com/angola)

## Luanda

**Cabinda Gulf Oil Company Limited**  
PO Box 2950  
Luanda  
Uige  
Angola  
Contact: Mr Alan Kleier  
Managing Director  
T: + 244 222 692 600  
F: + 244 222 394 348  
E: [questoes@chevron.com](mailto:questoes@chevron.com)  
W: [www.chevroningola.com](http://www.chevroningola.com)

## ARGENTINA

## Bahia Blanca

**Glencore/Toepfer Grain Elevator**  
Ingeniero White Port Area  
Bahia Blanca  
Argentina  
Contact: Mr Dario de Luca  
T: + 54 291 72332  
F: + 54 291 72360  
E: [dario.de.luca@glencore.com](mailto:dario.de.luca@glencore.com)

## Bahia Blanca

**Terminal Bahia Blanca, Piers 5/6, 7/8 and 9**  
Ingeniero White Port Area  
Bahia Blanca  
Buenos Aires  
8103  
Argentina  
Contact: Mr Horacio Moretti  
Manager  
T: + 54 91 457 3035  
F: + 54 91 457 1728  
E: [horacio.moretti@bunge.com](mailto:horacio.moretti@bunge.com)  
Location: Is located in Ingeniero White  
Port, Bahia Blanca City, Buenos Aires  
Province, Argentine Republic.  
Total uncovered Storage: TBB covers  
a total area of 136,890 sqm.  
Total covered Storage: The total  
storage capacity is about 197,000  
tons(wheat base) distributed among  
500 silos.  
The maximum discharging diary  
capacity is about 500 trucks and 200  
wagons.

## Bahia Blanca

**Oleaginosa Moreno Hermanos SA**  
Berths 2 and 3  
Puerto Galvan Port area  
Bahia Blanca  
8103  
Argentina  
T: + 54 291 457 3333  
E: [jruz@omhsa.com.ar](mailto:jruz@omhsa.com.ar)

## Bahia Blanca

**Bahia Blanca Port**  
Avenida Dr Mario M Guido  
8103 Ingeniero White  
Bahia Blanca  
Argentina  
Contact: Mr V Morán  
General Manager  
T: + 54 291 457 3213  
F: + 54 291 457 3214  
E: [secretaria@puertobahia.com.ar](mailto:secretaria@puertobahia.com.ar)  
W: [www.puertobahia.com.ar](http://www.puertobahia.com.ar)

## Bahia Blanca

**Puerto De Bahia Blanca**  
Consorcio De Gestion Del Puerto  
De Quequen  
Puertos De Ing White Y Galvan  
Av Dr Mario Guido Ing White  
Bahia Blanca  
Argentina  
Contact: Mr Luis Alejandro Arecco

President  
T: + 54 291 457 3213  
F: + 54 291 457 3214  
W: [www.puertobahia.com.ar](http://www.puertobahia.com.ar)

## Barranqueras

**Puerto de Barranqueras**  
Intervencion Provincial Puerto  
Barranqueras  
Av Rio Parana s/n  
Barranqueras  
Chaco  
3503  
Argentina  
Contact: Mr Daniel Ruben Gaborov  
T: + 54 3722 480216  
E: [puertobqras@arnet.com.ar](mailto:puertobqras@arnet.com.ar)  
W: [www.consejopuertoario.com.ar](http://www.consejopuertoario.com.ar)

## Barranqueras

**Puerto de Barranqueras**  
Av. Rio Parana s/n  
Barranqueras  
3503  
Argentina  
Contact: Mr Brandt  
T: + 54 3722 480216  
F: + 54 3722 480216  
E: [puertobqras@infovia.com.ar](mailto:puertobqras@infovia.com.ar)  
W: [www.advance.com.ar](http://www.advance.com.ar)

## Buenos Aires

**Terminal 4**  
Av. Edison y Prefectura Naval  
Puerto Nuevo  
Capital Federal  
Buenos Aires  
C1104BCA  
Argentina  
Contact: Mr Juan Corujo  
Terminal Manager  
T: + 54 11 45 900 900 Ext. 8120  
F: + 54 11 45 900 991  
E: [bueapmtrmg@apmterminals.com](mailto:bueapmtrmg@apmterminals.com)  
W: [www.apmterminals.com](http://www.apmterminals.com)

## Buenos Aires

**Terminals Rio de la Plata**  
Avda R.S. Castillo y Comodoro Py  
Buenos Aires  
C1104BEN  
Argentina  
T: + 54 11 4319 9500  
F: + 54 11 4315 2700  
E: [info@trp.com.ar](mailto:info@trp.com.ar)  
W: [www.trp.com.ar](http://www.trp.com.ar)

## Buenos Aires

**SA Berth**  
A/V Paseo Colon 505  
Fourth Floor (CP1063)  
Buenos Aires  
Argentina  
Contact: Mr Sergio Suarez  
T: + 54 11 4342 1727  
F: + 54 11 4346 8001  
E: [institucionales@puertobuenosaires.gov.ar](mailto:institucionales@puertobuenosaires.gov.ar)

## Buenos Aires

**Terminal EMCYM**  
Dársena C Norte 3ra. Sección  
Puerto Nuevo  
Buenos Aires  
1104  
Argentina  
T: + 54 11 4313 0332  
F: + 54 11 4313 0347  
E: [maritima@basal.com](mailto:maritima@basal.com)  
W: [www.basal.com](http://www.basal.com)

## Buenos Aires

**Terminal Buenos Aires SA**  
Av. Edison y Calle Prefectura Naval  
Argentina  
Dársena D Sud 2da.  
Puerto Nuevo  
Buenos Aires  
1104  
Argentina

Contact: Lic. Nicolas C Caporale  
Gerente de Planta  
T: + 54 11 4311 3598  
F: + 54 11 4312 8031  
E: ncaporale@terbasa.com.ar

## Buenos Aires

**ACA Berth - San Lorenzo Port**  
Asociacion de Cooperatives  
Argentinas Coop.(ACA)  
940 Madero Avenue  
6th Floor  
Buenos Aires  
C1106ACW  
Argentina  
Contact: Mr Nestor E. Salaberry  
Export Manager  
T: + 54 11 4310 1300 ext. 1168/1170  
F: + 54 11 4313 1349  
E: Salaberry@acacoop.com.ar  
W: www.acacoop.com.ar  
Location: KM 446,2 of Parana River -  
Santa Fe Province - Argentina  
Bulk Berths: 273mt load; draught  
40feet alongside berth at datum but  
according to Parana River limitation.  
Total covered Storage: 240,000mt dry  
grains. 11,000mt vegetable oils +  
70,000mt dry fertilizers + 30,000mt  
liquid fertilizers.  
Import: dry and liquid fertilizers.  
Export: grains and oilseeds  
ACA is a cooperative that also  
provides throughput to other Argentine  
exporters.

## Buenos Aires

**ACA Berth Nbr 3 - Quequen Port**  
Asociacion de Cooperatives  
Argentinas Coop.(ACA)  
940 Madero Avenue  
6th Floor  
Buenos Aires  
C1106ACW  
Argentina  
Contact: Mr Nestor E. Salaberry  
Export Manager  
T: + 54 11 4313 1300 ext.1168/1170  
F: + 54 11 4313 1349  
E: Salaberry@acacoop.com.ar  
W: www.acacoop.com.ar  
Location: Left hand margin at the  
mouth of the Quequen River, Buenos  
Aires, Argentina  
Bulk Berths: 230mt load; draught 39  
feet alongside at datum but according  
to Necochea Port restrictions  
Total covered Storage: 180,000mt dry  
grains. 10,5000mt vegetable oils.  
20,00mt dry fertilizers.  
Import: Dry fertilizers  
Export: Grains and vegetable oils  
ACA is a cooperative that also  
provides throughput to other Argentine  
exporters.

## Buenos Aires

**Quebracho Elevator**  
Avenida Leandro N Alem 928  
Buenos Aires  
1001  
Argentina  
Contact: Mr Luis Anunciata  
T: + 54 11 4476 29049  
F: + 54 11 4476 29057

## Buenos Aires

**TPA Terminals Portuarias**  
Argentinas  
Avenida Ramon Castillo 8  
Av. de los Inmigrantes y Av. Edison  
Acceso Maipu - Zona Puerto  
Buenos Aires  
1104  
Argentina  
Contact: Mr M Barea  
T: +54 11 4342 1727  
F: +54 11 4342 6836  
W: www.puertobuenosaires.gov.ar

## Buenos Aires

**Del Bene SA**  
Piedras  
77-90 Piso  
Buenos Aires  
1070  
Argentina  
Contact: Snr Ferruccio Del Bene  
T: + 54 11 4342 5211  
F: + 54 11 4343 5352

## Diamante

**Port of Diamante**  
Puerto Nuevo  
3105  
Diamante  
Entre Rios Province  
Argentina  
Contact: Mr Gheradi  
T: + 54 343 498 1424  
F: + 54 343 498 1424  
E: eaptodte@infoshoppte.com.ar

## Ensenada

**La Plata Port Administration**  
St. G. Gaggino y Ortiz de Rosas  
Ensenada  
Buenos Aires Province  
Argentina  
Port Director  
T: + 54 221 460 0233  
F: + 54 221 601014  
E: cgplp@ba.net

## Puerto General San Martin

**Terminal 6 S.A.**  
Hipolito Yrigoyen y Costa del  
Parana  
Puerto General San Martin  
Puerto General San Martin  
Provincia de Santa Fe  
CP 2202  
Argentina  
Contact: Mr Pablo Ferrés Sayago  
General Manager  
T: + 54 3476 438066  
F: + 54 3476 438046  
E: avaldez@terminal6.com.ar  
W: www.terminal6.com.ar

## Quequen

**Puerto Quequen**  
Avenue Juan de Garay 850  
Quequen  
Buenos Aires  
B7631XAF  
Argentina  
Contact: Mr Jose Alfredo Bisciotti  
President  
T: + 54 2262 450 006  
F: + 54 2262 450 006  
E: info@puertoquequen.com  
W: www.puertoquequen.com

## Quequen

**Consorcio de Gestion del Puerto**  
**de Quequen**  
Avda. Juan de Garay 850  
Quequen  
Buenos Aires  
7631  
Argentina  
Contact: Mr Jose Luiz  
President  
T: + 54 2262 450006  
F: + 54 2262 450006  
E: secretaria@puertoquequen.com  
W: www.puertoquequen.com  
Location: South East of the Province  
of Buenos Aires on the Atlantic Coast.

## Rosario

**Neptun SA - Operadores**  
**Maritimos**  
Terminal 1 s/no  
(Puerto Rosario)  
Rosario  
Sante Fe  
2000  
Argentina

Contact: Mr Alejandro Jose Peirone  
Administrative Manager  
T: + 54 57 1221 9406  
F: + 54 341 4808304  
E: info@neptunlog.com  
W: www.neptunlog.com

## Rosario

**Puerto Rosario**  
Ente Administrator Puerto Rosario  
Av Belgrano 341  
Rosario  
PICA de Santa Fe  
Argentina  
Contact: Mr Carlos Bermudez  
T: + 54 341 448 7105  
F: + 54 341 448 5010  
E: webcpgq@puertoquequen.com  
W: www.enapro.com.ar

## Rosario

**Puerto Rosario**  
Cordoba 1464 4 Piso de C  
Rosario  
PICA de Santa Fe  
2000  
Argentina  
Contact: Mr Marcelo J Suarez  
Vice President  
T: + 54 341 4487105  
F: + 54 341 4485010

## San Lorenzo

**Vicentin Elevator**  
Km 441  
San Lorenzo  
Argentina  
Contact: Mr Jorge Forbitti  
T: + 54 3 476 424 899  
F: + 54 3 476 425 977  
E: consultas@vicentin.com.ar  
W: www.vicentin.com.ar

## San Lorenzo

**Port of San Lorenzo**  
ACA Berth  
Avenida San Martin 2898  
San Lorenzo  
2200  
Argentina  
Contact: Mr Ing Raul Frugoli  
T: + 54 476 22225  
F: + 54 476 22225  
E: info@terminal6.com.ar

## San Pedro

**Terminal Puerto San Pedro S.A.**  
Av. San Martin 2500  
San Pedro  
Argentina  
Contact: Mr A Franco  
Port Director  
T: + 54 3329 420999  
F: + 54 3329 425279  
E: info@tsp.com.ar  
W: www.tsp.com.ar

## San Pedro

**Puerto de San Pedro**  
Administracion Portuaria  
Bonaerense  
Ruta 191 Km. 0  
San Pedro  
San Pedro  
2930  
Argentina  
Contact: Mr Miguel Hogo Gremo  
T: + 54 3329 425378  
F: + 54 3329 425279  
W: www.consejoportuario.com.ar

## Santa Fe

**Administration Puerto Santa Fe**  
Cabecera Darsena 1  
3000  
Santa Fe  
Argentina  
Contact: Mr Montero  
Port Director  
T: + 54 342 455 8400

F: + 54 342 455 8392  
E: info@puertosfe.com.ar  
W: www.puertosfe.com.ar

## Villa Constitucion

**Villa Constitucion Port Authority**  
Villa Constitucion  
Santa Fe  
Argentina  
Contact: Mr Martin Mansino  
T: + 54 3400 475012  
F: + 54 400 74404  
E: eapvc@cablenet.com.ar

## Zarate

**Zarate Port SA**  
Avda. Pagola 2007  
Zarate  
B2800DDO  
Argentina  
Contact: Mr Juan Gargantini  
General Manager  
T: +54 3487 423010  
F: +54 3487 423212  
E: juangargantini@zport.com.ar  
W: www.zport.com.ar

# ARUBA

## Oranjestad

**Port of Oranjestad**  
Aruba Ports Authority N.V.  
Port Administration Building  
L.G. Smith Blvd. # 23  
Oranjestad  
Aruba  
Contact: Mr Alfonso J Boekhoudt  
Managing Director  
T: + 297 582 6633  
F: + 297 583 2896  
E: Alfonso.Boekhoudt@  
arubaports.com  
W: www.arubaports.com

## San Nicolas

**San Nicolas Bay Port**  
Coastal Aruba Refining Co NV  
PO Box 2150  
San Nicolas  
Aruba  
Contact: Mr Jack Marshall  
Manager  
T: + 297 589 4500  
F: + 297 589 8000  
E: psn@intercom.com.ar  
W: www.consejoportuario.com.ar

# AUSTRALIA

## Adelaide

**ABB Grain**  
Southern Australia  
124-130 South Terrace  
Adelaide  
5000  
Australia  
T: + 61 8 8211 7588  
F: + 61 8 8124 0142  
E: abb@abb.com.au

## Adelaide

**Port Pirie Grain Terminal Berth 2**  
Grain House  
123-130 South Terrace  
Adelaide  
SA  
5001  
Australia  
T: + 61 8 8632 1455  
F: + 61 8 8632 5918  
E: flindersports@flindersports.com.au

## Adelaide

**Thevenard Grain Terminal**  
Grain House  
123-130 South Terrace  
Adelaide  
SA

5001  
Australia  
T: + 61 8 8211 8087  
F: + 61 8 8211 8087  
E: flindersports@flindersports.com.au

## Adelaide

**Flinders Ports Pty. Ltd**  
296 St. Vincent Street  
PO Box 19  
Adelaide  
S.A.  
5015  
Australia  
Contact: Mr Peter Shipp  
Port Operations  
T: + 61 8 8447 0611  
F: + 61 8 8447 0606  
E: flindersports@flindersports.com.au  
W: www.flindersports.com.au

## Adelaide

**Wallaroo Grain Terminal Berth 2**  
Grain House  
123-130 South Terrace  
Adelaide  
SA 5001  
Australia  
T: + 61 8 8211 8087  
F: + 61 8 8211 8087  
E: flindersports@flindersports.com.au  
W: www.flindersports.com.au

## Adelaide

**Flinders Ports Pty Ltd**  
296 St Vincent Street  
Port Adelaide  
Adelaide  
South Australia  
5015  
Australia  
Contact: Mr Wayne Parham  
Marketing Manager  
T: + 61 8 8447 0611  
F: + 61 8 8447 0606  
E: flindersports@flindersports.com.au  
W: www.flindersports.com

## Adelaide

**ABB Grain**  
GPO Box 1169  
Adelaide  
SA  
5001  
Australia  
Contact: Mr Tim Krause  
Logistics Manager  
T: + 61 8 8211 7199  
F: + 61 8 8231 1249  
E: tim.krause@abb.com.au  
W: www.abb.com.au

## Adelaide

**Port Giles Grain Terminal**  
Grain House  
124-130 South Terrace  
Adelaide  
5001  
Australia  
T: + 61 8 8211 7199  
F: + 61 8 8231 1249  
E: viterra.aus@viterra.com  
W: www.abb.com.au

## Adelaide

**SACBH Ardrossan Grain**  
**Terminal**  
Grain House  
123-130 South Terrace  
Adelaide  
5001  
Australia  
T: + 61 8 8211 8087  
F: + 61 8 8211 8087  
E: viterra.aus@viterra.com  
W: www.abb.com.au

## Albany

**Port of Albany**  
85 Brunswick Road



PO Box 175  
Albany  
WA 6330  
Australia  
Contact: Captain Steve Young  
Harbour Master  
T: + 61 8 9892 9000  
F: + 61 8 9841 7566  
E: apa@albanyport.com.au  
W: www.albanyport.com.au

## Brisbane

### North Queensland Bulk Ports Corporation Limited

GPO Box 409  
Brisbane  
Queensland  
4001  
Australia  
Contact: Mr Brad Fish  
CEO  
T: + 61 7 3011 7900  
F: + 61 7 3011 7997  
E: info@nqbp.com.au  
W: www.nqbp.com.au  
Location: Port Authority for Weipa, Abbot Point, Mackay, Hay Point & Maryborough: northwest coast and east coast of Queensland.  
Equipment & Capacity: Total throughput 2011-2012 approx. 124million tonnes.  
Bulk Berths: See port handbooks.  
The sea port facilities managed by NQBP are vital to the export and import performance of Queensland and Australia. NQBP ports handle bulk shipments of coal, bauxite, sand, sugar, grain, petroleum and general cargo.

## Brisbane

### Ports Corporation Queensland (PCQ)

GPO Box 409  
Brisbane  
Queensland 4001  
Australia  
Contact: Mr Brad Fish  
CEO  
T: + 61 733 247 088  
F: + 61 733 247 234  
E: info@pcq.com.au  
W: www.pcq.com.au  
Owns the port assets at Hay Point, Abbot Point, Weipa and Maryborough.

## Brisbane

### Port Weipa

Ports Corporation of Queensland  
PO Box 409  
Brisbane  
QLD 4001  
Australia  
Contact: Mr Brad Fish  
CEO  
T: + 61 7 3224 1088  
F: + 61 7 3224 7234  
E: info@pcq.com.au  
W: www.pcq.com.au  
Location: Located on the North-West coast of the Cape York Peninsula - Australia  
Equipment & Capacity: Total Bauxite export 2004/05: 15,519,910 tonnes  
Bulk Berths: Contact the Regional Harbour Master for current data.  
Phone (07) 4052 7412  
Other port facilities include general purpose and fuel wharves and tugs operated by Weifa Tug Service.  
Pilotage service provided by Maritime Safety Queensland.

## Brisbane

Queensland Bulk Handling Coal Export Terminal  
3 Bulk Terminals Drive  
Port of Brisbane  
Brisbane  
Queensland  
4178

Australia  
Terminal Manager  
T: + 61 7 3895 6500  
F: + 61 7 3895 1170  
E: qbhlogistics@qbh.com.au  
W: www.qbh.com.au  
Location: Port of Brisbane, Queensland, Australia

## Brisbane

### Cape Flattery

Ports Corporation of Queensland  
PO Box 409  
Brisbane  
QLD 4001  
Australia  
Contact: Mr Tycho Buningh  
Commercial Manager  
T: + 61 7 3244 7088  
F: + 61 7 3224 7234  
E: tbuningh@pcq.com.au  
W: www.pcq.com.au  
Location: Over 200 kms North of Cairns, on the east coast of the Cape York Peninsula, Australia  
Equipment & Capacity: On shore Silica Sand handling and stock pile facilities and a single trestle jetty and conveyor running from the mine to an off-shore berth and ship loader  
There is also a general purpose wharf where two line boats are moored (they assist in ship berthing). No tugs are required at the port.

## Bunbury

### Bunbury Port Authority

PO Box 4  
1 Henry Street  
Bunbury  
WA 6231  
Australia  
Contact: Mr Kevin Schellack  
General Manager-CEO  
T: + 61 8 97297020  
F: + 61 8 97218253  
E: grockford@bypport.com.au  
W: www.bypport.com.au  
Location: 170kms from Perth and some 15kms from the Kemeront Industrial Park.  
Equipment & Capacity: Four bulk shiploaders and a mobile shiploader.  
In addition the Port has six wharves for the discharge of bulk cargo.  
Loading capacities of the shiploaders range from 1,000tpb to approximately 2,000tpb.  
Bulk Berths: Six berths - serviced by deep water of 12.2m and uses a dynamic underkeel clearance to allow maximum freight to be carried by vessels. Using tide draughts of 12.5m are possible.  
Total uncovered Storage: Over 500 hectares of land suitable for Port related industry, much of which has direct access to berths and/or shiploading facilities.  
Total covered Storage: Provides a number of storage facilities ranging in size from 10,000sqm to 4,000sqm.  
The Authority has in place state of the art infrastructure, deep water and excellent transport corridors for the efficient and competitive exchange of goods between sea and land.

## Burnie

### Tasmanian Ports

PO Box 216  
Burnie  
Tasmania  
7320  
Australia  
Contact: Captain Trevor Bozoky  
Harbour Master & Deputy CEO  
T: + 61 3 6434 7300  
F: + 61 3 6434 7373  
E: secretary@tasports.com.au  
W: www.burnieport.com

## Cairns

### Ports North

PO Box 594  
Cairns  
QLD 4870  
Australia  
Contact: Mr Chris Boland  
Chief Executive Officer  
T: + 61 7 4052 3842  
F: + 61 7 4052 3853  
E: chris.boland@portsnorth.com.au  
W: www.portsnorth.com.au  
Location: Far North East Coast of Australia in the State of Queensland.  
Bulk Berths: Bulk discharges via hopper to truck on general cargo wharf.  
Total uncovered Storage: N/A

## Carrington

### Port Waratah Coal Services Limited

PO Box 57  
Carrington  
New South Wales  
2294  
Australia  
Contact: Mr Hennie du Plooy  
Chief Executive Officer  
T: + 61 2 4907 2000  
F: + 61 2 4907 3000  
E: contact\_us@pwcs.com.au  
W: www.pwcs.com.au  
Location: Newcastle, NSW, Australia  
Equipment & Capacity: Two coal export facilities with a combined capacity of 102 million tpa.  
Bulk Berths: 5 berths, each approximately 300m in length  
Total uncovered Storage: N/A  
Total covered Storage: N/A  
Port Waratah Coal Services Limited (PWCS), located in the Port of Newcastle, NSW, Australia, operates the world's largest and most efficient coal handling facility.

## Carrington

### Newcastle Agri Terminal

Lvl 1 92 Hill Street  
Carrington  
New South Wales  
2294  
Australia  
Contact: Mr Jock Carter  
Executive Director  
T: + 61 4 2728 3999  
E: jcarter@naterminal.com.au

## Carrington

### GrainCorp Operations Ltd

Denison Street  
(PO Box 64)  
Carrington  
NSW  
2294  
Australia  
Contact: Mr Mark Jelbart  
T: + 61 2 4224 6400  
F: + 61 2 4224 6466  
E: mjelbart@graincorp.com.au  
W: www.graincorp.com.au

## Dampier

### Dampier Port Authority

PO Box 285  
Dampier  
WA 6713  
Australia  
Contact: Mr C Norman  
General Manager  
T: + 61 91 596555  
F: + 61 91 596557  
E: info@dpa.wa.gov.au  
W: www.dpa.wa.gov.au

## Darwin

### P&O Automotive and General Stevedoring

PMB 23  
Berrimah

Darwin  
Northern Territory  
0828  
Australia  
Contact: Mr Michael Van Brederode  
Regional Manager  
T: + 61 8 8922 2300  
F: + 61 8 8941 0604  
E: craig.doudle@poags.com.au  
W: www.poags.com.au  
Location: Top of Australia, Northern Territory  
Equipment & Capacity: Heavy machinery and Portainer and mobile cranes  
Bulk Berths: Dry Bulk - discharge grabs and hoppers and bulk ship loader for loading  
Liquid bulk - discharging and loading equipment available  
Total uncovered Storage: As requested  
Total covered Storage: As requested

## Darwin

### Darwin Port Corporation

GPO Box 390  
Darwin  
NT  
0801  
Australia  
Contact: Mr Robert Ritchie  
Chief Executive Officer  
T: + 61 8 8922 0644  
F: + 61 8 8922 0666  
E: darwinport.dpa@nt.gov.au  
W: www.darwinport.nt.gov.au

## East Davenport

### P & O Automotive & General Stevedoring

Berth No 1, Spirit of Tasmania Terminal  
The Esplanade  
East Davenport  
Tasmania  
7310  
Australia  
Operations Manager  
T: + 61 3 6427 0138  
F: + 61 3 6427 8466

## East Perth

### James Point Pty Ltd (JPPL)

Level 2, 6 Bennett Street  
East Perth  
Western Australia  
6004  
Australia  
Contact: Mr Chris Whitaker  
Chairman  
T: + 61 408 428 079  
F: + 61 8 9202 1607  
E: chris.whitaker@jamespoint.com.au  
W: www.jamespoint.com.au

## Esperance

### Esperance Ports - Sean & Land

Corner of Bower Avenue & The Esplanade  
PO Box 35  
Esperance  
WA  
6450  
Australia  
General Manager of Commercial  
T: + 61 8 9072 3333  
F: + 61 8 9071 1312  
E: esppa@esperanceport.com.au  
W: www.esperanceport.com.au  
Location: Located on the Southern Ocean Coastline of Western Australia, approximately 720kms South East of the State Capital Perth.  
Equipment & Capacity: (Storage Capacity)  
Iron Ore: 900,000 Tonnes  
Nickel: 500,000 Tonnes  
Containers: 15,000 -20,000  
Fertiliser: 100,000 Tonnes  
Sulphur: 20,000 Tonnes  
Grain: 250,000 Tonnes

Bulk Berths: Cape Size Berth capable of loading 3,000tpb  
Total uncovered Storage: Approx. 89,000sqm  
Total covered Storage: Approx. 128,000sqm

## Fremantle

### Fremantle Ports

PO Box 95  
Fremantle  
WA  
6959  
Australia  
Contact: Mr Chris Leatt-Hayton  
CEO  
T: + 61 8 9430 3555  
F: + 61 8 9336 1391  
E: email@fremantleports.com.au  
W: www.fremantleports.com.au

## Geelong

### Geelong Port

PO Box 344  
Geelong  
Victoria  
3220  
Australia  
Contact: Mr Ken Stanley  
Operations Manager  
T: + 61 3 52470200  
F: + 61 3 52721560  
E: k.stanley@patrick.com.au  
W: www.geelongport.com.au  
Location: Southern Australia on Port Phillip Bay.  
Equipment & Capacity: Two level luffing cranes at Lascelles Wharf - Grabs up to 3,000 tonnes per shift and hooks 27.5 tonnes at 28m radius.  
Dry Bulk Loader at Corio Quay - 1,000 tpb capacity  
Bulk Berths: Corio Quay North No 1 & No 2 berths  
Length 375m, Draught 10.4m  
Lascelles Wharf No 1 Berth  
Length 185m, Draught 11.6 m  
Lascelles Wharf Nos 2 & 3 Berths  
Length 436m, Draught 11.6m  
Total uncovered Storage: 20,000sqm  
Total covered Storage: 15,500sqm

## Geraldton

### Geraldton Port Authority

289 Marine Terrace  
PO Box 1856  
Geraldton  
WA  
6531  
Australia  
Contact: Mr Martin North  
Harbour Master  
T: + 61 8 9964 0547  
F: + 61 8 9964 0555  
E: martin.north@gpa.wa.gov.au  
W: www.gpa.wa.gov.au  
Location: North West Coast of Australia. Approximately 200nm North of Fremantle.

## Gladstone

### Gladstone Ports Corporation

PO Box 259  
Gladstone  
Queensland  
4680  
Australia  
Contact: Mr Ian Drury  
Port Planning and Development GM  
T: + 61 7 4976 1333  
F: + 61 7 4972 2419  
E: druryi@gppl.com.au  
W: www.gppl.com.au

## Gladstone

Gladstone Ports Corporation  
Central Queensland Ports Authority  
PO Box 259  
Gladstone  
Queensland

QLD 4680  
Australia  
Contact: Mr Leo Zussino  
Chief Executive Office  
T: + 61 7 4976 1333  
F: + 61 7 4972 3045  
E: illingdo@gpqi.com.au  
W: www.gpa.org.au

## Gladstone

**Grainco Queensland Gladstone Terminal Berth 2**  
Gladstone Port Authority  
19 Yaroon Street  
PO Box 259  
Gladstone  
Queensland  
4680  
Australia  
Contact: Mr Leo Zussino  
Chief Executive Officer  
T: + 61 7 4976 1333  
F: + 61 7 4972 3045  
E: info@gpa.org.au  
W: www.gpa.org.au

## Gladstone

**Barney Point Coal Terminal**  
Central Queensland Ports Authority  
PO Box 259  
Gladstone  
Queensland  
QLD 4680  
Australia  
Contact: Mr Peter O'Sullivan  
T: + 61 7 4976 1471  
F: + 61 7 4972 3045  
E: osullivanp@cqpa.com.au  
W: www.gpa.org.au

## Gladstone

**Central Queensland Ports Authority**  
PO Box 259  
Gladstone  
Queensland  
4680  
Australia  
Contact: Mr Leo Zussino  
CEO  
T: + 61 7 4976 1333  
F: + 61 7 4972 3045  
E: zussinol@cqpa.com.au  
W: www.cqpa.com.au

## Hastings

**Port of Hastings Authority**  
PO Box 129  
Hastings  
VIC 3915  
Australia  
Contact: Mr Richard Cox  
Harbour Master  
T: + 61 3 5979 5500  
F: + 61 3 5979 5555  
E: enquiries@portofhastings.vic.gov.au  
W: www.tollports.com.au

## Kooragang Island

**PWCS Kooragang Terminal**  
Curlew Street  
Kooragang Island  
New South Wales  
2304  
Australia  
Contact: Mr Hennie du Plooy  
Chief Executive Officer  
T: + 61 2 4907 2000  
F: + 61 2 4907 3000  
E: contact\_us@pwcs.com.au  
W: www.pwcs.com.au  
Location: Port of Newcastle, New South Wales, Australia.  
Equipment & Capacity: Carrington Terminal  
25 Mtpa capacity  
4 x Stackers  
4 x Reclaimers  
2 x Shiploaders  
Kooragang Terminal

120 Mtpa capacity  
6 x Stackers  
4 x Reclaimers  
3 x Shiploaders

## Kooragang Island

**Newcastle Coal Infrastructure Group**  
Locked Bag 6003  
Hunter Region Mail Centre  
Kooragang Island  
NSW  
2310  
Australia  
Contact: Mr Paul Beale  
General Manager  
T: + 61 2 4920 3900  
E: enquiries@ncig.com.au  
W: www.ncig.com.au

## Mackay

**Dalrymple Bay Coal Terminal (DBCT)**  
Martin Armstrong Drive  
Hay Point  
Mackay QLD  
4740  
Australia  
Contact: Mr Gavin Springorum  
Media & Corporate  
T: + 61 7 4943 5645  
F: + 61 7 4943 8466  
E: andrew.garratt@dbct.com.au  
W: www.dbct.com.au  
Location: Hay Point Mackay  
Queensland Australia  
Equipment & Capacity: Total Coal export 2004/05: 50,248,059.  
2x stackers: 5,500 - 6,000tph  
1x reclaimers: 3,300 - 4,200tph  
5x stacker reclaimers: 3,300 - 5,800tph  
3x shiploaders: 7,200 - 7,950 tph  
Bulk Berths: Berth 1: 662m (combined with B2), 17.9mLAT (depth)  
Berth 2: 662m (combined with B1), 18.4MLAT (depth)  
Berth 3: 250m, 18.8LAT (depth)  
Total uncovered Storage: up to 1.4Mt  
Total covered Storage: n/a  
n/a

## Mackay

**Hay Point Coal Terminal (HPCT)**  
Mail Service 283  
Mackay  
Queensland  
4740  
Australia  
Contact: Mr Russell Grech  
General Manager  
T: + 61 7 4943 5201  
F: + 61 7 4956 3421  
E: russell.c.grech@bmacoal.com  
W: www.pcq.com.au  
Port Authority: Ports Corporation  
Queensland Limited.

## Melbourne

**P & O Ports - Geelong**  
P O Box 4732  
Melbourne  
VIC  
3001  
Australia  
Contact: Mr Jonathan La Forge  
Manager  
T: + 61 3 9396 6430  
F: + 61 3 9396 6444  
E: jonathan.laforge@poports.com.au  
W: www.poports.com.au/

## Melbourne

**Port of Melbourne Corporation**  
GPO Box 261  
Melbourne  
VIC  
3001  
Australia  
Contact: Mr Stephen Bradford  
Chief Executive Officer

T: + 61 39 683 1386  
F: + 61 39 683 1385  
E: stephen.bradford@portofmelbourne.com.au  
W: www.portofmelbourne.com.au

## Newcastle

**Newcastle Port Corporation**  
6 Newcomen Street  
(PO Box 663)  
Newcastle  
New South Wales  
2300  
Australia  
Contact: Ms Tegan Betts  
Marketing Manager  
T: + 61 2 4985 8222  
F: + 61 2 4926 4596  
E: business@newportcorp.com.au  
W: www.newportcorp.com.au  
Location: East Coast of Australia 70 nautical miles north of Sydney.  
Equipment & Capacity: Variety of ship handling facilities including pneumatic grabs, ships grabs, berth gantry grabs, pipelines, belt loaders and ships cranes.  
Bulk Berths: 19 operational berths. 11 berths dedicated to general cargo, bulk, break bulk and project cargoes. 8 berths dedicated to coal.  
Total uncovered Storage: Large range of opportunities available  
Total covered Storage: Range of facilities available  
One of our core objectives is to facilitate trade growth and to ensure the best use of port facilities and infrastructure. Contact Business Development for more information on our capabilities.

## North Sydney

**Patrick Stevedores Operations Pty Limited**  
Level 6  
15 Blue Street  
North Sydney  
NSW 2060  
Australia  
Contact: Mr John Horan  
General Manager Contracts & Marketing  
T: + 61 2 8484 8110  
F: + 61 2 8484 8176  
E: j.horan@patrick.com.au  
W: www.patrick.com.au  
Location: Pan Australia  
Scope of business; container terminal operators, automotive and general stevedores, automotive PDI and distribution services, logistics providers and rail operator.

## Perth

**CBH Albany Grain Terminal**  
GPO Box L886  
Perth  
WA  
6842  
Australia  
Contact: Mr Will Piercy  
Terminal Manager  
T: + 61 8 9845 5555  
F: + 61 8 9841 8499  
E: info@cbh.com.au  
W: www.cbh.com.au

## Perth

**CBH Esperance Grain Terminal**  
GPO Box L886  
Perth  
WA  
6842  
Australia  
Contact: Mr Michael Colgan  
Terminal Manager  
T: + 61 8 9071 2302  
F: + 61 8 9071 4040  
E: info@cbh.com.au  
W: www.cbh.com.au

## Perth

**CBH Kwinana Grain Terminal**  
GPO Box L886  
Perth  
WA  
6842  
Australia  
Contact: Mr Justin Bayles  
Terminal Manager  
T: + 61 8 9591 5100  
F: + 61 8 9527 7938  
E: info@cbh.com.au  
W: www.cbh.com.au

## Perth

**CBH Geraldton Grain Terminal**  
GPO Box L886  
Perth  
WA  
6842  
Australia  
Contact: Mr Eric Cooper  
Terminal Manager  
T: + 61 8 9921 9499  
F: + 61 8 9921 7463  
E: info@cbh.com.au  
W: www.cbh.com.au

## Pinekenba

**Grainco Queensland Pinekenba Terminal**  
31 Soutter Street  
Pinekenba  
Queensland  
4008  
Australia  
T: + 61 7 638 2440  
F: + 61 7 638 2440  
E: enquiries@graincorp.com.au

## Port Adelaide

**Flinders Ports - Port Pirie**  
296 St Vincent Street  
Port Adelaide  
SA 5015  
Australia  
Contact: Mr P Hartmut  
Port Manager/Pilot  
T: + 61 8 8447 0611  
F: + 61 8 8447 0606  
E: flindersports@flindersports.com.au  
W: www.flindersports.com.au

## Port Hedland

**Port Hedland Port Authority**  
PO Box 2  
Port Hedland  
WA 6721  
Australia  
Contact: Ms Paige Carroll  
Executive Secretary  
T: + 61 8 9173 0011  
F: + 61 8 9173 0060  
E: paige.carroll@phpa.com.au  
W: www.phpa.com.au

## Port Kembla

**Port Kembla Port Corporation**  
PO Box 89  
Port Kembla  
New South Wales  
2505  
Australia  
Contact: Mr Ray Smith  
Manager Business Development  
T: + 61 2 4275 0113  
F: + 61 2 4274 0643  
E: rxs@portkembla.com.au  
W: www.portkembla.com.au  
Location: Port Kembla is located 80km south of Sydney on the East Coast of Australia.  
Equipment & Capacity: Berth 202: One 17 tonne luffing crane; one 500tph shiploader.  
Berth 109: Two 30 tonne luffing cranes  
No. 2 Discharge Berth: Two 15 tonne travelling transporter grab cranes-gross loading rate 500tph and one 35 tonne travelling transporter grab

crane-gross rate 1,000tph.  
Berth 102: Two gantry shiploaders-nominal loading rate 6,600tph  
Berth 101: One gantry shiploader-nominal loading rate 1m200tph hour.  
Bulk Berths: Outer Harbour: Berths 202,204 - 300m, 10.40m  
Berths 203,205 - 300m 9.40m  
Inner Harbour:  
Berth 113 - 192m, 11.0m  
Berth 109 - 220m, 12.20m  
Berth 112 - 278m, 12.80m  
Berth 111 - 310m, 15.75m  
Berths 105,106 - 510m, 16.00m  
Berth 107 - 290m, 12.3m  
Berth 104 - 200m, 12.3m  
Berth 104 (air draught 17m) - 233m, 15.10m  
Berth 102 (air draught 22.4m) - 300m, 16.25m  
Berth 101 (air draught 17.4m) - 215m, 11.60m  
Total uncovered Storage: 80 hectares  
Total covered Storage: 20,000sqm  
The Port is a major trade centre for coal, steel and grain. The Port is now the facility for all imported vehicles for NSW.

## Port Lincoln

**Flinders Ports P/L**  
PO Box 354  
Port Lincoln  
SA 5606  
Australia  
Contact: Captain Robert Cobban  
MNI  
Port Pilot  
T: + 61 886 823633 / 868 23723  
F: + 61 886 826725  
E: captrcobbb@ozemail.com.au  
W: www.flindersports.com.au  
Location: South Australia - Spencer Gulf  
Bulk Berths: Two with Depth 15 metres  
Pending bulk iron ore commodity handling from 2010.

## Port of Brisbane

**Port of Brisbane Pty Ltd**  
Locked Bag 1818  
Port of Brisbane  
Queensland  
4178  
Australia  
Contact: Trade Services Team  
T: + 61 7 3258 4888  
F: + 61 7 3258 4703  
E: info@portbris.com.au  
W: www.portbris.com.au  
Location: Australia, East Coast, Queensland, Brisbane  
Equipment & Capacity: Fisherman Islands Grain; grain loading - up to 2,200tph, woodchips loading - 1,000tph, sugar loading - 800tph, cottonseed loading - 600tph.  
Fisherman Islands Coal: coal loading - up to 3,000tph, received by rail - 2,500tph & cement clinker - receive hopper or self-unloading ships up to 2,000tph.  
Clinker Wharf: cement clinker - receive hopper with travelling grab crane bucket, discharge up to 400tph.  
Incitec Pivot North: bulk cargoes - loaded into three 50t hoppers using ship or mobile cranes.  
Pinekenba Bulk Terminal: Mobile gantry loader, load up to 1,200tph. Two import hoppers each 300tph. Direct to truck, silo, shed.  
Incitec Pivot South: bulk dry cargoes - fixed gantry ship loader, load 200tph.  
Sugar Terminal: sugar - mobile gantry loader, load 1,500tph.  
Bulk Berths: Fisherman Islands Grain: length 285m, draught 13m  
Fisherman Islands Coal: length 317m, draught 13.5m  
General Purpose : length 213m, draught 11.5m



Cement Australia: length 220m, draught 9.7m  
 Incitec Pivot North: length 210m, draught 10m  
 Pinkenba Bulk Terminal: length 360m, draught 10.4m  
 Total uncovered Storage: Fisherman Islands Coal - stockpile storage 900,000t  
 Fisherman Islands Grain Pads - 100,000t  
 Pinkenba Bulk Terminal - open area 25,000t  
 Total covered Storage: Fisherman Islands Grain: silo storage 60,000t, sugar/cottonseed shed 40,000t  
 Clinker Wharf: storage sheds 30,000t, 82,000t, 5,000t.  
 Incitec Pivot North: storage 50,000t.  
 Pinkenba Bulk Terminal: 80,000t, silo 62,000t, open area 25,000t  
 Fisherman Islands Grain: wharf use - grain, woodchips, sugar, cottonseed exports. Fisherman Islands Coal/Clinker wharf: wharf use - steaming coal exports. Used to discharge - bulk clinker, gypsum, slag imports.

**Portland**

**Vicgrain Portland Terminal**  
 Harbour Rd  
 Portland  
 Victoria  
 Australia  
 Contact: Ms Kate Phillips  
 Marketing Services  
 T: + 61 8 8762 4873  
 E: graincorpools@graincorp.com.au  
 W: www.graincorp.com.au

**Portland**

**Port of Portland Pty Ltd**  
 PO Box 292  
 Barton Place  
 Portland  
 VIC 3305  
 Australia  
 Contact: Mr Malcolm Geier  
 Business Development Manager  
 T: + 61 355 250900  
 F: + 61 355 217488  
 E: info@portofportland.com.au  
 W: www.portofportland.com.au  
 Location: Southwest Victoria, Australia.

**Seventeen Mile Rocks**

**Mitchell Ports**  
 112 Bluestone Circuit  
 Seventeen Mile Rocks  
 Queensland  
 4073  
 Australia  
 Contact: Mr Robert Thatcher  
 T: + 61 7 3722 7277  
 F: + 61 7 3722 7256  
 E: r.thatcher@mitchellgroup.net  
 W: www.mitchellgroup.net/

**Sydney**

**D P World - P & O Ports**  
 ANZ Office  
 Level 21, 400 George Street  
 Sydney  
 New South Wales  
 2000  
 Australia  
 Contact: Mr Ganesh Raj  
 Senior Vice President and  
 Managing Director  
 T: + 61 2 9270 8800  
 F: + 61 2 9270 8888  
 E: ganeshraj@dpworld.com  
 W: www.pports.com

**Sydney**

**Patrick the Australian Stevedore**  
 Level 8  
 309 Kent Street  
 Sydney

2000  
 Australia  
 Contact: Mr A Perkins  
 NSW Manager  
 T: + 61 2 9256 6700  
 F: + 61 2 9299 2020  
 E: info@patrick.com.au  
 W: www.patrick.com.au

**Tasmania**

**Tasmanian Ports Corporation (Tasports)**  
 GPO Box 202  
 Tasmania  
 7001  
 Australia  
 Contact: Mr Charles Scarafiotti  
 Executive Manager - Marketing  
 T: + 61 3 6222 6067  
 E: charles.scarafiotti@tasports.com.au  
 W: www.tasports.com.au

**Thevenard**

**Thevenard Port**  
 Ports Corp South Australia  
 Thevenard Road  
 Thevenard  
 SA  
 5690  
 Australia  
 Contact: Mr John Joubert  
 Port Manager  
 T: + 61 886 252617  
 F: + 61 886 253100  
 E: fiindersports@fiindersports.com.au

**Toowoomba**

**Grainco Queensland Fisherman Island Terminal**  
 PO Box 136  
 Toowoomba  
 Queensland  
 4350  
 Australia  
 Contact: Mr Leon MaGuire  
 General Manager  
 T: + 61 7 4632 9122  
 F: + 61 7 389 51034  
 E: enquiries@graincorp.com.au

**Townsville**

**Port of Townsville Limited**  
 PO Box 1031  
 Townsville  
 Queensland  
 4810  
 Australia  
 Contact: Mr Barry Holden  
 CEO  
 T: + 617 4781 1512  
 F: + 617 4781 1525  
 E: info@townsville-port.com.au  
 W: www.townsville-port.com.au  
 Location: (19 deg. 5'30"S. 146 deg. 52'E)  
 Port of Townsville is a breakwater harbour situated on the Queensland coast in Cleveland Bay.  
 Equipment & Capacity: Individual stevedoring companies have an extensive range of mobile cargo handling equipment including forklifts, tractors, trailers (container), loaders and earth-moving equipment.  
 Bulk Berths: Berth 1 is a dedicated bulk liquids wharf used exclusively by tankers for bulk oil, gas and sulphuric acid discharge and by all types of vessels for bunkering.  
 Berth 2 is used for unloading nickel ore, two gantry cranes can be equipped to unload ore from the vessel into hoppers to feed a conveyor system, which carries the ore into the load out site. The berth is leased to Xstrata who have licensed its use to Queensland Nickel.  
 Berth 3 is leased to Xstrata, and is operated and controlled by Northern Stevedoring Services Pty Ltd. Typical cargoes handled over this wharf

include: lead ingots, refined copper, nickel and zinc. Also used for containerised cargo, fertiliser imports and live cattle exports.  
 Berth 4 has a priority berthing arrangement with Cement Australia handling bulk cement imported from Gladstone. The berth also handles molasses, mineral products, and general cargo. The molasses pipeline to this berth is capable of loading up to 400tph.  
 Berth 7 is leased to Xstrata and supports a bulk shiploader for mineral concentrates and ores at the rate of 1,000tph, and fertiliser at 1,200tph. Mineral concentrates mined in north west Queensland are exported over this wharf.  
 Berth 8 is a general purpose berth handling molasses, fertiliser, refined mineral products, sulphur and general cargo.  
 Berth 9 has a priority berthing arrangement with Queensland Sugar, and is Australia's largest point of export of sugar. A bulk shiploader delivers sugar to carriers at the rate of 2,000tph.  
 The berth is equipped with bulk molasses and bunker pipelines.  
 Berth 10 is a general purpose berth and is to be extended to accommodate cruise and military vessels.  
 Berth 11 is known as the Outer Berth Mineral Concentrates Loading Facility. Lead and zinc concentrates are placed onto a conveyor system by front-end loader and transported to the 1,350tphour shiploader. The facility is owned by BHP Billiton Cannington.  
 Total uncovered Storage: Open storage space for Crude Load, Refined Copper, Zinc and other cargoes.  
 Total covered Storage: Raw Sugar: Two storage sheds of 285,000t total capacity, located adjacent to Berth 9. A third storage shed of 420,000t storage capacity opened for business in late 2003.  
 Molasses: Four bulk storage tanks of 60,000t total capacity located adjacent to Berth 4. Caustic Soda: One 5,000t storage tank, located adjacent to No. 4 wharf.  
 Concentrates: 170,000t covered storage area, located adjacent to No. 7 wharf (MIM).  
 40,000t covered storage area located in the Northern Balloon Loop (BHP).  
 Cement: One 30,000t bulk cement storage silo, located in the Eastern Port Development Area.  
 Chemicals: Two sulphuric acid storage tanks of 17,000t total capacity (1x5,000, 1x12,000t capacity), located in the Eastern Port Development Area.  
 Fertilizer: One 90,000t covered storage shed, located in the Eastern Port Development Area.  
 Sulphur: One 10,000t covered storage shed, located in the Eastern Port Development Area.  
 Port of Townsville is a gateway to global trade and investment and the nexus of Australia's booming North Queensland region.  
 Port of Townsville Limited is a statutory Government owned corporation.

F: + 61 2 9296 4742  
 E: enquiries@sportsports.com.au  
 W: www.sportsports.com.au

**West Perth**

**Co-Operative Bulk Handling Ltd**  
 Gayfer House  
 30 Delhi Street  
 West Perth  
 WA  
 6005  
 Australia  
 Contact: Ms Claire Armstrong  
 Marketing  
 T: + 61 8 9237 9600  
 F: + 61 8 9322 3942  
 E: info@cbh.com.au  
 W: www.cbh.com.au

**Wollongong**

**Port Kembla Grain Terminal - GrainCorp Operations Limited**  
 PO Box 1029  
 Wollongong  
 NSW  
 2500  
 Australia  
 Contact: Mr Mark Jelbart  
 Manager  
 T: + 61 4 224 6400  
 F: + 61 4 224 6466  
 E: mjelbart@graincorp.com.au  
 W: www.graincorp.com.au

**Wollongong**

**Port Kembla Coal Terminal Limited**  
 Port Kembla Road  
 Wollongong  
 New South Wales  
 NSW 2520  
 Australia  
 Contact: Mr Peter Green  
 General Manager  
 T: + 61 2 4228 0288  
 F: + 61 2 4228 7605  
 E: peter.green@pkct.com.au  
 W: www.pkct.com.au  
 Location: Located in the southern major port of New South Wales in Australia.  
 (72 km south of Sydney)  
 Equipment & Capacity: COAL FACILITY Rail dump station, road dump station, receipt conveyors capacity 4400tph, 3 Stackers, stockyard, 2 Reclaimers, shiploading conveyors capacity 6600tph, 2 Shiploaders  
 BULK PRODUCTS FACILITY road dump station, screening plant ,conveyor system 1000tph, 1shiploader, unload conveyor for self discharging ships  
 Bulk Berths: Coal Berth length 250m, 16.25m alongside  
 Bulk Products berth 215m, 11.6m depth alongside  
 Approach channel 15.25m plus tide  
 Total uncovered Storage: Coal stockyard 850,000sqm  
 Bulk Products stockyard 250,000sqm  
 Total covered Storage: None  
 Port Kembla Coal Terminal serves the Southern and Western coalfields of New South Wales Australia and has an annual capacity modelled at some 18 million tonnes.

**Wollongong**

**Wyndham**

**CGL Wyndham Port**  
 PO Box 186  
 1 Wharf Road  
 Wyndham  
 Western Australia  
 WA 6740  
 Australia  
 Contact: Mr Steve Forrest  
 Wharf Manager  
 T: + 61 891 611 203  
 F: + 61 891 611 244  
 E: ordport@wn.com.au

Location: Far North, Kimberley Region, Western Australia  
 Contact us for more information.

**Wynnum Central**

**Patrick Stevedores**  
 PO Box 734  
 Wynnum Central  
 QLD 4178  
 Australia  
 Contact: Mr Matt Hollamby  
 Queensland Manager  
 T: + 61 7 3893 8555  
 F: + 61 7 3895 1534  
 E: m.hollamby@patrick.com.au  
 W: http://www.patrick.com.au

**AZORES**

**Ponta Delgada**

**Port Authority of Ponta Delgada**  
 Rua Teofilo Braga 1  
 Ponta Delgada  
 Sao Miguel  
 9500  
 Azores  
 Contact: Mr Luis Brandao  
 Port Director  
 T: + 351 962 5221  
 F: + 351 962 3390  
 E: apsm@apsm.pt  
 W: www.apsm.pt

**BAHAMAS**

**Freeport**

**Grand Bahama Port Authority**  
 PO Box 42666  
 Freeport  
 33114  
 Bahamas  
 Contact: Mr Felix N Stubbs  
 Chairman  
 T: + 1242 352-6611  
 F: + 1242 352-6184  
 E: fstubbs@gbpa.com  
 W: www.gbpa.com

**BAHRAIN**

**Manama**

**Mina Salman Port Authority**  
 Customs and Ports Authority  
 PO Box 15  
 Manama  
 Bahrain  
 Contact: Mr J S Kendrick  
 T: +973 72 5555  
 F: + 973 1772 5534  
 W: www.bahrainport.gov.com

**BANGLADESH**

**Chittagong**

**Chittagong Port Authority**  
 PO Box 2013  
 Bandar Bhaban  
 Chittagong  
 4100  
 Bangladesh  
 Contact: Mr Zulfrigar Ali  
 Commodore  
 T: + 880 31 7419 8090  
 F: + 880 31 710593  
 E: cmancpa@globalctg.net  
 W: www.cpabd.com

**BARBADOS**

**Bridgetown**

**Barbados Port Authority**  
 University Row  
 Princess Alice Highway  
 Bridgetown  
 Barbados

Coaltrans Conferences presents

13th Annual

# Coaltrans USA

January 31 & February 1, 2013  
Four Seasons Miami, Florida, USA

[www.coaltrans.com/usa](http://www.coaltrans.com/usa)



**Coaltrans**  
Conferences

**Hear from**

**Kevin Crutchfield**  
Chairman & CEO  
**Alpha Natural Resources**

**John Eaves**  
President  
**Arch Coal**

**Michael Beyer**  
CEO  
**Foresight Energy**

**Fred Palmer**  
Senior Vice President,  
Government Relations  
**Peabody Energy**

**Ernie Thrasher**  
CEO & Chief  
Marketing Officer  
**Xcoal Energy & Resources**

## Key Topics to be discussed:

- **A fuel displaced?** The impact of natural gas on demand for U.S. coal
- **Coal and politics:** What will the impact of November's election results be on America's coal industry?
- **Looking overseas:** Exploring the future of U.S. coal exports and potential infrastructure expansion
- **Production updates:** Which basins have the most competitive margins and where is demand coming from?

### Platinum Sponsor



### Silver Sponsors



**United Bulk Terminals**

### Bronze Sponsors



**ambreenergy**

**ERNST & YOUNG**  
Quality In Everything We Do



**For more information contact Dianne Bussell:**

**Tel: +44 (0)20 7779 8573 Fax: +44 (0)20 7779 8946**

**Email: [dbussell@euromoneyplc.com](mailto:dbussell@euromoneyplc.com) [www.coaltrans.com/usa](http://www.coaltrans.com/usa)**

"The ability to hear from so many industry experts at one event is priceless!"

**Grant McHenry,**  
**LogiCamms**  
(Previous Coaltrans Delegate)



Contact: Mr Richard Alleyne  
Harbour Master  
T: + 1 246 430 4700  
F: + 1 246 429 5348  
E: administrator@barbadosport.com  
W: www.barbadosport.com

**BELGIUM**

**Antwerpen**

**Alfaport Antwerpen**  
Brouwersvliet 33  
Post Bus 8  
Antwerpen B-2000  
Belgium  
Contact: Mr Rudi de Meyer  
Managing Director  
T: + 32 3 206 7381  
F: + 32 3 231 6728  
E: info@alfaportantwerpen.be  
W: www.alfaportantwerpen.be

**Antwerpen**

**Boortmalt Group**  
Zantvoort 2  
Haven 350  
Antwerpen B-2030  
Belgium  
Contact: Mr Yvan Schaepean  
CEO  
T: + 32 3 545 0411  
F: + 32 3 542 0582  
E: info@boortmalt.com  
W: www.boortmalt.com

**Antwerpen**

**Euroports Belgium NV**  
Atlantic House - 3rd floor  
Noorderlaan 147  
Antwerpen  
2030  
Belgium  
Contact: Mr Wim Leuyckx  
Commercial Director  
T: + 32 3 204 9300  
F: + 32 3 204 93 01  
E: info@euroports.com  
W: www.manuportgroup.com

**Antwerpen**

**SCR - Sibelco**  
Quellinstraat 49  
Antwerpen  
BE - 2018  
Belgium  
Contact: Ms. Laurence Boens  
T: + 32 3 2236658  
E: info@sibelco.com  
W: www.sibelco.be

**Antwerpen**

**Antwerp Bulk Terminal (ABT)**  
**SEA - invest**  
Haven 750, Delwaidedok  
Nieuwe Westweg 14  
Antwerpen  
B-2040  
Belgium  
Contact: Mr Michel Moons  
Manager ABT  
T: + 32 9 255 02 51  
F: + 32 9 259 08 94  
E: michel.moons@sea-invest.be  
W: www.sea-invest.com  
Location: Port of Antwerp  
Equipment & Capacity: 2 x 50t gantry  
1x 25t gantry  
3 x 40t mobile  
1 x 50t mobile  
2 x 40t mobile  
Bulk Berths: Antwerp: Delwaidedok,  
Leopolddok, Amerikadok, 6de  
Havendok  
Total uncovered Storage: 110 ha  
Total covered Storage: 130,000sqm

**Antwerpen**

**Noord Natie Terminal**  
Haven 227 - 243

Blauwe Weg 44  
Antwerpen  
2030  
Belgium  
Contact: Ms M Teeuwens  
Commercial Manager  
T: +32 3 543 99 00  
F: + 32 3233 39 38  
E: teeuwens.m@noordnatie.be  
W: www.noordnatie.be

**Antwerpen**

**Antwerp Port Authority**  
Havenhuis  
Entrepotkaai 1  
Antwerpen  
2000  
Belgium  
Contact: Mr Xavier van Rollegem  
Business Development Manager  
T: + 32 3 205 2051  
F: + 32 3 205 2269  
E: xavier.vanrollegem@  
haven.antwerpen.be  
W: www.portofantwerp.com  
Location: Antwerp is located in  
Northwest Europe. It is the second  
largest city in Belgium.  
Equipment & Capacity: 146 Electric  
shore cranes (from 2-5t lift to 51-  
100t), 37 ship loading installations, 3  
floating cranes and derricks, 9  
gantries for bulk goods (5t, 35t, 50t),  
14 grain elevators. 78 mobile cranes.  
Bulk Berths: The major bulk terminals  
have a total quay length of 3.8 km, of  
which 1,800 m cape size and 2.2 km  
panamax. In case of simultaneous  
arrivals it is possible to divert  
capesize or panamax vessels to  
different terminals in order to avoid  
delays.  
Total covered Storage: 4.800.000 sqm  
We have specialised terminals for all  
kind of goods.

**Brugge**

**Firma Germain D'Hoore -  
Ostende**  
Vaartdijkstraat 76  
Brugge  
8200  
Belgium  
Contact: Mr H D'Hoore  
Managing Director  
T: + 32 50 384 506  
F: + 32 50 384 851

**Gent**

**Ghent Coal Terminal NV - GCT**  
Skaldenstraat 1  
Gent  
9042  
Belgium  
Contact: Mr Bart Laureys  
T: + 32 9 255 02 11  
F: + 32 9 259 08 94  
E: Bart.Laureys@sea-invest.be  
W: www.sea-invest.com  
Location: Alongside the sea canal in  
the Port of Ghent at berth 2320.  
Equipment & Capacity: 2\*25 metric  
tons cranes + 1 ship's belt loader.  
Bulk Berths: Draught 12.5m (FW)  
Total uncovered Storage: About  
70,000 m2  
Total covered Storage: About 40,000  
m2  
GCT is the biggest solid fuel terminal  
in Belgium with open air and covered  
storage facilities, equipped with  
several screening, crushing, blending  
and drying installations.

**Gent**

**Euro-Silo NV**  
Zeehaven-Oost  
Alphonse Sifferdok  
J F Kennedylaan 19  
Gent  
B9000  
Belgium

Contact: Mr Daniel Matthys  
Managing Director  
T: + 32 9 345 96 11  
F: + 32 9 251 6074  
E: daniel.matthys@euro-silo.be  
W: www.euro-silo.com

**Gent**

**Mekol**  
Henri Farmanstraat 47  
Gent  
East Flanders  
9000  
Belgium  
Contact: Mr Edvin Gogol  
Director  
T: + 32 9 251 08 12  
F: + 32 9 251 76 41  
E: edvin.gogol@rwe.com

**Gent**

**Arcelor Steel Belgium NV**  
Arcelor Gent  
John Kennedylaan 51  
Gent  
9042  
Belgium  
Contact: Mr Koen De Coster  
Maintenance manager railway and  
locomotives  
T: + 32 9347 2670  
F: + 32 9347 4916  
E: info.sidmar@arcelormittal.com  
W: www.sidmar.be

**Gent**

**Ensagent NV**  
Skaldenstraat 1  
Gent  
9042  
Belgium  
Contact: Mr. Tom Zirrick  
Planning Manager  
T: + 32 9 255 02 11  
F: + 32 9 259 08 93  
E: info@sea-invest.be  
W: http://www.sea-invest.com/

**Gent**

**Reyniers Havenbedrijf NV**  
Stapelplein 38  
Gent  
9000  
Belgium  
Contact: Ms Jo van der Hert  
Marketing & Communications  
T: + 32 32 04 95 00  
F: + 32 32 04 93 01  
E: j.vanderherten@euroports.com  
W: www.manuportgroup.com

**Gent**

**Ghent Port Company amp**  
John Kennedylaan 32  
Gent  
B-9042  
Belgium  
Contact: Mr Johan Bresseleers  
Directorate General  
T: + 32 9 251 0550  
F: + 32 9 251 5406  
E: Johan.bresseleers@havengent.be  
W: www.portofghent.be  
Location: West Europe  
Equipment & Capacity: No own port  
cranes - cranes belong to private port  
companies  
Ghent is a modern and versatile  
medium-sized port situated in the  
centre of the Hamburg/Le Havre  
range, having an average water-borne  
cargo traffic of some 48 million tons,  
27,3 of which are transported  
overseas and 20.7 million tons by  
inland waterway.

**Gent**

**Stukwerkers Havenbedrijf NV**  
Port Arthurlaan 40  
Gent  
B - 9000

Belgium  
Contact: Mr Johan De Raeye  
Managing Director  
T: + 32 9 251 25 45  
F: + 32 9 251 61 81  
E: johan.deraeye@stukwerkers.com  
W: www.stukwerkers.com  
Location: Port of Ghent/Belgium  
Equipment & Capacity: 2 mobile  
harbour cranes of 100 tonnes  
capacity  
2 mobile harbour cranes of 63 tonnes  
capacity  
1 mobile crane of 25 tonnes capacity  
Bulk Berths: Sifferdock 830 - 840  
Sifferdock 1,000  
Grootdok 290 - 360  
Total quay length 3.5 km  
Total uncovered Storage: 150,000sqm  
Total covered Storage: 140,000sqm

**Gent**

**Manuport NV**  
178 Port Arthurlaan  
Gent  
9000  
Belgium  
Contact: Mr Bins  
T: + 32 32049 318  
F: + 32 9 218 2508  
E: wim.leuyckx@euroports.com

**Gent**

**Ghent Transport & Storage**  
Henri Farmanstraat 41  
Middendok-Noordkaai 0610-0620  
Gent  
9000  
Belgium  
Contact: Mr Yves Bienfet  
General Manager/Director  
T: + 32 9 250 5658  
F: + 32 9 251 10 52  
E: y.bienfet@gtsgent.be  
W: www.gtsgent.be  
Location: Middendok terminals 0600-  
0620  
Kluizendok terminals 7110 -7140  
Equipment & Capacity: 2 cranes :  
Liebherr, Sennebogen full panamax  
Bulk Berths: Water Depth: 13m  
Quay length: 8m  
Middendok terminal quay 0600-0620:  
300m  
Kluizendok terminals quay 7110-7140:  
500m quays  
Total uncovered Storage: 20,000sqm  
Total covered Storage: 67,000sqm

**Kallo**

**Belgian Scrap Terminal NV**  
Land van Waaslaan 1123  
Kallo  
Belgium  
Contact: Ms Sofie Van Peteghem  
T: +32 3575 0575  
F: +32 3575 1370  
E: info@belgianscrap.com  
W: www.belgianscrapterminal.com/

**Kallo**

**Metal Terminals International  
(MTI)**  
Land van Waaslaan  
Kaai 1207  
Kallo  
B-9130  
Belgium  
Contact: Mr Fritz Lippens  
General Manager  
T: + 32 3570 9670  
F: + 32 3570 9671  
E: mti@gearbulk.com  
W: www.mtiterminals.com  
Location: Port of Antwerp - Left Bank  
Equipment & Capacity: 4 x mobile  
crane 100 mt SWL  
Bulk Berths: 2km berth. Draught  
12.5m  
Total uncovered Storage: 250,000sqm  
Total covered Storage: 56,000sqm  
LME-accredited. Forwarding &

distribution services.

**Liege**  
**Terval S.A.**  
Ile Monsin, Route 10  
Liege  
B-4020  
Belgium  
Contact: Mr Dirk Schmidt-Holzmann  
Administrator  
T: + 32 4256 9340  
F: + 32 4264 0835  
E: dsh@terval.com  
W: www.terval.com

**Liege**

**Liege Port Authority**  
Quai de Maestricht 14  
Liege  
4000  
Belgium  
Contact: Mr Emile-Louis Bertrand  
Managing Director  
T: + 32 42 32 97 97  
F: + 32 4 223 11 09  
E: portdeliege@skynet.be  
W: www.portdeliege.be  
Location: Accessible via river Scheldt  
and Albert Canal (only at 14h  
navigation from Port of Antwerp)  
Equipment & Capacity: 102 cranes,  
max. 50t  
Bulk Berths: 26km  
Total uncovered Storage: 366  
hectares  
Total covered Storage: 150,000sqm

**Oostende**

**Ter Polder**  
Zwaaidok 2  
Oostende  
B-8400  
Belgium  
Contact: Mr Steven Verhelst  
Shipping Manager  
T: + 32 59 331 133  
F: + 32 59 331 433  
E: steven.verhelst@verhelst.be  
W: www.verhelstlogistics.be  
Location: Ostend, Belgium  
Equipment & Capacity: Cranes up to  
250t  
Bulk Berths: Length 120m/ Draught  
6.8m  
Total uncovered Storage: 30,500sqm  
Total covered Storage: 38,000sqm

**Puurs**

**SMEG Belgium NV**  
Schoonmansveld 12  
Puurs  
2870  
Belgium  
Contact: Mrs Ann Smedt  
Marketing  
T: +32 03 860 96 96  
F: + 32 03 886 0666  
E: ann.de.smedt@smeg.be  
W: www.smeg.com

**Roeselare**

**Van Eeckhout**  
**Vervoermaatschappij**  
Trakelweg 60  
Roeselare  
8800  
Belgium  
Contact: Mr Francis Eeckhout  
Port Director  
T: + 32 51 207313  
F: + 32 51 241310  
E: francis@vmcm.be

**Seraing**

**CTB Logistics SA**  
Rue du Pont du Val  
Seraing  
B-4100  
Belgium  
Contact: Ms Muriel Merthiers  
T: + 32 4330 1713

F: + 32 4337 1008  
W: www.ctblogistics.com  
Location: Belgium - Liepe, Charleroi  
Equipment & Capacity: 9 cranes  
Total uncovered Storage: 200,000sqm  
Total covered Storage: 95,000sqm

## Zeebrugge

### Zeebrugge Behandelings

**Maatschappij**  
Skaldenstraat 1  
Zeebrugge  
Gent  
9042  
Belgium  
Contact: Mr Philippe Van de Vyvere  
Manager  
T: + 32 50 544 095  
F: + 32 50 546 601

## Zeebrugge

### Devreese & Simon NV

Lanceloot Blondellaan 1  
Zeebrugge  
8380  
Belgium  
General Manager  
T: + 32 50 54 40 04  
F: + 32 50 54 43 21

## BENIN

### Cotonou

#### Port Autonome de Cotonou

PO Box 927  
Cotonou  
Benin  
Contact: Ms Issa Badarou  
General Manager  
T: + 229 21 312890 / 21 31 52 80  
F: + 229 312891  
E: pac@leland.bj  
W: www.portdecotonou.com

## BERMUDA

### Hamilton

#### Department Marine & Port Services

PO Box HM 180  
Hamilton  
HM AX  
Bermuda  
Contact: Mr David Simmons  
Harbour Master  
T: + 1 441 295 6575  
F: + 1 441 295 5523  
E: dcsimmons@gov.bm

## BRAZIL

### Anchieta

#### Port Authority of Ponta Uba

Rodovia do Sol s/n  
Anchieta  
ES 29230-000  
Brazil  
Contact: Mr E Drummond  
Manager  
T: + 55 27 3361 9000  
F: + 55 27 3361 9474  
E: portodeubu@samarco.com.br  
W: www.portodeubu.com.br

### Angra dos Reis

#### Port of Angra dos Reis

Avenida dos Reis Magos, s/n  
Angra dos Reis  
Rio de Janeiro  
RJ 23900-000  
Brazil  
Contact: Mr Fernando Mauricio de  
Lima Cavalcanti  
Manager  
T: + 55 24 2365 0273  
F: + 55 24 2365 0273  
W: www.portosrio.gov.br

### Aracruz

#### Portocel-Terminal Especializado de Barra do Riacho

Caminho da Barra do Riacho S/N  
Aracruz  
Barra do Riacho  
29197-900  
Brazil  
Contact: Mrs Patricia Dutra  
Lascosque  
Director  
T: + 55 27 3270 4444  
F: + 55 27 3270 4433  
E: msc@portocel.com.br  
W: www.portocel.com.br  
Location: Barra do Riacho, North  
Coast of Espírito Santo state.  
Bulk Berths: Max draught 11.90m  
(With tide 1.60m high)  
Max length: 213.99m  
Max beam: 35m  
Max 50,000 dwt  
Total covered Storage: - Armazém 1 =  
13.500 m2 - 51.485 T  
- Armazém 2 = 12.096 m2 - 45.153 T  
- Armazém 3 = 14.352 m2 - 55.072 T  
- Armazém 6 = 16.848 m2 - 71.842 T  
Portocel is the only port in Brazil  
which is specialized in the handling of  
forest products (woodpulp and logs). It  
belongs to two of the biggest  
woodpulp producers in Brazil, Aracruz  
(51%) and Cenibra (49%).

### Baia de Aratu

#### Port of Aratu

ADB Nordeste Terminal  
Companhia das Docas do Estado  
da Bahia (CODEBA)  
Via Matoim, s/n  
Baia de Aratu  
CEP 43.800-000  
Brazil  
Contact: Dr Osvaldo C Magalhaes  
T: + 55 71 602 5711  
F: + 55 71 602 5705  
E: portoaratu@codeba.com.br  
W: www.codeba.com.br

### Belem

#### Port Authority of Para

Avenida Presidente Vargas  
41-2 Andar  
Belem  
CEP 66010-000  
Brazil  
Contact: Mr Carlos Acatauassu  
Nunes  
Director-President  
T: + 55 91 3182 9000  
F: + 55 91 241 1741  
E: nunes@cdp.com.br  
W: www.cdp.com.br

### Belem

#### Port of Belem

Companhia Docas do Para -  
Autoridade Portuaria  
Endereço Av. Marechal Hermes s/n  
Cais do Porto  
Belem  
Para  
CEP 66010-000  
Brazil  
T: + 55 91 3216 2129  
F: + 55 91 3216 2130  
W: www.cdp.com.br

### Fortaleza

#### Port of Fortaleza

Praca Amigos da Marinha  
Esplanada do Mucuripe  
Fortaleza  
CE  
60 000  
Brazil  
Contact: Mr Livio Silva de France  
Director  
T: + 55 85 263 2267  
F: + 55 85 266 5241  
E: docasdoceara@  
docasdoceara.com.br

W: www.docasdoceara.com.br

### Ilheus

#### Port of Ilheus

Companhia das Docas do Estado  
da Bahia (CODEBA)  
Rua Rotary, s/n  
Cidade Nova  
Ilheus  
Bahia  
CEP 45.650-000  
Brazil  
Contact: Mr Ronaldo Lavinha  
Port Manager  
T: + 55 73 231-1200  
F: + 55 73 231-3318  
E: portoilheus@codeba.com.br  
W: www.codeba.com.br

### Imbituba

#### Imbituba Port Authority

Av Getulio Vargas  
No 100  
Imbituba  
Santa Catarina  
88780-000  
Brazil  
Contact: Mr G B da Costa Pereira  
Port Manager  
T: + 55 48 3255 0080  
F: + 55 48 3255 0701  
E: docas@cdiport.com.br  
W: www.cdiport.com.br

### Itaguaí

#### CSN - Terminal de Carvão e

#### Minério TECAR

Estrada da Ilha da Madeira  
s/no, Porto de Itaguaí  
Ilha de Madeira  
Itaguaí  
Rio de Janeiro  
23826-600  
Brazil  
Contact: Mr Guilherme Moretzsohn  
Andrade  
Tecar Operations Manager  
T: + 55 21 2688 9338  
F: + 55 21 2688 9209  
E: guilherme.moretzsohn@csn.com.br  
W: www.csn.com.br/tecar

### Jaragua

#### Port of Maceio

Rua Sa de Albuquerque  
Jaragua  
Maceio  
Alagoa 57000  
Brazil  
Contact: Mr Dominic Silva  
Administrator  
T: + 55 82 231 1999/1790  
F: + 55 82 231 2975  
E: dominico@portodemaceio.com.br  
W: www.portodemaceio.com.br

### Manaus

#### Port of Manaus

Rua Marques de Santa Cruz,  
Centro  
Manaus  
Amazonas  
AM 69005 050  
Brazil  
Contact: Mr Nelson Pedro de  
Aguilar Falcao  
Port Administrator  
T: + 55 92 2123 4350  
F: + 55 92 2123 4360  
E: alecom@portodemanau.com.br  
W: www.portodemanau.com.br

### Município de Oriximiná

#### Trombetas Port

Mineração Rio de Norte -  
Porto Trombetas  
Município de Oriximiná  
Pará State  
68275-000  
Brazil  
Contact: Mr Ricardo Sarmento

Port Manager

T: + 55 93 549 7029  
F: + 55 93 549 1482  
E: ricardos@mrm.com.br  
W: www.mrm.com.br  
Location: Lat. 01°27'36"S / Long.  
56°22'47"W  
Situated on the right bank of  
Trombetas River, state of Para, north  
region of Brazil.  
Equipment & Capacity: One  
Shiploader  
Capacity - 6,000tph  
Bulk Berths: One Pier - 101m length  
Draught - 38 feet maximum  
Total uncovered Storage: 36,000sqm  
Total covered Storage: 8,000sqm  
Due to restrictions for navigation on  
Trombetas River bends, the vessels  
are limited for Panamax Size up to  
260m LOA.

### Natal

#### Natal Port Authority

Avenida Hildebrando de Goes  
Ribeira  
Natal  
Rio Grande do Norte  
CEP 59000  
Brazil  
Contact: Mr Ivan Reis de Lima  
Administrator  
T: + 55 84 211 5311  
F: + 55 84 221 6072  
E: codmkt@zaz.com.br  
W: www.codern.com.br

### Niteroi

#### Port of Noiteroi

Avenida Feliciano Sodre 215  
Niteroi  
RJ  
24030  
Brazil  
Contact: Mr Antonio Manne  
Manager  
T: + 55 21 718 3182  
E: gemit@portosrio.gov.br  
W: www.portosrio.gov.br/niteroi/  
Nitpor.htm

### Para State

#### Port Authority of Vila Do Conde

Companhia Docas do Port Vila do  
Conde  
Para State  
Brazil  
Contact: Mr Carlos Edir  
Port Supervisor  
T: + 55 91 3754 1027  
F: + 55 91 3754 1026  
E: edir@cdp.com.br

### Paranagua

#### PFT-Paranaguá Forestry

**Terminals**  
Rua Professor Cleto, 1372  
Leblon  
Paranagua  
Parana  
83203-070  
Brazil  
Contact: Mr Fernando Drevnovicz  
T: + 55 41 3420 1900  
F: + 55 41 3420 1903  
E: pftcom@pft-terminals.com.br  
W: www.gearbulk.com

### Paranagua

#### Port Silo/Socopar Berths 1/2;

#### Gransol Berth 3

Administracao dos Ports de  
Paranagua e Antonnia  
(Port Authority)  
Centro Administrative Taguare  
Paranagua  
Brazil  
Contact: Mr Osiris Stenghel  
Guimares  
Port Superintendent  
T: + 55 41 420 1100

F: + 55 41 422 5324  
E: portos@pr.gov.br  
W: www.portodeparanagua.pr.gov.br

### Paranagua

#### Paranagua Port Authority

Rua Antonio Pereira, 161  
Paranagua  
PR  
83221-030  
Brazil  
T: + 55 14 1420 1100  
F: + 55 14 1422 5324  
E: portos@pr.gov.br  
W: www.portosdoparana.pr.gov.br

### Pelotas

#### Port of Pelotas

Rua Conde de Porto Algre 1  
Pelotas  
RS 96010-290  
Brazil  
Contact: Mr Jose Fernando  
Marques Ripoll  
Harbour Manager  
T: + 55 53 278 7263  
F: + 55 53 278 7333  
E: portopel@sph.rs.gov.br  
W: www.portopelotas.rs.gov.br/

### Porto Alegre

#### Port of Porto Alegre

Administracao do Porto de Porto  
Alegre  
Av Maua 1050 Centro  
Porto Alegre  
RS 90010-110  
Brazil  
Contact: Mr Paulo Elizeu Ody  
Port Administrator  
T: + 55 51 3211 5022  
F: + 55 51 3211 5033

### Recife

#### Port of Recife

Praça Comunidade Luso Brasileira  
no 70  
Bairro do Recife  
Recife  
PE  
50030-280  
Brazil  
Contact: Mr Luiz Roberto Trindade  
Lobato  
Port Director  
T: + 55 81 3419 1900  
F: + 55 81 3224 2848  
E: portodorecife@  
portodorecife.pe.gov.br  
W: www.portodorecife.pe.gov.br

### Rio de Janeiro

#### Cia Docas Do Rio de Janeiro

Porto do Rio de Janeiro  
Av Rodrigues Alves No 20-40  
Rio de Janeiro  
CEP  
20 080 000  
Brazil  
Contact: Mr Adacio CP Carvalho  
Port Manager  
T: + 55 21 2219-8617 /00  
F: + 55 21 2219-8618  
E: asscom@portosrio.gov.br

### Rio de Janeiro

#### Port of Forno

Rua Santa Cruz No 100  
Arriai do Cabo  
Rio de Janeiro  
28930-000  
Brazil  
Contact: Mr Marcos Nau  
Manager  
T: + 55 21 246 221185  
F: + 55 21 246 221185  
E: portodoforno@mar.com.br



**Rio de Janeiro**

**Rio de Janeiro Port Authority**  
 Rua Acre 21  
 Rio de Janeiro  
 20081  
 Brazil  
 Contact: Mr A R Menezes  
 President  
 T: + 55 21 2219 9542  
 E: suprio@portosrio.gov.br  
 W: www.portosrio.gov.br

**Rio de Janeiro**

**Petroleo Brasileiro SA-Petrobras**  
 Avenida Republica do Chile  
 65 Centro  
 Rio de Janeiro  
 RJ  
 20035  
 Brazil  
 Contact: Mr Luis Fernando Maya  
 Marketing Department  
 T: + 55 21 3224 1510  
 F: + 55 21 2262 3678  
 W: www.petrobras.com.br

**Rio de Janeiro**

**Companhia Portuaria Baia de Sepetiba**  
 Rua Rodrigo Silver 26  
 S2 201 Duplex Parte  
 Rio de Janeiro  
 CEP 2001  
 Brazil  
 Contact: Mr Gustavo L'Huillier  
 T: + 55 21 2688 1424  
 F: + 55 21 2688 1287

**Rio Grande**

**Bianchini Terminal**  
 Grain Terminal  
 Avenida Almirante Maximian da Fonseca  
 Sector 6 Industrial District  
 Rio Grande  
 RS  
 96204-040  
 Brazil  
 Contact: Mr Carlos (CB) Bacchieri  
 Terminal Manager  
 T: + 55 53 2126 6000  
 F: + 55 53 2126 6011  
 E: cb@bianchini-rg.com.br  
 W: www.bianchinisa.com.br

**Rio Grande**

**Port of Rio Grande**  
 Avenida Honrio Bicalho s/n  
 Edificio Deprec  
 Rio Grande  
 RS 96200  
 Brazil  
 Contact: Mr Newton Kuintas  
 T: + 55 53 3231 1366  
 E: nkuintas@portoriogrande.com.br  
 W: www.portoriogrande.com.br

**Salvador**

**Port Authority of Salvador**  
 Companhia das Docas do Estado da Bahia  
 Av. da Franca, 155 I, Comercio  
 Salvador  
 Bahia  
 CEP 40.010-000  
 Brazil  
 Port Director  
 T: + 55 71 320 1299  
 F: + 55 71 320 1268  
 E: portosalvador@codeba.com.br  
 W: www.codeba.com.br

**Santos**

**Companhia Docas do Estado de São Paulo - CODESP**  
 Avenida Conselheiro Rodrigues Alves, s/nº - Macuco  
 Santos  
 São Paulo  
 CEP 11015-900

Brazil  
 Contact: Mr José Di Bella Filho  
 Director-President  
 T: + 55 13 3222 5485  
 F: + 55 13 3222 3068  
 E: dj\_bella@uol.com.br  
 W: www.portodesantos.com.br  
 Location: Southeast coast of Brazil in the State of São Paulo  
 Equipment & Capacity: The Santos Port static capacity is 110 million tonnes. For dry bulk operation state of art equipment is available to handle products in export and import hands. The total static capacity for dry bulk operation in the Organized Port is 43,9 million tonnes.  
 Bulk Berths: 58 berths including 14 specialized berths for dry bulk.  
 Total uncovered Storage: 500,000sqm  
 Total covered Storage: 1,000,000sqm  
 The port operated in 2006 a total of US\$ (FOB) 60,6 billion in cargo value.

**Santos**

**Port of Santos**  
 Companhia Docas do Estado de Sao Paulo  
 Avenida Rodrigues Alves s/n  
 Santos  
 Sao Paulo  
 11015-900  
 Brazil  
 Contact: Mr Sergio Aquino  
 Port Operator  
 T: + 55 133 202 6565  
 F: + 55 133 233 3080  
 E: seaport@santos.sp.gov.br  
 W: www.portodesantos.com

**Santos**

**Tropical Agencia Maritima Ltda.**  
 4th floor  
 Rua do Comercio, 55  
 Santos  
 Sao Paulo  
 11010-141  
 Brazil  
 Contact: Mr Francisco Garcia  
 CEO  
 T: + 55 13 3213 8842  
 F: + 55 13 3219 2550  
 E: tropical@tropmar.com.br  
 W: www.tropmar.com.br  
 Location: Santos - South East Brazil  
 Equipment & Capacity: 14 Grabs - from 4 to 15 m3 capacity  
 2 Mobile hoppers of 35 m3 capacity  
 Total covered Storage: 800 m2  
 Mobile operation with grabs and hoppers attending most Brazilian ports.

**Sao Francisco do Sul**

**Sao Francisco do Sul Port Authority**  
 Ave Eugenio  
 Leite  
 Ribeiro  
 Sao Francisco do Sul  
 782  
 Brazil  
 Contact: Mr Ulisses Tavares Lopes  
 Commercial Manager  
 T: + 55 47 34 71 12 00  
 F: + 55 47 34 71 12 11  
 E: porto@apsfs.sc.gov.br  
 W: www.apsfs.sc.gov.br

**Sao Luis**

**Port of Ponta da Madeira**  
 Avenida dos Portugueses s/n  
 Praia do Boqueirao  
 Sao Luis  
 Maranhao  
 65085 580  
 Brazil  
 Contact: Mr Alvaro de Oliveira Jnr  
 Port Superintendent  
 T: + 55 98 218 4263  
 F: + 55 98 218 4019



**Sao Paulo**

**Coinbra - Grain**  
 Avenida Brigadeiro Faria Lima,  
 1355  
 14º Andar  
 Pinheiros CEP  
 Sao Paulo  
 01451 903  
 Brazil  
 Contact: Ms. Marcia Amorim  
 Marketing  
 T: + 55 11 3039 6700  
 F: + 55 11 3814 3235  
 W: www.louisdreyfus.com

**Vitoria**

**Port Authority of Espirito Santo**  
 Avenida Getulio Vargas No 556  
 Vitoria  
 Espirito Santo  
 29000  
 Brazil  
 Contact: Mr Jose Luiz Canjelo de Franca  
 Marketing  
 T: + 55 27 2132 7342  
 F: + 55 27 3132 7343  
 E: comark@codesa.gov.br  
 W: www.portodevitoria.com.br

**Vitoria**

**Capuaba Quay Grain Terminal/Port of Vitoria**  
 Ave Getulio Vargas 556  
 Centro  
 Vitoria  
 ES 29020  
 Brazil  
 Contact: Mr Dirceu Cardoso  
 Port Director  
 T: + 55 272 221 311  
 F: + 55 272 227 360  
 E: falaporto@codesa.gov.br  
 W: www.portodevitoria.com.br

**Vitoria**

**Tubarao Port Authority**  
 c/o Companhia Vale do Rio Doce  
 Porto de Tubarao  
 Vitoria  
 Espirito Santo  
 Brazil  
 Port Manager  
 T: + 55 273 35 5624  
 F: + 55 273 35 5293  
 E: info@cprd.com.br  
 W: www.cprd.com.br

**BULGARIA**

**Bourgas**

**Bulk Terminal 2A**  
 Port of Bourgas JSC  
 1 Al. Battenberg Str.  
 Bourgas  
 8000  
 Bulgaria

Contact: Mr Dimitar Terziev  
 Manager  
 T: + 359 56 822 400  
 F: + 359 56 822 156  
 E: headoffice@port-burgas.com  
 W: www.port-burgas.com

**Bourgas**

**Port of Bourgas JSC**  
 1, Prince Alexander Battenberg Street  
 Bourgas  
 8000  
 Bulgaria  
 Contact: Mr Stoycho Dimov  
 Chief FR, Marketing, QA Dpt  
 T: + 359 56 822 345  
 F: + 359 56 822 156  
 E: st\_dimov@port-burgas.com  
 W: www.port-burgas.com  
 Location: South East of Bulgaria on Black Sea Coast  
 Equipment & Capacity: Bulk Cargoes terminal / capacity - 6 million tons.  
 Siwertell Screw Unloader - 1  
 Cheretti Tanfani Grab Gantry unloader - 1  
 Forklift Trucks - 3  
 Front Loaders - 10  
 Telescopic Hold Cleaners - 2  
 Conveyor Belts - 9  
 Bulk Reclaimers - 3  
 Bulk Stackers - 2  
 Bulk Wagon Loading Station - 1  
 Truck Scales - 2Terminal 2A  
 Grab Gantry Unloaders, 1,200 t/h each - 2  
 Conveyor Belts - 14  
 Grab Gantry Unloaders - 1,200 t/h each - 2  
 Small Size Front Loaders (hold work) - 4  
 Wagon Weighing Bridge - 1  
 Wagon Loading Station - 2 lines per 600 t/hour - 1  
 Stacker/Reclaimer - 1  
 Stackers - 2  
 Reclaimer - 1  
 Capacity 6 million tons  
 Bulk Berths: Mooring Berths 4  
 Total Wharf Length 817 m  
 Allowable Draught 15.50 m  
 Open Storage 108,000 sqm  
 Total area 268,000 sqm  
 Total uncovered Storage: 268,000sqm  
 Total covered Storage: 160,000sqm

**CAMBODIA**

**Sihanoukville**

**Sihanoukville Autonomous Port (PAS)**  
 Vithei Phe  
 Sihanoukville  
 Preah Sihanouk Province  
 Cambodia  
 Contact: Mr Lou Kim Chhun  
 Director General  
 T: + 855 34 933 416 / 34 933 511

**CAMEROON**

**Douala**

**Delmas Cameroon (CMA-CGM Group)**  
 Cameroon National Ports Authority  
 5 Boulevard Leclerc  
 Douala  
 BP 4020  
 Cameroon  
 Contact: Mr Markous Mono Mboum  
 General Port Manager  
 T: +237 33 42 49 65  
 F: + 237 3343 1300 / 2 8836  
 E: dlo.cfandeu@african-agency.com  
 W: www.otal.com/cameroon/index.htm

**Douala**

**Cameroon National Ports Authority**  
 PO Box 4002  
 Maritime Affairs Centre  
 Douala  
 Cameroon  
 Contact: Mr Tchouta Moussa  
 General Manager  
 T: + 237 342 0133  
 F: + 237 426797  
 E: onpc@camnet.cm

**CANADA**

**Becancour**

**Becancour Waterfront Industrial Park**  
 1000 Boulevard Arthur-Sicard  
 Parc Industriel Portuaire  
 Becancour  
 Quebec  
 G9H 2Z8  
 Canada  
 Contact: Ms Manon Blais  
 Harbour Master  
 T: + 1 819 294 6656  
 F: + 1 819 294 9020  
 E: blais@spipb.com  
 W: www.spipb.com  
 Location: South shore of the St. Lawrence River, halfway between Montreal and Quebec.  
 Equipment & Capacity: Railway/ Scales/ Ro-Ro Ramp.  
 Bulk Berths: Depth = 35ft.  
 Berth 1 = 244m, Berth 2 = 150m, Berth 3 = 219m, Berth 4 = 214m, Berth 5 = 292m.  
 Total uncovered Storage: 100,000sqm  
 Year-round access.  
 Near Highways 30, 55, 40, 20.  
 Connected to the North American road network.

2013 DRY CARGO Events presents

# BULK PORTS, TERMINALS & LOGISTICS 2013

Crowne Plaza Hotel  
Antwerp, Belgium  
12th-14th May 2013

Discuss, debate and join executives in the industry to tackle timely issues affecting the bulk ports sector.

## Programme Highlights

- ❖ Demand outlook for major dry bulk commodities, the rise and fall of the Euro: consequences for the dry bulk trade.
- ❖ Chinese Macroeconomic Outlook (Dry Bulk Divergence / Capesize Comeback).
- ❖ Challenges Facing Dry Bulk Terminals in Developing Regions.
- ❖ Raw materials trades - EU Policy and the impact of developing countries on future trade flows.
- ❖ Performance Analysis and Benchmarking for Bulk Operations.
- ❖ Emerging techniques for clean bulk handling in ports.
- ❖ Advances in Biomass handling at ports and terminals.
- ❖ Safe Fertilizer Handling at Ports and Terminals.
- ❖ New developments in environmentally friendly bulk handling using Continuous Ship Unloaders.
- ❖ Handling and transshipment solutions at bulk facilities to cope with the increased trade of wood pellets from the USA to Europe. From bigger vessels to silos and river barges, the discharge of river barges directly to the power stations and efficient handling solutions
- ❖ The redesign of bulk terminals (on the design of new or expansions of existing bulk terminals).
- ❖ Large scale fuel storage silos for coal, petcoke and wood pellets.
- ❖ Quebec City Terminal management case study: Developments in materials handling equipment installations and analysis of tonnage throughput within the context of the St Lawrence Seaway, the "Northern Corridor" trade route.

VISIT TWO EVENTS  
IN ONE WEEK!

After BULK PORTS, TERMINALS  
& LOGISTICS 2013,  
attend BREAKBULK  
EUROPE 14-16 May 2013

## Current Speakers

- Olle Östensson, President, Caromb Consulting*  
*Dr Corina Hebestreit, Director, Euromines*  
*Jeffrey Landsberg, Managing Director, Commodore Research & Consultancy*  
*David Peel, European Manager, RightShip Pty Ltd*  
*Prof.dr.ir. Gabriel Lodewijks, Head of Department-Marine and Transport Technology, Delft University of Technology*  
*Han Ozturk, Director, The Nectar Group*  
*David Trueman, Sales Director, DBIS*  
*Geoff Lemont, Vice President, St Lawrence Stevedoring*  
*Professor Mike Bradley, Director, The Wolfson Centre*  
*Mr Nicholas Dechamps, Managing Director, Vigan*  
*J.P.J. Ruijgrok, Managing Director, ESI Eurosilos BV*  
*Dr Holger Lieberwirth, Executive Vice President, TAKRAF GmbH*  
*Philip Waddell, International Sales Manager, Telestack*  
*Belan Velan, Managing Director, Scorpio Engineering Ltd*

## Media Partners

portstrategy

DRY CARGO

SHIPSHORE

PORT TECHNOLOGY

## Sponsors & Exhibitors

BEDESCHI

NEUERO

VIGAN

Telestack

CARGOTEC

dbis

SENEBOGEN

info@dc-int.com +27 (31) 583 4360 www.drycargoevents.com





**Belledune**  
Port of Belledune



112 Shannon Drive  
Belledune  
New Brunswick  
E8G 2W2  
Canada  
Contact: Ms Jenna MacDonald  
Director of Marketing  
T: + 1 506 522 1204  
F: + 1 506 522 0803  
E: macdonald@portofbelledune.ca  
W: www.portofbelledune.ca  
Location: NE Coast of New Brunswick  
on Chaleur Bay  
Equipment & Capacity: Mobile/Fixed  
Covered Conveyors & Hoppers +/-  
1,200 to 1,800tph.; Rail Mounted Ship  
Load/Unloaders +/- 1,200 to 1,800tph;  
Mobile Cranes +/- 50t to +/-165t;  
Front End Loaders & Forklifts (cap.  
varied).  
Bulk Berths: Term. # 1 = 155m X 15m  
X 10.4 m; Term. # 2 = 307m X 28m X  
14.4m; Term. # 3 = 455m X 15m X  
9.9m (West) to 11.2m (East); Term. #  
4 Combination Ro-Ro/Barge; Ro-Ro  
Wharf = 184m X 31m X 9.0m; Ro-  
Ro Ramp = 19.2 m X 27.18 m; Barge  
Wharf = 122m X 31m X 7.0m;  
Total uncovered Storage:  
+/- 6,000,000sqm  
Total covered Storage: +/- 15,000sqm

**Burlington**  
Lloyd's Register

3050 Harvester Road  
Suite 208  
Burlington  
Ontario  
L7N 3J1  
Canada  
Contact: Mr Lori Malone  
Marketing  
T: + 1 281 675 3100  
E: barry.shepherd@lr.org

**Churchill**

**Hudson Bay Port Terminal**  
PO Box 217  
Churchill  
Churchill  
Manitoba  
ROB OEO  
Canada  
Contact: Captain Irvin Sawatzky  
Director, Marine Ops  
T: + 1 204 675 8823 ext. 206  
F: + 1 204 675 2550  
E: i.sawatzky@omnitrax.com

**Contrecoeur**

**Terminal Maritime Contrecoeur Inc**  
1920 Marie Victorin  
Contrecoeur  
Quebec  
JOL 1C0  
Canada  
Contact: Mr Norman Desjardins

General Manager  
T: + 1 450 587 2073  
F: + 1 450 587 8570  
E: ndesjard@logistec.com  
W: www.logistec.com  
Location: St. Lawrence River,  
Quebec, Canada  
Equipment & Capacity: 2 gantry  
cranes  
Bulk Berths: 228.9m

**Contrecoeur**

**Logistec**  
1920 Marie Victorin  
Contrecoeur  
Quebec  
JOL 1C0  
Canada  
Contact: Mr Philippe Desgagnés  
Director of Operations  
T: + 1 450 587 2073  
F: + 1 450 587 8570  
E: pdesgagn@logistec.com  
W: www.logistec.com  
Location: St. Lawrence River, East of  
Montreal  
Equipment & Capacity: Two gantry  
crane 34 MT  
Bulk Berths: Two berth  
Total uncovered Storage: 45,000sqm  
Total covered Storage: 3,500sqm

**Corner Brook**

**Corner Brook Port Corporation**  
R.A. Pollett Building  
61 Riverside Drive  
Corner Brook  
Newfoundland  
A2H 6T2  
Canada  
Contact: Ms Jacqueline Chow  
Port Manager & CEO  
T: + 1 709 634-6600  
F: + 1 709 634-6620  
E: info@cornerbrookport.com  
W: www.cornerbrookport.com/

**Dartmouth**

**Port Authority of Georgetown**  
Transport Canada  
PO Box 1013  
Dartmouth  
Nova Scotia  
B2Y 4K2  
Canada  
Contact: Mr W Chiasson  
Harbour Manager  
T: + 1 902 426 2588  
F: + 1 902 426 6334  
E: DSchronce@SCSPA.com

**Delta**

**Westshore Terminals**  
1 Roberts Bank  
Delta  
British Columbia  
V4M 4G5  
Canada  
Contact: Mr Denis Horgan  
Vice President and General  
Manager  
T: + 1 604 946 3400  
F: + 1 604 946 1388  
E: horgan@westshore.com

W: www.westshore.com  
Location: 30 km south of Vancouver,  
BC, Canada  
Equipment & Capacity: 4  
Stacker/Reclaimers, 2 rotary railcar  
dumpers, 2 berths - rated capacity 29  
million tpa  
Total uncovered Storage: 2.0 million  
mt  
Total covered Storage: None  
Currently North America's busiest coal  
export terminal. In the process of  
replacing the single rotary dumper  
with a double rotary and adding 3 new  
train indexers.  
Capacity will be 33 million tonnes  
upon completion in late 2012.

**Goderich**

**Southpier Terminals Limited**  
230 Harbour Street  
Goderich  
Ontario  
N7A 3Y5  
Canada  
Contact: Mr Calvin Kerr  
Manager  
T: + 1 519 524 7367  
F: + 1 519 524 7995  
E: ckerr@southpier.ca

**Guelph**

**Parrish & Heimbecker**  
Suite 205  
150 Research Lane  
Guelph  
Ontario  
N1G 4T2  
Canada  
Contact: Mr Matt Gardner  
Operations Mgr Eastern Canada  
T: + 1 519 780 4954  
E: mgardner@  
parrishandheimbecker.com  
W: www.parheim.mb.ca  
Location: Great Lakes  
Equipment & Capacity: 1,000mtph  
handling  
Bulk Berths: 4 full berths at seaway  
depth  
Total uncovered Storage: 2ha  
Total covered Storage: 50,000mt grain  
capacity

**Halifax**

**Halifax Port Corporation**  
PO Box 336  
Halifax  
Nova Scotia  
B3L 1K4  
Canada  
Contact: Mr Ches Carter  
Manager, Operations  
T: + 1 902 426 1796  
F: + 1 902 426 9067  
E: ccarter@portofhalifax.ca  
W: www.portofhalifax.ca

**Halifax**

**Halifax Grain Elevator Ltd**  
951 South Bland Street  
Halifax  
Nova Scotia  
B3H 4S6



Grain handling at  
Montreal.

Canada  
Contact: Mr Robert L White  
Operations Manager  
T: + 1 902 421 1714 x 15  
F: + 1 902 420 0343  
E: rwhite@halifaxgrain.com

**Hamilton**

**Hamilton Port Authority**  
605 James Street North  
Hamilton  
Ontario  
L8L 1K1  
Canada  
Contact: Mr Ian Hamilton  
VP, Business Development  
T: + 1 905 525 4330  
F: + 1 905 528 6554  
E: ihamilton@hamiltonport.ca  
W: www.hamiltonport.ca  
Location: Western End of Lake  
Ontario  
43 17' North 79 50' West  
Hamilton is the largest Canadian  
Great Lakes Port serving the  
Southern Ontario region and  
surrounding area.

**Hamilton**

**Richardson International Ltd**  
155 EastPort Blvd.  
Hamilton  
Ontario  
L8H 7S3  
Canada  
Contact: Mr Riley Verhelst  
Director of Operations  
T: + 1 905 545 3270  
F: + 1 905 545 8913  
E: Riley.Verhelst@richardson.ca  
W: www.richardson.ca  
Location: Pier 25 N Hamilton,  
Ontario, Canada

**La Baie**

**Alcan Primary Metal Group**  
262 1st Street  
La Baie  
Quebec  
G7B 3R1  
Canada  
Contact: Mr Louis Bruneau

Port Agent  
T: + 1 418 544 9674  
F: + 1 418 544 9622  
E: PA.agency@alcan.com

**Milford**

**National Gypsum Co Ltd**  
PO Box 57  
Milford  
Nova Scotia  
BON 1Y0  
Canada  
Terminal Operator  
T: + 1 902 883 2224  
F: + 1 902 758 3955  
E: info@ngcl.com  
W: www.nationalgypsum.com

**Montreal**

**Montreal Port Authority (Grain Terminal)**  
Port of Montreal Building  
2100 Pierre-Dupuy Ave, Wing 1  
Montreal  
Quebec  
H3C 3R5  
Canada  
Contact: Mr Réal Bélanger  
Director, Growth and Development,  
Grain & Bulk  
T: + 1 514 283 1313  
F: + 1 514 283 1858  
E: belangerr@port-montreal.com  
W: www.port-montreal.com  
Location: Section #54 at The Montreal  
Port Authority  
Equipment & Capacity: Unloading:  
3,000 tph / Loading: 5,500 tph  
Bulk Berths: Length: 395m / Depth:  
11.3m / Beam: 36m  
Total covered Storage: 262,000mt  
Operation: Year-round.  
We have 2 Rotary Screen Cleaner for  
a capacity of 24,000bph.

**Montreal**

**Port of Montreal Authority**  
Port of Montreal Building  
2100 Pierre-Dupuy Avenue, Wing 1  
Montreal  
Quebec

**Montreal**

**Port of Montreal Authority**  
Port of Montreal Building  
2100 Pierre-Dupuy Avenue, Wing 1  
Montreal  
Quebec

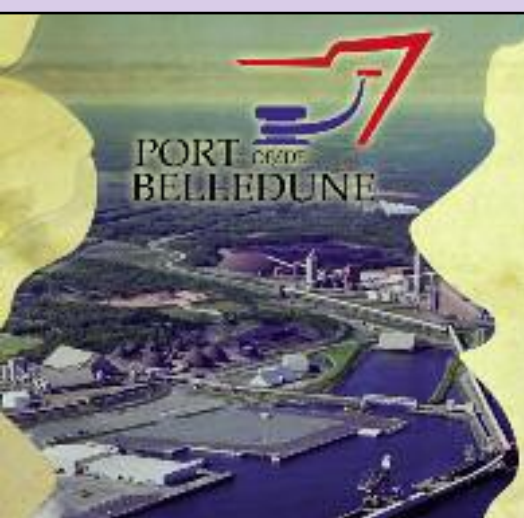

PORT OF  
BELLEDUNE

Explore the World through us...

www.portofbelledune.ca

112 promenade Shannon Drive |  
Belledune NB | E8G 2W2 | Canada

T. +1.506.522.1200 F. +1.506.522.0803



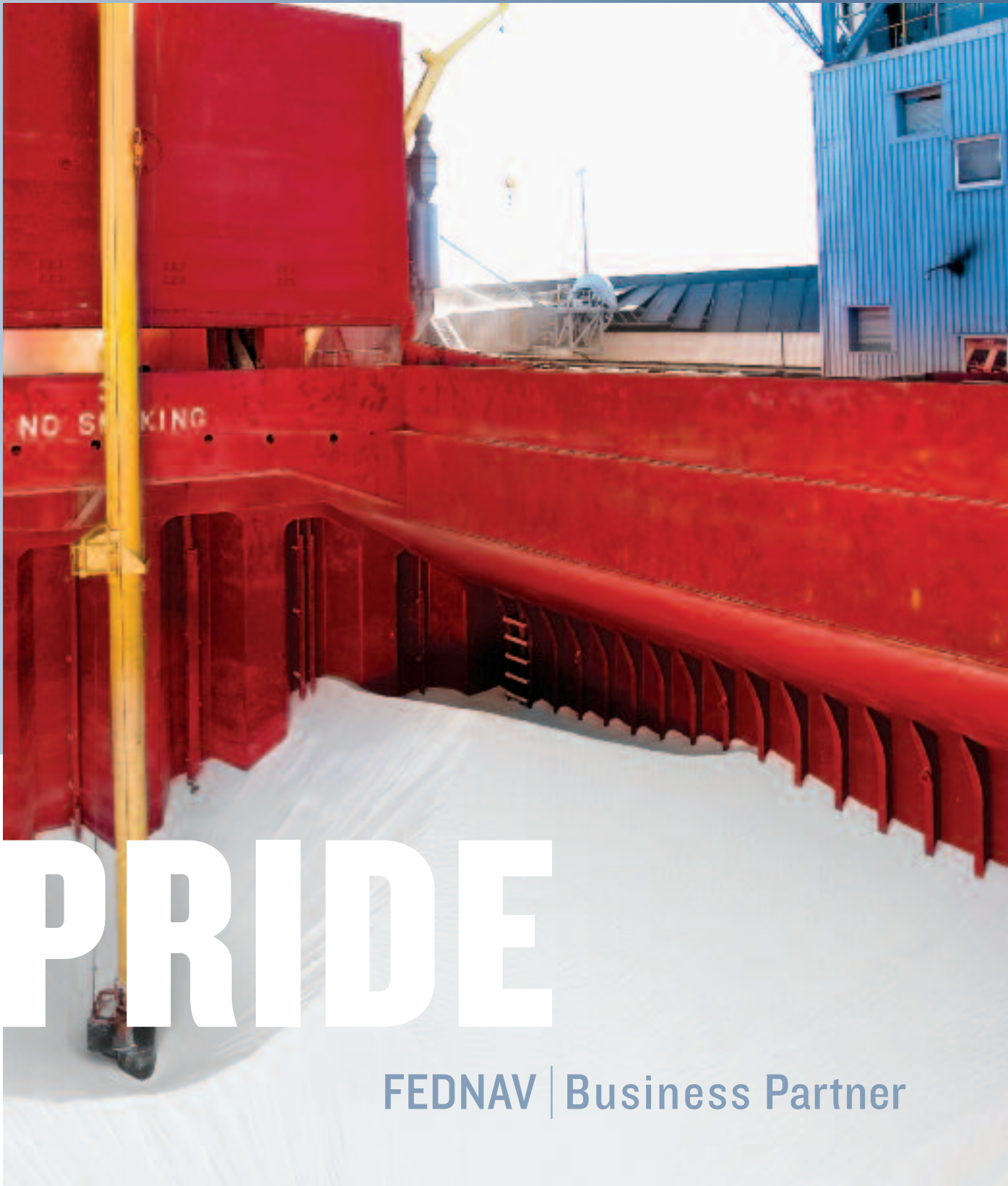

# PRIDE

FEDNAV | Business Partner

CANADA'S LARGEST INTERNATIONAL  
DRY-BULK OCEAN TRANSPORTATION GROUP



[www.fednav.com](http://www.fednav.com)



**FEDNAV**



H3C 3R5  
Canada  
Contact: Mr Tony Boemi  
Director, Growth & Development,  
Grain & Bulk  
T: + 1 514 283 1313  
F: + 1 514 283 0829  
E: belangerr@port-montreal.com  
W: www.port-montreal.com  
Location: Canadian East Coast  
Equipment & Capacity: See website  
www.port-montreal.com  
Bulk Berths: See website www.port-montreal.com  
Total uncovered Storage: See website  
www.port-montreal.com  
Total covered Storage: See website  
www.port-montreal.com  
One of the fastest and most efficient  
grain-handling facilities in Canada, the  
Port of Montreal grain terminal is  
geared primarily to international  
markets. Open year-round and  
featuring a total storage capacity of  
260,000 tonnes, the terminal is  
multifunctional.

**Montreal**

**Logistec Corporation**  
360 St Jacques  
Suite 15000  
Montreal  
Quebec H2Y 1P5  
Canada  
Contact: Mr George di Sante  
T: + 1 514 844 9381  
F: + 1 514 842 1262  
E: gdisante@logistec.com  
W: www.logistec.com  
Logistec Stevedoring Inc. is one of the  
largest cargo handling companies in  
Eastern Canada and has a network of  
strategically located facilities across  
Eastern Canada, the Great Lakes,  
and the United States East Coast.  
For more detailed information on each  
of the individual sites, please visit our  
web site at www.logistec.com.

**Montreal  
Federal Marine Terminals**



Suite 3500  
1000 de la Gauchetiere Street West  
Montreal  
Quebec  
H3B 4W5  
Canada  
Contact: Mr Mike Kirkpatrick  
Marketing Manager  
T: + 1 514 868 6500  
F: + 1 514 878 9168  
E: mkirkpatrick@fedmar.com  
W: www.fmtcargo.com

**Montreal**

**Strudes Inc**  
4700 De La Savane  
Suite 218  
Montreal  
Quebec H4P 1T7  
Canada  
Contact: Mr Henry Nowodworski  
President  
T: + 1 514 731 6951 x 123  
F: + 1 514 737 4146  
E: nowodworski@strudes.ca  
W: www.strudes.ca

**Montreal**

**Les Silos Port-Cartier**  
360 rue St-Jacques  
Montreal  
Quebec  
H2Y 1P5

Canada  
Contact: Mr Richard Bridgeman  
T: + 1 514 844 9391  
F: + 1 514 844 0588

**North Vancouver**

**Richardson International Ltd**  
375 Low Level Road  
North Vancouver  
BC V7L 1A7  
Canada  
Contact: Mr Phillip Hulina  
Director of Operations  
T: + 1 604 987 8855  
F: + 1 604 987 9532  
E: phil.hulina@pctl.ca  
W: www.richardson.ca

**North Vancouver**

**Kinder Morgan Canada Terminals  
Limited Partnership**  
1995 West First Street  
North Vancouver  
BC  
V7P 1A8  
Canada  
Contact: Mr Tim Ayling  
Director of Marketing and Sales  
T: + 1 604 904 7206  
F: + 1 604 982 7113  
E: Tim\_Ayling@kindermorgan.com  
W: www.kindermorgan.com  
Location: West coast of British  
Columbia, Canada on the Pacific  
Ocean  
Bulk Berths: 5 Panamax berths with  
draught of about 11m or more.  
Total uncovered Storage: 190,000 MT  
for sulphur  
Total covered Storage: 35,000sqm for  
pulp  
30,000 MT for agri bulk  
500,000 MT for mineral concentrates  
1 million gallons for liquids  
Very modern, multi-product terminal.  
5 berths, 111-acre site.

**North Vancouver**

**Neptune Bulk Terminals (Canada)  
Ltd**  
PO Box 86367  
North Vancouver  
BC V7L 4K6  
Canada  
Contact: Mr Tony Nardi  
VP Marketing & Transportation  
T: + 1 604 985 7461  
F: + 1 604 985 8941  
E: tnardi@nbtcl.bc.ca  
W: www.neptuneterminals.com  
Location: In Vancouver's inner  
harbour  
Equipment & Capacity: Dry Bulk: 4  
continuous loop tracks  
Two, three-car dumpers for covered-  
bottom hopper cars  
Semi-automated rail car opening  
system  
Up to 124 cars per train  
World's largest portal reclaimer for  
fertilizers (rated up to 3,000tph  
continuous operation, twin rakes)  
Fragile product handling (agricultural  
products)  
Coal: Continuous loop-track system  
Fully enclosed rotary dumper  
Up to 124 rail cars per train  
Rail mounted Stackers/Reclaimer:  
3,600tph  
600,000 tonnes open storage  
Bulk Berths: Berth 1 (Coal): Dock  
face: 230m (753 ft.), plus bollards &  
dolphins  
Draught alongside: 15.2m (50 ft.) at  
zero tide  
Vessel capacity: 180,000 dwt  
(Capesize)  
Will load up to 194,000 dwt (on  
request)  
Historical maximum cargo load:  
173,000 tonnes  
2 Quadrant shiploaders: 2,700tph.

each  
Air draught: 19m  
Berth 2 (Dry Bulk): Dock face: 230m  
(753 ft.) plus bollards & floating  
dolphins  
Draught alongside: 13.7m (45 ft.)  
Vessel capacity: 80,000dwt  
(Panamax)  
Air draught: 19m  
Chokefeeder hatch loading system  
2 Quadrant shiploaders: 2,200tph  
each  
Cascade spouts for dust control and  
to minimize product degradation  
Berth 3 (Dry Bulk): Dock face: 250m  
between bollards  
Draft alongside: 13.0m (43 ft.)  
Vessel capacity: 65,000dwt  
Air draft: 17.7m  
Krupp linear travelling shiploader (dry  
bulk)  
Loading rates: 2,500tph-potash;  
1,200tph-agricultural  
Strongco tube conveyor  
2 Inbound hoppers: 1,800tph  
receiving capacity  
Choke feeder hatch loading system  
Total covered Storage: 200,000  
tonnes for potash. 4,000 tonnes for  
alfalfa. Potential for 33,000 tonnes  
bin agricultural storage (on customer  
contractual demand)

**Nova Scotia**

**Port of Hantsport**  
Transport Canada  
PO Box 208  
Nova Scotia  
B0P 1P0  
Canada  
Contact: Ms Jeff Lawrence  
Chief Administrative Officer  
T: + 1 902 684 3210  
F: + 1 902 426 3904  
E: Jeff@hantsportnovascotia.com  
W: www.hantsportnovascotia.com

**Oshawa**

**Oshawa Harbour Commission**  
1050 Farewell Street  
Oshawa  
Ontario L1H 6N6  
Canada  
Contact: Ms Donna Taylor  
T: + 1 905 576 0400  
F: + 1 905 576 5701  
E: portoshawa@bellnet.ca  
W: www.oshawaportauthority.com

**Ottawa**

**Portha Inc**  
25 Noel Street  
Ottawa  
ON  
K1M 2A4  
Canada  
Contact: Mr Raymond Gaudreault  
T: + 1 613 833 0981  
F: + 1 613 833 0982  
E: rgaudreault@portha.ca

**Ottawa**

**Transport Canada**  
Surface Infrastructure Programs  
(AHSB)  
330 Sparks Road  
Place de Ville - Tower C 18th Floor  
Ottawa  
Ontario  
K1A 0N5  
Canada  
Operations Officer  
T: + 1 613 990 2309  
F: + 1 613 998 8620  
E: webfeedback@tc.gc.ca

**Owen Sound**

**Great Lakes Elevator**  
1499 First Avenue West  
Owen Sound  
Ontario N4K 5P1

Canada  
Contact: Mr Gary Shipleigh  
Operations Manager  
T: + 1 519 376 2754 x 3  
F: + 1 519 376 8292  
E: info@greatlakeslevator.com  
W: http://greatlakeslevator.com/

**Parrsboro**

**Port Authority of Parrsboro**  
PO Box 680  
Parrsboro  
Nova Scotia  
B0M 1S0  
Canada  
Contact: Mr C G Wood  
Harbour Master  
T: + 1 902 254 2513  
F: + 1 902 254 3260  
E: town@town.parrsboro.ns.ca  
W: www.town.parrsboro.ns.ca

**Port Cartier**

**Les Silos Port Cartier**  
CP 400  
188 Portage des Moussees  
Port Cartier  
Quebec  
G5B 2G9  
Canada  
Contact: Mr Allen Tupper  
T: + 1 418 766 2515  
F: + 1 418 766 4136  
E: allen.tupper@dcommodities.com  
Location: North shore of St Lawrence  
- Gulf of St Lawrence  
Equipment & Capacity: 6 loading spts.  
2,800tph average  
Bulk Berths: 1470' of bearth for  
load/unload  
Total uncovered Storage: 0  
Total covered Storage: 280,000t

**Port Colborne**

**Port Colborne Grain Terminal**  
P O Box 129  
Port Colborne  
Ontario  
L3K 5V8  
Canada  
Contact: Mr Joe Lannan  
Manager  
T: + 1 905 834 3644  
F: + 1 905 834 7816  
E: jlannan@goderichelevators.com  
Location: West side at the mouth of  
welland canal  
Equipment & Capacity: 2 loading  
spouts (1200tph), self unloading  
hopper(600tph)  
Bulk Berths: 700 ft dock wall  
Total covered Storage: 76,000 mt of  
storage space

**Prescott**

**Port of Prescott**  
Ports Canada  
PO Box 520  
River Road East  
Prescott  
Ontario K0E 1T0  
Canada  
Contact: Mr Robert Hennessy  
General Manager  
T: + 1 613 925 4228  
F: + 1 613 925 5022  
E: info@portofprescott.com  
W: www.portofprescott.com

**Prince Rupert**

**Ridley Terminals Inc**  
2110 Ridley Island  
PO Bag 8000  
Prince Rupert  
BC  
V8J 4H3  
Canada  
Contact: Mr Dennis Blake  
Senior Manager  
T: + 1 250 624 9511  
F: + 1 250 624 2389

E: dblake@rti.ca  
W: www.rti.ca  
Location: North West coast of British  
Columbia, 500 miles north of  
Vancouver.  
Equipment & Capacity: 12 million  
tonne dry bulk capacity  
Bulk Berths: 250,000dwt capable, 22  
metre draught  
Total uncovered Storage: 1.5 million  
tonnes  
Total covered Storage: None  
Two 20,000t liquid storage tanks and  
partially completed liquid unloading  
facilities also on site.

**Prince Rupert**

**Prince Rupert, Ridley Island  
Grain Elevator**  
PO Box 877  
Prince Rupert  
British Columbia  
V8J 3Y1  
Canada  
Contact: Mr Jeff Burghardt  
T: + 1 250 627 8777  
F: + 1 250 627 8541  
E: edouglas@prgrain.bc.ca

**Prince Rupert**

**Prince Rupert Port Authority**  
200-215 Cow Bay Road  
Prince Rupert  
British Columbia  
V8J 1A2  
Canada  
Contact: Mr Maynard Angus  
T: + 1 250 627 8899  
F: + 1 250 627 8980  
E: mangus@rupertport.com  
W: www.rupertport.com

**Quebec City**

**St Lawrence Stevedoring**  
Div of Quebec Stevedoring  
Company Ltd  
961 Boulevard Champlain  
Quebec City  
Quebec  
G1K 4J9  
Canada  
Contact: Mr Geoff Lemont  
Vice-President  
T: + 1 418 522 4701  
F: + 1 418 522 9770  
E: glemont@qsl.com  
W: www.qsl.com  
Location: On St Lawrence River  
Latitude 46° 50' 00" N  
Longitude 71° 12' 00" W  
Equipment & Capacity: Pneumatic  
unloader  
5 portal cranes, Ship loader - up to  
150,000 tpd  
Bulk Berths: Berths 250 to 325m  
each  
Depth - 12.5 to 15.5m  
Total uncovered Storage: 300,000sqm  
Total covered Storage: 17,000sqm

**Quebec City**

**Quebec Port Authority**  
150 Dalhousie St  
PO Box 80  
Station Haute-Ville  
Quebec City  
Quebec G1R 4M8  
Canada  
Contact: Mr Patrick Robitaille  
Director - Marketing  
T: + 1 418 648 3640 x1108  
F: + 1 418 648 4160  
E: patrick.robitaille@portquebec.ca  
W: www.portquebec.ca  
Location: 1300 km from the Atlantic  
Ocean on the St.Lawrence River

**Quebec City**

**Sillery Distribution Center Inc.**  
1111 Champlain Boulevard  
Quebec City

Quebec  
G1K 0A2  
Canada  
Contact: Mr Stephen Leonard  
General Manager  
T: + 1 418 687 7504  
F: + 1 418 687 0169  
E: stephen.leonard@cds-sillery.ca  
W: www.cargill.ca

## Quebec City

**Bunge of Canada Elevator**  
300 Dalhousie Street  
PO Box 2537  
Station Terminus  
Quebec City  
Quebec  
G1K 7R3  
Canada  
Contact: Mr Steve Cantin  
T: + 1 418 692 0217  
F: + 1 418 692 0182  
E: steve.cantin@bunge.com

## Regina

**Viterra Inc**  
2625 Victoria Avenue  
Regina  
Saskatchewan  
S4T 7T9

Canada  
Contact: Mr Bob Miller  
Senior Vice-President, Grain, North America  
T: + 1 866 569 4411  
F: + 1 306 569 4715  
E: investor@swp.com  
W: www.viterra.ca  
Location: (1) Canadian West Coast/North Vancouver, British Columbia; and (2) Canadian Great Lakes, St. Lawrence Seaway, Thunder Bay, Ontario and (3) Montreal (leased)  
Bulk Berths: Two ship berths at each location  
Total uncovered Storage: Storage Capacity: (1) 237,240mt capacity (2) 362,650mt capacity (3) 262,000mt capacity  
-Both Vancouver, BC and Thunder Bay, ON bulk grain terminals are serviced by Canadian National Railway.  
-Montreal facility is leased

## Saint John

**Saint John Port Authority**  
111 Water Street  
Saint John  
New Brunswick

E2L 0B1  
Canada  
Contact: Mrs Shannon Blanchard  
Cargo Development and Marketing Specialist  
T: + 1 506 6365859  
F: + 1 506 6364443  
E: sblanchard@sjport.com  
W: www.sjport.com  
Location: On the Bay of Fundy east coast of Canada. 110 km from the border with USA, 771km from Montreal and 1,318 km from Toronto by rail.  
Equipment & Capacity: Two 45-tonne Portainer Cranes at Rodney Container Terminal.  
Barrack Point Potash Terminal has quadrant loader with a loading capacity of 2,700tph  
Bulk Berths: Two 45-tonne Gantry Cranes at Rodney Container Terminal.  
Navy Island Terminal is equipped for Starboard quarter ramps and stern ramps. Specialized equipment to handle Forest Products.  
Rodney Terminal:  
Slip berth Length 291 m, depth 12.2m  
Marginal berth Length 369 m, depth 12.2 m  
American Iron and Metal

Terminal Berth Length 202 m, depth 12.2 m  
Navy Island Terminal:  
1A & 1B Length 378m, depth 10.4m  
2B Length 190m, depth 10.4m  
3A & 3B Length 313m, depth 10.4m  
Long Wharf Terminal:  
Berth length 285 m, depth 10.7m  
Lower Cove Terminal:  
Berth length 225 m, depth 10.7 m  
Barrack Potash Terminal  
Berth length 290 m, depth 13 m  
Total uncovered Storage: 164 acres  
Total covered Storage: 82,000sqm  
Saint John is an ice-free, deep-water port with modern specialized facilities. On dock rail available with competing lines, and direct highway access from each terminal.

## Salaberry-de-Valleyfield

**Valport Maritime Services Inc.**  
950 Boul. Gerard - Cadieux,  
Salaberry-de-Valleyfield  
Quebec  
J6T 6L4  
Canada  
Contact: Mr J. Frank Dunn  
President  
T: + 1 450 377 6686  
F: + 1 450 377 2521

E: frank@valport.ca  
W: www.valport.ca/  
Location: 70 km west of Montreal, in the St Lawrence Seaway.  
Equipment & Capacity: Crane, Conveyors.  
Shiploading up to 1,000tph  
Bulk Berths: Berth 1107, 1,105 metres of docks  
Total uncovered Storage: 115,000 sf  
Total covered Storage: 145,000 sf  
The only independent municipal port in Canada.  
Can accommodate up to 4 Seaway suitable cargo vessels at any one time. Ro/Ro ramp.

## Saskatoon

**Canpotex Limited**  
PO Box 1600  
Saskatoon  
SK  
S7K 3R7  
Canada  
Contact: Mr Scott Rudderham  
Senior Vice President, Operations  
T: + 1 306 931-2200  
F: + 1 306 653-5505  
E: corporate@canpotex.com

## Sept-Iles

**Porlier Express Inc**  
315 Ave Otis  
Sept-Iles  
Quebec  
G4R 1K9  
Canada  
Contact: Mr Denis Gagnon  
General Manager  
T: + 1 418 962 3073  
F: + 1 418 962 3067  
E: dgagnon@porlier.com  
W: www.porlier.com

## Sept-Iles

**Iron Ore Company of Canada**  
PO Box 910  
Sept-Iles  
Quebec  
G4R 4L2  
Canada  
Contact: Mr Jilles B  
Coordinator  
T: + 1 418 968 7540  
F: + 1 418 968 7113  
E: Harold.Hogan@ironore.ca  
W: www.ironore.ca

## Sept-Iles

**Tessier Ltd**  
265, rue des Pionniers  
Sept-Iles  
Quebec Province  
G4R 4K2  
Canada  
Contact: Mrs Oddepe  
Managing Director  
T: + 1 418 962 3639  
F: + 1 418 968 6910  
E: info@tessier.desgagnes.com  
W: http://www.tessierlee.com/

# ONE SIZE FITS ALL

# XXL

- ★ Full service bulk terminal
- ★ Professional services
- ★ Strategic geographic location
- ★ Deepwater port
- ★ All-size ships
- ★ Accessible year round
- ★ Multi-modal facilities



**24/7**  
FULL SERVICE  
+1 418 968-1231  
portsi.com





**Sept-Iles**  
Sept-Iles Port Authority



1 Quai Mgr- Blanche  
Sept-Iles  
Quebec  
G4R 5P3  
Canada  
Contact: Ms Patsy Keays  
Director of Corporate Affairs  
T: + 1 418 961 1235  
F: + 1 418 962 4445  
E: pkeays@portsi.com  
W: www.portsi.com  
Location: Sept-Iles is located on the north shore of the St-Lawrence River 287 NM east of Quebec City, Canada.  
Equipment & Capacity: - 100 MT mobile harbour crane (bulk & general cargo capable)  
- bucket grabs  
- mobile dry bulk conveyors (600 - 1000 Mtp, depending on cargo)  
- stacker  
- 4 ship loaders (5 000 Mtp capacity)  
- 5 hangars  
- Raicar ferry dock with mobile ramp  
Bulk Berths: Berth No 2 dock, Length 488m, Depth 18m (owned by Iron Ore Company of Canada/Rio Tinto)  
Berth No 4 & 5 dock, Length 487m, Depth 11m (owned by Iron Ore Company of Canada/Rio Tinto)  
Berth No 7 dock, Length 183m, Depth 8.5m  
Berth No 8 dock, Length 98m, Depth 12m  
Berth No 14 & 15 dock, Length 244m, Depth 8m  
Berth No 30 & 31 dock, Length 631.5m, Depth 16m (No 30), 12m (No

31)  
Berth 40 dock, Length 260m, Depth 14m  
Berth 41 dock, Length 200m, Depth 8.5m or 11m (with fenders)  
Total uncovered Storage: 208,241sqm  
Total covered Storage: 15,200sqm  
Other commodities handled: Coke breeze, gas, fuel, bunker, limestone, bentonite, alumina, aluminium

**Sept-Iles**

**Wabush Mines**  
1505 Point Noire  
Sept-Iles  
Quebec Province  
G4R 4L4  
Canada  
Contact: Mr Daniel Lebert  
General Manager  
T: + 1 418 962 5131  
F: + 1 418 962 0209

**Sorel-Tracy**

**Richardson International (Quebec)**  
10 Rue de la Reine  
Sorel-Tracy  
Quebec  
J3P 4R2  
Canada  
Contact: Mr Serge Laperriere  
Director of Operations  
T: + 1 450 743 3893 ext. 22  
F: + 1 450 743 7566  
E: serge.laperriere@rji.ca  
W: www.richardson.ca

**Squamish**

**Squamish Terminals Ltd**  
PO Box 1520  
37500 Third Avenue  
Squamish  
British Columbia  
V8B 0B1  
Canada  
Contact: Mrs Kim Stegeman-Lowe  
Manager, Marketing & Administration

T: + 1 604 892 3511  
F: + 1 604 892 5623  
E: info@sqterminals.com  
W: http://www.sqterminals.com/  
Location: 32 nautical miles north of the Port of Vancouver, British Columbia, Canada - at the north end of the Howe Sound  
Equipment & Capacity: Break Bulk Facility  
Bulk Berths: 2 Berths, which handle common size Panamax vessels  
Break Bulk Facility  
Total uncovered Storage: 50,000sqm  
Total covered Storage: 47,000sqm  
Squamish Terminals is a public terminal, open to all major break-bulk shipping lines providing its customers with access to markets world-wide and is capable of handling a wide variety of cargoes.

**St Catherines**

**The St Lawrence Seaway Management Corporation**  
508 Glendale Avenue  
St Catherines  
Ontario  
L2R 6V8  
Canada  
Contact: Mr Bruce Hodgson  
Director, Market Development  
T: + 1 905 641 1932  
F: + 1 905 641 2018  
E: bhodgson@seaway.ca  
Location: St. Lawrence Seaway Great Lakes  
Servicing 41 ports the Gateway to the North American Heartland.

**St Johns**

**Ports & Harbours**  
Transport Canada  
Harbours and Ports Directorate  
PO Box 1300  
St Johns  
Newfoundland  
Canada  
Contact: Ms Candice Keats  
Operations Manager

T: + 1 709 772 5199  
F: + 1 709 772 5127  
E: keatsc@tc.gc.ca

**St Johns**

**Port of Stephenville**  
Transport Canada  
Harbours & Ports Directorate  
PO Box 1300  
St Johns  
Newfoundland  
A1C 6H8  
Canada  
Contact: Mr Wayne Hamilton  
T: + 1 709 772 6197  
F: + 1 709 772 5127  
E: portharmonauth@nf.aibn.com  
W: www.portharmonauthority.ca

**Sydney**

**Sydney Ports**  
Tourism Cape Breton  
Marine and Development  
PO Box 1448  
Sydney  
Nova Scotia  
B1P 6R7  
Canada  
Contact: Mr Donald Rowe  
General Manager  
T: + 1 902 564 8452  
F: + 1 902 564 0911  
E: don@sydneyport.ca

**Thunder Bay**

**Richardson International Ltd**  
PO Box 10339  
Thunder Bay  
Ontario  
P7B 6T8  
Canada  
Contact: Mr Gerry Heinrichs  
Regional Manager  
T: + 1 807 343 5571  
F: + 1 807 345 0522  
E: gerry.heinrichs@rji.ca  
W: www.rji.ca

**Thunder Bay**

**Thunder Bay Terminals Ltd**  
McKellar Island  
PO Box 1800  
Station 'F'  
Thunder Bay  
Ontario  
P7C 5J7  
Canada  
Contact: Mr John Kepes  
T: + 1 807 625 7800  
F: + 1 807 623 5749  
E: j\_kepes@tbaytel.net  
W: www.portauthority.thunder-bay.on.ca  
Location: On Lake Superior

**Thunder Bay**

**Mission Terminal**  
Thunder Bay  
Ontario  
Canada  
Contact: Mr Paul Kennedy  
T: + 1 807 623 8868  
F: + 1 807 623 8823  
E: pkennedy@missionterminal.ca

**Thunder Bay**

**Valley Camp Terminal, Inc.**  
174 Darrel Ave  
Thunder Bay  
Ontario  
P7J 1K4  
Canada  
Contact: Mr Robert Van Patten  
T: + 1 807 655 1201  
F: + 1 807 656 1363  
E: rmvanpatten@aol.com  
W: www.namillyard.com  
Location: Northwest Ontario on Lake Superior  
Equipment & Capacity: Shiploader at 4000 tph  
Bulk Berths: 30 foot draught- accommodate 1100 foot boat  
Total uncovered Storage: 2,000,000 tonnes  
Total covered Storage: 40,000 tonnes  
On CN Rail





# TWO-WAY CARGO

The Port of Thunder Bay handles wind turbines and oversized project cargo destined for Western Canada. Grain, coal, and potash exist as backhaul cargoes for European and North African destinations.



**PROJECT CARGO**



**GRAIN**



FOR MORE INFORMATION CONTACT:

**THUNDER BAY  
PORT AUTHORITY**

1-807-345-6400  
[portofthunderbay.ca](http://portofthunderbay.ca)

**Canada** 





**Thunder Bay**

**Thunder Bay Port Authority**



100 Main Street  
Thunder Bay  
Ontario  
P7B 6R9  
Canada  
Contact: Mr Tim Heney  
CEO  
T: + 1 807 346 7387  
F: + 1 807 345 9058  
E: tbport@tbaytel.net  
W: www.portofthunderbay.ca  
Location: Mid-Canada - Lake Superior on Great Lakes St. Lawrence Seaway Grain handled through eight grain terminals. Other bulk commodities handled through two bulk terminals. See port website for details.

**Thunder Bay**

**Western Grain By-Products**

Thunder Bay  
Ontario  
Canada  
Contact: Mr Maurice Mailhot  
T: + 1 807 6238500  
F: + 1 807 622 0482  
E: wstgrain@tbaytel.net

**Toronto**

**Toronto Port Authority**

60 Harbour Street  
Toronto  
Ontario  
M5J 1B7  
Canada  
Contact: Mr Alain Lefebvre  
Manager Trade Developments  
T: + 1 416 462 0263  
F: + 1 416 462 1612  
E: alefebvr@logistec.com  
W: www.torontoport.com  
Location: 43 deg 40' north, 79 Deg 25' west on the North shore of Lake Ontario  
Equipment & Capacity: 8 docks at Seaway depth up to 300 MT capacity cranes  
Bulk Berths: 8 bulk docks  
Total uncovered Storage: 50,632sqm  
Total covered Storage: 19,821sqm  
This major inland port has 2720m of dock wall at Seaway depth specializing in general, bulk, and project cargo. 40 acres of container storage, 62 plug-ins for reefers. Container packing/ unpacking Special lifting equipment for all types of cargo.24/7 security and ISPS certified

**Trois-Rivières**

**Port of Trois Rivières**

1545 rue du Fleuve  
Room 300  
Trois-Rivières  
Quebec  
G9A 6K4  
Canada  
Contact: Mr Gaétan Boivin  
President & CEO  
T: + 1 819 378 2887  
F: + 1 819 378 2487  
E: adm\_gen@porttr.com  
W: www.porttr.com

**Trois-Rivières**

**Three Rivers Elevators**

PO Box 35  
Trois-Rivières  
Quebec  
G9A 5E3  
Canada  
Contact: Mr Gilles Morin  
General Manager  
T: + 1 819 374 6203  
F: + 1 819 374 6392  
E: g.morin@gls.qc.ca

**Trois-Rivières**

**Group Prommel**

3450 Boul. Gene-H-Kruger  
C.P. 294  
Trois-Rivières  
Quebec  
G9A5G1  
Canada  
Contact: Mr Eric Boifvert  
Vice President  
T: + 1 819 379 3311  
F: + 1 819 379 5584  
E: info@grpml.com  
W: www.grpml.com

**Vancouver**

**Cascadia Terminal**

3333 New Brighton Road  
Vancouver  
BC  
V5K 5JK  
Canada  
Contact: Mr John Dewar  
Director  
T: + 1 604 293 6207  
F: + 1 604 293 6214  
E: jdewar@cascadiaterminal.com  
W: www.viterra.ca  
Location: South Shore of Burrard Inlet, Vancouver, BC  
Bulk Berths: Max 120,000dwt  
Total covered Storage: 282,830t

**Vancouver**

**Port of Vancouver**

100 The Pointe  
999 Canada Place  
Vancouver  
BC  
V6C 3T4  
Canada  
Contact: Ms Katherine Bamford  
Business Communications Advisor  
T: + 1 604 665 9065  
F: + 1 866 284 4271  
E: katherine.bamford@portmetrovancover.com  
W: www.portvancouver.com  
Location: West coast of Canada, located in Burrard Inlet in Vancouver and at Roberts Bank in Delta.  
Equipment & Capacity: 25 major marine cargo terminals  
Bulk Berths: More than 60 berths  
Total uncovered Storage: Please see www.portvancouver.com for details per terminal  
Total covered Storage: Please see www.portvancouver.com for details per terminal  
The Port of Vancouver is Canada's largest deep-sea port and is the number one foreign export tonnage port in North America.

**Victoria**

**Little Narrows Gypsum Company Ltd**

RR 1 Little Narrows  
Victoria  
Nova Scotia  
BOE 1TO  
Canada  
Contact: Mr Mike Bishop  
T: + 1 902 756 2081  
F: + 1 902 756 2493  
E: awbishop@usg.com

**Ville de La Baie**

**Rio Tinto Alcan Port Alfred**

262 1st Street  
Ville de La Baie  
Quebec  
G7B 3R1  
Canada  
Contact: Mr Eric Favre  
Director Operations  
T: + 1 418 544 9615  
F: + 1 418 544 9622  
E: eric.favre@riotinto.com  
W: www.riotintoalcan.com  
Location: North East of Canada

Equipment & Capacity: 4 unloaders, 1,000tph each  
Bulk Berths: 385m, 12m draught  
Total uncovered Storage: 120KT  
Total covered Storage: 400KT

**WaWa**

**Michipicoten Harbour**

c/o Landfill Mining of Canada Ltd  
WaWa  
Ontario  
POS 1KO  
Canada  
Contact: Mr Mike Mezzonello  
Dock Superintendent  
T: + 1 705 856 0606  
F: + 1 705 856 9783  
E: info@superioraggregates.com  
W: www.superioraggregates.com

**West Vancouver**

**Canpotex Terminals Limited**

1111-100 Park Royal  
West Vancouver  
BC  
V7T 1A2  
Canada  
Contact: Ms Jennifer Siemens  
Manager, Corporate Communications  
T: + 1 306 931 2200  
F: + 1 306 653 5505  
E: jennifer.siemens@canpotex.com  
W: www.canpotex.com

**Windsor**

**ADM Agri-Industries Company/ Windsor Grain Terminal Ltd.**

5550/5600 Maplewood Drive  
Windsor  
Ontario  
N9C 4G9  
Canada  
Contact: Mr Brian Brohman  
Plant Manager  
T: + 1 519 972 8100  
F: + 1 519 972 2355  
E: b\_brohman@admworld.com  
Location: South side of the Detroit River between Lake St. Clair and Lake Erie  
Bulk Berths: 1000' dock X 30' foot draught  
Total covered Storage: 110,000 tonnes

**Windsor**

**Port of Windsor**

Windsor Port Authority  
502 Westcourt Place  
251 Goyeau  
Windsor  
Ontario  
N9A 6V2  
Canada  
Contact: Mr Peter Berry  
Harbour Master  
T: + 1 519 258 5741  
F: + 1 519 258 5905  
E: pberry@portwindsor.com  
W: www.portwindsor.com

**Winnipeg**

**Richardson International Ltd**

Corporate Head Office  
2800 - One Lombard Place  
Winnipeg  
MB  
R3B 0X8  
Canada  
Contact: Mr Riley Verhelst  
Plant Manager  
T: + 1 204 934 5961  
F: + 1 204 942 4161  
E: corporateaffairs@jri.ca  
W: www.jri.ca

**Winnipeg**

**Viterra**

CanWest Global Place  
201 Portage Ave

Winnipeg  
MB  
R3C 3A7  
Canada  
Contact: Mr Walter Fox  
VP Terminals  
T: + 1 207 944 5488  
F: + 1 207 944 5476  
E: info@viterra.ca  
W: www.viterra.ca

**CANARY**

**ISLANDS**

**Santa Cruz**

**Junta del Puerto de Sto Cruz**

Av Francisco Larroche 49  
Santa Cruz  
Tenerife  
38071  
Canary Islands  
Contact: Mr Miguel Pinter  
T: + 34 922 605 426  
E: web@puertosdetenerife.org

**CAPE VERDE**

**Praia**

**Capitania dos Portos de Sotavento**

PO Box 38  
Praia  
Cape Verde  
Contact: Mr Albertino Graca  
Port Director  
T: + 238 612382  
F: + 238 616133  
E: Portodesotavento@enapor.cv

**CHILE**

**Antofagasta**

**Caleta Coloso**

Ultramar Agencia Maritima  
Copia PO 574  
Casilla 1210  
Antofagasta  
Chile  
Contact: Mr Alberto Varas  
Director  
T: + 56 55 201793  
F: + 56 55 227341

**Arica**

**Puerto Arica**

Maximo Lira 389  
Arica  
1000002  
Chile  
Contact: Mr Mario Moya  
Montenegro  
T: + 56 58 202080  
F: + 56 58 202090  
E: mmoya@puertoarica.cl  
W: www.puertoarica.cl

**Castilla**

**Tocopilla**

c/o Servicios Integrales de Transitos y Transferencias  
Arturo Prat No 1060  
Castilla  
Tocopilla  
2098  
Chile  
Contact: Mr D Daniel Zarzosa  
Captain Port Authority  
T: + 56 55 813 279  
E: cptocopilla@directemar.cl

**Concepcion**

**Neuling Granelos SA**

San Martin  
553 Oficina

Concepcion  
805  
Chile  
Contact: Mr Sergio Ulloa  
General Manager  
T: + 56 41 2254 205  
E: sergio.ulloa@neulingsa.cl  
Location: South America, Chile, Bahía de Concepcion  
Equipment & Capacity: 20 trucks for bulk transportation  
1 belt conveyors 40 meters  
6 grabs (8 cub meters, each one)  
Total uncovered Storage: 15,000 sqm  
Total covered Storage: 5,200 sqm  
We are a stevedors company in ports of Bahía de Concepcion, Chile  
These ports are : San Vicente, Coronel, Lirquen.

**Iquique**

**Empresa Portuaria Iquique**

Avenida Jorge Barrera #62  
Iquique  
Chile  
Contact: Mr Alvaro Espinosa  
T: + 56 57 400100  
F: + 56 57 413 176  
E: epi@epi.cl  
W: www.epi.cl/z

**La Serena**

**Port Authority of Guayacan**

Compania Minera del Pacifico S.A.  
Pedro Pablo Munoz 675  
La Serena  
Guayacan  
Chile  
Contact: Mr Eduardo Bauer  
Port Manager  
T: + 56 51 208025  
F: + 56 51 208140

**Lirquen**

**Port of Lirquen SA**

Recinto Muelle s/n Lirquen  
Casilla no 937  
Correo Concepcion  
Lirquen  
Chile  
Contact: Mr Jorge Baksai Marquez  
Terminal Manager  
T: + 56 41 451037  
F: + 56 41 451030  
E: plirquen@puerto.cl

**Mejillones**

**Puerto de Mejillones S.A**

Casilla 108  
Mejillones  
Antofagasta  
1310000  
Chile  
Contact: Mr Cesar Barrera  
Operations Director  
T: + 56 55 883600  
F: + 56 55 621422  
E: cbarrera@puertoangamos.cl  
W: www.puertomejillones.cl  
Location: Bay of Mejillones, North of Chile

Equipment & Capacity: Two Berths:  
Berth N°1: Two level Luffing cranes, nominal capacity 1,200tph, conventional conveyor belt. One Shiploader, nominal capacity 1,500tph, pipe conveyor belt.  
Berth N°2: Unloading/Loading sulfuric acid, nominal capacity 500tph.  
Bulk Berths: Berth N°1: Length (LOA): 230 m  
Beam: 34 m  
DWT: 85,344 tonnes  
Berth N°2: Length (LOA): 230 m  
Beam: 34 m  
DWT: 80,000 tonnes  
Total uncovered Storage: 5,000sqm  
Total covered Storage: Zinc and Lead concentrates Stockpile: 6,274sqm  
Sulfuric Acid Terminal Tanks: 35,000sqm

Puerto de Mejillones inland facilities includes one stockpile 50.000 tonnes capacity, one spot uncovered area for 30.000 tonnes and 200.000 tonnes sulfuric acid storage capacity in 10 tanks.

## Puerto Natales

**Port of Puerto Natales**  
Empresa Portuaria De Chile  
Pedromot 325  
Puerto Natales  
Chile  
Contact: Mr Miguel Chaves  
Managing Director  
T: + 56 61 411 570  
F: + 56 61 411 409

## Quintero

**Port Authority of Quintero**  
Gobernacion Maritima de Valparaiso  
Avenida 21 Mayos/n  
Quintero  
Chile  
Contact: Mr L Fernandez  
General Manager  
T: + 56 3293 0366  
E: cpquintero@directemar.cl

## San Antonio

**Puerto Panul S.A.**  
Antonio Nunez de Fonseca No. 440  
Torre Bioceanica Piso 6 Of. 606  
San Antonio  
Barros Luco  
1613  
Chile  
Contact: Mr Carlos Valenzuela S  
@with line:

## Santiago

**E.CL S.A.**  
Av El Bosque Norte 500 of 902  
Las Condes  
Santiago  
Metropolitana  
7550092  
Chile  
Contact: Mr Emilio Bouchon  
Gerente de Puerto  
T: + 56 23533210  
F: + 56 23533208  
E: emilio.bouchon@e-cl.cl  
W: http://www.e-cl.cl

## Santiago

**Portuaria Puchoo SA**  
Av Bdo. O'Higgins 949 Of.1206  
Casilla  
Santiago  
2511  
Chile  
Contact: Mr Jamie Barahona V  
T: + 56 2 699 0330

## Tocopilla

**Central Termoelectrica Tocopilla**  
Avda Dr Leonardo Guzman 0780  
Tocopilla  
Casilla 1999  
Chile  
Contact: Mr Andres Tornquist  
Fernandes  
T: + 56 55 813279  
F: + 56 55 813279

## Valparaiso

**Valparaiso Port Authority**  
Pier No 6-10  
Errazuriz 25  
Valparaiso  
Chile  
Contact: Mr Gonzalo Davagnino  
Vergara  
Commercial Manager  
T: + 56 3244 8727  
F: + 56 3222 4190  
E: info@portvalparaiso.cl  
W: www.portvalparaiso.cl

## Valparaiso

**Saam**  
Blanco 895  
Valparaiso  
Chile  
Contact: Mr Manuel Inostroza  
Bulk Manager  
T: + 56 32 2201 229  
F: + 56 32 2201 481  
E: servicioalcliente@saamsa.com  
W: www.saamsa.com

## CHINA

### Anqing

**Anqing Port Authority**  
Administration Office  
7 Yanjiang Zhong Road  
Anqing  
Anhui 246030  
China  
Port Master  
T: + 86 556 521 7018  
F: + 86 556 554 2843

### Beihai

**Behai Harbour Administration**  
Administration Office  
75 Haijiao Road  
Beihai  
Guangxi 536000  
China  
Contact: Mr Yue Zhiwei  
Port Manager  
T: + 86 779 303 3481  
F: + 86 779 303 6387

### Chiwan

**Chiwan Harbour Container Office Building**  
11th Floor Marine Building  
Chiwan  
Shenzhen 518 068  
China  
Contact: Mr Du Xiaokun  
Commercial Department  
T: + 86 755 2669 4228  
F: + 86 755 2669 4297  
E: wuzm@cwccct.com  
W: www.cwccct.com

### Chongqing

**Chongqing Port Authority**  
3 Chaoqian Road  
Yuzhong District  
Chongqing  
Sichuan Province 400011  
China  
T: + 86 23 6310 0374  
F: + 86 23 6310 0612  
W: www.cqg.com.cn

### Dalian

**DCW Group Co**  
350 Zhong Nan Road  
Zhongshan District  
Dalian 116022  
China  
Contact: Mr Lu Kaili  
T: + 86 411 289 3900  
F: + 86 411 289 1756  
E: info@dalian-gov.net

### Dalian

**Dalian Port Authority**  
1 Gangwan Street  
Zhongshan District  
Dalian 116001  
China  
Contact: Mr Hong Sun  
Deputy Director of Marketing  
T: + 86 411 8263 7873  
F: + 86 411 280 7148  
E: info@portdalian.com  
W: www.portdalian.com

### Dalian

**Ganjiangzi Coal Terminal**  
1 Gangwan Street

Zhongshan District  
Dalian 116004  
China  
Contact: Mr Zang Feng Qiang  
T: + 86 411 8263 7873  
F: + 86 411 8280 7148

### Dalian

**Dalian Bay Coal Terminal**  
1 Gangwan Street  
Zhongshan District  
Dalian  
Liaoning Province 116004  
China  
Contact: Mr Zang Feng Chiang  
T: + 86 411 8263 7873  
F: + 86 411 8280 7148  
W: www.chinaports.com.cn/dalian.htm

### Dongfang County

**Basuo Port Corporation**  
Basuo  
Dongfang County  
Hainan  
China  
Contact: Mr Zhao Huang Yong  
General Manager  
T: + 86 8003 522 512  
F: + 86 8003 521 054

### Fangcheng

**Fangcheng Harbour Administration**  
Port Administration Office  
22 Youyi Road  
Fangcheng  
Guangxi Province  
China  
Contact: Mr Ye Shixiang  
Director General  
T: + 86 770 289 8141  
F: + 86 770 282 2663  
W: www.infomarine.gr/china/fangcheng

### Fujian Province

**Dongshan Port Authority**  
Port Administration Office  
Shipping Building Dongshan Port,  
Fujian Province 363401  
China  
Port Master  
T: + 86 596 562 2374  
F: + 86 596 202 8622

### Fuzhou

**Fuzhou Port**  
79 Chieh Fang Road West  
Fuzhou  
Fujian  
China  
Contact: Mr C Xiguan  
Deputy Director  
T: + 86 591 559 934  
F: + 86 591 839 87696

### Guangzhou

**Xinggang No1**  
30 Yangjiang No1 Road  
Guangzhou  
Guangzhou Province 510000  
China  
Contact: Mr Leung  
T: + 86 20 227 9412  
F: + 86 20 227 8303

### Haikou

**Haikou Port Authority**  
Hainan Port Affairs  
Hsui ying Wharf  
Haikou  
China  
Port Master  
T: + 86 898 866 6830  
F: + 86 898 866 2180  
E: bgs@shqj.com.cn

### Hong Kong

**China Cement Co (HK) Ltd**  
General Office

7 Lung Yiu Street  
Tap Shek Kok  
Tuen Mun NT  
Hong Kong  
China  
Contact: Mr Li Ka-Shing  
Chairman of the Board  
T: + 852 2122 3133  
F: + 852 2411 3421  
E: chairoff@ckh.com.hk

### Hong Kong

**CLP Power HK Limited**  
Castle Peak Power Station  
Tuen Mun  
Hong Kong  
China  
Contact: Mr Andrew C W Brandler  
CEO  
T: + 852 2678 8111  
F: + 852 2760 4448  
E: csd@clp.com.hk  
W: www.clp.com.hk/Pages/home.aspx

### Hong Kong

**The Hongkong Electric Company Ltd**  
44 Kennedy Road  
Hong Kong  
China  
Contact: Mr Francis C. Y. Cheng  
General Manager (Generation)  
T: + 852 2982 6201  
F: + 852 2982 1654  
E: mail@hkelectric.com  
W: www.hkelectric.com  
Location: Lamma Island, Hong Kong  
Equipment & Capacity: Five ship unloaders (2 of them are grab type with a capacity of 1,000tph each and 3 are continuous type with a capacity of 1,500tph each). One Stacker with a capacity of 3,000tph. One Stacker/Reclaimer with a stacking and reclaiming capacity of 3,000tph and 2,000tph respectively. Bulk Berths: Two berths (each 290m in length) capable of handling two coal vessels (max dwt 100,000MT) simultaneously. Total uncovered Storage: 63,000sqm Total covered Storage: 4,300sqm Facilities for the handling of limestone and gypsum are available at the East Heavy Unloading Area of the power station. The wharf is capable of unloading limestone barges up to 6,000 MT dwt with a screw-type unloader of 350tph capacity.

### Hualien

**Hualien Harbour Bureau**  
No.66 Hai-Ann Road  
Hualien  
Taiwan 97059  
China  
Contact: Mr Chung-Hsiung Wang  
Director  
T: + 886 38 325 131  
F: + 886 38 333 757  
E: dttd100@mail.hlhb.gov.tw  
W: www.hlhb.gov.tw

### Jiangsu

**Port of Lianyungang**  
Jiangsu Lianyungang Port Authority  
99 Zhongshan Rd  
Lianyungang  
Jiangsu  
222046  
China  
T: + 86 518 238 2501  
F: + 86 518 238 2906  
E: info@lygport.com.cn  
W: www.lygport.com.cn

### Jinzhou

**Jinzhou Port Authority**  
Port Administration Office  
11-2 Zhongyand Street  
1 Jingang Street

Jinzhou  
Liaoning 121007  
China  
Port Manager  
T: + 86 416 312 7123  
F: + 86 416 312 2419  
E: msc@jinzhouport.com  
W: www.jinzhouport.com

### Lianyungang

**Lianyungang Port Authority**  
99 Zhongshan Road  
Lianyungang  
Jiangsu 222046  
China  
Contact: Mr Chen Gang  
Assistant Economist  
T: + 86 518 238 2502  
F: + 86 518 233 2419  
E: wangmx@lyg.gov.cn  
W: www.lyg.gov.cn

### Longkou City

**Longkou Port Authority**  
Longkou Port Administration B  
24 Huanhai Road  
Longkou City  
Shandong Province  
265700  
China  
Contact: Mr Wang Shu-Bo  
T: + 86 535 884 2091  
F: + 86 535 884 1137

### Nanjing

**Nanjing Port Authority**  
19 Jianbian Road  
Xia Guan District  
Nanjing 210011  
China  
Contact: Mr Wu Deming  
T: + 86 25 5858 2721  
F: + 86 25 5882 3898

### Nantong

**Nantong Port Authority**  
12 Qingnian Road (W)  
Nantong  
Jiangsu Province 226006  
China  
Contact: Mr Shi Boxiang  
Port Director  
T: + 86 513 831 7591  
E: ntpa@public.nt.js.cn  
W: www.ntport.com.cn

### Ningbo

**Ningbo Port Authority**  
496 Yanjiangdong Road E  
Zhenhai District  
Ningbo  
Zhejiang Province 315200  
China  
Contact: Mr Linghong Li  
T: + 86 574 769 5142  
F: + 86 574 2769 5233  
E: npa\_office@nbport.com.cn  
W: www.nbport.com.cn/wps/portal

### Pinghu

**Zhapu Port Authority**  
Huhang Road  
Zhapu  
Pinghu  
Zhejiang 314201  
China  
Port Director  
T: + 86 573 552 2035  
F: + 86 573 552 2035

### Putian

**Port of Xiuyu**  
Rm422-425, Pacific Centre  
Licheng Boulevard  
Putian  
Fujian  
China  
Contact: Zhang Jingsong  
General Manager  
T: + 86 594 2696 290



F: + 86 594 2696 690  
 E: penavico@penavicomzw.com  
 Location: South of China on the South Coast  
 Equipment & Capacity: Shore crane (2\*8T 2\*10T 2\*40T 2\*16T 2\*25T) & conveyor  
 Bulk Berths: 25° 13' 0N 118° 59.0E(APPROX)  
 Total uncovered Storage: 138,000 m2  
 Total covered Storage: 120,000 m2

**Qingdao**

**Xigang Company**  
 65 Chongmingdao West Rd.  
 Huangdao District  
 Qingdao  
 Shandong 266500  
 China  
 T: + 86 532 8298 8085  
 F: + 86 532 8298 8085  
 E: bgs.xg@qdport.com  
 W: www.qdport.com/info/gkgk/gsgk\_gs\_xg/en/

**Qingdao**

**Port of Qingdao Coal Terminal**  
 Gang Qing Road 6  
 Qingdao  
 Shandong Province 266011  
 China  
 Contact: Mr Chang Dechuan  
 President  
 T: + 86 532 298 2011  
 F: + 86 532 292 2878  
 E: kefu@qdport.com  
 W: www.qdport.com/en

**Qingdao**

**Port of Qingdao**  
 Gang Qing Road 6  
 Qingdao  
 Shandong Province 266011  
 China  
 Contact: Mr Chang Dechuan  
 President  
 T: + 86 532 298 2011  
 F: + 86 532 282 2878  
 E: president@qdport.com  
 W: www.qdport.com/en

**Qinhuangdao**

**Qinhuangdao Port Authority**  
 35 Haibin Road  
 Qinhuangdao  
 Heibei 066002  
 China  
 Contact: Mr Huang Jianhua  
 Chairman of the Board  
 T: + 86 335 309 3222  
 F: + 86 335 341 5467

**Rizhao City**

**Rizhao Port Authority**  
 Huanghai Road 1  
 Rizhao City  
 Shandong Province 276826  
 China  
 Contact: Mr Wang Yan  
 Office Director  
 T: + 86 633 838 2900  
 F: + 86 633 838 2282  
 E: info@mail.rzport.com  
 W: www.rzport.com

**Sanya**

**Sanya Port**  
 Sanya Port Administration  
 Jiangang Road  
 Sanya  
 Hainan Province 572100  
 China  
 Port Director  
 T: + 86 899 827 4031  
 F: + 86 899 827 4153

**Shanghai**

**Shanghai International Port Group (SIPG)**  
 13 Zhongshan Dong Yi Lu

Shanghai 200002  
 China  
 Contact: Mr. Steven  
 Port Director  
 T: + 86 21 329 0660  
 F: + 86 21 329 0202  
 E: contact@portshanghai.com.cn  
 W: www.portshanghai.com.cn

**Shanghai Ming Sheng Stevedores No 3/4 Terminals**

No 3 Ming Sheng Rd  
 Pudong New District  
 Shanghai 200135  
 China  
 Contact: Mr Lin Huizheng  
 T: + 86 21 588 536 75  
 F: + 86 21 588 534 71  
 E: minsheng.port@online.sh.cn

**Shanghai**

**Shanghai Port Luojiang Bulk Terminals**  
 8 Shi Gang Road, Baoshan District  
 Shanghai  
 China  
 Contact: Mr Shao Xue Kang  
 Managing Director  
 T: + 86 21 6323 1871  
 F: + 86 21 6323 0184

**Shantou**

**Shantou Port**  
 Shantou Port Affairs Bureau  
 1 Shang Ping Road  
 Shantou  
 Guangdong 515011  
 China  
 Contact: Mr Shen Jingchang  
 T: + 886 754 893 2345  
 F: + 86 754 885 0425

**Shenzhen**

**Shekou Port Service Co Ltd**  
 Gang Wan Yi Lu  
 Shekou Industrial Zone  
 Shekou  
 Shenzhen  
 Guangdong Province 518067  
 China  
 Contact: Mr J Gao  
 T: + 86 755 699 1135  
 F: + 86 755 688 5859

**Shenzhen**

**Shenzhen Yantian Port**  
 Yantian Port Group Co  
 7/F Shatoujiao Office Building  
 Shenzhen 518090  
 China  
 Contact: Mr Ding Tong Liu  
 Administrator  
 T: + 86 755 8379 7111  
 F: + 86 755 8379 7138

**Shenzhen**

**Shenzhen Haixin Harbour Development Co Ltd**  
 Mawan Port  
 Nanshan District  
 Shenzhen  
 Guangdong 518052  
 China  
 Contact: Mr Zhou Zhong  
 Port Manager  
 T: + 86 755 669 3755  
 F: + 86 755 667 9353

**Shenzhen**

**Chiwan Port Authority**  
 c/o China Ocean Shipping Agency  
 Gangwan Yi Road, Shekou  
 Shenzhen  
 Guangdong 518067  
 China  
 Contact: Mr Du Xiaokun  
 T: + 86 755 2669 4888  
 F: + 86 755 2669 4297

**Shijiazhuang**

**Hebei Port Group Co, Inc**  
 35 Yuhuang Road  
 Shijiazhuang  
 Heibei  
 050019  
 China  
 Contact: Mr Edward Wong  
 Chief, Public Relations  
 T: + 86 311 8780 0528/+ 86 335 309 4924  
 F: + 86 311 8790 0111  
 E: wangcong@portqhd.com  
 W: www.porthbebei.com

**Taizhou City**

**Port of Haimen**  
 Port Administration Office  
 Jiaojiang District  
 Taizhou City  
 Zhejiang Province  
 318000  
 China  
 Contact: Mr Ji Jie Chao  
 Port Director  
 T: + 86 576 822 4571  
 F: + 86 576 888 1169

**Tanggu**

**Tianjin Xingang Sinor Terminal Co Ltd**  
 No 1 Road East Xingang  
 Tanggu  
 Tianjin  
 300456  
 China  
 Contact: Mr Svein Weie  
 General Manager  
 T: + 86 22 2570 6666  
 F: + 86 22 2570 6969  
 E: sw@gearbulk.com  
 W: www.gearbulk.com

**Tanggu**

**Tianjin Port Authority**  
 2 Xingang Road  
 Gate 35  
 Tanggu  
 Tianjin 300456  
 China  
 Contact: Mr Lin Chen  
 Division Chief  
 T: + 86 22 2570 5239  
 F: + 86 22 2570 9747

**Tangshan**

**Jintang Port**  
 Harbour Administration Office  
 Haigang  
 Development Zone  
 Tangshan  
 Hebei  
 063600  
 China  
 T: + 86 315 291 4059  
 F: + 86 315 291 4287

**Wenzhou**

**Wenzhou Port**  
 Wenzhou Port Affairs Bureau  
 7th and 8th Floor  
 Jiangrun Mansion  
 Jiangbin Road  
 Wenzhou  
 Zhejiang Province  
 325000  
 China  
 Port Director  
 T: + 86-577-88192999  
 F: + 86-577-88186775  
 E: office@wzport.com

**Wuhu**

**Wuhu Port Authority**  
 Port Administration Office  
 32 Jiang'an Rd  
 Wuhu  
 Anhui Province  
 241000  
 China

Port Master  
 T: + 86 553 383 9153  
 F: + 86 553 381 1064

**Xiamen**

**Xiamen Harbour Authority**  
 127 Dongdu Road  
 Xiamen  
 Fujian Province  
 361012  
 China  
 Contact: Mr Huang He Rong  
 Manager  
 T: + 86 592 561 4889  
 F: + 86 592 561 2682  
 E: xpgco@public.xm.fj.cn  
 W: www.portxiamen.com.cn

**Yantai**

**Yantai Port Authority**  
 Yantai Port Group Limited  
 155 Beima Road  
 Shandong Province  
 264000  
 China  
 Contact: Mr Liu Zhen Hu  
 General Manager  
 T: + 86 535 674 2134  
 F: + 86 535 624 1892  
 E: ytport@yantaiport.com.cn  
 W: www.yantaiport.com.cn

**Yingkou**

**Port of Yingkou**  
 Yingkou Harbour Administration  
 1 Xingang Road  
 Bayuquan District  
 Yingkou  
 Liaoning  
 115007  
 China  
 Port Director  
 T: + 86 417 625 1778  
 F: + 86 417 625 1523

**Zhanjiang**

**Zhanjiang Port Authority**  
 Ganggu Road  
 Zhanjiang  
 Jiangsu Province 215633  
 China  
 Contact: Mr Zhent Riqiang  
 Managing Director  
 T: + 86 759 2250102  
 F: + 86 759 2280814  
 E: zjport@163.net  
 W: www.zjport.com

**Zhanjiang**

**Zhanjiang Port Authority**  
 Port Administration Office  
 1 You Yi Rd, Xiashan  
 Zhanjiang  
 Guangdong  
 524027  
 China  
 Contact: Mr Liang da Tong  
 Managing Director  
 T: + 86 759 225 5516  
 F: + 86 759 228 0814

**Zhenjiang**

**Zhenjiang Port Authority**  
 Administration Office  
 19 Changjiang Road  
 Zhenjiang  
 Jiangsu Province  
 212001  
 China  
 Contact: Mr Xia Mao Xiang  
 Harbour Master  
 T: + 86 511 527 4892  
 F: + 86 511 257 7837  
 E: zjport@163.net

**Zhoushan**

**Zhoushan Port Administrative Bureau**  
 1 Ding Harbor Terminal

Zhoushan  
 Zhejiang  
 China  
 Contact: Mr Sheng Liding  
 Director  
 T: + 86 580 206 7164  
 E: zsgwj@sina.com  
 W: www.zsport.com.cn/english

**Zhoushan**

**Zhoushan Port Haitong Transshipment & Storage Co Ltd**  
 Loatangshan Port Area  
 Dinghai  
 Zhoushan  
 316043  
 China  
 Contact: Ms Li Yading  
 General Manager  
 T: + 86 580 801 0202  
 W: www.zsport.com.cn/english

**COLOMBIA**

**Barranquilla**

**ETE COLOMBIA SAS**



Oficina 708  
 Calle 77B No. 59-61 Centro  
 Empresarial Las Americas Torre 2  
 Barranquilla  
 Atlantico  
 Colombia  
 Contact: Capitan de Navio Mauricio Bejarano  
 T: +(57-5) 3198374 / 3195956/  
 cell +573114156906  
 E: mauricio.bejarano@  
 etecolombiasas.com.co  
 E: berta.rodriguez@  
 etecolombiasas.com.co  
 W: www.ete.pt  
 Location: North of Colombia –  
 Atlantic Coast  
 Equipment & Capacity: 1 floating  
 crane, 1 pusher + 1 barge  
 ETE Colombia operates a river and  
 port train tug and barge, as well as  
 floating cranes loading ocean going  
 vessels.

**Barranquilla**

**Sociedad Portuaria Del Norte**  
 Calle 2  
 No. 41N - 28  
 Barrio Villanueva  
 Barranquilla  
 Atlantico  
 Colombia  
 Contact: Mr Carlos Rosado  
 General Manager  
 T: + 575 344 57 37  
 F: + 575 344 6814  
 E: crosado@spdelnorte.com  
 W: www.spdelnorte.com

**Barranquilla**

**Cementos del Caribe**  
 Via 40 Las Flores  
 Barranquilla  
 Colombia  
 Contact: Mr Enrique Esparragoza  
 Shipping Manager  
 T: + 57 5 361 9389  
 E: eesparagoza@argos.com.co

**Barranquilla**

**Port of Puerto Bolivar**  
 International Colombia Resources  
 Corporation  
 Apartado Aero 52499  
 Barranquilla  
 Colombia  
 Contact: Capt Steve C Catton  
 Port Superintendent

T: + 57 53 799545  
 F: + 57 53 502121  
 E: oprpbv@navescolombia.com  
 W: www.navescolombia.com/  
 ports/pbolivar.htm

**Barranquilla**  
**Sociedad Portuaria Regional de Barranquilla SA**

Carrera 38  
 Calla 1a Orilla del Rio  
 Terminal Maritimo y Fluvial de Barranquilla  
 Barranquilla  
 Colombia  
 Contact: Mr Pablo Riveira  
 Operations Manager  
 T: + 575 37 16200  
 F: + 575 37 16310  
 E: priveira@sprb.com.co  
 W: www.sprb.com.co

**Barranquilla**  
**Carbones del Carrejon LLC**

Cra 54 # 72-80  
 Barranquilla  
 Colombia  
 Contact: Mr Ricardo Acosta  
 T: + 57 53 50 6802  
 F: + 57 53 50 2111  
 E: ricardo.acosta@carrejoncoal.com  
 W: www.carrejon.com  
 Location: North coast of Colombia  
 Equipment & Capacity: 28 Mtpa

**Barranquilla**  
**Sociedad Portuaria Golfo de Morrosquillo SA**

Via 40 Las Flores  
 Cementos Argos SA  
 Barranquilla  
 Atlantico  
 575  
 Colombia  
 Contact: Mr Uriel Duarte  
 Terminal Director  
 T: + 575 3619 233  
 F: + 575 3619 222  
 E: uduarte@argos.com.co  
 W: www.argos.com.co  
 Location: North East coast of Colombia  
 Equipment & Capacity: Movable shiploader & 900tph  
 Bulk Berths: 250m piled platform  
 Total uncovered Storage: 85,000sqm  
 Total covered Storage: 6,000sqm  
 Presently building a second berthing position to accommodate an additional large vessel.

**Barranquilla**

**Tolu**  
 c/o Tolcementos  
 Carrera 58 Nos 75-78  
 Barranquilla  
 Colombia  
 Contact: Mr Enrique Olarte  
 T: + 57 58 451 288  
 F: + 57 58 454 548  
 W: www.navescolombia.com/  
 ports/tolu.htm  
 Bulk Berths: Max LOA 200m, Max Draft alongside 34ft., Max Beam 30m

**Bogota**

**Santa Marta Coal Terminal**  
 Carbanandes  
 Transv 19 No 122-42  
 Bogota  
 Colombia  
 Contact: Mr Jairo Caicedo  
 T: + 57 1 248 7034  
 F: + 57 3 310 2544330  
 E: jairoca@cc-net.net

**Bogota**

**Puertos de Colombia**  
 Carrera 10a No 15-22  
 Piso 10  
 Bogota

Colombia

**Buenaventura**  
**Sociedad Portuaria Regional de Buenaventura S.A**

Avenida Portuaria  
 Edificio Administracion  
 Buenaventura  
 Colombia  
 Contact: Ms Matilde Correa  
 T: + 57 2 691 4348  
 F: + 57 2 691 43 52  
 E: matildec@sprbun.com  
 W: www.sprbun.com

**Santa Marta**

**Port of Santa Marta**  
 Carrera 1 No. 10 A – 12  
 Santa Marta  
 Magdalena  
 AA655  
 Colombia  
 Contact: Mr Rodolfo Schmulson  
 Commercial Director  
 T: + 57 5 4217970 ext 103  
 F: + 57 5 4212161  
 E: comercial@spsm.com.co  
 W: www.spsm.com.co  
 Location: Located at the northwest end of Santa Marta-Colombia.  
 Equipment & Capacity: Shore crane: 104 tons  
 Mobile crane: 50 tons  
 Reach Stacker: 45 tons  
 Low Boy: 70 tons  
 Forklift: 2,5; 3,0; 5,5; 7,0; 15,0 tons  
 Electric Forklift: 2,4 y 3,8 tons  
 Pallet Jack: 2,0 y 2,72 tons  
 Trucks: 35 tons  
 2 STS CRANES: 100 tons each  
 4 RTG'S: 50 tons each  
 Pneumatic unloading system (VIGAN): 600 ton/h  
 Bulk Berths: Berth # 4: Longitud 240 Mts, Calado 46'  
 Berth # 5: Longitud 94 Mts, Calado 25'  
 Berth # 6: Longitud 150 Mts, Calado 60'  
 Berth #7: Longitud 156 Mts, Calado 55'  
 Total uncovered Storage: 35,000sqm  
 Total covered Storage: 4 warehouses: 6,400 m2  
 5 automated grain warehouses with storing capacity: 31.500 tons  
 Metallic Storage Silo facility: 69.000 tons  
 The Port serves Colombian foreign commerce on a 24-hour daily basis all year round. It further provides the benefits of a safe storage within its yards and warehouses.  
 Plan of Expansion designed towards the specialization of the Container, Grain, General Cargo and Coal Sub Terminals.

**Santa Marta**

**Puerto Prodeco**  
 Centro Comercial Prado Plaza  
 Cra 4 C126A Esq 3er  
 Santa Marta  
 Colombia  
 Contact: Mr Andrew Lyons  
 T: + 57 5 4 21 4400  
 F: + 57 5 4 21 4698

**Sociedad Portuaria Santa Marta**

**CTS de Colombia**  
 Crra. La. #10A-12  
 Muelle 6  
 Soceidad Portuaria Santa Marta  
 Colombia  
 Contact: Mr Scott Harcourt  
 Project Manager  
 T: + 57 54 211 754  
 F: + 57 54 233 369  
 E: scott.harcourt@coopertsmith.com

**CONGO**

**(REPUBLIC**

**OF)**

**Pointe Noire**

**Port Authority of Pointe Noire**  
 PO Box 711  
 Pointe Noire  
 Congo (Republic of)  
 Administration Officer  
 T: + 242 940052  
 F: + 242 942042  
 Location: Lat: 4° 47' 4" S  
 Long: 11° 49' 58" E  
 Bulk Berths: Cargo pier max depth: 3.4m - 4.6m

**CROATIA**

**Ploce**

**Port of Ploce Authority**  
 Trg Kralju Tomoslava 21  
 Ploce  
 20340  
 Croatia  
 Contact: Captain Ivan Maric  
 Assistant to Executive Director  
 T: + 385 20 414 541  
 F: + 385 20 670 271  
 E: pfso-maric@port-authority-ploce.hr  
 W: www.port-authority-ploce.hr

**Rijeka**

**Terminal Bakar**  
 LUKA Rijeka dd  
 Riva 1  
 Rijeka  
 51000  
 Croatia  
 Contact: Mr Alen Sikic  
 Terminal Manager  
 T: + 385 51 496 000 / 4969 40  
 F: + 385 51 332 203  
 E: info@lukarijeka.hr  
 W: www.lukarijeka.hr

**Rijeka**

**LUKA Rijeka d.d.**  
 Riva 1  
 Rijeka  
 Hrvatska  
 51000  
 Croatia  
 Contact: Ms Tatjana Kriiic  
 President  
 T: + 385 51 496 000  
 E: marketing@lukarijeka.hr  
 W: www.lukarijeka.hr

**Zadar**

**Zadar Port Authority**  
 Lucka Kapetanija  
 Liburnska Obala 8  
 Zadar  
 57000  
 Croatia  
 Contact: Mr Milivoj Maricic  
 Harbour Master  
 T: + 385 23 254 888  
 F: + 385 23 254 876  
 E: lucka-uprava-zadar@zd.t-com.hr

**CUBA**

**Antilla**

**Antilla Port Authority**  
 Avenida 28 de Enero No 65  
 Apartado No 33  
 Antilla  
 Province de Holgium  
 Cuba  
 Contact: Mr Ramon Pavon  
 Harbour Master  
 T: + 53 24 88248

F: + 53 24 88437  
 E: cantilla@enet.cu

**Antilla**

**Nicaró**  
 c/o Agencia de Antilla  
 Avenida 28 de Enero No 65  
 Apartado No 33  
 Antilla  
 Prov de Holguin  
 Cuba  
 Port Manager  
 T: + 53 24 88248  
 F: + 53 24 88127

**Antilla**

**Port of Felton**  
 c/o Agencia de Antilla  
 Avenida 28 de Enero No 65  
 Apartado No 33  
 Provenida de Antilla  
 Antilla  
 Cuba  
 Contact: Mr Ramon Pavon  
 Port Manager  
 T: + 53 24 88248/88225  
 F: + 53 248 8437

**Cardenas**

**Port of Cardenas**  
 c/o Agencia Cardenas  
 Calle 2 entre Cespedes y Ave 2da  
 Apartado No 2847  
 Cardenas  
 Prov de Mantanzas  
 Cuba  
 @with line:

**Cienfuegos**

**Port of Cienfuegos**  
 c/o Agencia Cienfuegos  
 PO Box 420  
 Avenida 50  
 Cienfuegos  
 No 2712  
 Cuba  
 Contact: Mr M Roderiquez  
 Port Manager  
 T: + 53 432 27455  
 F: + 53 432 8466

**Havana**

**Port Authority of Havana**  
 Ministry of Transport  
 c/o Agencia Havana  
 Lamprilla No2  
 Havana  
 Cuba  
 Contact: Mr Miguel Izquierdo  
 Port Captain  
 T: + 53 7 61 6706

**Mariel**

**Port of Mariel**  
 c/o Agencia Mariel  
 Avenida 65 No 12411 124-126  
 Apartado No 5  
 Mariel  
 Cuba  
 Contact: Mr Manuel Ares  
 Director  
 T: + 53 92305  
 F: + 53 639 2510

**Matanzas**

**Port Authority of Matanzas**  
 c/o Agencia Matanzas  
 Milanes No 28002  
 Apartado No 245  
 Matanzas  
 Cuba  
 Contact: Mr Orestes Bravo  
 Manager  
 T: + 53 52 3804  
 F: + 53 52 3804

**Puerto Tarafa Nuevitas**

**Port of Nuevitas**  
 Agencia Nuevitas  
 PO Box 350  
 Puerto Tarafa Nuevitas

Province de Camaguey  
 Cuba  
 Contact: Mr D Jose  
 Manuel Tores  
 T: + 53 322 4646  
 F: + 53 322 4646

**Santiago de Cuba**

**Port of Santiago de Cuba**  
 Avenida Jesus Menendez No 658  
 Apartado No 522  
 Santiago de Cuba  
 Prov de Oriente  
 Cuba  
 Contact: Mr Ruben Callard  
 Port Master  
 T: + 53 2262 8543  
 F: + 53 2268 6274

**CURACAO**

**Wilemstad**

**Curacao Ports Authority**  
 Harbour Office  
 Werf de Wilde z/n  
 Wilemstad  
 Curacao  
 Contact: Mr Dimitri Cloose  
 Commercial & Marketing Manager  
 T: + 599 9 434 5922  
 F: + 599 9 461 3907  
 E: D.Cloose@curports.com  
 W: www.curports.com  
 Location: uth Coast of Curacao at the Port of Wilemstad or Fuikbay  
 Equipment & Capacity: 3 multi-purpose cargo quays at Brionwharves at the Port of Wilemstad, length: 305m, draught: 10.2m, plus platform for RO/RO  
 2 berths at Fuikbay, length: 109.7m, draught 7.3m, conveyer & loading tower with 8.53 fixed arm (150 tph)  
 Bulk Berths: Multi-purpose cargo (Wilemstad), phosphate and limestone shipment, cement storage silos, 5,500 Tonnes (Fuikbay)

**CYPRUS**

**Nicosia**

**Cyprus Port Authority**  
 PO Box 2007  
 Nicosia  
 1516  
 Cyprus  
 Contact: Mr Y Kokkinos  
 General Manager  
 T: + 357 2 450100  
 F: + 357 2 365420  
 E: cpa@cylanet.com.cy  
 W: kypros.org/CPA/

**Nicosia**

**Vassiliko Cement Works Ltd**  
 PO Box 22281  
 Nicosia  
 1519  
 Cyprus  
 Contact: Mr Georgios Stavrou  
 Technical Manager  
 T: + 357 24 845 504  
 F: + 357 24 332651  
 E: g.stavrou@vassiliko.com  
 W: www.vassiliko.com

**Nicosia**

**Port of Vassiliko c/o Cyprus Ports Authority**  
 PO Box 22007  
 Nicosia  
 1516  
 Cyprus  
 Contact: Captain G. Mousoulotis  
 Operations Manager  
 T: + 357 248 15 225  
 F: + 357 246 35 630  
 E: gmousoulotis@cpa.gov.cy  
 W: www.cpa.gov.cy



Location: Latitude  
34° 43' 0 N  
Longitude 033° 19' 0 E  
Equipment & Capacity: Grabs & mobile shore cranes  
Bulk Berths: 9m depth, max draught 8.5m  
Total uncovered Storage: 20,000sqm  
Private Port :  
Operated by Vassiliko Cement Works Co.

**Nicosia**

**Vassiliko Port**  
PO Box 22281  
Nicosia  
1519  
Cyprus  
Contact: Mr Marios Averkiou  
General Manager  
T: + 357 24845305  
F: + 357 24845413  
E: m.averkiou@vassiliko.com

**Nicosia**

**Lemesos Port c/o Cyprus Port Authority**  
PO Box 22007  
Nicosia  
1516  
Cyprus  
Contact: Captain George Pours  
Port Manager  
T: + 357 258 19200  
F: + 357 255 66374  
W: www.cpa.gov.cy  
Location: Latitude E  
34 40° N  
Longitude E 33 02° E  
Equipment & Capacity: Conveyor belt, grabs, pneumatic machinery-vacuum  
Bulk Berths: 10.40-12m depth  
Silo 70,000 ton capacity approximate

**DENMARK**

**Aabenraa**

**Ensted Transit Harbour I/S**  
Flensborgvej 185  
Aabenraa  
Jutland  
6200  
Denmark  
Contact: Mr Chresten Nissen  
Harbour Master  
T: + 45 99 55 1500  
F: + 45 74 62 05 00  
E: chrni@dongenergy.dk  
W: www.dongenergy.dk  
Location: Port of Ensted is located at Aabenraa Inlet, 55°01.5'N 9°26.5'E - nautical map no. 159.  
Equipment & Capacity: 1 CSU & 1 GUL - 2,000 mtpH  
Bulk Berths: Import quay = 350m. Export quay = 325m.  
Total uncovered Storage: 115,000 m2  
Ensted Transit Harbour is the largest transshipment terminal for coal in Northern Europe.

**Aabenraa**

**Aabenraa Havn Port Authority**  
Aabenraa Port  
Mellemvej 25  
Aabenraa  
DK 6200  
Denmark  
Contact: Mr Henrich  
Port Manager  
T: + 45 74 62 25 14  
F: + 45 74 62 31 43  
E: port@aabenaarakom.dk  
W: www.aabenaaraport.dk

**Aalborg**

**Port of Aalborg**  
PO Box 8530  
Langerak 19  
Aalborg

9220  
Denmark  
Contact: Mr. Jasper  
T: + 45 9930 1500  
F: + 45 9930 1515  
E: info@aalborghavn.dk  
W: www.aalborghavn.dk  
Location: Denmark  
Equipment & Capacity: 3 mobile harbour cranes  
Capacity about 200tph each  
Bulk Berths: More berths. Up to 400m draught. Max: 9.30m  
Total uncovered Storage: approx. 5,000sqm  
Total covered Storage: approx. 4,000sqm

**Aalborg**

**Aalborg Bulk Terminal**  
Østhaven  
Aalborg  
DK-9000  
Denmark  
Contact: Mr Lars Andersen  
T: + 45 982 577 00  
E: inter@mail.tele.dk  
Equipment & Capacity: 35,000 t  
Total covered Storage: 7,500sqm

**Aalborg**

**Aalborg Portland**  
Rordalsvej 44  
PO Box 165  
Aalborg  
DK 9100  
Denmark  
Contact: Mr Morten Knudsen  
T: + 45 99 33 77 41  
F: + 45 99 33 77 21  
E: mk@aalborg-portland.dk  
W: www.aalborg-portland.dk

**Aarhus**

**Port of Aarhus**  
PO Box 130  
Mindet 2  
Aarhus  
DK - 8100  
Denmark  
Contact: Mr Bjarne Mathiesen  
Port Director  
T: + 45 89 36 82 02  
F: + 45 86 12 76 62  
E: bm@port.aarhus.dk  
W: www.aarhushavn.dk

**Aarhus**

**Cargo Service A/S**  
Oceanvej 13  
Aarhus DK 8000  
Denmark  
Contact: Mr Lars Krabbe  
Managing Director  
T: + 45 8730 8000  
F: + 45 8730 8101  
E: info@cargoservice.dk  
W: www.cargoservice.dk  
Location: Central Denmark  
Total uncovered Storage: 400,000sqm  
Total covered Storage: 17,000sqm

**Bandholm**

**Port of Bandholm**  
c/o Knuthenborg Godskontor  
Birketvej 1  
Havneplassen 6  
Bandholm  
4941  
Denmark  
Contact: Mr N A Hovmand  
Port Manager  
T: + 45 54 76 36 11  
F: + 45 53 88 80 11  
E: alfr@hovmand.dk  
W: www.hovmand.dk

**Charlottenlund**

**Copenhagen Merchants**  
Lindegårdsvej 17  
Charlottenlund

DK 2920  
Denmark  
Contact: Mr Simon Rodian  
Christensen  
T: + 45 3996 5308  
F: + 45 3963 1057  
E: src@copmer.dk  
W: www.copmer.com  
Location: Kalundborg Bulk Terminal  
I/S: Kalundborg, Denmark (North West of Zealand)  
Fredericia Bulk Terminal I/S:  
Fredericia, Denmark.

Aalborg Bulk Terminal: Aalborg, Denmark.  
Grenaa Bulk Terminal, Grenaa, Denmark  
Gdansk Bulk Terminal, Gdansk, Poland  
CM Terminal, Banie, Poland  
Danstore, Liepaja, Latvia  
Equipment & Capacity: Kalundborg: 600-900 tph  
Fredericia: 300-600 tph  
Aalborg: 300-400 tph  
Grenaa: 300-400 tph  
Gdansk: 400 tph  
Banie: 200 tph  
Danstore: 1,000 tph  
Bulk Berths: Kalundborg: 230 m, 11.6 m draught (brackish)  
Fredericia: 400m, 13.5 m draught  
Aalborg: 400m, 9.5 m draught  
Grenaa: 400m, 11.0 m draught  
Gdansk: 150m, 7.6m draught  
Liepaja: 450m, 10.0m draught  
Total uncovered Storage: Kalundborg: 1,400 sqm  
Fredericia: 2,000 sqm  
Grenaa: 2,000 sqm  
Total covered Storage: Kalundborg: 23,000 sqm - 110,000 mt  
Fredericia: 20,500 sqm - 100,000 mt  
Aalborg: 7,000 sqm - 35,000 mt  
Grenaa: 8,000 sqm - 30,000 mt  
Gdansk: 3,000 sqm - 38,000 mt  
Banie: 5,000 sqm - 38,000 mt  
Liepaja: 9,000 sqm - 90,000 mt  
Kalundborg Bulk Terminal is the largest export terminal in Denmark for grains.  
Fredericia Bulk Terminal is particularly involved in exports of malting barley, imports of feedstuffs, imports/bagging of wood pellets/salt/fertilizer, and containerization of bulk commodities.  
Grenaa Bulk Terminal is a specialised wood pellet terminal that however also handles grains and feedstuffs.  
Gdansk Bulk Terminal is focusing on exports of grains and imports of feedstuffs and biomass.

CM Terminal is an inland grain facility. Danstore is focused on exports and imports of grains, feedstuffs and wood pellets.

**Copenhagen**

**Copenhagen Malmo Port AB**  
Containervej 9  
PO Box 900  
Copenhagen  
DK-2100  
Denmark  
Contact: Mr Soren Balken  
Marketing Coordinator  
T: + 45 3546 1112  
F: + 45 3546 1164  
E: soren.balken@cmport.com  
W: www.cmport.com  
Location: Copenhagen Malmo Port is located in the Øresundregion with terminals in both Denmark and Sweden  
Equipment & Capacity: CMP: 3 stationary cranes 20 tons  
1 mobilecrane 64 tons, capacity 12,000 tonnes of coal a day  
2 multidocker, 1 Fuchs  
Bulk Berths: CMP facilities:  
Swede Harbour/1001,1002 - 200m - 13.5m  
Sødra Bulk/ 740, 750, 751 - 6.0m  
Prøvestenen/855,856,857,858,859,86

0,861 - 679m - 10.5 - 6.0m  
Prøvestenen/862,863 - 250m,  
864,865,866 - 400m  
Private operators:  
Amagerværket/835,836,837,838 - 440m - 12.0m  
Margretheholm/825 - 140m - 6.0m  
Kalkbrænderihavnen/401,402 - 230m - 6.7m  
Total uncovered Storage: Approx 680,000sqm  
Total covered Storage: 28,500sqm

**Esbjerg**

**Port of Esbjerg**  
Hulvejen 1  
Esbjerg  
DK-6700  
Denmark  
Contact: Mr Sorens Stougaard  
T: + 45 75 13 4144  
F: + 45 75 13 4050  
E: adm@portesbjerg.dk  
W: www.port-of-esbjerg.dk

**Fredericia**

**Fredericia Bulk Terminal c/o Fredericia Shipping**  
Moellebugtvej 5  
Fredericia  
DK-7000  
Denmark  
Contact: Mr Johnny B. Nielsen  
Commercial Terminal Manager  
T: + 45 76 20 20  
F: + 45 76 20 25  
E: bulk@fredericiashipping.dk  
W: www.fredericiashipping.dk  
Location: Denmark, East coast of Jylland  
Equipment & Capacity:  
Cranes/Conveyor - 600 tph load  
Bulk Berths: Up to 14m draught - 350 m length  
Total uncovered Storage: 10,000sqm  
Total covered Storage: 12,000sqm

**Fredericia**

**DLA Agro**  
Centerhavnsvej 13  
Fredericia  
DK-7000  
Denmark  
Contact: Ms Heidi  
T: + 45 7921 2133  
F: +45 79 21 21 79  
E: jhl@dlagro.com  
W: www.dla.dk

**Fredericia**

**Associated Danish Ports A/S Port of Fredericia**  
Vesthavnsvej 33  
Fredericia  
DK-7000  
Denmark  
Contact: Mr Ole Haugsted  
Jørgensen  
Sales & Marketing Manager  
T: + 45 79 21 50 35  
F: + 45 79 21 50 05  
E: ohj@adp-as.dk  
W: www.adp-as.com  
Location: Located at the Great Belt at the entrance to the Baltic Sea.  
Equipment & Capacity: 10 cranes (3 mobile). Capacity 500 - 600 tph/crane depending upon commodity.  
Bulk Berths: Several bulk berths - water depths down to 15m, ice-free  
Total covered Storage: 20,000sqm  
Specialized in direct discharge into trucks. Short distance to motorway system.

**Grenaa**

**Grenaa Bulk Terminal**  
Neptunvej 8  
Grenaa  
Denmark  
Contact: Mr Klaus Andersen

T: + 45 76 20 20 02  
E: bulk@fredericiashipping.dk

**Grenaa**

**Port of Grenaa Ltd.**  
Grenaa Harbour  
Nordhavnsvej 1  
Grenaa  
8500  
Denmark  
Contact: Mr Henning Laursen  
Manager  
T: + 45 87 58 76 00  
F: + 45 86 32 43 71  
E: info@port-of-grenaa.com  
W: www.port-of-grenaa.com

**Haderslev**

**Port of Haderslev**  
PO Box 11  
Havnekontar  
Honnoerkajen 3  
Haderslev  
6100  
Denmark  
Contact: Mr J C Hansen  
Harbour Master  
T: + 45 7452 2404  
F: + 45 7452 5639  
E: jchansen@vip.cybercity.dk

**Horsens**

**Port Authority Horsens**  
Ove Jensens Alle 35  
Horsens  
8700  
Denmark  
Contact: Mr Peter Larsen  
Port Manager  
T: + 45 75 62 10 14/14 33  
F: + 45 75 62 14 57  
E: pchl@horsens.dk  
W: www.horsenshavn.dk

**Kalundborg**

**Asnaes Power Station**  
Asnaes Port Authority  
Asnaesvej 16  
Kalundborg  
4400  
Denmark  
Contact: Mr Arne Krogh  
Manager  
T: + 45 59 55 0600  
F: +45 9955 0699  
E: ark@e2.dk  
W: www.e2.dk

**Kalundborg**

**Kalundborg Port Authority**  
Baltic Plads 2  
Kalundborg 4400  
Denmark  
Contact: Mr Bent Rasmussen  
Port Director  
T: + 45 5953 4000  
F: + 45 5953 4003  
E: info@portofkalundborg.dk  
W: www.portofkalundborg.dk  
Location: At the head of a sheltered inlet in Kalundborg Fjord, on the W coast of Sjælland, at the Great Belt  
Equipment & Capacity: 2 gantry rocker cranes (on rail) each 300 ts/hour  
1 mob. harbourcrane 300 ts/hour  
1 mobile crane 200 ts/hour  
Bulk Berths: Suothharbour (12+13) 445 mtrs - draught 11,60 mtrs.  
Eastharbour (05+06) 320 mtrs - draught 9,60 mtrs.  
Eastharbour (09) 230 mtrs / - draught 7,50 mtrs  
Eastharbour (09) 245 mtrs / - draught 7,50 mtrs.  
Vestharbour (01) 250 mtrs - draught 5,30 mtrs  
Total covered Storage: 46.500 sqm  
Cap. covered Grain Storage: 177.000 tons.

## Kalundborg

**Kalundborg Bulk Terminal**  
Schultz Shipping A/S  
Vestre Havneplads 2  
Kalundborg  
DK-4400  
Denmark  
Contact: Mr Simon Rodian  
Christensen  
T: + 45 3996 5300  
F: + 45 3963 1057  
E: src@copmer.dk  
W: www.schultzshipping.com or  
www.copmer.dk

## Kolding

**Kolding Port Authority**  
Jens Holmsvej 1  
Kolding  
6000  
Denmark  
Harbour Master  
T: + 45 75 50 20 66  
F: + 45 75 50 20 58  
E: info@koldingport.dk  
W: www.koldingport.dk

## Korsoer

**Port of Korsøer**  
Amerikakajen 1  
Korsøer  
DK-4220  
Denmark  
Contact: Mr Jesper Kokholm  
Harbour Master  
T: + 45 5837 0085  
F: + 45 5835 2598  
E: info@portofkorsøer.com  
W: www.portofkorsøer.com

## Næstved

**Næstved Port**  
Toldbodgade 4  
Næstved  
4700  
Denmark  
Contact: Mr Jesper Pietersen  
Harbour Master  
T: + 45 55 78 51 82 / +45 55 98 5200  
5598 5200  
F: + 45 55 72 51 83  
E: port@naestvedport.dk  
W: www.naestvedport.dk

## Nakskov

**Nakskov Port**  
Havnegade 2  
Nakskov  
4900  
Denmark  
Contact: Mr Hans Borchensen  
Harbour Master  
T: + 45 54 67 73 30  
F: + 45 54 92 51 13  
E: havne@lolland.dk  
W: www.nakskovhavn.dk

## Nykøbing

**Nykøbing Port Authority**  
Havnevej 32  
Nykøbing  
Mors  
Denmark  
Contact: Mr B F Nielsen  
Harbour Master  
T: + 45 53 41 00 77 / 45 97 72 00 49  
F: + 45 53 41 11 30  
E: nykobingmhavn@hotmail.com  
W: www.morshavn.dk

## Nykøbing Falster

**Guldborgsund Havne**  
Port Office  
Fejøgade 2  
Nykøbing Falster  
4800  
Denmark  
Contact: Laila Nielsen  
Harbour Manager  
T: + 45 54 85 05 63

F: + 45 54 82 05 64  
E: lel@guldborgsund.dk  
W: www.guldborgsundhavn.dk  
Location: Isle of Falster  
Ports of Guldborgsund content:  
Port of Nykøbing Falster (Comm. Port)  
Port of Orehoved (Comm. Port)  
Port of Stubbekøbing (Comm. And)  
Port of Gedser (fishing port)

## Odense

**Port of Odense**  
Londongade 1  
Odense  
5000  
Denmark  
Contact: Mr Finn Vinther  
Harbour Master  
T: + 45 66 12 07 92  
F: + 45 65 91 47 74  
E: info@odensehaven.dk  
W: www.odensehavn.dk

## Randers

**Randers Port**  
Kulholmsvej 1  
Randers  
8900  
Denmark  
Contact: Mr John Morgen  
Harbour Director  
T: + 45 86 42 10 57  
F: + 45 86 40 71 81  
E: john.morgen@randers.dk  
W: www.randershavn.dk  
Location: Close to the Eastcoast of Jutland, with access to the sea Kattegat  
Equipment & Capacity: One rail situated coal crane . Several mobile cranes of up to 140 t. Molasses pipe line connections of 6" and 8".  
Bulk Berths: Maximum size of vessel: LOA 145 m ; Breadth 19 m  
Several areas available for storage of cargo. Temporarily storage on keyside also possible.

## Rodby

**Rodby Port Authority**  
c/o Scandlines  
Ostre Kaj 3  
Rodby  
4970  
Denmark  
Contact: Mr Torben Christiansen  
Port Captain  
T: + 45 54 605722  
F: + 45 54 605722  
E: torben.christiansen@scandlines.dk

## Roenne

**Roenne Port Authority**  
Munch Peterson's Way no. 2  
Roenne  
3700  
Denmark  
Contact: Mr Hans Kumler  
Harbour Master  
T: + 45 56950678  
F: + 45 56950631  
E: hk@roennehavn.dk

## Roenne

**Port of Roenne Ltd.**  
Munch Petersens Vej 2  
PO Box 47  
Roenne  
3700  
Denmark  
Contact: Mr Hans Kumler  
Port Director  
T: + 45 56 95 06 78  
F: + 45 56 95 06 31  
E: hk@roennehavn.dk  
W: www.roennehavn.dk  
Location: The Baltic  
Equipment & Capacity: 2 Demac Cranes - Mc 300  
1 Liebherr 954 B

Other commodities: Broken stone products.

## Roenne

**BAF (Bornholms Andels Foderstofforretning)**  
Port of Rønde  
Roenne  
Denmark  
Contact: Mr Cladio Pelsen  
+ 45 33 68 44 00  
T: + 45 5694 3000  
F: + 45 5694 3009  
E: info@baf.dk  
W: www.baf.dk

## Skaelskor

**Skaelskor Port Authority**  
Skaelskor Havnekontoret  
Næstvedvej 15  
Skaelskor  
4230  
Denmark  
Contact: Mr Jacob Lund  
T: + 45 58 19 80 17  
F: + 45 53 59 03 57  
E: skaelskor-havn@skaelskor.dk

## Skaelskor

**Stignæsvaerkets Port Authority**  
S K Energi  
Sjællandske Kraftvaerker  
Stignæsvaerket  
Skaelskor  
4230  
Denmark  
Contact: Mr John Slangstrup  
Slangstrup  
Port Manager  
T: + 45 58 16 40 00  
F: + 45 58 16 40 40  
E: sla@e2.dk

## Skoodstrup

**Studstrup Port Authority**  
Elsam t-Strudstrupvaerket  
Skoodstrup  
8541  
Denmark  
Contact: Mr Paul Rokkaer  
T: + 45 87 49 17 00  
F: + 45 87 49 17 73  
E: pro@elsam.com

## Vordingborg

**Vordingborg Port Authority**  
Harbour Office  
Valdemarsgade 43  
Vordingborg  
Sjælland  
4760  
Denmark  
Contact: Mr Claus Christensen  
Harbour Master  
T: + 45 55 362461  
F: + 45 55 362500  
E: clch@vordingborg.dk  
W: www.vordingborg-shipping.com

## DOMINICAN

## REPUBLIC

### Santa Domingo

**Port of Santo Domingo**  
c/o Maritima Dominicana SA  
PO Box 1301  
Carretera Sanchez KM  
Santa Domingo  
12 1/2  
Dominican Republic  
Harbour Master  
T: + 1809 593 5904  
F: + 1809 592 0910  
E: mail@fschad.com

## Santo Domingo

**Maritima Dominicana SA**  
PO Box 1301  
Carretera Sanchez Km 12 1/2  
Santo Domingo  
Dominican Republic  
Contact: Mr Karsten Windeler  
President  
T: + 1 809 539 6000  
F: + 1 809 539 7200  
E: info@mardom.com  
W: www.mardom.com  
Location: Rio Haina, south coast of the Dominican Republic.  
Equipment & Capacity: Grabs of up to 12 cu yds capacity, hoppers and payloaders.  
Bulk Berths: Several berths with up to 10m draught.

## Santo Domingo

**San Pedro de Macoris**  
Maritima Dominicana SA  
PO Box 1301  
Santo Domingo  
Dominican Republic  
Contact: Mr Jose Arias  
Terminal Manager  
T: + 1 809 980 8816  
F: + 1 809 539 7200  
E: operations@mardom.com  
W: www.mardom.com  
Location: South Coast Dominican Republic, in the Caribbean  
Bulk Berths: 6.5m brackish water draught

## Santo Domingo

**Barahona Port Authority**  
Maritima Dominicana SA  
PO Box 1301, Santo Domingo  
Dominican Republic  
Port Master  
T: + 1 809 688 4431  
F: + 1 809 689 1301  
E: ops@navierasbr.com

## Santo Domingo

**Cabo Rojo Port Authority**  
Maritima Dominicana SA  
PO Box 1301  
Santo Domingo  
Dominican Republic  
Port Master  
T: + 1 809 537 0055  
F: + 1 809 537 1706  
E: sugerencia@apordom.gov.do  
W: www.apordom.gov.do

## ECUADOR

### Guayaquil

**Port Authority of Guayaquil**  
PO Box 5739  
Puerto Maritimo  
Guayaquil  
Guayas Province  
Ecuador  
Contact: Mr D Victor Ceballos  
Secretary  
T: + 593 4 480120  
F: + 593 4 483748  
W: www.puertodeguayaquil.com

## EGYPT

### Alexandria

**Alexandria Port Authority**  
106 El-Horreya Avenue  
Alexandria  
Egypt  
Contact: Mr Mohamad Sammy  
General Manager  
T: + 203 4843532 / 4 / 8 / 487 4321  
22 23  
F: + 20 3 48 69177  
E: agency@imsalex.com  
W: www.apa.gov.eg

## Alexandria

**Kamaria Grain Terminal**  
106 EL Horreya Street  
Alexandria  
Egypt  
Contact: Admiral Ahmed Hamiea  
General Manager  
T: + 20 3 483 1640  
F: + 20 3 48 07245

## Cairo

**El Wadi Holdings**  
Mohandseen  
Cairo  
Mohandseen  
00202  
Egypt  
Contact: Mr Tony Freiji  
Vice President  
T: + 202 330 43 837  
F: + 202 3344 71 36  
E: amira\_hussien@medsofts.net  
W: www.wadigroup.com

## Cairo

**Abu Zenima Port Authority**  
Sinai Manganese Co SAE  
Head Office  
1 Kasr El Nil Street  
Cairo  
Egypt  
Contact: Mr Hassan Eid  
Chairman  
T: + 20 2 574 1096  
F: + 20 2 574 0142  
E: info@smc.eg.com

## Cairo

**Sinai Manganese Co S A E**  
1 Kasr El Nil Street  
Cairo  
Egypt  
Contact: Mr Sinai Manganese  
Managing Director  
T: + 20 2 574 1096  
F: + 20 2 574 0142  
E: info@smc.eg.com

## Cairo

**El Sokhna Port Development Company**  
10 Abo-Gaafar Al-Nahaas St  
Al-Nozha St., Ard El Golf  
Heliopolis  
Cairo  
Egypt  
Contact: Captain Ossama Al-Sharif  
T: + 20 2 37103222/ 3710320  
F: + 20 2 3331117/3321120  
E: redseaut@idscl.gov.eg

## Cairo

**Medsofts**  
40, 206St. Degla  
Cairo  
Maadi  
00202  
Egypt  
Contact: Mr Tarek Tawfik  
General Manager  
T: + 202 27 05 89 13  
F: + 202 27 54 40 54  
E: tawfik@medsofts.net  
W: www.medsofts.net

## Damietta

**Damietta Port Authority**  
PO Box 13  
Damietta  
345511  
Egypt  
Contact: Mr Ossoma Kamel  
Chairman  
T: + 20 57 325940  
F: + 20 57 325930  
E: contactus@dam-port.com  
W: www.dam-port.com



**Damietta**

**Mina Damyat Terminal**  
 PO Box 13  
 Damietta  
 34511  
 Egypt  
 Contact: Mr Ibrahim Shafik  
 General Manager  
 T: + 20 57 325 940  
 F: + 20 57 325 930

**Hamrawein**

**Hamrawein Port Authority**  
 4, Ptolemy Street  
 Bab Sharky  
 Hamrawein  
 Alexandria  
 21514  
 Egypt  
 T: +20 65 342 0124  
 F: +20 65 342 0124  
 E: contact@mts.gov.eg  
 W: http://www.mts.gov.eg

**Ismailia**

**Suez Canal Authority**  
 Depart. Of Planning, Research &  
 Studies  
 Information Centre - Library  
 Ismailia  
 41515  
 Egypt  
 Contact: Ms Dina Emara  
 Librarian  
 T: + 20 064 3910000  
 F: + 20 064 3914784  
 E: euscaeg@yahoo.com

**Ismailia**

**Suez Canal Authority**  
 Depart. Of Planning, Research &  
 Studies  
 Information Centre - Library  
 Ismailia  
 41515  
 Egypt  
 Contact: Mr Refaat Saad  
 Librarian  
 T: + 20 64 3910000  
 F: + 20 64 3914784  
 E: euscaeg@yahoo.com

**Ismailia**

**Port Authority of Safaga**  
 c/o The Suez Canal Authority  
 Ismailia  
 Egypt  
 Contact: Com Serrag Emara  
 Port Manager  
 T: + 20 065 45 1222  
 F: + 20 062 33 1126  
 W: www.mts.gov.eg

**Port Said**

**Port Said Port Authority**  
 Intersection of Mostafa Kamel and  
 Azmy Street  
 Railway Square  
 Port Said  
 Egypt  
 Contact: Adm M Maged Hamza  
 Chairman  
 T: + 20 66 3348270  
 F: + 20 66 3348262  
 E: info@psdports.org  
 W: www.psdports.org

**Port Tewfik**

**Red Sea Port Authority**  
 PO Box 1, Port Tewfik  
 Suez  
 Egypt  
 Contact: Vice Adm Thanaa Ahmed  
 Kamel  
 Chairman  
 T: + 20 62 220740  
 F: + 20 62 226761  
 E: mmt@idsc.net.eg  
 W: www.mts.gov.eg



**Safaga**

**Safaga Grain Berth No1**  
 Ports and Lights Administration  
 Safaga  
 Egypt  
 Contact: Cdr Serrag Emara  
 Harbour Master  
 T: + 20 65 45 12222  
 F: + 20 62 33 1126  
 E: info@ramseystours.com  
 W: http://safagaport.com

Equipment & Capacity: Equipment: 2 stackers, 2 retrievers, 2 vessel loaders, a carriage dumper  
 Capacity 5 000 000 tn per year  
 Bulk Berths: Berth 31: length 210m, depth 11m;  
 Berth 33: length 198 m, depth 11m;  
 Berth 32: length 365m, depth 17.5m  
 Total uncovered Storage: 45,000sqm

**Tallinn**

**AS Baltic Chemical Terminal**  
 Narva mt. 7d  
 Tallinn  
 Harjumaa  
 10117  
 Estonia  
 Contact: Ms Julia Smirnova  
 T: + 372 66 46 507  
 F: + 372 62 61 100  
 E: j.smirnova@bct.ee  
 W: www.bct.ee

Location: Sillamäe, East of Estonia  
 Equipment & Capacity: Output of over 1 million tons of ammonia and 1 million tons of UAN

Bulk Berths: For liquid commodities - up to 13m at the deepest berths  
 Total covered Storage: 120,000 m3  
 AS BCT (Baltic Chemical Terminal) is a modern and high-tech terminal for handling liquid fertilizers to Europe and throughout the world.

**Tallinn**

**PETROMAKS SPEDIITORI AS**  
 Nolva 9A  
 Tallinn  
 10416  
 Estonia  
 Contact: Mrs Kadi Neemelaid  
 Economic Expert  
 T: + 372 650 7702  
 F: + 372 650 7700  
 E: kadi@pmg.ee  
 W: www.petromaks.com

**Tallinn**

**Port of Tallinn**  
 Sadama 25  
 Tallinn  
 15051  
 Estonia  
 Contact: Mr Margus Sitsi  
 Business Manager (General cargo, dry bulk, Ro-Ro)  
 T: + 372 631 8 467  
 E: m.sitsi@ts.ee  
 W: www.portof tallinn.com  
 Location: South Coast of the Finnish

Gulf in the Baltic Sea  
 Equipment & Capacity: Dedicated coal, grain & fertilizers terminals in Muuga Harbour, scrap metal, gravel, peat, wood pellets and other dry cargo handled in Paldiski South Harbour.  
 Provided by terminal operators - list available at  
 www.portof tallinn.com/terminal-operators  
 Bulk Berths: Total of 20 bulk berths in 3 constituent harbours. Max draught ca 17m; max length of the vessel - 300m  
 Total uncovered Storage: 1,137,000sqm  
 Total covered Storage: 160,000sqm / 6,900sqm reefer warehouse  
 Port of Tallinn consists of 5 constituent harbours - Old City Harbour, Muuga Harbour, Paldiski South Harbour, Paljassaare Harbour and Saaremaa Harbour.

**Tallinn**

**KS Stevedoring**  
 Paljassaare Harbour  
 Paljassaare tee 28E,  
 Tallinn  
 10313  
 Estonia  
 Contact: Mr Mati Roosioja  
 Executive Director  
 T: + 372 6100 999  
 E: mati.roosioja@stevedore.ee  
 W: www.stevedore.ee

**Tallinn**

**AS MGT Muuga Grain Terminal**  
 57 Maardu Street  
 Tallinn  
 74115  
 Estonia  
 Contact: Capt. Artur Kivistik  
 Port Director  
 T: + 372 6319 521  
 F: + 372 6319 544  
 E: mgt@mgt.ee  
 W: www.mgt.ee  
 Location: Estonia, Baltic Sea  
 Equipment & Capacity: 4 unloaders - 2500 mt/h  
 1 loader - 1200 mt/h  
 Bulk Berths: 2 berths, length- 300m each, depth- 17.4 m  
 Total covered Storage: silo - 300 000 mt  
 import capacity - 5 mln.mt/ year  
 export capacity - 3 mln.mt/ year

grain laboratory  
 railcar/truck loading/unloading certificate ISO 9001:2000

**Tallinn**

**Muuga (Novotallinskiy)**  
 Maardu tee 57  
 Tallinn Eesti Vabariik  
 Tallinn  
 EE 0030  
 Estonia  
 Contact: Mr Anatoliy Kanaev  
 Port Director  
 T: + 372 6 319 205  
 F: + 372 2 234 313  
 E: tk@tk.ee

**Tallinn**

**AS DBT (Dry Bulk Terminal)**  
 13 Korma Street  
 Tallinn  
 74115  
 Estonia  
 Contact: Mrs Viktoria Jurjeva  
 Marketing Manager  
 T: + 372 66 46 509 / + 372 6 319 389  
 F: + 372 6 319 189  
 E: vika@dbtmuuga.ee  
 W: www.dbtmuuga.ee  
 Location: Muuga Harbour  
 Equipment & Capacity: 1gantry crane and 1 shiploader  
 Bulk Berths: 1 berth 288 m long and 14.5 m deep  
 Total uncovered Storage: 14,800 sqm  
 Total covered Storage: 20,785 sqm  
 Transport logistics, forwarding services, blending and bagging facility.

**Viimsi Vald**

**AS Stivis**  
 1 Koorma Street  
 Viimsi Vald  
 74115  
 Estonia  
 T: + 372 600 3872  
 F: + 372 600 3873  
 E: stivis@stivis.ee  
 W: www.stivis.ee

**FIJI**

**Suva**

**Ports Authority of Fiji**  
 PO Box 780  
 Suva  
 Viti Levu

**EL SALVADOR**

**Acajutla**

**Port of Acajutla**  
 CEPA  
 Zona Industrial  
 Acajutla  
 El Salvador  
 Contact: Mr Francisco Portillo  
 Engineer  
 T: + 503 452 3145  
 F: + 503 452 3145

**ERITREA**

**Assab**

**Assab Port Administration**  
 PO Box 58  
 Assab  
 Eritrea  
 Contact: Mr Mohammed Said Jassir  
 Port Manager  
 T: + 291 11 552 431  
 F: + 291 13 552 157

**ESTONIA**

**Tallinn**

**AS Coal Terminal**  
 4a, Joe Street  
 Tallinn  
 10151  
 Estonia  
 Contact: Ms Nadia Manzhos  
 Office Manager  
 T: + 372 626 36 52  
 F: + 372 630 36 53  
 E: info@coalterminal.ee  
 W: www.coalterminal.ee  
 Location: Located in the eastern part of the largest port in Estonia, Muuga, which almost never freezes; it is situated within 210km from the Russian border.

Fiji  
 Contact: Mr Ben Naidu  
 Chairman  
 T: + 679 3312700  
 F: + 679 3315549  
 W: www.fijiports.com.fj

## FINLAND

### Hamina

**Port of Hamina Ltd**  
 PO Box 14  
 Hamina  
 49401  
 Finland  
 Contact: Mr Esa Eerikainen  
 Port Manager  
 T: + 358 5 225 5400  
 F: + 358 5 749 5419  
 E: esa.eerikainen@portofhamina.fi  
 W: www.portofhamina.fi

### Kokkola

**Oy M Raunanheimo Ab**  
 PO Box 254  
 Kokkola  
 FIN - 67101  
 Finland  
 Contact: Mr Joakim Laxaback  
 Managing Director  
 T: + 358 50 387 3303  
 F: + 358 20 777 1320  
 E: joakim.laxaback@raunanheimo.com  
 W: www.raunanheimo.com

### Kokkola

**Port of Kokkola**



Satamatatu 53  
 Kokkola  
 67900  
 Finland  
 Contact: Mr Torbjörn Witting

Port Director  
 T: + 358 68 2424 00  
 E: torbjorn.witting@kokkola.fi  
 W: www.portofkokkola.fi  
 Location: The Port of Kokkola is the largest of the four major ports located along the coast of Ostrobothnia, Finland.

Equipment & Capacity: Conveyor systems from railway wagons into the warehouses and from the warehouse with loading conveyor systems into the vessel's hold.

Multipurpose 40 ton cranes on rails. Bulk Berths: 13m draught in the Deep Port, allowing Panamax class vessels of up to 80,000 DWT  
 Total covered Storage: Warehouses and terminals: A total of 70,000 sqm of covered warehouse space

### Kotka

**Port Of Kotka Ltd**  
 PO Box 196  
 Kotka 48101  
 Finland  
 Contact: Mrs Nanna Sirola  
 Marketing Manager  
 T: + 358 20790 8800  
 F: + 358 20 790 8891  
 E: nanna.sirola@portofkotka.fi  
 W: www.portofkotka.fi

### Kotka

**Steveco Oy**  
 PO Box 44  
 Kotka  
 48101  
 Finland  
 Contact: Mr Tapio Mattila  
 Director of Marketing and Development  
 T: + 358 5 232 3502  
 F: + 358 5 232 3392  
 E: tapio.mattila@steveco.fi  
 W: www.steveco.fi  
 Location: South East of Finland on the

south coast  
 Equipment & Capacity: 4 multi-purpose cranes, 1 shiploader  
 Bulk Berths: Length 600m, depth 13.5 - 15.3m  
 Total uncovered Storage: 20,000sqm  
 Total covered Storage: 30,000sqm  
 Steveco offers handling and warehousing services for dry bulk such as fertilisers and paper fillers. In the future Steveco will concentrate on project cargoes.

### Kotka

**OY Finnterminals AB**  
 PO Box 224  
 Kotka  
 48101  
 Finland  
 Contact: Mr T Kilpi  
 Managing Director  
 @with line:

### Loviisa

**Port of Loviisa**  
 Loviisa  
 Valko  
 FI-07910  
 Finland  
 Contact: Mr Aki Marjasvaara  
 Port Director / Harbour Office  
 T: + 358 19 555 1  
 E: aki.marjasvaara@loviisa.fi  
 W: www.loviisa.fi

### Naantali

**Port of Olkiluoto**  
 PL 41  
 Naantali 21101  
 Finland  
 Contact: Mr Jussi Malkia  
 T: + 358 400 785 489  
 F: + 358 5 531 320  
 E: jussi.malkia@meriaura.fi  
 W: www.meriaura.fi  
 PrivatePortOfOlkiluoto.html

### Naantali

**Port of Naantali**  
 Satamatie 13  
 Naantali  
 21100  
 Finland  
 Contact: Mr Yrjo Vainiala  
 Port Director  
 T: + 358 2 437 5511  
 F: + 358 2 435 1727  
 E: yrjo.vainiala@naantali.fi  
 W: www.naantali.fi

### Oulu

**Herman Andersson Oy**  
 PO Box 37  
 Oulu  
 90401  
 Finland  
 Contact: Mr Jari Ramtamala  
 Managing Director  
 T: + 358 8 315 0100  
 F: + 358 8 371743  
 E: info@hermandersson.fi  
 W: www.hermanandersson.fi

### Oulu

**Oulu Stevedoring OY**  
 PO Box 16  
 Oulu  
 90400  
 Finland  
 Contact: Mr Kari Himanen  
 Port Director  
 T: + 358 8 5584 2750  
 F: + 358 8 5584 2799  
 E: kari.himanen@ouka.fi

### Oulu

**Port of Oulu**  
 PO Box 23  
 Oulu  
 90015 Oulun Kaupunki  
 Finland  
 Contact: Mr Kari Himanen  
 Port Director

T: (Director) + 358 44 703 2750 / 3  
 F: + 358 8 5584 2799  
 E: kari.himanen@ouka.fi  
 W: www.ouluport.com

### Pori

**Port of Pori**



Porin Satama  
 Merisatamantie 13  
 Pori  
 28880  
 Finland  
 Contact: Mr Jaakko Nirhamo  
 Port Director  
 T: + 358 2 621 2601  
 F: + 358 2 621 2630  
 E: jaakko.nirhamo@pori.fi  
 W: www.pori.fi/port  
 Location: Port of Pori is centrally located on the west coast of Finland with fast access to the hinterlands.  
 Equipment & Capacity: - 13x Cranes, 1x Loader, 1x Stackers.  
 Lifting capacity 6-200 t  
 Bulk Berths: Max draught 10m-15.3m.  
 Quay length 2,700m  
 Total covered Storage: 110,500sqm

### Raah

**Port of Raah**  
 Lapaluodontie 342  
 Raah  
 92180  
 Finland  
 Contact: Mr Karo Hikkonen  
 T: + 358 08 439 3930  
 F: + 358 82 22 37 155  
 E: karo.hikkonen@raah.fi

## PORT OF KOKKOLA The Main Dry Bulk Port in Finland

### Ideal location with 13 m draft

The Port of Kokkola is ideally located, with rail and road connections to every part of Finland and to Russia. We are Finland's largest transit port delivering goods to and from Russia.

Continuous investments have made it the leading dry bulk port in Finland.

The draft of 13 m allows Panamax class vessels to load full loads of 75,000 ton, and larger vessels (120,000 DWT) have loads of more than 100,000 ton.





# Major bulk port in Finland

## Port of Pori

*The port of all size vessels*

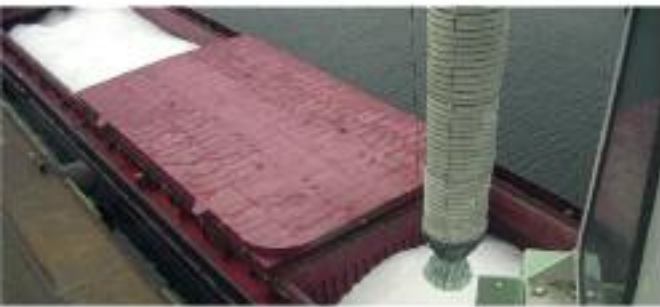

## The strengths of the Port of Pori

- Dust minimized loading and unloading systems in use
- Suitable for large volumes
- Deep fairway (15.3m) and the best ice conditions in Finland
- Uncongested hinterland connections
- Room to expand, free areas available for dry and liquid bulk
- Located far from dense housing areas
- Environmental and work safety as top priorities

### Reachability (by truck)

- Within 3 hrs. of Pori
- Within 6 hrs. of Pori

### FINLAND



### New 12m quay!

For more info go to:  
[www.portofpori.fi/en](http://www.portofpori.fi/en)



Port of Pori | Merisatamantie 4, FI-28880 PORI, FINLAND  
Tel: + 358 (0)2 621 2600 | Fax: + 358 (0)2 634 9498  
[info.port@pori.fi](mailto:info.port@pori.fi) | [www.portofpori.fi/en](http://www.portofpori.fi/en)



## Rauma

**Port of Rauma Authority**  
Hakuntintie 19  
Rauma  
26100  
Finland  
Contact: Mr Hannu Asumalahti  
Port Director  
T: + 358 2 834 4712  
F: + 358 2 822 6369  
E: harbour.office@portofrauma.com  
W: www.portofrauma.com

## Rauma

**Euroports Rauma (previously OY Rauma Stevedoring)**  
Hakuntintie 23  
PO Box 68  
Rauma  
FIN-26101  
Finland  
Contact: Mr Juha Vannio  
Sales and Marketing Manager  
T: + 358 2 83 121  
F: + 358 2 8312 444  
E: juha.vannio@euroports.fi  
W: www.euroports.com  
Location: West Coast of Finland  
Equipment & Capacity: Lifting capacity with shore cranes 200 ton  
Total covered Storage: abt 240,000sqm, 30,000sqm heated storages  
Break bulk, heavy lifts and project shipments.

## Turku

**Port of Turku Authority**  
Linnankatu 90  
Turku  
FIN-20100  
Finland  
Contact: Mr Kari Riutta  
Harbour Master  
T: + 358 2 2674 123  
F: + 358 2 2674 125  
E: kari.riutta@turku.fi  
W: www.portofurku.fi  
Location: South West Finland  
Equipment & Capacity: Shore cranes and grabs available.  
New mobile crane with 20 tons capacity.  
Bulk Berths: Depth 6.5m to 8.0m  
Total covered Storage: Grain silo available  
Port of Turku is mainly a passenger and ro-ro port but small amounts of bulk are handled such as grain and soya.

## Vaasa

**Port of Vaasa**  
PO Box 2  
Vaasa  
65101  
Finland  
Contact: Mr Lars Holmqvist  
Port Director  
T: + 358 6325 4500 / +358 400 680 199  
F: + 358 6 325 4514  
E: lars.holmqvist@vaasa.fi  
W: www.vaasa.fi/port  
Location: West coast of Finland  
Total uncovered Storage: 100,000 sqm approx.  
Total covered Storage: 30,000 sqm

## Vantaa

**Suomen Viljava Oy**  
Kielotie 5 B  
Vantaa  
01300  
Finland  
Contact: Mr Hannu Kortemaa  
Marketing Manager  
T: + 358 10 3464 204  
F: + 358 01 3464 200  
E: hannu.kortemaa@suomenviljava.fi  
W: www.suomenviljava.fi  
Location: 16 inland grain storages in

Finland  
5 port terminals for grain in Finland  
Equipment & Capacity: At port terminals capacity 250-500tph  
Oat fibre (betaglucane) factory in Kokemäki, Finland (business to business product).

## FRANCE

### Bassens

**CIMALIT**  
Zone Portuaire  
Quai Alfred de Vial  
Bassens  
33530  
France  
Contact: Mr Christina Moracchini  
Managing Director  
T: + 33 5 57 77 56 56  
F: + 33 5 57 77 56 50  
E: cimailit@wanadoo.fr  
W: www.cimailit.com

### Bassens

**Sea-invest Bordeaux**  
  
Rue Richelieu 1  
Bassens  
33530  
France  
Contact: Mr Franck Humbert  
T: + 33 557 77 49 51  
F: + 33 557 77 82 11  
E: franck.humbert@sea-invest-france.com  
W: www.sea-invest.be

### Bassens

**Ste Aquitaine du Silo de Bordeaux-Bassens**  
10 Quai Alfred de Vial  
Bassens  
33530  
France  
Contact: Mr Yannick M Collet  
General Manager  
T: + 33 556 33 47 00  
F: + 33 556 06 22 76

### Bassens

**Gemadocks**  
Supporting and auxiliary transport  
ZI Bellerie Avenue des Moines  
Bassens  
33530  
France  
Contact: Mr Franck Humbert  
Director  
T: + 33 5 56 31 50 34  
F: + 33 5 56 74 71 10

### Blainville Sur Orne

**SOEMAR**  
ZI Caen Canal  
Blainville Sur Orne  
14550  
France  
Contact: Mr Douglas Draper  
Agency/Stevedoring  
T: + 33 231 35 65 68  
F: + 33 231 720 520  
E: d.draper@sogemar-caen.com  
W: www.sogemar-caen.com/

### Blaye

**Blaye Grain Terminal**  
Silo Portaire  
BP 15  
Blaye  
33390  
France  
Contact: Mr Rabu  
T: + 33 557 42 0307  
F: + 33 557 42 3918

## Bordeaux

**SEMABLA**  
Port of Bordeaux  
Bordeaux  
France  
Contact: Mr Jean-François Rabu  
T: + 33 5 57 42 74 91  
F: + 33 5 57 42 39 18  
E: jf.rabu@sodistock.fr

## Bordeaux

**Bordeaux Port Authority**  
Palais de la Bourse  
3, Place Gabriel  
Bordeaux  
Cedex 33075  
France  
Contact: Mrs Laurence Bouchardie  
Commercial & Communications Manager  
T: + 33 5 56 90 59 93  
F: + 33 5 56 90 58 78  
E: l-bouchardie@bordeaux-port.fr  
W: www.bordeaux-port.fr  
Location: South West of France, on the Atlantic seaboard  
Equipment & Capacity: 4 Cranes of 34 tons - 700 tph each one  
Bulk Berths: Bulks berthes at Bassens (44m) are operated by Sea-Invest Bordeaux Company/mail: trambod@sea-invest-france.com and Baluerie Company www.baluerie.com  
Total uncovered Storage: 90 000 sqm

## Bordeaux

**SAIPOP**  
Port of Bordeaux  
Bordeaux  
France  
Contact: Mr Asneres  
Director  
T: + 33 5 57 80 87 50  
F: + 33 5 57 80 87 69  
E: sofiproteol@prolea.com

## Bordeaux

**SPBL**  
Port of Bordeaux  
Bordeaux  
France  
Contact: Mr Th. Audiger  
T: + 33 5 57 77 84 50  
F: + 33 5 57 77 84 51

## Boucau

**Maisica**  
Quai du Base  
Port de Bayonne  
Boucau  
64340  
France  
Contact: Mr Michel Prlleno Izac  
Director  
T: + 33 5 59 64 6342  
F: + 33 5 59 64 5718  
E: contact@maisica.com  
W: www.ports-basques.com/ports/bayonne

## Brest

**Port of Brest - CCI**  
1, avenue de Kiel  
Brest  
Brittany  
F-29200  
France  
Contact: Mr Gilles Fourné  
Port Manager  
T: + 33 298 46 23 80  
F: + 33 298 43 24 56  
E: info@brest.port.fr  
W: www.brest.port.fr  
Location: 48° 23' 8" N, 4° 28' 8" W,  
Head of Europe  
Equipment & Capacity: 9 cranes  
3 conveyors belts (1 000 tons / hour)  
Bulk Berths: 4 berths, 175m, 110m, 230m, 300m, draft from -6 m to - 12m  
Total uncovered Storage: 70 000 sqm

Total covered Storage: 160 000 tons  
Rail connection, linkspan  
5 mobiles cranes

## Brest

**CCI - Chambre de Commerce et d'industrie**  
Quai 6th Sud, Zone Industrielle  
Portuaire  
BP 126  
Brest  
29200  
France  
Contact: Mr Bon  
Operations Manager  
T: + 33 02 98 00 38 00  
F: + 33 02 98 00 39 02  
E: info@cci-brest.fr  
W: www.cci-brest.fr

## Brest

**Port of Brest - CCI**  
1 Avenue de Kiel  
Brest  
29200  
France  
Contact: Mr Jean Hattenville  
Sales Executive  
T: + 33 2 98 46 87 46  
F: + 33 2 98 43 24 56  
E: jch@cci-brest.fr  
W: www.brest.port.fr  
A deep-water port on the leading edge of Europe

## Brest

**Port of Brest Dry Bulk Terminal**  
Avenue de KIEL  
Brest  
29200  
France  
Contact: Mr Jean-Christophe Hattenville  
T: + 33 298 46 23 80  
F: + 33 298 43 24 56  
E: jean-christophe.hattenville@port.cci-brest.fr  
W: www.brest.port.fr  
Location: 48° 23' 8" N, 4° 28' 8" W  
Brest is located in the heart of the Atlantic Arc. The port is a gateway to France, Europe and a connection to ongoing worldwide sailings.  
Equipment & Capacity: 9 cranes  
3 conveyors belts (1 000 tons/hour each)  
2 mobile cranes  
Loading/unloading rail/road station (9 000 tons/day)  
Bulk Berths: 4 berths from 175m to 300m length  
Draft from 6m to 12m  
Total covered Storage: 160 000 tons (7 warehouses + 8 vertical silos)  
The terminal is enclosed, guarded 24/24H and controlled by video-surveillance; ISPS approved; ISO 9001-2000.  
2004 Figures  
Agro bulks : 644 000 tons  
Oils / Molasses : 146 400 tons  
Clinkers/cement : 130 652 tons  
Sand/aggregates : 120 409 tons  
Steel products/metal scraps : 78 817 tons  
Other : 37 000 tons

## Calais

**Port of Calais**  
Chambre Du Commerce  
24 Blvd. Des Allies  
Calais  
Cedex 62104  
France  
Contact: Mr Patrick Fourgeaud  
General Manager  
T: + 33 321 460 000  
F: + 33 321 460 099  
E: patrickfourgeaud@calais.cci.fr  
W: www.calais-port.com/

## Cherbourg-Octeville

**Port de Cherbourg**  
Port de Cherbourg SAS  
Quai de Normandie  
BP 50231  
Cherbourg-Octeville  
Cedex  
50102  
France  
Contact: Mr Thierry Lenepveu  
Development Manager  
T: + 33 2 33 236453  
F: + 33 2 33 236455  
E: tienepveu@portdecherbourg.fr  
W: www.port-cherbourg.com

## Dieppe

**Dieppe Port**  
Capitainerie, Quai de la Cale  
No 1  
Dieppe  
Seine Maritime  
76203  
France  
Contact: Mr Marc David  
Harbour Master  
T: + 33 235 06 8656  
F: + 33 235 06 12 56  
E: marc1.david@equipement.gouv.fr  
W: www.portdedieppe.fr  
Location: South of England, close to Newhaven  
Equipment & Capacity: 4 cranes on rails with each 2 wagons of 2.2 tons capacity,  
1 crane on rails with 2 trolleys of 2.5 tons capacity each,  
3 railed hoisting cranes of 8 tons capacity at 25m (6 tons capacity at 32m, 3 tons capacity at 40m),  
1 mobile crane of 40 tons capacity at 24m (30 tons capacity at 30m)  
1 mobile crane of 63 tons capacity at 20m (38.7 tons capacity at 30m, 27.2 tons capacity at 38m)- (april 2008)  
Bulk Berths: Quay of Norway, 700m long, berthing on 678m Quay of India, 150m long, berthing on 135m Quay of Morocco, 675m long, berthing on 555m  
Total uncovered Storage: Open quay surface of 10000m2 at Quebec quay  
Open quay surface of 18000m2 at Paris dock (Marocco & Norway quays)  
Total covered Storage: More than 20000m2 shed storage in Paris dock  
8000m2 refrigerated shed at Marocco quay  
Maximum vessels' dimensions 160m LOA, 24m breadth, 9m draught  
Vessels' inbound/outbound traffic taking place from 2h before to 1h after high tide  
Contact with "Dieppe port" on VHF channel 12.

## Dunkerque

**CAMEY Sables et Gravieres (Civil & Marine)**  
Quai a Marchandises Diverses  
Dunkerque  
59376  
France  
Contact: Mr Andre Vincent  
Managing Director  
T: + 33 3 28 58 77 17  
F: + 33 3 28 27 47 76  
E: andre.vincent@holcim.com

## Dunkerque

**Port of Dunkerque**  
Terre Plein Gullian  
BP 6534  
Dunkerque  
Cedex 1  
59386  
France  
Contact: Mrs Marie-Elizabeth Bogucki  
Communication & Relations  
Publiques  
T: + 33 3 28 28 7763



F: + 33 3 28 28 79 17  
E: mebogucki@portdedunkerque.fr  
W: www.portdedunkerque.fr

**Dunkerque**

**SGD - Silo a Grain Dunkerque**

Route du Fosse Defensif  
Port Est  
Dunkerque 59140  
France  
Contact: Mr Olivier Albrecht  
Commercial Director  
T: + 33 3 28 24 90 10  
F: + 33 3 28 24 90 15  
E: olivieralbrecht.dmt@orange.fr

**Dunkerque**

**Silonor**

Quai Cerealiier - Port Est  
Dunkerque 59140  
France  
Contact: Mr Olivier Albrecht  
Commercial Director  
T: + 33 3 28 24 90 10  
F: + 33 3 28 24 90 15  
E: olivieralbrecht.dmt@orange.fr

**Dunkerque**

**Sea-Bulk Terminal**

Route du Quai à Pondéreux Ouest  
Loon-Plage  
Dunkerque  
59279  
France  
Contact: Mr Philippe Bertoneche  
Terminal Manager  
T: + 33 328 28 79 40  
F: + 33 328 28 79 15  
E: philippe.bertoneche@sea-invest-france.com  
W: www.sea-invest.be

**Fecamp**

**Fecamp Port Authority**

16 Grand Quai  
PO Box 167  
Fecamp  
76400  
France  
Contact: Mr Y Morel  
Harbour Master  
T: + 33 235 28 23 76  
F: + 33 235 28 75 86  
E: info@fecamp.cci.fr  
W: www.fecamp.cci.fr

**La Rochelle**

**Port Atlantique La Rochelle**

BP 70394  
La Rochelle  
Cedex 1  
France  
Contact: Dominique Marquis  
Director of Communication  
T: + 33 54600 5360  
F: + 33 54600 56 22  
E: d.marquis@larochelle.port.fr  
W: www.larochelle.port.fr

**La Rochelle-Pallice**

**Silo de la Rochelle Pallice**

(SICA Manutention Porteur)  
69 Rue Montcalm  
La Rochelle-Pallice  
17000  
France  
Contact: Mr Jean-Pierre Esterez  
Director  
T: + 33 546 43 9922  
F: + 33 546 43 2494  
E: jp.esterez@sica-atlantique.com

**Le Havre**

**Coal Terminal**

Port of Le Havre Authority  
Terre Plein de la Barre  
PO Box 1413  
Le Havre  
Cedex  
76067

France  
Contact: Mr Eric Esneu  
Bulk Traffic Manager  
T: + 33 2 32 74 76 05  
F: + 33 2 32 74 76 09  
E: eric.esneu@havre-port.fr  
W: www.havre-port.net

Location: North West of France (Normandy) on the North Coast  
Equipment & Capacity: 2 Grab unloaders- Discharging rate: 25,000tpd  
Bulk Berths: Max ships draught: 17m  
Total uncovered Storage: 2 storage areas : 40,000sqm + 60,000sqm  
Reloading facilities: max ships draught 6m

**Le Havre**

**Port of Le Havre Authority**



PO Box 1413  
Terre Plein de la Barre  
Le Havre  
Cedex 76067  
France  
Contact: Mr Laurent Castaing  
Port Manager  
T: + 33 232 74 74 00  
F: + 33 232 74 74 29  
E: internetpah@havre-port.fr  
W: www.havre-port.fr  
Location: Located at the crossroads of major communication highways, at the heart of the west seaboard of the European continent, Le Havre is the first port of call for large transoceanic mother-ships. The Port of Le Havre provides the shortest transport times for commercial exchanges with all the other continents.

Equipment & Capacity: Multibulks Centre: can operate direct transhipment from ships to barges and coasters.  
Ore Centre ("Terminal MC-6"): sorting station dispatches products to storage yards, loading berths and loading tower for freight cars and trucks.  
Agribusiness Centre Grain terminal: Mechanised machines for unloading freight cars and lorries at Hermann du Pasquier quay. Gantry crane (1,800 tph) for loading large grain carriers at Joannes Couvert quay.

Agribusiness Centre Sugar terminal: Lorry and freightcar reception facilities and sacking station. Gantry crane for loading bulk sugar on specialised BIBO ships.  
Bulk Berths: Multibulks Centre: Main berth - unloading ships up to 180,000 dwt, loading 35,000/50,000dwt. Additional berth loading of 5,000dwt pusher trains of barges or coasters up to 8,000dwt.

Ore Centre ("Terminal MC-6"): Length 300m, 180,000 DWT. Main berth and loading berth for river barge convoys and coasters.

Agribusiness Centre: Bellot dock 30,000 DWT. Tidal dock can accommodate the largest grain carriers.  
Total uncovered Storage: Multibulks Centre: private storage yard of 2 million tonnes.

Ore Centre ("Terminal MC-6"): public yard of 530,000 tonnes, private yard of 250,000 tonnes.

Total covered Storage: Agribusiness Centre Grain terminal: 80,000 tonnes grain silo.  
Agribusiness Centre Sugar terminal: 45,000 tonnes sugar silos operated by SHGT ("Societe Havraise de Gestion et de transport").  
The Multibulks Centre has the necessary technical means for screening, grinding, mixing, long-term

storage and re-forwarding onto complete trains, trucks and barges.

**Le Havre**

**CIPHA Multibulk Centre**

182 Quai George V  
BP 1142  
Le Havre  
76600  
France  
Contact: Ms Miugendit  
T: + 33 232 74 24 80  
F: + 33 235 21 38 15  
E: lechevallier@shgt.fr  
W: www.cipha.fr  
Location: East Channel France Seine mouth  
Equipment & Capacity: 2x 30t gantry cranes  
Bulk Berths: 1 berth: draught 17.5m  
Total uncovered Storage: 300,000sqm  
Total covered Storage: 12,000sqm  
Screening crushing facility

**Le Portel**

**Gie Boulogne Clinker**

Quai de l'Europe  
Le Portel  
62480  
France  
Contact: Mr Jacques Duron  
Administrator  
T: + 33 6 21 31 85 97  
F: + 33 6 21 33 94 57  
W: www.gie-boulogne-clinker.com

**Lorient**

**Port de Commerce-Lorient**

3 Bd de la Rade  
Lorient  
56100  
France  
Contact: M J P Greverio  
T: + 33 297 371 670  
F: + 33 297 379 073  
E: lorient.port.commerce@morbihan.cci.fr

**Marseille**

**Marseilles Grain Terminal**

Port Autonome de Marseille  
Direction des Operations -  
Terminaux de Marseille  
23, place de la Joliette  
BP 1965  
Marseille  
13226 Cedex 02  
France  
Contact: Mrs Sacha Roujier  
Marketing  
T: + 33 4 91 39 44 21  
F: + 33 4 91 39 57 00  
E: gpmm@marseille-port.fr  
W: www.marseille-port.fr

**Marseille**

**Port Autonome de Marseille/Fos**

23 Place de la Joliette  
Hotel de la Direction du Port  
Marseille  
Cedex 02  
13226  
France  
Contact: Mr Vincent Mutel  
Public Relations  
T: + 33 0491 395320  
F: + 33 0491 394024  
E: gpmm@marseille-port.fr  
W: www.marseille-port.fr

**Marseille**

**Port of Marseilles**

23 Place De La Joliette  
BP 81965  
Marseille  
Cedex 02  
13226  
France  
Contact: Mr Jean Claude Terrier  
Managing Director  
T: + 33 4 91 39 4000/278  
F: + 33 4 91 39 57 00

E: pam@marseille-port.fr  
W: www.marseille-port.fr  
Location: Eastern and Western Harbors  
Equipment & Capacity: Please see website: www.marseille-port.fr  
Bulk Berths: Please see website: www.marseille-port.fr  
Total uncovered Storage: Eastern: 450 acres  
Western: 10,000 acres  
Total covered Storage: Western: Distriport Logistic Area 450,000sqm  
Please see website: www.marseille-port.fr

**Martiques**

**Carfos**

13, Boulevard Maritime  
Martiques  
13500  
France  
Contact: Mr Xavier Hauterat  
T: + 33 424 06 71 82  
F: + 33 424 06 34 94  
E: xavier.hauterat@sea-invest-france.com  
W: www.sea-invest.be

**Montoir-de-Bretagne**

**Sea-invest Montoir**



Rue de la Goëlette - BP 36  
Montoir-de-Bretagne  
44550  
France  
Contact: Mr Pascal Vialard  
T: + 33 240 17 31 71  
F: + 33 240 17 31 79  
E: pascal.vialard@sea-invest-france.com  
W: www.sea-invest.be

**Montoir-de-Bretagne**

**SONASTOCK & ATLANTIQUE STOCKAGE**

Montoir Export & Import Terminals  
Montoir-de-Bretagne  
France  
Contact: Mr Thierry Coiffard  
Director  
T: + 33 2 40 90 01 37  
F: + 33 2 40 90 46 17  
E: t.coiffard@sodistock.fr  
W: www.sodistock.fr/anglais/accueilgb.htm

**Nantes**

**SODISTOCK Group**

35 Rue des Usines  
Nantes  
cedex 4  
44 000  
France  
Contact: Mr Daniel Finon  
Director  
T: + 33 2 40 95 08 08  
F: + 33 2 40 58 01 22  
E: d.finon@sodistock.fr  
W: www.sodistock.fr

**Nantes**

**SONASTOCK - Nantes Export Terminal**

Sortie No 30 - Porte de l'Estuaire  
Nantes  
44186  
France  
Contact: Mr Daniel Finon  
Directeur Général  
T: + 33 2 40 95 60 61  
F: + 33 2 40 58 15 59  
E: d.finon@sodistock.fr  
W: www.sodistock.fr/anglais/accueilgb.htm

**Nantes**

**Montoir Agri-Bulk Terminal**

18 Quai Ernest Renaud  
Nantes

44031  
France  
Contact: Mr L Buvry  
Port Director  
T: + 33 240 442 020  
F: + 33 240 442 181  
E: l.buvry@nantes.port.fr  
W: www.nantes.port.fr

**Nantes**

**Grand Port Maritime Nantes St Nazaire**

I 894  
Centre De Documentation  
18 Quai Ernest Renaud  
BP 18 609  
Nantes  
Cedex 04  
44186  
France  
Contact: Mr Laurent Buvry  
Commercial Manager  
T: + 33 2 40 44 20 26  
F: + 33 2 40 44 21 81  
E: l.buvry@nantes.port.fr  
W: www.nantes.port.fr  
Location: Western France, on the Atlantic Seashore  
Equipment & Capacity: 1 Gantry crane - 700 t/h  
1 Crane - 700 t/h  
5 Cranes - 500 t/h each  
3 Continuous unloaders - 1200 t/h each  
1 Mobile conveyor belt - 350 t/h  
Bulk Berths: Montoir - Agricul Terminal  
4 Berths; Total length - 930 m; Drafts up to 13,5 m  
Total covered Storage: 70,000 sqm  
Leading French port for cattle feed imports, with a 60% market share. Special focus on traceability, cleaning, dedicated conveyors & storage, allowing strict separation of products. Quality control through HACCP process

**Nantes**

**Roche-Maurice Terminal**

18 Quai Ernest Renaud  
Nantes  
44031  
France  
Contact: Mr M Buvry  
Commercial Manager  
T: + 33 2 40 442 020  
F: + 33 2 40 442 181  
E: m.buvry@nantes.port.fr

**Nantes**

**Montoir Coal Terminal**

Port Atlantique Nantes Saint-Nazaire  
18 quai Ernest Renaud  
BP 18609  
Nantes  
44186  
France  
Contact: Mr Pascal Freneau  
Marketing & Advertising Manager  
T: + 33 2 40 44 2113  
F: + 33 2 40 44 20 01  
E: p.freneau@nantes.port.fr  
W: www.nantes.port.fr

**Nantes**

**Port Atlantique-Montoir Agri-Bulk Terminal**

18 quai Ernest Renaud  
BP 18609  
Nantes  
Cedex 4  
44186  
France  
Contact: Mr Pascal Freneau  
Communication Manager  
T: + 33 2 40 44 20 06  
F: + 33 2 40 44 21 81  
E: p.freneau@nantes.port.fr  
W: www.nantes.port.fr  
Location: Western France

# A NEW PORT SYSTEM

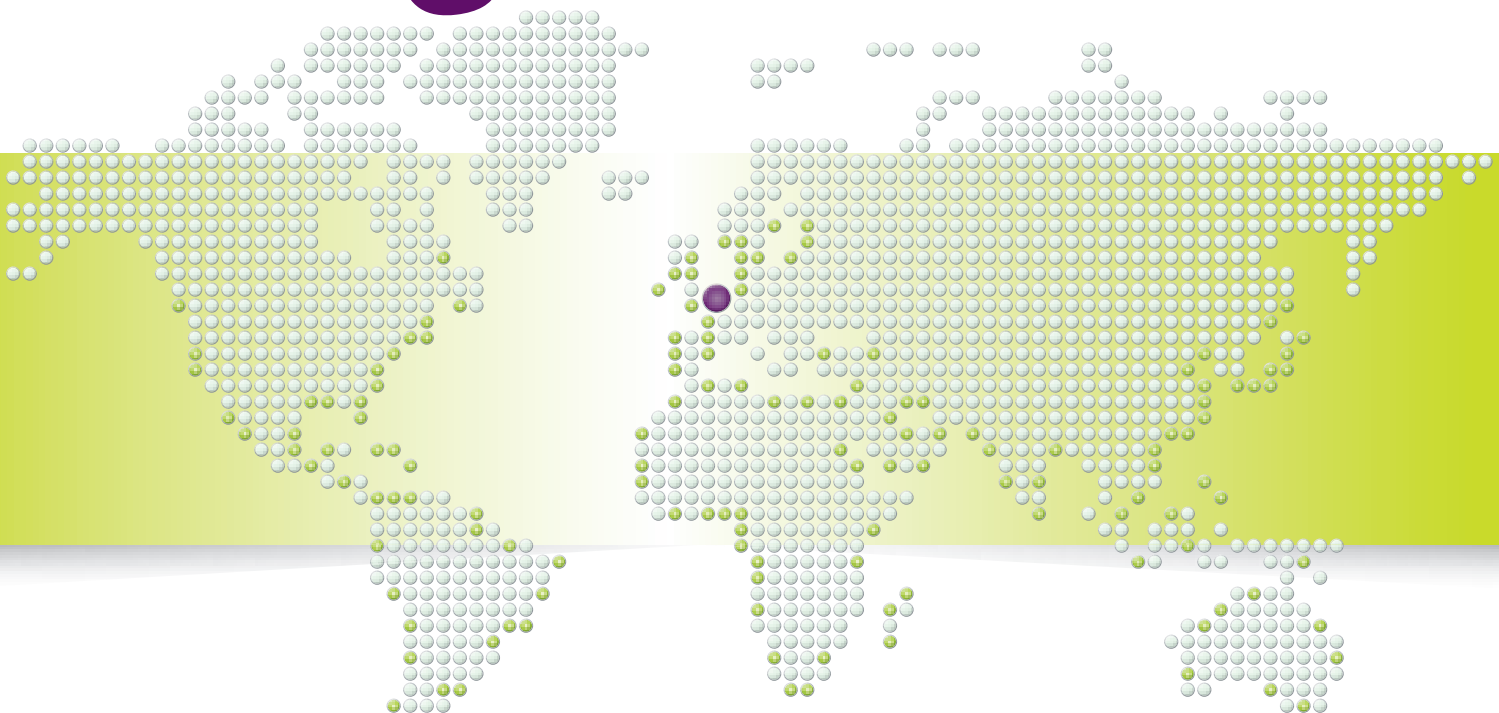

**HAROPA**  
YOUR LOGISTICS  
SOLUTION  
IN EUROPE

HAROPA, combining the ports of **Le Havre, Rouen and Paris**, is the 4<sup>th</sup> biggest port complex in Northern Europe.

Connected to every continent, it serves the second largest consumer market in Europe. Offering end-to-end multimodal transport solutions along the Seine artery, it provides a one-stop shop for your import/export logistics.



[www.haropaports.com](http://www.haropaports.com)  
[communication@haropaports.com](mailto:communication@haropaports.com)

## HAROPA

Ports de Paris Seine Normandie

**LE HAVRE**  
port  
Commerce - Croisières

**PORT de ROUEN**  
MARITIME

**PORTS de PARIS**  
VAL DE SEINE EN LOGISTIQUE



**Paris**

**Port of Paris Authority**



1, quai de Grenelle  
Paris  
Cedex 15  
75732  
France  
Contact: Mr Christophe Duchatelier  
T: + 33 140 58 27 40  
F: + 33 140 58 27 50  
E: christophe.duchatelier@paris-ports.fr  
W: www.paris-ports.fr

**Port De Montoir**

**Sea-invest France (Stocaloire)**



Terminal Agro Alimentaire  
Port De Montoir  
44550  
France  
Contact: Mr Florent Massart  
T: + 33 232108516  
F: + 33 155 66 81 50  
E: trampset@sea-invest-france.com

**Rouen**

**Simarex Villette**

Mole de la Darse des Docks  
BP 7  
Rouen  
Petit Couronne 76650  
France  
Contact: Mr Charles Vedie  
Operations  
T: + 33 2 3568 2402  
F: + 33 2 3567 2993  
E: c.vedie@simarex.fr  
W: www.portofrouen.com/

**Rouen**

**Maprochim**

Centre Tertiaire Portuaire  
19 Boulevard du Midi  
Rouen 76100  
France  
Contact: Mr Michael Fouche  
Managing Director  
T: + 33 2 3281 9633  
F: + 33 2 3572 2691  
E: commercial@maprochim.fr  
W: www.maprochim.fr

**Rouen**

**SENALIA**

Presqu'île Elie  
Rouen  
76100  
France  
Contact: Mr Kindelberger  
T: + 33 235 726 904  
F: + 33 235 723 054  
E: contact@senalia.com  
W: www.senalia.com

**Rouen**

**Port of Rouen**

34 Blvd de Boisguilbert  
Rouen  
Cedex 3  
F 76022  
France  
Contact: Mr Martin Butruille  
Traffic and Port Activity Manager  
T: + 33 235 52 54 30  
F: + 33 235 52 54 95  
E: dtap@rouen.port.fr  
W: www.rouen.port.fr  
Location: On the River Seine,  
between the Channel and Paris

**Rouen**

**SENALIA**

Boulevard Maritime

BP 71  
Grand Couronne  
Rouen  
76530  
France  
Contact: Mr Marc Blaiset  
T: + 33 235 183 030  
F: + 33 235 183 033  
E: MarcBlaiset@senalia.com  
W: www.senalia.com

**Rouen**

**Lequeur**

Val de la Haye  
QuennePort  
Canteleu  
Rouen 76380  
France  
Contact: Mr Patrick Chevallier  
Director  
T: + 33 2 35 36 25 23  
F: + 33 2 35 36 48 52  
E: p.chevallier@lequeur.com

**Rouen**

**Silos Soufflet - SOCOMAC I/II**

**Terminals**

Quai de Danemark  
Dieppendalle Croisset  
PO Box 1010  
Rouen 76380  
France  
Contact: Mr De Braquillanges  
T: +33 3 25 39 41 11 / + 33 235 363 145  
F: + 33 235 085 671  
E: pbrochot@soufflet-group.com

**Rouen**

**Sogema**

Boulevard Maritime - BP 3  
Grand-Couronne Terminal  
Rouen  
76530  
France  
Contact: Mr Robert Goudon  
Director  
T: + 33 232 11 51 01  
F: + 33 232 11 51 25  
E: r.goudon@sea-invest.fr  
W: www.sea-invest.be

**Saint Malo**

**St Malo Port Authority**

Terre-Plein de l'Ecluse du Naye  
Saint Malo  
35402  
France  
Contact: Mr Atreuh  
Vice Captain  
T: + 33 299 20 25 00  
F: + 33 029 94 02 58 7  
E: atreuh@Saint-Malo.CC.I.fr  
Location: North Brittany (France)  
West of Channel France  
Equipment & Capacity: 3 cranes - 400  
tph  
1 crane - 200 tph  
2 cranes - 100 tph  
Bulk Berths: 5 x 120 m - draft 9 m  
5 x 100m - draft 550 m  
Total uncovered Storage: 190 000  
sqm  
Total covered Storage: 30 000 sqm

**Sète**

**Sete-Multibulk Berth**

2 quai Philippe Regy  
BP 169  
Sète  
Cedex 34203  
France  
Contact: Mr Riethu  
Service du Développement -  
Cellule commerciale  
T: + 33 4 67 46 3501  
F: + 33 4 67 46 28 18  
E: cournon.henri@portsudfrance-  
sete.fr  
W: www.sete.port.fr  
Location: West Mediterranean

Bulk Berths: Max draft: 10.4m  
Total covered Storage: 10,000 sqm

**Sète**

**Sea-invest Sète**



Z.I. portuaire Darse 2  
B.P. 68  
Sète  
Cedex 34201  
France  
Contact: Mr Pierre de Boutray  
T: + 33 467 51 63 10  
F: + 33 467 48 30 85  
E: p.boutray@sea-invest-france.com  
W: www.sea-invest.be

**St Malo**

**SMG - Societe Malouine et**

**Granvillaise**

12 Avenue Louis-Martin  
St Malo  
Cedex 35401  
France  
Contact: Mr Franck Rose  
Marketing  
T: + 33 2 99 563 381  
F: + 33 2 99 401 210  
E: f.rose@blp.bollore.com

**Strasbourg**

**Strasbourg Port Authority**

25, rue de la Nuee-Bleue  
BP 407 R9  
Strasbourg  
Cedex  
67002  
France  
Contact: Mr Jean-Louis Jerome  
Port Director  
T: + 33 388 21 74 74  
F: + 33 388 23 56 57  
E: jl.jerome@strasbourg.port.fr  
W: www.strasbourg.port.fr

**Tarnos**

**Matrama Bayonne**

Rue de l'Industrie  
Tarnos  
40220  
France  
Contact: Mr Vincent Boullault  
T: + 33 240 321 735  
F: + 33 240 650 745  
E: vincent.boullault@sea-invest.fr  
W: www.ports-  
basques.com/ports/bayonne/  
Location: Mouth of the Adour river in  
the corner of the Bay of Biscay  
Total covered Storage: 30,000 sqm  
warehouse

**Toulon**

**Port of Toulon**

PO Box 501  
244, avenue de L'Infanterie de  
Marine  
Toulon  
Cedex 9  
83041  
France  
Contact: Mr Thierry Herve  
Harbour Master  
T: + 33 494 03 27 60 (harbour office)  
F: + 33 494 03 38 69  
E: thierry.herve@equipement.gouv.fr

**GABON**

**Libreville**

**Libreville Port Authority**

Office et Rades du Gabon  
PO Box 1051  
Libreville  
Gabon  
Contact: Mr P Andzembe  
Manager  
T: + 241 70 00 48  
F: + 241 70 37 35

E: info@ports-gabon.com  
W: www.ports-gabon.com

**Libreville**

**Owendo Port Authority**

PO Box 1051  
Libreville  
Gabon  
Port Manager  
T: + 241 70 00 48 / 17 59 / 17 98  
F: + 241 70 37 35  
E: info@ports-gabon.com  
W: www.ports-gabon.com

**GEORGIA**

**Batumi**

**Port of Poti**

52, D. Agmashenebeli Str  
Batumi 4401  
Georgia  
Contact: Mr Zviad  
Head of Marketing  
T: + 995 39320630 / + 995 393 20660  
F: + 995 393 22688  
E: marketing@potiseaport.com  
W: www.potiseaport.com

**Poti**

**Poti Sea Port Corporation**

52, D. Agmashenebeli street  
Poti 4401  
Georgia  
Contact: Mr Zviad Chkhartishvili  
Head of Marketing Department  
T: + 995 493277 500 / 777  
E: zviad.chkhartishvili@  
apmterminals.com  
W: www.apmterminals.com

**GERMANY**

**Brake**

**J. Müller Agri Terminal GmbH &**

**Co. KG**

Neustadtstraße 15  
Brake  
Lower Saxony 26919  
Germany  
Contact: Mr Lars Gottschenkis  
Marketing & Sales  
T: + 49 4401 914 211  
F: + 49 4401 914 228  
E: lars.gottschenkis@jmueller.de  
W: www.jmueller.de  
Location: North of Germany  
Equipment & Capacity: Discharging:  
20,000 mt/day  
Loading: 10,000 mt/day  
Bulk Berths: Max draught inward  
bound: 12.2m  
Max draught outward bound: 11.9m  
Total covered Storage: 465.000 mt  
silos and flat storage  
(New vertical Silo with 47.000 mto  
capacity under construction and ready  
by Autumn 2013) – thereafter total  
covered storage capacity 512.000 mt  
(silo and flat storage)  
Crushing, drying, aspiration available.  
Self service truck loading.  
Certificated: GMP B1, B2, B4.2, B4.4;  
B4.5, B5, Q+S, Öko-VO 834/2007.  
AEO Certificate, IFS Certificate.

**Brake**

**Niedersachsen Ports GmbH &**

**Co. KG**

PO Box 1262  
Brommstrasse 2  
Brake  
26912  
Germany  
Contact: Mr Heiko Uflacker  
Harbour Master  
T: + 49 4401 925200  
F: + 49 4401 3272  
E: post-brake@nports.de  
W: www.nports.de  
Location: German Bight, River Weser  
Total uncovered Storage: 150,000sqm  
Total covered Storage: 180,000sqm

**Brake**

**J. Müller BreakbulkTerminal**

**GmbH & Co. KG**

Nordstr. 2  
Brake  
26912  
Germany  
Contact: Mr Wilhelm Heyer  
VP - Breakbulk Logistic Centre  
T: + 49 4401 914 470  
E: wilhelm.heyer@jmueller.de  
W: www.jmueller.de  
Location: German North Sea coast  
Equipment & Capacity: 2x 88t  
container gantries, 3x 25t luffing  
cranes, 1x 1,000tph shiploader, 1x 32t  
slewing luffing crane, 1x 20t hydraulic  
crane  
Bulk Berths: Strompier (river pier);  
max draught 11.9m; length 275m  
Binnenhafen (inner port); max draught  
5.35m;  
Total uncovered Storage: 115,000sqm  
Total covered Storage: 155,000sqm

**Bremen**

**Weserport GmbH**

Huetttenstrasse 20  
Bremen  
28237  
Germany  
Contact: Mr Michael Appelhans  
Managing Director  
T: + 49 421 643 0182  
F: + 49 421 643 0164  
E: mappelhans@weserport.de  
W: www.weserport.de  
Location: German North Sea Coast  
Equipment & Capacity: 7 cranes up to  
55 to each  
Bulk Berths: about 2,000m with  
draught 9.45m  
Total uncovered Storage: > 250,000  
sqm  
Total covered Storage: > 20,000 sqm  
Please see our website  
www.weserport.de

**Bremerhaven**

**bremenports GmbH & Co. KG**

Am Strom 2  
Bremerhaven  
27570  
Germany  
Contact: Mr Ronald Schwarze  
Marketing  
T: + 49 421 30901 612



# THE GATEWAY TO EUROPE.



## Our location benefits enable long-range services.

duisport offers more than excellent transport connections to enhance the efficiency of your operations in continental Europe. Our services range from 1.5 million sq. m. of warehousing space to the unique opportunities provided by a future oriented logistic park with outstanding state-of-the-art facilities, a perfect integration in transportation networks and plenty of space for developing your business.

duisport has gained a reputation as a transportation and trading hub and developed into a hinterland port of strategic importance for the North Sea ports.

We are ready for the future. duisport – We provide a European service.

**duisport**   
*excellence in logistics*

Tel. +49 (0) 203-80 31  
mail@duisport.com  
www.duisport.com



F: + 49 421 30901 624  
 E: ronald.schwarze@bremenports.de  
 W: www.bremenports.de  
 Location: The Ports of Bremen and Bremerhaven, Northern Germany

**Brunsbüttel**

**Brunsbüttel Ports GmbH**  
 Elbehafen  
 Brunsbüttel  
 Schleswig-Holstein D-25541  
 Germany  
 Contact: Mr Frank Schnabel  
 Managing Director  
 T: + 49 4852 884 35  
 F: + 49 4852 884 26  
 E: f.schnabel@schrammgroup.de  
 W: www.schrammgroup.de  
 Location: At the lower Elbe and at the Kiel-Canal, direct access to North and Baltic Sea  
 Equipment & Capacity: 4 cranes up to 120 t, 2 Oil-fueling devices, etc.  
 Bulk Berths: Vessel length up to 350m, Vessel width up to 55m, draught limits dry cargo pier 14.8m  
 Total uncovered Storage: 483,900sqm  
 Total covered Storage: 27,900sqm  
 Brunsbüttel Ports GmbH is the owner of three ports at Brunsbüttel, Elbehafen, Oilport and Port of Ostermoor

**Duisburg**

**Rhenus AG & Co. KG**  
 August-Hirsch-Strasse 3  
 Duisburg 47119  
 Germany  
 Contact: Mr Ehrenfried Reemer  
 T: +49 203 8009 313  
 F: +49 203 8009 307  
 E: ehrenfried.reemer@de.rhenus.com

**Duisburg**

**Duisburger Hafen AG**

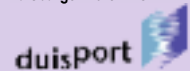

Alte Ruhrorter Straße 42 - 52  
 Duisburg  
 47119  
 Germany  
 Contact: Mr Jan Heitmann  
 T: + 49 203 803 4361  
 F: + 49 203 803 430  
 E: Jan.Heitmann@Duisport.de  
 W: www.duisport.de  
 Duisburger Hafen AG is the owner of the public Port of Duisburg and the parent company of the Duisburger Hafen Group.

**Emden**

**Emden Port Authority**  
 Niedersächsisches Hafenam  
 Emden  
 Friedrich Naumann Strasse 7-9  
 Emden 26725  
 Germany  
 Contact: Mr Frederick Voss  
 Marketing department  
 T: + 49 4921 51770  
 F: + 49 4921 979 860  
 E: fvoss@nports.de  
 W: www.seaport-dmden.de

**Emden**

**EVAG Emden Verkehrs und Automotive**  
 Gesellschaft mbH  
 Schweckendieckplatz 1  
 Emden  
 Lower Saxony 26721  
 Germany  
 Contact: Mr Torsten Meinke  
 Area Manager  
 T: + 49 4921 895 150  
 F: + 49 4921 895 5150  
 E: torsten.meinke@evag.com  
 W: www.evag.com

Location: North-West Germany / River Ems (North-Sea)  
 Equipment & Capacity: 3/Cranes  
 Dischrate 10-15,000 tpd  
 Crane reach 34m  
 Airdraught 14m  
 Bulk Berths: Length : 300m - EVAG controlled berth  
 Draught alongside berth approx. 10.5m - 11m  
 Limited by lock dims of 260 x 40m max experienced sizes: 242 x 32.4m (loa/beam)  
 max inward draught 34-35'  
 max outward draught 33-34'  
 Total uncovered Storage: About 8,500sqm  
 Total covered Storage: On request (occupied at present)  
 Port Operator: Niedersachsen Ports GmbH Co KG Emden  
 Direct access to Railway/Highway

**Flensburg**

**Flensburg Port Authority**  
 Stadwerke Flensburg GmbH, Aht  
 Hafetriebet  
 PO Box 2751  
 Flensburg  
 24917  
 Germany  
 Contact: Mr Frank Partik  
 Harbour Master  
 T: + 49 461 487 1505  
 F: + 49 461 487 1699  
 E: frank.partik@flensburgerhafen.de

**Hamburg**

**Wilhelm Mulch GmbH & Co KG**  
 Zitadellenstrasse 8  
 Hamburg  
 21079  
 Germany  
 Contact: Mr Beyer  
 T: + 49 40 77 14 41  
 F: + 49 40 77 40 94  
 E: beyer@mulch-umschlag.de  
 W: www.mulch-umschlag.de  
 Location: Port of Hamburg, Germany.  
 Equipment & Capacity: 2 handling cranes with calibrated electro-mechanical grabber weighing system, product-specific grabbers for a range of bulk/general cargo.  
 Bulk Berths: Quay length 156m  
 Total uncovered Storage: 8,000sqm of reinforced, enclosed open storage  
 Rail connection.

**Hamburg**

**Hamburg Sud**  
 Willy-Brandt-Strasse 59-61  
 Hamburg  
 20457  
 Germany  
 Contact: Mr Christoph Kelm  
 T: + 49 40 3705 2676  
 E: Christin.Terjung@ham.hamburgsud.com  
 W: www.hamburgsud.com

**Hamburg**

**Kali- Transport Gesellschaft GmbH**  
 Glockengießerwall 3  
 Hamburg  
 20095  
 Germany  
 Contact: Mr Frank Firmkes  
 T: + 49 40 30906 0  
 F: + 49 40 30906 113  
 E: frank.firmkes@k-plus-s.com

**Hamburg**

**BUSS Ross Terminal GmbH & Co KG**  
 Am Travehafen / Schuppen 80-82  
 Hamburg 20457  
 Germany  
 Contact: Mr Heinz J Wasser  
 MD

T: + 49 40 751 93 3500  
 F: + 49 40 751 93 3100  
 E: h.wasser@buss-group.de  
 W: www.buss-group.de  
 Location: Port of Hamburg  
 Equipment & Capacity: 1x 104t mobile crane, various grabs.  
 Discharge rate 8,000 - 10,000 tpd.  
 Bulk Berths: Main berth 230m.  
 Draught 11.5m.  
 Total uncovered Storage: Terminal area: 50,000 sqm  
 Direct connections to the BAB1 and BAB7 motorways.

**Hamburg**

**Diamant Mühle Hamburg GmbH**  
 Trettaustrasse 49  
 Hamburg  
 21107  
 Germany  
 Contact: Ms Gusco  
 Marketing Department  
 T: + 49 40 75 109 01  
 F: + 49 40 75 109 131  
 E: info@diamant-mehl.de  
 W: www.diamant-mehl.de  
 Location: Hamburg, Germany  
 Equipment & Capacity: 1 floating pontoon. 10m floating pontoon. 1 suction tube.  
 100tph for grain.  
 Bulk Berths: Max Depth 5m.  
 Grain discharge only.

**Hamburg**

**Eichholtz GmbH**  
 Rossweg 20  
 Hamburg  
 20457  
 Germany  
 T: + 49 40 741 39 00 0  
 F: + 49 40 741 39 00 21  
 E: info@eichholtz.de  
 W: www.eichholtz.de  
 Location: Rosshafen/Hachmannkai, Port of Hamburg  
 Equipment & Capacity: Mobile cranes.  
 Bulk Berths: 3 berths. Quay length 440m. Max Depth 11m.  
 Total covered Storage: 165,000sqm warehouse, of which 100,000sqm in the Free Port

**Hamburg**

**HANSAPORT**  
 Hafenbetriebsgesellschaft mbH  
 Am Sandauhafen 20  
 Hamburg  
 21129  
 Germany  
 Contact: Mr Erhard Meller  
 T: + 49 40 74003 201  
 F: + 49 40 74003 222  
 E: info@hansaport.de  
 W: www.hansaport.de  
 Location: Port of Hamburg  
 Equipment & Capacity: 4x discharge bridges each with 38t lifting capacity.  
 Handling capacity 15,000,000tpa  
 Bulk Berths: 3 berths. Draught 15.1m.  
 Length 760m for large vessels, 240m for small vessels.  
 Total uncovered Storage: 350,000 sqm  
 Rail connection with 15 tracks for block trains.

**Hamburg**

**H J M (H Jürgen Müller GmbH)**  
 1 Hafenstrasse 12-14  
 Hamburg  
 21079  
 Germany  
 T: + 49 40 725 86 90  
 F: + 49 40 725 86 929  
 E: info@hjm-hamburg.de  
 W: www.hjm-hamburg.de  
 Location: Seehafen 1, Port of Hamburg  
 Equipment & Capacity: 3 track-bound cranes, 2 mobile cranes, 4 silo

hoppers.  
 Bulk Berths: 2 berths. Quay length 250m. Max Depth 6.6m plus height of tide about 3.5m.  
 Total uncovered Storage: 20,000sqm  
 Total covered Storage: 3 enclosed silos of 32,500m3 total.

**Hamburg**

**Louis Hagel (GmbH & Co. KG)**  
 Eversween 19  
 Hamburg  
 21107  
 Germany  
 Contact: Mrs Sandra Reidock  
 T: + 49 40 751651  
 F: + 49 40 7533440  
 E: info@louis-hagel.com  
 W: www.louis-hagel.com  
 Location: Port of Hamburg  
 Equipment & Capacity: One 8t crane, one dry bulk loader (600-800t/h), two warehouses with several boxes, two truck loading facilities, a company owned railroad track  
 Bulk Berths: The constant water-depth of 11 m (tide independent) allows loading of vessels with a breadth up to 25m and a loading tonnage of approximately 30,000t.  
 Total covered Storage: 6.400 m2, 36,000t  
 The Hagel bulk terminal with a high-tec loader and combined storage capacities guarantees a quick and flexible handling of vessels up to 30,000 tons. Check out possible operations of our 8-tons crane for bulk goods.

**Hamburg**

**NHG - Neuhoof Hafengesellschaft mbH**  
 Köhlbrandstraße 3  
 Hamburg  
 D-21107  
 Germany  
 Contact: Mrs Kleinschmidt  
 T: + 49 40 752 7070  
 F: + 49 40 752 2512  
 E: info@neuhoof-hafen.de  
 W: www.neuhoof-hafen.de  
 Location: Port of Hamburg  
 Equipment & Capacity: 3 elevator systems of which, 1 mechanical discharge tower - 1,000tph, 2 pneumatic elevators - 350tph each, 1 loading-discharge tower - 250tph, 1 loader 1,200tph.  
 Approx capacity 2.5 million tpa  
 Bulk Berths: 4 berths, Draught 12.4m  
 Length 175m / 110m  
 Total covered Storage: 180,000 tonnes  
 Rail connection, truck dispatch.

**Hamburg**

**OAM Baustoffe GmbH**  
 Kirchenpauerkai 29  
 Hamburg  
 20457  
 Germany  
 T: + 49 40 81 97 870  
 F: + 49 40 81 97 8720  
 E: info@oam-bau.de  
 W: www.oam-bau.de  
 Location: Afrika-Terminal, Port of Hamburg,  
 Equipment & Capacity: Inland-waterways vessels, barges, grabbers, Panamax.  
 2 million tonnes capacity.  
 Bulk Berths: 4 berths. Quay length 100m. Max Depth 10.5m  
 Quay facility with parallel rail siding, warehouse capacity.

**Hamburg**

**Silo P. Kruse Betriebs-GmbH & Co. KG**  
 Blumensand 31 - 33  
 Hamburg

D - 21107  
 Germany  
 Contact: Mrs Kleinschmidt  
 Management  
 T: + 49 40 75206 0  
 F: + 49 40 75206 206  
 E: info@silo-p-kruse.de  
 W: www.silo-p-kruse.de  
 Location: Port of Hamburg  
 Equipment & Capacity: 2 pneumatic systems, 1 travelling crane bridge.  
 Handling capacity approx. 1,000tph.  
 Bulk Berths: 2 berths. Draught 12.5m. Length 275m  
 Total covered Storage: 80,000 tons in 200 silo compartments (ranging from 100 to 7,000 tons)  
 Drying, cleaning

**Hamburg**

**Buss Group GmbH & Co. KG**  
 Reiherdamm 44  
 Hamburg  
 20457  
 Germany  
 Contact: Mr J Killinger  
 Managing Director  
 T: + 49 40 3198-0  
 F: + 49 40 31 98 20 00  
 E: j.killinger@buss-group.de  
 W: www.buss-group.de  
 Location: Port of Hamburg  
 Equipment & Capacity: - 1 double boom crane with capacity of 40t, outreach max. 50 m, grab operation 16t  
 - 1 crane with capacity of 45 t, outreach max. 50 m, grab operation 16t  
 - 2 single boom cranes with capacity of 8t, outreach max. 36 m  
 - 1 mobile crane with capacity of 140t, outreach max. 51 m, grab operation 30t  
 Discharge rate 15 t/day.  
 2 double-link level luffing slew cranes (40-45t lifting capacity).  
 2 single-link level luffing slew cranes (8t lifting capacity).  
 Bulk Berths: Draught 11.5m, Main berth 380m  
 Total uncovered Storage: 215,000 sqm  
 Total covered Storage: 65,000 sqm  
 The terminal has direct connections to the goods station Hamburg-Süd and to the BAB 1 and BAB 7 motorways.

**Hamburg**

**GTH - Getreide Terminal Hamburg (GmbH & Co.KG)**  
 Eversween 11  
 Hamburg  
 D-21107  
 Germany  
 Contact: Mr Kay Boehmer  
 T: + 49 40 75106 121  
 F: + 49 40 75106 133  
 E: k.boehmer@getreide-terminal.de  
 W: www.getreide-terminal.de  
 Location: Port of Hamburg  
 Equipment & Capacity: Discharge rate 1,000t/h.  
 2 loading systems with up to 22,000t/day capacity.  
 Bulk Berths: Draught 12.4m. Length 270m.  
 Total covered Storage: Two warehouses capable of holding 35,000 tons of heavy grain.  
 Eleven silo complexes that can hold a total of 220,000 tons, divided up into 550 cells with a capacity of between 60 and 3,000 tons.  
 Drying, cleaning, cooling fumigation, customs clearance, sample check etc

**Hamburg**

**K+S Terminal (Kalikai)**  
 K+S Transport GmbH  
 Blumensand 27  
 Hamburg

D-21107  
Germany  
T: + 49 40 75275 0  
F: + 49 40 75275 122  
E: kalitransport@k-plus-s.com  
W: www.kalitransport.com  
Location: Port of Hamburg  
Equipment & Capacity: 2x grabs (12/20 mt).  
3x Shiploaders.  
Loading rate 2,000/ 3,000 mt/hour  
Bulk Berths: Main berth 500m.  
Draught 11.3m  
Total covered Storage: Total storage 405,000mt in 12 sheds and 7 silos.

## Hamburg

**HaBeMa Futtermittel GmbH & Co KG**  
Pollhornweg 25  
Hamburg  
D - 21107  
Germany  
T: + 49 040 752705 0  
F: + 49 40 75 27 05 33  
E: kontakt@habema.com  
W: www.habema.com  
Location: Reiherstieg-Süd, Port of Hamburg.  
Equipment & Capacity: Travelling crane, bridge slew crane, shiploader.  
Discharge capacity up to 10,000t/day.  
Loading capacity up to 15,000t/day.  
Bulk Berths: 2 berths. Quay length 330m, Max depth 12m.  
Total covered Storage: 61,000sqm warehouse space for approx. 150,000t of cargo.  
Rail connection to freight railway station Hohe Schaar, grain and animal feed loading for standard sea containers.

## Hamburg

**Mittal Steel Hamburg GmbH**  
Dradenaustr. 33  
Hamburg  
21129  
Germany  
Contact: Ms Stephanie Tremblay  
T: + 49 40 74 080  
F: + 49 40 74 01432  
E: stephanie.tremblay@arcelormittal.com  
W: www.mittalsteel.com  
Location: Dradenauhafen, Port of Hamburg  
Equipment & Capacity: 1 level luffing crane 12.5t, 1 crane bridge 25t, 1 mobile grabber.  
Bulk Berths: Quay length 460m, Max Depth 12.5m  
Company terminal, rail connection.

## Hamburg

**Port of Hamburg Marketing Association**  
Pickhuben 6  
Hamburg  
D-20457  
Germany  
Contact: Mr Bengt van Beuningen  
Director Communications  
T: + 49 40 3770 9110  
F: + 49 40 3770 9199  
E: vanbeuningen@hafen-hamburg.de  
W: www.hafen-hamburg.de  
Location: Universal port Hamburg located in northern Germany  
Information about the different bulk terminals under www.portofhamburg.com.

## Hamburg

**Hamburg Port Authority**  
Neuer Wandrahm 4  
Hamburg  
D - 20457  
Germany  
Contact: Mr Wolfgang Hurtienne  
Head of Port Planning Division  
T: + 49 40 4 2847 2311  
F: + 49 40 4 2847 2499  
E: wolfgang.hurtienne@hpa.hamburg.de  
W: www.hpa.hamburg.de

## Itzehoe

**Itzehoe Port Authority**  
Stadtwerke Itzehoe  
Gasstrasse 18  
Itzehoe  
25524  
Germany  
Contact: Mr Lausecker  
Harbour Master  
T: + 49 4821 774409  
F: + 49 4821 774417  
E: info@stadwerke-itzehoe.de  
W: www.stadwerke-itzehoe.de

## Krefeld

**Krefeld Port Authority**  
Oberstrasse 13  
Krefeld  
Uerdingen  
D-47829  
Germany  
Contact: Mrs Elizabeth Lehnen  
T: + 49 2151 49270  
F: + 49 2151 492750  
E: hafen-und-bahnbetriebe@krefeld.de

## Leer

**Rhenus AG**  
Hafenstrasse 14  
Leer  
26789  
Germany  
Contact: Mr Schröter  
T: + 49 491 92512 0  
F: + 49 491 92512 66  
E: info@de.rhenus.com  
Location: North West Germany  
Equipment & Capacity: 25,000 storage area  
Bulk Berths: Up to 5.3m draught seaport  
Total uncovered Storage: 25,000sqm  
Total covered Storage: 7,000sqm  
Trimodal terminal

## Neuss

**Neuss Port Authority**  
Städtische Hafenbetriebe Neuss  
Hammer Landstrasse 3  
Neuss  
41460  
Germany  
Contact: Mr Scheffer  
Harbour Master  
T: + 49 2131 53 230  
F: + 49 2131 5323105  
E: info@nd-haefen.de

## Nordenham

**Rhenus Midgard GmbH & Co. KG**  
  
Midgardstr. 50  
Nordenham  
26954  
Germany  
Contact: Mr Michael Appelhans  
Managing Director  
T: + 49 4731 81209  
F: + 49 4731 81258  
E: michael.appelhans@de.rhenus.com  
W: www.rhenus.com  
Location: German Bight, at River Weser  
Equipment & Capacity: 10 Shorecranes fitted for bulk and breakbulk cargo, heavylifts up to 100ts  
Bulk Berths: 2.0km berths, max. draught 9,45m  
Total uncovered Storage: 250,000sqm  
Total covered Storage: 50,000sqm  
Further services like stevedoring, agency, chartering of deepsea vessels and river barges are offered out of one hand.

## Nuremberg

**Hafen Nürnberg-Roth GmbH**  
Rotterdam Str 2  
Nuremberg  
Bavaria  
90451  
Germany  
Contact: Mr Harald Leupold  
Managing Director  
T: + 49 911 6429 418  
F: + 49 911 6429 410  
E: h.leupold@gvz-hafen.com  
W: www.gvz-hafen.com  
Location: South Germany  
Equipment & Capacity: More than 11 Mill. tons cargo turn over p.y.  
Total uncovered Storage: 3,370,000sqm  
260 companies located with more than 5,500 employees, multimodale gateway for South-East-Europe.

## Oldenburg

**Seaports of Niedersachsen GmbH**  
Hindenburgstrasse 28  
Oldenburg  
Niedersachsen  
D-26122

Germany  
Contact: Ms Inke Onnen-Lübben  
Marketing & Communications  
T: + 49 441 361 88882  
F: + 49 441 361 88889  
E: onnen-luebben@seaports.de  
W: www.seaports.de  
Location: Geographical prime location in Germany, directly on the estuaries of the large waterways in the German Bight and adjacent to the Kiel Canal.  
Seaports of Niedersachsen GmbH represents nine seaports with numerous port handling operators, trans-regionally active logistical networks and specialists for every type of port service.

## Papenburg

**Schulte + Bruns GmbH & Co. KG**  
Papenburg  
Germany  
Contact: Mr Smidt  
T: + 49 4961 8060  
F: + 49 4961 806116  
E: Schulte-bruns@schulte-bruns.de

## Rostock

**Bulk Terminal Rostock GmbH**  
Liebherstraße 3  
Rostock  
D-18147  
Germany  
Contact: Mr Günter Fett  
Managing Director  
T: + 49 381 6662 120  
F: + 49 381 6662 575  
E: guenter.fett@portofrostock.de  
W: www.portofrostock.de

## Rostock

**Seehafen Rostock Umschlagsgesellschaft mbH**  
Am Hansakai 14  
Rostock  
18147  
Germany  
Contact: Mrs Monica Muller  
Assistant  
T: + 49 381 6662101  
F: + 49 381 6662 205  
E: info@portofrostock.de  
W: www.portofrostock.de

## Rostock

**Getreide Service Rostock GmbH**  
Am Getreidehafen 3  
Rostock  
D-18147  
Germany  
Contact: Mr Karsten Lentz  
Managing Director  
T: + 49 381 6662 580  
F: + 49 381 6662 505  
E: karsten.lentz@portofrostock.de  
W: www.portofrostock.de  
Location: Baltic Sea  
Equipment & Capacity:  
Loading/unloading cap. 300- 1000 tph  
Total covered Storage: Silos 360.000 t

## Stade

**Butzfleth Port Authority**  
Niedersächsisches Hafenam  
Johann Rathje Koser Str 4  
Stade  
Hamburg  
21683  
Germany  
Contact: Mr Reinhart Gabriel  
Harbour Master  
T: + 49 4146 93810  
F: + 49 4421 4800  
E: postelle@nhajw.niedersachsen.de

## Stralsund

**Port of Stralsund**  
Stralsunder Hafen und Lagerhaus  
Hafenstrasse 20  
Stralsund  
18439



## COAL INTO GERMANY

via Rhenus Midgard's Seaports

**Coal Terminal NSB (Niedersachsenbrücke) in Wilhelmshaven, Jade Bay (Germany):**

- New: Capesize Vessels up to 250.000 dwt with a draft up to 18,50 m (60') sw
- Rail connections into Germany's hinterland and neighbourhood countries

**Coal Terminal Nordenham on the River Weser (Germany):**

- Rail- and inland waterway connections to Germany's hinterland and beyond
- Panmax- and partly loaden Cape Size Vessels with a draft up to 13,10 m (43') fw

Both ports handle close to 5 million tons, i.e. more than 10% of the imported coal into Germany.

**Rhenus, a company with a long history, is one of the world's leading providers of integral logistics services and has annual turnover totaling 3.4 billion Euro.**



Rhenus Midgard Wilhelmshaven GmbH & Co. KG · Lüneburger Str. 6 · D-26384 Wilhelmshaven  
Tel. +49 (0)4421 936-135 · Fax +49 (0)4421 936 104  
info.wilhelmshaven@de.rhenus.com · www.rhenus.com



Germany  
Contact: Mr Wolfgang Ostenberg  
Port Manager  
T: + 49 3831 25420  
F: + 49 3831 254297  
E: ostenberg@seehafen-stralsund.de

**Wilhelmshaven**

**Rhenus Midgard Wilhelmshaven GmbH & Co KG**  
Lüneburger Str. 6  
Wilhelmshaven  
Lower Saxony  
26384  
Germany  
Contact: Mr Jürgen Kleemeyer  
Coal Logistics Projects / Marketing & Sales  
T: + 49 4421 936 135  
F: + 49 4731 818 114  
E: juergen.kleemeyer@de.rhenus.com  
W: www.rhenus.com  
Location: Port of Wilhelmshaven, River Jade (Germany)  
Equipment & Capacity: Discharging rate 25,000tpd  
Bulk Berths: Bulkterminal "Niedersachsenbrücke" / draught 18.5m sw  
Total uncovered Storage: 80,000sqm  
Terminal "Niedersachsenbrücke" is under construction for fully loaded Capesize with a draught up to 18.50m sw, discharging rate > 50,000tpd, 10 M tpa coal, 3.5 M t stockpile etc.

**GHANA**

**Takoradi**

**Ghana Ports & Harbours Authority**  
PO Box 708  
Takoradi  
Ghana  
Contact: Mr Nester P Galley  
Director of Port  
T: + 233 312 4073  
F: + 233 312 2814  
E: takoradi@ghanaports.net  
W: www.ghanaports.gov.gh/

**Takoradi**

**Takoradi Port Authority**  
Ghana Ports Authority  
PO Box 708  
Takoradi  
Ghana  
Contact: Mr J E Quanash  
Port Manager  
T: + 233 31 24073  
F: + 233 31 22814  
E: takoradi@ghanaports.net  
W: www.ghanaports.gov.gh

**Tema**

**Tema Port**  
Valco Private Berth  
c/o Ghana Ports Authority  
PO Box 488  
Tema  
Ghana  
Contact: Mr I Carson  
Port Services Director  
T: + 233 221 204136 8  
F: + 233 31 22814  
E: tema@ghanaports.net  
W: www.ghanaports.gov.gh

**GREECE**

**Alexandroupolis**

**Alexandroupolis Port Authority**  
  
Alexandroupolis  
68100  
Greece  
Contact: Mr N Papanikolopoulos  
Harbour Master  
T: + 30 255 102 6468

F: + 30 255 102 1430  
E: alex@yen.gr

**Aliveri**

**Mylaki Port Authority**  
c/o Milaki Shipping Agency Ltd  
18 A Nikka Street  
Aliveri  
345 00  
Greece  
Port Manager  
T: + 30 223 23692  
F: + 30 223 23789

**Attica**

**Milaki Port-East Mediterranean Coal Terminal**  
49-51 Sof Venizelou Str  
Lycovrissi  
Attica  
14123  
Greece  
Contact: Mr Andrew Healey  
General Manager  
T: + 30 1 2898 111  
F: + 30 1 2840 021

**Chalkis**

**Chalkis Port Authority**  
1 Athinon Avenue  
Chalkis  
34100  
Greece  
Contact: Mr George Papanicolaou  
Harbour Master  
T: + 30 222 102 8888  
F: + 30 222 108 8888  
E: halk@yen.gr

**Chania Crete**

**Suda Bay Port**  
c/o Port Authority of Chania  
21 Akti Tompazi  
Chania Crete  
Greece  
T: + 30 282 10 98888  
F: + 30 282 10 28387

**Corfu**

**Corfu Port Authority**  
Xen Stratigou 2  
Corfu  
Greece  
T: +30 266 103 2655  
F: +30 266 103 9918

**Itea**

**Itea Port Authority**  
Itea Harbour  
Akti Poseidonos & 1, Iroon Str.  
332  
Itea  
Greece  
Port Master  
T: + 30 266 503 2319  
F: + 30 226 503 2100

**Kalamata**

**Kalamata Port Authority**  
Harbour Office  
Kalamata  
24101  
Greece  
Executive Director  
T: + 30 272 102 2218  
F: + 30 272 109 6880

**Milos Island**

**Milos Island Port Authority**  
Adhamas Harbour  
Milos Island  
84800  
Greece  
Contact: Port Authority Employees  
T: +30 22870 22100 / 1/ 23360  
F: + 30 22870 22100  
E: milos@hcg.gr

**Nissyros**

**Yali Island Port Authority**  
Port of Nissyros Island  
Nissyros Island  
Nissyros  
Greece  
Contact: Mr Boutis Evangelos  
Harbour Master  
T: + 30 224 203 1222  
F: + 30 224 203 1426

**Piraeus**

**Piraeus Port Authority**  
10 Atki Miaouli  
Piraeus  
18538  
Greece  
Contact: Mr George Anoneripis  
President / CEO  
T: + 30 210 4550229  
F: + 30 210 4550310  
E: prolp@olp.gr  
W: www.olp.gr

**Pylos**

**Pylos Port Authority**  
Harbour Office  
Pylos  
24001  
Greece  
Contact: Mr T Kakalis  
Harbour Master  
T: + 30 272 302 2225  
F: + 30 272 302 2007  
E: pylo@yen.gr

**Thessaloniki**

**Thessaloniki Port Authority SA**  
1st Pier  
Port of Thessaloniki  
Thessaloniki  
54110  
Greece  
Contact: Mr Stylianos Aggeloudis  
Chairman & CEO  
T: + 30 2310 593 105  
F: + 30 2310 510 500  
E: secretariat@thpa.gr  
W: www.thpa.gr  
Location: Mediterranean Sea,  
Northern part of the Aegean Sea  
Equipment & Capacity: 44 quay sea  
to shore gantry cranes 3-40 tonnes  
lifting capacity  
Bulk Berths: 30 berths, total length  
4000m, draught 10-12m  
Total uncovered Storage: 500,000sqm  
Total covered Storage: 100,000sqm

**GADELOUPE**

**Point A Pitre**

**Pointe-a-Pitre Port**  
Guadeloupe Port Authority  
PO Box 485  
Point A Pitre  
Cedex 97165  
Guadeloupe  
Contact: Mr Bernard Le Gall  
Harbour Master  
T: + 590 590 686 320  
F: + 590 590 686 301  
E: b-legal@port-guadeloupe.com  
W: www.port-guadeloupe.com

**GUAM**

**Piti**

**Apra Harbour**  
Port Authority of Guam  
Suite 201  
1026 Cabras Highway  
Piti  
96925  
Guam  
Contact: Mrs Mary C. Torres  
Port General Manager  
T: + 671 477 5931  
F: + 671 477 4445

E: webmaster@portguam.com  
W: www.portguam.com/  
Location: Western Pacific Region  
Equipment & Capacity: Tractor-31; Toplifter-4; Sideloaders -4; 40 ft. Shoreside Gantry-5; 20 ton Forklift-2; 10 ton Forklift -4; 3 ton Forklift -1; 5 ton Forklift -9; 150 ton Mobile Harbor Crane -1; R.T.G.'s -2  
Bulk Berths: 3 containers; 2 general cargo; access to 2 big tanker fuel piers  
Total uncovered Storage: 33 Acres  
Total covered Storage: 86,000 sq. ft.  
The Port of Guam is currently undergoing a \$200 million modernization program to upgrade its facility.

**GUYANA**

**Georgetown**

**Georgetown Port Authority**  
Transport and Harbours  
Department  
Battery Road and Fort Street  
Kingston  
Georgetown  
Guyana  
Contact: Mr William Joseph  
General Manager  
T: + 592 225 9350  
F: + 592 227 8545  
E: gnscc@guyana.net.gy  
W: www.gnscc.com

**Kingston**

**Linden Port Authority**  
Transport and Harbours Department  
Battery Road  
Kingston  
Georgetown  
Guyana  
Contact: Mr I English  
General Manager  
T: + 592 2 59350  
F: + 592 2 78545  
E: gnscc@guyana.net.gy  
W: www.gnscc.com

**Kingston**

**New Amsterdam Port Authority**  
c/o Transport and Harbours  
Department  
Battery Road  
Kingston  
Georgetown  
Guyana  
Contact: Mr I English  
General Manager  
T: + 592 2 67842  
F: + 592 2 78545  
E: gnscc@guyana.net.gy  
W: www.gnscc.com

**HAITI**

**Port Au Prince**

**Port Au Prince Port Authority**  
National Port Authority  
PO Box 616  
Port Au Prince  
Haiti  
Contact: Mr J B Vital  
Port Master  
T: + 509 223 2440  
F: + 509 221 3479  
E: apnpap@apn.gouv.ht  
W: www.apn.gouv.ht

**HONDURAS**

**Puerto Cortés**

**National Port Company**  
Barrio EL Centro  
1 ave  
1 calle  
Puerto Cortés

Nº. 18  
Honduras  
Contact: Mr José Manuel Arriaga  
Yacáman  
General Manager  
T: + 504 665 0987  
F: + 504 665 1402  
E: gerencia@epn.hn

**Puerto Cortés**

**Puerto Cortés Port Authority**  
Empresa Nacional Portuaria  
PO Box 18  
Puerto Cortés  
Honduras  
Contact: Snr Fernando E Alvarez L.  
Assistant General Manager  
T: + 504 665-0987  
F: + 504 665-1402  
E: gerencia@epn.hn

**San Pedro Sula**

**Terminales de Cortes, S.A de C.V**  
Blvd del Norte 150 mts este Puento  
Rio Blanco  
Apartado Postal 298  
San Pedro Sula  
11111  
Honduras  
Contact: Mr Juan Zelaya  
General Manager  
T: + 504 551 7011  
F: + 504 551 7000  
E: gmanager@termisa.com  
W: www.termisa.com  
Location: Puerto Cortes (Caribbean sea), San Lorenzo (Pacific Ocean)  
Equipment & Capacity: Bulk discharge with clamshells and hoppers, we can discharge 3 handysize vessel at same time. Average discharge rate for bulk is 1500 MT/WWD per workable hold with dedicated crane  
Bulk Berths: Berth #3 draft: 34ft; Berth #4 draft: 28ft  
Total uncovered Storage: No uncovered storage inside the port

**ICELAND**

**Grundartangi**

**Grundartangi Port**  
c/o Icelandic Alloys Ltd  
Skilmannahreppur, 301 Akranes  
Grundartangi  
Iceland  
Contact: Mr Smali  
Transport Manager  
T: + 354 432 0390  
F: + 354 432 0101  
E: smali@klafi.is

**Hafnarfjörður**

**Port of Hafnarfjörður**  
Óseyrarbraut 4  
Hafnarfjörður  
220  
Iceland  
Contact: Mr Kristinn Aadnegard  
Harbour Master  
T: + 354 414 2300  
F: + 354 414 2301  
E: port@hafnarfjordur.is  
W: www.hafnarfjardarhofn.is  
Location: South West Iceland, 10 km. south of Reykjavik, Iceland's Capital

**Raohusinu**

**Vestmannaeyjar Port Authority**  
Harvarstjorn Vestmannaeyjar  
Raohusinu  
Vestmannaeyjar  
900  
Iceland  
Contact: Mr S Olafsson  
T: + 354 481 1207  
F: + 354 481 3115  
E: olisnorra@vestmannaeyjar.is

**Reykjavik**

**Associated Icelandic Ports**  
Hafnarhusio/Tryggvagotgu 17  
Reykjavik  
121  
Iceland  
Contact: Mr Gisli Gislason  
Port Director  
T: + 354 525 8900  
F: + 354 525 8990  
E: gislign@faxi.is  
W: www.faxaports.is

**INDIA**

**Adyar**

**Subarnarekha Port Private Ltd**  
New No.84, Old No.50  
"Dakshin", 1st Ave, Indranagar  
Adyar  
Chennai  
600020  
India  
Contact: Mr Ramani Ramaswamy  
Joint Managing Director  
T: + 914424431900  
F: + 914442607368 - Ext 18  
E: subarnarekha.port@gmail.com  
W: www.creativeports.com

**Bhavnagar Gujarat**

**Bhavnagar Port Authority**  
Gujarat Maritime Board  
New Port Bhavnagar  
Bhavnagar Gujarat  
364005  
India  
Port Officer  
T: + 91 2712 38346  
F: + 91 2712 34703  
E: gmbad1@sancharnet.in

**Bhubaneswar**

**DPCL - Dhamra Port Company Limited**  
Fortune Towers, 2nd floor  
Chandrasekharpur  
Bhubaneswar  
Orissa  
751 023  
India  
Contact: Mr Santosh Mohapatra  
Chief Executive Officer  
E: ceo@dhamraport.com  
W: www.dhamraport.com

**Calcutta**

**Calcutta Port Trust**  
15 Strand Road  
Calcutta  
700 001  
India  
Contact: Captain Akbagchi  
Director Marine Department  
T: + 91 33 2230 3451  
F: + 91 33 2230 3214  
E: calport@vsnl.com  
W: www.portofcalcutta.com

**Calicut**

**Calicut Port Authority**  
Port Officer Calicut  
PO Box 1108  
Kerala 673 032  
Calicut  
673032  
India  
Contact: Capt AK Bagchi  
Director of Marine Department  
T: +91 495 274604  
F: + 91 495 274604  
E: portsdirector@asianet.in

**Chennai**

**Karaikal Port Private Limited**  
4th Floor, MARG Panchar  
Block B, No. 334, Futura IT Park  
Rajiv Gandhi Salai (OMR)  
Sholinganallur

Chennai  
Tamil Nadu  
600119  
India  
Contact: Mr N Suresh  
Senior VP, Business Development  
T: + 91 44 4562 4000  
F: + 91 44 4562 4617  
E: business@karaikalport.com  
W: www.karaikalport.com  
Location: 300 kms south of Chennai  
on the Tamil Nadu coast  
Equipment & Capacity: 3 MHC with  
35 cbm grabs, 105 tonnes each  
Bulk Berths: 2 Capesize berths, 2  
panamax size berths and 1 for smaller  
vessels up to 30,000dwt.  
Total uncovered Storage: 450,000sqm  
Total covered Storage: 63,000sqm  
- Multi Cargo Port.  
- Handles Gearless Panamax vessels.  
- Good connectivity through rail &  
road.  
- Handled Over 15 MMT of cargo so  
far.  
- Achieved good discharge rates.  
- No berthing delays.  
- Port capacity 50 MMT by 2016.  
- Great potential for port based  
industries available near the port.

**Chennai**

**Port of Chennai**  
Rajaji Salai  
Chennai  
600 001  
India  
Marketing Manager  
T: + 91 253 611 39 ext 2505  
F: + 91 253 602 78  
E: info@chennaiport.gov.in  
W: http://www.chennaiport.com

**Chennai**

**Sical Logistics Limited**  
4th Floor, Spic House  
88 Mount Road  
Guindy  
Chennai  
600 032  
India  
Contact: Mr K Sridhar  
T: + 91 44 42118611  
F: + 91 44 42118620  
E: information@sical.com  
W: www.sical.com

**Chennai**

**Ennore Port Limited**  
No.23, First Floor,  
P.T. Lee Chengalvaraya Naicker  
Maaligai  
Rajaji Salai,  
Chennai 600 001  
India  
Contact: Mr Shri S. Velumani  
Chairman  
T: + 91 44 25251666 / 1  
F: + 91 44 25251665  
E: svm@epl.gov.in  
W: www.ennoreport.gov.in

**Churchgate**

**Yogaytan Ports Pvt. Ltd.**  
4, Vaswani Mansions,  
120, Dinsha Vaccha Road  
Churchgate  
Mumbai  
400020  
India  
Contact: Mr Harihardas Raj  
Sr. Executive  
T: + 91-22-2288 0000  
F: + 91-22-2204 0000  
E: info@yogayatangroup.com  
W: www.yogayatangroup.com/

**Cochin**

**Cochin Port Trust**  
Willingdon Island  
Cochin

Kerala State  
682 009  
India  
Contact: Dr C. Unnikrishnan Nair  
Traffic Manager  
T: + 91 484 266 6418  
F: + 91 484 266 6418  
E: tm@cochinport.gov.in  
W: www.cochinport.gov.in  
Location: On the western coast of  
India towards Southwest 930km south  
of Mumbai and 320km north of  
Kanyakumari  
Latitude: 09°-57'-45" North  
Longitude: 76°-08'-59" East  
Equipment & Capacity: Mobile  
Harbour Crane(MHC)-1 no. of 40T  
cap.  
Mobile Crane-1no. of 40T cap.  
Fork Lift Trucks-22nos. of 3T  
cap.(includes 2 new Komatsu made)  
New Reach stacker-1 no. of 45T cap.  
Bulk Berths: Dedicated berth for FACT  
Ltd. with Grab unloader and  
mechanical conveyor for handling  
Fertiliser raw material  
Total uncovered Storage: 3 lakh m2 at  
wharves. Vast open area available  
outside the wharves also.

**Devanampattinam**

**Cuddalore Port Authority**  
Tamilnadu Port Department  
Marine House  
Beach Road  
Devanampattinam  
Tamil Nadu  
605 003  
India  
Contact: Mr S Sainath  
Port Officer  
T: + 91 4142 2025

**Dist. Nellore**

**Krishnapatnam Port Company Limited**  
P.O. Bag No. 1  
Muthukur  
Dist. Nellore  
Andhra Pradesh  
524 344  
India  
Customer Service Team  
T: + 91 861 2377999  
F: + 91 861 2377046  
E: customerservice@krishnapatnamport.com  
W: www.krishnapatnamport.com  
Location: -> 14° 15' N latitude, 80°  
08' E longitude.  
180 km north of Chennai.  
Located in Nellore (District HQ of  
Andhra Pradesh), on National  
Highway 5 (Chennai-Kolkata).  
26 km from Venkatchalam, the  
nearest rail head on the Chennai-  
Kolkata main line.  
Vast hinterland covering Southern  
Andhra Pradesh, Districts of  
Rayalseema, North Tamil Nadu and  
Eastern Karnataka.  
Equipment & Capacity: 13 shore  
cranes (10 Liebherr, 2 Gottwald, 1  
Sennebogen) with a capacity of 750  
to 1,000 Mtpd per crane  
Dedicated port-owned cargo-handling  
equipment - tippers, loaders,  
excavators and dozers  
4 locomotives for rake movements  
21 weighbridges. 7 of 120 MT and 14  
of 60 MT and 2 In-motion Railway  
weighbridges  
Dedicated Railway sidings - 6 for coal,  
4 for bagged cargo, 4 for granite  
cargo  
24 Automatic bagging machines each  
with a bagging capacity of 2,000 Mtpd  
Bulk Berths: -> 10 multi-purpose  
berths at north side and two berths at  
south side  
18m draught; deepest port in India.  
Dedicated Project Cargo berth with 12  
MT per CBM

Total uncovered Storage: 6,500 acres  
Total covered Storage: 13 closed  
warehouses with a total covered area  
of 1.5 Mn sq. ft for storing sensitive  
cargos like Fertilizers, Agri  
commodities, etc.  
All weather port with 24 x 7  
operations, all throughout the year  
Deep draught capable of handling  
Capesize vessels  
High load & discharge rates leading to  
faster turnaround of vessels  
Strategically located port in terms of  
road / rail distances  
Port provides single window clearance  
system for port users from  
stevedoring to custom documentation  
without the inconvenience of multiple  
interfaces (CHA, Stevedores,  
Customs, Port)  
KPCL is now certified to the ISO  
9001, ISO 14001, OHSAS 18001 and  
ISO 28000 management system  
standards by DNV

**Gandhinagar**

**Gujarat Maritime Board**  
GMB Head Quarters  
Sector 10-A, Opp. Air Force Station  
Gandhinagar  
Gujarat  
382 010  
India  
Contact: Shri H K Dash  
CEO  
T: + 91 79 232 383 46  
F: + 91 79 232 347 03  
E: gmbad1@sancharnet.in  
W: www.gmbports.org

**Goa**

**Mormugao Port Trust**  
Headland Sada  
Goa  
403804  
India  
Contact: Mr KC Kuncheria  
Traffic Manager/Chief Mechanical  
Engineer  
T: + 91 0832 2521170  
F: + 91 0832 2521175  
E: cme@mptgoa.com  
W: www.mptgoa.com  
Location: West Coast of India  
Equipment & Capacity: Mechanical  
Ore Handling Plant with a loading  
capacity of 8,000 tph  
Bulk Berths: 2 no. Multipurpose  
General Cargo Berths  
1 no. Iron Ore handling berth.  
2 no. Coal/Coke handling berths  
operated on BOOT basis.  
Total uncovered Storage: 3.25 lakh  
sqm  
Total covered Storage: 41562 sqm.  
Besides Mechanical Ore Handling  
Plant, Iron Ore is also handled in mid  
stream by transhippers, floating  
cranes, ship's own gears and at  
Mooring Dolphins.

**Gujarat**

**Kandla Port Trust**  
PO Box 50  
Gandhidham  
Kutch  
Gujarat 370 201  
India  
T: + 91 2836 238055  
F: + 91 2836 239055  
E: bdc@kandlaport.com  
W: www.kandlaport.com

**Gujarat**

**Dahej Port Authority**  
Gujarat Maritime Board  
Sector 10-A, Opp. Air Force Station  
Gandhinagar  
Gujarat  
382 010  
India  
T: + 91 079 2323 8346

F: + 91 079 2323 4703  
E: gmbad1@sancharnet.in  
W: www.gmbports.org

**Haldia**

**TM International Logistics Ltd.**  
Finger Jetty Road  
Chiranjibpur  
Haldia  
East Midnapore(WB)  
721604  
India  
Contact: Mr K.L Bhowmick  
Chief of Port Operations  
T: + 91 3224 252150  
E: kb\_hal@tmilltd.com

**Hyderabad**

**Gangavaram Port Limited**  
Hansa Crest, 1st Floor  
Plot No.62, Road No.1  
Jubilee Hills  
Hyderabad  
Andhra Pradesh  
500 033  
India  
Contact: Mr Sanjay Gupta  
Director - Commercial  
T: + 91 40 4434 9999  
F: + 91 40 4434 9990  
E: sgupta@gangavaram.com  
W: www.gangavaram.com

**Karnataka State**

**Karwar Port Authority**  
c/o Tata Marine Agencies  
The Director of Ports & IWT  
Uttar Kannada District  
Karnataka State  
Karwar  
581302  
India  
Port Officer  
T: + 91 8382-21494  
F: + 91 8382 21488  
E: directorate@sancharnet.in

**Karnataka State**

**New Mangalore Port Trust**  
Panambur  
Karnataka State  
Mangalore  
575 010  
India  
Contact: Mr Shri P. Tamilvanan  
Chairman  
T: + 91 824 240 7300  
F: + 91 824 2408390  
E: nmptchairman@sify.com  
W: www.newmangalore-port.com

**Kolkata**

**T M International Logistics Limited**  
subsidiary of TATA Steel  
TATA Centre 14th Floor  
43 Jawaharlar Nehru Road  
Kolkata  
70071  
India  
Contact: Mr M S Sulochana Ghosh  
R/C  
T: + 91 33 2300 9003  
F: + 91 33 2288 3011  
E: gsulochana@tatasteel.com

**Kolkata**

**Riverine Group**  
5 A , N . C. DUTTA SARANI  
3rd Floor  
Kolkata  
West Bengal  
700001  
India  
Contact: Mr Shrey Tayal  
Director  
T: + 91 33 4005 4949  
F: + 91 33 4005 4909  
E: shreytaylor@riverinegroup.co.in  
W: www.riverine-group.com



**Minapore**

**Haldia Port Authority**  
Calcutta Port Trust  
Haldia Dock Complex  
Jawahar Tower Annexe  
Minapore  
721 607  
India  
Contact: Mr Rajeev Dube  
General Manager-Operations  
T: + 91 3224 263 209  
F: + 91 3224 6310 0151  
E: haldia.dock@nic.in  
W: www.kolkataporttrust.gov.in

**Mumbai**

**Skil Infrastructure Ltd**  
Skil House  
209 Bank Street  
Cross Lane, Fort  
Mumbai  
400023  
India  
Contact: Mr Nikhil Gandhi  
Group Chairman  
T: + 91 22 66199163  
F: + 91 22 22696023  
E: excellent.india@gmail.com  
W: www.pipavav.com

**Mumbai**

**J.M. Baxi & Co**  
Sapt Building  
2nd Floor  
18 J.N. Heredia Marg  
Ballard Estate  
Mumbai  
400 001  
India  
Contact: Mr John C. Alexander  
Senior VP Business Development  
T: + 91 22 2270 3779 / 82  
F: + 91 22 2210 3629  
E: jca@jmbaxi.com  
W: www.jmbaxi.com

**Mumbai**

**Seacrest Marine Services Pvt. Ltd.**  
201, Remi Biz Court A Wing  
Plot - 9, Shah Industrial Estate,  
Veera Desai Road,  
Andheri (w)  
Mumbai  
400053  
India  
Contact: Captain Sanjay Kumar  
T: + 91-22-56939660  
F: + 91-22-56939665  
E: operations@crestsea.com  
W: www.crestsea.net

**Mumbai**

**Bombay Port Trust**  
Shoorji Vallabhdas Marg  
Ballard Estate  
Mumbai  
400038  
India  
Contact: Shri V. R. Joglekar  
Chief Public Relations Officer  
T: + 91 22 261 4321  
F: + 91 22 261 1011  
E: pro@mbptmail.com  
W: http://mumbaiport.gov.in/  
Equipment & Capacity: LOA 110,  
beam: 32, dwt: 12,500 tonnes. Two  
heavy-duty cranes, discharging boom,  
hoppers, conveyor system on board,  
discharging rate 18,000 tonnes per  
day.

**Mundra**

**Adani Ports and Special  
Economic Zone Limited**  
Navinal Island  
Mundra  
370421  
India  
Contact: Mr Sadhu Ravindra  
Engineering Services

T: +91-9687639233  
E: ravindra.sadhu@mundraport.com

**Nagapattinam**

**Nagapattinam Port Authority**  
Port Office  
PO Box No 6  
Nagapattinam  
Tamil Nadu State  
611 001  
India  
Contact: Captain M Anbarasan  
Port Captain  
T: + 91 4356 242255  
F: + 91 4365 242363

**Nungambakkam**

**International Seaports (India) Pvt  
Ltd**  
East India Chambers, 3rd Floor  
3 Village Road  
Nungambakkam  
Chennai  
600 034  
India  
Vice President  
T: + 91 44 2 8238804  
F: + 91 44 2 8238809  
E: info@ispl.co.in

**Orissa**

**Paradip Port Trust**  
PO Paradip Port  
District Jagatsinghpur  
Orissa  
754 142  
India  
Contact: Mr G.J. Rao  
Chairman  
T: +91 6722222 046 /127  
F: + 91 6722 22256  
E: chmppt@paradippport.gov.in  
W: http://www.paradippport.gov.in/

**Porbander**

**Porbandar Port Authority**  
Bandar Road  
Porbander  
Gujarat State  
360 575  
India  
Port Director  
T: + 91 286 20147  
F: + 91 286 44013  
E: gmbad1@sancharnet.in  
W: www.gmbports.org

**Port Okha**

**Port Okha Port Authority**  
Port Officer  
Gujarat Maritime Board  
Port Okha  
Gujarat State  
India  
Contact: Captain G.G Panday  
Port Officer  
T: + 91 2892 262 001  
F: + 91 2892 262 002  
E: gmbad1@sancharnet.in  
W: www.gmbports.org

**Tuticorin**

**Tuticorin Port Trust**  
Tuticorin  
Tamil Nadu  
628 004  
India  
Contact: Mr N K Raghupathy IAS  
Chairman  
T: + 91 461 235 2290  
F: + 91 461 235 2031  
E: info@tuticorinport.gov.in  
W: tuticorinport.gov.in/  
Location: Located in the Gulf of  
Mannar. Latitude: 8° 45' North.  
Longitude: 78° 13' East on the east  
coast of India  
Equipment & Capacity: VOC I & II;  
800,000tpa, AB I & II; 890,000tpa,  
VIII BERTH; 1,280,000tpa

Bulk Berths: VOC I & II; 9.3m draught  
each, 25,000dwt and 40,000dwt, AB I  
& II; 8.6m & 9.3m draught, 40,000dwt,  
VIII BERTH; 10.8m draught,  
65,000dwt  
Total uncovered Storage: 60,000sqm  
+ 5 hectares  
Total covered Storage: 10,800sqm

**Visakhapatnam**

**Visakhapatnam Port Trust**  
Visakhapatnam  
530 035  
Andhra Pradesh  
India  
Contact: Mr Ajeya Kallam  
Chairman  
T: + 91 891 2876 001  
F: + 91 891 2565023  
E: info@vizagport.com  
W: www.vizagport.com

**Visakhapatnam**

**Port of Visakhapatnam**  
Visakhapatnam  
Andhra Pradesh  
530-035  
India  
Contact: Mr Ajeya Kallam  
Chairman  
T: + 91 891 256 2758  
F: + 91 891 256 5023  
E: info@vizagport.com  
W: www.vizagport.com

**INDONESIA**

**Bandar Lampung**

**PT. Bukit Asam (Persero) Tbk**  
Jl. Soekarno Hatta Km. 15  
Tarahan  
Bandar Lampung  
DKI Jakarta  
Indonesia  
Contact: Mr Edy Purwanto  
Senior Manager Marketing  
T: + 62 21 525 4014  
F: + 62 21 525 3992  
E: epurwanto@bukitamasam.co.id  
W: www.ptba.co.id

**Banjarmasin**

**Port of Banjarmasin**  
PT (Persero) Pelabuhan Indonesia  
III Banjarmasin  
Jl Barito Hilir No 6  
Banjarmasin  
70117  
Indonesia  
Contact: Mr Anton Tri Agung  
Shipping Superintendent  
T: + 62 51 153 670  
F: + 62 51 152 552  
E: inaport3@pp3.co.id  
W: www.pp3.co.id

**Bitung**

**Port of Bitung**  
Bitung Port Administration  
Indonesian Port Corp IV  
Jl DS Sumulang No 1  
Bitung  
95522  
Indonesia  
Contact: Mr Soedaryono  
Manager  
T: + 62 43 821196  
F: + 62 43 821380

**Cilacap**

**Cilacap**  
Port Administrator  
Jalan Niaga  
Cilacap  
Indonesia  
Port Director  
F: + 62 282 34217

**Cilegon**

**PT Krakatau Bandar Samudera**  
JL. May. Jend S. Parman  
Km. 13  
Cigading  
Ciwandan  
Cilegon  
Banten  
42447  
Indonesia  
Contact: Mr Zamhari Hamid  
Commercial Director  
T: + 62 254 311182 / 0  
F: + 62 254 311178  
E: azhar@cigadingport.com  
W: www.cigadingport.com

**Irian Jaya**

**Amamapare**  
Freeport Indonesia Inc  
Irian Jaya  
Indonesia  
Contact: Mr S Rizal  
T: + 62 967 34018

**Jakarta**

**P T Indominco Mandiri**  
Ventura Building  
8th Floor  
J1 RA Kartini No 26 Cilandak  
Jakarta  
12430  
Indonesia  
Contact: Mr Suriya  
President Director  
T: + 62 021 750 8376  
F: + 62 021 750 8380  
E: dharmaSubur@cbn.net.id

**Jakarta**

**North Pulau Laut Coal Terminal**  
PT Arutmin Indonesia  
Mid Plaza 2, 9th Floor  
Jalan Jenderal Sudirman Kav. 10-  
11  
Jakarta  
10220  
Indonesia  
T: + 62 21 5720012  
F: + 62 21 5741689  
E: marketing@arutmin.com  
W: www.arutmin.com

**Jakarta**

**PT Indonesia Bulk Terminal**



Jl. HR Rasuna Said  
Blok X-5, Kav. 1-2  
Menara Karya, 23rd Floor  
Jakarta  
12950  
Indonesia  
Contact: Mr Bram Surjadi  
Marketing  
T: + 62 21 5211 265 / + 62 21  
25533000 ext 3244  
F: + 62 21 522 4341  
E: marketing@ibt.co.id  
W: www.ptibt.com  
Location: South Kalimantan,  
Indonesia  
Equipment & Capacity: 2 discharging  
wharfs - 1500tph rate, 2 shiploaders -  
3000 tph rate.  
12 m tonnes annual throughput  
capacity  
Bulk Berths: Max vessel size  
80,000dwt, max LOA 230m, max  
beam 36m, max draught 14.5m, 1  
berth, 288m wharf length  
Total uncovered Storage: 8 stockpiles,  
total capacity 800,000 tonnes  
Please see our website  
www.ptibt.com

**Jakarta**

**Tanjung Priok**  
PT (Persero) Pelabuhan Indonesia  
II  
Jalan Raya Pelabuhan No 9  
Tanjung Priok  
Jakarta  
14310  
Indonesia  
Contact: Mrs Lani  
Port Manager  
T: + 62 21 430 1080  
F: + 62 21 437 2933  
E: priok@inaport2.co.id  
W: www.priokport.co.id

**Jakarta**

**Pulau Laut**  
World Trade Centre 7 Floor  
JL Send  
Surdiman Kav 31  
Jakarta  
12920  
Indonesia  
Contact: Mr B T Kuan  
General Manager  
T: + 62 21 522 9250  
F: + 62 21 522 4341

**Jakarta**

**PT. Terminal Batubara Indah**  
World Trade Centre, 07th floor  
Jl. Jend Sudirman Kav. 29-31  
Jakarta  
12920  
Indonesia  
Contact: Mrs Lilly  
T: + 62 21 5712579  
F: + 62 21 571 2597  
W: www.pttbi.co.id

**Jakarta**

**Gebe Island**  
c/o PT Pelayaran Bahtera Adhiguna  
10-12 Jl Kalibesar Timur  
PO Box 1315  
Jakarta  
Indonesia  
Port Director  
T: + 62 21 691 2547  
F: + 62 21 690 1450

**Jakarta**

**Balikpapan Coal Export Terminal**  
PT Dermaga Perkasapratama  
The Landmark Centre Tower B  
29th Floor  
Jl Jend Sudirman No1  
Jakarta  
14310  
Indonesia  
Contact: Mr Edward Djumaili  
T: + 62 21 570 155  
F: + 62 21 570 145

**Jakarta**

**PT. Pulau Laut**  
Jl. Raya Pelabuhan No.41  
Tanjung Priok  
Jakarta  
14310  
Indonesia  
Contact: Mr Djoko (Tommy)  
Oetomo  
President Director  
T: + 62 21 494 769  
F: + 62 21 430 0922

**Kijang**

**Port of Kijang**  
c/o PT Aneka Tambang  
Unit-pertambangan Bauksit  
Kijang  
Tanjung Pinang  
Indonesia  
Port Director  
T: + 62 622 21177  
F: + 62 622 61561

## PT Indonesia Bulk Terminal – natural transport hub for Indonesia’s coal trade

PT Indonesia Bulk Terminal (IBT) is the developer and operator of the Pulau Laut Coal Terminal which is a common user terminal situated on the southern tip of the island of Pulau Laut in Indonesia’s South Kalimantan Province.

Demand for coal as a major global energy resource is continuing to grow rapidly and the Pulau Laut Coal Terminal offers a secure, reliable and cost effective means of stockpiling, blending and loading Indonesian coal to meet this demand.

IBT handled 11.99mt (million tonnes) in 2007 compared with 9.69mt in 2006. The increase in throughput is due to continuous efficiency improvements in adopting best practices.

Pulau Laut is located adjacent to the Java Sea and the Makassar Strait and lies on major domestic and international shipping routes. This strategic location and the sheltered deep water anchorage of the IBT terminal in the south of the island represent a natural transport hub for Indonesia’s significant coal trade.

### TERMINAL OPERATIONS

IBT offers shippers the peace of mind operation of consolidating cargo on the stockpile. Furthermore, with an independent



on-site laboratory, IBT allows shippers quick insight on the cargo quality. Shippers can also opt to blend cargo of various qualities, as IBT is equipped for blending multiple cargo quality to the desired quality within good accuracy.

IBT currently has eight stockpile pads capable of storing eight Panamax-size cargoes.

Dry cargo (coal), is discharged from barges using 4 x 750tph (tonnes per hour) luffing /slewing grab cranes into hoppers. From hoppers, coal is fed onto conveyors and is carried to the stockpile or direct loading onto vessels. A fleet of 5 x Caterpillar D10 bulldozers is used for stockpile management and coal reclaiming for shiploading. Shiploading is carried out utilizing two fixed luffing slewing ship loaders with a capacity of 3,000tph.

Blending option adds value to the cargo as shippers can mix and match the available sources to derive at their desired quality. The onsite automatic sampling facility offers a systematic sampling process according to the desired ISO or ASTM standards that shippers may select and coupling with the onsite



laboratory, certificates are issued promptly.

Utilization of the terminal is maintained at 75% and is measured by the ship-loading berth occupancy rate. This is kept at 75% in order to minimize vessel queuing time for shippers shipping through the terminal.

IBT is continuously looking at improvement initiatives to raise the throughput of the terminal. Current evaluation includes future stockpile expansion and a higher cargo handling rate.

### INFRASTRUCTURE

The company currently employs in excess of 200 personnel of which 75–80% are recruited and trained from the local area. Onsite housing is available for customers use to supervise loading operations and for Indonesia Bulk Terminal personnel. Catering, cleaning and medical services are provided to personnel through onsite facilities. A medical clinic is also located onsite which is staffed by qualified medical personnel.

Potable and industrial water for the terminal operations comes from a dam located within the site with this water being chemically treated and filtered before use. The industrial water used in stockpile management is recirculated from settling ponds after re-filtration.

Power is provided through an onsite diesel generating station with a capacity of 7MW which includes back-up systems to ensure continuous power supply. Onsite storage tanks provide fuel for the power station, terminal mobile equipment, maintenance equipment and the berthing tugs.

The terminal operates a 1,250-metre certified airstrip located 10km from the site with a regular service now being operated between Banjarmasin and the terminal with 18-seat commuter aircraft.

The government maintains a harbour master’s office at the terminal which provides port health, customs and immigration services. These services can be arranged through a number of shipping agents with international links that have permanent offices on site.





## Port of Indonesia Bulk Terminal specifications

### LOCATION

Country: Indonesia  
State: South Kalimantan

### CAPACITY

Operations Commencement: 1998  
Annual Throughput Capacity: 12 million tonnes

### BARGE DISCHARGING

Discharging Wharfs: 2  
Discharging Rate (nominal): 1,500tph  
Discharging Method: Gear & Grabs

### STOCKPILING

Number of Stockpiles: 8  
Total Stockpile Capacity: 800,000 tonnes  
Stockpiling Method: Overhead conveyor/tripper  
Stockyard Equipment: 4 bulldozers

### SHIPLOADING

Coal Reclaim Method: Bulldozer into underground stockpile dischargers  
Blending: Possible  
Number of Shiploaders: 2  
Shiploading Rate (nominal): 3,000tph

### SHIPPING

Maximum Vessel Size: 80,000dwt  
Maximum LOA: 230m  
Maximum Beam: 36m  
Sailing Draft: 14.5m  
Number of Berths: 1  
Wharf Length: 288m

### SERVICES

Quality Assurance: ISPS-certified  
Sampling: During barge discharging & shiploading, on-site independent superintending company  
Environmental: Dust suppression/monitoring of coal with water spray management.



**PT Indonesia Bulk Terminal**

Pulau Laut Coal Terminal  
Desa Mekar Putih  
Kec. Pulau Laut Barat  
Kab. Kotabaru  
Kotak Pos 118 Kalsel  
Tel: (62 518) 388 00  
Fax: (62 518) 388 22

Marketing  
Tel: (62 21) 522 9250  
Email: marketing@ibt.co.id  
Web: www.ptIBT.com/



Pulau Laut Coal Terminal, your secure, reliable and cost effective means of stockpiling, blending and loading Indonesian coal to meet your demand.

**Kotabaru**

**PT Indonesia Bulk Terminal**  
 Pulau Laut Coal Terminal  
 PO Box. 118 Kalsel  
 Kotabaru  
 Kalimantan Selatan  
 72111  
 Indonesia  
 Contact: Mr Wan Yazid  
 Terminal Manager  
 T: + 62 5183 8800  
 F: + 62 5183 8822  
 W: www.ptibt.com  
 Location: Pulau Laut on the  
 Kalimantan Selatan  
 Equipment & Capacity: Unloading  
 Barges and Loading Vessels,  
 3,000tph  
 10,000,000tpa of coal handled.  
 Total uncovered Storage: 120 hectare  
 Total covered Storage: 60 hectare

**Lampung**

**Pelabuhan Panjang**  
 Dit Jen Perhubungan Laut  
 Pelabuhan Panjang  
 Lampung  
 Indonesia  
 Contact: Mr Prayitno  
 Port Manager  
 T: + 62 721 31098  
 F: + 62 721 33237

**Lhokseumawe**

**Port of Lhokseumawe**  
 Ji Pelabuhan Lama 3  
 Lhokseumawe  
 Aceh  
 Indonesia  
 Contact: Mr M Sandi  
 Port Manager  
 T: + 62 645 43485  
 F: + 62 645 43485

**Padang**

**Port of Teluk Bayur**  
 Jl Semarang No 3  
 Teluk Bayur  
 Padang  
 25217  
 Indonesia  
 Contact: Mr Sarwediona  
 Port Manager  
 T: + 62 751 61646  
 F: + 62 781 61169  
 E: corp\_sec@inaport2.co.id  
 W: www.telukbayurport.com

**Padang**

**Teluk Bayur Coal Terminal**  
 PT Tambang Batubara Bukit Asam  
 (PTBA)  
 Jl Tanjung Priok  
 No 01 Teluk Bayur  
 Padang  
 West Sumatra  
 Indonesia  
 Contact: Mr Muztav Sjab  
 Taluk Bayur Coal Terminal Manager  
 T: + 62 734 4510 96  
 F: + 62 21 525 4002  
 E: corsec@bukitasam.co.id  
 W: www.ptba.co.id

**Palembang**

**Port Authority Palembang**  
 Jl. Blihyu nomor 1  
 Boom Baru  
 Palembang  
 South Sumatera  
 30115  
 Indonesia  
 Contact: Mr Housan  
 T: + 62 711 710611 / +62 8159946494  
 F: + 62 711 711758  
 E: tmpip@palembangport.com  
 W: www.palembangport.com  
 Location: Latitude 02° - 58' - 48" S.  
 Longitude 104° - 46' - 36" E.  
 Bulk Berths: Max LOA 151m.  
 Max Length: 475m

Total uncovered Storage: Boom Baru:  
 8,173 sqm  
 Sungai Lais: 16,700 sqm  
 Total covered Storage: Boom Baru -  
 Warehouse: 9,785 sqm  
 Sungai Lais - Shed: 230 sqm

**Palembang**

**Kertapati Coal Terminal**  
 PT Tambang Batubara Bukit Asam  
 (PTBA)  
 Jl Stasiun Kerata Api  
 Palembang  
 South Sumatra  
 Indonesia  
 Contact: Mr Dadan Ruswandana  
 Coal Terminal Manager  
 T: + 62 711 512 617  
 F: + 62 711 511 388  
 W: www.bukitasam.co.id

**Sabang**

**Port of Sabang**  
 Sabang Port Administration Office  
 Dit Jen Perhubungan Laut  
 Cabang Sabang  
 Sabang  
 Aceh  
 Indonesia  
 Operations Manager  
 T: + 62 652 21207  
 E: humas@tps.co.id  
 W: www.tps.co.id

**Surabaya**

**Surabaya Port Authority**  
 Jalan Tanjung Perak  
 Timur 610  
 Surabaya  
 Indonesia  
 Contact: Mr Mrfugand Briyanpo  
 Manager  
 T: + 62 31 3291364  
 F: + 62 31 313835  
 E: humas@tps.co.id  
 W: www.tps.co.id/

**Tanjung Priok**

**Bogasari Flour Mills Terminal**  
 Tanjung Priok  
 Indonesia  
 Contact: Mr Joko  
 T: + 62 31 329 3082  
 F: + 62 31 329 1843  
 E: lagansa@bogasariflour.com  
 W: www.bogasariflour.com

**IRAN**

**Tehran**

**Khorramshar Port Authority**  
 Ports and Shipping Organisation  
 751 Enghelab Avenue  
 Tehran  
 15994  
 Iran  
 Contact: Mr Mohammad Hossein  
 Alaei  
 Public Relations Manager  
 T: + 98 21 880 9280  
 F: + 98 21 880 9324  
 E: m\_alaei@khmail.ir  
 W: www.khport.ir

**Tehran**

**Chah Bandar Port Authority**  
 Ports and Shipping Organisation  
 751 Enghelab Avenue  
 Tehran  
 15994  
 Iran  
 Contact: Mr M R Ghaderi  
 Director General-Maritime Affairs  
 T: + 98 21 880 9280  
 F: + 98 21 880 9324

**Tehran**

**Bandar Abbas Port Authority**  
 Ports and Shipping Organisation  
 751 Enghelab Avenue  
 Tehran  
 15994  
 Iran  
 Contact: Mr Sarwediona  
 Port Manager  
 T: + 62 751 33533  
 F: + 62 751 33569

**IRELAND**

**Arklow**

**Arklow Port Authority**  
 Harbour Office  
 South Quay  
 Arklow  
 Ireland  
 Contact: Mr Tommy Myler  
 Harbour Master  
 T: + 353 402 32466  
 F: + 353 402 31068  
 E: gavin@arklowportharbour.com

**Cork**

**Ringaskiddy Deepwater Terminal**  
 Port of Cork Company  
 Custom House Street  
 Cork  
 Ireland  
 Contact: Mr Sean Geary  
 T: + 353 21 4273125  
 F: + 353 21 4276484  
 E: info@portofcork.ie  
 W: www.portofcork.ie

**Cork**

**Port of Cork Company**  
 Custom House Street  
 Cork  
 Munster  
 Ireland  
 Contact: Ms Sara Dymond  
 Marketing Executive  
 T: + 353 21 427 3125  
 F: + 353 21 427 6484  
 E: sdymond@portofcork.ie  
 W: www.portofcork.ie  
 Location: South Coast of Ireland  
 Equipment & Capacity: 2 high output  
 dockside cranes (rated capacity 400  
 tonnes per hour) and one mobile  
 (rated capacity 600 tonnes per hour)  
 Bulk Berths: Ringaskiddy Deepwater  
 Berth: Length 485m Depth 13.4m CD  
 South Jetties: Length 411m Depth  
 8.8m CD

**Dublin**

**Dublin Port & Docks Board**  
 Port Centre  
 Alexandra Road  
 Dublin  
 Ireland  
 T: + 353 1887 60 00  
 F: + 353 1874 12 41  
 W: www.dublinport.ie

**Dundalk**

**Dundalk Harbour Commissioners**  
 Harbour Office  
 40 Quay Street  
 Dundalk  
 Co Louth  
 Ireland  
 Contact: Captain Frank Allen  
 Harbour Master  
 T: + 353 42 9334096  
 F: + 353 42 35481  
 E: dundalkport@eircom.net

**Foynes**

**Shannon Foynes Port Company**  
 Harbour Offices  
 Main Street  
 Foynes

County Limerick  
 Ireland  
 Contact: Mr Martin Morrissey  
 Commercial Manager  
 T: + 353 69 73100  
 F: + 353 69 65 142  
 E: mmorrissey@sfpcc.ie  
 W: www.sfpcc.ie

**Galway**

**Galway Harbour Company**  
 Harbour Office  
 New Docks  
 Galway  
 Ireland  
 Contact: Captain Brian Sheridan  
 Harbour Master  
 T: + 353 91 561874  
 F: + 353 91 563738  
 E: info@galwayharbour.com  
 W: www.galwayharbour.com

**Greenore**

**Greenore Port Limited**  
 Greenore  
 Co Louth  
 Ireland  
 Contact: Mr Roisin de Pasquale  
 Managing Director  
 T: + 353 42 937 3170  
 F: + 353 42 735 67  
 E: info@greenore.net

**Kilrush**

**Kilrush Port Authority**  
 Kilrush Urban District Council  
 Town Hall  
 Kilrush  
 Co Clare  
 Ireland  
 Contact: Mr John Corrie  
 Town Clerk  
 T: + 353 65 905 1047  
 F: + 353 65 905 2821  
 E: kilrush@clarecoco.ie

**Kinsale**

**Kinsale Harbour Commissioners**  
 Harbour Office  
 Pier Road  
 Kinsale  
 Co Cork  
 Ireland  
 Contact: Capt. Phil Devitt  
 Harbour Master/Secretary  
 T: + 353 21 477 2503  
 F: + 353 21 477 4695  
 E: kharbour@iol.ie  
 W: www.kinsaleharbour.com  
 Location: South Coast of Ireland  
 Equipment & Capacity: 1 Crane &  
 Bob Cat  
 Bulk Berths: 68m long (Can handle  
 vessels of 95m long ...up to 4,000  
 D/W)  
 Total uncovered Storage: N/A  
 Total covered Storage: N/A  
 Henry Good Ltd, Agents, Hauliers and  
 storage facilities (covered of approx.  
 5,000mt)

**Kinsale**

**Henry Good Limited**  
 Waterlands  
 Kinsale  
 Co Cork  
 Ireland  
 Contact: Mr Roger Dale  
 Director  
 T: + 353 21 4772300  
 F: + 353 21 4772548

**New Ross**

**New Ross Port Company**  
 Harbour Office  
 The Quay  
 New Ross  
 Co Wexford  
 Ireland  
 Contact: Captain L J Foley  
 Harbour Master/CEO

T: + 353 5142 1303  
 F: + 353 5142 1294  
 E: ceo@newrossport.iol.ie  
 Location: South coast Ireland.

**Tralee**

**Fenit Port Authority**  
 Tralee and Fenit Harbour  
 Commissioners  
 Harbour Offices  
 Fenit  
 Tralee  
 Co Kerry  
 Ireland  
 Contact: Mr D Buttimer  
 Port Manager  
 T: + 353 66 36231  
 F: + 353 66 36231  
 E: fenitmarina@eircom.net

**Turvey**

**Moneypoint**  
 Electricity Supply Board  
 Moneypoint Generating Station  
 Unit 19, Turvey Business Centre  
 Turvey  
 County Dublin  
 Ireland  
 Contact: Mr Paul Dunne  
 T: + 353 1 8900466  
 F: + 353 1 8900575  
 E: info@moneypoint.ie

**Waterford**

**Port of Waterford Company**  
 3rd Floor  
 Marine Point  
 Belview Port  
 Slieverue  
 Waterford  
 Munster  
 Ireland  
 Contact: Mr Stan McIlvenny  
 T: + 353 51 874907  
 F: + 353 51 874908  
 E: jsm@portofwaterford.com  
 W: www.portofwaterford.com  
 Location: South East of Ireland  
 Equipment & Capacity: 1 Liebherr RH  
 1080 Portal crane, with a 12 cubic  
 metre grab, and a 400 T/hr pneumatic  
 ship discharge unit  
 1Liebherr 250 portal crane, with a 65  
 tonne lift capacity, 20 cubic metre  
 grab, and a new 11 cubic metre cactus  
 grab  
 Bulk Berths: 513m of bulk quay  
 Total uncovered Storage: Substantial  
 Total covered Storage: Substantial

**Wicklow**

**Wicklow Port Co**  
 Harbour Office  
 North Quay  
 Wicklow  
 Ireland  
 Contact: Capt. J.M. Barlow  
 Harbour Master/CEO  
 T: + 353 404 67455  
 F: + 353 404 67455  
 E: wicklowport@eircom.net  
 Location: South East Ireland (Irish  
 Sea)  
 Equipment & Capacity: All mobile  
 cranes depending on cargo. 150  
 tonne (plus) per hour on timber.  
 Bulk Berths: 110 metres length,  
 draught 5.5m. Total of 3 berths.  
 Total uncovered Storage: To be  
 advised on request  
 Total covered Storage: To be advised  
 on request  
 All other cargoes can be  
 accommodated by direct delivery. (Off  
 hook)



**ISRAEL**

**Ashdod**

**Ashdod Port Co. Ltd**  
Ports and Railways Authority  
PO Box 9001  
Ashdod  
77191  
Israel  
Contact: Capt Yaakov Tzemach  
Harbour Master  
T: + 972 8 851 7279  
F: + 972 8 851 7296  
E: yaakovt@ashdodport.co.il  
W: www.ashdod.org.il

**Ashkelon**

**The National Coal Supply Corporation (N.C.S.C)**  
Ashkelon Coal Terminal  
Ashkelon  
Israel  
T: + 972 3625 7000  
F: + 972 3625 7001  
E: ncsc@ncsc.co.il  
W: www.ncsc.co.il

**Eilat**

**Eilat Port Ltd - Israel**  
PO Box 37  
Eilat  
88100  
Israel  
Contact: Captain Guy Gilron  
Harbour Master  
T: + 972 7 6358341  
F: + 972 7 6358300  
E: gilrong@eilatport.co.il  
W: www.israports.org.il  
Location: South Israel  
Equipment & Capacity: Shipping & Ports  
Total uncovered Storage: 200,000sqm  
Total covered Storage: 30,000sqm  
Eilat port is the south entrance to Israel.

**Hadera**

**The National Coal Supply Corporation Ltd (NCSC)**  
Hadera Coal Terminal  
Hadera  
Israel  
T: + 972 3625 7000  
F: + 972 3625 7001  
E: ncsc@ncsc.co.il  
W: www.ncsc.co.il

**Hadera**

**Port of Hadera**  
PO Box 314  
Hadera  
38102  
Israel  
Contact: Mr Yoram Nachshol  
Managing Director  
T: + 972 4 622 5577  
F: + 972 4 634 3034

**Haifa**

**Haifa Port Company Ltd**  
Haifa Port and Railways Authority  
PO Box 33539  
Haifa  
31334  
Israel  
Contact: Mr Mendy Zaltzman  
Port Manager & Managing Director  
T: + 972 4 851 8111  
F: + 972 4 867 4853  
E: mendy.zaltzman@haifaport.co.il  
W: www.haifaport.com

**Haifa**

**Haifa Grain Terminal**  
Israel Ports and Railways Authority  
PO Box 33539  
Haifa  
31334  
Israel

Contact: Mr Mendy Zaltzman  
Port Manager  
T: + 97 24 851 8111  
F: + 97 24 867 4853

**Tel Aviv**

**Israel Ports Company**  
74 Derech Menachem Begin  
Tel Aviv  
67215  
Israel  
Contact: Mr Dov Frohlinger  
COO  
T: + 972 3565 7060  
F: + 972 3562 2281  
E: dovf@israports.co.il  
W: www.israports.co.il  
Government owned company responsible for the management and development of Israel's seaport infrastructure.

**Tel Aviv**

**Ports and Railways Authority of Israel**  
74 Menachem Rd  
Tel Aviv  
67215  
Israel  
Contact: Mr Gul Caplan  
I/C Materials Handlings Equipment  
T: + 972 3 565 7913  
E: info@israports.co.il  
W: www.israports.org.il

**Tel Aviv**

**Ports & Railways Authority**  
Menachem Begin Road 74  
Tel Aviv  
61201  
Israel  
Contact: Ms Gittith Shlapobersky  
Librarian  
T: + 972 3 5657087  
F: + 972 3 5619338  
E: info@israports.org.il

**ITALY**

**Ancona**

**Ancona Port Authority**  
Banchina Nazario Sauro 12  
Ancona  
60100  
Italy  
Contact: Mr Plavigi  
Port Director  
T: + 39 071 207891  
F: + 39 071 2078940  
E: info@autoritaportuale.ancona.it  
W: www.autoritaportuale.ancona.it

**Ancona**

**Ancona Coal Terminal**  
Ancona  
Italy  
Contact: Mr Paolo Galli  
T: + 39 071 2071664  
F: + 39 071 2077736  
E: operativo@anconamerici.it

**Barlette**

**Barletta Port Authority**  
Port Captain  
1 Campanone  
Via Columbo 30  
Barletta  
70051  
Italy  
Contact: Commendant Carbonara  
Port Director  
T: + 39 088 353 1020  
F: + 39 088 353 3400  
E: barletta@guardiacostiera.it

**Cagliari**

**Port of Cagliari**  
Port Captain  
Cagliari

09100  
Italy  
Contact: Mr N Silenti  
Operations Director  
T: + 39 070 679 531  
F: + 39 070 679 533 45  
E: autorita.portuale@tiscali.it  
W: www.porto.cagliari.it

**Chioggia**

**Chioggia Port Authority**  
Port Captain  
Piazza Santa Croce 1290  
Chioggia  
30015  
Italy  
Contact: Mr R Barnabei  
Port Commander  
T: + 39 041 520 5600  
F: + 39 041 550 6812  
E: info@chioggia.evanet.it

**Civitavecchia**

**Civitavecchia Port Authority**  
Consorzio Autonomo Pier Di  
Civitavecchia  
Porto di Civitavecchia  
Civitavecchia  
00053  
Italy  
Contact: Mr Marinucci  
Port Director  
T: + 39 076 636 6201  
F: + 39 766 501717  
E: marinucci@portodocivitavecchia.it  
W: www.portodiroma.it

**Crotone**

**Crotone Port Authority**  
Liga Navale Italiana  
Port Captain  
Crotone  
Italy  
Contact: Captain Valentini  
Port Captain  
T: + 39 0962 20721  
F: + 39 0962 290 2094  
E: info@portodigiatauro.it  
W: www.portodigiatauro.it

**Gaeta & Civitavecchia**

**Intergroup S.r.l.**  
Lungomare Caboto 110  
Gaeta & Civitavecchia  
Rome area  
04024  
Italy  
Contact: Mr Giovanni Migliaccio  
General Manager  
T: + 39 771 310 077  
F: + 39 771 472 114  
E: info@intergroup.it  
W: www.intergroup.it  
Location: Central Italy, port of Romes.  
Equipment & Capacity: Gottwald cranes, Terberg tag master, Scania trucks, Caterpillere, linde forklifts, concetti packaging equipment.  
Bulk Berths: 12m  
Services: National and International transport, warehousing, packaging, special cargo handling.

**Gela**

**Gela Port Authority**  
Gela Ufficio Circondariale Marittimo  
Street Mare no 156  
Gela  
93012  
Italy  
Contact: Mr Com Adrogano  
Harbour Master  
T: + 39 0933 917755  
F: + 39 0933 913700  
E: gela@guardiacostiera.it

**Genova**

**Terminal Rinfuse Genova SpA**  
Palazzina Uffici  
Calata Rubattino  
Genova

16126  
Italy  
Commercial Director  
T: + 39 010 248 8620  
E: alessandro.vianello@euroports.it  
W: www.porto.genova.it

**Genova**

**Port of Genova**  
Palazzo San Giorgio  
Via Della Mercanzia 2  
Genova  
16123  
Italy  
Contact: Snr Pietro Oddone  
Marketing Disector  
T: + 39 010 241 2793  
F: + 39 010 241 2309  
E: p.oddone@porto.genova.it  
W: www.porto.genova.it

**La Spezia**

**La Spezia Port Authority**  
Viale Italia 4  
La Spezia  
Italy  
Contact: Mr Sergio Somaglia  
Marketing Manager  
T: + 39 0187 546328  
F: + 39 0187 599664  
E: sergio.somaglia@porto.laspezia.it  
W: www.portolaspezia.it

**Livorno**

**Livorno Port Authority**  
Scali Rosciano 6  
Livorno  
57123  
Italy  
Contact: Mr Roberto Lippi  
Head of Promotions Dept.  
T: + 39 058 624 9411  
F: + 39 0586 249 515  
E: marketing@porto.livorno.it  
W: www.portauthority.li.it  
Location: Central Italy on the west coast  
Equipment & Capacity: Multipurpose and container port with 31 terminals equipped.  
1,600,000sqm of harbour, useable land area of 2,500,000sqm, 11,250m of quays with 97 berths for vessel with up to 13 m draughts.  
Bulk Berths: Cereals - 340 metres quay  
Dry bulk cargo - 450 metres quay  
Forest, Pulp and Paper - 860 metres quay  
Total uncovered Storage: 1,000,000 sqm  
Total covered Storage: 70,000 sqm covered storage facilities  
A Logistic platform ( Interporto Vespucci) is 5 km away from the port and directly connected with 4 lane fast road and rail. Total uncovered storage of 822,000 sqm, total covered storage of 325,000sqm

**Manfredonia**

**Manfredonia Port Authority**  
Port Captain  
Piazza Marconi  
Manfredonia  
Italy  
Contact: Captain Antonio Vincenzo Ranieri  
Port Captain  
T: + 390 884 583 871  
F: + 39 0884 587388  
E: manfredonia@guardiacostiera.it

**Palermo**

**Palermo Port Authority**  
Via Paino dell'Ucciardone 4  
Palermo  
90139  
Italy  
Contact: Mr Riccardo Damico  
General Manager

T: + 39 091 627 7111  
F: + 39 091 637 4291  
E: promociion@autport.pa.it  
W: www.autport.pa.it

**Piazzale Cabato**

**Gaeta Port Authority**  
Port Captain  
Piazzale Cabato  
Gaeta  
04024  
Italy  
Contact: Mr Mario Magliulo  
Port Director  
T: + 39 0771 460 088  
F: + 39 771 464 724  
E: gaeta@guardiacostiera.it

**Piombino**

**TOP - Terminal Offshore**  
**Piombino**  
(subsidiary of Coeclerici Logistics SpA)  
Uff. Circondariale Marittimo  
P. Le Premuda 19  
Piombino  
Livorno  
57025  
Italy  
Contact: Captain Gianfranco Passalacqua  
T: + 39 335 730 1097  
F: + 39 02 624 69444  
E: n/a  
W: www.coeclerici.com  
Location: North West coast Italy  
Equipment & Capacity: 500,000 tpa  
Bulk Berths: Max beam 42m, Max Airdraught 15m  
Total uncovered Storage: n/a  
Total covered Storage: n/a  
Equipped by self discharging conveyor system.  
Commercial Contact: Capt Giordano Scotto Coeclerici Logistics Spa  
Piazza Diaz 7 - 20123 Milan- email: newprojects@coeclerici.com

**Piombino (LI)**

**Autorità Portuale di Piombino**  
Ente di Diritto Pubblico  
Legge 28 gennaio 1994, n. 84  
Piombino (LI)  
Toscana  
57025  
Italy  
Contact: Mr Giampiero Costagli  
T: + 39 056 522 4210  
F: + 39 056 522 1000  
E: g.costagli@ap.piombinoelba.it  
W: http://www.porto.piombino.li.it  
Equipment & Capacity: LOA 110, beam: 32, dwt: 12,500 tonnes. Two heavy-duty cranes, discharging boom, hoppers, conveyor system on board, discharging rate 18,000 tonnes per day.

**Porto Torres**

**Porto Torres Port Authority**  
Captainaria di Porto Torres  
Porto Torres  
Italy  
Contact: Mr Luigi Gargiulo  
Port Captain  
T: + 39 079 502258  
F: + 39 79 502090  
E: info@portodigiatauro.it  
W: www.portodigiatauro.it

**Ravenna**

**Ravenna Port Authority**  
Via Magazzini Anteriori, 63  
Ravenna 48100  
Italy  
Contact: Ms Mariliana Moschona  
Marketing Manager  
T: + 39 0544 608811  
F: + 39 0544 421945  
E: mariliana.moschona@port.ravenna.it

W: [www.port.ravenna.it](http://www.port.ravenna.it)  
 Location: North East of Italy 44° 23'N  
 12° 17' East  
 Equipment & Capacity: 8 cranes, 3  
 gantry cranes, 9 pneumatic suckers, 3  
 bag chutes  
 Bulk Berths: 2,846m quay length  
 Total uncovered Storage:  
 1,358,000sqm  
 Total covered Storage: 2,575,000m3  
 bulk cargo warehouses

## Sant Antioco

**Sant Antioco Port Authority**  
 Localita Ponta  
 Sant Antioco  
 Sardinia  
 I-09017  
 Italy  
 Contact: Mr Maurizio Paganini  
 Harbour Master  
 T: + 39 078 18 3071  
 F: + 39 078 18 3071  
 E: [compamareauop@interfree.it](mailto:compamareauop@interfree.it)  
 W: [www.harbours.net/augusta](http://www.harbours.net/augusta)

## Savona

**Port Authority of Savona**  
 Via Gramsci, 14  
 Savona  
 17100  
 Italy  
 T: + 39 019 85 541  
 F: + 39 019 827399  
 E: [authority@porto.sv.it](mailto:authority@porto.sv.it)  
 W: [www.porto.sv.it](http://www.porto.sv.it)  
 Location: Northern Italy-Tyrrhenian Sea  
 Bulk Berths: Max depth 19.5m:  
 Quay 16A: length 128m, depth 11m;  
 Zone 26, length 390m, depth 15.5m;  
 Public Berths: draught 15.5m;  
 Zone 30, length 300m, depth 19.5m;  
 Zone 31, length 180m, depth 15m;  
 Zone 32, length 180m, depth 15m;  
 Zone 14/15/16, length 292m, depth  
 12m;  
 S. Raffalele jetty, length 450m, depth  
 13m  
 A number of terminals handling dry  
 bulk exist at the Port

## Savona

**Authorita Potuati di Savona**  
 vai Gramsci  
 Savona  
 17100  
 Italy  
 Contact: Mr Agostino Ghiglione  
 T: + 39 01982 5541  
 F: + 39 01982 7399  
 E: [authority@porto.sv.it](mailto:authority@porto.sv.it)  
 W: [www.porto.sv.it/english/  
 The-Port/Port-s-Ope/  
 Terminals/Rinfuse-So/  
 savonasilos.htm\\_cvt.htm#](http://www.porto.sv.it/english/The-Port/Port-s-Ope/Terminals/Rinfuse-So/savonasilos.htm_cvt.htm#)

## Sicily

**Siracusa Port Authority**  
 Capitaneria di Porto  
 Siracuse  
 Sicily  
 Italy  
 T: + 39 93 166 713  
 F: + 39 93 169 260  
 E: [siracusa@guardiacostiera.it](mailto:siracusa@guardiacostiera.it)

## Torre Annunziata (NA)

**SOLACEM Spa**  
 Molo di Levante - Interno Porto  
 Torre Annunziata (NA)  
 Naples  
 80058  
 Italy  
 Contact: Dr Giuseppe Rocco  
 Managing Director  
 T: + 39 081 8621199  
 F: + 39 081 8615991  
 E: [direzione@solacem.it](mailto:direzione@solacem.it)  
 W: [www.solacem.it](http://www.solacem.it)  
 Location: South west Italy between  
 Naples and Salerno.

Equipment & Capacity: 50 of 40m  
 high cylindrical silos  
 Bulk Berths: 260m for bulk and cerilas  
 for silos and 300m for general cargo,  
 roro, breakbulk and containers.  
 Total uncovered Storage: 25,000sqm  
 Total covered Storage: 55,000 tons in  
 silos + 6,500sqm in warehouse  
 Vessel draught will increase to 11m,  
 quay length to 100m and a further  
 50,000sqm storage will be made  
 available. Security is being upgraded,  
 new equipment is being purchased,  
 and transport links between the Port  
 and Naples-Salerno motorway will be  
 made plus a new and direct rail link to  
 the national network.

## Trieste

**Port of Trieste**  
 PO Box 569  
 Punto Franco Vecchio  
 Trieste  
 34100  
 Italy  
 Contact: Mr Franco Giannelli  
 Business Activity Manager  
 T: + 39 040 673 2335  
 F: + 39 040 673 2406  
 E: [fgiannelli@porto.trieste.it](mailto:fgiannelli@porto.trieste.it)  
 W: [www.porto.trieste.it](http://www.porto.trieste.it)

## Trieste

**Trieste Port, Pier 7**  
 Coeclerici Logistics  
 Via Diaz 7  
 Trieste  
 34121  
 Italy  
 Contact: Mr Giovanni Steccoli  
 T: + 39 010 605 3440  
 F: + 39 010 605 3444  
 E: [info@coeclerici.com](mailto:info@coeclerici.com)  
 W: [www.coeclerici.com](http://www.coeclerici.com)  
 Equipment & Capacity: Floating  
 terminal Bulk Trieste, storage capacity  
 120,000dwt. Four Cavaletto systems,  
 each with a discharging capacity of  
 11,000 tonnes per day. One mobile  
 crane.

## Vado Ligure (SV)

**Terminal Rinfuse Vado**  
 Via Montegrappa 1  
 Vado Ligure (SV)  
 17047  
 Italy  
 Contact: Mr Vittorio Barzilai  
 Marketing and Sales  
 T: + 39 019 216 06253  
 F: + 39 019 216 06299  
 E: [vittorio.barzilai@  
 terminalrinfuseitalia.it](mailto:vittorio.barzilai@terminalrinfuseitalia.it)

## Venezia

**T.M.B SRL Venezia**  
 Zattere 1401  
 Venezia  
 I-30123  
 Italy  
 T: + 39 041 533 4484  
 F: + 39 041 533 4570

## Venice

**Port Authority of Venice**  
 Santa Marta - Fabbriato 13  
 Venice  
 30123  
 Italy  
 Contact: Mr Antonio Revedin  
 Director  
 T: + 39 041 533 4284  
 F: + 39 041 533 4254  
 E: [antonio.revedin@port.venice.it](mailto:antonio.revedin@port.venice.it)  
 W: [www.port.venice.it](http://www.port.venice.it)

## Venice

**Port of Venice Marghera**  
 Zattere Commerciale Molo B  
 Zattere 1401  
 Venice

30123  
 Italy  
 Contact: Mr Stefano Bonaldo  
 Statistics  
 T: + 39 041 533 4281  
 F: + 39 041 533 4577  
 E: [stefano.bonaldo@port.venice.it](mailto:stefano.bonaldo@port.venice.it)  
 W: [www.port.venice.it](http://www.port.venice.it)

## IVORY COAST

### Abidjan

**Port Autonome d'Abidjan**  
 PO Box V85  
 Abidjan  
 Ivory Coast  
 Contact: Mr Jean-Michel Moulou  
 Managing Director  
 T: + 225 21 21 620  
 F: + 225 21 24 80 80  
 W: [www.paa-ci.org/](http://www.paa-ci.org/)

## JAMAICA

### Kingston

**Kingston Port Authority**  
 PO Box 116  
 NewPort East  
 Kingston  
 Jamaica  
 Contact: Mr H C De Lisser  
 Vice President  
 T: + 1 876 922 0290  
 F: + 1 876 924 9437  
 E: [hdelisser@portjam.com](mailto:hdelisser@portjam.com)

### Kingston

**Port Authority of Jamaica**  
 PO Box 474  
 40 Harbour Street  
 Kingston  
 Jamaica  
 Contact: Mr Lucian M Rattray  
 T: + 1 876 922 0290  
 F: + 1 876 922 6516  
 E: [paj@portjam.com](mailto:paj@portjam.com)  
 W: [www.portjam.com](http://www.portjam.com)

### Kingston

**Port of Port Rhoades**  
 Port Authority of Jamaica  
 15-17 Duke Street  
 Kingston  
 Jamaica  
 Operations Manager  
 T: + 1 876 922-0290  
 F: + 1 876 924-9437  
 E: [paj@portjam.com](mailto:paj@portjam.com)  
 W: [www.portjam.com](http://www.portjam.com)

### Kingston

**Port Kaiser**  
 Kaiser Terminal  
 Port Authority of Jamaica  
 15-17 Duke Street, PO Box 116  
 Newport East  
 Kingston  
 Jamaica  
 Contact: Mr J McFarlane  
 Port Director  
 T: + 1 809 922 67 66  
 F: + 1 809 922 64 19

### Saint Ann's Bay

**Ocho Rios Port**  
 Jamaica Bauxite Mines  
 Lydford PO  
 Saint Ann's Bay  
 Jamaica  
 Contact: Mr Williams  
 Port Manager  
 T: + 1 876 974 2603  
 F: + 1 876 973 1556  
 E: [paj@portjam.com](mailto:paj@portjam.com)  
 W: [www.portjam.com](http://www.portjam.com)

## St Catherine

**Port Esquivel**  
 c/o WINDALCO (West Indies  
 Alumina Company)  
 PO Box 2  
 Old Harbour  
 St Catherine  
 Jamaica  
 Contact: Mr Gilbert Callaghan  
 Director  
 T: + 1 876 983 9300  
 F: + 1 876 983 2215  
 E: [gilbert.callaghan@windalco.com](mailto:gilbert.callaghan@windalco.com)  
 W: [www.portjam.com](http://www.portjam.com)  
 Bulk Berths: Western Berth: Bulk  
 loading Alumina - Max draught 11.9m.  
 Eastern Berth: General Cargo - Max  
 draught 11m, wharf length 198.12m.  
 Mini Berth: Max draught 5m, length  
 70m.

## St Catherine

**West Indies Alumina Company**  
 Port Esquivel  
 PO Box 2  
 Old Harbour  
 St Catherine  
 WI  
 Jamaica  
 Contact: Mr Gilbert Callaghan  
 Port & Railway Operations  
 Manager  
 T: + 876 525 2215  
 F: + 876 983 2215  
 E: [gilbert.callaghan@windalco.com](mailto:gilbert.callaghan@windalco.com)  
 W: [www.windalco.com](http://www.windalco.com)  
 Location: West Indies  
 Equipment & Capacity: 1500 tonne/hr  
 loading rate  
 Bulk Berths: Berthing of caustic, oil,  
 alumina, ethanol, lime, grain and  
 general cargo  
 Total uncovered Storage: None  
 Total covered Storage: 73 MT  
 Alumina, 55,000 MT Caustic, 380,000  
 bbls Oil

## JAPAN

### Akigun

**Port of Mitsukojima**  
 Mitsukojima Transshipment Co  
 24-1 Tonoko 2-chome, Ondo-cho  
 Akigun  
 Hiroshima Pref  
 Japan  
 T: + 81 82 3253336

### Akita City

**Port of Akita**  
 c/o Akita Kairiku Unso Co Ltd  
 5-9, Nishi-2 Chome  
 Tsuchizaki-Minato  
 Akita City 011  
 Japan  
 T: + 81 18 845 2021  
 E: [agent@kairiku.co.jp](mailto:agent@kairiku.co.jp)  
 W: [www.kairiku.co.jp](http://www.kairiku.co.jp)  
 Location: Geographical 39°46'North /  
 140°00'East  
 Equipment & Capacity: One unloader  
 (600MT/hr) for Bulk Concentrates  
 Bulk Berths: Gaiko -13M No.1 Pier  
 (for Bulk Concentrates)  
 Max LOA 200M Max Draft 11.8M  
 Nippon Daishowa Itagami Tohoku  
 Dolphin (For Woodchip)  
 Max LOA 210M Max Draft 10.0M

### Anan City

**Port of Anan**  
 Anan Dobuku Office  
 Aotani, Tomioka-cho  
 Anan City, Tokushima Prefecture  
 Japan  
 Contact: Mr Hirao Hisao  
 Director General  
 T: + 81 886 212580  
 F: + 81 886 212674

## Aomori

**Port of Aomori**  
 Aomori Port Admin Office  
 5-5, Hon-cho 4 chome  
 Aomori  
 Japan  
 T: + 81 177 344101  
 F: + 81 177 344101  
 E: [kowan@pref.aomori.lg.jp](mailto:kowan@pref.aomori.lg.jp)  
 W: [www.pref.aomori.lg.jp/](http://www.pref.aomori.lg.jp/)

## Aomori

**Port of Hachinohe**  
 Hachinohe Port Administration  
 Office  
 1-131 Kitanuma, Kawaragi  
 Hachinohe-Shi  
 Aomori 039-1161  
 Japan  
 Contact: Mr Ishitori Masahiko  
 Director  
 T: + 81 178 282105  
 F: + 81 178 204746

## Chiba City

**Chiba Port**  
 Port & Harbor Division  
 Chiba Prefectural Government  
 1-1 Ichiba-cho Chou-ku  
 Chiba City 260-8667  
 Japan  
 Port and Harbour Management  
 T: + 81 43 223 3835  
 F: + 81 43 227 0928  
 E: [kousin2@mz.pref.chiba.lg.jp](mailto:kousin2@mz.pref.chiba.lg.jp)  
 W: [www.pref.chiba.lg.jp/kouwan/  
 chibanokouwan](http://www.pref.chiba.lg.jp/kouwan/chibanokouwan)  
 Location: Located in the northeastern  
 part of Tokyo Bay and Japan's largest  
 seaport.  
 Equipment & Capacity: Public berth:  
 12m quay until 30,000 DWT  
 Private berth: 19m quay more than  
 30,000 DWT aside of JFE Steel  
 Company.  
 Bulk Berths: Public for forest  
 products and private for many kinds  
 of commodities.  
 Only one hour's drive from central of  
 Tokyo

## Chiba-City

**Kisarazu Port**  
 Port & Harbor Division  
 Chiba Prefectural Government  
 1-1 Ichiba-cho Chuo-ku  
 Chiba-City  
 260-8667  
 Japan  
 T: + 81 43 223 3835  
 F: + 81 43 227 0928  
 E: [kousin2@mz.pref.chiba.lg.jp](mailto:kousin2@mz.pref.chiba.lg.jp)  
 W: [www.pref.chiba.lg.jp/kouwan/  
 chibanokouwan](http://www.pref.chiba.lg.jp/kouwan/chibanokouwan)  
 Location: Inside Tokyo bay area and  
 stands by the Trans Tokyo Bay bridge  
 Equipment & Capacity: Public berth:  
 12 m quay until 30,000 DWT  
 Private berth: 19 m quay more than  
 30,000 DWT  
 Bulk Berths: Private berth is managed  
 by big steelmaker works (Nippon  
 Steel & Sumitomo Metal)  
 Kisarazu port is appointed one of  
 International Strategic Bulk Port for  
 Iron Ore by Minister of Land  
 & Transportation

## Chiyoda-ku

**Idemitsu Bulk Terminal-Chiba**  
 c/ Industrial Energy Dpt. Idemitsu  
 Kosan  
 1-1 Marunouchi 3-chome  
 Chiyoda-ku  
 Tokyo  
 100-8321  
 Japan  
 Contact: Mr T Nio  
 T: + 81 3 3746 8721  
 F: + 81 3 3746 3645  
 W: [www.idemitsu.co.jp](http://www.idemitsu.co.jp)



**Fukuoko City**

**Hakata Port & Harbour Bureau**  
13-13 Sekijo-Machi  
Hakatu-ku  
Fukuoko City  
812  
Japan  
Contact: Mr Teizo Ishibashi  
Deputy Executive Director  
T: + 81 92 282 7111  
F: + 81 92 291 7144  
W: www.port-of-hakata.or.jp/english

**Hakodate**

**Hakodate Port and Airport Department**  
4-13 Shinonome-cho  
City of Hakodate  
Hakodate  
Hokkaido  
040-8666  
Japan  
Contact: Ms Yoshie Yorozuya  
Promotion Section Manager  
T: + 81 138 21 3488  
F: + 81 138 26 2656  
E: yorozuya.y@city.hakodate.hokkaido.jp  
W: www.city.hakodate.hokkaido.jp/harbor/  
Location: The southern part of Hokkaido and the southern entrance of Hokkaido.  
Equipment & Capacity: 1 Jib Crane and 1 reach stacker.  
Bulk Berths: Nishi(West) Pier:(-4)312m (-5)140m, (-9)165m, (-6.5)105m  
Bandai Pier:(-4)67m, (-5.5)90m(-7.5)130m, (-10)185m, (-5.5)90m(-7.5)130m  
Kita(North) Pier:(-5)130m, (-5.5)88m, (-7.5)130m, (-5.5)330m  
Chuo(Central) Pier:(-8)133m, (-5.5)130m, (-5.5)90m(-9)165m(-9)165m  
Minato-cho Pier: (-14)280m, (-12)240m  
Total uncovered Storage: Minato-cho Pier: 1.5ha (1.84ha During December to June)  
Total covered Storage: Minato-cho Pier: 0.09ha  
Reefer plug 220V:2 440V:28 Spare:12  
Total 40

**Handa City**

**Port of Kinuura**  
Kinuura Port Authority  
1-1. 11-Gochi  
Handa City  
Aichi Prefecture  
Japan  
T: + 81 569 21 2451  
F: + 81 569 21 2459  
E: kinuura-komu@pref.aichi.lg.jp  
W: www.pref.aichi.jp/kensetsu-somu/kinuura-komu/index.html

**Hiroshima**

**Kure Port Authority**  
1-6 Chou, 4-chome  
Kure City  
Hiroshima  
Japan  
Contact: Mr Hiroyuki Shindo  
T: + 81 823 25 3334  
F: + 81 823 25 1361  
E: kureport@alto.ocn.ne.jp

**Hiroshima**

**Hiroshima Port Authority**  
23-53 Ujina Kaigan  
2-chome, Minami-ku  
Hiroshima  
Japan  
Contact: Mr M Shimizu  
Port Manager  
T: + 81 82 251 7117  
F: + 81 82 253 8250  
E: soukouhou@pref.hiroshima.lg.jp

**Hiroshima**

**Port of Takehara No 1P/S**  
3035-13 Nagahama  
Tadami-cho  
Takehara-shi  
Hiroshima  
729-23  
Japan  
Contact: Captain Yamada  
T: + 81 846 27 0211  
F: + 81 846 24 1506

**Hiroshima**

**Fukuyama Port Authority**  
Port Section of Hiroshima  
Prefecture  
Motomashi, 10-52 Naka-ku  
Hiroshima  
730  
Japan  
T: + 81 849 45 3238  
F: + 81 849 45 3442

**Hokkaido**

**Tomato Coal Center**  
622 Aza-Hamaatsuma  
Atsuma-cho  
Hokkaido  
059-17  
Japan  
Contact: Mr Masatoshi Machida  
T: + 81 1452 83121  
F: + 81 1452 83123

**Ibaraki**

**Hitachi Port Authority**  
Hitachi City Office  
Kuji-Cho 1-3-21  
Ibaraki  
Japan  
T: + 81 294 524 000  
F: + 81 294 535 337  
E: kowan5@pref.ibaraki.jp  
W: www.pref.ibaraki.jp

**Iymishima City**

**Port of Mishima-Kawanoe**  
Marine Safety Agency  
Mishima-Kawanoe Branch  
6-45 Kamiya-Cho  
Iymishima City  
Ehime Pref  
799-04  
Japan  
T: + 81 89 623 5267  
E: mtjm-i88s3@pa.skr.mlit.go.jp

**Kagoshima City**

**Port of Kagoshima**  
Kagoshima Port and Harbour  
Kagoshima Port Operation Office  
18-16 Izumi-cho  
Kagoshima City  
Kagoshima  
892-0822  
Japan  
Contact: Mr Taturou Suga  
Governor  
T: + 81 225 956 271  
F: + 81 225 956 273  
E: kowan@pref.kagoshima.lg.jp  
W: www.pref.kagoshima.jp/home/kowanka/  
cruise-net/english/01kagoshima

**Kagoshima City**

**Pacific Grain Terminal**  
4-20 Nanei  
Kagoshima City  
Japan  
Contact: Mr Shigeichi Koriyama  
Senior MD  
T: + 81 99 268 8291  
F: + 81 99 269 5553

**Kakogawa City**

**Higashi-Harima Port Authority**  
c/o Kakogawa Dabuku  
Public Works Office Tenjingi  
Jike-machi

Kakogawa City  
Hyogo Pref  
Japan  
T: + 81 78 3417711  
F: + 81 78 3416477  
E: wss.kobe@wilhelmsen.com

**Kamisu-City**

**Kanto Grain Terminal Co. Ltd**  
2-3 Higashi Fukashiba  
Kamisu-City  
Ibaraki-ken  
314-0103  
Japan  
Contact: Mr H Omori  
T: + 81 299 92 6531  
F: + 81 299 92 6548  
E: h.oomori@kanto-grain.co.jp  
Location: Kamisu-City, Japan.  
Equipment & Capacity: 1x Pneumatic unloader - 400tph  
2x Mechanical unloader - 400tph  
Chain conveyors & bucket elevators  
400tph loading into silo via 3 routes,  
200tph loading out to feed factories and trucks via 8 routes.  
3x Hoppers 5 Mt loading in  
9x 2.5 Mt loading out.  
Bulk Berths: Max length 280m, Max depth 13m, Max DWT 73,000 (Panamax)  
Total uncovered Storage: Site area 29,865sqm  
Total covered Storage: Concrete silo with steel plate lined and steel silo.  
135 bins, 176,881t for corn, sorghum, barley etc  
15 bins, 16,264t for soybean meal etc.

**Kanda-Machi**

**Kanda Port**  
Kanda Port Administration Office  
29 Branch minato-machi  
Kanda-Machi  
Fukouka Pref  
Japan  
Contact: Mr K Yano  
General Manager  
T: + 8193 434 0585  
F: + 8193 436 2875  
E: kowan@pref.fukuoka.lg.jp

**Kasaoka City**

**Kasaoka Port**  
Kasaoka Public Works Office  
2-5 Rokuban-cho  
Kasaoka City  
Okayama Pref  
Japan  
T: + 81 86 563 5252  
E: wss.kobe@wilhelmsen.com

**Kawasaki City**

**Port of Kawasaki**  
Port & Harbour Bureau of Kawasaki  
1-Miyamoto-cho, Kawasaki-ku  
Kawasaki City  
Japan  
T: + 81 44 200 2111  
F: + 81 44 222 0219  
E: 58yuuti@city.kawasaki.jp

**Kitakyushu City**

**Kitakyushu Port & Harbour Authority**  
2-7 Nishi-Kaigan  
1-chome, Moji-ku  
Kitakyushu City  
Fukuoka Pref  
801-8555  
Japan  
Contact: Mr Tashiro  
Marketing  
T: + 81 93 3215933  
F: + 81 93 3215915  
E: kqport@kitaqport.or.jp  
W: www.kitaqport.or.jp/

**Kitakyushu City**

**Port of Kokura**  
c/o Kitakyushu Port & Harbour Bureau  
2-7 Nishi-Kaigan 1-chome Moji-ku  
Kitakyushu City  
Fukuoka Pref  
801  
Japan  
Contact: Mr Tashiro  
Marketing  
T: + 81 93 321 5941  
F: + 81 93 321 5915  
E: kqport@kitaqport.or.jp

**Kitakyushu City**

**Port of Yawata**  
Kitakyushu Port and Harbour Bureau  
2-7 Nishi-Kaigan 1-chome, Moji-ku  
Kitakyushu City  
Fukuoka Pref  
801  
Japan  
Contact: Ms Keiko Katsura  
Marketing  
T: + 81 93 321 5941  
F: + 81 93 321 5933  
E: kqport@kitaqport.or.jp

**Kitakyushu City**

**Port of Hibikinade**  
c/o Kitakyushu Port and Harbour Bureau  
Nishi-Kaigan 1-2-7 Moji-ku  
Kitakyushu City  
Fukuoka Pref  
801  
Japan  
T: + 81 93 321 5941  
F: + 81 93 321 5933  
E: wss.tokyo@wilhelmsen.com

**Kitakyushu City**

**Yawata Hibikinada**  
Port/Harbour Bureau of Kitakyushu City  
2-7 Nishikaigan  
1-Chrome  
moji-ku  
Kitakyushu City  
801  
Japan  
T: + 81 93 331 1331  
F: + 81 93 321 5915

**Kobe**

**Port of Kobe**  
Port & Harbour Bureau  
5-1, 6-chome Kano-cho  
Chou-Ku  
Kobe  
650  
Japan  
Contact: Mr Noriyoshi Okaguchi  
Director General  
T: + 81 78 331 8181  
F: + 81 78 322 6120  
E: info\_kobeport@office.city.kobe.lg.jp  
W: www.city.kobe.jp/cityoffice/39/port/index.htm  
Location: The centre of Japan (Latitude 34 38-43N, Longitude 35 5-18E)  
Equipment & Capacity: Total Berths 234  
Berths 225, 43,442m  
Dolphins 9 31  
Total uncovered Storage: 107,835sqm  
Total covered Storage: 273,936sqm

**Kobe**

**Port Authority of Himeji**  
Public Works Division  
Hyogo Prefecture  
5-10-1 Shimoyamate-dori  
Chu-ku  
Kobe  
Japan  
T: + 81 78 362 9274  
F: + 81 78 322 6120

E: kouwanka@pref.hyogo.jp  
W: www.shikamakaiun.co.jp/ue47.htm

**Kobe**

**Amagasaki Port Authority**  
Ports and Harbour Section  
Hyogo Pref  
5-1 Shimoyamate-dori Chou-ku  
Kobe  
Japan  
T: + 81 78 341 7711  
F: + 81 78 341 6477

**Kochi City**

**Port of Kochi**  
Kochi Maritime Safety Office  
5-4-55, Sanbashi -dori  
Kochi City  
780  
Japan  
Port Manager  
T: + 81 888 239888  
F: + 81 888 372111  
E: 175201@ken.pref.kochi.lg.jp

**Komatsushima City**

**Port of Tokushima**  
Komatsushima  
Komatsushima Port and Harbour Office  
37, Shinko, Komatsushima-cho  
Komatsushima City  
Tokushima Pref  
Japan  
T: + 81 88 621 2028  
E: koe@city.komatsushima.tokushima.jp

**Kurashiki City**

**Mizushima Port Authority**  
1-12 Mizushima Fukuzaki-cho  
Kurashiki City  
Okayama  
712-8056  
Japan  
Contact: Mr Imoue  
Director  
T: + 81 864 447141  
F: + 81 841 483010  
E: wss.kobe@wilhelmsen.com  
W: www.pref.okayama.jp/bichu/mizu/port.htm

**Kushiro City**

**Kushiro Port Authority**  
Port & Harbour Department  
Kushiro Kowan Goda Chosha  
100-17 Shin Fujich  
Kushiro City  
Hokkaido  
Japan  
T: + 81 154 533 373  
F: + 81 154 533 373  
E: ku210101@city.kushiro.hokkaido.jp  
W: www.city.kushiro.hokkaido.jp/kouwan/minato/

**Maizuru City**

**Maizuru Port Authority**  
Maizuru Port Admin Office  
19-5 Koaza Shimazaki Aza  
Matsukage  
Maizuru City  
Japan  
T: + 81 773 75 7184  
F: + 81 773 75 7198  
E: m-port@mxa.nkansai.ne.jp  
W: www5.nkansai.ne.jp/offm-port/index\_e.htm

**Marugame City**

**Port of Marugame**  
Marugame Harbour Office  
127-16 Fukushima-cho  
Marugame City  
Kagawa  
Japan  
T: + 81 877-23-7696

## Minatoku

**Niihama Coal Centre**  
Sumitomo Coal Mining  
204, 3-Chrome  
Nishi-Shimbashi  
Minatoku  
Tokyo  
Japan  
Contact: Mr Yoshitoyo Nakayama  
Deputy General Manager  
T: + 81 3 5404 0410  
F: + 81 3 5404 0447

## Moji-ku Kitakyushu City

**Port of Tobata**  
c/o Kitakyushu Port Bureau  
2-7 Nishikaigan, 1-chome,  
Moji-ku Kitakyushu City  
Fukuoka Pref 801  
Japan  
Contact: Mr Hiroyuki Tagami  
T: + 81 93 321 5941  
F: + 81 93 321 5915  
E: hiroyuki\_tagami01@  
city.kitakyushu.jp  
W: www.kitaport.or.jp

## Moji-ku Kitakyushu City

**Moji Port Authority**  
Port and Harbour Bureau  
2-7 Nishi-Kaigan  
Moji-ku Kitakyushu City  
Fukuoka Pref  
Japan  
Contact: Mr Tashiro  
Head of International Affairs  
T: + 81 93 321 5941  
F: + 81 93 321 5933  
E: wss.moji@wilhelmsen.com  
W: www.japanwelcomesyou.com/  
cssweb/ports/port/html/kitakyushu.html

## Morioka

**Port of Kamaishi**  
Port and Harbour Department  
10-1 Uchimaru  
Morioka  
Iwate Pref  
020  
Japan  
T: + 81 19 629 5912  
F: + 81 193 243962  
E: AG0010@pref.iwate.jp

## Morioka

**Port of Ofunato**  
Port & Harbour Section of Iwate  
Prefecture  
10-1 Uchimaru  
Morioka  
Iwate-Pref  
020  
Japan  
Contact: Mr H Kimura  
T: + 81 192 273111  
F: + 81 196 515 604  
E: wss.tokyo@wilhelmsen.com

## Mubanti

**Shukuzu Coal Centre**  
Koowan-Bu  
Hokkaido Muroran-shi  
Kaigan-Choo  
1-Chrome  
Mubanti  
Japan  
Contact: Mr T Nakamura  
Manager  
T: + 81 143 244466  
F: + 81 143 240011

## Muroran City

**Muroran Port Authority**  
20-30 Kaigan-cho  
1-chome  
Muroran City  
Hokkaido Province  
Japan  
Contact: Mr Asei Sakata  
T: + 81 143 22 3191

F: + 81 143 22 6069  
E: oport@city.muroran.hokkaido.jp  
W: www.city.muroran.hokkaido.jp

## Nagasaki City

**Port of Matsushima**  
Matsushima Port Authority  
Port and Harbour Section  
2-13 Edo-Machi  
Nagasaki City  
850  
Japan  
T: + 81 95 824 1111

## Nagoya

**Gamagori Port Authority**  
c/o Port and Harbour Section of  
Aichi Prefecture,  
3-1-2 Sannomaru  
Naka-Ku  
Nagoya  
460-01  
Japan  
T: + 81 52 654 7840  
F: + 81 52 650 7995

## Niigata City

**Port of Niigata**  
Bureau of Port and Airport  
Development  
Niigata Prefecture  
4-1 Shinko-cho  
Niigata City  
Niigata  
950-8570  
Japan  
Contact: Mr T Sugimoto  
T: + 81 0 25 280 5456  
F: + 81 25 284 5042  
E: T1700102@mail.pref.niigata.jp  
W: Port of Niigata

## Niihama City

**Port of Niihama**  
5-1 Ikku-cho  
1 chome  
Niihama City  
Ehime Pref  
792-0025  
Japan  
T: + 81 897 33 5151  
F: + 81 897 324 515  
E: wss.kobe@wilhelmsen.com

## Oita City

**Port of Oita**  
Oita Port Authority  
Shin Sangyotoshi Kaihatsu Kyoku  
3-33 Mukaibaru  
Oita City  
Nishi 1-chome Oita Pref  
Japan  
T: + 81 97 558 5111  
F: + 81 97 553 0655  
W: www.pref.oita.jp/14300/faz/  
faz1/english/faz\_en.html

## Osaka City

**Port of Osaka**  
Osaka Port and Harbors Bureau  
WTC Bldg 41F  
1-14-16 Nanko-Kita  
Suminoe-ku  
Osaka City  
559-0034  
Japan  
Contact: Mr Tadashi Ito  
Manager, Port Promotion  
T: + 81 6 6615 7764  
F: + 81 6 6615 7769  
E: na0004@city.osaka.lg.jp  
W: www.city.osaka.jp/port

## Otaru City

**Port of Otaru**  
Otaru Port Authority  
4-2 Minato-Machi  
Otaru City  
Hokkaido Pref  
Japan

T: + 81 134 23 1109  
E: kowan@city.otaru.hokkaido.jp  
W: www.city.otaru.hokkaido.jp/  
minato/mina\_s.htm

## Sakaide City

**Sakaide Port Administration**  
5-32 Irifune-cho  
1-chome  
Sakaide City  
Kagawa Pref  
Japan  
T: + 81 877 46 2518  
E: kowan1@city.sakaide.lg.jp

## Sakaide City

**Sakaide Port Administration**  
5-32 Irifune-cho, 1-chome  
Sakaide City  
Kagawa Pref  
Japan  
T: + 81 877 462 518  
F: + 81 877 464056

## Sasebo City

**Port of Sasebo**  
Port and Harbour Bureau  
3-5 Yorozu-cho  
Sasebo City  
Nagasaki Pref  
Japan  
T: + 81 956 226128  
F: + 81 956 226149

## Schimonoseki City

**Schimonoseki Port & Harbour Bureau**  
Schimonoseki City Government  
Nabe-cho  
1-1  
Schimonoseki City  
Yamaguchi Pref  
Japan  
Contact: Mr Toshihiko Nakano  
Director General  
T: + 81 832 31 1111  
F: + 81 832 33 0860  
E: webmaster@schimonoseki-port.com  
W: www.schimonoseki-port.com

## Sendai

**Port of Ishinomaki**  
Ports & Harbors Promotion Division  
Public Works Department  
Miyagi Prefectural Government  
Aoba-ku  
Sendai  
Miyagi Pref.  
980-8570  
Japan  
Contact: Mr Kimio Doi  
Chairman  
T: + 81 22 211 3221  
F: + 81 225 956 273  
E: kousin@pref.miyagi.jp  
W: www.port-ishinomaki.jp

## Sendai

**Port of Sendai**  
Sendai Port Administrative Office  
3-8-20 Minato  
Miyagino-ku  
Sendai  
Miyagi pref  
983  
Japan  
T: + 81 22 254 3131  
F: + 81 22 211 3296  
E: kousin@pref.miyagi.jp  
W: www.pref.miyagi.jp/  
snd-kouwan/english/english.htm

## Shibushi-shi

**Port of Shibushi**  
Shibushi Port Administrative Office  
6617-17 Cho Shibushi-cho,  
Shibushi-shi  
Kagoshima Pref  
899-7102  
Japan

T: + 81 994 73 1651  
F: + 81 994 73 1671  
E: shibushi-minato@  
pref.kagoshima.lg.jp  
W: www.pref.kagoshima.jp/  
infra/port/minato/shibushi/index.html

## Shizuoka City

**Port Authority of Shimizu**  
9-25 Hinode-cho  
Shimizu-ku  
Shizuoka City  
Shizuoka Prefecture  
424-0922  
Japan  
Contact: Mr Aritsuka Kobayashi  
Planning & Development Manager  
T: + 81 543 53 2203  
F: + 81 543 54 0380  
E: port@mail.wbs.ne.jp  
W: www.portofshimizu.com  
Location: 35 01 N  
138 32 E  
Bulk Berths:  
Grain,Cement,LNG,Oil,etc.  
Total uncovered Storage: 335,901  
sqm  
Total covered Storage: 62,947 sqm  
Shimizu is the mail port of Shizuoka  
prefecture.The total container volume  
of Shimizu is 518,742 TEU in 2004  
(7th in Japan). Shimizu open 24 hours  
a day.

## Shizuoka City

**Port of Tagonoura**  
Port Administrative Office  
2-1 Suzukawa-cho  
Fuji Shi  
Shizuoka City  
417  
Japan  
Contact: Mr Kyusaku Sato  
Master of Tagonoura Port Office  
T: + 81 5 433 0495  
F: + 81 5 433 1009

## Takamtsu City

**Naoshima Port Authority**  
Port & Harbour Department  
1-10 Bancho 4-chome  
Takamtsu City  
Kagawa Pref  
Japan  
T: + 81 87 831 1111  
E: wss.tokyo@wilhelmsen.com

## Tokuyama City

**Tokuyama Port Authority**  
13-23 Chikko-cho  
Tokuyama City  
Yamaguchi Pref  
745-0025  
Japan  
Contact: Mr Hidoshi Onishi  
Port Manager  
T: + 81 834 211787  
F: + 81 834 325090

## Tokuyama City

**Tonda Port Authority**  
c/o Shunan Port Admin Office  
13-23 Chikko-cho  
Tokuyama City  
Yamaguchi Pref  
Japan  
Contact: Mr Masaru Kaneno  
Port Manager  
T: + 81 834 211787  
F: + 81 834 325090

## Tokyo

**Tokyo Metropolitan Government**  
Bureau of Port and Harbour 8-1  
Nishi-Shinjuku 2-chome,  
Shinjuku-ku  
Tokyo  
163-8001  
Japan  
Contact: Ms Toshiko Seki  
T: + 81 3 5320 5549

F: + 81 3 5388 1576  
E: S0000517@section.metro.tokyo.jp  
W: www.kouwan.metro.tokyo.jp  
Location: The port is on the north-  
western part of the Tokyo Bay. It is  
located in the area between the  
estuaries of the Arakawa and  
Tamagawa Rivers.  
Equipment & Capacity: Breakwater  
Length : 8,781m  
Mooring Facilities :  
-Wharves and Piers : 23,059m 205  
berths (incl. 4,479m, 15 berths for  
container)  
-Buoys : 3 2 berths  
-Dolphins : 31 19 berths  
-Landing Stage : 2,094m  
Timber Basins : 999,213 sqm 6  
berths  
Bulk Berths: Bulk Cargo Terminal : 1  
berth, 240m, -12m Oi Construction-  
Materials Terminal : 4 berths, 280m, -  
5m Oi Food Stuff Terminal : 3 berths,  
610m, -12m/-11m Shinagawa  
Terminal(Domestic) : 5 berths, 856m, -  
8m Shibaura Terminal : 7 berths,  
870m, -7.5m/-5.5m  
Total uncovered Storage: Open-air  
Storage Yards (public) : 1,010,595  
sqm  
Total covered Storage: Transit Sheds  
(public) : 209,487 sqm

## Tomakomai City

**Tomakomai Port Authority**  
6-38, Minato-Machi 1-chome  
Tomakomai City  
Hokkaido  
053-0004  
Japan  
Contact: Mr Junichi Suzuki  
Executive Vice President  
T: + 81 144 345551  
F: + 81 144 345559  
E: t-masuda@ptmk.com  
W: www.ptmk.com

## Toyama City

**Toyama Port Authority**  
Administration Office  
5 Kaigan-dori  
Higashi Iwase,  
Toyama City  
Toyama  
931-8358  
Japan  
Contact: Mr K Yamaguchi  
T: + 81 764 377 131  
F: + 81 764 419 050

## Toyama City

**Toyama-Shinko Public Berths**  
Fushiki Kairiku Unso  
Toyamashinko Branch  
4-2 Nagonoe  
Shinminato-shi  
Toyama City  
Japan  
T: + 81 766 82 1118  
F: + 81 766 84 3335

## Tsuruga City

**Tsuruga Port Authority**  
2-1 Sakura-machi  
Tsuruga City  
Fukui Pref  
Japan  
T: + 81 776 20 0489  
E: kowan@pref.fukui.lg.jp

## Ube City

**Port of Ube, Okinoyama Coal Terminal**  
12-32 Nishihon-machi  
1-Chrome  
Ube City  
Yamaguchi Pref  
Japan  
Contact: Mr Masayoshi Wanishi  
General Manager  
T: + 81 335 31 5971



F: + 81 838 31 5885

**Usui City**

**Tsukumi Port Authority**  
Usuki Doboku Office  
72-254 Aza Susaki, Oaza Usuki  
Usui City  
Oita Pref  
875-0041  
Japan  
T: + 81 972 634136

**Wakayama City**

**Wakayama Port Authority**  
Wakayama Shimotsu Admin Office  
22 Chikko 6- chome  
Wakayama City  
Hokkaido Pref  
Japan  
T: + 81 734 413154  
F: + 81 734 334839

**Wakayama City**

**Smikin Transport Service**  
1850 Minato  
Wakayama City  
Hokkaido Pref  
Japan  
Contact: Mr Tutomu Oonishi  
T: + 81 734 51 5168  
F: + 81 734 51 5150

**Yatsushiro City**

**Yatsushiro Port Office**  
249 Minato-machi  
Yatsushiro City  
Kumamoto Pref  
Japan  
Port Office Superintendent  
T: + 81 96 333 2514  
E: kouwan@pref.kumamoto.lg.jp

**Yokkaichi City**

**Chubu Coal Centre**  
2-16 Kasumi  
Yokkaichi City  
Mie-Pref  
510-0011  
Japan  
Contact: Mr J Deguchi  
Director  
T: + 81 593 63 0671  
F: + 81 593 64 7871

**Yokohama**

**Port of Yokohama**  
Port and Harbour Bureau  
5F Sangyo-Boeki Center Boulevard 2  
Yamashita-cho, Naka-ku  
Yokohama  
231-0023  
Japan  
Contact: Mr Kazuhiko Watanabe  
Port Promotion Director  
T: + 81 45 671 7188  
F: + 81 45 671 7310  
E: portoubo@city.yokohama.jp  
W: www.city.yokohama.jp/me/port

**JERSEY**

**St Hellier**

**Induvac**  
Belrespiro  
La Route des Petits Camps  
St Hellier  
JE2 4JN  
Jersey  
Contact: Mr Ian Miller  
T: + 44 1534 767623  
F: + 44 1534 874088  
E: belrespiro@aol.com

**JORDAN**

**Aqaba**

**The Ports Corporation Aqaba**  
Port Corps of Aqaba  
PO Box 115  
Aqaba  
77110  
Jordan  
Contact: Mr Awwad Maytah  
Director General  
T: + 962 3 201 4042  
F: + 962 3 201 6204  
E: info@aqabaports.gov.jo  
W: www.adc.jo

**KENYA**

**Mombasa**

**Grain Bulk Handlers Ltd**  
Grain House  
Beira Road  
Shimanzi  
PO Box 80469  
Mombasa  
Coast  
80100  
Kenya  
Contact: Mr Mujtaba Jaffer  
CEO  
T: + 254 7030 17000  
F: + 254 7030 17444  
E: gbh@grainbulk.com  
W: www.grainbulk.com

**Mombasa**

**Port of Mombasa**  
Kenya Port Authority  
PO Box 95009  
Mombasa  
Kenya  
Contact: Mr Brown M. Ondego  
Managing Director  
T: + 254 11 312211  
F: + 254 11 311867  
E: micd@kpa.co.ke

**Mombasa**

**Kenya Ports Authority**  
PO Box 95009  
Mombasa  
Kenya  
Contact: Capt Twalib Khamis  
General Manager - Operations  
T: + 254 41 312 211  
F: + 254 41 311 867  
E: tkhamis@kpa.co.ke  
W: www.kenya-ports.com  
Location: East Africa on the Indian Ocean  
Equipment & Capacity: -Travelling Cranes - nos. 30, 5 - 20 tonne  
-Portal electric fixed cranes - nos. 3, - 3 tonne  
-Electric overhead travelling cranes - nos. 3, 2 - 10 tonne  
-Under hung jib - nos. 4, 1.5 tonne  
-Forklift trucks - nos. 50, 3 - 16 tonne  
-Mobile cranes - nos. 13, 5 - 43 tonne  
Bulk Berths: -Grain Bulk Handlers Ltd - Berth No - 3, Total Length (m) 166.4, Draft 10, 2 Ship unloaders - 600 tonnes per hour  
-Magadi Soda Ltd - Berth No 9, Total length (m) 179.8, Draft 10.4, 1 payload  
-Mbaraki 1-Total length(m) 153, Draft 10.4 - 10.97  
-Mbaraki 2 -Total length(m) 153, Draft 10.4 - 10.97  
- Berth 11- Total length(m) 173.1, Draft 10.4 - 9.75  
- Berth 12, Total length(m) 166.4, Draft 10.4 - 9.75  
Total uncovered Storage: 114,117 sqm  
Total covered Storage: 132,781 sqm

**KIRIBATI**

**Betio**

**Kiribati Ports Authority**  
PO Box 506  
Betio  
Tarawa  
Kiribati  
Contact: Mrs Rubee Eromanga  
T: + 686 25147  
F: + 686 26164  
E: kpa@tskl.net.ki

**KUWAIT**

**Safat**

**Shuwaikh Port**  
c/o Kuwait Port Authority  
PO Box 3874  
Safat  
13039  
Kuwait  
Contact: Mr Alia Salem Al-Saba  
Director General  
T: + 965 481 2622  
F: + 965 481 9714  
E: isaship@qualitynet.net  
W: www.isakwi.com/

**Safat**

**Shuaiba Port**  
Kuwait Ports Authority  
PO Box 3874  
Safat 13039  
PO Box 3874  
Safat 13039  
Safat  
13039  
Kuwait  
Contact: Mr Karim Habib Ali  
T: + 965 4812622  
F: + 965 4819 714  
W: www.kpa.com.kw

**LATVIA**

**Liepaja**

**Liepaja Special Economic Zone**  
**Authority SEZ**  
4 Feniska Street  
Liepaja  
3401  
Latvia  
Contact: Mr Aivers Boja  
Port General Manager  
T: + 371 6 34 27605  
F: + 371 34 80252  
E: authority@sez.lv  
W: www.liepaja.lv

**Liepaja**

**Liepaja Port Authority**  
4 Feniska Street  
Liepaja  
34Z01  
Latvia  
Contact: Mr I Boja  
Port Director  
T: + 371 34 29605  
F: + 371 34 80252  
E: port@sez.lv  
W: www.liepaja-sez.lv

**Riga**

**Freeport of Riga Authority**  
12 Kalpaka Boulevard  
Riga  
LV 1010  
Latvia  
Contact: Mr Leonids Loginovs  
Chief Executive Officer  
T: + 371 6703 0800  
F: + 371 6703 0835  
E: info@freeportofriga.lv  
W: www.freeportofriga.lv/  
Location: South-East of the Baltic Sea at the Riga Bay  
Equipment & Capacity: 4 Container

re-loaders, 30.5t  
15 Mobile cranes, 5 - 100t  
100 Cranes, 5 - 40t  
300 Forklifts, 1.5 - 25t  
Bulk Berths: Number of bulk berths: 52  
max length: 250 m  
max draft: 12.2 m  
Total uncovered Storage: 1,797,000 sqm  
Total covered Storage: 180,000 sqm

**Riga**

**WT Terminal Ltd**  
Flotes Street 3a  
Riga  
LV-1016  
Latvia  
Contact: Mr Janis Lapins  
T: + 371 6780 6018  
F: + 371 6744 3001  
E: janis.lapins@wt-terminal.lv  
W: www.wt-terminal.lv  
Location: In Freeport of Riga, Latvia  
Equipment & Capacity: 3 cranes and 8 forklifts. 500,000m3/tonnes/year  
Bulk Berths: 350m, 5.5m draught  
Total uncovered Storage: 95,000sqm  
Total covered Storage: 9,000sqm  
The terminal handles cargoes to/from vessels, trucks, railways wagons. The Terminal is able to store and transship several types of bulk & general cargoes. Terminal is fully ISPS - compliant. Our customers enjoy on-line stock control.

**Riga**

**Riga Central Terminal**  
15 Eksporta Street  
Riga  
LV-1170  
Latvia  
Contact: Ms Kristine Vizule  
Marketing and PR Manager  
T: + 371 673 295 46 / + 371 673 29816  
F: + 371 6732 6501  
E: Kristine.vizule@rigact.lv  
W: www.rigact.lv  
Location: Capital of Latvia (Middle Latvia)  
Equipment & Capacity:

Equipment	Quant.	Capacity
Portal cranes	29	up to 40t
Caterpillar cranes	3	up to 21t
Forklifts	65	up to 10t
Forklifts	8	10t-25t
Reach stacker	1	up to 45t
Tug masters	5	up to 80t
Scoop tractors	14	up to 7.5m <sup>3</sup>
Wagon tractors	9	40 t
Locomotives	3	60

wagons  
Bulk Berths: Berth / Length / Draught  
EO-7 / 190 / 9.5  
EO-9 / 130 / 6.6  
EO-10 / 150 / 7.0  
EO-11 / 140 / 7.2  
EO-12 / 159 / 7.0  
EO-14 / 210 / 11.7  
EO-15 / 212 / 11.7  
PM-16 / 145 / 9.5  
PM-17 / 145 / 9.5  
Total uncovered Storage: 158,000 sqm  
Total covered Storage: 59,800 sqm  
Total terminal area: 67.6 ha.  
Max vessel: length 225m; DWT 76000t.  
Railway access roads: 19.5 km,  
Operative capacity for 400 wagons.

**Ventspils**

**Kalija Parks**  
20a Dzintaru iela  
Ventspils  
3602  
Latvia  
Contact: Mr Dainis Treimanis  
Member of the Board  
T: + 371 636 07232

F: + 371 3625345  
E: director@kp.vcp.lv  
W: www.ventspils.lv

**Ventspils**

**JSC BALTIC COAL TERMINAL**  
39B Dzintaru Street  
Ventspils  
LV-3602  
Latvia  
Contact: Mr Ilya Sokolov  
Chairman of the Board  
T: + 371 636 34 000  
F: + 371 636 34 001  
E: info@balticcoal.com  
W: www.balticcoal.com  
Location: Latvia, Ventspils, The Baltic Sea  
Equipment & Capacity: Throughput capacity - 6 mln tons coal per year  
Bulk Berths: For ships up to 120,000dwt  
Total uncovered Storage: N/A  
Total covered Storage: Warehouse 24,000 sqm with storage up to 210,000 tonnes of coal.  
Terminal uses modern coal transshipment technologies and has covered warehouse as well conveyor galleries to prevent environmental pollution. The deepwater pier depth is 16.0m and length 350m.

**Ventspils**

**AS Ventspils Tirdzniecibas Osta**  
22 Dzintaru Street  
Ventspils  
LV3602  
Latvia  
Contact: Ms Julianna Svedenko  
Secretary  
T: +371 63668706  
F: + 371 36 68870  
E: Julianna.Svedenko@vto.lv  
W: http://www.vto.lv

**Ventspils**

**Free Port of Ventspils Authority**  
19 Jāņa Str.  
Ventspils  
LV 3601  
Latvia  
Contact: Mr Imants Sarmulis  
T: + 371 6 362 2586  
F: + 371 6 362 1297  
E: marketing@portofventspils.lv  
W: www.portofventspils.lv  
Location: East coast of the Baltic Sea, West coast of Latvia, on the coasts of the river Venta.  
Equipment & Capacity: A deepwater port with opportunities to accommodate Aframax type vessels for liquid cargoes and Panamax type vessels for dry bulk and general cargoes.  
Bulk Berths: Max draught up to 15m.  
Dry bulk terminals are Kalija parks (transshipment of mineral fertilizers); Ventspils Commercial Port (transshipment of metals, coal, ferro-alloys, grain, raw sugar); grain transshipment terminal Ventspils Grain Terminal and closed storage coal terminal Baltic Coal Terminal.

**Ventspils**

**Ventspils Grain Terminal**  
41 Dzintaru Street  
Ventspils  
LV 3602  
Latvia  
Contact: Mr Vladislavs Safranskis  
Board Chairman  
T: + 371 6 366 8802  
F: + 371 366 8850  
E: vgt@vgt.lv  
W: www.vgt.lv

## LEBANON

### Beirut

**Chekaa Bay**  
c/o Port of Beirut  
PO Box 1490  
Beirut  
Lebanon  
Contact: Mr J Khazen  
Port Director  
T: + 961 1 580211  
F: + 961 1 585835  
E: info@portdebyrouth.com  
W: www.portdebyrouth.com

### Beirut

**Port Authority of Selaata**  
c/o Port of Beirut  
PO Box 1490  
Beirut  
Lebanon  
Contact: Mr J Khazen  
Port Director  
T: + 961 1 601602  
F: + 961 1 601602

### Tripoli

**Tripoli Port Authority**  
Service d'Exploitation du Port de  
Tripoli  
Tripoli  
Lebanon  
Contact: Mr. Ahmad Taner  
Manager  
T: + 9616211775 / +9616600413  
F: + 96 16220180  
E: admin@portdetripoli.com  
W: www.tripoliport.com

## LIBERIA

### Monrovia

**National Port Authority**  
Bushrod Island  
PO Box 1849  
Monrovia  
Liberia  
Contact: Mr Fassue Kellah  
Managing Director  
T: + 231 221332  
F: + 231 226388  
E: natport@liberia.net

### Monrovia

**Monrovia Port**  
National Port Authority  
PO Box 10-18-49  
Monrovia  
1000  
Liberia  
Contact: Ms Elsie Dossen Bodio  
President  
T: + 231 221332  
F: + 231 226388  
E: natport@liberia.net

### Robertfield

**Buchanan Port Authority**  
Lamco JV Venture Operating Co  
c/o Roberts International AirPort  
Robertfield  
Liberia  
Contact: Mr D Uittenbogaard  
Chief Agent  
T: + 231 221332  
F: + 231 226388  
E: natport@liberia.net

## LITHUANIA

### Klaipeda

**State Enterprise Klaip da State Seaport Authority**  
J Janonio st. 24  
Klaipeda  
LT-92251  
Lithuania

Contact: Mr Arturas Drungilas  
Director for Marketing  
T: + 370 46 499 748  
F: + 370 46 499777  
E: a.drungilas@port.lt  
W: www.portofklaipeda.lt  
Location: Northernmost port on the Eastern coast of Baltic Sea.  
Equipment & Capacity: Mobile loaders, wheeled loaders, cranes, warehouses.  
Bulk Berths: 21 berths for bulk cargo  
Total uncovered Storage: 780,300sqm  
Total covered Storage: 368,000sqm

### Klaipeda

**BEGA, Stevedoring Company**  
Nemuno st. 2B  
Klaipeda  
LT - 91199  
Lithuania  
Contact: Mr Aloyzas Kuzmarskis  
General Manager  
T: + 370 46 395 500  
F: + 370 46 380 384  
E: bega@bega.lt  
W: www.bega.lt

Location: South-eastern coast of Baltic Sea; a good geographical location of the ice-free port of Klaipeda on the East-West trade route.  
Equipment & Capacity: 6 million tonnes of cargo a year.  
Mobile ship loaders (up to 1500 tph), cranes (120 tons), covered/uncovered rail wagons loading stations (up to 50 rail cars at a time), own trucks and locomotives etc.  
Bulk Berths: Max length - 2km; Max draught - 13m  
Total uncovered Storage: 300,000sqm  
Total covered Storage: 525,000sqm tonnes  
Specialization: dry and liquid fertilizers, agribulks; minerals, cement, soda ash etc.  
Additional services: bulk packing, cargo forwarding, ships agency

### Klaipeda

**Joint-Stock Stevedoring Company**  
Klaipedos Smelte  
Nemuno Street 24  
Klaipeda  
5804  
Lithuania  
Contact: Mr Eduardos  
Gawushkinas  
General Manager  
T: + 370 46 496306  
F: + 370 46 496246  
E: info@smelde.lt

### Klaipeda

**Vakaru krova, UAB**  
Minijos g. 180  
Klaipeda  
LT-93269  
Lithuania  
Contact: Mr Nerijus Gričius  
Director  
T: + 370 46 483 883  
F: +370 46 483 884  
E: nerijus.gricius@wsy.lt  
W: www.wsy.lt

### Klaipeda

**Klaipeda Stevedoring Company (KLASCO)**  
Zauveino Street 18  
Klaipeda  
LT-92122  
Lithuania  
Contact: Mr Vidas Kuklierius  
Senior Manager  
T: + 370 46 399031  
F: + 370 46 39 9235  
E: vidas@klasco.lt  
W: www.klasco.lt  
Location: Lithuania, South East Coast

of the Baltic Sea  
Equipment & Capacity: Into the vessel up to 1,500 mtpm, from railcars - up to 800 mtpm  
Bulk Berths: Berth length - 220m - depth - 14m  
Total covered Storage: For bulk products - 180,000 mt

## LUXEMBOURG

### Luxembourg

**Euroports Holdings S.a.r.l.**  
4th floor  
6, rue Jean Monnet  
Luxembourg  
Luxembourg  
L-2180  
Luxembourg  
Contact: Mr Richard Jennings  
Chief Commercial Officer  
T: + 352 621 555 866  
F: + 352 26 75 41 05  
E: Richard.jennings@euroports.com  
W: www.euroports.com

## MADAGASCAR

### Toamasina

**Societe d'Exploitation du Port de Toamasina**  
PO Box 492  
Toamasina  
501  
Madagascar  
Contact: Mr Pierre Marolahy  
General Manager  
T: + 261 5 32155  
F: + 261 5 335 58  
E: sept@dts.mg

## MALAYSIA

### Butterworth

**Penang Port SDN BHD**  
SBU Cargo Services  
Administration Building  
Butterworth  
Penang  
12100  
Malaysia  
Contact: Mr Haji Abdul Rahim Abu Bakar  
General Manager  
T: + 60 4 3102200  
F: + 60 4 3324414  
E: Rahim@penangport.com.my  
W: www.pgport.com.my

### Johor

**Bulk & Breakbulk Terminal**  
Johor Port Berhad  
PO Box 151  
Minjias Kontena  
Pasir Gudang  
Johor  
81707  
Malaysia  
Contact: Captain Mohd. Siim Mohd. Din  
Head of Bulk and Break Bulk  
T: + 60 7253 5888  
F: + 60 7251 0980  
E: jpb@johorport.com.my  
W: www.johorport.com.my

### Johor Baharu

**Johor Port BERHAD**  
PO Box 151  
Wisma Kontena  
Pasir Gudang  
Johor Baharu  
81707  
Malaysia  
Contact: Mr Ahmed Kamal  
Head, Corporate Communications  
T: + 60 7 253 5888  
F: + 60 7 251 0980

E: akamal@johorport.com.my  
W: www.johorport.com.my  
Location: Eastern side of the southern tip of Peninsular Malaysia  
Equipment & Capacity: Bulk/Break Bulk: 2 Gantry Cranes, 2 Level-Luffing Cranes, Continuous Chain Unloader, 2 Dedicated Conveyors (1000 tonnes/hour), Shore Cranes at up to 300 tonne capacity.  
Bulk Berths: Breakbulk:  
Berth Lighterage: 60m length, 6.0m depth, 6,500DWT displacement  
Berth W1: 110m length, 6.0m depth, 26,000DWT displacement  
Berth W2: 183m length, 11.0m depth, 39,000DWT displacement  
Berth W3: 183m length, 11.0m depth, 39,000DWT displacement  
Dry Bulk:  
Berth W4: 192m length, 12.7m depth, 78,000DWT displacement  
Berth W5: 217m length, 12.9m depth, 78,000DWT displacement  
Berth W6: 214m length, 13.0m depth, 78,000DWT displacement  
Multipurpose (Break Bulk, Dry Bulk & Container Cargo):  
Berth W7: 195m length, 13.5m depth, 80,000DWT displacement  
Berth W8: 195m length, 13.5m depth, 80,000DWT displacement  
Berth W9: 195m length, 13.5m depth, 80,000DWT displacement  
Berth W10: 195m length, 13.5m depth, 80,000DWT displacement  
Berth W11S: 230m length, 11.0m depth, 13,000DWT displacement  
Berth W11N: 120m length, 5.0m depth, 13,000DWT displacement  
Total uncovered Storage: Approximately 80,000 sqm  
Total covered Storage: Approximately 164,000 sqm  
JPB is listed on the London Metal Exchange for storage and handling of seven (7) non-ferrous metals: primary aluminium, aluminium alloy, lead, zinc, copper, nickel and tin.  
JPB runs its own Free Zone, which also has a rail depot.

### Kota Kinabalu

**Sabah Ports Authority**  
Locked Bag No 2005  
Kota Kinabalu  
Sabah  
88617  
Malaysia  
Contact: Datuk Mayong Omar  
General Manager  
T: + 60 88 538400  
F: + 60 88 223036  
E: sabport@po.jaring.my  
W: www.lpps.sabah.gov.my  
Location: East & West and North of Sabah  
Total uncovered Storage: 2,800 sqm - 26,800 sqm  
Dry bulk cargo is currently handled using grabs and hoppers provided by the cargo owners/agents.

**Kuantan**  
**Kuantan Port Consortium Son Bhd**  
PO Box 199  
Tanjung Gelang  
Kuantan  
Pahang Darul Makmur  
25720  
Malaysia  
Contact: Mr IR Ho Phea Keam  
Managing Director  
T: + 60 9 586 3888  
F: + 60 9 583 9393  
E: irpkho.kuantanport@ijm.com  
W: www.portal.kuantanport.com.my  
Location: East of Malaysia  
Equipment & Capacity: Grab Unloader  
Bulk Berths: Two - 400m  
Total uncovered Storage: 30,000 sqm  
Total covered Storage: 10,000 sqm

### Kuantan

**Kuantan Port Consortium Son Bhd**  
PO Box 199  
Tanjung Gelang  
Kuantan  
Pahang Darul Makmur  
25720  
Malaysia  
Contact: Mr IR Ho Phea Keam  
Managing Director  
T: + 60 9 586 3888  
F: + 60 9 583 9393  
E: irpkho.kuantanport@ijm.com  
W: www.portal.kuantanport.com.my  
Location: East of Malaysia  
Equipment & Capacity: Grab Unloader  
Bulk Berths: Two - 400m  
Total uncovered Storage: 30,000 sqm  
Total covered Storage: 10,000 sqm

Port Terminal handling fertilizers, mineral ores, coal, gypsum etc

### Kuantan

**Kuantan Port Authority**  
KM 25, Jalan Kuantan-Kemaman  
Tanjung Gelang  
P.O. Box 161  
Kuantan  
25720  
Malaysia  
Contact: Mr Khairul Anuar Abdul Rahman  
Chief Executive Officer/General Manager  
T: + 60 9585 8000  
F: + 60 9585 8000  
E: lpktn@lpktn.gov.my

### Kuantan

**Lembaga Pelabuhan Kuantan**  
Tanjung Gelang  
Peti Surat 161  
Kuantan  
Pahang Darul Makmur  
25720  
Malaysia  
Contact: Mr Mohamad Iramhan  
T: + 60 9 585 8000  
F: + 60 9 583 3866  
E: lpktn@lpktn.gov.my  
W: www.lpktn.gov.my

### Labuan

**Labuan Port Authority**  
W-2 Liberty Port Storage Area  
P.O. Box 81858  
Labuan  
87028  
Malaysia  
Contact: Mr C Simon  
Port Manager  
T: + 60 87 421699  
F: + 60 87 421850  
E: labuanport@lplm.com.my  
W: www.lplm.com.my

### Malacca

**Malacca Port Authority**  
Pelabuhan Tanjung Bruas  
Tanjung Kling  
Malacca  
76400  
Malaysia  
Contact: Mr Chua Yew Ling  
Port Manager  
T: + 60 6 351 1766  
F: + 60 6 351 1216  
E: arum@portsworld.com

### Miri

**Miri Port Authority**  
Jalan Miri Port  
Kuala Baram Industrial Estate  
Kuala Baram  
PO Box 1179, 98008 Miri, Sarawak  
Miri  
Sarawak  
98000  
Malaysia  
Contact: Madam Serawa Budol  
Manager, Business Development Services  
T: + 60 85 609 031  
F: + 60 8 560 4841  
E: serawab@miriport.gov.my  
W: www.miriport.gov.my  
Location: Lat 004 34' Long 114 2' 36"  
E  
Equipment & Capacity: 1 x 100t mobile harbour crane  
2 x 41t reachstacker  
9 x 3-4t, 1 x 7t and 3 x 3t forklifts  
1 x 20' spreader  
1 x 140t and 1 x 50t hydraulic truck mounted cranes  
5 x terminal tractor  
4 x 40' skeletal trailer  
1 x 40' platform trailer  
Bulk Berths: Total Length ~ 390m (6 berths of 65m length each)



Total uncovered Storage: 63,000sqm  
Total covered Storage: 5,400sqm  
Container Yard ~ 328 ground slots,  
241 TGS, Reefer points 28 TGS  
Dangerous Goods Storage ~ 200sqm

**Penang**

**Penang Port SDN BHD**  
1 King Edward Place  
Georgetown  
Penang  
10300  
Malaysia  
Contact: Mr Ahmad Ibnihajar  
Managing Director  
T: + 60 4 210 2211  
F: + 60 4 263 4792  
E: info@penangport.com.my  
W: www.penangport.com.my

**Penang**

**Prai Bulk Cargo Terminal**  
Penang Port Commission  
3A-6 Bangunan Sri Weld  
Pangkalan Weld  
Penang  
10300  
Malaysia  
Contact: Mr Noor Ariff bin Yusoff  
General Manager  
T: + 60 4 263 3211  
F: + 60 4 263 2623  
E: spps@penangport.gov.my  
W: www.penangport.gov.my

**Penang**

**Penang Port Sdn Bhd (PPSB)**  
PO Box 1204,  
No 1 King Edward Place  
Penang  
10710  
Malaysia  
Contact: Mr Suri bin Yusop  
T: + 60 4 310 2210  
F: + 60 4 2634 792 / + 60 4 2613336  
E: suri@penangport.com.my  
W: www.penangport.com.my

**Port Kelang**

**West Fertilizer Terminal Sdn Bhd**  
Lot No 55709  
Dry Bulk Terminal 2  
Persiaran Teratai, Pulau Indah  
Port Kelang  
Selangor DE  
42009  
Malaysia  
Contact: Mr Leo Bernsten  
General Manager  
T: + 60 3 31011886  
F: + 60 3 31011886  
E: enquiry@chunyuconstruction.com

**Port Klang**

**Northport (Malaysia) Bhd.**  
Jalan Pelabuhan  
North Port  
PO Box 234  
Port Klang  
Selangor Darul Ehsan  
42009  
Malaysia  
Contact: YBhg Dato' Basheer  
Hassan  
CEO/Managing Director  
T: + 60 3 3169 8888  
F: + 60 3 3169 8811  
E: info@northport.com.my  
W: www.northport.com.my

**Port Klang**

**Port Klang Authority**  
Mail Bag Service 202  
Jalan Pelabuhan  
Port Klang  
Selangor  
42005  
Malaysia  
Contact: Mr G Shanti  
Corporate Communications  
Manager

T: + 60 3 3168 8211  
F: + 70 3 3167 0211  
E: shanti@pka.gov.my  
W: www.pka.gov.my  
Location: West Coast of Peninsular  
Malaysia - 40km from Kuala Lumpur.  
Equipment & Capacity: Conveyor - 3,  
110,000t  
Bulk Berths: 6  
Total uncovered Storage: 12,935sqm  
Total covered Storage: 42,565sqm

**Pulau Indah**

**Westports Malaysia Sdn Bhd**  
P O Box 266  
Pulau Indah  
Port Kelang  
42009  
Malaysia  
Contact: Mr Nathan  
T: + 60 3 3169 4047  
F: + 60 3 3169 4119  
E: info@westportmalaysia.com.my  
W: www.westportsmalaysia.com/

**Sandakan**

**Sandakan Port Authority**  
PO Box 1368  
Sandakan  
Sabah  
90008  
Malaysia  
Contact: Mr Francis Lee Fah Hin  
Port Manager  
T: + 60 89 612 411  
F: + 60 88 22 3036  
E: info@portarea.com

**Seri Manjung**

**Lumut Maritime Terminal Sdn Bhd**  
Lekir Bulk Terminal (LBT)  
Pulau Lekir 1  
Jln Teluk Rubiah  
Seri Manjung  
Perak  
32040  
Malaysia  
Contact: Mr Amin Bin Halim Rasip  
Chief Executive Officer  
T: + 60 3 2141 7728  
F: + 60 3 2141 2995  
E: aminrasip@integrx.com.my  
W: www.lumutport.com  
Location: On a reclaimed island,  
South East of Pangkor Island, Perak,  
West Malaysia (Off the Straits of  
Malacca)  
Equipment & Capacity: 2 Grab Ship  
Unloaders with rated capacity of  
1,500mtp each and 2 import  
conveyors lines with rated capacity of  
3,800mtp each  
Bulk Berths: Total quay length about  
800m  
Total uncovered Storage: About 80  
acres (About 323,752sqm)  
Total covered Storage: Nil  
Minimum natural depth of 20m  
alongside the berth

**Sibu**

**Rajang Port Authority**  
Sibu  
Sarawak  
96000  
Malaysia  
Contact: Mr Chong Siew Yang  
General Manager  
T: + 60 84 319 009  
F: + 60 84 318 754  
E: arum@portsworld.com  
W: www.portsworld.com/Ports/  
rajangport.htm

**Terengganu Darul Iman**

**Kemaman Port Authority**  
Bangunan Demaga Timur  
Telok Kalung  
Terengganu Darul Iman  
Kemaman

24000  
Malaysia  
Contact: Mr Dato 'Tik bin Mustafa'  
General Manager  
T: + 60 9 863 1590  
F: + 60 9 863 1599  
E: arum@portsworld.com

**Utara**

**Kelang Port Management**  
Tingkat 2  
Blok A  
Bangunan Pentadbiran  
Jalan Parang pelabuhan  
Utara  
Selangor  
42005  
Malaysia  
Contact: Mr A Kanesan  
T: + 60 3 3168 8211  
F: + 60 3 3168 7626  
E: onestopagency@pka.gov.my  
W: www.pka.gov.my

**MALTA**

**Marsa**

**Port of Valletta**  
Malta Transport Centre  
Ports & Yachting Directorate  
Xatt L-Ghassara Ta'L-Gheneb  
Marsa  
MRS 1917  
Malta  
Contact: Mr David Bugeja  
Chief Officer  
T: + 356 22914 401  
F: + 356 21222 208  
E: david.bugeja@transport.gov.mt  
W: www.transport.gov.mt  
Location: Malta

**Paola**

**Kordin Grain Terminal Company Ltd**  
PO Box 25  
Paola  
PLA 01  
Malta  
Contact: Mr Alex Agius  
Chief Executive  
T: + 356 2360 4112  
F: + 356 2360 4180  
E: aagius@malta.net  
W: www.kordingrain.com.mt  
Location: Malta in Valletta port  
Equipment & Capacity: Ship unloader  
1100mtp  
Ship loader 1200mtp  
Bulk Berths: Discharging facility:  
Magazine Wharf Grand Harbour,  
Valletta. 200m length, 14m draught.  
Loading facility: Laboratory Wharf  
Grand Harbour, Valletta. 120m length,  
10m draught.  
Total uncovered Storage: 90,000t  
Total covered Storage: 88,000t  
Located in the natural deep-draught  
Valletta Harbour, Kordin is in a most  
strategic location for the handling,  
storage and transhipment of all types  
of free flowing grains reaching the  
Mediterranean

**Valletta**

**Malta Maritime Authority**  
Ports Department  
Marina Pinto  
Valletta  
01  
Malta  
Contact: Mr C V Schembri  
Port Director  
T: + 356 222679/203  
F: + 356 222208  
E: info.tm@transport.gov.mt

**MAURITANIA**

**Nouadhibou**

**Port Autonome de Nouadhibou**  
PO Box 236  
Nouadhibou  
Mauritania  
Contact: Ms Gaye Sidatt  
Harbour Director  
T: + 222 45 134  
E: contact@pan.mr  
W: www.portndb.com  
Bulk Berths: Draught 16.2m. Max  
LOA 310m. Max Beam 47m.

**MAURITIUS**

**Port Louis**

**Mauritius Ports Authority**  
PO Box 379  
H. Ramnarain Building  
Mer Rouge  
Port Louis  
Mauritius  
Contact: Mr Shekur Sintah  
Ag. Director General  
T: + 230 206 5400  
F: + 230 240 0856  
E: s.sintah@mauport.com  
W: www.mauport.com  
Location: 2,400 km off east coast of  
Africa  
Equipment & Capacity: 26 x 1t and 47  
x 3t Hyster forklifts, 7 x 5t forklifts, 3 x  
7-10t empty handlers, 16 x 25t  
Douglas prime movers, 23 x 20t and 9  
x 40t low bed trailers, 1 x 40t  
Gottwald crane.  
Bulk Berths: 6 quays with maximum  
dredged depth of -12.2m  
Total uncovered Storage: 8.05 Ha  
Total covered Storage: 17,900sqm

**MEXICO**

**Acapulco**

**Port Authority of Acapulco**  
Costera Miguel Aleman, Malecon  
Fiscal  
Col Centro  
Acapulco  
39300  
Mexico  
Contact: Mr Francisco JE Lopez  
Stiles  
Director General  
T: + 52 971 40668  
F: + 52 971 40436  
E: marketing@apiacapulcoport.com  
W: www.apiacapulcoport.com

**Altamira**

**Cooper T. Smith De Mexico SA de CV**  
Mar Negro KM 0.380  
Puerto Industrial  
Col. Puerto De Altamira  
Altamira  
Tamaulipas  
89603  
Mexico  
Contact: Mr Arturo Encinas  
General Director  
T: + 52 833 260 45 00  
F: + 52 833 260 10 82  
E: arturo.encinas@coopertsmith.com  
W: www.coopertsmith.com  
Location: Port of Altamira, Mexico  
Equipment & Capacity: Two 45-ton  
gantry cranes with the capacity to  
unload 10,000 ton/day.  
Frontloaders and railcars.

**Altamira**

**Industrial Port of Altamira**  
Altamira  
Tamaulipas  
89608  
Mexico

Contact: Ing. Jose Luis Diaz  
Covarrubias Hanun  
Director of Port Operations  
T: + 52 833 260 60 76  
F: + 52 833 260 60 70  
E: jdiaz@puertoaltamira.com.mx  
W: www.puerto-de-altamira.com.mx  
Fastest growing port in Mexico

**Altamira**

**Terminal Maritima de Altamira, SA de CV**  
Altamira  
Tamaulipas  
89608  
Mexico

Contact: Ing. Rogelio Maya  
Moncada  
Terminal Manager  
T: + 52 833 260 1138  
F: + 52 833 260 1142  
E: tmamexplus@infosel.net.mx  
W: www.atpaltamira.com.mx  
Location: Port of Altamira, Mexico  
Equipment & Capacity: 3 grab gantry  
cranes. Conveyor bands.  
Loading/unloading ships: 10,000  
ton/day.  
Loading/unloading barges: 10,000  
ton/day  
Loading/unloading trucks and railroad  
cars.  
Bulk Berths: Depth - 38 feet.  
Length - 783 feet.  
Max DWT - 55,000.  
Total uncovered Storage: 4 acre  
product storage yard.  
Total covered Storage: Grain  
warehouse: 70,000 ton capacity.  
Mineral grains warehouse: 45,000 ton  
capacity.  
Largest facility of it's type in Latin  
America.

**Chiapas**

**Port Authority of Puerto Madero**  
Interior Recinto Portuario  
Puerto Madero  
Chiapas  
96400  
Mexico  
Contact: Mr Jose Rafael Reyes  
Ruiz  
Director General  
T: + 52 962 46757  
F: + 52 962 46758  
E: info@puertomadero.com

**Ensenada**

**Port Authority of Ensenada**  
Boulevard Teniente Azueta 224  
Ensenada  
22800  
Mexico  
Contact: Mr Carlos Jauregui  
General Director  
T: + 52 64 61740396  
F: + 52 6 1740370  
E: cjaug@apiensenada.com.mx

**Garita de Otay**

**Morro Redondo Port Authority**  
Exportadora de sal SA de CV  
3a Oeste 17523-A Fracc  
Garita de Otay  
Tijuana  
BC ZP 22500  
Mexico  
Contact: Mr Orozco  
T: + 52 66 869891  
F: + 52 66 869891  
E: info@portarea.com  
W: www.portarea.com /

**Guaymas**

**Port Authority of Guaymas**  
Recinto Portuario Zona Franca  
Guaymas  
Sonora State  
85430

Mexico  
 Contact: Mr Felipe de Jesus  
 Rivadeneira y Sauri  
 Director General  
 T: + 52 622 41160  
 F: + 52 622 24743  
 W: www.puertodeguaymas.com

**La Paz**  
**San Juan de la Costa Port Authority**  
 Port Office  
 La Paz  
 A Brocado  
 Muelle y Comercio No 13  
 La Paz  
 Baja California State  
 Mexico  
 T: + 52 61 2122 7777  
 F: + 52 61 2122 7778  
 E: apibcs@prodigy.net.mx  
 W: www.bajaport.com

**Mazatlan**  
**Port Authority of Mazatlan**  
 Interior Recinto Fiscal  
 Mazatlan  
 Sinaloa 82000  
 Mexico  
 Contact: Mr Alfonso Gil Diaz  
 T: + 52 669 9823019  
 F: + 52 669 9821960  
 E: marketing@apimazatlan.com.mx  
 W: www.apimazatlan.com.mx

**Salina Cruz**  
**Port Authority of Salina Cruz**  
 Calle Miramar Esq Wilfrido C. Cruz  
 Edif  
 Capitanía de Puerto  
 Salina Cruz

70680  
 Mexico  
 Contact: Mr D Enrique Murga  
 Arroyo  
 T: + 52 971 41325  
 F: + 52 971 42675  
 E: puerto@puertosalacruz.com.mx  
 W: www.apisal.com.mx/

**San Carlos**  
**San Carlos Port Authority**  
 Calle Puerto Acapulco s/n  
 San Carlos  
 Baja California State CP 23740  
 Mexico  
 Contact: Captain Rodriguez  
 Port Captain  
 T: + 52 113 60133  
 F: + 52 113 60198  
 E: apibcs@prodigy.net.mx  
 W: www.apibcs.com/

**Tampico**  
**Port Authority of Tampico**  
 Edificio API Tampico s/n  
 Recinto Portuario  
 Tampico 89000  
 Mexico  
 Contact: Ms Ana Laura Camarillo  
 Torre  
 Commercial Manager  
 T: + 52 833 241 14 41  
 F: + 52 833 241 14 64  
 E: acamarillo@puertodetampico.com.mx  
 W: www.port-of-tampico.com.mx

**Topolobampo**  
**Topolobampo Port Authority**  
 Port Office  
 Acceso al Parque Industrial

Pesquero S. N.  
 Topolobampo  
 Sinola State 81370  
 Mexico  
 Contact: Mr Cesar Madrazo Lozano  
 Director General  
 T: + 52 686 20127  
 F: + 52 686 20494  
 E: comercial@apitopo.com.mx  
 W: www.apitopa.com.mx

**Veracruz**  
**Port Authority of Veracruz**  
 Avenida Merina Mercante 210  
 7 piso  
 Veracruz  
 91700  
 Mexico  
 Contact: Mr Juan Jose Sanchez  
 Director  
 T: + 52 229 923 2170  
 F: + 52 29 323040  
 E: acouttolem@puertoveracruz.com.mx  
 W: www.puertoveracruz.com.mx

## MOROCCO

**Casablanca**  
**Office d'Exploitation des Ports**  
 4 rue Moussa Ibnou Nussair  
 Casablanca  
 Morocco  
 Contact: Mr M Hashami  
 Marketing Director  
 T: + 212 2 317111  
 F: + 212 2 313501  
 E: administration@odep.org.ma  
 W: www.odep.org.ma

**Casablanca**  
**Port Nador**  
 c/o Marbar SA Casablanca  
 81 Avenue Houmane  
 Fegovaki, Casablanca  
 Morocco  
 Contact: Mr Adil  
 Port Director  
 T: + 212 2 224190  
 F: + 212 2265398  
 E: n\_ouakka@marsamaroc.co.ma

**El Jadida**  
**Agence Nationale Des Ports**  
 Anl Jorf Lasfar  
 Capitainerie du Port  
 Km 22, Route Duzlidia  
 El Jadida BP 407  
 Morocco  
 Contact: Mr Hamzaoui Mohamed  
 Harbour Master  
 T: + 212 2334 5180  
 F: + 212 2334 5093  
 E: hamzaoui.mohamed25@menara.ma

**El Jadida**  
**Jorf Lasfar Power Station**  
 Jorf Lasfar Energy 8P 99  
 Sidi Bouzid  
 El Jadida  
 Morocco  
 Contact: Mr Boutaib Said  
 T: + 212 3 34 5371  
 F: + 212 3 34 5375  
 E: jlec@jlec.co.ma

**Kenitra**  
**Port of Kenitra**  
 PO Box 23  
 Kenitra

Morocco  
 Contact: Mr Hanouh  
 Port Director  
 T: + 212 7 371345  
 F: + 212 7 372159

**Tangier**  
**Port of Tangier**  
 BP 305  
 Tangier  
 Morocco  
 E: m\_saabou@marsamaroc.co.ma  
 W: www.marsamaroc.co.ma

## MOZAMBIQUE

**Beira**  
**Largo dos CFM-C**  
 Porto da Beira  
 PO Box 236  
 Beira  
 Sofala  
 Mozambique  
 Contact: Mr Rui Fonseca  
 President & Chairman of the Board  
 of Directors  
 T: + 258 21431706  
 F: + 258 21313364  
 E: cirnefonseca@cfmnet.co.mz  
 W: www.cfmnet.co.mz

**Beira**  
**Cornelder de Moçambique, s.a.r.l**  
 Porto da Beira  
 PO Box 236  
 Largo dos CFM  
 Beira 150 Be  
 Mozambique  
 Contact: Mr Felix Machado  
 Sales & Marketing Manager



SILOS E TERMINAL GRANELEIRO DA MATOLA. SARL

...a gateway to Southern Africa

Ship Loading and Unloading • Silo • Road and rail unloading • Railway/Truck loading in bulk • Loading bags into trucks • Truck expedition • Bagging

Phone: (258 21) 721762/ 722770 • Fax: +258 21 721763 • Cell: +258 82 3003576

E-mail: stema@stema.co.mz • Web: www.stema.co.mz

Head Office: 729, LÍNGAMO, MATOLA  
 PO Box 1940, MAPUTO, MOZAMBIQUE





T: + 258 2332 2734/5  
F: + 258 2332 2736  
E: Cornelder.mz@teledata.mz

**Maputo**

**Portos e Caminhos De Ferro de Mozambique**

E.P Praca dos Trabalhadores  
PO Box 2158  
Maputo  
Mozambique  
Contact: Mr Alberto Elias  
Port Director  
T: + 258 21 303576  
F: + 258 21301508  
E: albertoelias@cfmnet.co.mz

**Maputo**

**Mozambique Ports and Railways - CFM**

Praca dos Trabalhadores  
Maputo  
2158  
Mozambique  
Contact: Mr Antonio Jorge Libombo  
Director  
T: + 258 21301390  
F: + 258 21301390  
E: alibombo@cfmnet.co.mz  
W: www.portmaputo.com

**Maputo**

**Grindrod Terminals - Maputo**



Praca dos Trabalhadores  
Porto de Maputo  
Maputo  
Mozambique  
Contact: Mr Mark Flynn  
Terminal Operations Manager  
T: + 258 21 720 350  
F: + 258 21 720 180  
E: markf@grindrod.co.mz  
W: www.grindrod.co.za  
Location: Port of Matola - Maputo, Mozambique.  
Equipment & Capacity: Rail wagon tipplers, conveyors, stacker/reclaimers and ship loaders. Current (2012) capacity - 6million tons pa but expanding to handle 7.3 million tons pa in 2013.  
Bulk Berths: 210m in length, can accommodate vessels up to 230m in length - depth at quayside current 12m, design 12m.  
Total uncovered Storage: 70 000sqm  
Phase 4 development will add another 20mtpa coal terminal adjacent to the existing terminal.

**Maputo**

**Maputo Port Development Company SARL**

Port Director's Building  
Port Maputo  
PO Box 2841  
Maputo  
Mozambique  
Contact: Mr Ricardo Roberts  
Commercial Manager  
T: + 258 21 313 920  
F: + 258 21 313 921  
E: ricardo.roberts@portmaputo.com  
W: www.portmaputo.com  
Location: In the South of Mozambique - Maputo City  
Equipment & Capacity: 2 mobile cranes general cargo (40&60tons) 2 gantry cranes 40tons and 2 mobile cranes 100tons each at the container terminal)  
Total uncovered Storage: 247,000sqm  
Total covered Storage: 35,000sqm  
From middle next year, covered storage will increase to 65,000sqm.

**Maputo**

**TCM - Terminal de Cabotagem de Maputo**



(Maputo Coastal Terminal)  
Avenida Mártires de Inhamitanga  
Recinto Portuário, Portão nº 4  
P.O. Box - 145  
Maputo  
Mozambique  
Contact: Nuno Lopes / Pedro Mangue  
T: +258 21 312706/7  
T: +258823293110  
T: +258.823181160  
F: +258 21 326310  
E: nuno.lopes@navique.co.mz  
E: pmangue@navique.co.mz  
W: www.ete.pt/Grupo/Empresas/TCM\_E.htm  
Location: African Southeastern Coast  
Bulk Berth Details: 300 m dockable quay; 8.5 m depth  
Total uncovered storage (sqm): 27,000  
Total covered storage (sqm): 5,000  
Shareholders include Navique (majority shareholder) and the company responsible for the ports and railways of Mozambique (CFM).

**Matola**

**Stema SA**



Lingamo, 729  
Matola  
Mozambique  
Contact: Mr Silvino Moreno  
Chief Executive Officer  
T: + 258 21 721 762 / +258 21 722770  
F: + 258 21 721 763  
E: stema@stema.co.mz  
W: www.stema.co.mz  
Location: Southern Africa, East Coast  
Equipment & Capacity: Mobile unloader 250tph, Loader 500tph  
Bulk Berths: 3 berthing Dolphin, 1 mooring Dolphin  
Total covered Storage: 25,000t in bulk. 27 silo, 1700 each

**Nacala**

**Nacala Port Authority**

Direcção nacional dos Portos  
PO Box 70  
Nacala  
Mozambique  
Contact: Mr Boaventura M Cherinda  
Port Director  
T: + 258 26 212927  
F: + 258 26 212034  
E: info@cdn.co.mz

**MYANMAR**

**Yangon**

**Yangon Port Authority**

Myanmar Ports Corporation  
PO Box No 1  
Yangon  
Myanmar  
Contact: Mr U K M Gyi  
Port Manager  
T: + 95 1 283122  
F: + 95 1 95134  
E: mpa-sad@mpmail.net.mm  
W: www.mot.gov.mm/mpa/index.html

**NAMIBIA**

**Walvis Bay**

**Namport**  
No 17 13th Road  
PO Box 361  
Walvis Bay  
Namibia  
Contact: Mr Christian Faure  
Marketing & Business Dvpt  
T: + 264 64 2082207  
F: + 264 64 2082323  
E: cfaure@namport.com.na  
W: www.namport.com

**Walvis Bay**

**Namibian Ports Authority**  
PO Box 361  
Walvis Bay 9190  
Namibia  
Contact: Mr Cliff Shikuambi  
Marketing Dept  
T: + 264 64 208 2207  
F: + 264 64 208 2323  
E: pr.assistant@namport.com.na  
W: www.namport.com  
Location: Situated on the central coastal region of Namibia  
Equipment & Capacity: 2 x 100 tonnes mobile cranes  
2 x 45 tonnes reach stackers  
1 x 42 tonnes container stacker  
1 x 42 tonnes forklift with spreader  
2 x 45 tonnes Kalmar Reach stacker

**Walvis Bay**

**Grindrod Terminals - Walvis Bay**



1st Floor Grindrod House  
174 Third Street East  
Walvis Bay 9000  
Namibia  
Contact: Adv Shakespeare Masiza  
Regional Manager  
T: + 264 271 270  
F: + 264 271 280  
E: shakespeare@grindrod.com.na  
W: www.grindrod.co.za  
Location: West coast of Africa in Namibia  
Equipment & Capacity: Conveyor belt, shiploader, rail discharge, screening plant. The facility has the capacity to handle 725 000 tons pa.  
Bulk Berths: Two Berths adjacent to facilities  
Total uncovered Storage: 47 546  
Future projects/developments - 500 000 tons pa Sulphur handling facility  
120 000 tons Fluorspar shed and 140 000 tons copper concentrate facility.

**NAURU**

**Aiwo**

**Nauru Port Authority**

P O Box 5  
Aiwo  
Nauru  
Contact: Mr B Blundell  
Marketing Manager  
T: + 674 555 4191  
F: + 674 444 7352

**NETHERLANDS**

**ANTILLES**

**Bonaire**

**Bonaire Pilots**

Fort Oradse z/n  
Bonaire  
Netherlands Antilles

Contact: Captain L O Statie  
Harbour Master  
T: + 559-717-8151  
F: + 559-717-8797

**NEW**

**CALEDONIA**

**Houailou**

**Societe des Mines du Cap Bocage**  
Presqu'île du Cap Bocage  
Box no. 18  
Houailou 98816  
New Caledonia  
Contact: Mr Stephane  
Mine Manager  
T: + 687 42 4855  
F: + 687 42 5284  
E: smcb@canl.nc  
Location: Port : Baie UGUE on East Coast of New Caledonia  
Commodities handled: Nickel Ore

**NEW**

**CALEDONIA**

**Noumea**

**Port Authority of New Caledonia**  
PO Box 14  
Avenue James Cook  
Noumea 98845  
New Caledonia  
Contact: Mr Phillipe Lafleur  
Port Manager  
T: + 687 255000  
F: + 687 283772  
E: noumeaportnc@canl.nc

**NEW**

**ZEALAND**

**Auckland**

**Onehunga Port Authority**

c/o Ports of Auckland Ltd  
PO Box 2353  
Auckland  
New Zealand  
Contact: Mr Brian Jarman  
Port Co-ordinator  
T: + 64 9 6364264  
F: + 64 9 6346599  
E: harcon@poal.co.nz  
W: www.poal.co.nz

**Auckland**

**Ports of Auckland Limited**

Sunderland Street  
PO Box 1281  
Auckland 1010  
New Zealand  
Contact: Mr Jens Madsen  
Chief Executive  
T: + 64 9 366 0055  
F: + 64 9 367 5451  
E: info@poal.co.nz  
W: www.poal.co.nz

**Auckland**

**NZ Stevedoring Co Ltd**

PO Box 1291  
Auckland  
New Zealand  
Contact: Mr R J Seamer  
T: + 649 303 4048  
F: + 649 379 4836

**Bluff**

**South Port NZ Ltd**

PO Box 1  
Bluff 9842

New Zealand  
Contact: Mr Mark O'Connor  
Chief Executive  
T: + 64 3 2128159  
F: + 64 3 2128685  
E: reception@southport.co.nz  
W: www.southport.co.nz

**Gisborne**

**Port Gisborne Ltd**  
PO Box 549  
Gisborne 3800  
New Zealand  
Contact: Mr B Tahata  
General Manager  
T: + 64 6 867 5129  
F: + 64 6 867 8084  
E: ben.t@portgisborne.co.nz

**Lyttelton**

**Lyttelton Coal Terminal**

Private Bag 501  
Norwich Quay  
Lyttelton  
Canterbury  
New Zealand  
Contact: Mr Peter Davie  
Chief Executive  
T: + 64 3328 8198  
F: + 64 3328 7828  
E: peter.davie@ipc.co.nz  
W: www.ipc.co.nz

**Mount Maunganui**

**NZL Group Limited t/a NZ**

**Marshalling & Stevedoring**

Private Bag 12506  
Mount Maunganui  
New Zealand  
Contact: Mr Tony Cousins  
General Manager  
T: + 64 7 575 4440

**Napier**

**Port of Napier Ltd**

PO Box 947  
Napier 4140  
New Zealand  
Contact: Mr Garth Cowie  
Chief Executive  
T: + 646 833 4400  
F: + 646 833 4408  
E: info@portofnapier.co.nz  
W: www.portofnapier.biz  
Location: East Coast of North Island  
Equipment & Capacity: Including 800tph conveyor. Please see website for more details.  
Bulk Berths: Cassidy Quay 250m, 2 North 200m, 2 South 200m  
Total covered Storage: 16,600sqm

**New Plymouth**

**Port Taranaki Limited**

PO Box 348  
New Plymouth 4340  
New Zealand  
Contact: Mr Roy J Weaver  
Chief Executive  
T: + 64 6 751 0200  
F: + 64 6 751 0886  
E: rweaver@porttaranaki.co.nz  
W: www.porttaranaki.co.nz  
Location: Centrally located on the West coast of New Zealand's North Island.  
For further information please refer to our website.

**Port Chalmers**

**Port Otago Ltd**

PO Box 8  
Port Chalmers  
New Zealand  
Contact: Mr Geoff Plunket  
Chief Executive  
T: + 64 3 472 7890  
F: + 64 3 472 9891  
E: pol@portotago.co.nz  
W: www.portotago.co.nz

## Ruakaka

**North Port Ltd**  
North Tugz Limited  
PO Box 26  
Ruakaka 0151  
New Zealand  
Contact: Mr Tom Greig  
Marine Services Manager  
T: + 64 9 4328452  
F: + 64 9 4328475  
E: tom@northtugz.co.nz  
W: www.northport.co.nz  
Location: North East of New Zealand East Coast  
Equipment & Capacity: Container Forklift to 36T capacity  
Bulk Berths: 3 berths @ 580m with 13.0m to 14.5m at CD  
Total uncovered Storage: 28 ha  
Total covered Storage: 5000 sqm

## Tauranga

**C3 Limited (previously Toll Owens Ltd)**  
Maritime House  
10 Rata Street  
Mount Maunganui  
Private Bag 12501  
Tauranga  
Bay of Plenty  
3143  
New Zealand  
Contact: Mr Dean Camplin  
Chief Executive  
T: + 64 7572 8972  
F: + 64 7575 2000  
E: Dean.Camplin@C3.co.nz  
W: www.c3.co.nz  
Location: New Zealand - All 13 Ports  
Equipment & Capacity: Various Stevedoring and Marshalling Equipment

## Tauranga

**Port of Tauranga Ltd**  
Sailisbury Avenue  
Mount Maunganui  
Private Bag 12504  
Tauranga 3143  
New Zealand  
Contact: Mr Mark Cairns  
Chief Executive  
T: + 64 7 572 8899  
F: + 64 7 572 8800  
E: marketing@port-tauranga.co.nz  
W: www.port-tauranga.co.nz  
Location: Bay of Plenty, North Island, New Zealand  
Equipment & Capacity: Twelve (12) Hoppers ranging in size from 300 tonne to 50 tonne capacity  
Bulk Berths: Berth no./ max length / max depth / max draught at LW:  
8 / 180m / 12.5m / 11.7m  
9 / 180m / 12.5m / 11.7m  
10 / 200m / 12.5m / 11.7m  
11 / 223m / 12.5m / 11.7m  
12 / Cement/Tanker / 12.9m / 12.0m  
Total uncovered Storage: Combined Mount Maunganui wharves and Tauranga Container Terminal: 560,000sqm  
Total covered Storage: Mount Maunganui:  
Dry Storage 31,806sqm  
Cold Storage 22,500sqm  
General Cargo/Cool Storage 6,076sqm  
Container Terminal:  
Dry Storage 37,378sqm  
Cold Storage 7,210sqm  
Port of Tauranga's land holdings total 185 hectares.

## Timaru

**PrimePort Timaru**  
PO Box 544  
Timaru  
New Zealand  
Contact: Mr Jeremy Boys  
Chief Executive  
T: + 643 6844199

F: + 643 6840351  
E: info@primeport.co.nz  
W: www.port-timaru.co.nz

## Wanganui

**Wanganui Port Authority**  
c/o Wanganui Port (2010)  
Castlecliff Wharf  
PO Box 623  
Wanganui  
New Zealand  
Contact: Mr J S M Blaikie  
Harbour Master  
T: + 64 6 3447684  
F: + 64 6 3447524  
E: john.blaikie@wanganui.govt.nz  
W: www.wanganui.govt.nz

## Wellington

**Port of Wellington**  
Port Operations  
PO Box 794  
Wellington  
New Zealand  
T: + 644 472 8912  
F: + 644 499 0720

## Westport

**Westport Harbour**  
PO Box 335  
Westport 7866  
New Zealand  
Harbour Master/ Port Manager  
T: + 64 3 788 8086  
F: + 64 3 789 6269  
E: westportharbour-nz@xtra.co.nz  
W: www.westportharbour.co.nz  
Location: Situated on the NW coast of South Island, NZ.  
Bulk Berths: Fixed coal loader 400-1,000tph. Cement 700tph.  
Total uncovered Storage: 20,000sqm

## NICARAGUA

### Managua

**Empresa Portuaria Nacional (EPN)**  
Residencial Bolonia  
De Optica Nicaraguense 1 C. al Lago y 1 C. Abajo.  
Managua  
Nicaragua  
Contact: Licenciado Virgilio Rommel Silva Munguia  
Presidente Ejecutivo  
T: + 505 266 2545/4271  
F: + 505 266 2555  
E: vsilva@epn.com.ni  
W: www.epn.com.ni

### Sandino

**Port Sandino**  
PO Box 100  
Sandino  
Leon  
Nicaragua  
Contact: Mr Oscar Vindell  
Port Manager  
T: + 505 312226  
F: + 505 312261

## NIGERIA

### Lagos

**Nigerian Ports Authority Plc**  
26/28 Marina  
Private Mail Bag 12588  
Lagos  
Nigeria  
Contact: Mr A.B Sanni  
Port Manager  
T: + 234 1 260 0620  
F: + 234 1 263 0306

### Lagos

**Lagos/Apapa**  
Nigerian Ports Authority

PO Box 12588  
Lagos  
Nigeria  
Contact: Mr A A Suleiman  
Port Director  
T: + 234 1 260 0620  
F: + 234 1 263 0306

## Port Harcourt

**Nigerian Ports Plc**  
Private Mail Bag 5043  
Basket House  
Port Harcourt  
Nigeria  
Contact: Mr Stephen Mgbakogu  
Port Manager  
T: + 234 84 300370  
F: + 234 84 335402  
W: www.nigeria-ports.com/

## Port Harcourt

**Port Harcourt**  
Nigerian Ports Authority  
PO Box 5043  
Port Harcourt  
Nigeria  
T: + 234 84 300370  
F: + 234 84 335402

## NORWAY

### Brevik

**Greenland Port Authority**  
Strømtangen  
PO Box 20  
Brevik N-3951  
Norway  
T: + 47 3593 1000  
F: + 47 3593 1011  
E: ghv@grenland-havn.no  
W: www.port.of.grenland.com

### Drummen

**Port Authority of Drammen**  
Hans Kiaersgaten 1A  
Postboks 636T  
Drummen 3041  
Norway  
Contact: Mr Einar Olsen  
Port Manager/Executive Director  
T: + 47 32 20 86 50  
F: + 47 32 20 86 51  
E: einar.olsen@drammenhavn.no  
W: www.dreammenhavn.no

### Farsund

**Elkem Aluminium Lista**  
PO Box 128  
Lista  
Farsund  
N-4551  
Norway  
Contact: Mr Trygve Lundegeard  
Shipping Manager  
T: + 47 38 39 91 00  
F: + 47 38 39 92 57  
E: trygve.lundegeard@elkem.no

### Floro

**Port Authority of Floro**  
PO Box 17  
Floro  
6901  
Norway  
Contact: Mr Arild Hovland  
Harbour Master  
T: + 47 57 75 6740  
F: + 47 57 740 916  
E: arild.hovland@floro.kommune.no

### Glomfjord

**Port Authority of Glomfjord**  
c/o Norsk Hydro AS  
Postboks 190  
Glomfjord 8160  
Norway  
Contact: Mr Erik Knutsson  
T: + 47 75 71 91 00  
F: + 47 75 71 94 15

E: erik.knutsson@yarra.com

### Husnes

**Aluminium Works Terminal**  
PO Box 85  
Husnes N-5460  
Norway  
Contact: Mr M Rosslund  
Senior Manager Soral  
T: + 47 53 47 50 00  
F: + 47 53 47 53 98

### Kirkenes

**Port of Kirkenes**  
Municipality of Sor-Varanger  
PO Box 406  
Kirkenes 9901  
Norway  
Contact: Mr Arnt Kr. Marthinussen  
Manager  
T: + 47 78 99 91 00  
F: + 47 78 99 12 00  
E: arntrk@kirkenes-havn.no

### Kristiansund

**Kristiansund and Nordmøre Port Authority**  
Astrupsgate 9  
Kristiansund  
6509  
Norway  
Contact: Mr Arnt Helge Honstad  
Harbour Master  
T: + 47 40 00 65 04  
F: + 47 71 67 14 83  
E: ahh@knhavn.no  
W: www.knhavn.no

### Larvik

**Larvik Port Authority**  
PO Box 246  
Larvik  
3251  
Norway  
Contact: Mr Jan Fredrick Jonas  
Port Director  
T: + 47 33 16 57 50  
F: + 47 33 16 57 59  
E: jfj@larvik.havn.no  
W: www.larvikhavn.vf.no

### Mo I Rana

**Mo I Rana Port Authority**  
PO Box 185  
Mo I Rana  
8601  
Norway  
Contact: Mr P Nygaard  
T: + 47 75 13 47 00  
F: + 47 75 13 47 01  
E: pa.nygaard@rana.kommune.no  
Bulk Berths: Draught 11.4m. Max LOA 250m. Max Beam 32.2m.

### Mosjoen

**Mosjoen Port Authority**  
Havnegaten 60  
Mosjoen  
8650  
Norway  
Contact: Mr Torbjorn Jorgensen  
Harbour Master  
T: + 47 75 10 18 70  
F: + 47 75 10 18 71  
E: torbjorn.jorgensen@vefsn.kommune.no

### Moss

**Port Authority of Moss**  
Moss Maritime Center  
Postboks 5020  
Moss  
N-1503  
Norway  
Contact: Mr F P Syvertsen  
Harbour Master/Managing Director  
T: + 47 69 25 10 39  
F: + 47 69 25 07 38  
E: firmapost@moss-havn.no

## Narvik

**Narvik Port Authority**  
PO Box 627  
Narvik N-8508  
Norway  
Contact: Mr Ivan Jorgensen  
Port Captain  
T: + 47 76 95 03 70  
F: + 47 76 95 03 84  
E: ij@portofnarvik.com  
W: www.portofnarvik.com  
Location: At the fjord head of Vestfjorden, North Norway  
Equipment & Capacity: LKAB Loading Facilities, 5-7000 tph  
Bulk Berths: 26 m depth, no length limit

## Narvik

**LKAB**  
Bologsgata 40  
PO Box 314  
Narvik N-8504  
Norway  
Contact: Mr Svein Ivar Sivertsen  
General Manager  
T: + 47 959 23870  
F: + 47 769 44925  
E: svein.sivertsen@lkab.com  
W: www.lkab.com  
Location: North of Norway  
Equipment & Capacity: 20 million tpa  
Bulk Berths: LOA, no limitation.  
Draught 27m. 350.000 dwt  
Total uncovered Storage: 0.8 million tons  
Total covered Storage: 0.5 million tons  
From the end of 2009 all storage will be covered. Total 1.5 million tons

## Orkanger

**Port of Orkanger**  
Thamshavn Verk A/S and Co  
PO Box 10  
Orkanger 7301  
Norway  
Contact: Mrs Anita Berre  
T: + 47 72 48 04 00  
F: + 47 72 48 19 30  
E: anita.berre@orkla-shipping.no

## Ovre

**Aardalstangen**  
Hydro Aluminium Terminal Berths  
No 1 and No 2  
PO Box 303  
Ovre  
Aardalstangen N-5870  
Norway  
Contact: Mr Johnny Hovland  
Manager Bulk Handling  
T: + 47 57 64 98 53  
F: + 47 57 64 97 53  
E: johnny.hovland@hydro.com

## Sauda

**Sauda Port Authority**  
P.O.Box 111  
Sauda 4201  
Norway  
Contact: Mr Handelan  
Harbour Master  
T: + 47 52 78 62 72  
F: + 47 52 78 15 65  
E: sauski@online.no

## Sentrum

**Oslo Port Authority**  
PO Box 230  
Sentrum  
Oslo N-0103  
Norway  
Contact: Ms Anne Sigrid Hamran  
Port Director  
T: + 47 23 49 2610  
F: + 47 23 49 2601  
E: anne.sigrid.hamran@ohv.oslo.no  
W: www.oslohavn.no  
The Port of Oslo handles over 500.000 tonnes of cement annually, and up to 200.000 tonnes of grain a year.



**Stavanger**

**Port Authority of Stavanger**  
Nedre Strandgt 51  
Stavanger  
4005  
Norway  
Contact: Mr Bjorn Helgoy  
Port Director  
T: + 47 51 50 12 00  
F: + 47 51 50 12 22  
E: bjorn.helgoy@stavanger.havn.no  
W: www.stavanger.havn.no

**Stavanger**

**Stavanger Havnesilo**  
Nedre Banegt 60  
Potsboks 1569  
Kjelvene  
Stavanger  
4004  
Norway  
T: + 47 51 89 10 45  
F: + 47 51 89 04 40

**Sundalsora**

**Hydro Aluminium Sundal A/S**  
Sundalsora  
6600  
Norway  
Contact: Mr Sigmund Elshaug  
Port Manager  
T: + 47 71 69 30 00  
F: + 47 71 69 36 07  
E: Sigmund.Elshaug@hydro.com

**Sundalsora**

**Hydro Aluminium Private Terminal**  
PO Box 51  
Sundalsora  
N-6600  
Norway  
Contact: Mr Sigmund Elshaug  
Port Manager  
T: + 47 71 69 3384  
F: + 47 71 69 36 07  
E: sigmund.elshaug@hydro.com  
Location: North West of Norway  
Equipment & Capacity: Two Portal Cranes 15 and 30 ton, 1 pneumatic unloading equipment  
Bulk Berths: 300 meter, draft : 10,40 meter high water (planned to increase draft to 13 meter)

**Svolvaer**

**Vagan**  
Vagan Havnevesen KF  
Skiagsagentur  
PO Box 121  
Svolvaer  
N8301  
Norway  
Contact: Mr Kjell Hansen  
Harbour Master  
T: + 47 76 06 79 90  
F: + 47 76 06 79 91  
E: post@vagan-havnevesen.no  
W: www.vagan-havnevesen.no

**OMAN**

**Muscat**

**Port Sultan Qaboos**  
Port Services Corporation (SAOG)  
PO Box 133  
Muscat  
100  
Oman  
Contact: Mrs Sunita Ramakrishan  
Marketing Manager  
T: + 968 24714000  
F: + 968 24714007  
E: mktg@pscoman.com  
W: www.pscoman.com

**PAKISTAN**

**Karachi**

**Bulk Trade International**  
1A Anchor House 111  
15C 4th Commercial Lane  
Zamzama  
Karachi  
75600  
Pakistan  
Contact: Mr Syed Warasat Hussain  
Director  
T: + 92 21 5833981  
F: + 92 21 5833982  
E: bti@attglobal.net

**Karachi**

**Port Muhammad Bin Qasim**  
Port Qasim Authority  
PO Box 75020  
Karachi  
75020  
Pakistan  
Contact: Captain Azhar  
General Manager  
T: + 92 21 927 2111  
F: + 92 21 473 010  
E: info@portqasim.org  
W: www.portqasim.org.pk/

**Karachi**

**Pak Shaheen Group**  
36-A/2, Lalazar, Opposite Beach  
Luxury Hotel  
Off M.T. Khan Road  
Karachi  
74000  
Pakistan  
Contact: Mr Yussuf Farrukh  
COE - Services  
T: + 92 21 3285 1800  
F: + 92 21 561 2230  
E: yfarrukh@pakshaheen.com.pk  
W: www.pakshaheen.com.pk

**PAPUA NEW**

**GUINEA**

**Alotau**

**Alotau Port Authority**  
PNG Harbours Board  
PO Box 42  
Alotau  
Papua New Guinea  
Contact: Mr John Tungapit  
Port Manager  
T: + 675 211 637  
F: + 675 611 276  
E: enquiries@pngports.com.pg  
W: www.pngports.com.pg/

**Kavieng**

**Kavieng Port Authority**  
PNG Harbours Board  
PO Box 127  
Kavieng  
New Ireland  
Papua New Guinea  
Contact: Mr S Gems  
Port Manager  
T: + 675 984 2182  
F: + 675 984 1408

**Kimbe**

**Kieta Port Authority**  
PO Box 65  
Kimbe  
Papua New Guinea  
T: + 675 935134  
E: BusinessManager.Kieta@pngports.com.pg  
W: www.pngports.com.pg

**Kimbe**

**Kimbe Port Authority**  
PO Box 65  
Kimbe  
Papua New Guinea  
Contact: Mr John Tungapit

Port Manager  
T: + 675 211 637  
F: + 675 935 609  
E: enquiries@pngports.com.pg

**Lae**

**Lae Port Authority**  
c/o PNG Harbours Board  
PO Box 563  
Lae  
Papua New Guinea  
Contact: Mr Joshua Taruna  
Regional Port Manager  
T: + 675 426 434  
F: + 675 856 2506  
E: enquiries@pngports.com.pg

**Lae**

**PNG Ports Corporation Limited**  
PO Box 563  
Lae  
Papua New Guinea  
Contact: Mr Tony Aelingian Willie  
Senior Port Manager  
T: + 675 4722477  
F: + 675 4722543  
E: tony.willie@pngharbours.com.pg  
Location: North of Australia - Lae Port is the biggest port in Papua New Guinea  
Equipment & Capacity: 30 tonnes allowed on all berths  
Bulk Berths: 400m berth length  
Total uncovered Storage: Approx 1 sq km  
Total covered Storage: Approx 0.5 sq km  
Lae Port handles Roro, Containerised, Bulk fuel Tankers, Gas Tankers, and Gen bulk vessels. Berth length up to 1 km. Port operates on 24 hours operations.

**Popondetta**

**Oro Bay Port Authority**  
PNG Harbours Board  
PO Box 160  
Popondetta  
Papua New Guinea  
Port Manager  
T: + 675 3 229 263  
F: + 675 3 223 207  
E: enquiries@pngports.com.pg  
W: www.pngports.com.pg/

**Rabaul**

**Rabaul Port Authority**  
PO Box 592  
Rabaul  
Papua New Guinea  
Contact: Mr J Taruna  
Regional Port Manager  
T: + 675 921317  
F: + 675 921367  
E: enquiries@pngports.com.pg

**PERU**

**Arequipa**

**Terminal Internacional del Sur SA**  
Tisur SA  
Puerto Matarani  
Arequipa  
Peru  
Contact: Snr Mario Hart Potesta  
T: + 51 54 9 557197  
F: + 51 54 9 557044

**Callao**

**ENAPU SA**  
Port Terminal of Callao  
Callao  
1No260  
Peru  
Contact: Mr Luis Vargas Caballero  
Cooban  
President and Chief Executive  
T: + 51 1429 9210  
F: + 51 1469 1011

E: principal@enapu.gob.pe  
W: www.enapu.com.pe

**Callao**

**Conchan Port Authority**  
Empresa Nacional de Puertos  
Terminal Maritimo  
Callao  
Peru  
T: + 51 1 429 9210  
F: + 51 1 465 6717  
W: www.cementoslima.com.pe

**Chancy**

**Chancay Port Authority**  
c/o Agencias Unidas Chancay SA  
Malecon de Puerto 248  
Chancy  
Peru  
Port Manager  
T: + 51 2095

**Ilo**

**Agencia Maritima Busonich**  
c/o Moguegua no 100  
Ilo  
Peru  
Contact: Mr Marco Busonich  
T: + 51 54 782962  
F: + 51 54 782962  
E: maritima@cosapidata.com.pe  
W: www.iconet.net.pe/enapu

**Iquitos**

**Iquitos Port Authority**  
Avenida la Marina  
Iquitos  
s/n Puchana  
Peru  
Contact: Mr Hernan Marroquin  
Talavera  
Port Manager  
T: + 51 94 251955  
F: + 51 94 252041  
W: www.enapu.com.pe

**La Caleta**

**Port Authority of Chimbote**  
Departamento de Ancash Region  
Chavin  
Malecon Grau s/n  
La Caleta  
Chimbote  
Peru  
Contact: Mr Julio Cesar Zamorano  
Calvo  
Port Manager  
T: + 51 44 323831  
F: + 51 44 321199  
E: chenapu@iconet.net.pe  
W: www.iconet.net.pe/enapu

**La Perla**

**Autoridad Portuaria Nacional**  
Av. Santa Rosa, 135  
La Perla  
Callao  
Peru  
Contact: Mr Frank Boyle Alvaro  
President  
T: 511 630 9600  
F: 511 630 9620  
E: Informes@apn.gob.pe  
W: www.apn.gob.pe

**Moquegua**

**ILO Port Terminal**  
Jr Matara  
Moquegua  
104 100  
Peru  
Contact: Mr Julio Zamorano Calvo  
Office Manager  
T: + 51 1429 9210  
F: + 51 1 465 6717  
E: info@enapu.gob.pe  
W: www.enapu.com.pe/

**Pisco**

**General San Martin Port Authority**  
Punta Pejerrey Paracas  
Pisco  
Peru  
Contact: Mr Alfredo Ibarcena Moran  
Port Manager  
T: + 51 34 532972  
F: + 51 34 532972  
W: www.enapu.com.pe

**Supe Puerto**

**Supe Port Authority**  
Giron Callao 302  
Empresa Nacional de Puertos  
Ancash Department  
Supe Puerto  
Peru  
Contact: Mr Comte Camino  
Port Manager  
T: + 51 34 364045  
F: + 51 34 364045

**Trujillo**

**ENAPU SA**  
Salaverry Port Terminal  
Calle Cordova s/n  
Salaverry  
Trujillo  
Peru  
Contact: Ms Eufrosina Hilda Santa  
Maria Rubio  
Manager  
T: + 51 4443 7359  
F: + 51 4443 7359  
E: tpsalaverry@enapu.com.pe  
W: www.enapu.com.pe

**PHILIPPINES**

**Batangas City**

**Batangas Port Authority**  
Philippine Ports Authority  
Santa Clara  
Batangas City  
Luzon Island  
Philippines  
Contact: Mr Edmond Moreno  
Manager  
T: + 63 437 231 701  
F: + 63 437 230 1604  
E: alex\_t\_cruz@ppa.com.ph  
W: www.ppa.com.ph/Port%20Profile/  
SouthLuzon/batangas/batangas.htm

**Cagayan de Oro City**

**Philippine Ports Authority**  
Philippine Port Authority  
Port District Office of Northern  
Mindanao  
Agora Gate  
Port Area  
Cagayan de Oro City  
9000  
Philippines  
Contact: Mr Bienvenido P Basco  
Port District Manager  
T: + 63 88 8562819  
F: + 63 88 8562820  
E: info@ppa.com.ph  
W: www.ppa.com.ph

**Cagayan de Oro City**

**Masao Port Authority**  
Philippine Ports Authority  
Port Management Unit  
Cagayan de Oro City  
Philippines  
Contact: Mr Felix M Barcala  
Port Manager  
T: + 63 920 8522468  
F: + 63 43 2886187  
E: pmocalapan@yahoo.com  
W: www.ppa.com.ph/



# Brand new coal terminal in Gdansk

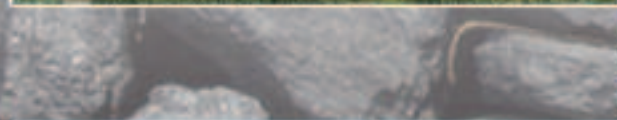

**Under construction, operational 2nd half of 2013**  
**Permissible draught: 15,00 M Baltmax**  
**2 cranes of 60 MT lifting capacity**  
**Conveyor belts: 4.000 MT / hour**  
**Reloading to train: 2.400 MT / hour**  
**Raw materials gateway to Poland and Central - Europe**



**Cebu City**

**Cebu Port Authority**  
Philippines Port Authority  
North Reclamation Area  
CIP Complex  
Cebu City  
Philippines  
Contact: Mr Manuel Gorme  
Acting Manager  
T: + 63 32 96241  
E: info@cpa.gov.ph

**Iligan City**

**Iligan Port Authority**  
Philippine Ports Authority  
Port Area, Iligan City  
Philippines  
Contact: Mr E L Delacruz  
Port Manager  
T: + 63 76 621013  
E: ppailigan@yahoo.com

**Iloilo City**

**Iloilo Port Management Office**  
Philippine Ports Authority  
Bgy Loboc, La Paz  
Iloilo City  
Iloilo Province  
Philippines  
Contact: Mr Christian B Santillan  
Manager  
T: + 63 33 76945  
F: + 63 33 76945  
E: info@ppa.com.ph

**Jolo Sulu**

**Jolo Port Authority**  
Philippine Ports Authority  
Jolo Sulu  
Philippines  
Contact: Mr Sisali B Arap  
Manager PMO-Jolo  
T: + 63 2 914  
E: info@ppa.com.ph

**La Union**

**San Fernando Port Authority**  
Philippine Ports Authority  
Port Management Office  
San Fernando  
La Union  
Luzon Island  
Philippines  
Contact: Mr Adolfo Amor Junior  
Port Manager  
T: + 63 72 412557  
F: + 63 72 415580

**Legazpi City**

**Lagazpi Port Management Authority**  
PMO Legazpi  
Pier Site  
Legazpi City  
4500  
Philippines  
Contact: Ms Hazel A Garchitorena  
Acting Terminal Supervisor  
T: + 63 522 480 7890  
F: + 63 522 480 7890

**Makati City**

**Mariveles Port-Smithbell & Co**  
Smith Bell Building  
2294 Pasong Tamo Extension  
Makati City  
1231  
Philippines  
T: + 63 2 816 7851  
F: + 63 2 813-6949  
E: ho@smithbell.com.ph

**Makati City**

**Wilhelmsen-Smith Bell Shipping, Inc.**  
2294 Pasong Tamo Extension  
Makati City  
1231  
Philippines  
Contact: Mr Fausto R Preysler Jr

President & Chairman  
T: + 63 2 8167851 to 58  
F: + 63 2 8150199 / + 63 2 8136949  
E: preysler@smithbell.com.ph  
W: www.smithbell.com.ph

**Manila**

**Philippine Ports Authority**  
Port Management Unit  
Bonifacio Drive  
South Harbour  
Manila  
Philippines  
Contact: Atty. Oscar M Sevilla  
General Manager  
T: + 53 321 3373  
F: + 53 325 7244  
E: gm@ppa.com.ph  
W: www.ppa.com.ph

**Manila**

**Mariveles Grain Terminal (MGT)**  
A. Bonifacio Drive Port Area  
Manila  
Bataan  
1018  
Philippines  
Contact: Mr Ruel S Lagtapon  
AVP & Terminal Manager  
T: +632 528-6000  
F: +632 527-3647  
E: ruell@asianterminals.com.ph  
W: www.asianterminals.com.ph

**Manila**

**Asian Terminals Incorporated**  
A Bonifacio Drive  
Port Area  
South Harbor  
Manila  
Philippines  
Contact: Mr Suhail Al Banna  
Executive Vice President -  
Technical  
T: + 63 2 528 6000  
F: + 63 2 527 2467  
E: webmaster@  
asianterminals.com.ph  
W: www.asianterminals.com.ph

**Tacloban**

**Philippine Ports Authority**  
Brgy 1 & 4, Port Area,  
Tacloban City  
Tacloban  
Leyte 6500  
Philippines  
Contact: Mr Dominador D. Licayan  
Port Manager  
T: + 63 53 321 6704  
F: + 63 53 325 7248  
E: pmotacloban@ppavis.com  
W: www.ppavis.com  
Location: Lat 11° 15' N ; Long 125°00'  
E.. The port is located on the NE of  
Leyte Island and is the regional  
capital of Eastern Visayas.  
Equipment & Capacity: Crane - 25t  
Bulk Berths: Length 813m, Draught  
along berth 5.78m below MLLW  
Total uncovered Storage: 4,459sqm  
Total covered Storage: 576.60sqm

**POLAND**

**Gdansk**

**Port of Gdansk Authority SA**  
Zamknietna 18  
Gdansk  
Pomeranian 80-955  
Poland  
Contact: Mr Julian Skelnik  
Foreign Relations, Mrlking &  
Promo. Director,Proxy  
T: + 48 58 737 99 00  
F: + 48 58 737 99 02  
E: julian.skelnik@portgdansk.pl  
W: www.portgdansk.pl  
Location: Centre of the Southern  
Coast of the Baltic Sea



Equipment & Capacity: Cranes from 3.2 t to 25t. Conveying systems, defrosting systems, automated sampling machines, railcar tippers, railway sidings etc.  
Bulk Berths: PORT FREE ZONE: Area 31 ha; Warehouses area 38,553sqm, Warehouses capacity 32,000t, Open stores 113,400sqm, Cranes from 6 to 16t.  
OLIWSKIE QUAY: Warehouses area 30,000sqm, Warehouses capacity 15,000t, Elevator 5,000t, Open stores 35,534sqm, Cranes from 6 to 16t.  
WISLANE QUAY- cranes from 6 to 25t,  
Warehouses area 19,727sqm, Grain elevator 8,500t, Open stores 91,307sqm, 2 bunkers 3,945sqm.  
PRZEMYSLOWE QUAY - cranes 3t, Warehouses area 11,839sqm, Warehouses capacity 75,000t.  
CHEMIKOW QUAY - cranes 8t and gantry cranes 20t, warehouses capacity 75,000t.  
RUDOWE QUAY - cranes from 8 to 25t, Open stores 34,610sqm, 2 bunkers 5,093sqm.  
WEGLOWE QUAY - cranes from 8 to 25t, 5 bunkers 12,583sqm.  
OBRONCOW POCZTY POLSKIEJ QUAY - cranes from 3.2 to 6.3t, open stores 20,000sqm.  
COAL TERMINAL - Open stores 17,355sqm, 5 bunkers 73,085sqm.  
In Port of Gdansk there are acceptable the vessels with the following parameters: up to 400m in length and 15m draught.  
Total uncovered Storage: 549,525sqm  
Total covered Storage: 107,022sqm  
The Port of Gdansk is situated at the intersection of the principal European transport routes, providing the most convenient connection between both Central and Eastern Europe and Scandinavia as well as between Western and Eastern Europe.

**Gdansk**

**Port Polnocny Sea-invest**

**SEA-invest**  
Skaldenstraat 1  
9042 GHENT - BELGIUM  
T: +32 9 255 02 11  
W: info@sea-invest.be  
W: www.sea-invest.com  
Dry bulk distribution and storage centre for import, export and transshipment of raw materials. Mainly coal and iron ore, but also all kind of dry bulk cargoes. Two jetties each with a draught of 15m, allowing for the loading and unloading vessels of up to 150,000dwt. Two cranes, each with a lifting capacity of 50 tonnes. Two maritime shiploaders, able to load Capesize vessels. One train loading station. Five stacker/reclaimers. 32 ha stockpiling area. Up to date environmental equipment.

**Gdansk**

**PPS Port Polnocny Co Ltd**  
23 Budowniczych Portu Polnocnego Str  
Gdansk 80-601  
Poland  
Contact: Mr Andrzej Kasprzak  
President  
T: + 48 58 737 60 52  
E: polnocny@portgdansk.pl  
W: www.portgdansk.pl

**Gdynia**

**Baltic Bulk Terminal Ltd**  
Gdyni, Poland  
Contact: Mr Roman Malow  
Operations Director  
T: + 48 58 621 57 53  
F: + 48 58 621 55 34  
E: bbm@bbm.gdynia.pl  
W: www.bbm.gdynia.pl

**Gdynia**

**Baltic Ports Organization Secretariat**  
c/o Actia Forum, Gdynia 81-368  
Poland  
Contact: Mr Bogdan Oldakowski  
Secretary General  
T: + 48 58 627 24 67  
F: + 48 58 627 24 27  
E: bpo.office@actiaforum.pl  
W: www.bpoports.com

**Gdynia**

**Baltic Grain Terminal**  
Indyjska 2 Street  
Gdynia 81-336  
Poland  
Contact: Mr Marek Kwiatkowski  
Logistics Director  
T: + 48 58 627 4372  
F: + 48 58 621 5544  
E: btztrade@btz.gdynia.pl  
W: www.port.gdynia.pl  
Location: North of Poland; Baltic Sea  
Equipment & Capacity: 2 berth's reloaders: Buhler and Transmec; 1 mln tpa  
Bulk Berths: 2 berths: Indyjskie of 245m length and 11m depth; Norweskie of 115m length and 8.5m depth  
Total covered Storage: 51,000t (elevator, silos and flat warehouse)  
The Terminal serves ships up to 70,000dwt

**Gdynia**

**Port of Gdynia**  
Ul Rotterdamska 9  
Gdynia 81-337  
Poland  
Contact: Mr Janusz Jaroński  
Managing Director  
T: + 48 58 627 4002  
F: + 48 58 621 6916  
E: marketing@port.gdynia.pl  
W: www.port.gdynia.pl

## Gdynia

Maritime Bulk Terminal Gdynia Ltd



ul. Węglowa 4  
Gdynia 81-341  
Poland

Contact: Mr Rinus Roose  
Manager Marketing and  
Development

T: + 48 58 627 4555  
F: + 48 58 621 5354  
E: roose@mtmg.gdynia.pl  
W: www.mtmg.gdynia.pl

Location: North of Poland on the  
Baltic Sea

Equipment & Capacity: 15 shore grab-  
hook cranes, capacity of 8, 10, 16 and  
40 tonnes, 3 self-propelled grab-hook  
cranes of the lifting capacity of 24-124  
tonnes, stationary pneumatic-  
mechanical conveyor, covered device  
for grain reloading with the electronic  
container scales, 2 weighbridges for  
wagons and 3 weighbridges for  
trucks, external parking for 122 trucks.  
Bulk Berths: - Dutch quay: length  
500m, depth 13m  
- Southern Pier of Danish quay  
(dedicated for liquid chemicals):  
length 170m, depth 9,1m  
- Swedish quay: length 444m, depth  
10,6m  
- Silesian quay: length 353m depth  
8,6m

Total uncovered Storage: 73,070sqm  
Total covered Storage: 17,055sqm  
and 20,000 m3

## Gdynia

Rudoport SA

Kpt. Z W Witolda Poinca 1

Gdynia 80-955

Poland

Contact: Dr Eng Jerzy Pasinski

T: + 48 58 6213696

F: + 48 58 6213698

E: rudoport@portgdansk.pl

Location: Poland Nord - Gdansk

Equipment & Capacity: In investing  
process

Total uncovered Storage: 140,000  
sqm (total uncovered and covered)

## Gdynia

BTDG - Baltic General Cargo  
Terminal Gdynia Ltd

Dokarów 7 St

Gdynia 81-336

Poland

Contact: Mr Jacek Dubicki

General Director

T: + 48 58 627 40 90

F: + 48 58 627 41 07

W: www.btdg.pl

## Kolobrzeg

Port Authority of Kolobrzeg

c/o Polish Baltic Shipping Co

ul Portowa 41

Kolobrzeg 78-100

Poland

Contact: Mr W Grzeszniek

Director

T: + 48 94 352 5211

F: + 48 94 352 6612

E: info@polferries.pl

W: www.polferries.pl

## Police

Port Police

Zakłady Chemiczne 'Police' S.A.,

ul. Kuznicka 1,

Police 72-010

Poland

Contact: Mr Roman Polak

Port Manager

T: + 48 91 317 4330

F: + 48 91 317 1519

E: rpolak@zchpolice.com

W: www.polfracht.pl/polfracht/

psal/localinf/police/portpoli.htm

Location:  $\phi = 53^{\circ}33,7' N$   $\lambda =$

$014^{\circ}35,4' E$

Total uncovered Storage: 15 tys. m2

Total covered Storage: N/A

## Swinoujscie

Port Handlowy Swinoujscie Sp. z  
o.o.

ul. Bunkrowa 1

Swinoujscie

Zachodniopomorskie 72-602

Poland

Contact: Mr Lukasz Przyszlak

Trade & Marketing Director

T: + 48 91 32 77 524

F: + 48 91 32 77 520

E: lukasz.przyszlak@phs.com.pl

W: www.phs.com.pl

Location: North West of Poland on the  
Baltic Sea

Equipment & Capacity: 9 shore  
cranes (10-140 ton capacity), 1 coal  
loading device, Coal Terminal, Cereal  
Terminal, Iron Ore Terminal, Biomass  
Terminal

Bulk Berths: 4 berths

Total uncovered Storage: 156,235sqm

Total covered Storage: 23,930sqm

Max ships' draught 13,2m, port's  
annual handling potential ca 12 million  
tons

## Szczecin

Bulk Cargo - Port Szczecin Sp.

z.o.o.

Gdanska 21

Szczecin

Zachodniopomorskie 70-661

Poland

Contact: Mr Bogdan Walczak

Marketing Director

T: + 48 91 4 307 112

F: + 48 91 4 307 115

E: bwalczak@bulkcargo.com.pl

W: www.bulkcargo.com.pl

Location: At the mouth of the Odra

river, the 65 km from the coast of the

Baltic Sea, at the crossroads of

transport routes from north to the

south of Europe

Equipment & Capacity: Stationary  
cranes x 31, Mobile cranes x 14,  
Loaders x 14, Bulldozers x 5, Fork-lift  
trucks x 42, Locomotive x 3, Wheel  
tractors x 12, Conveyors x 20, Trailers  
x 22.

Bulk Berths: 11 quays available.  
From 188m - 525m length and 6.4m -  
9.15m depth

Total uncovered Storage: 300,000sqm

Total covered Storage: 40,000sqm

We are the most multipurpose  
stevedoring company with  
comprehensive storing and reloading  
offer covering all groups of cargoes.

## Szczecin

Szczecin and Swinoujscie

Seaports Authority

ul Bytomska 7

Szczecin 70-603

Poland

Contact: Mrs Katarzyna Malinowska

Manager of Marketing Division

T: + 48 914 308 139

F: + 48 914 624 145

E: k.malinowska@port.szczecin.pl

W: www.port.szczecin.pl

Location: North-west Poland, close to

Germany border. The port of

Swinoujscie is situated just on the

Baltic coast. The port of Szczecin is

situated alongside the arms of the

Odra River - up-land 65km from the

sea.

Equipment & Capacity: Świnoujscie: 1  
x 40t and 1 x 25t gantry crane, 2 grab  
gantry cranes of 20t capacity,  
shiploader of 2 000tph capacity, 2  
wagon tippers and defreezing station  
and a belt conveyors system.

Szczecin: 1 x wagon tipper and  
1,000tph shiploader. 2 cranes and 7  
telescopic ship loaders.

Loading/discharging of vessels at max  
rate of 10,000tpd for grain and  
3,500tpd for feed.

Bulk Berths: Swinoujscie: Bulk  
carriers up to 270m in length, 13,2m  
draught

Świnoujscie quays: Górników (245m  
long, 12,8m draught), Hutników (329m  
long, 13,2m draught), Chemików  
(282m long, 12,8m draught),

Portowcow (245m long, 11,9m  
draught).

Szczecin: Vessels up to 210m in  
length and 9,15m draught

Szczecin: quays: Górnosłaskie (282m  
long, 9,15m draught), Noteckie  
(283m long, 6,4m draught), Regalica  
(210m long, 6,7m draught), Huk  
(268m long, 7,20m draught), Gliwickie  
(260m long, 9,15m draught),

Bytomskie (342m long, 9,15m  
draught), Walbrzyskie (270m long,  
8,7m draught), Pirs Węglowy (188m  
long, 9,15m draught), Chorzowskie  
(290m long, 9,15m draught),  
Katowickie (525m long, 9,15m  
draught), Parnica (320m long, 7,0m  
draught).

Grain silo quays in Szczecin:

Zbożowe quay (220m long, 9,15m  
draught), Snop (316m long, 5,8m  
draught), Bydgoskie (125m long, 5,8m  
draught), Poznańskie (80m long, 5,2m  
draught).

Total uncovered Storage: Świnoujscie:

156,000sqm of open storage for up to

700,000 tonnes of coal. An open

storage area of 70,000 tonne capacity

for iron ore.

Szczecin: 267,000 sqm. 35,000sqm  
of open storage for up to 170,000t of  
coal.

Total covered Storage: Świnoujscie:  
20,000 sqm. 100,000-tonne capacity  
warehouse with its belt conveyor  
installation.

Szczecin: 27,000 sqm

Grain silo in Szczecin: 73,000 cu m.

Silo EWA has a total capacity of

55,000t including 158 bins and 13

storeys of flat storage. There are

three other silos, of total storage

capacity over 15,000t.

The port complex of Szczecin and

Swinoujscie is of crucial significance

for Polish economics. That largest dry

bulk cargo centre at Polish sea-coast

handles nearly 50 % of the country's

coal exports and nearly 100% of its

sea-shipped iron ore imported.

## Szczecin

Andreas sp. z o.o.

St Oder 72

Szczecin 71820

Poland

Contact: Mr P Andreas

President

T: + 48 91 453 8691

F: + 48 91 421 5914

E: p.andreas@andreas.szczecin.pl

W: www.andreas.szczecin.pl

## Szczecin

Przedsiębiorstwo Usług

Portowych

Elewator EWA S-ka z.o.o.

ul Hryniewickiego 26

Szczecin 70-606

Poland

Contact: Mr Wojciech Kazmierczak

President/Director

T: + 48 91 4 308266

F: + 48 91 4 624165

E: sekretariat@elewator-

ewa.szczecin.pl

W: www.elewator-ewa.szczecin.pl

## Szczecin

Rolsped Sp. Ltd

St Wimming pool 15/17

Szczecin 70-660

Poland

Contact: Mr Krzysztof Wejt

T: + 48 91 462 3210

F: + 48 91 462 3163

W: www.rolsped.com.pl

## PORTUGAL

### Aveiro

Socarpor (Aveiro) SA

Av. Dr. Lourenço Peixinho, 15-5B

Apartado 593

Aveiro 3801-901

Portugal

Contact: Capt Ferreira Jorge

Managing Director

T: + 351 234 378 790

F: + 351 234 378 791

E: socarpor@socarpor-aveiro.pt

W: www.socarpor-aveiro.pt

Location: Port of Aveiro 40° 38,5' N

8° 44,9' W

Equipment & Capacity: Gottwald

Mobile Harbour Cranes - 65 up to 120

Mtons lifting capacity

Unloading rate 1000 Mtp

Bulk Berths: 300m of quay length

w/alongside draught up to 10m

Total uncovered Storage: 130,000sqm

Total covered Storage: 20,250sqm /

60,000 Mtons of steel silos storage

capacity

Fully environment friendly Terminal

Completely enclosed conveying

system from ship to silos and transfer

from silos to truck or rail wagon.

Monitor control room fully

computerized.

**MORSKI TERMINAL MASOWY GDYNIA**

**MARITIME BULK TERMINAL GDYNIA Ltd**

We offer our customers:

- 4 berths total length 1700 metres
- 75,000 m<sup>2</sup> open storage area
- 17,400 m<sup>2</sup> covered storage area
- 21 cranes lifting capacity 8 - 124 tonnes
- electronic scales for wagons and trucks
- highly qualified staff

**RELIABLE PARTNER IN BUSINESS**

**MARITIME BULK TERMINAL GDYNIA Ltd**

ul. Węglowa 4, 81-341 Gdynia, POLAND

Phones: +48 58 627 43 18 , 627 45 55  
Fax: +48 58 621 53 54  
E-mail: mtmg@mtmg.gdynia.pl

Contact: Mr. Rinus Roose  
roose@mtmg.gdynia.pl

[www.mtmg.gdynia.pl](http://www.mtmg.gdynia.pl)







1349-026 Lisboa  
 Portugal  
 Contact: Ms Sandra Rodrigues  
 Commercial Relations  
 T: + 351 21 3611026 / 5  
 F: + 351 21 392 2041  
 E: srodrigues@portodelisboa.pt  
 W: www.porto-de-lisboa.pt  
 Location: In the Tagus estuary.  
 Equipment & Capacity: Dry bulk cargo; more than 5,200,000t last year, of which 3,550,000t were agri-bulk.  
 Bulk Berths: The port of Lisbon has several specialised terminals for dry bulk cargo on both banks of the Tagus.  
 The port of Lisbon is a natural port, opened throughout the whole year. Please see our website www.porto-de-lisboa.pt for more information.

**Setubal**  
**Junta Autonoma Do Porto De Setubal**  
 Pracaj De Replublica  
 Setubal 2900  
 Portugal  
 Contact: Mr Antonio Reairo  
 T: + 351 265 235 667  
 F: + 351 265 534 622  
 E: suporte@mail.telepac.pt  
 W: www.cidadevirtual.pt

**Setubal**  
**Sadomar**  
 Rua Praia Da Saude 231  
 Setubal 2900  
 Portugal  
 Contact: Mr Jose M Sardinha  
 T: + 351 65 2908  
 F: + 351 65 523 002

**Sines**  
**Porto de Sines SA**  
 Apartado 16  
 Sines 750-953  
 Portugal  
 Contact: Ms Anna-Rita Rosa  
 Marketing  
 T: + 351 269 860 600  
 F: + 351 269 860 790  
 E: ana.rosa@portodesines.pt  
 W: www.portodesines.pt

**Trafaria**  
**Trafaria Terminal - Silopor**  
 Rua das Matas Nacionais  
 Trafaria 2825-867  
 Portugal  
 Contact: Mr Francisco Belo  
 Manager  
 T: + 351 21 392 33 50/360  
 F: + 351 21 290 52 45  
 E: francisco.belo@silopor.com  
 W: www.silopor.pt  
 Location: South Bank of Tagus River

at Lisbon's Harbour  
 Equipment & Capacity: Discharge: 3 Pneumatic mobil shipunloaders with a rate of 1,000tph each.  
 Loading: Sea Going Vessels and Barges with a rate of 2, 000tph  
 Loading Trucks: 7 000tpd  
 Bulk Berths: Two intake quays for ships with 20m and 18m depths respectively, able to receive ships up to 100000 dwt.  
 Total uncovered Storage: Not applicable  
 Total covered Storage: 200,000 Tons in Vertical storage with 114 separated Vertical Bins  
 HACCP and SGSA Implemented  
 NP EN ISO 22000:2005 Certified

**Vila Franca de Xira**  
**Alhandra Terminal- Cimpor Industria de Cimentos SA**  
 Centro de Produção de Alhandra - Praçeta Teófilo de Araújo Rato,

Apartado 1  
 Vila Franca de Xira  
 2601-908 Alhandra  
 Portugal  
 Contact: Dr Ana Cristina Ascenso  
 T: + 351 21 940 87 00  
 F: + 351 21 940 87 33  
 E: aascenso@cimpor.com  
 W: www.cimpor.pt  
 Location: Lisbon (Located on the north bank in the Tagus River)  
 Equipment & Capacity: Installed handling capacity: 430,000tpa  
 Equipment: Loading station for bulk - 300tph  
 Bulk Berths: Length of Quay: 177m  
 Depth: -5m ZH  
 Total uncovered Storage: Licensed Area: 80,705sqm  
 Solid bulk cargo, destined for the production of cement, is handled at this terminal. Solid bulk cargo, destined for the production of cement, is handled at this terminal.



**PUERTO RICO**

**San Juan**

**Port of Ponce**  
 Port of the Americas Authority  
 PO Box 362350  
 San Juan  
 00936-2350  
 Puerto Rico  
 Contact: Mr Thomas E Kierce  
 Communications Management  
 Consultants  
 T: + 1 787 274 8181  
 F: + 1 787 274 0140  
 E: cmcorporation@cmc-pr.com  
 W: www.portoftheamericas.com

**San Juan**

**Puerto Rico Port Authority**  
 PO Box 362829  
 San Juan  
 PR 009366-2829  
 Puerto Rico  
 Contact: Mr Herman Sulsona

Executive Director  
 T: + 1 787 29 8480  
 F: + 1 787 22 7867

**QATAR**

**Doha**

**Umm Said Ports Authority**  
 Mesaieed  
 PO Box 313  
 Doha  
 Qatar  
 Harbour Master  
 T: + 974 457 457  
 F: + 974 413 563  
 E: harbourdohaport@qatar.net.qa

**Doha**

**Qatar Flour Mills Co**  
 PO Box 1444  
 Doha  
 1444  
 Qatar

Contact: Mr Tarique Mohammad  
 General Manager  
 T: + 974 4415000  
 F: + 974 4438137  
 E: qfmmgmt@qatar.net.qa  
 W: www.qatarflourmills.com

**REPUBLIC**

**OF GUINEA**

**Conakry**

**Port Autonome de Conakry**  
 PO Box 805  
 Conakry  
 Republic of Guinea  
 Contact: Mr Bangle Camara  
 Director General  
 T: + 224 412 737  
 F: + 224 412 604  
 E: pac@eti-bull.net

**Conakry**

**Direction du Port de Kamsar**  
 Office d'Aménagement -de-Boke  
 PO Box 820  
 Conakry  
 Republic of Guinea  
 Contact: Mr M.L Cisse  
 Director  
 T: + 224 163 2117  
 F: + 224 163 2116

**Conakry**

**Conakry Port Authority**  
 Direction du Port  
 PO Box 534  
 Conakry  
 Republic of Guinea  
 Contact: Mr M Ducoure  
 Harbour Master  
 T: + 224 442737  
 F: + 224 412604

**REPUBLIC**  
**OF YEMEN**

**Hodeidah**

**Hodeidah Port**  
 Yemen Red Sea Ports Corporation  
 PO Box 3183  
 Hodeidah  
 Hodeidah  
 Republic of Yemen  
 Contact: Eng. Issa A. Hashem  
 Executive Chairman  
 Chairman of the board  
 T: + 967 3 217064  
 F: + 967 3 211561  
 E: chairman@hodport.com  
 W: www.hodport.com





# DRY CARGO

## international

### SUBSCRIPTION FORM

Name ..... Position .....

Company Name .....

Address .....

Postcode ..... Country .....

Tel ..... Fax .....

Email ..... Website .....

Please state your particular area of expertise within the bulk industry .....

.....

#### Annual Subscription Rates

	<input type="checkbox"/> 1 year	<input type="checkbox"/> 2 years	<input type="checkbox"/> 3 years
UK	£170	£280	£365
Europe	£210	£355	£460
USA & ROW	£260	£445	£580

Please charge my credit card       No. of copies required .....

Cardholder's name ..... Expiry date ..... / .....

Signature  Date

I enclose a cheque for ..... payable to **Trade Publishing International Ltd**

**PLEASE COMPLETE AND FAX TO: +44 (0)1206 562566**

Dry Cargo International, Clover House, 24 Drury Road, Colchester, Essex CO2 7UX, UK

Tel: +44 (0)1206 562560 Fax: +44 (0)1206 562566 Email: [info@dc-int.com](mailto:info@dc-int.com)

Website: [www.dc-int.com](http://www.dc-int.com)



*Make sure you don't miss the next issue...*

- The world's only monthly dry bulk publication
- Five industry-specific editorial sections, with their own news and features every month
- Additional special focuses and regional reports





## REUNION

**Le Port Cedex, Reunion**

Direction Departmentale de  
L'Equipment

2 Rue Evariste de Parry  
PO Box 2002

Le Port Cedex, Reunion  
97821

Reunion

Contact: Capt M Berthelot

Harbour Master

T: + 262 420955

F: + 262 420602

## ROMANIA

**Agigea**

**Silotrans SRL**

Constanta Port - South

Agigea

Dobrogea

907015

Romania

Contact: Mr Djordje Krkijus

Silo Manager

T: + 40 241 743350

F: + 40 241 743250

E: ConstantaSilotrans@chsinc.com

W: www.chsinc.com

**Braila**

**Braila Port Authority**

Harbour Master's Office

Gara Fluviala Street

Braila

Romania

Contact: Mr Vladut Branza

T: + 40 239 612 184

F: + 40 2 39 612066

E: capitania-braila@ma.ro

W: www.rna.ro

**Constanta**

**SC MINMETAL SA Constanța /**

**Romania**

Incinta Port

Berth 64

Constanta 900900

Romania

Contact: Mr Ghebur Liviu

General Director

T: + 40 241 639 035

F: + 40 241 639091

E: office@minmetal.ro

W: www.minmetal.ro

**Constanta**

**SC Silotrans Srl**

Incinta Port Constanța Sud Mol 1S

Constanta

907015

Romania

Contact: Mrs Corina Ionescu

Economist

T: + 40 241 602290

F: + 40 241 743250

E: office@silotrans.ro

**Constanta**

**Comvex SA**

Incinta Port Dana 80-84

Constanta

900900

Romania

Contact: Mr Viorel Panait

Terminal Manager

T: + 40 241 639 016

F: + 40 241 639 010

E: viorelpanait@comvex.ro

W: www.comvex.ro

Location: Western Black Sea Coast

Equipment & Capacity: Three

Shipunloaders 50t lifting cap/2000tph

discharging cap- each. Four Stacker

reclaimers. Three barge loaders.

One Railcars loading terminal.

Bulk Berths: 18m depth

17.5m SWAD

Total uncovered Storage: 64 HA  
Up to 3.0 mil mt storage capacity  
simultaneously; sprinkler installations  
for dust control; no other restrictions  
for vessels sizes; belt conveyors  
system with high operational flexibility,  
full covered transfer points and total  
length of 22km.

**Constantza**

**Constantza Port Administration**

Incinta Port

Gara Maritima

Constantza

8700

Romania

Contact: Ms E. Ihagi

Marketing & Sales

T: + 40 241 601211

F: + 40 241 619 512

E: apmc@constantza-port.ro

W: www.constantza-port.ro

**Constantza**

**Sicim SA**

Incinta Port

Constantza

8700

Romania

Contact: Mr Adrian Neagu

Terminal Manager

T: + 40 241 677 077

F: + 40 241 639015

E: mansicim@sicim.ro

**Sulina**

**Sulina Free Zone Administration**

Port Operations Department

202 First Street

Sulina

8229

Romania

Contact: Ms Miranda Felizia

Commercial Director

T: + 402 40 543241

F: + 402 40 543294

E: office@azsulina.ro

## RUSSIA

**Arkangelsk**

**Port of Arkangelsk**

52 Triotsky Prospect

Arkangelsk

163000

Russia

Contact: Mr V N Titov

General Director

T: + 7 8182 210 580

F: + 7 8182 657 724

E: port@ascp.ru

W: www.ascp.ru

**Kaliningrad**

**Transmarine**

Kaliningrad Portovaya 24

Kaliningrad

Russia

Contact: Mr Nikolai Apekhtin

Managing Director

T: + 7 4012 632 256

F: + 7 4012 632 210

E: na@transmarine.ru

W: www.transmarine.ru

**Moscow**

**Port Management Company Ltd**

Gagarinsky per. 33

Moscow

119002

Russia

Contact: Mr Alexander Aliev

Department Chief

T: + 749 5735 4331

F: + 749 5735 4331

E: aar@portmc.ru

W: www.vpnet.ru/

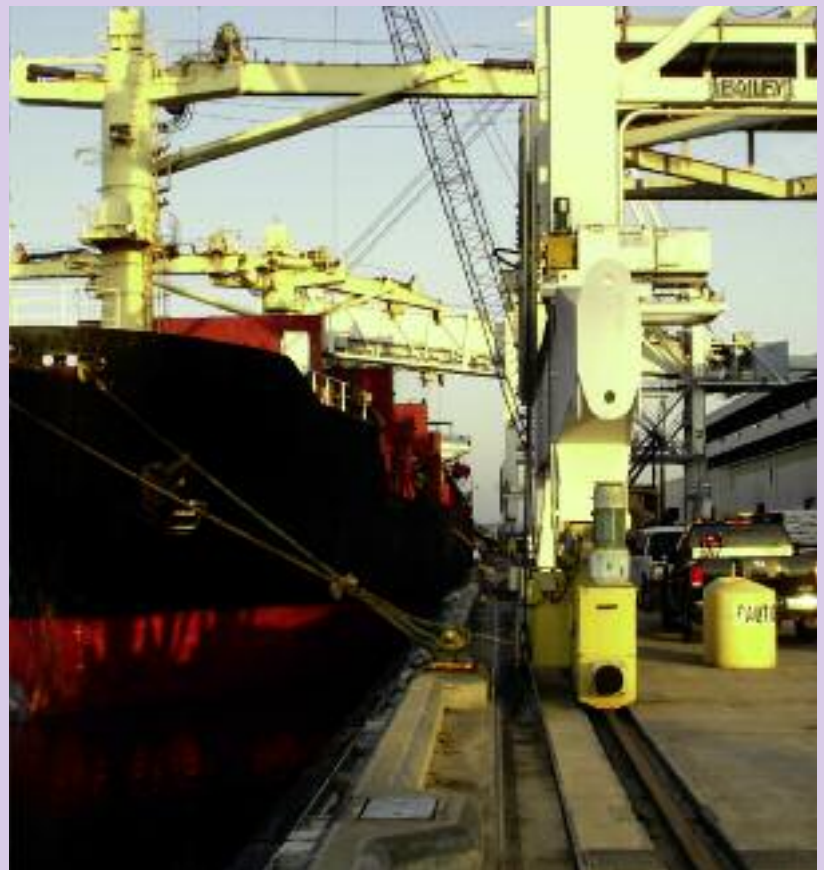
**Murmansk**

**Port of Murmansk Authority**

Portoviy Proezd 19

Murmansk

183024

Russia

Contact: Mr Dmitriev Alexander

Harbour Master

T: + 7 8152 689 111

F: + 7 8152 423 127

E: mmt@mmtp.ru

W: www.murmansk.ru

**Nakhodka**

**Nakhodka Port Authority**

22 Port Street

Nakhodka

Primorsky Krai

692900

Russia

Contact: Mr Nikolay L. Pesotsky

Commercial Director

T: + 7 4236 6198 35

F: + 7 4236 6198 00

E: nikolay.pesotsky@ncsp.ru

W: www.ncsp.ru

**Nakhodka**

**VP- Vostochny Port**

Wrangel-1

Nakhodka

Primorsky Krai

692941

Russia

Contact: Mr Sergey N. Kushnarev

Chief of Marketing and Logistiks

Department

T: + 7 4236 665 271

F: + 7 4236 665 153

E: vp@vpnet.ru

W: www.vpnet.ru

Location: Far-East of Russia

**Novorossiysk**

**Novorossiysk Port Authority**

2, Mira str.

Novorossiysk

Krasnodar Region

353900

Russia

Contact: Mr Georgiy Antonyan

Harbour Master

T: + 7 8617 602 516

F: + 7 8617 676 378

E: referent@nle.ru

W: www.nle.ru

**St Petersburg**

**Seaport of St Petersburg JSC**

Mezhevoy Kanal 5

St Petersburg

198035

Russia

Contact: Ms Alexandra Chaschina

Specialist of Department of PR and

Advertising

T: + 7 812 714 91 25

F: + 7 812 714 94 98

E: a.chaschina@seaport.spb.ru

W: www.seaport.spb.ru

Location: North West Russia on the

Baltic Sea

Equipment & Capacity: 56 gantry

cranes up to 40 tons hoisting capacity,

a floating crane of 300 tons capacity,

2 Liebherr mobile rubber-tyred cranes

LHM 600 with the lifting capacity up to

140 tons, 1 truck-mounted crane with

the lifting capacity of 55 tons, 244

different specialized loading

mechanisms.

Bulk Berths: 32 berths in disposal with

total length 5,3 km and draught up to

11.5m

Total uncovered Storage: 412,000sqm

Total covered Storage: 46,000sqm

The JSC "Seaport of St. Petersburg"

is the largest operator providing dry

cargo transshipment in Saint-

Petersburg port and the North-West of

Russia.

**Tuapse**

**Port of Tuapse Authority**

8 Gorkogo Street

Tuapse

352800

Russia

Contact: Mr O Antonov

General Director

T: + 7 86167 76 4 00

F: + 7 86167 76 4 03

E: map@tuapseport.ru

W: www.tuapseport.ru

**Ulgorsk**

**Ulgorsk Port Authority**

Primorskaya ul 7

Ulgorsk

Russia

Port Manager

T: + 7 42432 21771

**Vanino**

**Vanino Commercial Sea Port,**

**PJSC**

1 Zheleznodorozhnaya Str.

Vanino

Khabarovsk Territory

682860

Russia

Contact: Mr Apollon Shengeliya

General Director

T: + 7 421 37 5 09 23

F: + 7 872 140 26 10

E: market@vcsp.ru

W: www.vcsp.ru

**Vanino**

**Vanino Port Authority**

FEPCO, Khabarovsk Krai

Ul Zheleznodorozhnaya 1

Vanino

682860

Russia



- ▲
- Angola
- Anguilla
- Antarctica
- Antigua & Barbuda
- Argentina
- Australia**
- Bahamas
- Bahrain
- Benin
- Brazil
- ▼

# Click GAC Shipping

## for the bulk of your business

From Australia to Middle East, India to Argentina, South Africa to Europe, traders are managing their supply chains more efficiently thanks to GAC Shipping. Our presence locally is helping them reduce costs globally, thanks to faster port turnaround and better coordination on shore. Click for everything from port agency to landside services like stevedoring, storage, customs clearance and cargo forwarding. It's another world-class solution from GAC—available in over a thousand locations on earth.

[www.gac.com](http://www.gac.com)



wherever you go



Marketing Director  
 T: + 7 4232 495 222  
 F: + 7 4232 222364  
 E: office@gavmp.vladivostok.ru  
 W: www.vladcomport.ru

**Vyborg**  
**Port of Vyborg Authority**  
 Ulitsa Yuzhny Val 1  
 Vyborg  
 188900  
 Russia  
 Contact: Mr Ovechkin  
 Harbour Master  
 T: + 7 812 782 0477  
 F: + 7 812 783 2485  
 E: mapvyb@vbg.spb.ru

**SAUDI**

**ARABIA**

**Dammam**  
**Arabian Agricultural Services (ARASCO)**  
 Dammam - Al-Khobar, Coastal Road  
 PO Box 6977  
 Dammam  
 Eastern  
 31452  
 Saudi Arabia  
 Contact: Mr Abdulaziz Abdulla Al-Fayez  
 Logistic President  
 T: + 966 3 859 1171  
 F: + 966 3 859 4474  
 E: a.alfayez@arasco.com  
 W: www.arasco.com

**Dammam**  
**Ras Al Mishab**  
 c/o Gulf Agency Company Saudi Arabia



PO Box 335  
 Dammam  
 31411  
 Saudi Arabia  
 Contact: Mr Abdulla Al-Havage  
 Port Manager  
 T: + 966 3 832 8762  
 F: + 966 3 832 3035  
 E: dammam@gacworld.com

**Dammam**  
**King Abdul Aziz Port Authority-Dammam**  
 PO Box 28062  
 Dammam  
 Eastern Province  
 31437  
 Saudi Arabia  
 Contact: Mr Abdullah Alhammad  
 Deputy Port Director  
 T: + 966 3 858 3500  
 F: + 966 3 858 3945  
 E: kaap@ports.gov.sa  
 W: www.ports.gov.sa

**Jeddah**  
**Jeddah Islamic Port**  
 PO Box 9285  
 Jeddah  
 21188  
 Saudi Arabia  
 Contact: Mr Sahir M Tahlawi  
 Port Director General  
 T: + 966 2 647 1200 ext 2121 / 6477702  
 F: + 966 2 647 7411

E: jip@ports.gov.sa  
 W: www.ports.gov.sa  
 Location: Red Sea Port, west coast of Saudi Arabia  
 Equipment & Capacity: 19 unloaders, pneumatic and mechanical, 100 - 600tph capacity  
 Bulk Berths: 5 x 250m long, 11.5 - 13.5m draught, 2 x 181m, 10.4 - 11.5m draught  
 Total uncovered Storage: No storage of grains in open area  
 Total covered Storage: 120,000t silos  
 In addition, 2 unloaders should be in service within one year.

**Jeddah**  
**AJWA Port Services Co.**  
 PO Box 16645  
 Jeddah  
 21474  
 Saudi Arabia  
 Contact: Mr Saleh N Al-Fadhli  
 General Manager  
 T: + 966 264 712 50  
 F: + 966 264 704 25 / 906 06  
 E: snalfadhli@ajwa.com  
 W: www.ajwagroup.com  
 Location: Jeddah Islamic Port and Yanbu Commercial Port.  
 Both ports along the Red Sea coast of Saudi Arabia  
 Equipment & Capacity: 5 Grain ship-unloaders: capacity from 200 to 400tph at Jeddah & Yanbu. A large fleet of different cargo handling equipment including 1x 100 ton swl mobile harbor crane at Yanbu Commercial Port.  
 Bulk Berths: Ajwa grain silos opp. Berth # 03 in Jeddah and 7 berths in Yanbu.  
 Maximum draught at Yanbu is 14m.  
 Total uncovered Storage: 450,000sqm in Yanbu.  
 Total covered Storage: 65,000sqm of shed & warehouse storage and 40,000t of vertical silos for dry bulk cargo storage in Yanbu. Bulk grain

storage capacity at Jeddah port is 120,000t.  
 Ajwa handles bulk grain at Jeddah port. At Yanbu port cargo handled includes containers, general, bulk, Ro-Ro & live-stock, while transshipment cargo enjoys 3 months demurrage free storage.

**Jizan**  
**Jizan Port Management**  
 PO Box 16  
 Jizan  
 Saudi Arabia  
 Contact: Mr Abdul Hamid Saaddi  
 Director General  
 T: + 966 7 317 1000  
 F: + 966 7 317 0777  
 E: info@ports.gov.sa

**Yanbu**  
**Yanbu Commercial Port**  
 Yanbu Port Management  
 PO Box 1019  
 Yanbu  
 Al Bahr  
 Saudi Arabia  
 Contact: Mr A R Al-Khateeb  
 Port Director  
 T: + 966 4 322 1163  
 F: + 966 4 322 7643  
 E: info@ports.gov.sa

**SENEGAL**

**Dakar**  
**Port Autonome de Dakar**  
 21 Boulevard de la Liberation  
 PO Box 3195  
 Dakar  
 Senegal  
 Contact: Mr Souleye Sall  
 Port Director  
 T: + 221 234545  
 F: + 221 233606  
 E: pad@portdakar.sn

**SEYCHELLES**

**Victoria**  
**Seychelles Ports Authority**  
 PO Box 47  
 New Port  
 Mahe Quay  
 Victoria  
 Seychelles  
 Contact: Captain Daniel Hoareau  
 Harbour Master  
 T: + 248 224701  
 F: + 248 224004  
 E: enquiries@seychellesports.sc  
 W: www.spa.sc

**SIERRA**

**LEONE**

**Cline Town**  
**Sierra Leone Port Authority**  
 PM Bag 386  
 Cline Town  
 Freetown  
 Sierra Leone  
 Contact: Mr Helmut Friedrichs  
 General Manager  
 T: + 232 22 250 111  
 F: + 232 22 250 616

**Freetown**  
**Pepel**  
 c/o Marampa Iron Ore Mining Co  
 PO Box 735  
 Freetown  
 Sierra Leone  
 Harbour Master  
 T: + 232 24542

**Freetown**  
**Sierra Leone Ports Authority**  
 Queen Elizabeth II Quay  
 PO Box 386  
 Freetown







[www.bulkconnections.com](http://www.bulkconnections.com)

**Bulk**

*connections*







Sierra Leone  
 Contact: Capt P Schiffard  
 Director of Operations  
 T: + 232 22 250111  
 F: + 232 22 250616

**SINGAPORE**

**Jurong Sembawang Terminal**  
 c/o Port of Singapore Authority  
 PO Box 300  
 PSA Building Post Office  
 Jurong  
 0511  
 Singapore  
 Contact: Ms Karyn Yap  
 Marketing Manager  
 T: + 65 274 7111  
 F: + 65 274 4677

**Singapore Jurong Port Pte Ltd**  
 37 Jurong Port Road  
 Singapore  
 619110  
 Singapore  
 Contact: Mr Achaibar Gupta  
 Senior Manager Corporate  
 Communications  
 T: + 65 6265 0666 / 66609582  
 F: + 65 6261 4359  
 E: achaibar@jp.com.sg  
 W: www.jp.com.sg

**Singapore Sin Heng Chan (Singapore) Pte Ltd**  
 Lot A 5052 Jurong Port  
 Jurong Port Road  
 Singapore  
 619111  
 Singapore  
 Contact: Mdm Poon Poay Huang  
 General Manager

T: + 65 6268 4711 ext 216  
 F: + 65 6268 5711  
 E: info@sinhengchan.com.sg  
 W: www.sinhengchan.com.sg

**Singapore Offshore Bulk Terminal Pte Ltd**  
 50, Collyer Quay  
 OUE Bayfront, #06-04  
 Singapore  
 049321  
 Singapore  
 Contact: Mr Stephen Suharya  
 Director  
 T: + 65 6534 2928  
 F: + 65 6509 5519  
 E: marketing@obt-group.com

**Singapore LD Ports & Logistics**  
 45A Club Street  
 Singapore  
 Singapore  
 Singapore  
 Contact: Mr Patrick Jourdain  
 General Manager  
 T: + 65 6576 9877  
 E: patrick.jourdain@oms.sg  
 W: www.ldportslogistics.com

**Singapore Maritime and Port Authority of Singapore**  
 460 Alexandra Road  
 # 19-00 PSA Building  
 Singapore  
 119963  
 Singapore  
 T: + 65 6375 1600  
 F: + 65 6275 9247  
 E: qsm@mpa.gov.sg  
 W: www.mpa.gov.sg

**Singapore Jaldhi Overseas Pte Ltd**  
 101 Cecil Street  
 08-06 Tong Eng Building  
 Singapore 069533  
 Singapore  
 Contact: Mr Vira Chand Bothra  
 T: + 65 6223 8929  
 F: + 65 6223 8920  
 E: vcb@jaldhi.com  
 W: www.jaldhi.com/

**SLOVENIA**

**Koper Luka Koper d.d., Dry Bulk Cargo Terminal**  
 Vojkovo Nabrežje 38  
 Koper  
 SI-6501  
 Slovenia  
 Contact: Mr Ivan Peric  
 Director - Dry Bulk Cargo Terminal  
 T: + 386 566 56 511  
 F: + 386 566 56 509  
 E: ivan.peric@luka-kp.si  
 W: www.luka-kp.si  
 Location: Slovenian coast, the northernmost part of the Adriatic  
 Equipment & Capacity: 3x Gantry crane 16 ton; 1 kangaroo crane 16 ton  
 Bulk Berths: 3 Berths  
 Total uncovered Storage: 40,000mt  
 Total covered Storage: 80,000mt  
 Different types of Minerals  
 Quayside 525 m  
 Sea depth 6 – 12,5 m  
 Special capacities for Alumina  
 Sea depth 9 m  
 Berth1  
 Storage capacity 20.000mt  
 Our terminal is also specialized in handling and warehousing of different kinds of cereals and fodder.

**SOUTH**

**AFRICA**

**Bishopsgate South African Sugar Association**  
 SA Sugar Terminal Department  
 PO Box 61104  
 Bishopsgate  
 KZN  
 4008  
 South Africa  
 Contact: Mr S Suleman  
 T: + 27 31 365 8100  
 F: + 27 301 1313  
 E: shaffee.suleman@sasa.org.za  
 W: www.sasa.org.za

**Durban Bulk Connections**  
  
 P O Box 21273  
 Bluff  
 Durban  
 KwaZulu Natal  
 4036  
 South Africa  
 Contact: Mr Iain Geldart  
 MD  
 T: + 27 31 466 1960  
 F: + 27 31 466 9667  
 E: iaing@bulkconnections.com  
 W: www.bulkconnections.com  
 Location: East Coast of South Africa  
 Equipment & Capacity: Sized sensitive loading equipment. Capacity of 3.5 million tpa.  
 Bulk Berths: Three berths, up to 10.3m deep  
 Berth 3. Length 184m. Draught 8,8m.  
 Berth 4. Length 220m. Draught 10,3m.  
 Total uncovered Storage: 140,000

sqm  
 Total covered Storage: 4,000 sqm  
 Bulk Connections is an import/export, multi modal bulk terminal specialising in soft handling of cargo.

**Durban South African Bulk Terminals LTD**  
 101 Maydon Road  
 Maydon Wharf  
 Durban  
 KwaZulu Natal  
 4001  
 South Africa  
 Contact: Mr Koos Smith  
 Managing Director  
 T: + 27 31 327 5048  
 F: + 27 31 304 6794  
 E: koos.smith@sabulk.co.za  
 W: www.bidvest.co.za

**Durban Bulk Connections**  
 Location: Durban, South Africa  
 Equipment & Capacity: MW5 - SKT 800 + 300 tph/ load 500 tph  
 IV3 - Pneumatic(2) 640 tph/load 1500 tph  
 Bulk Berths: MW5 200m/9.6m  
 IV3 up to 255m/12.8m  
 Total covered Storage: MW5 - 150 000 tonnes silo/bin  
 IV3 - 69500 tonnes silos + 5650 vegetable oil storage tanks

**Durban Bidfreight Port Operations (Pty) Ltd**  
 PO Box 900  
 Durban  
 4000  
 South Africa  
 Contact: Ms Belinda Kruger  
 Executive Assistant & Corporate  
 Communications  
 T: + 27 31 274 2400  
 F: + 27 31 205 4116  
 E: marketing@bidports.co.za





# GRAIN FED

Harvest our extensive experience in the trading, shipping and freight logistics of agricultural and dry bulk products. Our subsidiary, Island View Shipping's large fleet of modern vessels caters to the international Handysize, Handymax and Panamax markets, specialising in the movement of grains and proteins worldwide. We service extensive road routes in southern Africa and operate as a major trader and supplier of agricultural commodities worldwide. That's food for thought, for all your dry bulk shipping and logistics requirements.

**Freight • Trading • Shipping • Financial** | [www.grindrod.co.za](http://www.grindrod.co.za)

  
**GRINDROD**  
LIMITED

[info@grindrod.co.za](mailto:info@grindrod.co.za)



W: www.bidports.co.za  
 Location: All major ports in South Africa  
 BPO offer an integrated port operations solution to customers importing or exporting in South Africa.

**Durban**  
**Transnet Port Terminals Head Office**  
 Kingsmead Office Park  
 Stalwart Simelane/Stanger Street  
 Durban  
 KwaZulu Natal  
 4001  
 South Africa  
 Contact: Ms Mbali Mathenjwa  
 T: + 27 31 3088310  
 F: + 27 31 308 8336  
 E: Mbali.Mathenjwa@transnet.net  
 W: www.transnetportterminals.net  
 Location: 16 cargo terminals situated in 7 commercial ports along South Africa's coastline.  
 Transnet Port Terminals (previously South African Port Operations) is responsible for cargo handling and logistics services.

**Durban**  
**Grindrod Terminals - Maydon Wharf**



34 Shadwell Road  
 Maydon Wharf  
 Durban  
 Kwazulu Natal  
 4001  
 South Africa  
 Contact: Mr Paul Leisegang  
 Regional Manager  
 T: + 27 31 274 3270  
 F: + 27 31 2743277  
 E: paul@grindrod.co.za  
 W: www.grindrod.co.za  
 Location: South Africa - Kwazulu Natal  
 Bulk Berths: Have access to 14 multi user berths of varying lengths.  
 Draught of between 9m and 10.3m .  
 Preferential berthing rights at one berth.  
 Total uncovered Storage: Container terminal - in excess of 1300 container slots.  
 Total covered Storage: Storage capacity of 150 000 tons (Bulk, Break Bulk and Bagged).  
 Container handling and packing facilities. Intermodal warehouse and container yards - 176 655m2.

**Durban**  
**South African Sugar Association (Pty) Ltd**  
 PO Box 700  
 Mount Edgecombe  
 Durban  
 KwaZulu Natal  
 0300  
 South Africa  
 Contact: Mr Vino Naicker  
 T: + 27 31508 7000  
 F: + 27 31508 7189  
 E: vinonai@sasa.org.za  
 W: www.sasa.org.za

**East London**  
**Transnet National Port Authority**  
 PO Box 101  
 East London  
 5200  
 South Africa  
 Contact: Capt Naresh Sewnath  
 Port Captain  
 T: + 27 43 700 1176  
 F: + 27 43 700 2227  
 E: naresh.newnath@transnet.net

**East London**  
**S A Port Ops East London Grain Terminal**  
 P O Box 101  
 East London  
 5200  
 South Africa  
 Contact: Mr Neil Pettifer  
 T: + 27 43 700 2027  
 F: + 27 43 700 2304  
 E: neil.pettifer@transnet.net  
 W: www.transnetnationalportsauthority.net

**Johannesburg**  
**Anglo Coal**  
 PO Box 61587  
 Marshalltown  
 Johannesburg  
 Gauteng  
 2107  
 South Africa  
 Contact: Mr Kevin Martens  
 General Manager, Logistics  
 T: + 27 11 638 5422  
 F: + 27 11 638 5428  
 E: kmartens@angloamerican.co.za  
 W: www.angloamerican.co.uk

**Johansberg**  
**National Ports Authority of South Africa (NPASA)**  
 30 Wellington Road  
 Parktown  
 Johansberg  
 Gauteng  
 2193  
 South Africa  
 Contact: Mr Pieter Smit  
 Marketing Manager  
 T: + 27 11 351 9019  
 F: + 27 11 351 9023  
 E: pieters@npa.co.za  
 W: www.npa.co.za

**Meerensee**  
**Grindrod Terminals**



PO Box 10744  
 Meerensee  
 3901  
 South Africa  
 Contact: Mr Christo Coetzer  
 Executive - Terminals  
 T: + 27 35 797 9092  
 F: + 27 35 797 9033  
 E: christoc@grindrod.co.za  
 W: www.grindrod.co.za  
 Location: South Africa - Kwazulu Natal  
 Equipment & Capacity: 4.0 million tons handled annually. Four different sites have the capacity to handle 5 million tons pa.  
 Bulk Berths: Import: 3 berths (Max. vessel length x max. Draught depth) 1@ 240 x 13.5m, 1@ 220 x 13.5 and 1@ 260 x 17.0m Export: 5 berths (Max. vessel length x max. Draught depth) 2 @ 200 x 17.0m, 1@ 190 x 17.0 and 2 @ 230 x 17.0m.  
 Total uncovered Storage: 35,400m2  
 Silo storage 79,000 tonnes @ cargo SG of 2.5  
 Total covered Storage: 61,000m2  
 Terminals are belt connected to the quayside for imports and exports.  
 Grindrod is well equipped to handle all sorts of cargoes from tipping of trains, bulk storage, bagging of products and containerisation of cargoes.

**Port Elizabeth**  
**Portnet Port Elizabeth**  
 P O Box 162  
 Port Elizabeth  
 6000  
 South Africa  
 Contact: Mr Manie Coetzee  
 Marketing  
 T: + 27 41 507 2604  
 F: + 27 41 558 383  
 E: manie.coetzee@transnet.net  
 W: www.transnet.net

**Port Elizabeth**  
**Transnet Port Terminals**  
 PO Box 162  
 Port Elizabeth  
 6000  
 South Africa  
 Contact: Ms Nandi Oliphant  
 T: + 27 41 507 1824  
 F: + 27 41 507 1801  
 E: nandi.oliphant@transnet.net  
 W: www.transnetportterminals.net  
 Equipment & Capacity: Over 2 million tons annual throughput. Exports more than 1.7 million tons of manganese ore.  
 Bulk Berths: 4 berths  
 Value-added services include packing and unpacking of containers, storage and additional logistics management.

**Richards Bay**  
**Port of Richards Bay**  
 PO Box 181  
 Richards Bay  
 KwaZulu Natal  
 3900  
 South Africa  
 Contact: Mr Preston Khomo  
 Port Manager  
 T: +27 35 905 3203  
 F: +27 35 905 3333  
 E: Preston.Khomo@transnet.net  
 W: www.ports.co.za/richards-bay.php  
 Location: Located approximately 160km north-east of Durban and 465km south of Maputo on the eastern seaboard of South Africa.  
 Equipment & Capacity: Please see our website for more information - www.npa.co.za  
 Bulk Berths: Please see our website for more information - www.npa.co.za  
 Total uncovered Storage: Please see our website for more information - www.npa.co.za  
 Total covered Storage: Please see our website for more information - www.npa.co.za  
 The port's hinterland comprises the Northern KwaZulu Natal, Gauteng and Mpumalanga regions. The port boasts substantial bulk handling capacity, excellent rail/port connections, transshipment facilities and growing container handling facilities. It also offers easy access to South Africa's national road and rail network with substantial growth capacity in rail network link.

**Richards Bay**  
**Richards Bay Coal Terminal**  
 PO Box 56  
 Richards Bay  
 KwaZulu Natal  
 3900  
 South Africa  
 Contact: Mr Ronald Llaie  
 Acting Corporate Affairs Manager  
 T: + 27 35 904 4015  
 F: + 27 35 907 7200  
 E: rllaie@rbct.co.za  
 W: www.rbct.co.za  
 Location: Eastern seaboard of South Africa.  
 Equipment & Capacity: 4x shiploaders, 6x stacker reclaimers, 2 stackers, 1 reclaimer, 58m conveyor belt system up to 2.5m wide, travelling

up to 22km/h  
 Bulk Berths: 301, 302, 303, 304, 305.  
 Permissible draught 17.5m  
 Total uncovered Storage: 6.7 million tonnes  
 Export capacity of 72 million tones per annum.  
 Land surface area of 254,114 hectares

**Richards Bay**  
**Transnet Port Terminals**  
 Dry Bulk Terminal  
 Customer Services Department  
 PO Box 1793  
 Richards Bay  
 KwaZulu Natal  
 3900  
 South Africa  
 Contact: Mr Warren Vickers  
 Customer Services Manager  
 T: + 27 35 905 3105  
 F: + 27 35 905 3216  
 E: Warren.Vickers@transnet.net  
 W: www.transnet.net  
 Location: The port of Richards Bay is located about 180 km north of Durban, South Africa.  
 Equipment & Capacity: 4 General purpose ship loaders (2,500tph)  
 2 Pneumatic woodchip loaders (700 & 1,000 tph each)  
 3 Grab unloaders (1,500 tph)  
 3 Mobile harbour cranes (600 tph)  
 2 Pneumatic unloaders (600 & 500 tph)  
 Bulk Berths: Berth 609 - 300m - 14.0m draught  
 Berth 701 - 240m - 14.0m draught  
 Berth 702 - 300m - 17.5m draught  
 Berth 703 - 240m - 17.5m draught  
 Berth 704 - 240m - 17.5m draught  
 Berth 705 - 280m - 17.5m draught  
 Berth 801 - 260m - 17.5m draught  
 Berth 804 - 260m - 17.5m draught  
 Total uncovered Storage: Import: nil  
 Export: Area ABC West : 3 x 50 000 ton: Area ABC East : 2 x 100 000 ton  
 Total covered Storage: Import: 25 000m2 (shed)  
 Export: 38 910m2 (sheds)  
 Export: 120,600m3 (silos & storage bins)

Over 13 million tonnes of bulk cargo is imported and exported via a fully computerised conveyor belt system, controlled from a central control room.  
 40 Km of conveyor belt links seven private harbour bound industries to the quayside operation of loading and discharging vessels. NB Vessels must ballast during discharge to maintain 18.0m max air-draught.  
 Magnetite and Anthrasite also handled.

**Saldanha**  
**Saldanha Bulk Terminal**  
 Private Bag X8  
 Saldanha  
 4395  
 South Africa  
 Contact: Mr Christopher Gomez  
 Communications Manager  
 T: + 27 22 703 4204  
 F: + 27 22 703 4828  
 E: christopherg@saportops.co.za

**Saldanha**  
**S A Port Ops**  
 Private Bag X14  
 Saldanha  
 7395  
 South Africa  
 Contact: Mr Deon Julies  
 Business Unit Executive  
 T: + 27 22 703 4710  
 F: + 27 22 703 4832  
 E: deon.julies@transnet.net

**SOUTH**

**KOREA**

**Cheju**  
**Cheju Port Authority**  
 918-30 Geonip-Dong  
 Cheju  
 South Korea  
 Port Manager  
 T: + 82 64 22 1754  
 F: + 82 64 57 5002

**Donghae**  
**Mukho Port Authority**  
 Donghae District Maritime Port Administration  
 Donghae  
 South Korea  
 Port Manager  
 T: + 82 394 521 7000  
 F: + 82 394 521 0317

**Donghae City**  
**Donghae Port Authority**  
 806 Cheongok-dong  
 Donghae City  
 Gangwon  
 240-716  
 South Korea  
 Contact: Mr K Nam  
 Port Manager  
 T: + 82 33 533 3011  
 F: + 82 33-533-1415  
 E: info@portarea.com  
 W: www.portdonghae.go.kr

**Inchon**  
**Korea Silo Company Pier 7**  
 3 1-KA Puksgong-Dong  
 Chung-Gu  
 Inchon  
 South Korea  
 T: + 82 32 763 3211  
 F: + 82 32 763 9178  
 E: marcello\_b@yahoo.com  
 W: www.koreasilco.co.kr

**Jung-gu**  
**Incheon Port Authority**  
 193 Seohaero  
 1-17 Hang-dong 7 ga  
 Jung-gu  
 Incheon  
 402-705  
 South Korea  
 Contact: Mr Lee Jeeong-Ryoul  
 Port Management Division  
 T: + 82 32 880 6114  
 F: + 82 32 884 3563  
 E: demigod@icpa.or.kr  
 W: www.portincheon.go.kr/

**Kunsan**  
**Changhang Port Authority**  
 Kunsan Port Authority  
 1-7 Jangmi-Dong  
 Kunsan  
 South Korea  
 Port Manager  
 T: + 82 654 420660  
 F: + 82 654 433217

**Kunsan**  
**Kunsan Port Authority**  
 1-7 Jangmi-Dong  
 Kunsan  
 South Korea  
 Port Manager  
 T: + 82 654 420 660  
 F: + 82 654 433 217

**Masan-South**  
**Masan Port Authority**  
 1-6 Wolpo-Dong  
 Masan-South  
 South Korea  
 Port Manager

T: + 82 551 456177  
F: + 82 551 456179

## Nam Ku

**Ulsan Port Authority**  
Ulsan District Maritime  
139-9 Maeam Dong  
Nam Ku  
Ulsan  
South Korea  
Port Manager  
T: + 82 522 614881  
F: + 82 522 614873

## Pohang

**Pohang District Maritime & Port Authority**  
58-7 Hangku-Dong  
Pohang  
South Korea  
T: + 82 562 421881  
F: + 82 562 451623

## Pohang

**Port of Pohang**  
Pohang District Maritime & Port Authority  
58-7 Hangku-dong  
Pohang  
South Korea  
T: + 82 562 421 812  
F: + 82 562 422 122

## Ulsan

**Port of Ulsan Public Piers 1&2**  
Ulsan District Maritime and Port Authority  
139-9 Maeam-dong  
Ulsan  
South Korea  
Contact: Mr Jeong Chang-won  
T: + 82 52 228 5500  
F: + 82 52 228 5549  
W: www.ulsan.mltm.go.kr

## Yosu

**Yeosu Port Authority**  
335-1 Sujoung-dong  
Yosu  
South Korea  
Port Manager  
T: + 82 61 660 9000  
F: + 82 61 662 4054  
W: www.yosu.momaf.go.kr

## Yosu

**Samil Port Authority**  
c/o Yosu District Maritime Port Authority  
335-2 Soojung-Dong  
Yosu  
South Korea  
Port Manager  
T: + 82 662 624953  
F: + 82 662 645 436

## SPAIN

### Alcudia

**Port of Alcudia**  
Autoridad Portuaria de Baleares  
Ed. Arranque Muelle Pesquero, s/n  
Alcudia  
Balearic Islands  
07410  
Spain  
Contact: Ms Teresa Alonso  
Estrategic Plan Manager  
T: + 34 971 22 81 50 ext 241  
F: + 34 971 54 91 67  
E: portsdebalears@portsdebalears.com  
W: www.portsdebalears.com  
Location: Eastern Mediterranean Sea.  
Balearic Islands Archipelago. North of Mallorca  
Equipment & Capacity: Muelle Ribera. Productos Asfálticos, S.A. Betunes asfálticos, descarga por tubería, 3

silos en Muelle Ribera de 1.990 m3.  
Muelle Comercial. Portland de Mallorca. Cemento, descarga por tubería 200 Tn./hora  
Total uncovered Storage: Muelle Adosado 3.200 e.m. (coal)

### Algeciras

**Port Authority of La Bahia de Algeciras**  
Apartado No7  
Paseo de la Conferencia S/N  
Algeciras  
Cadiz  
11207  
Spain  
Contact: Mr Gerardo Landaluce  
Marketing Manager  
T: + 34 9 56 58 54 00  
F: + 34 9 56 58 54 45  
E: glandaluce@apba.es  
W: www.apba.es

### Alicante

**Port of Alicante**  
Muelle de Poniente 11  
Alicante  
03001  
Spain  
Contact: Mr Luis Charles Lopez  
Marketing  
T: + 34 96 513 0134  
E: llopez@puertoalicante.com  
W: www.portel.es/alicante

### Almeria

**Carboneras**  
c/o Autoridad Portuaria de AlmeriaMotril  
Muelle de Levante s/n  
Almeria  
04071  
Spain  
Contact: Mr Muelle Levante  
Port Director  
T: + 34 9 50 23 60 33  
F: + 34 9 50 23 29 49  
E: almeria@apalmeria.com  
W: www.apalmeria.com/

### Almeria

**Port of Almeria**  
Muelle Levante s/n  
Almeria  
04071  
Spain  
Contact: Mrs Trinidad Cabeo  
Rodríguez  
President  
T: + 34 950 236 033  
F: + 34 950 232 949  
E: tcabeo@apalmeria.com  
W: www.apalmeriamotril.com

### Asturias

**Port Authority of Aviles**  
El Muelle 8  
Avile  
Asturias  
33400  
Spain  
Contact: Ms Cristina Lopez  
Head of Marketing  
T: + 34 9 8 554 11 11  
F: + 34 9 8 554 04 79  
E: cristinal@puertoaviles.com  
W: www.puertoaviles.es

### Barcelona

**Ergransa**  
22B Contradic Est Wharf  
Barcelona  
Spain  
Contact: Mr Jordi Archs  
General Manager and CEO  
T: + 34 93 2954580/4433716  
F: + 34 93 442 20 28  
E: gerencia@ergransa.es  
W: www.ergransa.es

### Barcelona

**Ergransa Terminal**  
11 Muelle Contradique  
Barcelona  
Spain  
Contact: Mr Jorge Arch Miquel  
T: + 34 93 295 45 80  
F: + 34 933 173 042  
E: gerencia@ergransa.es  
W: www.ergransa.es

### Barcelona

**Port of Barcelona**  
WTc, Ed. Est, Moll de Barcelona s/n  
Barcelona  
08039  
Spain  
Contact: Mrs Norma de la Fuente  
Communications & Institutional Relations Director  
T: + 34 9 3 306 88 00  
F: + 34 9 3 306 88 58  
E: norma\_delafuente@portdebarcelona.es  
W: www.portdebarcelona.es  
Location: West Mediterranean  
Equipment & Capacity: The Port of Barcelona has 6 companies dedicated to solid bulks:  
- Porcemen, S.A and Cemex España (Cement)  
- Ergransa (Grain)  
- Cargill España, S.A and Moyresa/Bunge (Soya products)  
- Tramer, S.A (Potash)  
Bulk Berths: 1422 m.l  
Total uncovered Storage: 38,192sqm approx.  
Total covered Storage: 17,659sqm approx.  
Total surface: 138,035sqm

### Barcelona

**Portcemen, SA**  
22c Contradic Wharf  
Port of Barcelona  
Barcelona 08039  
Spain  
Contact: Mr Eduard Duran  
Managing Director  
T: + 34 93 443 05 14  
F: + 34 93 443 10 29  
E: portcemen@entorno.es  
W: www.portcemen.com

### Barcelona

**Tramer SA**  
22a Contradic Nord Wharf  
Port of Barcelona  
Barcelona  
08039  
Spain  
T: + 34 93 442 19 40  
F: + 34 93 443 20 73  
E: tramer@iberposash.com

### Barcelona

**Moyresa Molturación y Refino SA**  
23A Oest Wharf  
Port of Barcelona  
Barcelona  
08039  
Spain  
T: + 34 934 43 40 00  
F: + 34 934 41 05 16

### Barcelona

**Cemex España**  
01B Adosst Wharf  
Port of Barcelona  
Barcelona  
08039  
Spain  
Contact: Almudeno Lomillo  
Marketing  
T: +34 918 00 78 00 / +34 902 23 63 93  
F: + 34 93 221 93 44  
W: www.cemex.es

### Bilbao

**Autoridad Portuaria De Bilbao**  
Campo De Volantin 37  
Bilbao  
Bizkaia  
48007  
Spain  
Contact: Mr Julio Burgos  
Desarrollo Comercial  
T: + 34 94 487 1200  
F: + 34 94 487 1410  
E: jburgos@bilbaoport.es  
W: www.bilbaoport.es  
Location: Inner quays: Nemar, Adosado & Princesa docks  
Outer Abra: AZ1 & Punta Sollana docks  
Equipment & Capacity: Inner quays: 2 overhead gantries of 35t, 7 luffing cranes of 16t  
Outer Abra quays: 2 on tyre wheel cranes of 105 & 140t, 1 mobile crane of 25t, conveyor belts for grains (2,000 tph) and clinker (1,000 tph), continuous loader for sulphate (700 tph)  
Bulk Berths: Inner quays: total length 1,027m, draught 14m.  
Outer Abra quays: total length 1,250m, draught 21m.  
Total uncovered Storage: 220,100sqm  
Total covered Storage: 53,800 + silos for grain with 100,000t of storage capacity  
Industrial installations: grinder for oil seeds, clinker mill, drying shed for coke.

### Cadiz

**Cadiz Bay Port Authority**  
Plaza de Espana 17  
Cadiz  
11006  
Spain  
Contact: Ms Kate Bonet  
Marketing Manager  
T: + 34 9 56 24 04 00  
F: + 34 9 56 24 04 76  
E: cadiz@puertocadiz.com  
W: www.puertocadiz.com

### Cartagena

**Port Authority of Cartagena**  
Plaza Heroes de la Marina, s/n  
Cartagena  
Murcia  
30201  
Spain  
Contact: Mr Fernando Munoz  
Commercial Director  
T: + 34 9 68 32 58 00  
F: + 34 9 68 32 58 15  
E: fmunoz@apc.es  
W: www.apc.es  
Location: 0° 59' O Longitude 37° 35' N Latitude  
South East of Spain on the South Mediterranean Coast  
Equipment & Capacity: Escombreras Basin  
ISO 9001/2008 Certification in solid bulks traffic.  
- 7 x 100 T mobile cranes capable of operating at both quays.  
- Cranes of 40T, 30T and 12T  
Bulk Berths: Principe Felipe E004: Length 180m, Draught 11.9m.  
Principe Felipe E005: Length 175m, Draught of 13.2m  
Principe Felipe E006: Length 175m, Draught 13.72m  
Isaac Peral E007: Length 240m, Draught 13.72m  
Isaac Peral E008: Length 240m, Draught 13.72m  
Muelle Sur E023: Length 301m, Draught 21m  
Muelle Sur E024: Length 302m, Draught 21m  
Total uncovered Storage: 115,617 sqm  
Total covered Storage: 34,421 sqm  
Extension of the Escombreras Basin

with over 2,600 metres of mooring berth and a surface area of 64 hectares.  
Industrial and logistics activities area: 28 Ha

### Cartagena

**Port of Aguilas**  
Port Services Parque 1 entresuela  
Cartagena  
Murcia  
Spain  
Contact: Mr Pedro Albadalejo  
Port Manager  
T: + 34 9 68 36 24 98  
F: + 34 9 68 36 23 27

### Ferrol

**Port Authority of Ferrol-San Ciprian**  
Muelle de Curuxeiras s/n  
Ferrol  
15401  
Spain  
Contact: Mr Miguel Villalobos  
Port Director  
T: + 34 981 369 155  
F: + 34 9 981 35 31 74  
E: ferrol@ferrol.portel.es  
W: www.porto-ferrolsanciprian.com

### Ferrol

**Port Authority of Ferrol – S**  
Muelle Curuxeiras s/n  
Ferrol  
A Coruña  
15401  
Spain  
Contact: Mr Julio Hernández  
Commercial Manager  
T: + 34 981 338 064  
F: + 34 981 33 80 01  
E: jhernandez@apfsc.es  
W: www.apfsc.es  
Location: North West of Spain  
Equipment & Capacity: Quays, cranes, berths, warehouses, etc.  
Bulk Berths: Draughts up to 20 meters

### Formentera

**Port of La Savina**  
Autoridad Portuaria de Baleares  
Passeig de la Marina, s/n  
Formentera  
Balearic Islands  
07870  
Spain  
Contact: Ms Teresa Alonso  
T: + 34 91 32 21 30  
F: + 34 91 32 21 30  
E: portsdebalears@portsdebalears.com  
W: www.portsdebalears.com  
Location: Eastern Mediterranean Sea  
Balearic Islands Archipelago. North of Formentera

### Garrucha

**Garrucha**  
Empresa Publica de Puertos de Andalucía  
Puerto Pesquero de Garrucha  
Garrucha  
Almería  
04630  
Spain  
Contact: Mr AF Romero  
Port Director  
T: + 34 9 50 46 02 36  
F: + 34 9 50 13 26 36

### Gijón

**Port Authority of Gijon**  
Claudio Alvargonzalez 32  
Gijón  
Asturias  
33201  
Spain  
President  
T: + 34 985 17 96 07  
F: + 34 985 35 99 17



E: comunicacion@puertogijon.es  
 W: www.puertogijon.es  
 Location: Northwest of Spain on the Cantabrican Sea (Atlantic coast) 5° 41'W 43°34'N  
 Equipment & Capacity: 28 cranes ( 3 cranes of 2.200 tph)  
 Bulk Berths: Main bulk terminal for coal and iron ore: EBHISA (EUROPEAN BULK HANDLING INSTALLATION)  
 Length: 800 m.  
 Draught: 270 m with 20m. depth at L.W.O.S.T. and 530 m with 21 m depth at L.W.O.S.T.  
 Total uncovered Storage: 2,569,402 sqm  
 Total covered Storage: 60,459 sqm  
 EBHISA is an enterprise owned by Port of Gijon -more than 80%- with other regional companies.

**Gijón**

**EBHI - European Bulk Handling Installation**

Muelle Marcelino León s/n  
 El Musel  
 Gijón  
 Asturias  
 33212  
 Spain  
 Contact: Mr Laureano Lourido  
 Managing Director  
 T: + 34 985 308 507  
 F: + 34 985 308 123  
 E: jalago@ebhi.es  
 W: www.ebhi.es  
 Location: North coast of Spain.  
 Equipment & Capacity: 17 Million tons per year capacity with a maximum daily throughput of 100,000 tons.  
 Bulk Berths: No LOA / DWT limitation. 18m draught (60 feet)  
 Total uncovered Storage: 260,000sqm

**Huelva**

**Port Authority of Huelva**  
 Avda Real Sociedad Colombiana  
 Onubenso 1  
 Huelva  
 21001  
 Spain  
 Contact: Mr Enrique P Gomez  
 Director  
 T: + 34 9 59 21 31 00  
 F: + 34 9 59 21 31 01  
 E: aph@puertohuelva.com  
 W: www.puertohuelva.com

**Ibiza**

**Port of Ibiza**  
 Autoridad Portuaria de Baleares  
 Moll Interior, 1  
 Ibiza  
 Balearic Islands  
 07800  
 Spain  
 Contact: Ms Teresa Alonso  
 T: + 34 971 31 06 11  
 F: + 34 971 31 04 00  
 E: portsdebalears@portsdebalears.com  
 W: www.portsdebalears.com  
 Location: Eastern Mediterranean Sea  
 Balearic Islands Archipelago. South of Ibiza

**La Coruña**

**Muelle del Centenario**  
 Autoridad Portuaria de la Coruna  
 Avda de la Marina 3  
 La Coruña  
 15002  
 Spain  
 Contact: Mr Luis Felipe Fernandez  
 Rueda  
 T: + 34 981 22 74 02  
 F: + 34 981 205 862  
 E: explotacion@puertocoruna.com  
 W: www.puertocoruna.com

**La Coruña**

**Terminales Maritimos de Galicia, S.L.**  
 Muelle Calvo Sotelo S/N  
 La Coruña  
 15006  
 Spain  
 Contact: Mr Iago Mallo Sanz  
 Technical Manager  
 T: + 34 981 12 61 69  
 F: + 34 981 12 22 35  
 E: imallo@tmga.es  
 W: www.tmga.es  
 Location: North West of Spain on the North Coast

**La Coruña**

**T.M.G.A. SL**  
 Cuesta de la Palloza  
 1-Entlo  
 La Coruña  
 15006  
 Spain  
 Contact: Mr Juan Ibanez  
 Managing Director  
 T: + 34 981 175690  
 F: + 34 981 227556  
 E: jibanez@mconsiflet.com  
 W: www.tmga.es

**La Coruña**

**Port Authority of La Coruña**  
 Avenida del la Marina 3  
 La Coruña  
 15001  
 Spain  
 Contact: Ms Marta Rodriguez  
 Pantín  
 Commercial Unit Manager  
 T: + 34 981 219 621  
 F: + 34 981 219 600  
 E: mrodri@puertocoruna.com  
 W: www.puertocoruna.com  
 Location: North West of Spain  
 Bulk Berths: More than 1000 m long  
 Total uncovered Storage: 32,000sqm  
 Total covered Storage: 66,400sqm  
 New outer port in Punta Langosteira for bulks (250 ha surface; 22 m draft; 900 m long).

**Los Barrios**

**Endesa**  
 PO Box 11  
 Los Barrios  
 Cadiz 11370  
 Spain  
 Contact: Mr Francisco Aamoros  
 Commercial Department  
 T: +34 6256 04 167  
 F: + 34 956 6782 11  
 E: info@unesa.es

**Madrid**

**Ership S.A.U**  
 5th Floor  
 Lagasca 88  
 Madrid  
 28001  
 Spain  
 Contact: Mr Jorge Alvorgonzalez  
 Shipbroker  
 T: + 34 91 4263400  
 F: + 34 91 5757565  
 E: jorge.alvorgonzalez@ership.com  
 W: www.ership.com

**Madrid**

**Puertos del Estado**  
 Avda.del Partenon, 10  
 Campo de las Naciones  
 Madrid  
 28042  
 Spain  
 Contact: Mr Jose Maria Sanchez  
 Segovia  
 T: + 34 91 524 55 00  
 F: + 34 91 524 55 01  
 E: presidencia.puertos@puertos.es  
 W: www.puertos.es

**Mahon**

**Port of Mahon**  
 Autoridad Portuaria de Baleares  
 Moll de Llevant, 1  
 Mahon  
 Balearic Islands  
 07701  
 Spain  
 Contact: Ms Teresa Alonso  
 T: + 34 971 36 30 88/66  
 F: + 34 971 36 31 01  
 E: portsdebalears@portsdebalears.com  
 W: www.portsdebalears.com  
 Location: Eastern Mediterranean Sea  
 Balearic Islands Archipelago. East of Menorca  
 Equipment & Capacity: Muelle Cos Nou. Valenciana de Cementos. 2 Silos cemento de 1.500 Tn. de capacidad, 1 silo de 1.900 Tn.  
 Total uncovered Storage: Muelle Cos Nou 58.945 e.m.

**Malaga**

**Malaga Port Authority**  
 Muelle de Canovas s/n  
 Malaga  
 29001  
 Spain  
 Contact: Mr Sebastian Camps  
 Managing Director of Malagaport  
 A.I.E  
 T: + 34 952 125 013  
 F: + 34 952 125 014  
 E: info@malagaport.net  
 W: www.malagaport.net  
 Location: Southern Spain, 80 miles from the Strait Gibraltar  
 Equipment & Capacity: Total: 6,210 metres (ro ro ramps, containers, dry and liquid bulk, fishing and cruises berths)  
 Bulk Berths: Docks 5, 6 and 7  
 Total uncovered Storage: 353,498sqm  
 Total covered Storage: 4,884sqm

**Marin**

**Ceferino Nogueira SA**  
 Avenida Oresnse 1-B  
 Marin  
 Pontevedra  
 36900  
 Spain  
 Contact: Mr Ceferino Nogueira  
 Garcia  
 T: + 34 986 88 0600  
 F: + 34 986 88 4776  
 E: info@nogar.es

**Melilla**

**Port Authority of Melilla**  
 Avda of Spanish Navy No 4  
 Melilla  
 52001  
 Spain  
 Contact: Mr Alejandro Suarez  
 Marketing Department  
 T: + 34 952 673 600  
 F: + 34 952 674 838  
 E: asuarez@puertodemelilla.es  
 W: www.puertomelilla.com

**Motril**

**Port of Motril**  
 C/ Recinto Portuario, S/N  
 Motril  
 Granada  
 18613  
 Spain  
 Contact: Mr Domingo Reyes Martín  
 Operations & Port Services  
 T: + 34 958 60 12 07  
 F: + 34 958 60 12 34  
 E: dreyes@apmotril.com  
 W: www.apmotril.com  
 Location: South East Spain, Strait of Gibraltar, Alboran Sea  
 Equipment & Capacity: 2 cranes, 350 and 250 tph  
 Bulk Berths: 607 / 260m length, 12/10m depth

Total uncovered Storage: 683.929sqm  
 Total covered Storage: 6,174sqm  
 Please see our website  
 www.apmotril.com for more details

**Motril**

**Motril Port - Granada**  
 c/Recinto Portuario s/n  
 Motril  
 Granada  
 18613  
 Spain  
 Contact: Mr Jose Bermúdez del Valle  
 General Manager  
 T: + 34 958 601 207 ext 160  
 F: + 34 958 601 234  
 E: jbermudez@motrilport.com  
 W: www.apmotril.es  
 Location: South East Spain, Strait of Gibraltar  
 Promotion and commercialization Port of Motril-Granada

**Palma**

**Port of Palma**  
 Autoridad Portuaria de Baleares  
 Muelle Viejo 3  
 Palma  
 Balearic Islands  
 07012  
 Spain  
 Contact: Mr M Ginard  
 Head of Marketing  
 T: + 34 971 22 81 50  
 F: + 34 971 72 69 48  
 E: mginard@portsdebalears.com  
 W: www.portsdebalears.com  
 Location: Eastern Mediterranean Sea  
 Balearic Islands Archipelago. South of Mallorca  
 Equipment & Capacity: Dique del Oeste - 2ª alineación. Silos y almacenes Baleares, S.A.. 3 Silos de cemento de 3.800 Tn. de capacidad, 1 toma de descarga de 200 Tn./hora  
 Dique del Oeste - 2ª alineación. Cemex España, S.A.. 3 Silos de cemento de 3.800 Tn. de capacidad, 1 toma de descarga de 200 Tn./hora  
 Total uncovered Storage: Muelle de Ribera-18.644 e.m.  
 Total covered Storage: Muelle de Ribera 4.651 e.m. (Grain/Agribulk)

**Pasaia**

**Port Authority of Pasaia**  
 Edificio Transatlántico, Zona Portuaria s/n  
 Apartado 56  
 Pasaia  
 Gipuzkoa, Basque Country  
 20110  
 Spain  
 Contact: Mr Gorka Reizabal  
 Press and PR Department  
 T: + 34 943 35 18 44  
 F: + 34 943 35 01 41  
 E: greizabal@puertopasajes.net  
 W: www.puertopasajes.net  
 Location: North Spain, Bay of Biscay  
 43° 19' 15,82" N.  
 01° 55' 15,98" W.

**Pto. Alcudia**

**Transportes Maritimos Alcudia, SA**  
 Teodoro Canet No 26  
 Pto. Alcudia  
 Mallorca-Baleares  
 07400  
 Spain  
 Contact: Mr Miguel Oliver  
 Managing Director  
 T: + 34 971 545 932/28  
 F: + 34 971 547 356  
 E: moliver@tmalculdia.com  
 W: www.portsdebalears.com

**Sagunto**

**Port of Sagunto**  
 Autoridad Portuaria de Valencia  
 Muelle Centro SN  
 Sagunto  
 46520  
 Spain  
 Contact: Mr Ramon Izquierdo  
 Port Administrator  
 T: + 34 96 269 9002  
 F: + 34 96 3268 0972  
 E: psagunto@valenciaport.com

**Santa Cruz de Tenerife**

**Port Authority of Tenerife**  
 Avenida Francisco La Roche No 49  
 Santa Cruz de Tenerife  
 Canary Islands  
 Spain  
 Contact: Mr Manuel Fernandez del Castillo  
 Port Director  
 T: + 34 9 22 605400  
 F: + 34 9 22 605479  
 E: comercial@puertosdetenerife.org  
 W: www.puertosdetenerife.org

**Santander**

**Port Authority of Santander**  
 Muelle de Maliaño s/n  
 Santander  
 Cantabria  
 39009  
 Spain  
 Contact: Ms Sophie Lanos  
 Marketing Assistant  
 T: + 34 942 203600  
 F: + 34 942 203632  
 E: comercial@puertosantander.com  
 W: www.puertosantander.com  
 Location: Situated on Europe's Atlantic Coast, on the largest bay in northern Spain, in the Cantabrico's sea.  
 Equipment & Capacity: 16 Portal cranes: 1x 16-35t, 62.5-312.5 tph; 10x 16t, 62.5-312.5 tph; 4x 12t, 25-150 tph, 1x 35t, 4x 50/80 t mobile cranes  
 Bulk Berths: CADEVESA-CANTABRIASIL: Total area 10.441sqm; Length 180m; Width 37m; Depth 8m.  
 NUEVA MONTAÑA-GLOBA: Total Area 10.474sqm; Length 218m; Depth 5m.  
 RAOS 1: Total area 98.107sqm; Length 300m; Depth 13m.  
 RAOS 2: Total area 66.964sqm; Length 208m; Depth 13m.  
 RAOS 3: Total area 151.303sqm; Length 569m; Depth 13m.  
 RAOS 4: Total area 43.402sqm; Length 356m; Depth 13m.  
 RAOS 5: Total area 15.000sqm; Length 335m; Depth 10m.  
 Dry bulk cargo terminal - the only completely indoor terminal in the world; highly computerized, state of the art equipment, high performance, minimal emissions into the atmosphere. Unloading capacity: 2,250 tph, 20,000 tpd.  
 Total uncovered Storage: 758,651sqm  
 Total covered Storage: 122,772sqm  
 Solid Bulks  
 2008: 3,732,466 Tons  
 2009: 2,919,749 Tons

**Santander**

**Puerto de Santander**  
 Autoridad Portuaria de Santander  
 Muelles de Maliaño s/n  
 Santander  
 Cantabria  
 E390 09  
 Spain  
 Contact: Mr José Joaquín Martínez  
 Sieso  
 Chairman  
 T: + 34 942 20 36 00  
 F: + 34 942 20 36 33

E: info@puertosantander.com  
 W: www.puertosantander.com  
 Location: North of Spain on the north Cantabrian coast.  
 Equipment & Capacity: Water Depth 13m  
 Panamax  
 Bulk Berths: 1.76m  
 Total uncovered Storage: 911,768sqm  
 Total covered Storage: 160,498sqm  
 - Santander to Madrid 393 kilometers. tax free.  
 - High intermodal accessibility  
 - Multipurpose port. Last generation terminals

**Sevilla**  
**Port Authority of Sevilla**

Avenida de Molini No 6  
 Sevilla  
 41012  
 Spain  
 Contact: Mr Manuel A. Fernandez González  
 President  
 T: + 34 954 24 73 00  
 F: + 34 954 24 73 33  
 E: sevilla@apsevilla.com  
 W: www.apsevilla.com

**Tarragona**  
**Berge Maritima**

Tarragona  
 Spain  
 Contact: Mr Daniel Vega  
 T: + 34 977 55 05 00  
 F: + 34 977 48 43 82  
 E: consignacion.tar@berge-m.es  
 W: www.berge-m.es

**Tarragona**  
**Euroports Iberica TPS**

Apto. Correos 839  
 Tarragona  
 Tarragona  
 43080  
 Spain  
 Contact: Mr Javier Herrera  
 Commercial Manager  
 T: + 34 977 22 22 19  
 F: + 34 977 22 04 59  
 E: jherrera@europortsiberica.com  
 W: www.euroports.com  
 Location: North Mediterranean coast of Spain  
 Equipment & Capacity: Unload: 24,000t/day for coal, 14,000t/day for agribulk  
 Bulk Berths: Draught from 18.5m to 13.2m  
 Total uncovered Storage: 160,000sqm  
 Total covered Storage: 70,000sqm  
 Handling Pulp, Steel and all type of General Cargo, developing at this step a new specialized terminal.

**Tarragona**  
**Silos de Tarragona SA (SITASA)**

Muelle Castilla s/n Ap.160  
 Tarragona  
 43080  
 Spain  
 Contact: Mr Joan Marc Papiro  
 Director  
 T: + 34 977 259 500  
 F: + 34 977 259 530  
 E: jmpapiro@silostgna.com  
 W: www.silostgna.com

**Tarragona**  
**Codemar-Iberbulk**

Muelle de Castilla, s.n.  
 Tarragona  
 43004  
 Spain  
 Contact: Mr Luis Fernández  
 General Manager  
 T: + 34 9 77 21 5273  
 F: + 34 9 77 22 98 53  
 E: lfernandez@codemar-iberbulk.es  
 W: www.codemar-iberbulk.es

Location: North East of Spain in the Mediterranean Coast. South of Barcelona. Distance to Barcelona 100km.  
 Bulk Berths: Limitation according to the public information by the Port Authority of Tarragona.  
 Total covered Storage: Out 34,000 sqm covered flat stores  
 Conveyor belts running from quayside to three of five flat stores in our facilities at the Muelle de Castilla yard.

**Tarragona**  
**Port Authority of Tarragona**

Passeig de l'Escullera s/n  
 Tarragona  
 43004  
 Spain  
 Contact: Mr Pedro Bernal  
 Commercial Manager  
 T: + 34 977 259 400  
 F: + 34 977 241 372  
 E: omercial@porttarragona.cat  
 W: www.porttarragona.cat

**Torre Vieja**  
**Torre Vieja Port Authority**

Espanada del Mar s/n  
 Torre Vieja  
 Spain  
 Port Director  
 T: + 34 96 571 0234  
 F: + 34 96 571 0234

**Valencia**  
**Inst Portuarios de Estudios**

Edificio del Reloi  
 Muelle del Grao s/n  
 Valencia  
 46024  
 Spain  
 Contact: Mr Ramon Gomez-Ferrer  
 Boldova  
 Director  
 @with line:

**Valencia**  
**Port Authority of Valencia**

Av. Muelle del Turia s/n  
 Valencia  
 46024  
 Spain  
 Contact: Ms Francesca Antonelli  
 Marketing Manager  
 T: + 34 9 6 393 95 00  
 E: fantonelli@valenciaport.com  
 W: www.valenciaport.com  
 Location: Spain's Eastern Mediterranean Coastline

**Vigo**  
**Port Authority of Vigo**

Plaza de la Estrella, 1 (VIGO)  
 Vigo  
 E:36201  
 Spain  
 Contact: Ms Dolores Rois  
 Commercial Director  
 T: + 34 9 86 26 80 00  
 F: + 34 9 86 26 80 01  
 E: drois@apvigo.es  
 W: www.apvigo.es

**Vilagarcía de Arousa**  
**Port of Vilagarcía**

Peirao de Pasaxeiros, 1  
 Vilagarcía de Arousa  
 Pontevedra  
 36600  
 Spain  
 Contact: Mr Juan Diego Perez  
 Freire  
 Director Manager  
 T: + 34 9 86 565 129 / +349 06 565921  
 F: + 34 9 86 507923  
 E: juandiego@portovilagarcia.com  
 W: www.portovilagarcia.com  
 Location: Northwest of the Iberian Peninsula. Ria of Arousa.

Bulk Berths: Dry bulks by special installation and Dry bulks without special installation  
 Total uncovered Storage: 80,200sqm  
 Total covered Storage: 109,692sqm  
 During the year 2005, Vilagarcía Port moved 1,184,178 tonnes

**Vilagarcía de Arousa**  
**Autoridad Portuaria de Vilagarcía de Arousa**

Avenida de la Marina, 15  
 Vilagarcía de Arousa  
 36600  
 Spain  
 Contact: Ms Patricia González  
 Núñez  
 Jefa de Unidad de Relaciones Externas  
 T: + 34 986 56 59 20  
 E: comunicacion@portovilagarcia.es  
 W: www.portovilagarcia.es  
 Location: North West of Spain, on the Atlantic coast of Galicia  
 Equipment & Capacity: 10 lines of quay, 9 crane onto rails, 2 mobile high-tonnage cranes, pipelines systems for liquid bulks and for cement.

Bulk Berths: - For solid bulks by specific installation: 303 linear metres, depth 13 m.  
 - For solid bulks without specific installation: 2.655 linear metres, depth max. 13m., min. 7m.  
 Total uncovered Storage: 119,868sqm  
 Total covered Storage: 96,416sqm  
 The Port enjoys a privileged location in a wide, sheltered bay, and has excellent communications by road and railway. The nearest airports are about 45 min. distant.

**SRI LANKA**

**Galle**  
**Galle Port**

Sri Lanka Ports Authority  
 Closenberg Jetty  
 Magalla  
 Galle  
 Sri Lanka  
 Harbour Master  
 T: + 94 11 242 1201  
 F: + 94 11 244 0651  
 E: webmaster@slpa.lk

**ST PIERRE &**

**MIQUELON**

**Saint-Pierre and Miquelon**  
**Saint-Pierre Harbour**

Quai de l'Alysse  
 BP 4217  
 Saint-Pierre and Miquelon  
 97500  
 St Pierre & Miquelon  
 Contact: Mr Enrique Perez  
 Harbour Master  
 T: + 11 508 410 974  
 F: + 11 508 410 979  
 E: enrique.perez@equipement.gouv.fr  
 W: www.saint-pierre-et-miquelon.developpement-durable.gouv.fr  
 Location: The North Atlantic Ocean, south of the Canadian province of Newfoundland and Labrador.  
 Equipment & Capacity: 5 mobile cranes (5t-20t capacity).  
 Wheel crane (70 t).  
 Bulk Berths: 3 wharfs up to 170sqm long. Draught: 6m-8.5m  
 Total uncovered Storage: 17,500sqm  
 Total covered Storage: 2,800sqm in warehouse

**ST VINCENT**

**& THE**

**GRENADINES**

**Kingstown**  
**Kingstown**  
 St Vincent Port Authority  
 PO Box 1237  
 Kingstown  
 St Vincent & The Grenadines  
 Contact: Mr Brenan B King  
 Harbour Master  
 T: + 1809 4561830  
 F: + 1809 45626732  
 E: portsvvg@mail.caribsurf.com

**SUDAN**

**Port Sudan**  
**Sea Ports Corporation**

PO Box 531  
 Port Sudan  
 Sudan  
 Contact: Eng Ibrahim A. Ahmed  
 General Manager  
 T: + 249 2910  
 F: + 249 2127  
 E: ohag\_ohag@hotmail.com  
 Location: North East coast. 1200 miles south swiscanal-Egypt  
 Equipment & Capacity: 16 quay cranes, 6 STS gantry, 15 RTG, 46 handling facilities with average loading capacity 3-50 tons  
 Bulk Berths: 4 berths - overall length 861m, depth 16m for each  
 Total uncovered Storage: 850,000m  
 Total covered Storage: 1,350,000m  
 New projects for container berths and Suakin Port, livestock & vegetables loading new terminal under construction.

**SULTANATE**

**OF OMAN**

**Muscat**  
**Oman Flour Mills Co SAOG**

PO Box 566  
 Ruwi-112  
 Muscat  
 Sultanate of Oman  
 Contact: Mr Ali Habaj  
 General Manager  
 T: + 968 24711155  
 F: + 968 24711111  
 E: flour@omantel.net.om  
 W: www.omanflourmills.com

**N. Azaiba**  
**Port of Duqm**

4th Floor, Almashreq Building  
 18 November Street  
 N. Azaiba  
 Sultanate of Oman  
 Contact: Mr Peter Broers  
 CEO  
 T: + 968 24 587 343  
 F: + 968 24 342 800  
 E: info@portduqm.com  
 W: www.portduqm.com

**SURINAME**

**Paramaribo**  
**N.V. Havenbeheer Suriname**  
 Suriname Ports Management Company  
 Havenlaan Zuid #5  
 Paramaribo  
 Suriname

Contact: Mr John A. Defares  
 Managing Director/CEO  
 T: + 597 40 2375  
 F: + 597 40 3691  
 E: smeport@sr.net  
 Location: Nieuwe Haven  
 Within the Capital (Paramaribo) about 20 km up stream of the "Suriname river".  
 Equipment & Capacity: Cranes with lifting capacity of 100 tons  
 Bulk Berths: No special Bulk facilities  
 Total uncovered Storage: 8.9 ha  
 Total covered Storage: Temporary shed about 2,000sqm  
 The port is nearing the finalization of a rehabilitation process. In 2010 more covered storage space will be created.

**SWEDEN**

**Gavle**  
**Port of Gavle Authority**

Fredriksskans  
 Gavle  
 805 95  
 Sweden  
 Port Director  
 T: + 46 26 17 88 44 dcd  
 F: + 46 26 14 09 79  
 E: info@gavlehamn.se  
 W: http://www.gavle-port.se/

**Göteborg**  
**Port of Göteborg**

Nordtältauten  
 Gate 5  
 Göteborg  
 SE 403 38  
 Sweden  
 Contact: Ms Susan Hansel  
 Media Relations officer  
 T: + 46 31 731 23 25  
 F: + 46 31 731 22 03  
 E: eva.jonasson@portgot.se  
 W: www.portgot.se

**Halmstad**  
**Halmstad Port**

PO Box 1  
 Halmstad  
 301 02  
 Sweden  
 Contact: Ms Bergitta Johannsen  
 Production Manager  
 T: + 46 35 15 53 14  
 F: + 46 35 14 05 93  
 E: birgitta.j@porthalmstad.com  
 W: www.halmstadharbour.se

**Helsingborg**  
**Helsingborg Coal Terminal**

PO Box 821  
 Helsingborg  
 S-25108  
 Sweden  
 Contact: Mr Andreas Eriksson  
 Information Officer  
 T: + 46 4210 6300  
 F: + 46 4212 4374  
 E: andreas.eriksson@port.helsingborg.se  
 W: www.port.helsingborg.se

**Helsingborg**  
**Lantmännen, Farmers Assoc.**

Massgodsleden  
 Helsingborg  
 252 25  
 Sweden  
 Contact: Mr Claes Nilsson  
 Operations Manager  
 T: + 46 42 19 57 00  
 F: + 46 42 14 87 86  
 E: claes.nilsson@lantmannen.com  
 W: www.lantmannen.se



**Helsingborg**

**Helsingborgs Hamn, Port of Helsingborg**  
Oceangatan 3  
PO Box 821  
Helsingborg  
SE 251 08  
Sweden  
Contact: Mr Kjell-Åke Rantf  
Sales Manager  
T: + 46 42 10 63 00  
F: + 46 42 28 22 99  
E: kjell.rantf@port.helsingborg.se  
W: www.port.helsingborg.se  
Location: Swedish southwest coast  
Handles fiberfuels and for the local powerplant.

**Husum**

**Husum Port**  
Mo ch Domsjö AB  
Harbour Department, Husum Mill  
Husum  
890 35  
Sweden  
Contact: Mr Conny Sallander  
Port Manager  
T: + 46 660 78714  
F: + 46 660 299 028  
E: conny.sallander@ovikshamn.se  
W: www.ormskoldsvikshamn.se/

**Kalmar**

**Kalmar Hamn AB (Port of Kalmar)**  
PO Box 810  
Kalmar  
391 28  
Sweden  
Contact: Mr Carl-Johan Nordheim  
Managing Director  
T: + 46 480 45 14 50  
F: + 46 480 45 14 58  
E: info@kalmarhamn.se  
W: www.kalmar.se/kalmarhamn  
Location: South East Coast of Sweden  
Equipment & Capacity: 7 mobile cranes, 15-36 tonnes capacity  
Bulk Berths: max depths 7.7m  
Total uncovered Storage: 75,000sqm  
Total covered Storage: 13,000sqm

**Karlshamn**

**Port of Karlshamn**  
PO Box 8  
Karlshamn  
374 21  
Sweden  
Contact: Mr Bjorn Nilsson  
Marketing Manager  
T: + 46 454 30 50 00  
F: + 46 45 48 10 40  
E: info@karlshamnshamn.se  
W: www.karlshamnshamn.se

**Karlstad**

**Vänerhamn AB**  
Stuvargatan 1  
Karlstad  
652 21  
Sweden  
Contact: Mr Tobias Uhn  
Sales Manager  
T: + 46 54 14 48 60  
F: + 46 54 21 33 16  
E: tobias.uhn@vanerhamn.se  
W: www.vanerhamn.se  
Location: Five modern ports at lake Vänern, strategically located in the heart of Sweden. Ports are Vänersborg, Lidköping, Otterbäck, Kristinehamn and Karlstad. Well-developed infrastructure and excellent opportunities for combining sea transport with road and rail.  
Equipment & Capacity: 11 railborne, 4 fixed and 6 mobile crane, Heavy lift crane 200 tonnes. Forklifts, loading machines and bobcats.  
Bulk Berths: argest vessel size 88 x 13,20 x 5,40 m (Vänermax)

Total uncovered Storage: 312,000 sqm  
Total covered Storage: 109,000 sqm

**Kristinehamn**

**Kristinehamn Port**  
Hamnvagen 6A  
Kristinehamn  
681 30  
Sweden  
Contact: Mr Carlerik Holmlin  
Harbour Master  
T: + 46 550 87750  
F: + 46 550 83897  
E: carlerik.holmlin@vanerhamn.se

**Lulea**

**Port of Lulea**  
Stromorvagen 9  
Lulea  
SE 974 37  
Sweden  
Contact: Mr Roger Danell  
Port Director  
T: + 46 9204 53000  
F: + 46 920 25 55 94  
E: leif.aberg@hamn.lulea.se  
W: http://www.lulea.se/hamnen

**Lysekil**

**Port of Lysekil**  
Hamnkontoret  
Lysekil  
S-453 80  
Sweden  
Contact: Mr Olle Samuelson  
Harbour Master  
T: + 46 523 14090  
F: + 46 523 14094  
E: olle.samuelson@lysekil.se  
W: www.lysekilhamn.se  
Location: West of Sweden  
Equipment & Capacity: Cranes, Hopper, Fork-lifts etc  
Total uncovered Storage: 30,000sqm  
Total covered Storage: 30,000sqm

**Malmö**

**Copenhagen Malmö Port AB**  
Terminalgatan 18  
Box 566  
Malmö  
S-201 25  
Sweden  
Contact: Mr Soren Balken  
Marketing Coordinator  
T: + 46 40 680 4100  
F: + 46 40 180 501  
E: soren.balken@cmport.com  
W: www.cmport.com  
Location: Copenhagen Malmö Port is located in the Øresundregion with terminals in both Denmark and Sweden.  
Equipment & Capacity: CMP: 3 stationary cranes 20 tons  
1 mobilecrane 64 tons, capacity 12,000 tonnes of coal a day  
1 multidocker 8.5 tons, 1 Fuchs  
Bulk Berths: CMP facilities:  
Swede Harbour: 1001,1002 - 200 m - 13.5 m  
Sødra Bulk/ 740, 750, 751 - 6.0 m  
Prøvestenen/855,856,857,858,859,86 0,861 - 679 meters - 10.5 - 6.0 m  
Private operators:  
Amagerværket/835,836,837,838 - 440 meters - 12.0 m  
Margretholm/825 - 140 meters - 6.0 m  
Kalkbrænderihavnen/401,402 - 230 m - 6.7 m  
Total uncovered Storage: Approx 500,000 sqm  
Total covered Storage: 28,500 sqm  
A new 180,000sqm terminal for bulk is constructed. Terminal has 650m of quay with a water depth of 11.4m.

**Oxelsund**

**Oxelosunds Hamn AB**  
Box 1200  
Oxelsund  
SE-61324  
Sweden  
Contact: Mr Bo Ytterstrom  
Marketing Manager  
T: + 46 155 258 000  
F: + 46 1553 4321  
E: bo.ytterstrom@oxhamn.se  
W: www.oxhamn.se  
Bulk Berths: Draught 15.3m. Max LOA 265m. Max Beam 41m.

**Södertälje**

**Port of Sodertälje**  
PO Box 2016  
Södertälje  
151 02  
Sweden  
Contact: Mr Erik Froste  
Managing Director  
T: + 46 8 55 02 37 40  
F: + 46 8 55 03 19 49  
E: info@soept.se  
W: www.soept.se

**Sonderhamn**

**Sonderhamn Port**  
Strandgatan 4  
Sonderhamn  
826 60  
Sweden  
Contact: Mr Tommi Eriksen  
Harbour Master  
T: + 46 270 28 41 32  
F: + 46 270 28 41 26  
E: info@sshb.se

**Stockholm**

**Port of Hargshamn**  
742 50 Hargshamn  
Stockholm  
Sweden  
Contact: Mr Hakan Nilsson  
Port Director  
T: + 46 173 20155  
F: + 46 173 20311  
E: hakan.nilsson@hargshamn.se  
W: www.hargshamn.se

**Uddevalla**

**Uddevalla Port**  
Uddevalla Hamnterminal AB  
PO Box 543  
Bastiongatan 5  
Uddevalla  
451 21  
Sweden  
Contact: Mr Ulf Stenberger  
Harbour Master  
T: + 46 522 912 04 / + 46 522 91244  
F: + 46 522 33630  
E: ulf.stenberger@uddevalla-hamn.se  
W: www.stockholmshamn.se

**Västerås**

**Mälarenhamnar AB**  
Box 3013  
Västerås  
720 03  
Sweden  
Contact: Mr Magnus Johansson  
Sales Manager  
T: + 46 21 150100  
F: + 46 21 150145  
E: magnus.johansson@malarhamnar.se  
W: www.malarhamnar.se  
Location: In the lake of Mälaren we have two ports, one in Köping and one in Västerås, Sweden  
Equipment & Capacity: Cranes, loaders, Rechstackers, trucks, etc.  
Bulk Berths: 7 berths  
Total uncovered Storage: 100,000sqm  
Total covered Storage: 55,000sqm  
Receiving ships up to 7,000 tons net weight. Ongoing investments to receive 13,000 tons. Reaching 1/3 of

Swedens population within 200 km radius (3 million people).

**Ystad**

**Port of Ystad**  
Bornholmsgatan 6  
Ystad  
Scania  
27139  
Sweden  
Contact: Mr Michael Törnfeldt  
Operational Manager  
T: + 46 411 577 661  
F: + 46 411 749 50  
E: michael.tornfeldt@ystad.se  
W: www.port.ystad.se  
Location: Ystad is situated on the south coast of Sweden. N55 - 24,5 - E 013 - 43'  
Equipment & Capacity: Cranes: 1 mobile, capacity 40 tons.  
Stevedoring: Ystad Stevedores, fork trucks (max 12 tons), terminal tugmasters, bobcats and loading machines.  
Bulk Berths: Bulk, ferry and industrial port guarantees a water depth of 7.2m at normal tide levels. Water depth in the anchorage basin 15m.  
Quays: Length 1.100m. Load allowed 2-3 t/m<sup>3</sup>. Axle pressure 10/16 t. 1,000m railway tracks in the dock area.  
Total covered Storage: Warehouses: The Port Administration: 4.500 sqm, Ystads Stevedores 2.200 sqm and Pol-Line 400 sqm  
The Port of Ystad is ISPS certified.

**SWITZERLAND**

**Basel**

**Rhenus-Alpina AG**  
Basel  
Switzerland  
Contact: Ms Claudia Bracher  
T: + 41 61 639 33 33  
F: + 41 61 639 34 66  
E: info@rhenus.ch

**Basel**

**Ultra-Brag AG**  
Südquaistrasse 55  
Basel  
CH-4019  
Switzerland  
Contact: Mr Beat Heydrich  
CEO  
T: + 41 61 639 72 00  
F: + 41 61 639 72 10  
E: info@ultra-brag.ch  
W: www.u-b.ch  
Location: Ports of Basel, Switzerland (City of Basel, Birsfelden, Auhafen)  
Equipment & Capacity: Various cranes up to 600mt lifting capacity  
Total uncovered Storage: 25,000sqm  
Total covered Storage: 30,000sqm  
3 silos for storage of up to 90,000mt grain and animal feeds

**Basel**

**Port of Switzerland**  
Hochbergerstrasse 160  
Basel  
CH-4019  
Switzerland  
Contact: Ms Nina Hochstrasser  
Communication Officer  
T: + 41 61 639 9597  
F: + 41 61 639 9514  
E: nina.hochstrasser@portof.ch  
W: www.port-of-switzerland.ch  
Location: North West of Switzerland  
Equipment & Capacity: 60 cranes  
Bulk Berths: 7 km, 3.2 m  
Total uncovered Storage: 200,000 sqm  
Total covered Storage: 250,000 sqm  
Container terminals, distribution

centers, tank storage, elevators

**Birsfelden**

**BIRS Terminal AG**  
Hafenstrasse 54  
Postfach  
Birsfelden  
CH 4127  
Switzerland  
Contact: Ms Sabine Schmid  
T: + 41 61 377 8032  
F: + 41 61 377 8010  
E: sabine.schmid@birsterminal.ch  
W: www.birsterminal.ch

**Lugano**

**Interbulk**  
Via Bagutti 6  
Lugano  
6904  
Switzerland  
Contact: Mr Michele Caffarena  
International Terminals Department  
T: + 41 91 911 37 41  
F: + 41 91 911 37 29  
E: m.caffarena@interbulk.ch

**SYRIA**

**Lattakia**

**Lattakia General Port Company**  
PO Box 220  
Baghdad Street  
Lattakia  
Syria  
Contact: Mr Mdhat Abou Al-Shamlat  
General Manager  
T: +963 41 476452  
F: +963 41 475760  
E: info@bahharshipping.com

**Tartous**

**Tartous Port Authority**  
PO Box 86  
Tartous  
Syria  
Contact: Eng. Zaki-E Najib  
Port Manager  
T: + 963 43 313 752  
F: + 963 43 315 602  
E: ta-pco@mail.sy  
W: www.tartousport.com

**TAIWAN**

**Hualien**

**Haulien Port**  
Haulien Harbour Bureau  
No 66 Hai-Ann Road  
Hualien  
Taiwan  
Contact: Mr Li Keh-Shul  
Harbour Bureau Director  
T: + 886 38 325131  
F: + 886 38 333757  
E: lly@mail.hh.gov.tw  
W: www.hh.gov.tw

**Kaohsiung**

**Kaohsiung Harbour Bureau**  
No. 62  
Lin Hai 2nd Rd  
Kaohsiung  
Taiwan  
Contact: Mr Ting-Yi Tsai  
Harbour Manager  
T: + 886 7 562 2100  
F: + 886 7 521 6915  
E: p04685@mail.khb.gov.tw  
W: www.khb.gov.tw  
Location: South West coast of Taiwan  
Equipment & Capacity: 18 cement silos (278,000t), 2 grain silos (180,000t), 1 coal silo (80,000t)  
Bulk Berths: 20 dry bulk cargo wharves  
Total uncovered Storage: 6 open storage yards (44,885sqm)  
Total covered Storage: 50



## Bulk Terminal Amsterdam

Your partner for dry bulk cargoes  
into the main European Markets

- **MAIN TERMINAL:** QUAY LENGTH 1.2 KM WITH TWO BERTHS/SEPARATE BELT SYSTEM FOR SIMULTANEOUS DISCHARGE OF TWO LARGE COAL VESSELS (UP TO CAPE SIZE) AT A HIGH CAPACITY TO THE VARIOUS STACKING INSTALLATIONS (3250 AND 3850 TPH)
- **TERMINAL NORTH:** QUAY LENGTH 350 METERS / ONE BERTH FOR UP TO CAPE SIZE VESSELS
- **MAX VESSEL SIZE:** 17.80 METERS DRAFT SWEK, MAX BEAM 45 METERS
- 4 GANTRY CRANES (1 X 60 TONS / 1 X 50 TONS / 2 X 30 TONS)
- FLOATING CRANE (50 TONS)
- COAL STORAGE CAPACITY 3MIO TONS ON 650,000M<sup>2</sup>
- RAILCAR LOADING FACILITY; 25,000 TPD
- TWO LARGE SHIP (SPOUT) LOADERS: 60,000 TPD AT THE SONTHAVEN FOR (PUSH) BARGE COMBINATIONS AND SEAGOING VESSELS.
- GRAB LOADING INTO BARGE/SEAGOING VESSEL AT MAIN TERMINAL AND TERMINAL NORTH
- IN TTL 9 HEAVY DUTY MAGNETIC SEPARATORS INSTALLED IN ALL INWARD AND OUTWARD BOUND CONVEYOR BELT ROUTES, INCLUDING THE RAILCAR LOADER. BOARD/BOARD INTO BARGE BARGE/COASTER ALSO POSSIBLE VIA THE MAGNETIC SEPARATORS.
- HOMOGENISING OF VARIOUS GRADES OF COAL WHILST LOADING VIA THE CONVEYOR BELT INCL. WEIGHT ASSESSMENT PER QUALITY
- SCREENING/CRUSHING/MIXING
- COVERED STORAGE CAPACITY AT MAIN TERMINAL IN 5 SHEDS DIRECTLY UNDER REACH OF THE GRABS; TTL. 25,000M<sup>2</sup> FOR BIOMASS, AGRIBULK AND MINERALS.

## OBA Bulk Terminal Amsterdam

Westhavenweg 70, 1042 AL Amsterdam,

Managing Director: Hans Fylstra (hans.fylstra@oba-bulk.nl) +31 20 5873701

Manager Commercial Department: Hans Mattheyer; (hans.mattheyer@oba-bulk.nl) +31 20 5873750

Website: [www.oba-bulk.nl](http://www.oba-bulk.nl)



warehouses (221,662sqm)

**Keelung**

**Keelung Port Authority**  
Keelung Harbour Bureau  
Port Building  
1 Chung Cheng Road  
Keelung  
202  
Taiwan  
Contact: Mr Han Te An  
Director  
T: + 886 2 428 1156  
F: + 886 2 428 5613  
E: dttd200@klhb.gov.tw  
W: www.jlhb.gov.tw

**Mai Liao**

**Mai Liao Harbour Administration Corp**  
No 1-1 Formosa Industrial Complex  
Mai Liao  
Yunlin County  
638  
Taiwan  
T: + 886 5681 2766  
F: + 886 5681 2135  
E: captliow@fpg.com.tw  
Location: West South West of Taiwan  
Equipment & Capacity: 1x grab type/12,000tpd, 2x bucket type/15,000tpd, 4x screw type/25,000tpd  
Bulk Berths: E2, E3, E4, E5  
Other commodities handled - industrial salt.

**Suao Port Building**

**Su-Ao Port Authority**  
Su-Ao Harbour Bureau  
3rd Floor  
Suao Port Building  
Suao  
Taiwan  
Contact: Mr Kuo-Hung Yeh  
Port Manager  
T: + 886 39 972001  
F: + 886 39 952739  
E: srdykh@klhb.gov.tw

**Taichung**

**Taichung-Wharf No 1**  
Pei Heng 11 Road  
Ching Shui Chen  
Taichung  
Taiwan  
T: + 886 4 656 4211  
F: + 886 4 656 8069

**Taichung**

**Port of Taichung, Asia Cement Berth**  
Taichung Harbour Bureau  
Wuchi  
Taichung  
Taiwan  
Contact: Mr CT Huang  
Director  
T: + 886 4 656 2611  
F: + 886 4 656 5703

**Taipei**

**Eastern Media International Corporation**  
8th Floor  
Yu Tai Enterprise Building  
368 Fu Hsing South Road  
Section 1  
Taipei  
106  
Taiwan  
Contact: Mr Michael LY Pan  
Executive Vice President  
T: + 886 2 2755 7565  
F: + 886 2 2702 8079  
E: spokesman@emic.com.tw  
W: www.emic.com.tw

**Wuchi**

**Taichung Port Authority**

Taichung Harbour Bureau  
Harbour Building  
Wuchi  
Taichung District  
Taiwan  
Contact: Mr C T Huang  
Director  
T: + 886 4 656 2611  
F: + 886 4 656 5702  
E: director@mail.tchb.gov.tw  
W: www.tchb.gov.tw

**TANZANIA**

**Dar es Salaam**

**Tanzania Harbours Authority**  
Bandari Street  
PO Box 9184  
Dar es Salaam  
Tanzania  
Contact: Mr Flavian Kinunda  
Director of Marketing  
T: + 255 22 2115559  
F: + 255 22 2115559  
E: kinunda@tanzaniaports.com

**Dar es Salaam**

**Tanzania Ports Authority**  
Dar es Salaam Port  
PO Box 1130  
Dar es Salaam  
Tanzania  
Contact: Mr Iddi Mkwata  
Port Manager  
T: + 255 22 2113642  
F: + 255 22 2113646  
E: pmdsm@tanzaniaports.com  
W: www.tanzaniaports.com  
Location: Latitude 6.5 and Longitude 39.17 East Coast of East Africa  
Equipment & Capacity: General cargo Terminal- Mobile cranes 63T, 35T, Portal cranes, Tractors, Trailers, Frontloader, Forklifts, bagging units, hoppers, etc.  
Bulk Berths: 2 berths, designed water depth of 12.2m., length of 183m.each.  
Total uncovered Storage: 82,700sqm  
Total covered Storage: 66,900sqm

**Kurasini**

**Grindrod Terminals - Dar Es Salaam**



Bandari Road, Plot 2A,  
Mission to Seafarer's Compound  
Annex Building Ground Floor  
Kurasini  
Dar Es Salaam  
Tanzania  
Contact: Mr Peter Buchholz  
Regional Manager  
T: + 255 22 213 3848  
F: + 255 22 213 3848  
E: peterb@grindrod.co.za  
W: www.grindrod.co.za  
Location: East coast of Africa in Tanzania  
Equipment & Capacity: 15 000 million tons bulk sulphur can be handled per vessel  
Bulk Berths: Berth No7  
Total covered Storage: Shed No 4 2700m2  
Currently discharge, store and bag commodity. Handle 80 000 tons of sulphur pa but have the capability of handling other commodities such as Nickel, copper concentrate, Ingots, Manganese ore and Fertilizer.

**THAILAND**

**Bangpli**

**S.P Intermarine Co., Ltd**  
150/90 Moo 3 Soi Wongsepad

Teparak Road (Km.10)  
Bangpli Yai  
Bangpli  
Samutprakarn  
10540  
Thailand  
Contact: Mr Krithep Suwajanakorn  
Marketing Department  
T: + 662 385 5335  
F: + 662 385 5910  
E: info@spintermarine.co.th  
W: www.spintermarine.co.th  
Location: Gulf of Thailand  
Equipment & Capacity: 4 VERSA MAX transhipment stations.  
10 high-speed floating cranes.  
Commodity-specific grabs.  
Transhipment capacity up to 2,000 TPH.  
More than 2,000,000 metric tons of various cargoes per year..  
Suitable for all agri and industrial bulks.

**Sattahip**

**Sattahip Port Authority**  
102/21 Moo 6 Plutalaung  
Sattahip  
Cholburi Province  
Thailand  
Port Director  
T: + 66 38 43134850  
F: + 66 38 431261

**Singhanakorn**

**Chaophaya Terminal International Co. Ltd**  
Songkhla Port  
Moo 7, Huakao  
Singhanakorn  
Songkhla  
90280  
Thailand  
Contact: Mr Jun Tao  
Port Director  
T: + 66 74 3310738  
F: + 66 74 331199  
E: info.skp@ctic.co.th  
W: www.ctic.co.th

**THE GAMBIA**

**Banjul**

**The Gambia Ports Authority**  
Liberation Ave  
Banjul  
The Gambia  
Contact: Miss Naffi Macdougall  
T: + 220 229940  
F: + 220 227268

E: info@accessgambia.com  
W: www.accessgambia.com/

**THE NETHERLANDS**

**Amsterdam**

**Graham - Grondstoffen Exp. Amsterdam (Arc Marine)**  
Amerikahavenweg 14  
Amsterdam  
1045 AD  
The Netherlands  
Contact: Mr Koos Van Der Steen  
Commercial Manager  
T: + 31 20 614 6949  
F: + 31 20 613 4959

**Amsterdam**

**Oba - Bulk Terminal Amsterdam**



Westhavenweg 70  
Amsterdam  
1042 AL  
The Netherlands  
Contact: Mr Piotr Skotnicki  
Managing Director  
T: + 31 20 587 3700  
F: + 31 20 611 6908  
E: directie@oba-bulk.nl  
W: www.oba-bulk.nl  
Location: Amsterdam North Sea  
Equipment & Capacity: 4 gantry cranes: 60t, 50t, 2x 30t.; 1 floating crane: 50t; 1 floating weighing tower; 2 Stackers; 2 Reclaimers; Conveyor belt systems with powerful magnetic separators; 1 ship loader (coaster); 2 barge loaders; 1 Train loader.  
Bulk Berths: 1,200m quay  
Total uncovered Storage: 600,000sqm  
Total covered Storage: 25,000sqm  
Annual volume 20 million tonnes.  
Products handled: Coal, Agribulk, Minerals, Biomass.  
Additional services: Mixing, crushing, screening.  
All transport modalities: Ships from Capes to Coasters, barges, rail, road.

**Amsterdam**

**Civil and Marine Nederland**  
Amerikahavenweg 11

Amsterdam  
1045 AA  
The Netherlands  
Contact: Mr Lennard Marthas  
Operations Director  
T: + 31 20 614 7928  
F: + 31 20 614 7918  
E: hanson-dc@wxs.nl

**Amsterdam**

**Maja Stuwadoors Rotterdam**  
PO Box 57196  
Amsterdam  
1040 BB  
The Netherlands  
Contact: Mr Arie Holleman  
T: + 31 20 684 2194  
F: + 31 20 684 7024  
E: info@majastuwadoors.nl  
W: www.majastuwadoors.nl  
Location: Port of Amsterdam, Rotterdam, Netherlands  
Equipment & Capacity: Floating operation with floating cranes in the ports of Amsterdam and Rotterdam. Operating with 8 floating cranes with capacities upto 1.000 mtp. Approx. 4 million tons a year throughput.  
Bulk Berths: Capesize vessels discharging on the buoys

**Amsterdam**

**Rietlanden Stevedores BV**  
Corsicaweg 10  
PO Box 59191  
Amsterdam  
1040KD  
The Netherlands  
Contact: Mr Karl Schot  
Managing Director  
T: + 31 20 506 1144  
F: + 31 20 613 0724  
E: karl.schot@rietlanden.com  
W: www.rietlanden.com  
Location: Amsterdam  
Equipment & Capacity: 5 floating cranes  
Total uncovered Storage: 60 hectares

**Amsterdam**

**B.V. Bouwgrondstoffen AGM**  
Amerikahavenweg 12  
Amsterdam  
1045 AD  
The Netherlands  
Contact: Mr Lennard Marthas  
Terminal Manager  
T: + 31 20 614 7821  
F: + 31 20 614 5984  
E: l.martha@paes-nl.com





# Port of Amsterdam



## PORT OF AMSTERDAM MAKE IT YOURS

What sort of people do you want to work with? Enthusiastic, committed, involved? People who care about their company - and yours? People who work with you to find the best possible solution to your supply chain needs? People who help you keep your customers happy? Then come to the Port of Amsterdam. The port with great accessibility. The port where people are passionate about your cargo. The port where you matter.

Please contact:



+31 (0)20 523 4560



cargo@portofamsterdam.nl



Port of Amsterdam Network

[www.portofamsterdam.com](http://www.portofamsterdam.com)



**Amsterdam**

Port of Amsterdam



Harbour Building  
De Ruijterkade 7  
PO Box 19406  
Amsterdam  
N-Holland  
1000 GK  
The Netherlands  
Contact: Mr Lex de Ridder  
Commercial Manager Unit Bulk  
T: + 31 20 523 4577  
F: + 31 20 523 5077  
E: lex.de.ridder@portofamsterdam.nl  
W: www.portofamsterdam.com  
Location: The Netherlands  
Amsterdam is one of Europe's leading dry bulk ports. Dedicated bulk terminals in all fields of drybulk logistics offer their flexible, personal services; for further information see above contact details.

**Amsterdam**

Amfert

Fosfaatweg 48  
PO Box 313  
Amsterdam  
1000 AH  
The Netherlands  
Contact: Mr Rainer Marx  
Logistics & Purchasing Manager  
T: + 31 20 581 5100  
F: + 31 20 686 8328  
E: marx@amfert.nl  
W: www.amfert.nl

**Badhoevedorp**

IGMA

Schipholweg 337 D  
Badhoevedorp 1171 PL  
The Netherlands  
Contact: Mr Rob Hansen  
General Manager  
T: + 31 20 580 1613  
E: rob\_hansen@igma.nl /  
rob\_hansen@cargill.com  
W: www.igma.nl  
Location: Port of Amsterdam  
Equipment & Capacity: 5 cranes/ 2 siwertels/2 suckers  
Bulk Berths: 5 berths for capes/panamax  
Total uncovered Storage: 50,000sqm  
Total covered Storage: 140,000sqm

**Botlek**

Borax Rotterdam N.V.

Welplaatweg 104  
Botlek  
Rotterdam  
3197 ZG  
The Netherlands  
Contact: Mr van der Linde  
General Manager  
T: + 31 10 490 9600  
F: + 31 10 416 0023  
E: boraxrotterdam@borax.com

**Botlek**

Jewometaal Stainless Processing

Quebecstraat 7  
Botlek  
Rotterdam 3197 KL  
The Netherlands  
Contact: Mr Henk Aulich  
Managing Director  
T: + 31 181 242 424  
F: + 31 181 242 425  
E: haulich@jewometaal.com  
W: www.jewo.com

**Delfzijl**

Groningen Seaports

Business Unit Logistics  
PO Box 20004  
Delfzijl  
9930 PA  
The Netherlands  
Contact: Mr Jannes Stokroos  
Public Relations  
T: + 31 596 640 400  
F: + 31 596 630 464  
E: g.stokroos@groningen-seaports.com

**Delfzijl**

Aldel - Aluminium Delfzijl

PO Box 133  
Delfzijl  
NL 9930 AC  
The Netherlands  
Contact: Mr S Fokkens  
T: + 31 0596 638357  
F: + 31 0596 638402  
E: info@aldel.nl  
W: www.aldel.nl  
Location: North East of The Netherlands  
Equipment & Capacity: Smelter 110KT

**Delfzijl**

Groningen Seaports

Handelskade Oost 1  
Postbus 20004  
Delfzijl  
9930 PA  
The Netherlands  
Contact: Mr Jannes Stokroos  
Director Shipping  
T: + 31 59 66 40 400  
F: + 31 59 66 30 464  
E: j.stokroos@groningen-seaports.com  
W: www.groningen-seaports.com

**Dordrecht**

BV Zeehavenbedrijf Dordrecht (ZHD Stevedoring)



PO Box 12  
Dordrecht  
3300 AA  
The Netherlands  
Contact: Mr Leo Lokker  
Commercial Director  
T: + 31 78 61 11 009  
F: + 31 78 63 32 815  
E: leo.lokker@zhd.nl  
W: www.zhd.nl  
Location: Rotterdam, Dordrecht and Moerdijk  
Equipment & Capacity: 15 cranes - 8 up to 50 tons lifting capacity (incl. 3 self-propelled floating cranes)  
Bulk Berths: Dordrecht 1.750m draught 31'  
Moerdijk 950m draught 28'  
(Lightering in Rotterdam possible with floating cranes)  
LOA: 201 m.  
Beam: 32.5 m.  
Total uncovered Storage: 150.000 sqm  
Total covered Storage: 80.000 sqm  
ZHD is an independent stevedoring company operating in Dordrecht, Moerdijk and Rotterdam. ZHD has large expansion plans, which includes development of 18 hectares "green field" (31' draught) and construction of new warehouses.

**Dordrecht**Port Authority of Dordrecht  
Merwekade 56  
Dordrecht

3311 TH  
The Netherlands  
Contact: Mr Niek Ooijevaar  
Harbour Master  
T: + 31 78 639 7875  
F: + 31 78 639 7879  
E: nooijevaar@dordrecht.nl

**Europoort - Rt**

Ertsoverslagbedrijf Europoort C.V. (EECV)

Markweg 131  
Europoort - Rt  
Zuid-Holland  
3198 NB  
The Netherlands  
Contact: Mr Thomas Heyer  
Project Management  
T: + 31 181 25 77 02  
F: + 31 181 25 77 03  
E: Info.eecv@thysenkrupp.com  
W: www.eecv.nl  
Location: Port of Rotterdam Europoort  
Equipment & Capacity: 3 grab unloaders each 2300 tph,  
1 continuous shipunloader 3000 tph,  
6 stacker reclaimers 4600 tph each,  
3 barge loaders 4600 tph each,  
1 train loading station 2000 tph.  
Bulk Berths: 3 berths, 18.5-23.7m draught  
Vessel size up to 365,000dwt.  
Total uncovered Storage: 40 ha

**Farmsum**

Akzonobel

Oosterhorn 4  
Farmsum  
Delfzijl 9936 HD  
The Netherlands  
Contact: Mr Arend Niemeijer  
Shipping Manager  
T: + 31 596 64 7000  
E: arend.niemeijer@akzonobel.com  
W: www.akzonobel.salt



An independent stevedoring company operating in Dordrecht, Moerdijk and Rotterdam.



- bulkhandling
- warehousing
- storage
- containerhandling

*More than just a stevedore*

Terminal Dordrecht  
's-Gravendeelsedijk 175  
3316 AS Dordrecht

T +31 (0)78-6 111 000  
F +31 (0)78-6 111 001  
E info@zhd.nl

WWW.ZHD.NL

Terminal Moerdijk  
Vlasweg 19  
4782 PW Moerdijk

T +31 (0)168-328 050  
F +31 (0)168-327 678

# stevedoring & warehousing rotterdam

- PROJECT CARGO
- INDUSTRIAL BREAKBULK
- 730 METRES QUAY LENGTH
- HEAVY LIFT STORAGE AREA
- HEAVY LIFT UP TO 1500 TONS

Lifting your cargoes faster

ISPS CERTIFIED

**rhb**  
ROTTERDAM

Waalhaven n.z. 4  
3087 BL Rotterdam  
P.O. Box 55092  
3006 EB Rotterdam  
Portnumber 2157

TELEPHONE  
+31 (0)10 429 94 33

FAX  
+31 (0)10 429 02 61

E-MAIL  
office@rhb.nl

WEB  
www.rhb.nl



shorecranes up to 208 tons



**Ijmuiden**

**Nebam BV**  
 PO Box 512  
 Ijmuiden  
 1970 AM  
 The Netherlands  
 Contact: Mr Marcel Botterhuis  
 Manager Agency Dept  
 T: + 31 251 495521  
 F: + 31 251 470279  
 E: marcel.botterhuis@nebam.nl  
 W: www.NEBAM.nl

**Koudekerk aan den Rijn**

**ENBO BV**  
 3 Hondsdijk  
 Koudekerk aan den Rijn  
 HG  
 2396  
 The Netherlands  
 Contact: Mr Jan Lahuis  
 Advertising  
 T: + 31 713 413 600  
 F: + 31 713 416 007  
 E: info@enbo.nl

**Mierlo**

**International Bulk Handling Technology BV**  
 PO Box 47  
 Mierlo  
 5730 AA  
 The Netherlands  
 Contact: Mr Johan M.A.M. Brands  
 Technical Manager  
 T: + 31 492 664 885  
 F: + 31 492 664 695  
 E: info@ibtbulk.nl  
 W: www.ibtbulk.nl  
 Offers over 42 years of expertise in design, manufacturing and maintenance of bulkhandling systems. Recently completed projects include ship loading facilities, reclaimers, hoppers, bins, automated train and ship loading/unloading facilities, Beltwall and pipe conveyors. Located in Indonesia, China, Argentina, Germany, USA and The Netherlands.

**Moerdijk**

**Associated Metal Services B.V.**  
 Vlasweg 19  
 PO Box 14  
 Moerdijk  
 Noord-Brabant  
 4780 AA  
 The Netherlands  
 Contact: Mr Albert Marcha van Ommen  
 Managing Director  
 T: + 31 168 393203  
 F: + 31 168 393202  
 E: a.vanommenjr@eurorijn.com  
 W: www.eurorijn.com

Location: Rotterdam area (Moerdijk)  
 Equipment & Capacity: 3 cranes - 6000 tons per month  
 3 payloaders - 10 vt trucks  
 2 weigh bridges  
 Bulk Berths: Draught 8.90m, quay 700 metres  
 Total uncovered Storage: 20,000sqm  
 Total covered Storage: 45,000sqm  
 We also offer processing and packing services.

**Moerdijk**

**Combined Cargo Terminals B.V.**  
 Graanweg 19  
 Moerdijk  
 Noord-Brabant 4782 PP  
 The Netherlands  
 Contact: Mr Luc Smits  
 Managing Director  
 T: + 31 168 334270  
 F: + 31 168 381193  
 E: info@cctmoerdijk.com  
 W: www.cctmoerdijk.com  
 Location: Moerdijk  
 Equipment & Capacity: Crane cap till 150m  
 Bulk Berths: Quay length 1,600m, draught 8.90m  
 Total uncovered Storage: 250,000sqm  
 Total covered Storage: 22,000sqm

**Rotterdam**

**Marcor Stevedoring BV**  
 Rotterdam



Dodewaardstraat 14  
 (Port Number 2175)  
 Rotterdam  
 3087 BA  
 The Netherlands  
 Contact: Mr Aad Groenenboom  
 Director  
 T: + 31 10 299 21 21  
 F: + 31 10 299 21 22  
 E: a.groenenboom@marcor.nl  
 W: www.marcor.nl  
 Location: Throughout the Port of Rotterdam  
 Equipment & Capacity: 4 floating cranes; up to 1,400 tph per crane  
 2 floating weighing towers for agri bulk only  
 Bulk Berths: No restrictions for Panamax vessels; even Cape size vessel are possible.  
 Total uncovered Storage: Floating storage vessel and numerous barges.  
 Total covered Storage: Floating storage vessel and numerous barges.  
 Fast, flexible and reliable high quality standards.

**Rotterdam**

**Van Uden NedCargo**  
 Van Maasdijkweg 27  
 Rotterdam  
 3088 EC  
 The Netherlands  
 Contact: Mr Diederik Antvelink  
 T: + 31 10 7990200  
 F: + 31 10 7990299  
 E: d.antvelink@van-uden.nl  
 W: www.NedCargo.com

**Rotterdam**

**Van Uden Stevedoring**  
 Gustoweg 68  
 (Port number 385)  
 Rotterdam  
 3029 AS  
 The Netherlands  
 Contact: Mr Gerard de Jong  
 T: + 31 10 476 0171  
 F: + 31 10 476 1927  
 E: g.dejong@vanudenstevedoring.nl  
 W: www.vanuden.nl  
 Location: Rotterdam  
 Equipment & Capacity: 6 cranes each a capacity of 500 tons an hour  
 Bulk Berths: 650 mtr quay length, draft 10.2m (high tide), draft 9.65m (low tide)  
 Total uncovered Storage: 25,000 sqm  
 Total covered Storage: 20,000 sqm  
 10 bunkers with capacity of 500 tons each.

**Rotterdam**

**C. Steinweg-Handelsvem BV**

Parmentierplein 1  
 Rotterdam  
 Zuid-Holland  
 3088 GN  
 The Netherlands  
 Contact: Mr Henk Poen  
 Director Ferro Alloys  
 T: + 31 10 487 93 96  
 F: + 31 10 487 92 78  
 E: h.poen@nl.steinweg.com  
 W: www.steinweg.com  
 Location: Waalhaven, The Netherlands. Rotterdam, Port NO. 2186  
 Equipment & Capacity: Cranes, crushing/screening possibilities  
 Bulk Berths: Quayside of 300m.  
 Draught approx. 10m.  
 Total uncovered Storage: 40,000 sqm  
 Total covered Storage: 60,000 sqm  
 Stevedoring/storage/crushing/screening.  
 g. Packing of bulk ferro alloy.

**Rotterdam**

**Stuwadoors en Controlebedrijf BV**  
 Dodewaardstraat 14  
 Rotterdam

3087 BA  
 The Netherlands  
 Contact: Mr Nico Westerdeke  
 T: + 31 10 28 31 044  
 F: + 31 10 28 31 040  
 E: info@oosterom.com  
 W: www.oosterom.com

**Rotterdam**

**Europees-Massagoed Overslagbedrijf (EMO) BV**



PO Box 9000  
 Maasvlakte RT  
 Rotterdam  
 3199 XA  
 The Netherlands  
 Contact: Mr Sjaak Roukema  
 Commercial Manager  
 T: + 31 181 371113  
 F: + 31 181 371222  
 E: j.c.roukema@emo.nl  
 W: www.emo.nl  
 Location: Maasvlakte - Rotterdam  
 Equipment & Capacity: 1 x 36 tonne lift capacity floating crane  
 3 x 85 tonne lift capacity grab unloaders  
 2 x 55 tonne lift capacity grab unloaders  
 Bulk Berths: Draught 23m.  
 Storage capacity 7 million m<sup>3</sup>  
 Total covered Storage: EMO offers a discharge capacity of around 42 mta.  
 Daily unloading rates of up to 175,000 tonnes  
 4 bulk carriers can be accommodated simultaneously.

**Rotterdam**

**Port of Rotterdam**

PO Box 6622  
 Rotterdam  
 3002 AP  
 The Netherlands  
 Contact: Mr Karel Peters  
 Business Manager Dry Bulk  
 T: + 31 10 252 1204  
 F: + 31 10 252 1020  
 E: ksm.peters@portofrotterdam.com  
 W: www.portofrotterdam.com  
 Location: Rotterdam, The Netherlands  
 Total port area 10,500 ha  
 Area of industrial sites 5,100 ha  
 Bulk cranes 58  
 Dry Bulk terminals 15  
 Bulk Berths: Area of water 3,440 ha  
 Infrastructure 1,960 ha  
 Port length 40 km  
 Quay length 74 km  
 Slope length 187 km

Total covered Storage: 4.7 million (m<sup>2</sup>) total Rotterdam + other great Rotterdam  
 The aim of the Port of Rotterdam Authority is to enhance the port of Rotterdam's competitive position as a logistics hub and world-class industrial complex. Not only in terms of size, but also quality. The core tasks of the Port Authority are to develop, manage and run the port in a sustainable way and to maintain a speedy and safe service for shipping.

**Rotterdam**

**RHB Stevedoring & Warehousing**



Waalhaven NZ 4  
 Port Number 2 1 5 7  
 Rotterdam  
 ZH  
 3087 BL  
 The Netherlands  
 Contact: Mr Peter van der Pluijm  
 Managing Director  
 T: + 31 10 429 9433  
 F: + 31 10 429 0261  
 E: office@rhb.nl  
 W: www.rhb.nl  
 Location: Rotterdam - The Netherlands  
 Equipment & Capacity: Shorecranes up to 208 m/tons. Floating cranes up to 1500 m/tons  
 Bulk Berths: ISPS certified quay of 730m length with 8 shorecranes & 4 floating cranes, max draught 10m. AEO-F certified.  
 Total uncovered Storage: 30,000sqm  
 Total covered Storage: 15,000sqm  
 Handling project cargoes, industrial breakbulk, heavy lifts, metals, steel and general cargoes incl. oversized.

**Rotterdam**

**Van Uden Bulk Logistics**

Gustoweg 68  
 Rotterdam  
 3029 AS  
 The Netherlands  
 Contact: Mr Robert van Muiden  
 General Manager  
 T: + 31 10 221 40 20  
 F: + 31 10 476 19 27  
 E: r.vanmuiden@vubl.nl  
 W: www.van-uden.nl  
 Location: Port of Rotterdam  
 Equipment & Capacity: 7 cranes, private owned terminal warehouses, weighing bridge etc.



**YOUR PARTNER IN LOGISTICS**



# EMO – 40 years fully equipped to meet your expectations



Please visit [emo.nl](http://emo.nl) to monitor our progress.





## LOOK TO THE FUTURE AND PLAN AHEAD

Since 1973, the EMO terminal in the Rotterdam port has been a major hub in transporting coal and iron ore from all over the world to the European hinterland. EMO has always been a reliable partner for its customers in helping to control these flows of goods by combining daily processes with a clear vision for the future.

EMO is able to accommodate the world's largest dry bulk vessels, and yet we never cease to look to the future and plan ahead – now more than ever! In 2012, we have strongly increased our storage and transshipment capacity and efficiency by commissioning five new, state-of-the-art projects: the seventh stacker reclaimer, the fifth unloader, the second fully automated coal wagon loader, a brand-new sea-going vessel loader along an innovative, new quay, and a high-tech operations centre. These projects ensure that we are fully equipped to enhance our safety, efficiency and sustainability performance, and to continue to serve you as a reliable partner in dry bulk transshipment in the coming decades.





## European Bulk Services Rotterdam



**European Bulk Services (E.B.S.) B.V.**

Elbeweg 117 ▶ Europoort Rotterdam ▶ Port no. 5820 ▶ P.O. Box 1204 ▶ 3180 AE ▶ Rozenburg ▶ The Netherlands  
T +31(0)181-258121 ▶ F +31(0)181-258154 ▶ E sales@ebsbulk.nl ▶ W www.ebsbulk.nl



Bulk Berths: Merwehaven Bulk Terminal nr. 385  
 Total uncovered Storage: 50,000 sqm  
 Total covered Storage: 12,500 sqm  
 Specialized in door-to-door logistic services for drybulk minerals as well as packed in bigbags and/or pallets. GMP certified.

**Rotterdam**  
**European Bulk Services (EBS) BV**



Elbeweg 117, Port number 5820  
 3198 LC Europoort-Rotterdam  
 P.O. Box 1204  
 180 AE Rozenburg  
 Rotterdam  
 Zuid Holland  
 3180 AE  
 The Netherlands  
 Contact: Mr Taco de Vries  
 Managing Director  
 T: + 31 181 258 147  
 F: + 31 181 258 154  
 E: sales@ebsbulk.nl  
 W: www.ebsbulk.nl  
 Location: Rotterdam, The Netherlands  
 Equipment & Capacity: Floating grab cranes; gantry cranes 36t  
 Bulk Berths: Panamax, cape , coaster berth  
 Total uncovered Storage: 35 ha  
 Total covered Storage: 500,000m<sup>3</sup>  
 1 agri-bulk/grain handling terminal  
 1 multi purpose bulk terminal (coal, minerals, Agri, Biomass)  
 Floating cranes  
 Various storage modes for different products



**Rotterdam**  
**Meneba**  
 Posbus 5149  
 Rotterdam  
 3008 AC  
 The Netherlands  
 Contact: Ms Wendy de Vos  
 T: + 31 10 4238911  
 F: + 31 10 4238625  
 E: w.devos@meneba.com  
 W: www.meneba.com

**Rozenburg**  
**EP Shipping & Trading BV**  
 PO Box 1050  
 Rozenburg  
 3180 AB  
 The Netherlands  
 Contact: Mr Eddy Van de Wijngaart (snr)  
 T: + 31 181 402 788  
 F: + 31 181 402 689  
 E: eps@epship.nl  
 W: www.epship.nl

**Sas van Ghent**  
**Zuid-Chemie**  
 Westkade 38a  
 PO Box 70  
 Sas van Ghent  
 4550 AB  
 The Netherlands  
 Contact: Mr Wim Wille  
 Marketing Department  
 T: +31 115 456 000  
 F: +31 115 451 647  
 E: info.nl@rosier.eu  
 W: www.zuidchemie.nl

**Sas van Ghent**  
**Cerestar Benelux**  
 PO Box 9  
 Sas van Ghent  
 4550 AB  
 The Netherlands  
 Contact: Mr Tony van der Stad  
 T: + 31 115 459 000  
 F: + 31 115 451 033  
 E: info@cerestar.com  
 W: www.cerestar.com

**Schiedam**  
**Van Mannekus & Co**  
 Nieuwe Waterwegstraat 540  
 Schiedam  
 The Netherlands  
 Contact: Mr Henk Don  
 Manager  
 T: + 31 10 409 15 00  
 F: + 31 10 473 08 80  
 E: h.don@mannekus.com

**Schiedam**  
**Nieuwe Waterweg Silo**  
 Nieuwe Waterwegstraat 53-55  
 (Port 542-543)  
 Schiedam 3115 HE  
 The Netherlands  
 Contact: Mr Jan Maasdam  
 Manager  
 T: + 31 10 427 12 30  
 F: + 31 10 473 75 73  
 E: jmaasdam@nwssilo.nl  
 W: www.nwssilo.nl  
 Location: Schiedam, Netherlands.  
 Port of Rotterdam on the Main waterway  
 Equipment & Capacity: 2 floating cranes. 500 tph  
 Bulk Berths: Portnr 542 120m length - 8m depth  
 Portnr 543 120m length - 8m depth  
 Total uncovered Storage: 2,500sqm  
 Total covered Storage: Silo of 9 bins.  
 4200 m<sup>3</sup> capacity total (for cereals)

**Spijkensisse**  
**SGS (Nederland) BV**  
 Malledijk 18  
 Spijkensisse  
 AE 3200  
 The Netherlands  
 Contact: Mr Rolf Wiltling  
 T: + 31 181 69 3260

F: + 31 181 69 3581  
 E: rolf.wiltling@sgs.com  
 W: www.sgs.nl  
 We are an inspection company present in all segments

**Stiens**  
**EMG-Silo Groningen**  
 PO Box 22  
 Stiens  
 9050 AA  
 The Netherlands  
 Contact: Mr Sjoerd De Vries  
 T: + 31 566 625710  
 F: + 31 566 625711  
 E: sj.devries@tell.devries.nl  
 W: http://www.feedlogistics.nl

**Terneuzen**  
**Zeeland Seaports**



**Zeeland Seaports**  
 NOT AGENCY

PO Box 132  
 Terneuzen  
 4530 AC  
 The Netherlands  
 Contact: Mr Arno Dirkzwager  
 Public Relations Officer  
 T: + 31 115 647 400  
 F: + 31 115 647 500  
 E: arno.dirkzwager@zeeland-seaports.com  
 W: www.zeeland-seaports.com  
 Location: At the entrance of the Western Scheldt River  
 Zeeland Seaports represent the ports of Terneuzen and Vlissingen. Both ports have an open connection to the North Sea. Vessels with a draught of 16.5m can be accommodated.

OUR FOCUS  
 ON CUSTOMERS  
 MAKES THE  
 DIFFERENCE

The seaports of Terneuzen and Vlissingen provide an ideal gateway between northern Europe and the rest of the world. They guarantee a rapid flow of goods thanks to their easy accessibility, deepwater location and excellent facilities. The two modern ports are strategically located between Rotterdam and Antwerp, at the mouth of the Western Scheldt. Together with a first-rate network of congestion-free roads, railways and waterways, this ensures fast and effective transport links with the hinterland. The key advantages of Terneuzen and Vlissingen are customer-friendliness, tailor-made solutions and ample opportunities for logistics and industrial activity. And the Zeeland Seaports Authority is there to see that these important benefits are carefully maintained and safeguarded for all our customers.

driven by dedication 

schelpenpad 2 • p.o. box 132 • 4530 AC terneuzen • the netherlands  
 port@zeelandseaports.com • www.zeelandseaports.com  
 p +31 (0)115 647400 • f +31 (0)115 647500



# Quality in Bulk



Mr. F.J. Haarmanweg 16d  
4538 AR Terneuzen  
The Netherlands

Tel.: +31 115 676 700  
Fax: +31 115 620 316  
E-mail: info@ovet.nl

Contact: Mr. Jan Agten  
Mr. Bram Peters  
Mr. Sander van der Veeke

- **4 floating cranes**
- **80,000 t/day capacity**
- **Screening/crushing facilities**
- **Terminals in Terneuzen and Vlissingen**
- **Draught: 16.50 m SW**





**Terneuzen**

**Terneuzen Port Authority**  
 Zeeland Seaports  
 PO Box 132  
 Noorwegenweg 1  
 Terneuzen  
 4530 CA  
 The Netherlands  
 Contact: Mr Francesco Faes  
 Commercial Director  
 T: + 31 115 647400  
 F: + 31 115 647500  
 E: francesco.faes@zeeland-seaports.com

**Terneuzen**

**Ovet BV - Terneuzen Terminal**



Mr F.J. Haarmanweg 16 d  
 Terneuzen  
 Zeeland  
 NL-4538 AR  
 The Netherlands  
 Contact: Mr Jan Agten  
 Commercial Manager  
 T: + 31 115 676 700  
 F: + 31 115 620 316  
 E: info@ovet.nl  
 W: www.ovet.nl  
 Location: South West of The Netherlands:  
 Kaloothaven, Vlissingen +  
 Massagoedharbour, Terneuzen  
 Equipment & Capacity: 4 floating cranes (3 floating cranes with 25t lifting capacity each/ 1 floating crane with 36t lifting capacity)/ 80,000

tonnes per day / 1,000tph free digging capacity.  
 Bulk Berths: —Vlissingen Terminal:  
 Capesize up to 180,000 tonnes / Max draught 16.5m salt water/ 1,000m quay  
 -Terneuzen Terminal:  
 Panamax up to 80,000 tonnes / Max draught 12.5m fresh water/ 1,400m quay  
 -2 anchorage places on the river Scheldt  
 Total uncovered Storage: -  
 Vlissingen Terminal:  
 2,000,000 tonnes open storage/  
 315,000sqm paved terrain.  
 -Terneuzen Terminal:  
 600,000 tonnes open storage  
 160,000sqm paved terrain  
 Total covered Storage: 1 Shed with 6 compartments of 1,000sqm each. So total 6,000sqm.  
 Both terminals equipped with:  
 (Mobile) screening, crushing, blending and de-ironing installations.  
 Trainloading and mobileshore cranes.  
 Lightening operations possible for vessels which are too deep to enter the ports of Terneuzen, Ghent and Antwerp.

**Terneuzen**

**Verbrugge Terneuzen Terminals**  
 Finlandweg 13  
 Harbour 1265  
 Terneuzen  
 4530 AA  
 The Netherlands  
 Contact: Mr Mario H. L. van Rijt  
 Manager Bulk  
 T: + 31 115 646 491  
 F: + 31 115 646 490  
 E: mario.rijt@verbrugge.nl  
 W: www.verbrugge.nl



**International Shipping & Forwarding**

**Your solution for mineral logistics Bulk & Breakbulk**

- ◆ Short sea / deep sea chartering
- ◆ Ships agencies
- ◆ Barging
- ◆ Stevedoring
- ◆ Storage
- ◆ Door-to-door logistics
- ◆ Cargo inspection, supervision
- ◆ Weight / draught surveys
- ◆ Sampling, preparation and analysing
- ◆ Customs clearance
- ◆ GMP+ and ISO 9001 certified

**Hudig & Veder Bulk B.V.**

Debussystraat 2  
 3161 WD Rhoon  
 The Netherlands

T: +31 10 5066600 E:bulk@hudigveder.nl  
 F: +31 10 5012819 W: hudigveder.nl







**Any bulk commodity  
in any volume  
from any vessel,  
ROTTERDAM BULK TERMINAL  
... at any time.**



RBT is the Rotterdam *bulkterminal*  
that handles any kind of bulk in any volume, at any time  
with care and professionalism, fast and competitive.

Rotterdam Bulk Terminal offers you fast, reliable and flexible bulk handling, with a customer-friendly and highly service-oriented approach at an excellent price/quality ratio, no matter the volume or type of bulk that is involved. Extensive possibilities for specialized storage for a wide range of bulk commodities, combined with a huge capacity, offer you a maximum result.

*Rotterdam Bulk Terminal, better in bulk!*





**Vlaardingen**

**Rotterdam Bulk Terminal (R.B.T.) B.V.**



Schiedamsedijk 16  
(Harbour no. 610)  
Vlaardingen  
South Holland  
3134 KK  
The Netherlands  
Contact: Mrs Carola  
Broers-Keuning  
Director  
T: + 31 10 234 35 55  
F: + 31 10 234 21 85  
E: info@rbtrtrotterdam.com  
W: www.rbtrtrotterdam.com  
Location: Rotterdam Port Area  
Equipment & Capacity: 2 Gantry  
Cranes 350 - 600 tph  
Bulk Berths: 525m quay length and  
12m draught  
Total uncovered Storage: 50,000 sqm  
Total covered Storage: 20,000 sqm  
Throughput capacity of 3,000,000 tpa

**Vlaardingen**

**Vulcaanhaven BV**

Schiedamsedijk 2a  
(Port number 610)  
Vlaardingen  
3134 KK  
The Netherlands  
Contact: Mr T.J. (Hans) Meeuwisse  
Managing Director  
T: + 31 10 299 83 33  
F: + 31 10 299 83 30  
E: info@vulcaanhaven.nl  
W: www.vulcaanhaven.nl  
Location: Rotterdam, The Netherlands  
Equipment & Capacity: 2 x 16 mt  
gantry cranes  
Bulk Berths: Draft 39ft  
Total covered Storage: 33,000 sqm  
Rail connection. Situated 3 minutes  
from main highway.

**Vlaardingen**

**Port of Vlaardingen**

PO Box 1002  
Vlaardingen  
3130 EB  
The Netherlands  
Contact: Mrs Petra de Wit  
Harbour Master  
T: + 31 10 248 4561  
F: + 31 10 434 43 73  
E: p.de.wit@vlaardingen.nl  
W: www.havenkantoor.vlaardingen.nl  
Location: South West of Holland on  
the North Sea  
....being a neighbour of Rotterdam  
means sharing in the advantages of a  
world port. At the same time we can  
offer you a more personal approach!

**Vlissingen**

**Ovet BV - Vlissingen Terminal**

Mr F.J. Haarmanweg 16 d  
Terneuzen  
Zeeland  
NL-4538 AR  
The Netherlands  
Contact: Mr Jan Agten  
Commercial Manager  
T: + 31 115 676 700  
F: + 31 115 620 316  
E: info@ovet.nl  
W: www.ovet.nl  
Location: South West of The  
Netherlands:  
Kaloothoven, Vlissingen +  
Massagoedharbour, Terneuzen  
Equipment & Capacity: 4 floating  
cranes (3 floating cranes with 25t  
lifting capacity each/ 1 floating crane  
with 36t lifting capacity)/ 80,000

tonnes per day / 1,000tph free digging  
capacity.

Bulk Berths: - Vlissingen Terminal:  
Capesize up to 180,000 tonnes / Max  
draught 16.5m salt water/ 1,000m  
quay

-Terneuzen Terminal:  
Panamax up to 80,000 tonnes / Max  
draught 12.5m fresh water/ 1,400m  
quay

-2 anchorage places on the river  
Scheldt:  
For lightening vessels for Antwerp,  
Ghent and Terneuzen. Max draught  
16.5m salt water.

Total uncovered Storage: -  
Vlissingen Terminal:  
2,000,000 tonnes open storage/  
315,000sqm paved terrain.

-Terneuzen Terminal:  
600,000 tonnes open storage  
160,000sqm paved terrain  
Total covered Storage: 1 Shed with 6  
compartments of 1,000sqm each. So  
total 6,000sqm.

Both terminals equipped with:  
(Mobile) screening, crushing, blending  
and de-ironing installations.

Trainloading and mobileshore cranes.  
Lightening operations possible for  
vessels which are too deep to enter  
the ports of Terneuzen, Ghent and  
Antwerp.

**Zwijndrecht**

**Agro Delta Group**

Zwijndrecht  
Lindtsedijk 62  
PO Box 120  
Zwijndrecht  
ZH  
3330 AC  
The Netherlands  
Contact: Mr John van Belle  
Managing Director/Owner  
T: + 31 78 6100900  
F: + 31 78 6100301  
E: jvbelle@agro-delta.nl  
W: www.agro-delta.nl  
Location: The Netherlands, riverside  
near Rotterdam. Port of Dordrecht  
and Zwijndrecht.

Equipment & Capacity: 2 bulkcranes,  
shovels, fork-lift trucks, 3  
weighbridges, screening facilities for  
fertiliser, cleaning facilities for grains,  
seeds and pulses  
Bulk Berths: 4 berths, 3 with 4 mtr  
draught, 1 with 8,75 mtr draught  
Total covered Storage: 54,000 sqm,  
60,000 m.t. silo space  
Storage and handling of grains,  
seeds, pulses, rice, fertiliser,  
feedstuffs, breakbulk and rental of  
warehouses.

**TOGA**

**Lome**

**Office Togolaise des Phosphates**

PO Box 379  
Lome  
Toga  
Contact: Mr K Atefeibu  
Harbour Master  
T: + 228 213901  
F: + 228 217105

**TRINIDAD &**

**TOBAGO**

**Couvra Trinidad**

**Point Lisas Industrial Port**

**Development Corp Ltd**  
PO Bag 191  
Apdo Postal  
Couvra Trinidad  
Trinidad & Tobago

Contact: Ms Cindy Asevero  
T: + 1 868 636 2201  
F: + 1 868 679 7659  
E: casevero@plipdeco.com

**Point Lisas**

**Point Lisas Industrial Port**

**Development Corp**  
Atlantic Avenue  
Point Lisas Estate  
Point Lisas  
Trinidad & Tobago  
Contact: Mr Rawle Baddaloo  
Divisional Port Manager  
T: + 1 868 636 4913  
F: + 1 868 636 4061  
E: plipdeco@plipdeco.com  
W: www.trinidad.net/plipdeco

**Port of Spain**

**Port of Spain**

Port Authority of Trinidad and  
Tobago  
Dock Road  
Port of Spain  
Trinidad & Tobago  
Contact: Ms Kathleen Maxwell  
Manager  
T: + 868 623 2901 5

**Port of Spain**

**Chaguaramas Terminals Ltd**

Chag Terminals Drive  
PO Box 608  
Port of Spain  
Trinidad & Tobago  
General Manager  
T: + 1 86 634 4384  
F: + 1 86 634 4542

**Port of Spain**

**Cronstadt Island**

Baroid Trinidad Services Ltd  
PO Box 765  
Port of Spain  
Trinidad & Tobago  
Contact: Mr C Fuller  
General Manager  
T: + 1 86 680 2428  
F: + 1 86 627 5193

**Port of Spain**

**Port Authority of Trinidad and  
Tobago**

1 Dock Road  
Port of Spain  
Trinidad & Tobago  
Contact: Mr Kelvin Harris  
Divisional Manager Operations  
T: + 1 868 625-2644  
F: + 1 86 627 266  
E: kelvinh@patnt.com  
W: www.patnt.com

**TUNISIA**

**Bizerte**

**Office des Ports Nationaux**

**Tunisiens**  
Quai Tarek Ibn Ziad  
Bizerte  
7000  
Tunisia  
Contact: Mr Mohamed Adel  
Mokhtar  
Director  
T: + 216 2 431139  
F: + 216 2 433688  
E: ompmp@ompmp.nat.tn  
W: www.ompmp.nat.tn

**Bizerte**

**Port Authority of Bizerte**

Quai Tarek Ibn Zied  
Bizerte  
7000  
Tunisia  
Contact: Mr Ben Sadhel  
Port Director

T: + 216 71 735 300  
F: + 216 71 735 812  
E: ompmp@ompmp.nat.tn  
W: www.ompmp.nat.tn

**Port de la Goulette**

**Port Authority of Tunis Goulette**

Batiment Administratif  
Port de la Goulette  
Tunisia  
Port Director  
T: + 216 1 735 300  
F: + 216 1 736 812  
E: ompmp@ompmp.nat.tn  
W: www.ompmp.nat.tn

**Sfax**

**Port Authority of Sfax**

Office des Ports Nationaux  
Tunisiens  
Rue Okba Ibn Nafaa  
Sfax  
3029  
Tunisia  
Contact: Captain Lamere Chokri  
Port Captain  
T: + 216 4 225040  
F: + 216 4 225107  
E: ompmp@ompmp.nat.tn  
W: www.ompmp.nat.tn

**TURKEY**

**Bursa**

**Gemlik Port**

Kocacukur Mevkii  
101 Gemlik  
Bursa  
Turkey  
Contact: Mr Ali Kerim leil demirhan  
Assistant General Manager  
T: + 90 224 524 88 31  
F: + 90 224 524 88 30  
E: gempport@gempport.com.tr  
W: www.gempport.com.tr/

**Eregli**

**Eregli Port Authority**

Nevzat Direk  
Karadeniz Eregli  
Liman Baskanligi  
Eregli  
67330  
Turkey  
Contact: Mr Turget Ege  
Harbour Master  
T: + 90 372 323 1007  
F: + 90 372 323 1169  
E: kdzeregli@denizcilik.gov.tr  
W: www.denizcilik.gov.tr

**Hereke-Izmit**

**NUH Cement Factory of Hereke**

Akyar Mevkii  
PO Box 7  
Hereke-Izmit  
1000  
Turkey  
Contact: Mr Seyid Uluabay  
General Manager  
T: + 90 262 511 3975  
F: + 90 262 511 412

**Istanbul**

**Toros Tarim Sanayi ve Ticaret A -**

**TOROS Ceyhan Term**

Buyukdere Caddesi  
Tekfen Tower, 19th Floor  
4 Levent  
Sisli  
Istanbul  
Marmara  
34394  
Turkey  
Contact: Mr Aydin Erdemir  
Vice President - Terminal & Port  
Activities  
T: + 90 212 357 02 02 ext. 284/286  
F: + 90 212 357 02 31  
E: aydin.erdemir@toros.com.tr

W: www.toros.com.tr

Location: South of Turkey, on the  
South East Coast of Mediterranean  
Sea.

Seaports Coordinates - West Jetty  
36 55 00 N - 35 58 54 E

36 54 24 N - 35 59 06 E

Seaport Coordinates - East Jetty  
36 55 12 N - 35 59 18 E

36 54 30 N - 35 59 34 E

Equipment & Capacity: For Dry Bulk  
and General Cargo; up to 14,400,000  
tons loading/unloading capacity per  
year.

For Liquids (including petroleum and  
chemical products); up to 13,500,000  
tons loading/unloading capacity per  
year.

Bulk Berths: For dry bulk up to  
110,000 DWT.

For oil and chemical liquid up to  
40,000 DWT.

Total uncovered Storage: 1,000,000  
sqm

Total covered Storage: Warehouse  
capacity is 160,000 ton.

Storage Tanks capacity is 236,500  
m3.

Ceyhan Terminal is located in the  
heart of the Ceyhan Energy Zone in  
the East Med in proximity to the BTC  
(Baku Tbilisi Ceyhan crude oil pipe  
line) and Kerkuk-Ceyhan (Botas Iraq)  
crude oil pipe lines.

**Istanbul**

**Toros Tarim Sanayi ve Ticaret A -**

**TOROS Samsun Term**

Tekfen Tower, 19th Floor

4 Levent

Istanbul

Marmara

34394

Turkey

Contact: Mr Aydin Erdemir

Vice President - Terminal & Port

Activities

T: + 90 212 357 02 02 ext. 284/286

F: + 90 212 357 02 31

E: aydin.erdemir@toros.com.tr

W: www.toros.com.tr

Location: North of Turkey, on the

Black Sea Coast.

Seaport Coordinates 36 27 05 E - 41

15 00 N

Equipment & Capacity: For Dry Bulk

and General Cargo; up to 4,200,000

tons loading/unloading capacity per

year.

For Liquids (including petroleum and

chemical products); up to 4,500,000

tons loading/unloading capacity per

year.

Bulk Berths: For dry bulk and

chemical liquid up to 60,000 DWT.

Total uncovered Storage: 500,000

sqm.

Total covered Storage: 210,000 tons

**Izmir**

**Izmir Port**

General Directorate of Turkish

State Railways

Liman Isletmesi Mudurlugu

Izmir

Turkey

Port Director

T: + 90 232 463 2252

F: + 90 232 463 2248

E: izmiriman@tcdd.gov.tr

W: www.tcdd.gov.tr

**Mersin**

**Famagusta Port Authority**

Works and Tourism Ministry Ports

Department

Mersin

North Cyprus

10

Turkey

Contact: Mr Enver Yetili  
Director of Ports

T: + 90 392 36 62627  
F: + 90 392 36 66465  
E: fpa@cc.emu.edu.tr

## Tekirdag

**Tekirdag Port**  
TDI  
Tekirdag Liman Isletmesi  
Mudurlugu  
Tekirdag  
Turkey  
Contact: Mr Rasim Sinel  
Port Director  
T: + 90 282 261 0800  
F: + 90 282 261 2346

## Tekkeköy/Samsun

**Toros Tarım San. ve Tic. A.**  
Samsun Ordu Karayolu 14.km  
Sanayi Mah  
Tekkeköy/Samsun  
55300  
Turkey  
Contact: Mr Ismail Turan  
Toros Terminal Opr. Man  
T: + 90 2123570202  
F: + 90 2123570231  
E: ismail.turan@toros.com.tr  
W: www.toros.com.tr

## Trabzon

**Trabzon Port**  
Ports Management  
Trabzon Liman Isletmesi Mudurlugu  
Trabzon  
Turkey  
Contact: Mr Taner Kaskin  
Harbour Master  
T: + 90 462 321 1073  
F: + 90 462 322 1004  
E: info@cerahogullari.com.tr

## UAE

### Abu Dhabi

**Port Zayed**  
Abu Dhabi  
UAE  
Contact: Mr Mohammed Wagdy  
Corporate Communications &  
Branding Officer  
T: + 971 2 6975270  
F: + 971 2 6975166  
E: mohammed.wajdi@adterminals.ae  
W: www.portzayed.gov.ae

### Abu Dhabi

**Abu Dhabi Seaport Authority**  
PO Box 422  
Mina Zayed  
Abu Dhabi  
UAE  
Contact: Mr Mubarak Al Buainain  
Port Director  
T: + 971 2 730 6003  
F: + 971 2 731023  
E: mrktdebt@emirates.net.ae  
W: www.portzayed.gov.ae

### Ajman

**Emirates Ports Services**  
PO Box 388  
Ajman  
UAE  
T: + 971 06 7470111  
F: + 971 06 7470333  
E: mail@ajmanport.gov.ae  
W: www.ajmanport.gov.ae/

### Dubai

**Dubai Port World**  
PO Box 17000  
Dubai  
UAE  
Contact: Mr Abdul Rahim Al Qassim  
Director  
T: + 971 4 2621241  
F: + 971 4 2663331  
E: AbdulRahim.alQassim@

dpworld.com  
W: www.dpworld.ae/

## Dubai

**DP World**  
PO Box 17000  
Dubai  
UAE  
Contact: Mr Raveen Guliani  
T: + 971 4 881 5645  
F: + 971 4 881 7777  
E: marketing@dpworld.com  
W: www.dpworld.com

## UAE

### Fujairah

**Port of Fujairah**  
PO Box 787  
Fujairah  
UAE  
Contact: Captain Mousa Morad  
General Manager  
T: + 971 9222 8800  
F: + 971 9222 8811  
E: Gms\_pof@fujairahport.ae  
W: www.fujairahport.ae

## UK

### Ayr

**Ayr**  
ABP Port Office  
Ayr  
Ayrshire  
KA8 8AH  
UK  
Contact: Mr P Creswell  
Port Manager  
T: + 44 1292 281 687  
F: + 44 1292 287 787  
E: ayr@abports.co.uk  
W: www.abports.co.uk

### Ayr

**Associated British Ports (Ayr and Troon)**  
Associated British Ports  
Port Office  
North Harbour Street  
Ayr  
KA8 8AH  
UK  
Contact: Mr Colin Hume  
Commercial & Administration  
Manager  
T: + 44 1292 281687  
F: + 44 1292 287787  
E: chume@abports.co.uk  
W: www.abports.co.uk  
Location: West Coast of Scotland,  
entrance to the Firth of Clyde  
Equipment & Capacity: 3 hydraulic  
excavator cranes, several shovels,  
telehandlers, FLTs 1 rail wagon  
discharge, rail connected quays  
Bulk Berths: Various - Max Length  
110m, Max Draught 5.8m - 6.2m  
Total uncovered Storage: Extensive  
Total covered Storage: 17,500sqm  
Also experienced in Heavy Lift  
operations.

### Barrow upon Humber

**New Holland Bulk Services**  
PO Box 1, Old Ferry Terminal  
New Holland  
Barrow upon Humber  
South Humberside  
DN19 7SD  
UK  
Contact: Mr James Lyne  
Managing Director  
T: + 44 1469 531 102  
F: + 44 1469 531 966  
E: james.lyne@  
newhollandbulkservices.co.uk

## Barrow-In-Furness

**Port of Barrow-in-Furness**  
Associated British Ports  
Ramsden Dock Road  
Barrow-In-Furness  
Cumbria  
LA14 2TW  
UK  
Contact: Mr Chris Clouter  
Port Operations Manager  
T: + 44 1229 822911  
F: + 44 1229 835822  
E: barrow@abports.co.uk  
W: www.abports.co.uk  
Location: North West England, West  
Coast, Irish Sea  
Total uncovered Storage: 200,000sqm  
Total covered Storage: 6,000sqm  
Ideal base port for offshore wind farm  
installation projects and long term  
O&M.

## Belfast

**Belfast Harbour Commissioners**  
Harbour Office  
Corporation Square  
Belfast  
BT1 3AL  
UK  
Deputy Harbour Master  
T: + 44 2890553015  
E: michael.evans@belfast-  
harbour.co.uk  
W: www.belfast-harbour.co.uk/  
Location: N. Ireland  
Equipment & Capacity: Over 3 million  
tonnes of Dry Bulk products each  
year.  
Almost 500,000 tonnes of Break Bulk  
in 2003.  
Please see website for equipment  
details.

## Berwick-Upon-Tweed

**Berwick Harbour Commission**  
Harbour Master's Office  
Tweed Dock  
Berwick-Upon-Tweed  
Northumberland  
TD15 2AB  
UK  
Contact: Mr. Alan Irving  
CEO  
T: + 44 1289 307404  
F: + 44 1289 332 854  
E: info@bhshipping.com  
W: www.portofberwick.co.uk

## Blyth

**Port of Blyth**  
South Harbour  
Blyth  
Northumberland  
NE24 3PB  
UK  
Contact: Mr Martin Lawlor  
Commercial Director  
T: + 44 1670 352066  
F: + 44 1670 368540  
E: commercial@blythport.co.uk

## Bootle

**E-ON UK Liverpool**  
Bulk Terminal  
Gladstone Dock  
Bootle  
Merseyside  
L20 1BE  
UK  
Contact: Mr Ken Jones  
T: + 44 151 933 0860  
F: + 44 151 933 0867  
E: ken.jones@eon-uk.com

## Boston

**Lingrain Services Ltd**  
The Dock  
Boston  
Lincs  
PE21 6BJ  
UK

Contact: Mr Tony A Drew  
Manager  
T: + 44 1205 366 484  
F: + 44 1205 368242  
E: tony.drew@centaurgrain.com

## Bristol

**The Bristol Port Company**  
St Andrews House  
St Andrews Road  
Avonmouth  
Bristol  
Avon  
BS11 9DQ  
UK  
Contact: Mrs Jullie Gough  
Commercial Executive  
T: + 44 117 982 0000  
F: + 44 117 982 0698  
E: julie.gough@bristolport.co.uk  
W: www.bristolport.co.uk  
Location: Bristol Port - South West  
England  
Equipment & Capacity: Royal  
Portbury Dock - 2 Continuous Ship  
Unloaders 2500tph, , Shiploader  
2000tph.  
Avonmouth Dock - Gottwald 260  
HMK, 3 x mobile cranes & numerous  
jib cranes.  
Bulk Berths: 300m loa, 41m breath,  
14.5m draught  
Total uncovered Storage: Royal  
Portbury - 700,000t Coal  
Total covered Storage: Royal Portbury  
- 200,000t AFS

## Cannington

**European Metal Recycling Ltd**  
Bidden Street  
Cannington  
London  
E16 4SZ  
UK  
Contact: Mr Bob Garwood  
Southern Director  
T: + 44 20 7476 3104  
F: + 44 20 7474 5633  
E: bob.garwood@emrltd.com  
W: www.emrltd.com  
Location: London, North side of River  
Thames.  
Equipment & Capacity: Bulk handling  
cranes  
Bulk Berths: Handle vessels up to  
4,000 DWCC  
Total uncovered Storage: 10,000sqm  
Total covered Storage: None

## Cardiff

**Associated British Ports**  
Queen Alexandra House  
Cargo Road  
Cardiff  
CF10 4LY  
UK  
Contact: Mr Callum Couper  
Port Manager  
T: + 44 870 609 6699  
F: + 44 29 208 35001  
E: ccouper@abports.co.uk  
W: www.abports.co.uk  
Location: South Wales  
Equipment & Capacity: Cranes up to  
45MT, Materials Handlers, Various  
Quayside Equipment and mobile plant  
Bulk Berths: Up to 35,000 dwt  
Total uncovered Storage: In excess of  
250,000sqm  
Total covered Storage: Circa  
100,000sqm  
Port of Cardiff has road connections  
to the M4 and links to the Midlands as  
well as rail connections to the national  
network.

## Cardiff

**ABP South Wales (Ports of Newport, Cardiff, Barry, Port Talbot & Swansea)**  
Queen Alexandra House

Cargo Road  
Cardiff  
South Glamorgan  
CF10 4LY  
UK  
Contact: Mr Matthew Kennerly  
Port Director  
T: + 44 870 609 6699  
F: + 44 2920 835001  
E: mkennery@abports.co.uk  
W: www.abports.co.uk

## Coleraine

**Coleraine Harbour Commissioners**  
Harbour Office  
4 Riversdale Road  
Coleraine  
Co Londonderry  
BT52 1RY  
UK  
Contact: Mr Pat McKeegan  
Harbour Manager  
T: + 44 28 703 42012  
F: + 44 28 703 52000  
E: coleraineharbour@aol.com  
W: www.ports.org.uk/

## Dundee

**Grainfax**  
Carolina Port  
Dundee Harbour  
Dundee  
DD1 3LW  
UK  
Contact: Mr Alan Burns  
T: + 44 132 4668 400  
F: + 44 1382 878 135  
E: alan.burns@forthports.co.uk  
W: www.grainfax.co.uk  
Location: Dundee, East of Scotland  
Equipment & Capacity: 2 Cranes -  
300 t per hour  
Bulk Berths: Up to 9.5 m, 400 m lda  
Total covered Storage: 20 000 sqm

## Dundee

**Forth Ports PLC - Port of Dundee**  
King George V Wharf  
Port Control Office  
Dundee  
DD1 3LJ  
UK  
Contact: Mr Matt North  
Port Manager  
T: + 44 1382 224121  
F: + 44 1382 200834  
E: matt.north@forthports.co.uk  
W: www.forthports.co.uk

## Egham

**Cemex UK**  
Coldharbour Lane  
Thorpe  
Egham  
Surrey  
TW20 8TD  
UK  
Contact: Mr Gavin Cowen  
Plant Director  
T: + 44 1932 568 833  
F: + 44 1375 856618  
E: gavin.cowen@cemex.com  
W: www.cemex.co.uk/

## Falmouth

**A & P Falmouth Ltd**  
The Docks  
Falmouth  
Cornwall  
TR11 4NR  
UK  
Contact: Mr Mike Reynolds  
Port Operations Director  
T: + 44 1326 212100  
F: + 44 1326 211635  
E: mike.reynolds@ap-falmouth.co.uk  
W: www.ap-group.co.uk  
Location: South West of England  
Equipment & Capacity: 1 X Liebherr  
LHM 150.



Grab cranes, up to 500 tonnes per hour  
Bulk Berths: 3 berths total length: 640m, maximum draught 8.2m  
Total uncovered Storage: 10,000 sqm  
Total covered Storage: 7,500 sqm  
Strategically placed in SW approaches of English Channel. Rail connected and capable of handling a wide range of commodities.

**Felixstowe**

**Felixstowe Dock & Railway Company**

Tomline House  
The Docks  
Felixstowe  
Suffolk  
IP11 8TB  
UK  
Contact: Mr Richard Pearson  
Managing Director  
T: + 44 1394 604500  
F: + 44 1394 604929  
E: enquiries@fdrc.co.uk  
W: www.portoffelixstowe.co.uk/

**Feltham**

**RMC Feltham**

RMC House  
High Street  
Feltham  
Surrey TW13 4HA  
UK  
Contact: Mr Sean Hayward  
T: + 44 208 751 0006  
E: info@rmc-group.com

**Fowey**

**Fowey Harbour Commissioners**

Harbour Office  
Albert Quay  
Fowey  
Cornwall  
PL23 1AJ  
UK  
Contact: Mr M J Sutherland  
Chief Executive Officer/Harbour Master  
T: + 44 1726 832472  
F: + 44 1726 833738  
E: info@foweyharbour.co.uk

**Garston**

**ABP - Garston**

Dock Road  
Garston  
Liverpool  
L19 2JW  
UK  
Contact: Mr Paul Jervis  
Port Manager  
T: + 44 151 427 5971  
F: + 44 151 494 3232  
E: pjervis@abports.co.uk  
W: www.abports.co.uk  
Location: North West England on North Bank of River Mersey. 10km upstream from Liverpool City Centre  
Lat 50 21'N Long 02 54'W  
Equipment & Capacity: 2 Mobile exc/Heavy Lift crane/Grain conveyors  
Bulk Berths: Various upto 150m LOA  
Total uncovered Storage: 30,000sqm  
Total covered Storage: 10,000sqm  
Duty Free/TASCC/Soil Association approved bulk stores.

**Glasgow**

**Clydeport Operations**

16 Robertson Street  
Glasgow  
Ayrshire  
G2 8DS  
UK  
Contact: Mr David Jerome  
Marketing  
T: + 44 1412218733  
E: david.jerome@clydeport.co.uk  
W: www.clydeport.co.uk

**Glasgow**

**Clyde Port Authority**

16 Robertson Street  
Glasgow  
Strathclyde  
G2 8DS  
UK  
Contact: Mr David Jerome  
Marketing  
T: + 44 141 241 8530  
E: david.jerome@clydeport.co.uk

**Goole**

**ABP - Goole Port**

East Parade  
Goole  
East Yorkshire  
DN14 5RB  
UK  
Contact: Mr Phil Coombes  
Commercial Manager  
T: + 44 1482 327 171  
F: + 44 1482 608 434  
01482 608 434  
E: pcoombes@abports.co.uk  
W: www.abports.co.uk

**Grangemouth**

**Leith Docks**

Forth Ports PLC  
Carron House  
Central Dock Road  
Grangemouth  
Scotland  
SK38TY  
UK  
Contact: Mr Alan C Burns  
T: + 44 131 555 8750  
F: + 44 131 555 1212  
E: alan.burns@forthports.co.uk  
W: www.forthports.co.uk

**Grangemouth**

**Casper Shipping Ltd**

2nd Floor  
5 Kerse Road  
Grangemouth  
FK3 8HQ  
UK  
Contact: Mr Douglas Couser  
Office Manager  
T: + 44 1324 486486  
F: + 44 1324 486444  
E: dcouser@casperitd.com  
W: www.casperitd.com

**Grangemouth**

**Grangemouth**

Forth Ports PLC  
Dock Office  
Grangemouth  
Stirlingshire  
FK3 8UE  
UK  
Contact: Mr Derek Knox  
Port Manager  
T: + 44 1324 482591  
F: + 44 1324 665106  
E: enquiries@forthports.co.uk  
W: www.forthports.co.uk  
Location: Grangemouth on the Firth of Forth  
Equipment & Capacity: 3 x Ship-to-shore Container Cranes, 13 x Straddle Carriers, 3 x Empty Container Handlers, 2 x 40tonne FLT's  
Total uncovered Storage: 5,000sqm  
Total covered Storage: 19,000sqm

**Grangemouth**

**Forth Ports Plc**

Carron House  
Central Dock Road  
Grangemouth  
Stirlingshire  
FK3 8TY  
UK  
Contact: Mr Dave Mc Pherson  
Port Manager  
T: + 44 1324 668 400

F: + 44 1324 668 484  
E: marketing@forthports.co.uk  
W: www.forthports.co.uk

**Gravesend**

**Port of London Authority**

London River House  
Royal Pier Road  
Gravesend  
DA12 2BG  
UK  
Contact: Mr Doug Kempster  
Marketing  
T: + 44 14 7456 2366  
F: + 44 14 7456 2398  
E: martin.garside@hotmail.com  
W: www.portoflondon.co.uk

**Great Yarmouth**

**East Port UK**

20/21 South Quay  
Great Yarmouth  
Norfolk  
NR30 2RE  
UK  
Contact: Mr Eddie Freeman  
Chief Executive  
T: + 44 1493 335500  
F: + 44 1493 852480  
E: efreeman@eastportuk.co.uk  
W: www.eastportuk.co.uk

Location: Norfolk (East Coast)  
Equipment & Capacity: Fleet of cranes up to 80 tonne truck mobile equivalent, grain elevators, forklift trucks, mechanical loading shovels.  
Full specifications available on application.

Bulk Berths: 6 kilometres of commercial quays. Main bulk berths located at East Quay, Ocean Terminal, Atlas Terminal. All vessels that can gain entry to the port can access all berths.  
Total uncovered Storage: Open Storage in excess of 40 acres available  
Total covered Storage: Warehouses are located at strategic points around the port varying in size from 8,000 to 25,000 sq ft. total available approximately 250,000 sq ft  
Access is normally available on a round-the-clock basis. Very low tidal range (less than 2m). No locks or bridges in the commercial area.  
2 weighbridges and state of the art grain testing equipment available on site.

**Grimsby**

**Associated British Ports - Grimsby & Immingham**

Port Office  
Cleethorpe Road  
Grimsby  
North East Lincolnshire  
DN31 3LL  
UK  
Contact: Mr John Fitzgerald  
Port Director  
T: + 44 1472 359 181  
F: + 44 1472 242 488  
E: jfitzgerald@abports.co.uk  
W: www.abports.co.uk

**Hartlepool**

**Tees and Hartlepool Port Authority**

Hartlepool Docks  
Middleton Road  
Hartlepool  
Cleveland TS24 0SE  
UK  
Contact: Ms Kirsten Potter  
Marketing  
T: + 44 1642 87 7000  
F: + 44 1642 87 7056  
E: kirsten.potter@pdports.co.uk  
W: www.thpal.co.uk

**Holywell**

**Mostyn Docks Limited**

Mostyn  
Holywell  
Clwyd  
CH8 9HD  
UK  
Contact: Mr R C Hyde-Linaker  
Harbour Master  
T: + 44 1745 560335  
F: + 44 1745 560324  
E: harbourmaster@portofmostyn.com  
Location: North East Wales  
Equipment & Capacity: One crane up to 26t, FLT up to 25t. Loading Shovels Bobcats Etc.  
Bulk Berths: Up to 120m length overall and 6m draught.  
Total uncovered Storage: 5 Acres adjacent to berths  
Total covered Storage: 25,000sqm

**Hull**

**Titan Cement UK**

Shed 12  
King George Dock  
Hull  
HU9 5PR  
UK  
Contact: Mr Phil Langdale  
General Manager  
T: + 44 1482 784 012  
F: + 44 1482 784 013  
E: info@titanuk.co.uk  
W: www.titanuk.co.uk

**Hull**

**ABP - Port of Hull**

PO Box 1  
Port House  
Northern Gateway  
Hull  
HU9 5PQ  
UK  
Contact: Mr Phill Coombes  
Commercial Manager  
T: + 44 1482 327 171  
F: + 44 1482 326 283  
E: pcoombes@abports.co.uk  
W: www.abports.co.uk

**Hull**

**Frontier Agriculture Ltd**

King George Dock  
Hull  
HU9 5PR  
UK  
Contact: Mr Tony Greendale  
Silo Manager  
T: + 44 1482 701281  
F: + 44 1482 784891  
E: tony.greendale@frontierag.co.uk

**Immingham**

**Casper Shipping Ltd**

Riverside House  
East Riverside  
Immingham  
NE Lincolnshire  
DN40 2LZ  
UK  
Contact: Mr David Healey  
T: + 44 1469 575 246  
F: + 44 1469 575 589  
E: immingham@casperitd.com  
W: www.casperitd.com  
Location: North East Lincolnshire  
Equipment & Capacity: 3 x shore mobile and 2 x shore gantry  
Bulk Berths: LOA 295m x beam 45m x airdraft 17m x draught 14.20m - subject to tidal conditions  
Tidal predictions available on request.

**Ipswich**

**ABP Port of Lowestoft**

Old Custom House  
Key Street  
Ipswich  
Suffolk  
IP4 1BY

UK

Contact: Mr Alastair MacFarlane  
Port Manager  
T: + 44 147 323 1010  
F: + 44 147 328 8488  
E: amacfarlane@abports.co.uk  
Location: East of England on the North Sea  
Bulk Berths: Silo berth 10,000t grain & 4,000t cement  
Total uncovered Storage: 6m draught m.a.a.b.j.a. 10,000 approx  
Total covered Storage: 10,000sqm

**Ipswich**

**ABP - Port of Ipswich**

Old Custom House  
Key Street  
Ipswich  
Suffolk  
IP4 1BY  
UK  
Contact: Mr Alan Mason  
Sales Manager  
T: + 44 1473 231010  
F: + 44 1473 230914  
E: amason@abports.co.uk  
W: www.abports.co.uk  
Location: East coast, Suffolk, England  
Equipment & Capacity: All equipment necessary for bulk/neo bulk cargoes.  
Bulk Berths: Vessels up to 15,000dwt.  
Total uncovered Storage: Various areas at all port berths.  
Total covered Storage: 74,000sqm  
Extensive variety of purpose built, modern, storage facilities adjacent to berths.

**Ipswich**

**The Grain Terminal (Ipswich) Ltd**

Cliff Quay  
Ipswich  
Suffolk  
IP23 0BG  
UK  
Contact: Mr Tim Capey  
Director  
T: + 44 1473 250461  
F: + 44 1473 233212  
E: info@grainterminal-ips.com  
W: www.ipswichgrainterminal.com/  
Location: East Anglia  
Equipment & Capacity: Ipswich (600 mt load rate/hr)  
Ipswich (5 cranes)  
Harwich Grain Terminal (6000 mt load rate /day)  
Total covered Storage: Ipswich 80,000 mt  
Harwich 25,000 mt

**Ipswich**

**Clarksons Port Services**

Sentinel Terminal  
East Bank  
Cliff Quay  
Ipswich  
IP3 0BS  
UK  
Contact: Mr Julian Scott  
Director  
T: + 44 1473 254435  
F: + 44 1473 254438  
E: Julian.Scott@clarksons.com  
W: www.clarksons.com

**Isle of Man**

**Port of Ramsey**

Harbour Master's Office  
East Quay  
Ramsey  
Isle of Man  
IM8 1BG  
UK  
The Manager  
T: +44 1624 812 245  
F: + 44 1624 815 361  
E: ramsey.port@gov.im  
W: www.gov.im/harbours  
Location: Isle of Man  
Equipment & Capacity: Private.

Mobile cranes  
Bulk Berths: L = 58m. Max draught  
4.0m spring tide  
Total uncovered Storage: None  
Total covered Storage: Private  
warehouse

## Kings Lynn

**King's Lynn Conservancy Board**  
Harbour Office  
Common Staith  
Kings Lynn  
Norfolk  
PE30 1LL  
UK  
Contact: Mr J Lorking  
Harbour Master  
T: + 44 1553 773411  
F: + 44 1553 768185  
E: harbourmaster@  
portauthoritykingslynn.fsnet.co.uk

## Liverpool

### Mersey Docks & Harbour

**Company**  
Maritime Centre  
Port of Liverpool  
Liverpool  
Merseyside  
L21 1LA  
UK  
Contact: Mr Dean Hammond  
Business Development Manager -  
Bulk Solids  
T: + 44 1928 508555  
F: + 44 151 949 6300  
W: www.merseydocks.co.uk  
Location: North West of England at  
mouth of River Mersey  
Equipment & Capacity: Specialist  
crane and equipment to handle all  
cargoes specific to the Port  
Bulk Berths: Numerous berths and  
facilities located in both Liverpool and  
Birkenhead Dock systems.  
Total uncovered Storage: 8,100,000  
sqm  
Total covered Storage: 500,000 sqm  
A multi functional Port with individual  
companies specialising in the  
handling, storage, and distribution of  
the various commodities handled  
through the Port's facilities.

## Liverpool

### Royal Seaforth Grain Terminal

Royal Seaforth Dock  
Liverpool  
L21 1JD  
UK  
Contact: Mr Colin McLoughlin  
T: + 44 151 949 6201  
F: + 44 151 949 6461  
E: colin.mcloughlin@peelports.com

## London

### MacQuarie Capital (Europe)

**Limited**  
Level 2, Moor House  
120 London Wall  
London  
EC2Y 5ET  
UK  
Contact: Mr Jim Lennon  
Executive Director  
T: + 44 20 3037 4271  
F: + 44 20 3037 4306  
E: jim.lennon@macquarie.com

## Londonderry

### Londonderry Port & Harbour

**Commissioners**  
Harbour Office  
Port Road  
Lisahally  
Londonderry  
Northern Ireland  
BT47 6FL  
UK  
Contact: Mr Bill McCann  
Harbour Master

T: + 44 287 186 1113  
F: + 44 28 7186 1168  
E: bill@londonderry-port.co.uk  
W: www.londonderryport.com

## Manningtree

### Mistley Quay & Forwarding

High Street  
Mistley  
Manningtree  
Essex  
CO11 1HB  
UK  
Contact: Mr John Jenkins  
Port Manager  
T: + 44 1206 394431  
F: + 44 1206 393882  
E: jrjenkins@twlogistics.co.uk

## Merton

**ABP**  
Merton Lane  
Merton  
York  
YO19 5GH  
UK  
Contact: Mr David Wood  
General Manager  
T: + 44 1904 488333  
F: + 44 1904 489837  
E: david.wood@abpbeef.com

## Methil

### Port of Burntisland

Forth Ports PLC  
Dock Office  
Methil  
Fife  
KY8 3RE  
UK  
Contact: Mr Murray  
Murray Cheyne  
Port Superintendent  
T: + 44 1383 413 366  
F: + 44 1333 424 873  
E: alan.burns@forthports.co.uk

## Middlesbrough

### Casper Shipping Ltd

Cleveland Business Centre  
1 Watson Street  
Middlesbrough  
Cleveland  
TS1 2RQ  
UK  
Contact: Mr Michael Shakesheff  
Managing Director  
T: + 44 1642 233 570  
F: + 44 1642 243 936  
E: mshakesheff@casperitd.com  
W: www.casperitd.com

## Middlesex

### Hall Aggregates Wharf

Hall Aggregates (South East) Ltd  
RMC House  
High St  
Feltham  
Middlesex  
TW13 4HD  
UK  
Contact: Mr Mark Gilliard  
Wharf Manager  
T: + 44 20 8893 7888  
F: + 44 20 8893 7800

## Montrose

### Montrose Port Authority

South Quay  
Ferryden  
Montrose  
Angus  
DD10 9SL  
UK  
Contact: Mr John Paterson  
Chief Executive  
T: + 44 1674 672302  
F: + 44 1674 675530  
E: info@montroseport.co.uk  
W: www.montroseport.co.uk  
Location: East Coast of Scotland

Equipment & Capacity:  
Craneage/Elevators etc.  
Bulk Berths: Quayside Bulk Store  
Total uncovered Storage: 60,000sqm  
Total covered Storage: 200,000sqm  
Available uncovered & covered  
storage, varies week by week

## Near Hull

### Hull Agency (Goole)

Casper Shipping Ltd  
Saltend Office DL1 (Upper Floor)  
Saltend Hedon  
Near Hull  
East Yorkshire  
HU12 8DS  
UK  
Contact: Mr Don Mussett  
T: + 44 1482 891533  
F: + 44 1482 891186  
E: hull@casperitd.com  
W: www.casperitd.com

## Newport

### ABP - Port of Newport

Dock Office  
Alexandra Dock  
Newport  
Gwent  
NP20 2UW  
UK  
Contact: Mr Clive Thomas  
Deputy Port Manager  
T: + 44 870 609 6699  
F: + 44 1633 221285  
E: cjtthomas@abports.co.uk  
W: www.abports.co.uk  
Location: South Wales

## Newport

### ABP - Port of Swansea

Dock Office  
Alexandra Dock  
Newport  
Gwent  
NP20 2UW  
UK  
Contact: Mr Clive Thomas  
Deputy Port Manager  
T: + 44 870 609 6699  
F: + 44 1633 221285  
E: cjtthomas@abports.co.uk  
W: www.abports.co.uk/swansea

## Newport

### Newport Stevedores Ltd

Eastway Road, North Dock  
Alexandra Dock  
Newport  
Gwent  
NP9 2NP  
UK  
Contact: Mr Matthew Kennerley  
Port Director  
T: + 44 1633 220969  
F: + 44 1633 221371  
E: info@abports.co.uk

## North Killingholme

### Humber Sea Terminal

Simon Warehousing and  
Distribution  
Clough lane  
North Killingholme  
DN40 3JP  
UK  
Contact: Mr Hugh Gates  
T: + 44 1469 542 125  
F: + 44 1469 541 121  
E: hugh.gates@simonports.co.uk  
W: www.simongroup.plc.uk

## Nottingham

### Hull Bulk Handling Ltd

Fernwood House  
Fernwood Drive  
Main Road  
Watnall  
Nottingham  
NG16 1LA  
UK

Contact: Mr Charles Holehouse  
Managing Director  
T: + 44 11 593 893 78  
F: + 44 1482 784 895  
E: charles.holehouse@  
fernwood.co.uk  
W: www.hullbulk.co.uk  
Location: North East of England on  
the North Sea, Humber Estuary  
Equipment & Capacity: 2 x Butterley  
15 tonne grab crane  
up to 1300 tph  
Bulk Berths: 10 Quay, Queen  
Elizabeth Dock  
195m LOA.  
10.4m Draught.  
25.5m Beam  
Total uncovered Storage: 165,000  
sqm  
Total covered Storage: Available on  
request  
Terminal is road /rail and barge  
connected see website :  
www.hullbulk.co.uk for further details

## Oban

### Glensanda Harbour

Yeoman Glensanda  
Rhugh Garbh Depot  
Barcaldine  
Oban  
Argyll  
PA37 1SE  
UK  
Contact: Captain John Jackson  
Harbour Master/Pilot  
T: + 44 1631 730537  
F: + 44 1631 730460  
E: john.jackson@foster-yeoman.co.uk  
Location: West Coast of Scotland.  
Equipment & Capacity: One ship  
loader capable of loading Panamax  
size vessels at 6 000 tph.  
Bulk Berths: Berth length 100m with  
mooring dolphins on shore. Max  
length 256m - max draught 14.5 m  
on high tide.  
Approximately 7 000 000 m/t crushed  
granite aggregates are shipped out  
annually from Glensanda.

## Padstow

### Padstow Harbour

**Commissioners**  
Harbour Office  
West Quay  
Padstow  
Cornwall  
PL28 8AQ  
UK  
Contact: Mr R M Atkinson  
Harbour Master  
T: + 44 1841 532239  
F: + 44 1841 533346  
E: padstowharbour@btconnect.com  
W: www.padstow-harbour.co.uk

## Penzance

### Penzance Harbour

Harbour Office, North Arm  
Wharf Road  
Penzance  
Cornwall  
TR18 4AH  
UK  
Contact: Mr Neil Clark  
Harbour Master  
T: + 44 1736 366113  
F: + 44 1736 366114  
E: neil.clark@penwith.gov.uk  
W: www.penwith.gov.uk

## Perth

### Perth Harbour

Perth Harbour Office  
Friarton Road  
Perth  
Scotland  
PH2 8BB  
UK  
Harbour Master  
T: + 44 1738 624056

F: + 44 1738 622263  
Location: An inland port on the east  
coast of Scotland approx. 26 miles  
from the fairway buoy on the River  
Tay.  
Bulk Berths: Vessels up to 90 metres  
accepted.  
All stevedoring and storage is handled  
by independent operators.

## Poole

### Poole Harbour Commissioners

20 New Quay Road  
Hamworthy  
Poole  
Dorset  
BH15 4AF  
UK  
Contact: Mr Jim Stewart  
Chief Executive  
T: + 44 1202 440210  
F: + 44 1202 440212  
E: chiefexecutive@phc.co.uk  
W: www.phc.co.uk

## Port Talbot

### ABP - Port Talbot

Puckey House  
The Docks  
Port Talbot  
West Glamorgan  
SA13 1RB  
UK  
Contact: Mr Matthew Kennerley  
Port Director  
T: + 44 870 609 6699  
F: + 44 1792 332 255  
E: mkennerley@abports.co.uk  
W: www.abports.co.uk

## Portbury

### Agricultural Bulk Services

Royal Portbury Dock  
Portbury  
Bristol  
BS20 9XL  
UK  
Contact: Mr James Reeson  
T: + 44 1275 375 777  
F: + 44 1275 374932  
E: james.reeson@bristolport.co.uk

## Portland

### Portland Port Ltd

Port Office  
Castletown  
Portland  
Dorset  
DT5 1PP  
UK  
Contact: Mr Steve Davies  
Director and General Manager  
T: + 44 1305 824044  
F: + 44 1305 823045  
E: I.green.pa@portland-port.co.uk  
W: www.portland-port.co.uk  
Location: UK SouthCoast  
Equipment & Capacity: 50t - 15t 2  
Cranes  
6t 2 Cranes  
300t 1 Crane  
Bulk Berths: 13 Commercial Berths -  
Max Draft13m  
Max LOA250m  
Total uncovered Storage: 30,000m2  
Total covered Storage: 10,000m2

## Rosyth

### Port of Methil

Forth Ports PLC  
Exmouth Building  
Rosyth  
Fife  
KY11 2XP  
UK  
Contact: Mr Alan Burns  
Port Manager  
T: + 44 1383 413 366  
F: + 44 1383 414 499  
E: alan.burns@forthports.co.uk



**Runcorn**

**Manchester Ship Canal Company Ltd**  
Engineering Workshops  
Runcorn Docks  
Percival Lane  
Runcorn  
Cheshire  
WA7 4UY  
UK  
Contact: Mr Dean Hammond  
General Manager  
T: + 44 01928 508550  
F: + 44 01928 567469  
E: mail@shipcanal.co.uk  
W: www.shipcanal.co.uk

**Rye**

**Rastrum Ltd**  
Rye Wharf  
Harbour Road  
Rye  
East Sussex  
TN31 7TE  
UK  
Contact: Mr Rod Chapman  
Director  
T: + 44 1797 224778  
F: + 44 1797 223650  
E: rodc@ryewharf.co.uk  
W: www.ryewharf.co.uk  
Location: South East Coast of England  
Equipment & Capacity: Mechanical Handling 500tph  
Bulk Berths: 2 x 2,500 tonnes  
Total uncovered Storage: 50,000sqm  
Total covered Storage: 30,000sqm

**Seaham**

**Seaham Harbour Dock Company**  
Cargo Durham Distribution Centre  
Seaham  
Durham  
SR7 7NZ  
UK  
Contact: Mr Alan Luscombe  
Managing Director  
T: + 44 191 516 1700  
F: + 44 191 516 1701  
E: alanluscombe@victoriagroup.co.uk  
W: www.portofseaham.demon.co.uk

**Sharpness**

**Port of Sharpness**  
c/o Sharpness Docks Ltd  
Sharpness  
Gloucester  
GL13 9UX  
UK  
Contact: Mr Garry Strickland  
General Manager/Director  
T: + 44 1453 811644  
F: + 44 1453 811990  
E: info@sharpnessdock.co.uk  
Location: South West England Bristol Channel  
Equipment & Capacity: 4 x Portals cranes at 6.0 mts capacity  
1 x Cement pump  
2 x Grain elevators  
3 x WCK mobile cranes  
200 mts per hour  
Bulk Berths: 14 berths - 6 metres draft  
Total uncovered Storage: 50 000 sqm  
Total covered Storage: 250 000 sf  
2 x Grain export silos with combined capacity of 16 000 tonnes

**Silloth**

**ABP - Port of Silloth**  
Dock Office  
New Dock  
Silloth  
Cumbria  
CA7 4JQ  
UK  
Contact: Captain C Puxley  
Harbour Master & Port Superintendent  
T: + 44 1697 331358  
F: + 44 1697 332709

E: silloth@abports.co.uk  
W: www.abports.co.uk

**South Shields**

**Port of Tyne**  
Maritime House  
Tyne Dock  
South Shields  
Tyne & Wear  
NE34 9PT  
UK  
Contact: Mr Andy Fulds  
Commercial Manager  
T: + 44 191 455 2671  
F: + 44 191 454 1460  
E: andy.fulds@portoftyne.co.uk  
W: www.portoftyne.co.uk  
Location: Riverside Quay, north east of England on the north east coast  
Location - South Side River Tyne 54 degrees 59.13'N 001 degrees 27.3'West (Chart BA 1934)  
Distance to sea 2.2 miles  
Equipment & Capacity: 6.9 ha  
Container Terminal  
- Heavy duty harbour mobile cranes and associated equipment (Gottwald and Liebherr)  
- Heavy-duty mobile loading shovels  
- Fork lift trucks  
- Pallet storage: 58,000 pallet slots available  
- Intermodal rail terminal and in-house distribution fleet  
Bulk Berths: Riverside Quay: 574m long Depth of Water 12.1m below Chart Datum  
Total uncovered Storage: 20,000sqm  
Customs Approved open storage area  
Total covered Storage: 21,000sqm  
Customs Approved transit shed storage  
The Port of Tyne is a deep river port open 24 hours/7 days a week and situated to the A1, M1, A19 road links and with a rail terminal linking to the main London Edinburgh rail network.

**Southampton**

**ABP - Southampton**  
Ocean Gate  
Atlantic Way  
Eastern Docks  
Southampton  
SO1 1XQ  
UK  
Contact: Mr Douglas Morrison  
Port Director  
T: + 44 2380 48 88 00  
F: + 44 2380 33 64 02  
E: dmorrison@abports.co.uk  
W: www.abports.co.uk

**Southampton**

**Southampton Grain Terminal Ltd**  
Gate 4 Berth 36  
Test Road  
Eastern Docks  
Southampton  
SO14 3GG  
UK  
Contact: Mr Richard Pollard  
Director  
T: + 44 2 380 334433  
F: + 44 2 380 330657  
E: richard.pollard@sgtsilos.co.uk  
Location: South of England on English Channel  
Equipment & Capacity: Ship loader at up to 1,000tph  
Bulk Berths: 36 Berth vessels up to 220m - tidal min 9.3m  
Total uncovered Storage: Not applicable  
Total covered Storage: Concrete silos - 28,000t  
Vessels up to 235m may be accommodated

**Southampton**

**Solent Stevedores Ltd**  
King George V Dock  
Western Avenue  
Western Docks  
Southampton  
Hampshire  
SO15 0HH  
UK  
Contact: Mr Stuart Cullen  
Managing Director  
T: + 44 1453 544 449  
F: + 44 1453 549 149  
E: stuart@solentstevedores.com  
W: www.solentstevedores.co.uk  
Location: Southampton on the Solent, Hampshire; Silvertown on the Thames, London  
Equipment & Capacity: Mobile harbour cranes, quay cranes, conveyor system, quayside equipment, 4 x public weighbridges  
Total uncovered Storage: 75,000sqm  
Total covered Storage: 20,000sqm

**Sunderland**

**Port of Sunderland**  
Capstan House  
Greenwells Quay  
South Docks  
Barrack Street  
Sunderland  
Tyne & Wear  
SR1 2BU  
UK  
Contact: Mr Matthew Hunt  
Port Director  
T: + 44 191 553 2100  
F: + 44 191 553 2120  
E: ian.duncan@portofsunderland.org.uk  
W: www.portofsunderland.org.uk  
Location: North East of England on the East Coast  
Bulk Berths: East Quay South, Hudson Dock: 183m long, 5.5m draught  
Total uncovered Storage: 6 400 sqm  
Total covered Storage: Nil  
Current bulk materials are accommodated on a self-handled basis. All berths are serviced by a crawler crane if required.

**Swansea**

**ABP Harbour Office**  
Lock Head  
King's Dock  
Swansea  
West Glamorgan  
SA1 1QR  
UK  
Contact: Mr Clive Thomas  
Deputy Port Manager  
T: + 44 870 609 6699  
F: + 44 1792 332255  
E: cjthomas@abports.co.uk  
W: www.abports.co.uk  
Location: South Wales

**Teignmouth**

**ABP - Teignmouth**  
Teignmouth  
Devon  
UK  
Contact: Mr Colin Greenwell  
Port Manager  
T: + 44 1626 774044  
F: + 44 1626 776240  
E: teignmouth@abports.co.uk

**Tilbury**

**Port of Tilbury London Limited**  
Lesley Ford House  
Tilbury FreePort  
Tilbury  
Essex  
RM18 7EH  
UK  
Contact: Mrs Tracey Sampson  
T: + 44 1375 852 200

F: + 44 1375 855 106  
E: caroline.gerrard@potll.com  
W: www.forthports.co.uk

**Tilbury**

**Stema Shipping UK**  
Powell Duffryn House  
21 Berth  
Tilbury Docks  
Tilbury  
Essex  
RM18 7JT  
UK  
Contact: Mr Terje Johansen  
T: + 44 1375 857890  
F: + 44 1375 857456  
E: enquiries@stema.co.uk  
W: www.stema.co.uk

**Tilbury**

**Port of Tilbury London Ltd - Grain Terminal**  
Tilbury FreePort  
Tilbury  
Essex  
RM18 7EH  
UK  
Contact: Mr Peter Ward  
Senior Asset Manager - Grain & Bulks  
T: + 44 1375 852485  
F: + 44 1375 852250  
E: peter.ward@potll.com  
W: www.forthports.co.uk/ports/tilbury/  
Location: South East England  
Equipment & Capacity: 2 continuous unloaders, 2,000mt per hour.  
2 harbour mobile grab cranes.  
Bulk Berths: Grain 12.5m. Bulks 10.5m  
Total uncovered Storage: 120,000 silos.  
80,000 flat stores.  
1 Grain Terminal for import/export.  
2 Bulk Handling berths.

**Warrenpoint**

**Warrenpoint Harbour Authority**  
The Docks  
Warrenpoint  
Co Down  
BT34 3JR  
UK  
Contact: Mr Kerin Grant  
Operations Director  
T: +44 28 4175 2878  
F: + 28 4175 2875  
E: bmcjury@warrenpointharbour.co.uk  
Location: East Coast - Northern Ireland  
Equipment & Capacity: 4 Mobile, 2 Grantry - up to 43 tonnes swc  
Bulk Berths: 6 Berths

**Whitstable**

**Whitstable Harbour**  
Harbour Office  
Whitstable  
Kent  
CT5 1AB  
UK  
Contact: Mr Michael Weir  
Port Manager & Harbour Master  
T: + 44 1227 274086  
E: whitstable.harbour@canterbury.gov.uk  
W: http://whitstable.seapublish.co.uk/  
Location: South East Kent  
Equipment & Capacity: Cranes to be hired from private contractor  
Bulk Berths: West Quay 170m  
East Quay 140  
Total uncovered Storage: 5700 sqm  
Total covered Storage: 0

**Wolverhampton**

**Tarmac Limited**  
Millfields Road  
Ettingshall  
Wolverhampton  
West Midlands

WV4 6JP  
UK  
Contact: Mr Paul Burgess  
Production Manager  
T: + 44 1206 332 464  
E: enquiries@tarmac.co.uk  
W: www.tarmac.co.uk/

**Workington**

**Port of Workington**  
Cumbria County Council  
Prince of Wales Dock  
Workington  
Cumbria  
CA14 2JH  
UK  
Contact: Mr Colin Sharpe  
General Manager / Deputy Port Manager  
T: + 44 1900 602301  
F: + 44 1900 604696  
E: gateway@portofworkington.co.uk  
W: www.portofworkington.gov.uk

**UKRAINE**

**Berdiansk**

**Berdiansk Port Authority**  
13/7 Maxim Gorky Street  
Berdiansk  
Zaporozhie Province  
71112  
Ukraine  
Contact: Mr Anatoliy Reznikov  
Director General  
T: + 380 61 53 32210  
F: + 380 61 53 36593  
E: post@bstport.berdiansk.net  
W: www.ukrport.org.ua/  
p-berdiansk-e.htm

**Ilichevsk**

**Port of Ilichevsk Authority**  
6 Trouda Square  
Ilichevsk  
270901  
Ukraine  
T: +380 48 68 691 600  
F: +380 48 68 693 606  
E: pm@ilport.com.ua

**Izmail**

**Commercial Sea Port of Izmail**  
Str. Portovaya 7  
Izmail  
68600  
Ukraine  
Contact: Mr Valentin F Kotelniy  
Port Director  
T: + 380 4841 25601  
F: + 380 4841 26258  
E: ves@izmport.com.ua

**Kerch**

**The Kerch Merchant Port**  
28 Kirova Street  
Kerch  
Crimea  
334512  
Ukraine  
T: + 380 654 777-83-80  
F: + 380 654 35-64-01  
E: ukrport@ukrport.org.ua  
W: www.ukrport.org.ua

**Kyiv**

**PORTINVEST LLC**  
Velyka Vasykivska street 77A  
Kyiv  
Kyiv  
03150  
Ukraine  
Contact: Ms Olena Svitlychna  
PR-Manager  
T: + 38 044 581 81 24  
F: + 38 050 359 95 00  
E: olena.svitlychna@portinvest.com.ua  
W: www.portinvest.com.ua

“A MAN WHO STOPS  
ADVERTISING TO  
SAVE MONEY IS  
LIKE A MAN WHO  
STOPS A CLOCK TO  
SAVE TIME”

- Henry Ford

To find out how you can benefit from advertising in the world's only monthly dry  
bulk publication contact Jason Chinnock or Andrew Hucker-Brown on:  
Tel: +44 (0)1206 562560 Fax: +44 (0)1206 562566 Email: [info@dc-int.com](mailto:info@dc-int.com)





**Mariupol**

**Mariupol Sea Commercial Port**  
99, Admiral Lunin Avenue  
Mariupol  
Donetsk Region  
87510  
Ukraine  
Contact: Mr Aleksandr Oleynik  
1st Deputy General Manager of the port  
T: + 380 629 408 616  
F: + 380 629 408 660  
E: mail@marport.net  
W: www.marport.net  
Location: South East of Ukraine, North West part of Taganrog Gulf of the Sea of Azov,  
14 miles from the gulf entry  
Equipment & Capacity: Portal cranes 5-50 tn capacity  
Floating cranes 100-150 tn capacity  
Container loaders 40 tn capacity  
Bulk Berths: 18 Berths TOTAL, 8 Berths - BULK cargo, 10 Berths - GENERAL cargo  
Total uncovered Storage: 228,400 sqm  
Total covered Storage: 15,500 sqm  
Mariupol Port is one of the leading ports in Ukraine on mechanization, hydro-engineering construction, cargo handling volumes and services.

**Nikoleav**

**Nikolayev Port Authority**  
23 Zavodskaya Street  
Nikoleav  
327004  
Ukraine  
Port Director  
T: + 380 512 508 400  
F: + 380 512 508 807  
E: nmp@portnikoleav.com  
W: www.portnikoleav.com

**Odessa**

**PortInvest**  
11 Polyskiy Usviz  
Odessa  
65026  
Ukraine  
Contact: Mr Ilja Cerkasskis  
Project Manager  
T: + 380 048 740 04 06  
F: + 380 048 710 04 01  
E: ilja.cerkasskis@portinvest.com.ua  
W: www.portinvest.com.ua

**Odessa**

**Port of Odessa Authority**  
1 Vakulenchuk Square  
Merskoy Port  
Odessa  
27004  
Ukraine  
Contact: Mr AP Kharitoshin  
Harbour Master  
T: + 380 482 218081  
F: + 380 482 348328  
E: info@portgdansk.pl

**Odessa**

**Transinvestservice (TIS) Ltd**  
50 Chapayev Str  
Vizirka Village  
Kominternovo District  
Odessa  
67543  
Ukraine  
Contact: Mr Andrey Slavnitser  
Deputy Director  
T: + 380 482 300 711  
F: + 380 482 300 735  
E: mail@tis.ua  
W: www.tis.ua  
Location: Yuzhny port, North Coast of the Black Sea  
Equipment & Capacity: Total truck discharge- 1000 trucks/day.  
Total RW discharge - 1000 wagons/day  
5 million tonnes per year

Bulk Berths: Depth 14m. Length 760m  
Vessel size limitation: Capesize DWT up to 130,000 tons  
Total uncovered Storage: Total storage: 770,000 mt  
380,000 tonnes - total storage for grains  
20,000 sqm  
Total covered Storage: 65,000 sqm

**Odessa**

**Odessa Port Silo**  
4 Khlebnaya Gavan  
Odessa  
65003  
Ukraine  
Contact: Mr Igor A. Zubrich  
Director  
T: +380 48 723 24 60  
F: + 380 48 741 14 21  
E: portelelevator@paco.net  
W: www.port-elevator.odessa.ua/eng/photogallery.html

**Port of Kilia**

**Kiliya Transshipment Point**  
4 Zheleznyakova Street  
Port of Kilia  
Odessa Region  
683000  
Ukraine  
Contact: Mr Bladimir Chernobykin  
Managing Director  
T: + 38 04843 238 81  
F: + 38 04843 237 03  
E: kilport.kiliya.uptel.net

**Reni**

**Port of Reni**  
188 Dunayskaya Str.  
Reni  
Odessa  
68802  
Ukraine  
Contact: Mr Yuriy Pishchalo  
Manager of Marketing and Commerce Dpt  
T: + 380 4840 42652  
F: + 380 4840 26739  
E: ovspor@reni.uptel.net  
W: www.portreni.com.ua  
Location: South-west of Ukraine at the junction of the Ukrainian, Romanian and Moldovian borders, at the crossing of 4 transport corridors: Cretan No. 7 and No. 9, Euro-Asian and Black Sea.  
Equipment & Capacity: 2 x cranes, lifting capacity 36t and 250t  
3 x floating cranes, lifting capacity 5t, 16t and 100t  
Variety of gantry cranes, fork lift trucks, bucket loaders etc.  
Bulk Berths: 39 specialised berths, handling cargoes including general, bulk, and loose bulk.  
Vessel size limitation - draught enabling passage along Sulinsky Canal (7 m.), which connects the Danube with the Black Sea.  
Total uncovered Storage: 195,000sqm  
Total covered Storage: 30,000sqm

**Vikovo**

**Port of Ust-Dunaysk**  
2 Pridunayskaya Street  
Vikovo  
Odessa  
272626  
Ukraine  
Contact: Mr Pavel V Kosinets  
General Director  
T: + 380 4843 31135

**Yalta**

**Yalta Sea Trade Port Authority**  
5 President F D Roosevelt Street  
Yalta  
Crimea  
334200

Ukraine  
Contact: Mr Sergiy Tarakanov  
General Manager  
T: + 380 654 230 065  
F: + 380 654 323 926  
E: yasco@mail.ylt.crimea.com

**Yuzhny**

**Port Yuzhny**  
Bulk and General Cargo Terminal  
Yuzhny  
Odessa Region  
65481  
Ukraine  
Contact: Mr V Ivanov  
General Port Director  
T: +380 487 507 254  
F: + 380 48 750 7254  
E: boss@port-yuzhny.com.ua  
W: www.port.yuzhny.odessa.ua

**Yuzhny**

**JV Transinvestservice TIS**  
Chapayeva Str  
50 v Vizirka  
Kominter-Novski District  
Yuzhny  
Odessa Region  
67543  
Ukraine  
Contact: Mr Oleg Sologul  
Industrial Engineer  
T: + 380 482 725711  
F: + 380 480 300735  
E: mail@tis.ua  
W: www.tis.ua

**URUGUAY**

**Montevideo**

**T.G.U.S.A Uruguayan Grain Terminals**  
Rondeau Ave 1908 .5  
Montevideo  
11800  
Uruguay  
Contact: Mr A Deambrosi  
President  
F: + 598 2929 0603  
W: www.tgu.com.uy

**Montevideo**

**Paysandu Coordinadora de Puertos Uruguay**  
Administracion Nacionala de Puertos  
Rambla 25 de Agosto de 1825 No 160  
Montevideo  
Uruguay  
Port Director  
T: + 598 2917 0731  
F: + 598 2916 0754  
E: info@puertos.com.uy  
W: http://puertos.com.uy

**Montevideo**

**Corporación Navios S.A.**  
Juan Carlos Gomez 1445 esc 701  
esquina 25 de Mayo  
Montevideo  
11.000  
Uruguay  
Contact: Mr Pablo Soler Brusa  
General Manager  
T: + 598 2 9163310  
F: + 598 2 9162874  
E: psoler@naviosterminals.com  
W: www.naviosterminals.com

**Nueva Palmira**

**Terminal Nueva Palmira**  
Ruta 12km  
Nueva Palmira  
Uruguay  
Contact: Mr R Grien  
T: + 5982 628 80 59  
F: + 5982 628 65 62  
E: rgrien@anp.com.uy

W: www.tgu.com.uy

**Rio Negro**

**Terminal Fray Bentos**  
Puerto Fray Bentos  
Rio Negro  
Uruguay  
F: + 598 4562 7428  
W: www.tgu.com.uy

**USA**

**Aberdeen**

**Port of Grays Harbor**  
PO Box 660  
Aberdeen  
Washington  
98520-0141  
USA  
Contact: Mr Seth Taylor  
Marine Terminal Manager  
T: + 1 360 533 9528  
F: + 1 360 533 9505  
E: staylor@portgrays.org  
W: www.portofgraysharbor.com  
Location: PNW North America  
Equipment & Capacity: Dry bulk loader 1200mtp  
Bulk Berths: Terminal 2, 600', -41MLLW  
Total uncovered Storage: 160,000sqm  
Total covered Storage: 6,500sqm

**Albany**

**Albany Port District Commission**  
Administration Building  
Port of Albany  
Albany  
NY 12202  
USA  
Contact: Mr Rich Hendrick  
General Manager  
T: + 1 518 463 8763  
F: + 1 518 463 8767  
E: Rhendrick@portofalbany.us  
W: www.Portofalbany.us  
Location: 124 miles north of New York Harbor on the Hudson River.  
Equipment & Capacity: Forklifts and cranes of various capacities.  
Bulk Berths: 1 grain berth of 228m in length with a draught of 9.45m and various multi-use berths.  
Total uncovered Storage: 8 ha.  
Total covered Storage: 27,900 sqm

**Alexandria**

**American Association of Port Authorities (AAPA)**  
1010 Duke Street  
Alexandria  
VA  
22314  
USA  
Contact: Mr Aaron Ellis  
Public Affairs Director  
T: + 1 703 684 5700  
F: + 1 703 684 6321  
E: aellis@aapa-ports.org  
W: www.aapa-ports.org  
Trade association representing ports throughout the Western Hemisphere.

**Ama**

**ADM Gromark-Destrehan**  
PO Box 120  
Ama  
LA 70031  
USA  
Contact: Ms Ruth Sacra  
T: + 1 504 431 8245  
F: + 1 504 431 7275  
E: ruth\_sacra@admworld.com

**Anacortes**

**Metro Ports**  
PO Box 406  
Anacortes  
WA  
98221

USA  
Contact: Mr Shawn Bundy  
Manager Anacortes Operations  
T: + 1 360 299 2931  
F: + 1 360 299 3932  
E: info@metroports.com  
W: www.metroports.com  
Location: Port of Anacortes

**Anacortes**

**Port of Anacortes**  
100 Commercial Ave  
Anacortes  
WA  
98221  
USA  
Contact: Mr Josh Beaner  
Marine & Aviation Services Manager  
T: + 1 360 299 1828  
F: + 1 360 293 9608  
E: josh@portofanacortes.com  
W: www.portofanacortes.com  
Location: Pacific Northwest  
Equipment & Capacity: Mobile Bulk Outloader 380tph  
Bulk Berths: 1 berth:465',1,028' w/dolphins

**Anacortes**

**Metropolitan Stevedore Company**  
Pier 2  
Port of Anacortes  
Anacortes  
Washington  
98221  
USA  
Contact: Mr Shawn Bundy  
T: + 1 360 299 2931  
F: + 1 360 299 3932  
E: shawn.bundy@metsteco.com  
W: www.metsteco.com  
Location: USA; Pacific Northwest  
Equipment & Capacity: 1,100 MT/Hour shiploader (fixed)  
Bulk Berths: Max depth 13.4m, Wharf Length 140.8/345.3m (dolphine)  
Truck access; truck wash

**Anchorage**

**North Star Terminal Stevedore Company**  
PO Box 102019  
Anchorage  
AK 99501  
USA  
Contact: Mr Steve Post  
Manager  
T: + 1 907 272 7537 X117  
F: + 1 907 272 8755  
W: www.northstarak.com

**Anchorage**

**Port of Anchorage**  
2000 Anchorage Port Road  
Anchorage  
Alaska  
AK 99501  
USA  
Contact: Governor William J Sheffield  
Port Director  
T: + 1 907 3436200  
F: + 1 907 2775636  
E: wwport@ci.anchorage.ak.us  
W: www.muni.org/port

**Arabi**

**Associated Terminals of St Bernard**  
8000 St. Bernard Hwy  
Reserve  
Arabi  
Louisiana  
70032  
USA  
Contact: Mr Zeljko Franks  
Vice President  
T: + 1 504 277 5101  
F: + 1 504 279 8353  
E: zfranks@associatedterminals.com

W: [www.associatedterminals.com](http://www.associatedterminals.com)  
 Location: Lower Mississippi River miles 86 to 91  
 Equipment & Capacity: Fleet of midstream stevedoring cranes, dock cranes, conveyors, mobile equipment  
 Bulk Berths: Four midstream berths, one set of mooring dolphins, and wharves for handling bulk and general cargoes  
 Total uncovered Storage: 150,000 sq ft  
 Total covered Storage: 240,000 sq ft  
 ATSB is the major terminal facility on the Mississippi River handling both bulk and breakbulk cargoes. Multiple docks and berths, as well as warehouses for bulk and breakbulk, rail and truck connections make ATSB the right choice for shippers.

## Argo

### Kinder Morgan Terminals

Midwest Regional Office  
 8500 West 68th Street  
 Argo  
 Illinois  
 60501  
 USA  
 Contact: Mr Brian Feyereisen  
 Commercial Director  
 T: + 1 708 496 2890  
 F: + 1 708 496 2888  
 E: [Brian\\_Feyereisen@kindermorgan.com](mailto:Brian_Feyereisen@kindermorgan.com)  
 W: [www.kindermorgan.com](http://www.kindermorgan.com)

## Baltimore

### Baltimore Terminal

CNX Marine Terminals Inc.  
 3800 Newgate Avenue  
 Baltimore  
 Maryland  
 MD 21224-6404  
 USA  
 Contact: Mr Chris Marsh  
 Vice President  
 T: + 1 410 631 6426  
 F: + 1 410 631 6425  
 E: [chrismarsh@consolenergy.com](mailto:chrismarsh@consolenergy.com)  
 W: [www.consolenergy.com](http://www.consolenergy.com)

## Baltimore

### Rukert Terminals Corp

2021 S. Clinton St  
 PO Box 5163  
 Baltimore  
 MD  
 21224  
 USA  
 Contact: Mr John Coulter  
 T: + 1 410 276 1013  
 F: + 1 410 327 2315  
 E: [john@rukert.com](mailto:john@rukert.com)  
 W: [www.rukert.com](http://www.rukert.com)  
 Location: Rukert Terminals is located on the Northwest branch of the Patapsco River, a tributary of the Chesapeake Bay. Baltimore gains great advantage over other East Coast ports with a geographic location that is closest to the U. S. Midwest.  
 Equipment & Capacity: 4 cranes  
 1 Rapid discharge Bulk Unloader 400tph  
 2 175 ton Crawlers  
 1 70 ton Mobile  
 Bulk Berths: Pier 5 Bulk (PECO Gantry Crane) 875 feet 39.5 feet  
 Lazaretto A Bulk / Break-Bulk / Containers 525 feet 35 feet  
 Pier C Break-Bulk / Special Projects 1000 feet 35  
 Total uncovered Storage: 160,000 sqm  
 Total covered Storage: 112,000 sqm  
 Since 1921, Rukert Terminals Corporation has been a privately-owned and operated company which specializes in the handling of metals, ores, fertilizers, alloys, and other dry bulk and break-bulk cargoes. Services

include stevedoring, warehousing, and transfer to and from vessel, rail or truck.

## Baltimore

### CNX Marine Terminal, Inc.

3800 Newgate Avenue  
 Baltimore  
 MD  
 21224  
 USA  
 Contact: Mr Christopher Marsh  
 General Manager  
 T: + 1 410 631 6419  
 E: [regispeternel@consolenergy.com](mailto:regispeternel@consolenergy.com)  
 W: [www.consolenergy.com](http://www.consolenergy.com)

## Baltimore

### Port of Baltimore

Maryland Port Administration  
 World Trade Center  
 401 East Pratt Street  
 Baltimore  
 MD 21202-3041  
 USA  
 Contact: Mr Richard Scher  
 Director of Communications  
 T: + 1 410 385 4483  
 F: + 1 410 385 4485  
 E: [rscher@marylandports.com](mailto:rscher@marylandports.com)

## Baltimore

### Maryland Port Administration

The World Trade Centre  
 Baltimore  
 Maryland  
 21202-304  
 USA  
 Contact: Mr Louis LoBianco  
 T: + 1 410 385 4455  
 F: + 1 410 333 1126  
 E: [stras@mdot.state.md.us](mailto:stras@mdot.state.md.us)  
 W: [www.mpa.state.md.us](http://www.mpa.state.md.us)

## Baton Rouge

### Louisiana Mid-Stream Terminals, LLC

8280 YMCA Plaza Drive #2  
 Baton Rouge  
 LA  
 70810  
 USA  
 T: + 1 225 324 6038  
 F: + 1 225 767 9648  
 E: [traffic@lamidstream.com](mailto:traffic@lamidstream.com)  
 W: [www.cooperconsolidated.com](http://www.cooperconsolidated.com)  
 Location: Mississippi River, Milepost 134, LaPlace, Louisiana  
 Equipment & Capacity: Mechanical Sampling, Magnet, 20000TPD  
 Bulk Berths: Mid-Stream Buoys  
 Total uncovered Storage: In Barges  
 Total covered Storage: N/A  
 LMO (Louisiana Mid-Stream One) floating terminal.

## Bayonne

### Duraport Marine & Rail Terminal, LLC

PO Box 1009  
 Bayonne  
 New Jersey  
 07002  
 USA  
 Contact: Mr Vincent Alessi  
 President  
 T: + 1 201 437 0703  
 F: + 1 201 437 0158  
 E: [vincealessi@aol.com](mailto:vincealessi@aol.com)

## Beaumont

### Beaumont Bulk Terminal Inc

1399 Carroll Street  
 Beaumont  
 Texas  
 77701  
 USA  
 Contact: Mr Rusty Harris  
 T: + 1 409 839 4888  
 F: + 1 409 835 0838  
 E: [dahrel\\_harris@kindermorgan.com](mailto:dahrel_harris@kindermorgan.com)

W: [www.tgsgroup.com](http://www.tgsgroup.com)

## Beaumont

### Port of Beaumont

PO Drawer 2297  
 1255 Main St  
 Beaumont  
 Texas  
 USA  
 Contact: Mr John Roby  
 Transportation Manager  
 T: + 1 409 835 5367  
 F: + 1 409 835 0512  
 E: [jro@portofbeaumont.com](mailto:jro@portofbeaumont.com)  
 W: [www.portofbeaumont.com](http://www.portofbeaumont.com)

## Bellingham

### Port of Bellingham

PO Box 1677  
 1801 Roeder Avenue  
 Bellingham  
 WA  
 98277  
 USA  
 Contact: Mr Dan Stahl  
 Director of Marine Services  
 T: + 1 360 676 2500  
 F: + 1 360 671 6411  
 E: [dans@portofbellingham.com](mailto:dans@portofbellingham.com)  
 W: [www.portofbellingham.com](http://www.portofbellingham.com)  
 Location: North Puget Sound - 15 miles south of Canadian Border  
 Bulk Berths: 1600 ft of berthing area of 32' depth  
 Total uncovered Storage: 35,000 sqm  
 Total covered Storage: 8,000 sqm

## Benicia

### Port of Benicia Authority

PO Box 315  
 Benicia  
 CA 94510  
 USA  
 Contact: Mr Jimmy Triplett  
 Port Manager  
 T: + 1 707 745 2394  
 F: + 1 707 746 1485  
 E: [jtriplett@ampports.com](mailto:jtriplett@ampports.com)  
 W: [www.ampports.com](http://www.ampports.com)  
 Location: San Francisco Bay Area, California, USA

## Boston

### Massport Maritime Department

One Harborside Drive  
 Boston  
 MA  
 02128-2909  
 USA  
 Contact: Ms Lynn Vikesland  
 Market Research Manager  
 T: + 1 617 946 4429  
 F: + 1 617 946 4466  
 E: [lvikesland@massport.com](mailto:lvikesland@massport.com)  
 W: [www.massport.com](http://www.massport.com)

## Braithwaite

### Plaquemines Port

Harbour & Terminal District  
 124 Edna LaFrance Road  
 Braithwaite  
 LA  
 70040  
 USA  
 Contact: Mr John L Pennison  
 Port Manager  
 T: + 1 504 682 7920  
 F: + 1 504 682 0649  
 E: [plaqport@bellsouth.net](mailto:plaqport@bellsouth.net)  
 W: [www.portofplaquemines.com](http://www.portofplaquemines.com)  
 Location: Lower Mississippi River South of New Orleans, La., Mid-Gulf Coast

## Bridgeport

### Bridgeport Port Authority

330 Water Street  
 Bridgeport  
 CT  
 06604  
 USA

Contact: Mr Joseph C Savino Jnr  
 Harbour Master  
 T: + 1 956 831 4592  
 F: + 1 956 831 5006  
 E: [bpt.port.auth@snet.net](mailto:bpt.port.auth@snet.net)  
 W: [www.portconnecticut.com](http://www.portconnecticut.com)

## Brownsville

### Port of Brownsville

1000 Foust Rd.  
 Brownsville  
 Texas  
 78521  
 USA  
 Contact: Mr Eduardo Campirano  
 CEO & Port Director  
 T: + 1 956 831 4592  
 F: + 1 956 831 5006  
 E: [eacampirano@portofbrownsville.com](mailto:eacampirano@portofbrownsville.com)  
 W: [www.portofbrownsville.com](http://www.portofbrownsville.com)

## Brunswick

### Marine Port Terminals Inc

225 Newcastle Street  
 Brunswick  
 GA  
 31520  
 USA  
 Contact: Mr David Proctor  
 Terminal Manager  
 T: + 1 912 264 4044 x238  
 F: + 1 912 267 6352  
 E: [dproctor@logistec.com](mailto:dproctor@logistec.com)

## Buffalo

### Port of Buffalo

Gateway Metroport  
 PO Box 880  
 2544 Clinton Street  
 Buffalo  
 New York  
 14224  
 USA  
 Contact: Mr Jim Pfohl  
 Port Director  
 T: + 1 716 826 2890  
 F: + 1 716 826 1342  
 E: [jpfohl@buffalocrushedstone.com](mailto:jpfohl@buffalocrushedstone.com)  
 Location: Lackawanna, New York south of Buffalo on Lake Erie.  
 Total uncovered Storage: 60,000 sqm  
 Total covered Storage: None currently available.

## Burlingame

### Ports America

1270 Drake Avenue  
 Burlingame  
 CA  
 94010  
 USA  
 Contact: Mr Peter Stone  
 T: + 1 510 749 7400  
 F: + 1 510 769 9626  
 W: [www.mtcorp.com](http://www.mtcorp.com)  
 Location: US West Coast, South & Mid-Atlantic

## Camden

### Delaware River Port Authority

One Port Centre  
 2 Riverside Drive  
 Camden  
 NJ 08101  
 USA  
 Contact: Mr Raymond A Lawler  
 Asst. Director  
 T: + 1 856 968 2000  
 F: + 1 856 968 2226  
 E: [info@lists.drpa.org](mailto:info@lists.drpa.org)

## Camden

### South Jersey Ports Corp

PO Box 129  
 2500 Broadway  
 Camden  
 NJ  
 08104  
 USA  
 Contact: Mr Joseph A Balzano

T: + 1 856 757 4969  
 F: + 1 856 757 4903  
 E: [sjpc@southjerseyport.com](mailto:sjpc@southjerseyport.com)

## Cape Canaveral

### Port Canaveral

Canaveral Port Authority  
 445 Challenger Road  
 Suite 301  
 Cape Canaveral  
 FL  
 32920  
 USA  
 Contact: Mrs Shannon Feeley  
 Senior Manager, Business Development  
 T: + 1 321 783 7831  
 F: + 1 321 783 3748  
 E: [SFeeley@portcanaveral.com](mailto:SFeeley@portcanaveral.com)  
 W: [www.portcanaveral.com](http://www.portcanaveral.com)  
 Location: Center of State of Florida, on Atlantic Ocean; due East of Orlando  
 Equipment & Capacity: Bulk conveyors, breakbulk facilities available, waterfront refrigerated warehousing. Land available.  
 Bulk Berths: South Cargo Piers 4 & 5 at 12 meters draught MLW  
 North Cargo Piers 1, 2, 3, & 4 at 12 meters draft MLW  
 Total uncovered Storage: 101,175sqm  
 Total covered Storage: 70,000sqm  
 We've handled bulk and breakbulk since 1955. See our website [www.portcanaveral.com](http://www.portcanaveral.com) for more information.

## Carteret

### Kinder Morgan Liquid Terminals, LLC

1 Terminal Road  
 Carteret  
 New Jersey  
 07008  
 USA  
 Contact: Mr Scott Johnston  
 Director, Business Development  
 T: + 1 732 969 5721  
 F: + 1 732 969 3575  
 E: [scott\\_johnston@kindermorgan.com](mailto:scott_johnston@kindermorgan.com)

## Caruthersville

### Pemiscot County Port Authority

111 E 3rd Street  
 Caruthersville  
 MO 63830  
 USA  
 Contact: Mr David P. Madison  
 Director  
 T: + 1 573 333 4125  
 F: + 1 573 333 4216  
 E: [pemiscotport@yahoo.com](mailto:pemiscotport@yahoo.com)  
 W: [www.pemiscotport.com](http://www.pemiscotport.com)  
 Location: Lower Mississippi River mile 849.9  
 Equipment & Capacity: Public dock; tower crane  
 Bulk Berths: Nine (9) barge berths  
 Rail access; two interstate highways; many large available sites

## Catoosa

### Tulsa Port of Catoosa

5350 Cimarron Road  
 Catoosa  
 OK 74015 - 3027  
 USA  
 Contact: Mr Robert W Portiss  
 Port Director  
 T: + 1 918 266 2291  
 F: + 1 918 266 7678  
 E: [bob@tulsaport.com](mailto:bob@tulsaport.com)  
 W: [www.tulsaport.com](http://www.tulsaport.com)  
 Location: Central US.  
 Equipment & Capacity: See website  
 Bulk Berths: See website  
 Total uncovered Storage: 10 acres  
 Total covered Storage: 80,000 short tons



**Catoosa**

**Gavilon Fertilizer, LLC**  
5640 W Channel Road  
Catoosa  
Oklahoma  
74015  
USA  
Contact: Mr Matt Benda  
Terminal Manager  
T: + 1 918 266 1244  
F: + 1 918 266 6129  
E: matthew.benda@gavilon.com  
Location: River mile 445 on the  
Arkansas River  
Total covered Storage: 70,000t  
Other commodities handled: salt

**Cerado**

**Kanawha River Terminal Inc**  
Main and River  
PO Box 308  
Cerado  
West Virginia  
25507  
USA  
Contact: Mr Matt Gaston  
Manager  
T: + 1 304 526 0753  
F: + 1 304 453 5521

**Charleston**

**Stevens Shipping & Terminal Co**  
PO Box 22826  
Charleston  
SC  
29413-2826  
USA  
Contact: Mr Norman Massey  
Operations Manager  
T: + 1 912 651 4000  
F: + 1 843 527 4577

**Charleston**

**Kinder Morgan Terminals -  
Shipyard River Terminal**  
Mid Atlantic Regional Office  
1801 Milford Street  
Charleston  
South Carolina  
29405  
USA  
T: + 1 843 843 0543  
F: + 1 843 853 3367  
W: www.kindermorgan.com

**Charleston**

**Kinder Morgan Terminals - Pier  
IX Terminal**  
Mid Atlantic Regional Office  
1801 Milford Street  
Charleston  
South Carolina  
29405  
USA  
T: + 1 843 843 0543  
F: + 1 843 853 3367  
W: www.kindermorgan.com

**Charleston**

**Port of Charleston**  
South Carolina State Ports  
Authority  
PO Box 22287  
Charleston  
SC  
29413  
USA  
Contact: Mr Fred Stribling  
VP Marketing & Sales  
T: Port of Bellingham  
F: + 1 843 577 8710  
E: SCSPPAMktg\_Sales@scspa.com

**Charlotte**

**CSX World Terminals**  
2101 Rexford Road  
Suite 250 West  
Charlotte  
North Carolina  
28211

USA

Contact: Mr Gert De Piper  
Senior Vice President, Chief  
T: + 1 704 973 7200  
F: + 1 704 9737246  
W: www.csxwt.com

**Chesapeake**

**Kinder Morgan Elizabeth River  
Terminals**  
4100 Buell Street  
Chesapeake  
VA 23324  
USA  
Contact: Ms Jennifer Darden  
T: + 1 757 543 0335  
F: + 1 757 543 8936  
E:  
jennifer\_darden@kindermorgan.com  
W: www.kindermorgan.com  
Location: Southern Branch Elizabeth  
River  
Bulk Berths: 2x 100'0 berths @ 35'  
Total uncovered Storage: 110 acre  
terminal  
Total covered Storage: Over 600,000  
sq feet  
Storage and handling, including valve  
added services, of dry bulk materials.

**Chicago**

**Illinois International Port Dist.**  
3600 East 95th Street  
Chicago  
IL  
60617  
USA  
Contact: Mr Anthony G Ianello Jnr  
Executive Director  
T: + 1 773 646 4400  
F: + 1 773 221 7678  
E: iipd@iipd.com  
W: www.iipd.com  
Location: South of Chicago on Lake  
Michigan and the Calumet River

**Chicago**

**KCBX Terminals Company**  
3259 E. 100th Street  
Chicago  
IL  
60617  
USA  
Contact: Mr Tom Kramer  
General Manager  
T: + 1 773 933 5302  
F: + 1 773 933 5309  
E: kramert@kochind.com  
Location: 100th Street & Calumet  
River, Chicago, IL  
Equipment & Capacity: Twin bottom  
dump 2,000tph unloading systems,  
Traveling Tower ship loaders,  
10,000,000t annual capacity  
Bulk Berths: Twin loading berths each  
735ft length  
Total uncovered Storage: 1,000,000t  
River barge unloading and loading  
services.

**Cleveland**

**Port of Cleveland**  
1375 E. 9th Street  
#2300  
Cleveland  
Ohio 44114-1786  
USA  
Contact: Mr Eric Hirsimaki  
Marketing  
T: + 1 216 241 8004  
F: + 1 216 241 8016  
E: eric.hirsimaki@portofcleveland.com  
Location: Downtown Cleveland, Ohio  
USA on Lake Erie  
Equipment & Capacity: 4 Cranes to  
150 tons  
Bulk Berths: Cleveland Bulk Terminal:  
300m length, 8.3m depth  
Total uncovered Storage: 40 hectares  
Total covered Storage: 35000sqm  
Good rail and road access

**Conneaut**

**Pittsburgh & Conneaut Dock Co.**  
950 Ford Ave  
Conneaut  
Ohio  
44030  
USA  
Contact: Mr James Rogers  
Senior Manager of Dock  
Operations  
T: + 1 440 599 0242  
F: + 1 440 599 0245  
E: James.Rogers@cnworldwide.com  
W: www.cn.ca  
Location: West Of Erie Pa. on Lake  
Erie  
Equipment & Capacity: 4 reclaimers  
and 4 stackers  
Total uncovered Storage: 5 million  
sqm

**Convent**

**IC RailMarine Terminal (ICRMT)**  
7790 LA, Highway 44  
Convent  
LA  
70723  
USA  
President  
T: + 1 225 562 5201  
F: + 1 225 562 9948  
E: bruce.conti@cn.ca  
Location: MP 161.0 AHP Mississippi  
River  
(East bank between Baton Rouge and  
New Orleans)  
Equipment & Capacity: IMPSA Ship  
Unloader - 1500 Mtp, Gottwald Ship  
Unloader - 900 Mtp, Metalna  
Traveling Ship Loader-2700 Mtp,  
EMS Tech Barge Loader - 450 Mtp  
(all nameplate rates)  
Bulk Berths: Vessels 850' LOA-Beam  
150'  
Total uncovered Storage: 34 acres -  
two pads - 1.2 million tons  
Total covered Storage: none  
Italimpianti Traveling Radial Stacker,  
Heyl & Patterson Rotary/Bottom Car  
Dumper, Kanawha Railcar Batch  
Loader, 130 Railcar Unit Train Loop  
Track. Railroad: Canadian National  
Railroad

**Convent**

**St. James Stevedoring Partners,  
LLC**  
9114 Stevedoring Road  
Convent  
LA  
70723  
USA  
Contact: Mr John C Crane  
Vice President  
T: + 1 225 562 3919  
F: + 1 225 562 3515  
E: jcrane@sjustevedore.com  
W: www.sjustevedore.com  
Location: Mississippi River, Texas Gulf  
Equipment & Capacity: 8 Gottwald  
Floating Cranes  
Bulk Berths: 6 midstream berths for  
handling up to cape sized vessels  
St. James operates a coal auger  
barge for obtaining mechanical coal  
samples.

**Coos Bay**

**Oregon International Port of  
Coos Bay**  
PO Box 1215  
Coos Bay  
OR  
97420  
USA  
Contact: Mr Jeffrey Bishop  
General Manager  
T: + 1 541 267 7678  
F: + 1 541 269 1475  
E: jbishop@portofcoosbay.com  
W: www.portofcoosbay.com

**Cora**

**Kinder Morgan Terminals - Cora**  
Mid Atlantic Regional Office  
1801 Milford Street  
Charleston  
South Carolina  
29405  
USA  
Contact: Mr Brian Feyereisen  
T: + 1 843 853 0453  
F: + 1 843 853 7971  
E: brian\_feyereisen@  
kindermorgan.com  
W: www.kindermorgan.com

**Cordova**

**Port of Cordova**  
P.O.Box 1210  
Cordova  
Alaska AK 99574  
USA  
Contact: Mr Dale R Muma  
Port Director  
T: + 1 907 4246400  
F: + 1 907 4246000  
E: harbor@cityofcordova.net

**Corpus Christi**

**Public Elevator**  
PO Box 2229  
Corpus Christi TX 78403  
USA  
Contact: Mr Ed Altemus  
Director of Trade  
T: + 1 361 882 1456  
F: + 1 361 882 1998

**Corpus Christi**

**Boyd-Campbell Company**  
210 S. Carancahua  
Suite 620  
Corpus Christi  
Texas 78401  
USA  
Contact: Mr Sonny Boyd  
Manager/Agent  
T: + 1 361 884 9321  
F: + 1 361 884 9067  
E: agency@boyd-campbell.com  
Location: Corpus Christi and Point  
Comfort, Texas, USA  
Equipment & Capacity: Stevedore  
bulk cargoes, break bulk cargoes and  
heavy lift cargoes.  
Bulk Berths: Bulk Materials Dock #1 -  
one rolling gantry crane with grab  
bucket that can be used for loading or  
unloading bulk cargoes.  
Bulk Materials Dock #2 - one radial  
loader.  
Total uncovered Storage: Port owned  
property may be leased short term or  
long term.  
Port public pads for bulk cargoes at  
Bulk Handling Terminal .  
Large amounts of pads for break bulk  
cargo in South and North Side Cargo  
Terminals.  
Total covered Storage: Limited private  
covered storage for bulk cargoes.  
Port has 1 large covered storage area  
in their North Side Cargo Terminal  
and 2 large covered storage areas in  
their South Side Cargo Terminal that  
can be used for bulk or break bulk  
cargoes.  
North and South Side Cargo  
Terminals have wide aprons or open  
docks for discharge direct to trucks or  
rail.

**Corpus Christi**

**Port of Corpus Christi**  
PO Box 1541  
222 Power Street  
Corpus Christi TX 78403  
USA  
Contact: Mr Maynard "Sandy"  
Sanders  
Deputy Port Director Operations  
T: + 1 361 885 6115  
F: + 1 361 882 7110

E: jvalls@pocca.com  
W: www.portofcorpuschristi.com

**Corpus Christi**

**Port of Corpus Christi - Bulk  
Terminal**  
PO Box 1541  
222 Power Street  
Corpus Christi  
TX  
78403  
USA  
Contact: Mr Paul (Skip) Kaup  
Bulk Terminal Manager  
T: + 1 361 883 1162  
F: + 1 361 883 1652  
E: paulg@pocca.com  
W: www.portofcorpuschristi.com  
Location: Gulf of Mexico  
Equipment & Capacity: Gantry Crane  
600tph. Shiploader 1,500tph  
Bulk Berths: Depth: 45'

**Corpus Christi**

**Sherwin Alumina, L.P.**  
PO Box 9911  
Corpus Christi  
Texas 78469  
USA  
Contact: Mr Josh Autenrieth  
Port Superintendent  
T: + 1 361 7772434  
F: + 1 361 7772347  
E: raabrajano@sherwinalumina.com

**Darrow**

**Cooper/Consolidated**  
  
PO Box 242  
Darrow  
LA  
70724  
USA  
Contact: Mr Brent C Mahana  
General Manager - Sales  
T: + 1 985 871 4403  
F: + 1 985 867 3509  
E: Brent.Mahana@cgb.com  
W: www.cooperconsolidated.com  
Location: Lower Mississippi River  
Equipment & Capacity: Multiple high  
capacity floating cranes  
Mid-stream coal transfer facility aka  
"LMO"  
and mid-stream grain transfer facility  
aka "The America"  
Bulk Berths: 11 mid-stream berths  
(mp 111-180)  
Total uncovered Storage: n/a  
Total covered Storage: n/a  
We specialize in full logistics  
solutions. Services include  
stevedoring, barging, trucking, rail,  
inland terminaling, as well as barge  
fleeting, cleaning and repairs.

**Darrow**

**Burnside Bulk Marine Terminal**  
4258 Highway 44  
Darrow  
LA  
70725  
USA  
Contact: Mr Mike Tenchuk  
CEO  
T: + 1 225 474 3792  
F: + 1 225 474 3719  
E: mike.tenchuk@ormet.com  
W: www.burnsideterminal.com

**Davant**

**United Bulk Terminals - Davant**  
14537 Hwy 15  
Davant  
LA  
70040  
USA

Contact: Mr Brian Miles  
Vice President of Sales & Marketing  
T: +1 504 301 9193  
E: brian.miles@unitedbulkterminals.com  
W: www.unitedbulkterminals.com  
Location: Lower Mississippi river Mile Post 55. Davant, LA USA.  
Bulk Berths: 4 Berths  
Buoys; #1 Dock- 2200 ft; #2 Dock 1000 ft  
Total uncovered Storage: 200 acres-storage space for 5 million tonnes  
Total covered Storage: N/A  
United Bulk Terminals-Davant is a full service bulk stevedore. We can handle four panamax vessels at one time. Most storage space on the Mississippi River. Package Logistics opportunities available.

## Davant

### U.S. United Bulk Terminal

14537 Highway 15  
Davant  
Louisiana  
70040  
USA  
Contact: Mr Brian Miles  
T: +1 504 301 9193  
F: +1 504 834 2772  
E: brian.miles@united-mar.com  
W: www.unitedbulkterminal.com  
Location: Mile Post 55 Lower Mississippi River, Left Descending Bank  
Equipment & Capacity: Storage Capacity: 5 million tonnes  
Throughput Capacity: 25 million tonnes  
Bulk Berths: Berthing available for four Panamax  
Total uncovered Storage: 5 million tonnes  
Largest full service terminal on the Mississippi River

## Decatur

### Kinder Morgan Terminals - Decatur

Lower River Regional Office  
7116 Highway 22  
PO Box 625  
Sorrento  
LA  
70778-0625  
USA  
Contact: Mr Hans Luetkemeier  
Commercial Director  
T: +1 225 675 0308  
F: +1 225 675 8259  
E: hans\_luetkemeier@kindermorgan.com  
W: www.kindermorgan.com/  
bulk\_terminals/

## Decatur

### ARTCO

4666 Faries Parkway  
Decatur  
IL  
62526  
USA  
Contact: Mr Kevin Van Meter  
Director  
T: +1 217 424 5556  
F: +1 217 451 4122  
E: kevin.vanmeter@adm.com  
W: www.admworld.com

## Detroit

### Detroit / Wayne County Port Authority

8109 E. Jefferson Ave.  
Detroit  
MI  
48214  
USA  
Contact: Miss Cheryl Solomon  
Marketing Director  
T: +1 313 331 3842x310

F: +1 313 331 5457  
E: solomon@portdetroit.com  
W: www.portdetroit.com

## Detroit

**Port of Detroit**  
8109 Jefferson Avenue  
Detroit  
Michigan  
48214  
USA  
Contact: Ms Cheryl Graham  
Solomon  
Marketing Director  
T: +1 313 331 3842 ext 310  
F: +1 313 331 5457  
E: solomon@portdetroit.com  
W: www.portdetroit.com

## Duluth

**Duluth Seaway Port Authority**  
1200 Port Terminal Drive  
Duluth  
MN  
55802-2609  
USA  
Contact: Ms Adele Yorde  
Public Relations Manager  
T: +1 218 727 8525  
F: +1 218 727 6888  
E: ayorde@duluthport.com  
W: www.duluthport.com  
Location: Western-most tip of Lake Superior and Great Lakes/ Saint Lawrence Seaway System in North America.  
Bulk Berths: 20 privately owned/operated commercial docks: 10 bulk cargo, 2 ore docks, 1 coal terminal, 7 grain elevators; 1 fueling depot; tug/barge services; plus 1 breakbulk terminal.  
On average, the Port of Duluth-Superior sees nearly 1,000 vessel calls and handles 40 million net tons each year with principal cargoes: iron ore, coal, grain, limestone, cement, salt and other commodities plus heavy-lift and project cargo.

## Duluth

### General Mills Elevator A

200 Garfield Ave.  
Duluth  
MN  
55802  
USA  
Contact: Mr Douglas Christiansen  
General Manager  
T: +1 218 722 7759  
F: +1 218 727 7956  
E: doug.christiansen@genmills.com

## Duluth

### AGP Grain Limited

602 Arthur Avenue  
Duluth  
MN  
55802-2602  
USA  
Superintendent  
T: +1 218 722 0538  
F: +1 218 722 0076  
E: info@agp.com  
W: www.agp.com/

## East Liverpool

### Columbiana County Port Authority

1250 St. George Street  
East Liverpool  
Ohio  
43920  
USA  
Contact: Mr Tracy Drake  
Chief Executive Officer  
T: +1 330 386 9051  
F: +1 330 386 1122  
E: ccpa@ccpa-ohioriver.com  
Location: Wellsville Intermodal Facility - Ohio River mile Post 49. Pittsburgh-

Cleveland Area  
Equipment & Capacity: 60 ton bridge crane/bulk  
Bulk Berths: Conveyor System  
Opening - 2011

## Eastport

**Eastport Port Authority**  
PO Box 278  
3 Madison Street  
Eastport  
ME  
04631  
USA  
Contact: Mr Christopher Gardner  
Executive Director  
T: +1 207 853 4614  
F: +1 207 583 9584  
E: eportauth@nemaine.com  
W: www.portofeastport.org

## Erie

**Mount Fort Terminal**  
PO Box 179  
2 East Bay Drive  
Erie  
PA  
16512-0179  
USA  
Contact: Mr Callaghan  
Terminal Manager  
T: +1 814 453 6721  
F: +1 814 453 5138  
E: dtodeagleton@aol.com

## Eureka

**Humboldt Bay Harbour District**  
P.O.Box 1030  
Eureka  
California  
CA 95502-1030  
USA  
Contact: Mr David Hull  
Chief Executive Officer  
T: +1 707 4430801  
F: +1 707 443080  
E: info@portofhumboldt.org

## Evansville

### Kinder Morgan Terminals - Evansville

Midwest Regional Office  
8500 West 68th Street  
Argo  
Illinois  
60501  
USA  
Contact: Mr Roy Cook  
T: +1 414 769 1901 ext-120  
F: +1 414 769 1144  
E: roy\_cook@kindermorgan.com  
W: www.kindermorgan.com

## Everett

**Port of Everett**  
PO Box 538  
Everett  
WA  
98206  
USA  
Contact: Ms Lisa Lefeber  
PR/Communication Administrator  
T: +1 425 259 3164  
F: +1 425 252 7366  
E: lisam@portofeverett.com  
W: www.portofeverett.com  
Location: West Coast of USA  
Equipment & Capacity: Lift up to 100 tons  
Bulk Berths: 7  
Total covered Storage: 36,000 sq ft  
2 x 40 LT Mitsubishi Gantry Cranes will be in service year 2005.

## Fields Landing

**Port of Eureka**  
Fields Landing  
PO Box 266  
Fields Landing  
CA 95537  
USA

Contact: Mr Stamwood A Murphy  
Jnr  
Port Owner  
T: +1 707 443 5631  
F: +1 707 443 3553  
W: www.humboldtport.org

## Fort Lauderdale

**Port Everglades Department of Broward County**  
1850 Eller Drive  
6th Floor Administration Building  
Fort Lauderdale  
FL  
33316  
USA  
Contact: Ms Ellen Kennedy  
Marketing  
T: +1 954 523 3404  
F: +1 954 525 1910  
E: portevergladescargo@broward.org  
W: www.co.broward.fl.us/port.htm

## Fresno

**Penny Newman Grain Co**  
PO Box 12147  
Fresno  
California  
93776  
USA  
Contact: Mr Mike Nicoletti  
T: +1 559 448 8800  
F: +1 559 448 0500  
E: mike@penny-newman.com

## Galveston

**Farmland Elevator G**  
3100 Wharf Rd  
PO Box 2647  
Galveston  
Texas  
77553  
USA  
T: +1 409 763 6447  
F: +1 409 763 8608

## Galveston

**Port of Galveston**  
PO Box 328  
Galveston  
Texas  
77553  
USA  
Contact: Captain John G Peterlin III  
Senior Director of Marketing  
T: +1 409 766 6112  
F: +1 409 766 6107  
E: jpeterlin@portofgalveston.com  
W: www.portofgalveston.com

## Galveston

**Metro Ports**  
PO Box 1252  
Galveston  
TX  
77553  
USA  
Contact: Mr Troy Gouger  
General Manager  
T: +1 409 762 8131  
F: +1 409 762 1006  
E: troy.gouger@metroports.com  
W: www.metroports.com

## Garden City

**Metro Ports**  
16 Foundation Drive  
Garden City  
GA  
31408  
USA  
Contact: Mr Ted Winter  
VP Business Development  
T: +1 310 816 6545  
F: +1 912 963 5640  
E: info@metroports.com  
W: www.metroports.com  
Location: Port of Savannah Berth 1A

## Georgetown

**Winyah Stevedoring Inc**  
PO Box 1498  
Georgetown  
SC  
29442  
USA  
Contact: Mr Perry Collins  
T: +1 843 527 2823  
F: +1 843 527 1179

## Georgetown

**Stevedoring Services of America (SSA)**  
609 Kaminski Street  
Georgetown  
SC  
29442  
USA  
Contact: Mr Buddy Wiggins  
Operations Manager  
T: +1 843 971 2900  
F: +1 843 971 2919  
E: buddy.wiggins@ssamarine.com

## Georgetown

**Port of Georgetown**  
South Carolina State Ports Authority  
PO Box 601  
1324 Dock Street, Pier 31  
Georgetown  
SC  
29440  
USA  
Contact: Mr L David Schronce  
Director  
T: +1 843 527 4476  
F: +1 843 527 2601  
E: dschronce@scspa.com

## Georgetown

**WSI of the Southeast llc**  
PO Box 1498  
Georgetown  
SC  
29442  
USA  
Contact: Mr Perry Collins  
General Manager  
T: +1 843 527 2823  
F: +1 843 527 1179  
E: perry.collins@wsijason.com  
W: www.wsijason.com

## Georgetown

**Liberty Terminals, LLC**  
PO Box 1498  
Georgetown  
29442  
USA  
Contact: Mr Perrt R Collins  
Managing Member  
T: +1 843 527 1743  
F: +1 843 527 1743  
E: sc@liberty-terminals.com

## Glen Carbon

**SynFuel Technologies Inc.**  
20A Kettle River Drive  
Glen Carbon  
IL  
62034  
USA  
Contact: Mr Robert Van Patten  
President  
T: +1 618 655 1201  
F: +1 618 656 1363  
E: rmvanpatten@aol.com

## Grand Rivers

**Kinder Morgan Terminals - Grand Rivers**  
Mid Atlantic Regional Office  
1801 Milford Street  
Charleston  
South Carolina  
29405  
USA  
T: +1 843 722 2878



F: + 1 843 722 5720  
W: www.kindermorgan.com

**Green Bay**

**Port of Green Bay**  
Brown County  
2561 S. Broadway Street  
Green Bay  
WI  
54304  
USA  
Contact: Mr Dean Haen  
Port Manager  
T: + 1 920 492 4950  
F: + 1 920 492 457  
E: haen\_dr@co.brown.wi.us  
W: www.portofgreenbay.com

**Gretna**

**Associated Grain Terminals**  
848 Behrman Hwy  
Gretna  
Louisiana  
70053  
USA  
Contact: Mr Bill Sullivan  
Terminal Manager  
T: + 1 985 536 4520  
F: + 1 985 536 4521  
E: bill@associatedterminals.com  
W: www.associatedterminals.com  
Location: Lower Mississippi River miles 56 to 58  
Equipment & Capacity: Floating grain elevator and fleet of midstream stevedoring cranes.  
Bulk Berths: Three midstream berths  
Total uncovered Storage: 0  
Total covered Storage: 0  
AGT offers a flexible and reliable one-stop shop for moving bulk cargo on the Lower Mississippi. Short vessel transit times make this an ideal port to move cargo efficiently at midstream berths.

**Gulfport**

**Mississippi State Port Authority at Gulfport**  
One Hancock Plaza  
Suite 1401  
Gulfport  
MS  
39501/39502  
USA  
Contact: Mr John H Webb  
Deputy Director of Engineering  
T: + 1 228-865 4300  
F: + 1 228-865 4335  
E: jwebb@shipmspa.com  
W: www.shipmspa.com

**Hilo**

**State of Hawaii, Department of Transportation**  
Harbours Division, Hawaii District  
Hilo  
HI  
96720  
USA  
Contact: Mr Jeff D. Hood  
District Manager  
T: +1 808 933 8850  
F: +1 808 933 8851  
E: jeff.d.hood@hawaii.gov  
W: www.state.hi.us/dot/harbors  
Location: Hawaii Island  
Equipment & Capacity: None  
Bulk Berths: 1265 feet  
Total uncovered Storage: n/a  
Total covered Storage: n/a  
Hawaii Island Harbors District has two ports, Hilo & Kawaihae. Hilo is on the east side & Kawaihae is on the west side of the island.

**Hilo**

**Hilo Harbour**  
Department of Transportation  
Harbours Division  
80 Kuhio Street

Hilo  
HI 96720  
USA  
Contact: Mr Jeff D Hood  
District Manager  
T: + 1 808 933 8850  
F: + 1 808 933 8851  
E: Jeff.Hood@hawaii.gov

**Homer**

**City of Homer Port and Harbor**  
4350 Homer Spit Road  
Homer  
Alaska  
99603  
USA  
Contact: Mr Bryan Hawkins  
Port Director/Harbormaster  
T: + 1 907 235 3160  
F: + 1 907 235 3152  
E: port@ci.homer.ak.us  
W: http://www.cityofhomer-ak.gov/port  
Location: End of Homer Spit in Kachemak Bay, Alaska  
Equipment & Capacity: Small Harbor with 920 reserved stalls and over 6,000 linear feet of transient moorage available; Port consisting of two commercial docks; Fish dock for loading/unloading seafood

**Honolulu**

**Honolulu Port Authority**  
700 Fort Street  
Honolulu  
HI 96813  
USA  
Contact: Mr Scott Cunningham  
Harbour Master  
T: + 1 808 587 2050  
F: + 1 808 587 2065  
E: dotpao@hawaii.gov  
W: www.ehawaii.gov/dakine/index.html  
Location: Pier 23  
South coast of island of Oahu  
Bulk Berths: Max draught 34' / 10.36m

**Houston**

**Public Elevator 2**  
PO Box 2562  
Houston  
Texas  
77252-2562  
USA  
Contact: Mr Jimmy Jamison  
T: + 1 713 670 2676  
F: + 1 713 670 2562

**Houston**

**Tx Tx Corporation**  
11811 Interstate  
10 East  
Suite 630  
Houston  
Texas  
77029  
USA  
Contact: Mr Gary Nixon  
T: + 1 713 453 0664  
F: + 1 713 453 2756

**Houston**

**Cooper/T. Smith Stevedoring**



2315 McCarty Drive  
Houston  
Texas  
77029  
USA  
Contact: Mr Britton Cooper  
Vice President Operations  
T: + 1 713 675 0017  
F: + 1 713 675 2370  
E: britton.cooper@coopertsmith.com  
W: www.coopertsmith.com

**Houston**

**Port of Houston Authority**  
1519 Capital Avenue  
PO Box 2562  
Houston  
Texas  
77252  
USA  
Contact: Ms Lisa Whitlock  
Advertising Manager  
T: + 1 713 670 2644  
E: lwhitlock@poha.com  
W: www.portofhouston.com

**Humble**

**P&O Ports Texas, Inc.**  
5810 Wilson Road  
Suite 220  
Humble  
Texas  
77396  
USA  
Contact: Mr Norman Lamb  
Vice President  
T: + 1 832 615 7201  
F: + 1 832 615 7250  
E: norman.lamb@portsamerica.com  
W: www.portsamerica.com  
Location: Houston, Tx; Galveston, TX; Beaumont, TX, Corpus Christi, TX and Freeport, TX  
Contract Stevedore and Terminal Operator

**Indiana**

**Port of Indiana**  
Burns Int'l Harbour 6600  
US Highway  
12 Portage  
Indiana  
46368  
USA  
Contact: Mr Peter Becarthy  
T: + 1 219 787 8636  
F: + 1 219 787 8842  
E: info@portsofindiana.com

**Indianapolis**

**Burns International Harbour-Port of Indiana**  
Indiana Port Commission  
150 West Market Street  
Suite 603  
Indianapolis  
IN  
46204  
USA  
Contact: Mr Jody Peacock  
Marketing  
T: + 1 317 232 9200  
F: + 1 317 232 0137  
E: jpeacock@portsofindiana.com  
W: www.portsofindiana.com

**Jacksonville**

**Jacksonville Port Authority**  
2831 Talleyrand Avenue  
Jacksonville  
FL 32206  
USA  
Contact: Mr R Comer  
Assistant Production Manager  
T: + 1 904 630 3070  
F: + 1 904 630 3066  
E: info@jaxport.com  
W: www.jaxport.com

**Jacksonville**

**Jacksonville Electric Authority**  
21 West Church St  
Jacksonville  
FL 32202  
USA  
Contact: Mr Wanyonyi Kendrick  
Chief Information Officer  
T: + 1 904 665 7217  
E: kendwj@jea.com  
W: www.jea.com

**Juneau**

**Port of Juneau**  
City Dock and Alaska Steam Dock  
155 South Seward  
Juneau  
Alaska  
AK 99801  
USA  
Contact: Mr John Stone  
Port Director  
T: + 1 907-586-0292  
F: + 1 907-586-0295  
E: john.stone@ci.juneau.ak.us  
W: www.juneau.lib.ak.us

**Kalama**

**Peavey Elevator**  
2211North Hendricks Drive  
PO Box 1008  
Kalama  
Washington 98625  
USA  
Contact: Mr Steve Oakes  
T: + 1 360 673 3900  
F: + 1 360 673 3910

**Kalama**

**Harvest States Elevator**  
400 Toteff Road  
Kalama  
Washington  
98625  
USA  
Contact: Mr Lance Helgeson  
T: + 1 360 673 2011  
F: + 1 360 673 5101  
E: lance.helgeson@chsinc.com

**Kenai**

**Port of Kenai**  
210 Fidalgo  
Kenai  
Alaska AK 99611  
USA  
Contact: Mr Keith Kornelis  
Port Director  
T: + 1 907 2837535  
F: + 1 907 2621892  
E: bfrates@ci.kenai.ak.us  
W: www.ci.kenai.ak.us

**Kenova**

**Big Sandy Terminal Inc**  
Big Sandy River Road  
Kenova  
West Virginia  
25530  
USA  
Contact: Mr Phil Rogers  
President  
T: + 1 304 453 6161  
F: + 1 304 453 1117  
E: phil.rogers@nscorp.com

**Kirkland**

**Macquarie Ports Inc**  
620 Kirkland Way  
Suite 206  
Kirkland  
WA  
98033  
USA  
Contact: Mr James Leonard  
E: james.leonard@macquarie.com  
W: www.macquarie.com

**Kodiak**

**City of Kodiak Harbour Department**  
403 Marine Way  
Kodiak  
Alaska  
AK 99615  
USA  
Contact: Mr G V McCorkle  
Harbour Master  
T: + 907 486 8080  
F: + 907 486 8090  
W: www.kodiak.org

**La Place**

**Port of South Louisiana**  
171 Belle Terre Boulevard  
La Place  
Louisiana  
70068  
USA  
Contact: Ms Linda Prudhomme  
Director of Business Development  
T: + 1 985 652 9278  
F: + 1 985 652 9518  
E: lprudhomme@portsl.com  
W: www.portsl.com  
Location: Lower Mississippi River  
Equipment & Capacity: 60 private and public docks and facilities - 246 million tonnes/year  
Bulk Berths: Globalplex Intermodal Terminal Bulk Cargo Handling Facility - 570'x44" (Port-Owned)  
Total covered Storage: Two 50,000 ton cement domes  
The Port of South Louisiana covers 54 miles on the lower Mississippi River (mile 114-118). "America's largest tonnage port".

**Lake Charles**

**Lake Charles Harbor & Terminal District**  
PO Box 3753  
150 Marine Street  
Lake Charles  
LA 70602  
USA  
Contact: Mr Dan Loughney  
Director of Marketing & Trade Development  
T: + 1 337 439 3661  
F: + 1 337 493 3528  
E: marketing@portlc.com  
W: www.portlc.com

**Lake Charles**

**Port of Lake Charles**  
150 Marine Street  
Lake Charles  
LA  
70602  
USA  
Contact: Mr Winn  
T: + 1 337 439 3661  
F: + 1 337 439 3523  
E: marketing@portlc.com  
W: www.portlc.com

**Lamberts Point**

**Norfolk Southern - Lamberts Point**  
Coal Business Group  
110 Franklin Rd  
Roanoke  
VA  
24042-0026  
USA  
Contact: Mr Mark H Bower  
Group VP Export & Metallurgical Coal Marketing  
T: + 1 540 985 6711  
F: + 1 540 985 6398  
E: Mark.Bower@nscorp.com  
W: www.nscorp.com  
Location: Hampton Roads, Virginia  
USA

**Laplace**

**Consolidated Terminals & Logistics Company**



Midstream buoys at Laplace.  
c/o headquarters at:  
PO Box 249  
Mandeville  
LA  
70470-0249  
USA  
Contact: Mr Brent C Mahana  
Director of Sales & Marketing

# Innovation. Dedication. Experience.



STEVEDORING ♦ BARGE ♦ TRUCK ♦ RAIL ♦ OCEAN ♦ LOGISTICS



Featuring the "Louisiana Mid-Stream One", a unique barge-mounted conveying system that offers quality control features such as a metal collection and mechanical sampling.

Over 40 Years of Coal Transfer & Transportation Experience.  
Innovative Transfer Technologies. Seamless Logistics Packages.  
Dedicated Customer Service.



COOPER/CONSOLIDATED

Telephone +1 985 871-4403 • Fax +1 985 867-3509

**CTLC**

CONSOLIDATED TERMINALS AND LOGISTICS CO.

A Division of  Enterprises, Inc.

[www.cctlconline.com](http://www.cctlconline.com)



the COOPER GROUP of companies

[www.coopertsmith.com](http://www.coopertsmith.com)



T: + 1 985 871 4403  
 F: + 1 985 867 3509  
 E: Brent.Mahana@cgb.com  
 W: www.cticonline.com  
 Location: Lower Mississippi River  
 Equipment & Capacity: Multiple high capacity floating cranes. Mid-stream coal transfer facility aka "LMO", dry dock, turn fleet servicing 500+ barges, aggregate dock/yard with 20,000 ton capacity and scales  
 Bulk Berths: 11 mid-stream berths (mp 111-180)  
 CTLC offers full inland logistics including vessel Stevedoring, Barging, Terminal, Truck and Rail delivery to all inland destinations.

**Laplace**  
**Cooper/Consolidated**



Midstream buoys at Laplace.  
 c/o headquarters at:  
 PO Box 249  
 Mandeville  
 LA  
 70470-0249  
 USA  
 Contact: Mr Brent C Mahana  
 General Manager - Sales  
 T: + 1 985 871 4403  
 F: + 1 985 867 3509  
 E: Brent.Mahana@cgb.com  
 W: www.cooperconsolidated.com  
 Location: Lower Mississippi River  
 Equipment & Capacity: Multiple high capacity floating cranes  
 Mid-stream coal transfer facility aka "LMO"  
 and mid-stream grain transfer facility aka "The America"  
 Bulk Berths: 11 mid-stream berths (mp 111-180)  
 Total uncovered Storage: n/a  
 Total covered Storage: n/a  
 We specialize in full logistics solutions. Services include stevedoring, barging, trucking, rail, inland terminaling, as well as barge fleet, cleaning and repairs.

**Long Beach**  
**MCC-Lucky Cement Terminal**  
 1150 Pier F Avenue  
 Pier F Berth 208  
 Long Beach, California 90802  
 USA  
 Contact: Mr Marty Marcum  
 Manager of Operations  
 T: + 1 562 495 0600  
 F: + 1 562 495 5929

**Long Beach**  
**Cooper/T. Smith Stevedoring**



**Cooper/T. Smith**

PO Box 229  
 Long Beach  
 California  
 90801  
 USA  
 Contact: Mr Ed Viner  
 Assistant Vice President/Operations  
 Manager  
 T: + 1 562 436 2259  
 F: + 1 562 590 0547  
 E: ed.viner@coopertsmith.com  
 W: www.coopertsmith.com

**Long Beach**  
**Metro Ports**  
 1045 Pier G Avenue  
 Long Beach  
 California 90802  
 USA

Contact: Mr Brian Johnson  
 Vice President Business  
 Development  
 T: + 1 310 816 6523  
 F: + 1 310 816 6519  
 E: info@metroports.com  
 W: www.metroports.com  
 Location: Port of Long Beach Berths  
 G212-214  
 Equipment & Capacity: 1 x 2500  
 Mtpth, 1 x 4,500 Mtpth traveling  
 shiploaders  
 Bulk Berths: 2 berths, 1900' total (1 x  
 40' draught, 1 x 50' draught at MLLW)

**Long Beach**  
**Oxbow Carbon & Minerals LLC**

330 Golden Shore  
 Suite 210  
 Long Beach  
 CA 90802  
 USA  
 Contact: Mr Jimmy Roachell  
 Facility Manager  
 T: + 1 409 944 3308  
 F: + 1 409 944 3551  
 E: jimmy.roachell@oxbow.com  
 W: www.oxbow.com  
 Location: Texas Gulf Coast, USA  
 Equipment & Capacity: 2 hydraulic  
 cranes: (1) 90 ton RT, and (1) 15 ton  
 galleon  
 Bulk Berths: Dock #45, 1 berth  
 Total uncovered Storage: 22 acres  
 Total covered Storage: n/a

**Long Beach**  
**Port of Long Beach**

PO Box 570  
 Long Beach CA 90801  
 USA  
 Contact: Mr Art Wong  
 Director of Communications  
 T: + 1 562 590 4123  
 F: + 1 310 437 3231  
 E: wong@polb.com  
 W: www.polb.com

**Longview**  
**Port of Longview**

10 Port Way  
 Longview  
 WA 98632-7739  
 USA  
 Contact: Mrs Laurie Nelson-Cooley  
 Business Development Manager  
 T: + 1 360 425 3305  
 F: + 1 360 425 8650  
 E: lnelson-cooley@portoflongview.com  
 W: www.portoflongview.com  
 Location: Southwest Washington  
 State, USA  
 Equipment & Capacity: Bulk,  
 breakbulk and project cargo handling  
 Bulk Berths: Berth 2, Berth 5  
 Total uncovered Storage: 2 million sq.  
 ft.  
 Total covered Storage: 1 million sq. ft.  
 Premier bulk, breakbulk and project  
 cargo handling port in SW  
 Washington State on the deep draft  
 Columbia River.

**Louisville**  
**Cooper/T. Smith Stevedoring**

Louisville Jefferson Riverport  
 Terminal  
 6900 Riverport Drive  
 Louisville KY 40258  
 USA  
 Contact: Mr Joe Knight  
 Operations Manager  
 T: + 1 502 935 7226  
 F: + 1 502 935 7296  
 E: joe.knight@coopertsmith.com  
 W: www.coopertsmith.com

**Louisville**  
**Kinder Morgan Terminals -  
 Louisville**

Midwest Regional Office  
 8500 West 68th Street  
 Argo  
 Illinois  
 60501  
 USA  
 Contact: Mr Roy Cook  
 T: + 1 414 769 1901 ext-120  
 F: + 1 414 769 1144  
 E: roy\_cook@kindermorgan.com  
 W: www.kindermorgan.com

**Mason**

**Coal Network**  
 1111 Western Row Rd.  
 Mason  
 Ohio  
 45040  
 USA  
 Contact: Mr Ramesh Malhotra  
 President  
 T: + 1 513-398-2625  
 F: + 1 513-398-5419  
 E: rmalhotra@uscoalnet.com

**Maumee**  
**The Andersons, Inc**

PO Box 119  
 Maumee  
 Ohio  
 43537-0119  
 USA  
 Contact: Mr Don Wray  
 T: + 1 419 241 8943  
 F: + 1 419 255 5366  
 E: don\_wray@andersonsinc.com  
 W: www.andersonsinc.com  
 Location: Toledo/Lake Erie  
 Equipment & Capacity: Grain  
 Merchant  
 Bulk Berths: 1,000 ft/seaway draft  
 Grain shipping and receiving. Bulk  
 liquid and dry ag fertilizer. NSRR.

**Maumee**  
**The Andersons - Maumee Grain  
 Marine facilities**

Kuhlman & Edwin Drive  
 General offices  
 PO Box 119  
 480 W. Dussel Drive  
 Maumee  
 Ohio  
 43537  
 USA  
 Contact: Mr Jim McKinstry  
 Director, Development and  
 Transportation  
 T: + 1 419 891 6565  
 F: + 1 419 891 6513  
 E: jim\_mckinstry@andersonsinc.com  
 W: www.andersonsinc.com  
 Location: Maumee River / Toledo, OH  
 Bulk Berths: 2 x 1000 ft @ Seaway  
 draught  
 Total covered Storage: 1 million metric  
 tons  
 Load rate at each facility  
 approximately 1,000tph

**Maumee**  
**Kuhlman Corporation**  
 1845 Indian Wood Circle  
 Maumee  
 Ohio 43537  
 USA

Contact: Mr Steve Smigelski  
 General Manager  
 T: + 1 419 897 6000  
 F: + 1 419 897 6061  
 E: ssmigelski@kuhlman-corp.com  
 W: www.kuhlman-corp.com  
 Location: Western Lake Erie Basin  
 Total uncovered Storage: 175,000 MT  
 Total covered Storage: 140,000 MT

**Metairie**  
**Kinder Morgan Terminals**  
 3500 N. Causeway Blvd  
 Suite 210  
 Metairie

LA  
 70002  
 USA  
 Contact: Mr John Vaughn  
 Senior Accountant  
 T: + 1 504 620 4639  
 F: + 1 504 620 4698  
 E: john\_vaughn@kindermorgan.com

**Metropolis**  
**AEP/Cook Coal Terminal**

PO Box 870 3316 N. US 45 Rd.  
 Metropolis  
 IL  
 62960  
 USA  
 Contact: Mr Robert Korte  
 Plant Manager  
 T: + 1 618 524 9345  
 F: + 1 618 524 1968  
 E: rskorte@aep.com  
 W: www.aep.com  
 Location: Metropolis, Illinois - Ohio  
 River 947.5

**Miami**  
**Port of Miami**

1015 N America Way  
 Miami  
 FLA  
 33132  
 USA  
 Contact: Mr Bill Johnson  
 Director  
 T: + 1 305 371 4859  
 F: + 1 305 347 4843  
 E: BJ4@miamidade.gov  
 W: www.co.miami-  
 dade.fl.us/portofmiami/

**Miami**  
**Panama Canal Authority (ACP)**

Marketing Division (MEMC)  
 P O Box 526725  
 Miami  
 FL  
 33152-6725  
 USA  
 Contact: Mrs Yoemy Waller  
 Acting Manager  
 T: + 1 507 272 3586  
 F: + 1 507 272 1622  
 E: cpmr-jc@pancanal.com  
 W: www.pancanal.com

**Milwaukee**  
**Continental Grain Elevator**

960 East Bay Street  
 Milwaukee  
 Wisconsin  
 53207  
 USA  
 T: + 1 414 482 1900  
 F: + 1 414 482 1733

**Milwaukee**  
**Milwaukee Bulk Terminals**

1900 S Harbour Drive  
 Milwaukee  
 WI  
 53207  
 USA  
 Contact: Mr Roy Cook  
 President  
 T: + 1 414 769 1901 x120  
 F: + 1 414 769 1144  
 E: mbtrmc@aol.com

**Milwaukee**  
**Port of Milwaukee**

2323 S Lincoln Memorial Drive  
 Milwaukee  
 WI 53207  
 USA  
 Contact: Mrs Paul Vornholt  
 Operations and Trade Director  
 T: + 1 414 286 8130  
 F: + 1 414 286 8506  
 E: paul.vornholt@milwaukee.gov  
 W: www.milwaukee.gov/port  
 Location: Located on the

Southwestern shore of Lake Michigan.  
 Equipment & Capacity: Cranes from  
 58,000 to 200,000 KG capacity  
 Bulk Berths: Terminals 1 and 4  
 dedicated to handling and storage of  
 dry bulk commodities.  
 Total uncovered Storage: 36 acres  
 Total covered Storage: Four storage  
 domes totaling 50,000 tons. Terminal  
 4 warehouse = 7,100 m2  
 Approximately 2.5 million tons of bulk  
 commodities are handled yearly, coal,  
 salt, cement, limestone, aggregates  
 and grain.

**Mobile**  
**Stevedoring Services Services of  
 America**

PO Box 2188  
 Mobile  
 AL 36652  
 USA  
 Contact: Mr Brian R. Frennea  
 T: + 1 334 438 4771  
 F: + 1 334 432 3180

**Mobile**  
**Cooper/T. Smith Stevedoring**



**Cooper/T. Smith**  
 118 North Royal Street  
 P O Box 1566  
 Mobile  
 Alabama  
 36602  
 USA  
 Contact: Mr John Murray  
 VP Operations — Cooper Marine and  
 Timberlands  
 T: +1 251 415 7360  
 F: +1 251 432 5045  
 E: John.MurrayIII@coopertsmith.com  
 W: www.coopertsmith.com  
 Location: Mobile, Alabama, USA  
 Equipment & Capacity: Two Floating  
 Crane-One Land Based Gantry  
 Floating Cranes Direct to Barge  
 Land Gantry Unloads/Loads  
 Woodchips  
 Bulk Berths: Three Berths - 40' Fresh  
 Water Arrival Draught  
 Pan-Max Type Ships  
 Total uncovered Storage: Two Storage  
 Areas:  
 1. Woodchips approx. 200,000tonnes  
 2. Storage Area for Ores/Pig  
 Iron/Scrap  
 600'x100' approx. 65,000tonnes  
 Rail Siding on Site & Certified Rail  
 Scale  
 We have two barge fleetling areas  
 capable of holding 250 barges with 14  
 Pushboats.

**Mobile**  
**Alabama State Port Authority**

PO Box 1588  
 Mobile  
 AL  
 36633  
 USA  
 Contact: Ms Judith Adams  
 Manager, Media Relations &  
 Economic Development  
 T: + 1 251 441 7003  
 F: + 1 334 441 7216  
 E: jadams@asdd.com  
 W: www.asdd.com

**Mobile**  
**Port of Mobile**

Alabama State Port Authority  
 PO Box 1588  
 Mobile  
 AL  
 36633 1588  
 USA  
 Contact: Ms Judith Adams  
 Manager, Media Relations

T: + 1 251 441 7003  
 F: + 1 334 441 7216  
 E: jadams@asdd.com  
 W: www.asdd.com  
 Location: Eastern Gulf of Mexico  
 Equipment & Capacity: 5 bulk cranes  
 750-15000 tph  
 5 bulk loaders 1000-3000 tph  
 40T paceco container crane  
 Gottwald 330 mobile harbor  
 Bulk Berths: 3 berths at 45' draft  
 1000' length  
 2 berths at 40' draft 750' length  
 Grain berth 40' draft 900' length  
 Cement berth 40' draft 750' length  
 25 general cargo berths 40' draft  
 Total uncovered Storage: 180,000  
 square meters general cargo  
 25,000 square meters bulk  
 Served by 5 class one railroads, 2  
 interstate highways, and a 1500 mile  
 inland waterway system

**Mobile**  
**FGDI LLC - ASPA Pier D Grain Elevator**  
 Mobile  
 Alabama  
 USA  
 Contact: Mr Lamar Willis  
 T: + 1 251 432 2211  
 E: lamarw@fcstone.com

**Mobile**  
**McDuffie Coal Terminal**  
 Alabama State Port Authority  
 PO Box 1588  
 Mobile  
 Alabama  
 36633  
 USA  
 Contact: Mr Melvin Barnett  
 Superintendent - Operations  
 T: + 1 251 441 7675  
 F: + 1 251 441 7216  
 E: mbarnett@asdd.com  
 W: www.asdd.com  
 Location: At mouth of Mobile River,  
 Mobile, Alabama, USA  
 22 miles from Gulf of Mexico  
 Equipment & Capacity: 6 Stackers-  
 Reclaimers, 3 off loaders, 2 ship  
 loaders, 22 million tonne capacity  
 Bulk Berths: 3 ship berths, 3 barge  
 loaders, 2 barge unloaders  
 Total uncovered Storage: 2.4 million  
 tonnes

**Monaca**  
**Colona Terminal Services**  
 1755 Pennsylvania Ave  
 Monaca  
 Pennsylvania  
 15061  
 USA  
 Contact: Mr Mark McClymonds  
 President  
 T: + 1 724 368 8040  
 F: + 1 724 368 0550  
 E: sales@colonatransfer.com  
 W: www.colonatransfer.com

**Monroe**  
**Tower Monroe Port Commission**  
 PO Box 585  
 Monroe  
 LA 48161  
 USA  
 Contact: Mr M McCray  
 Executive Director

**Morehead City**  
**North Carolina State Ports Authority/Morehead City**  
 113 Arendell St.  
 Morehead City  
 NC  
 28557  
 USA  
 Contact: Ms Shannon Moody  
 Director, Communications

T: + 1 910 343 6482  
 F: + 1 910 343 6225  
 E: shannon\_moody@ncports.com  
 W: www.ncports.com  
 Location: Port of Morehead situated  
 along the Newport River and Bogue  
 Sound  
 Equipment & Capacity: 2 gantry  
 cranes, 1 container crane, 3 mobile  
 cranes & cargo handling equipment  
 Bulk Berths: Dry bulk facility (used  
 mainly for phosphate) w/ 225,000 ton  
 capacity warehouse, conveyor system  
 & shiploader. Open storage dry bulk  
 facility which can outload 1,000 tons  
 per hr. w/ a two-million-ton annual  
 capacity.  
 Total uncovered Storage:  
 Approximately 14 acres of paved,  
 open storage.  
 Total covered Storage: 457,564 sq. ft.  
 of covered, sprinklered warehouse  
 storage.  
 Approximately 205 acres, w/ 150 (+/-)  
 acres suitable for port industrial  
 development on Radio Island (In  
 Morehead City)

**Mount Pleasant**  
**Strachan Shipping Co**  
 950 Houston Northcutt Boulevard  
 Watermark Plaza, Suite 200  
 Mount Pleasant  
 SC  
 29464  
 USA  
 Contact: Mr Bill Adams  
 T: + 1 843 856 1000  
 F: + 1 843 856 1013

**Mount Vernon**  
**Ports Of Indiana**  
 Southwind Maritime Centre  
 2751 Bluff Rd  
 Mount Vernon  
 IN  
 47620-8521  
 USA  
 Contact: Mr Phillip Wilzbacher  
 Port Director  
 T: + 1 812 833 2166  
 F: + 1 812 838 4377  
 E: pwilzbacher@portsfindiana.com  
 W: www.portsfindiana.com

**Myrtle Grove**  
**International Marine Terminals**  
 Myrtle Grove Terminal  
 18559 HWY 23  
 Myrtle Grove  
 LA  
 70083-9722  
 USA  
 Contact: Mr Adam Smith  
 General Manager  
 T: + 1 255 675 0308  
 F: + 1 255 675 8259  
 E: adam\_smith@kindermorgan.com  
 W: www.kindermorgan.com  
 Location: Myrtle Grove, Louisiana,  
 Milepost 57 Mississippi River, 30  
 miles south of New Orleans  
 Equipment & Capacity: Full Service  
 Marine Terminal which also operates  
 a fleeting service for up to 300  
 barges.  
 Bulk Berths: Three vessel berths and  
 one barge berth, including midstream  
 mooring buoys for direct transfer  
 cargoes.  
 Total uncovered Storage: 1,300,000  
 tons capacity  
 Total covered Storage: N/A  
 24/7 SHINC  
 A Kinder Morgan Operated Terminal

**New Haven**  
**New Haven Terminal**  
 Logistec Connecticut Inc  
 PO Box 9411  
 100 Waterfront Street  
 New Haven

CT  
 06534-0411  
 USA  
 Contact: Mr James Schine  
 Sales and Marketing Manager  
 T: + 1 203 468 0805  
 F: + 1 203 469 1318

**New Haven**  
**New Haven**  
 Gateway Terminal  
 400 Waterfront Street  
 New Haven  
 CT  
 06512  
 USA  
 Contact: Mr Tom Dubno  
 T: + 1 203 230 0778  
 F: + 1 203 437 7251

**New Orleans**  
**Cooper/T. Smith Stevedoring**



One Canal Place  
 365 Canal Street  
 Suite 1450  
 New Orleans  
 LA  
 70130  
 USA  
 Contact: Mr Eric Hansen  
 Vice President  
 T: + 1 504 569 2160  
 F: + 1 504 569 2188  
 E: eric.hansen@coopertsmith.com  
 W: www.coopertsmith.com

**New Orleans**  
**Port of New Orleans**  
 PO Box 60046  
 WTC Building  
 New Orleans  
 LA  
 70160  
 USA  
 Contact: Ms Sandi Byrd  
 T: + 1 504 528 3363  
 F: + 1 504 524 4156  
 E: info@portno.com  
 W: www.portno.com

**Newark**  
**Metal Management NE**  
 Foot Hawkins Street  
 Newark  
 New Jersey  
 NJ 07105  
 USA  
 Contact: Mr Mike Henderson Jr.  
 T: + 1 973 344 5575 / 4570  
 F: + 1 973 344 8155  
 E: mhendersonjr@mtlm.com  
 W: www.mtlm.com

**Newport News**  
**Kinder Morgan -Pier IX Terminal**  
 1900 Harbor Access Road  
 Newport News  
 Virginia  
 23607  
 USA  
 Contact: Mr Joseph De Matteo  
 Terminal Manager  
 T: + 1 757 928 1520  
 F: + 1 757 928 1560  
 E: Joseph\_DeMatteo@  
 kindermorgan.com  
 W: www.kindermorgan.com  
 Location: Mid Atlantic US; Newport  
 News VA  
 Equipment & Capacity: Coal and  
 Cement Handling Equipment; Export  
 and Import; 14m tpa capacity  
 Bulk Berths: Cape and Panamax  
 vessel berthing

**Newport News**  
**Dominion Terminal Associates**  
 PO Box 967-A  
 Newport News  
 Virginia  
 VA-23607  
 USA  
 Contact: Mr Rick Cole  
 President  
 T: + 1 757 245 2275  
 F: + 1 757 247 9729  
 E: rcole@dominionterminal.com  
 W: www.dominionterminal.com  
 Location: Port of Hampton Roads,  
 Virginia, USA  
 Equipment & Capacity: 1 tandem  
 rotary dumper, 2 stacker/reclaimers, 1  
 reclaimer, 1 finger pier, 1 shiploader  
 Capacity: 20 million tonnes (net)  
 annually.  
 Bulk Berths: Depth at mean low  
 water; 50 feet (15.24m)  
 Total uncovered Storage: 1.7 million  
 tonnes (net)  
 Inbound and Outbound sampling.  
 Blending, using two 4,000 tonne silos

**Norfolk**  
**Virginia International Terminals Inc**  
 PO Box 1367  
 Norfolk  
 VA 23501  
 USA  
 Contact: Mr Dave Rudloff  
 Dir. Engineering & Maintenance  
 T: + 1 757 440 7000  
 F: + 1 757 391 6223  
 W: www.vit.org

**Norfolk**  
**Virginia Port Authority**  
 Hampton Roads District  
 600 World Trade Centre  
 Norfolk  
 VA  
 23510 1696  
 USA  
 Contact: Ms Linda Ford  
 Director of Port Promotion  
 T: + 1 757 683 8000  
 F: + 1 757 683 8500  
 E: lford@portofvirginia.com  
 W: www.portofvirginia.com

**Norfolk**  
**Virginia Maritime Association**  
 236 East Plume Street  
 Norfolk  
 Virginia  
 23510  
 USA  
 Contact: Mr David  
 Administrator  
 T: + 1 757 622 2639  
 F: + 1 757 622 6302  
 E: vma@portofhamptonroads.com  
 W: www.portofhamptonroads.com

**North Charleston**  
**Cooper/T. Smith Stevedoring**



2030 Hayter Street  
 Building 58A Pier C  
 North Charleston  
 South Carolina  
 29405  
 USA  
 Contact: Mr Ronnie Turner  
 Vice President  
 T: + 1 843 744 1613  
 F: + 1 843 554 2975  
 E: ronnie.turner@coopertsmith.com  
 W: www.coopertsmith.com

**Oakland**  
**Port of Oakland**  
 PO Box 2064  
 Oakland  
 California  
 94604  
 USA  
 Contact: Mr Jerry Bridges  
 Chief Executive Officer  
 T: + 1 510 627 1100  
 F: + 1 510 839 5104  
 E: jbridges@portofakland.com  
 W: www.portofakland.com

**Oakville**  
**The Andersons**  
 500 Oakville Road  
 Oakville  
 IN  
 47367  
 USA  
 Contact: Ms Dawn Betancourt  
 General Manager  
 T: + 1 765 288 1951  
 F: + 1 765 288 4176  
 E: dawn\_betancourt@  
 andersonsinc.com  
 W: www.andersonsgrain.com

**Ogdensburg**  
**Ogdensburg Bridge & Port Authority**  
 1 Bridge Plaza  
 Ogdensburg  
 NY 13669  
 USA  
 Contact: Mr Wade Davis  
 Executive Director  
 T: + 1 315 393 4080  
 F: + 1 315 393 7068  
 E: wadavis@ogdensport.com  
 W: www.ogdensport.com

**Olympia**  
**Port of Olympia**  
 915 Washington Street NE  
 Olympia  
 WA 98501-6931  
 USA  
 Contact: Mr Jim Amador  
 Marine Terminal Director  
 T: + 1 360 528 8032  
 F: + 1 360 528 8093  
 E: JimA@portolympia.com  
 Location: Northwest Coast of United  
 States  
 Equipment & Capacity: 2-40 LT gantry  
 cranes, 15 forklifts (8,000-30,000 lb lift  
 capacity), container handling  
 equipment, log loaders, bucket  
 loaders  
 Bulk Berths: No bulk facilities.  
 Continuous berth face (berths 1-2-3)  
 equalling 1,750 feet  
 Total uncovered Storage: 57 acres  
 Total covered Storage: 2 acres  
 (76,000 square feet)

**Omaha**  
**Hansen-Mueller Company**  
 12231 Emmet Street  
 Omaha  
 NE  
 68164  
 USA  
 Contact: Mr John W. Orr  
 President  
 T: + 1 402 491 3385  
 F: + 1 402 491 0645  
 E: john@hmgrain.com  
 W: www.hmgrain.com  
 Location: Houston, TX  
 Equipment & Capacity: 1,500tph (3 x  
 21 m3 grabs + 2 x 10 m3 grabs + 3  
 vessel receiving hoppers)  
 Total covered Storage: 135,000  
 tonnes



**Oswego**

**Port of Oswego Authority**  
1 East Second Street  
Oswego  
NY  
13126  
USA  
Contact: Mr Jonathan Daniels  
Executive Director  
T: + 1 315 806 6405  
F: + 1 315 343 5498  
E: jdaniels@portoswego.com  
W: www.portoswego.com

**Owensboro**

**Kinder Morgan Terminals - Owensboro**  
Midwest Regional Office  
8500 West 68th Street  
Argo  
Illinois  
60501  
USA  
Contact: Mr William Patterson  
T: + 1 708 496 2891  
F: + 1 708 496 2540  
E: william\_patterson@kindermorgan.com  
W: www.kindermorgan.com

**Pago Pago**

**Port of Pago Pago**  
Department of Port Administration  
Government Of American Samoa  
PO Box 1539  
Pago Pago  
American Samoa  
96799  
USA  
Contact: Mr Matagi R Ma'ilo  
Mcmoore  
Port Director  
T: + 1 684 6334251  
F: + 1 684 6335281  
E: Matagi.Mcmoore@americansamoa.gov  
W: www.americansamoa.gov

**Palmer**

**Port MacKenzie, Matanuska-Susitna Borough**  
350 E. Dahlia Avenue  
Palmer  
Palmer  
AK  
99645  
USA  
Contact: Mr Marc Van Dongen  
Port Director  
T: + 1 907 746 7414  
F: + 1 907 745 1248  
E: mvandongen@matsugov.us  
W: www.portmackenzie.com

**Palmer**

**Port MacKenzie/Mat-Su Borough**  
350 East Dahlia Ave  
Palmer  
Alaska  
AK 99645  
USA  
T: + 1 907 745 1265  
F: + 1 907 745 1248  
E: portmackenzie@matsugov.us  
W: www.portmackenzie.com  
Location: NW of Anchorage Alaska - 2 miles  
Equipment & Capacity: 220 ton crane, 100 ton crane, 2,000tpd conveyor.  
Bulk Berths: 500ft barge dock @ - 20MLLW + 1200ft dock @ -60MLLW  
Total uncovered Storage: 14 sq miles  
Total covered Storage: 50,000 sq ft

**Palmetto**

**Port Manatee Forestry Terminal Inc**  
600 Regal Cruise Way  
Palmetto  
Florida  
34221

USA  
T: + 1 941 729 2424  
F: + 1 941 729 4343  
E: tamwww@gearbulk.com  
W: www.gearbulk.com

**Pascagoula**

**Port of Pascagoula**  
3033 Pascagoula Street  
Pascagoula  
MS  
39567 0070  
USA  
Contact: Ms Betty Ann White  
Manager, Government Affairs & Public Relations  
T: + 1 228 762 4041  
F: + 1 228 762 7476  
E: info@portofpascagoula.com  
W: www.portofpascagoula.com

**Pensacola**

**Port of Pensacola**  
PO Box 889  
700 S Barracks Street  
Pensacola  
FL  
32594-0889  
USA  
Contact: Ms Amy Miller  
Business Development Manager  
T: + 1 850 436 5070  
F: + 1 850 435 1879  
E: info@portofpensacola.com  
W: www.portofpensacola.com

**Philadelphia**

**Agway**  
3501 S C Columbus BLVD  
Pier 122 South  
Philadelphia  
PA  
19148  
USA  
Contact: Mr George Moore  
Foreman  
T: + 1 215 467 5861  
F: + 1 215 467 5874  
E: gmoore@growmark.com  
W: www.agway.com

**Philadelphia**

**Port of Philadelphia & Camden**  
3460 North Delaware Avenue  
2nd Floor  
Philadelphia  
PA 19134  
USA  
Contact: Mr Sean E Mahoney  
T: + 1 215 426 2441  
F: + 1 215 426 2447  
E: semahoney@philaport.com  
Location: North East on the Delaware River  
Equipment & Capacity: 9 Cranes  
Bulk Berths: 21 - 20 180' - 40'  
Total uncovered Storage: 1 132 922 sqm  
Total covered Storage: 355 353 sqm

**Piti**

**Port Authority of Guam**  
1026 Cabras Highway  
Suite 201  
Piti  
Guam  
96915  
USA  
Contact: Mr Joseph W. Duenas  
General Manager  
T: + 671 71 477 5931/35  
F: + 671 71 477 2689  
E: mphenderson@portofguam.com  
W: www.portofguam.com  
Location: Western Pacific  
Equipment & Capacity: 2 Ship-shore container gantries 1 Hitachi 40t, 1 Paceco 40t; Mobile cranes (truck-mounted) 1 Grove 150t; Yard gantries 2 Paceco 40t; Front end handlers/reachstackers 3 Hyster 40t,

5 Hyster 7.5t.  
Total uncovered Storage: Total Area 132,000sqm  
Total covered Storage: 3,300sqm

**Point Comfort**

**Port of Point Comfort/Port Lavaca**  
The Calhoun County Navigation District  
PO Box 397  
Point Comfort  
TX  
77978  
USA  
Contact: Mr Robert Van Borssum  
Port Director  
T: + 1 361 987 2813  
F: + 1 361 987 2189  
E: info@portofplpc.com

**Port Allen**

**Associated Terminals of Baton Rouge/Port Allen**  
1133 Mahaffey Road  
Port Allen  
Louisiana  
70876  
USA  
Contact: Mr Barry Hoth  
Vice President  
T: + 1 985 479 6358  
F: + 1 985 479 6360  
E: barry@associatedterminals.com  
W: www.associatedterminals.com  
Location: Lower Mississippi River  
Baton Rouge / Port Allen  
Equipment & Capacity: Dock cranes, conveyors, mobile equipment.  
Bulk Berths: 400-linear ft. of water frontage.  
Total uncovered Storage: 50,000 sq ft  
Total covered Storage: 30,000 sq ft  
Barge terminal just inside of the Port Allen locks. Facility meets a demand for cargo transfers between barge, storage and truck. The terminal is located on the Intracoastal Waterway in Port Allen, adjacent to the Port of Greater Baton Rouge.

**Port Allen**

**Port of Greater Baton Rouge**  
PO Box 380  
Port Allen  
LA  
70767  
USA  
Contact: Ms Karen St. Cyr  
T: + 1 225 342 1660  
F: + 1 225 342 1666  
E: stcyrk@portgbr.com  
W: www.portgbr.com

**Port of Los Angeles**

**Port of Los Angeles**  
338 West First Street  
Port Angeles  
WA 98362  
USA  
Contact: Mr Jeffrey Robb  
Executive Director  
T: + 1 360 457 1138  
F: + 1 360 452 3959  
E: jeffr@portofpa.com

**Port Arthur**

**Port of Port Arthur**  
PO Box 1428  
221 Houston Avenue  
Port Arthur  
TX  
77641  
USA  
Contact: Mr Floyd Gaspard  
Executive Port Director  
T: + 1 409 983 2011  
F: + 1 409 985 9312  
E: fgaspard@portofportarthur.com  
W: www.portofportarthur.com  
Location: On Gulf Intracoastal

Waterway - 19 miles Gulf of Mexico  
Equipment & Capacity: 75 ton level luffing gantry crane  
Bulk Berths: Dock length 946m; Road Dock 25m; 31m April; 40' water  
Total uncovered Storage: 69m  
Total covered Storage: 48m

**Port Arthur**

**Pabtex**  
209 Taft Ave. Extension  
PO Box 3635  
Port Arthur  
TX 77643  
USA  
Contact: Mr Greg Alder  
Terminal Manager  
T: + 1 409 962 8343  
F: + 1 409 962 8581  
E: gregalder@savageservices.com  
W: www.savageservices.com

**Port Hueneme**

**Port Hueneme Port Authority**  
PO Box 608  
Port Hueneme  
CA  
93044  
USA  
Contact: Mr Tony  
Executive Director  
T: + 1 805 488 3677  
F: + 1 805 488 2620  
E: wberg@portofhueneme.org

**Port Newark**

**Port Authority of NY & N Jersey**  
260 Kellogg Street  
3 Rd Floor  
Port Newark  
NY  
N.J. 07114  
USA  
Contact: Mr Robert Gaffney  
Director  
T: + 1 212 435 6001  
F: + 1 212 435 6030  
E: rgaffney@panynj.gov

**Port Royal**

**Port of Port Royal**  
South Carolina State Ports Authority  
601 Paris Avenue  
Port Royal  
SC  
29935-2431  
USA  
Contact: Mr A J Pesavento  
Terminal Manager  
T: + 1 803 524 9311  
F: + 1 803 524 5397  
E: scspainfo@scspa.com  
W: www.portofcharleston.com/proyal.htm

**Port Smith**

**Granite State Minerals**  
227 Market Street  
Port Smith  
New Hampshire  
03801  
USA  
Contact: Mr Paul Wentworth  
Marketing  
T: + 1 603 436 8505  
E: gsmsalt@aol.com  
Location: Mid-Atlantic- USA  
Equipment & Capacity:  
Conventional/Self un-loader Capacity  
Total uncovered Storage: 40 Acres  
Total covered Storage: 100,000 Sq Ft  
Dry Cargo Specialist

**Portland**

**International Terminals**  
PO Box 10047  
Portland  
Oregon  
97296-0047  
USA

Contact: Mr Chuck Ford  
Terminal Superintendent  
T: + 1 503 286 6923  
F: + 1 503 286 6960  
W: www.innterm.com

**Portland**

**Port of Portland**  
PO Box 3529  
Portland  
OR  
97208  
USA  
Contact: Mr Josh Thomas  
Media Relations Manager  
T: + 1 503 415 6054  
E: joshua.thomas@portofportland.com  
W: www.portofportland.com  
Location: The Port is located in Portland, Ore. at the confluence of the Columbia and Willamette Rivers.  
Equipment & Capacity: Terminal 2: 49 acres, bulk, breakbulk steel, heavy lift project cargo  
Terminal 4: 280 acres, autos, mineral and liquid bulks  
Terminal 5: 159 acres, mineral bulks, grain, manufacturing  
Terminal 6: 386 acres, containers, autos, breakbulk steel  
Bulk Berths: Terminal 2: 4 berths, draught 35-43', 50t and 40t cranes.  
Terminal 4: 7 berths, draught 35-43'  
Terminal 5: 2 berths, 1 industrial dock, draught 43'  
Terminal 6: 5 berths, 9 quayside gantry cranes, draught 43'  
Total covered Storage: 310,000 sq ft  
The Port's proximity to major highways, mainline railroads, and barging on the Columbia-Snake River system provide auto, bulk, breakbulk, liquid bulk and container shippers with cost-effective, reliable gateways to domestic and international markets.

**Portland**

**Columbia Grain Elevator**  
1300 SW 5th Avenue  
Suite 2929  
Portland  
Oregon  
97201  
USA  
Contact: Mr Amer Badawi  
VP  
T: + 1 503 224 8624  
F: + 1 503 241 0296  
E: web-info@columbiagrains.com  
W: www.columbiagrains.com

**Portsmouth**

**Sprague Energy**  
Two International Drive  
Suite 200  
Portsmouth  
New Hampshire  
03801  
USA  
Contact: Mr James Therriault  
VP Marketing  
T: + 1 603 430 5372  
F: + 1 603 766 7448  
E: jtherriault@spragueenergy.com  
W: www.spragueenergy.com  
Location: North East United States.  
Seasport Maine, Portland Maine, Portsmouth NH, Boston MA, Providence RI  
Twenty terminals

**Providence**

**Waterson Terminal Services.**  
35 Terminal Road  
Providence  
RI  
02905  
USA  
Contact: Mr Christopher Waterson  
General Manager  
T: + 1 401 461 9900  
F: + 1 401 461 6240



E: [chris@watersonllc.com](mailto:chris@watersonllc.com)  
 W: [www.watersonllc.com](http://www.watersonllc.com)  
 Location: Port of Providence, Rhode Island  
 Equipment & Capacity: Including 2x Barge Cranes with 140 ton stevedoring capacity and up to 1,500 TPH production rates.  
 Bulk Berths: 6 berths - 3500 linear feet of berthing. Please see website [www.watersonllc.com](http://www.watersonllc.com) for further details.  
 Total uncovered Storage: 20+ acres paved open lay down area.  
 Total covered Storage: Two warehouses totaling over 250,000 square feet of storage.  
 Situated on our 105 acres we offer over 3,500 feet of linear berthing capable of working 6 vessels at any one time.

**Pueblo**  
**Association of American Railroads**  
 PO Box 11130  
 Pueblo  
 CO  
 81001  
 USA  
 Contact: Ms Patricia Reilly  
 Vice President Communications  
 T: + 1 719 584 0749  
 F: + 1 719 585 1895  
 E: [preilly@aar.org](mailto:preilly@aar.org)  
 W: [www.aar.org](http://www.aar.org)

**Redwood City**  
**Port of Redwood City**  
 675 Seaport Blvd  
 Redwood City  
 CA  
 94063-2794

USA  
 Contact: Mr Steve Wright  
 Operations Manager  
 T: + 1 650 306 4150 ext 16  
 F: + 1 650 369 7636  
 E: [swright@redwoodcityport.com](mailto:swright@redwoodcityport.com)  
 Location: San Francisco Bay in Northern California - mid way between San Francisco and San Jose  
 Equipment & Capacity: Not applicable  
 - Private equipment  
 Bulk Berths: 5 Wharves with 34 draught

**Reserve**  
**Associated Terminals at Globalplex**  
 1342 Highway 44  
 Reserve  
 Louisiana  
 70084  
 USA  
 Contact: Mr Barry Hoth  
 Vice President  
 T: + 1 985 479 6358  
 F: + 1 985 479 6360  
 E: [barry@associatedterminals.com](mailto:barry@associatedterminals.com)  
 W: [www.associatedterminals.com](http://www.associatedterminals.com)  
 Location: Miles 136-141 Lower Mississippi River  
 Equipment & Capacity: Two dock-mounted gantry cranes, fleet of midstream stevedoring cranes as well as mobile cargo handling equipment  
 Bulk Berths: Five berths  
 Total uncovered Storage: 177,000 sq ft  
 Total covered Storage: 206,000 sq ft  
 Associated Terminals at Globalplex is one of the largest multiple purpose terminals on the Lower Mississippi River. Both bulk and breakbulk cargoes can be handled and stored in

multiple warehouses as well as in open storage. Rail and truck connections are available.

**Reserve**  
**Associated Terminals LLC**  
 1342 Highway 44  
 Reserve  
 Reserve  
 Louisiana  
 70084  
 USA  
 Contact: Mr Todd Fuller  
 Sr. Vice President  
 T: + 1 985 536 4520  
 F: + 1 985 536 4521  
 E: [todd@associatedterminals.com](mailto:todd@associatedterminals.com)  
 W: [www.associatedterminals.com](http://www.associatedterminals.com)  
 Location: Lower Mississippi River miles 56.8 to 141.5  
 Equipment & Capacity: Fleet of high-capacity floating cranes plus mobile equipment  
 Bulk Berths: 12 midstream berths  
 Total uncovered Storage: 427,000 sq ft  
 Total covered Storage: 536,000 sq ft  
 Associated Terminals is one of the largest midstream stevedoring companies on the Mississippi River, operating a fleet of twelve high capacity floating cranes. The company transloads cargo to and from vessels and barges at twelve mid-stream anchorage facilities on the lower Mississippi, as well as at additional dockside and on-site locations.

**Richmond**  
**Levin-Richmond Terminal Corporation (LRTC)**  
 402 Wright Avenue

Richmond  
 CA  
 94804  
 USA  
 Contact: Ms Barbara N. O'Neill  
 Director of Marketing - Bulk Operations  
 T: + 1 510 307 4009  
 F: + 1 510 236 0129  
 E: [barbara@levinterminal.com](mailto:barbara@levinterminal.com)  
 W: [www.levinterminal.com](http://www.levinterminal.com)  
 Location: West Coast of United States  
 Equipment & Capacity: Three 50-tonne diesel/hydraulic gantry cranes, One 25-tonne electric gantry crane.  
 New ship-loader rated at 1,000tph.  
 Bulk Berths: 2 Berths, A-Berth Depth is -12.5m, 182.9m length.  
 Berth, Depth is -9.1m, 243.8m length  
 Total uncovered Storage: 12.14 hectares  
 Total covered Storage: 15,850m covered storage being used for calcined petroleum coke.  
 Privately owned and operated diversified marine dry bulk facility.  
 Rail served by RPRC, which connects with the UPRR and BNSF.

**Richmond**  
**Port of Richmond**  
 1411 Harbour Way South  
 Richmond  
 California  
 CA 948404  
 USA  
 Contact: Mr Jim Matzorkis  
 Executive Director  
 T: + 1 510 215 4600  
 F: + 1 510 233 3105  
 E: [Richmondport@yahoo.com](mailto:Richmondport@yahoo.com)

**Saint Paul**  
**Port of St Paul**  
 Village Cove  
 St Paul Port Authority  
 PO Box 901  
 Saint Paul  
 Alaska  
 AK 99660  
 USA  
 Contact: Mr Larry Merculiett  
 City Manager  
 T: + 1 907 546 3140  
 F: + 1 907 546 3140  
 E: [info@sppa.com](mailto:info@sppa.com)

**Salt Lake City**  
**Savage Companies**  
 6340 South  
 3000 East Suite 600  
 Salt Lake City  
 Utah 84121  
 USA  
 Contact: Mr Nathan Savage  
 Director Marketing Coal & Petcoke  
 T: +1 801 944 6600  
 E: [nathans@savagecompanies.com](mailto:nathans@savagecompanies.com)

**San Diego**  
**Port of San Diego**  
 601 Switzer St  
 10th Avenue marine Terminal  
 San Diego  
 California  
 CA 92101-7811  
 USA  
 Contact: Ms Marguerite Elicone  
 Manager - Media Relations  
 T: + 1 619 686 6281  
 F: + 1 619 686 7288  
 E: [helpdesk@portofsandiego.org](mailto:helpdesk@portofsandiego.org)  
 W: [www.portofsandiego.com](http://www.portofsandiego.com)



**San Francisco**

**Port of San Francisco**  
 Pier 1, The Embarcadero  
 San Francisco  
 California  
 CA 94111-4263  
 USA  
 Contact: Mr Jim Maloney  
 Maritime Marketing Manager  
 T: + 1 415 274 0519  
 F: + 1 415 274 0412  
 E: Jim.Maloney@sfport.com  
 W: www.sfport.com  
 Location: West Coast of United States in Central California.  
 Equipment & Capacity: 6 gantry cranes  
 Bulk Berths: 6 deepwater berths  
 Total uncovered Storage: 120,000sqm

**San Pedro**

**Marine Terminals Corporation**  
 2001 John S. Gibson Blvd  
 San Pedro  
 CA  
 90731  
 USA  
 Contact: Mr Dan Wylie  
 Executive V P - General  
 Stevedoring Operations  
 T: + 1 510 4 208 578  
 F: + 1 510 5 479 352  
 E: donwy@mtcorp.com

**San Pedro**

**World Port LA (Port of Los Angeles)**  
 425 S.Palos  
 Verdes St  
 PO Box 151  
 San Pedro  
 CA 90733  
 USA  
 Contact: Ms Geraldine Knatz  
 Executive Director  
 T: + 1 310 732 7678  
 E: gknatz@portla.org  
 W: www.portoflosangeles.org

**San Pedro**

**Los Angeles Export Terminal**  
 160 W 6th Street  
 San Pedro  
 CA  
 90731  
 USA  
 Contact: Mr Jim Holland  
 T: + 1 562 436 5234  
 F: + 1 310 732 0107  
 E: jeholland@laxtinc.com

**San Pedro**

**Los Angeles Harbour Department**  
 425 South Palos Verdes Street  
 PO Box 151  
 San Pedro  
 CA  
 90733  
 USA  
 Contact: Mr Jim Mac Lellan  
 Director of Trade Services  
 T: + 1 310 732 3870  
 E: jmaclellan@portla.org

**San Pedro**

**Port of Los Angeles**  
 PO Box 151  
 San Pedro  
 California  
 90733-0151  
 USA  
 Contact: Ms Geraldine Knatz  
 Executive Director  
 T: + 1 310 7323456  
 F: + 1 310 8316936  
 E: kos-read@portla.org  
 W: www.portoflosangeles.org

**Sandusky**

**Sandusky Dock Corporation, Pier #3**  
 2705 West Monroe Street  
 PO Box #899  
 Sandusky  
 Ohio  
 44870

USA

Contact: Mr Jeff Smith  
 Superintendent  
 T: + 1 419 626 1215  
 F: + 1 419 483 1296  
 E: jeff.smith@nscorp.com  
 W: www.nscorp.com  
 Location: Pier #3 is nearly a mile in length and surrounded on three sides by the waters of Sandusky Bay, Ohio, USA  
 Equipment & Capacity: Ship-loader is capable of loading 9,000 tons per hour (cars and reclaim combined) with a 75' outboard reach

**Sandusky**

**CT Stevedoring**  
 2705 West Monroe Street  
 PO Box 2647  
 Sandusky  
 OH  
 44870  
 USA  
 Contact: Mr Ron House  
 General Manager  
 T: + 1 419 626 0801  
 F: + 1 419 626 8248  
 E: Ron.house@coopertsmith.com  
 W: www.coopertsmith.com

**Savannah**

**Georgia Ports Authority USA**  
 PO Box 2406  
 Savannah  
 Georgia  
 31402  
 USA  
 Contact: Mr Bill Jakubsen  
 Global Manager, Ro-Ro, Bulk & General Cargo  
 T: + 1 912 964 3891  
 F: + 1 912 964 3869  
 E: bjakubsen@gaports.com  
 W: www.gaports.com  
 Location: Georgia's deepwater ports of Savannah & Brunswick are geographically positioned on the U.S. East Coast, centrally located to

service the U.S. Southeast and Midwest.  
 Equipment & Capacity: The GPA maintains an extensive inventory of bulk handling equipment. Visit www.gaports.com for handling equipment details by terminal and port. Or, email bjakubsen@gaports.com.  
 Bulk Berths: Deepwater Berthing, All Terminals

Visit www.gaports.com for berthing details by terminal and port. Or, email bjakubsen@gaports.com.  
 Total uncovered Storage: Multiple Terminal Operations combining to provide over 75 ha of open storage.  
 Total covered Storage: Multiple Terminal Operations combining to provide 190,500 m2 of covered storage.  
 Port of Brunswick:  
 1. Colonel's Island Terminal Agri-bulk Facility owned & operated by GPA. Served by 2 class 1 railroads and immediate access to interstate.  
 2. Mayor's Point Terminal owned & operated by GPA. Focus on Forest Products.  
 3. East River Terminal in Brunswick, Georgia leased to Logistec, USA, Inc. They are building a wood pellet & wood chips export terminal.

**Seattle**

**Port of Seattle**  
 Pier 69  
 PO Box 1209  
 Seattle WA 98111  
 USA  
 Contact: Mr Mic Dinsmore  
 Executive Director  
 T: + 1 206 728 3000  
 F: + 1 206 728 3754  
 E: info@portseattle.org  
 W: www.portseattle.org

**Seattle**

**Stevedoring Services of America**  
 1131 SW Klickitat Way  
 Seattle  
 WA 98134  
 USA  
 Pay Roll  
 T: + 1 206 623 0304  
 F: + 1 206 623 0179  
 E: info@ssamarine.com  
 W: www.ssofa.com

**Seward**

**Port of Seward**  
 PO Box 167  
 Seward  
 Alaska AK 99664  
 USA  
 Contact: Mr Foster Singleton  
 Harbour Master  
 T: + 1 907 2243331  
 F: + 1 907 2247187  
 E: harbormaster@cityofseward.net

**Seward**

**Aurora Energy Services, LLC**  
 PO Box 1789  
 Seward  
 Alaska  
 99664  
 USA  
 Contact: Mr Victor Stoltz  
 General Foreman  
 T: + 1 907 224 3120  
 F: + 1 907 224 3921  
 E: vstoltz@usibelli.com  
 Location: Seward, Alaska, USA  
 Equipment & Capacity: Bucketwheel stacker reclaimer. Fixed position luffing & slewing shiploader. Load rate 700-1,000mtph.  
 Bulk Berths: Berth type: dolphin 900ft (berth face), 1,360ft (dolphin to dolphin)  
 Total uncovered Storage: Stockpile capacity 190,000mt  
 Year round ice free port



# Thank you

**...for proving us right. Advertising really does work.**

To find out how you can benefit from advertising in the world's only monthly dry bulk publication contact Jason Chinnock or Andrew Hucker-Brown on Tel: +44 (0)1483 542790  
Fax: +44 (0)1483 542799





**Skagway**

**Port of Skagway**  
City of Skagway  
PO Box 415  
Skagway  
Alaska AK 99840  
USA  
Contact: Mr Matt O'Boyle  
Harbour Master  
T: + 1 907 983 2628  
F: + 1 907 983 3087  
E: m.oboyle@skagway.org  
W: www.skagway.org

**St Louis**

**Bunge St Louis**  
PO Box 28500  
St Louis  
Missouri 63146  
USA  
Contact: Mr Roy Tomson  
T: + 1 314 292 2000  
E: bna.ebusiness@bunge.com  
W: www.bungenorthamerica.com

**St Louis**

**Cahokia Marine Services**  
1441 Hampton Avenue  
St Louis  
MO 63139  
USA  
Contact: Mr John Brereton  
Vice President Marketing  
T: + 1 314 647 7529  
F: + 1 314 647 8084  
E: jbrereton@slay.com

**Stamford**

**Oxbow Carbon Minerals**  
850 Canal Street  
Stamford  
Connecticut  
CT 06902  
USA  
Contact: Mr Gary J. Dielsi  
Vice President, Operations  
T: + 1 203 353 8888  
E: gary.dielsi@oxbow.com

**Stockton**

**Port of Stockton**  
2201 W. Washington Street  
PO Box 2089  
Stockton  
CA 95201  
USA  
Contact: Mr Bill Lewicki  
Director of Marketing  
T: + 1 209 946 0246  
F: + 1 209 466 5986  
E: blewicki@stocktonport.com  
W: www.portofstockton.com  
Location: 75 nautical miles (120 km)  
East from San Francisco Bay,  
California USA.  
Equipment & Capacity: Bulk export  
loading tower  
Bulk Berths: Average channel depth at  
10.6m  
Total uncovered Storage: 809  
hectares  
Total covered Storage: 715,000 sqm  
Serviced by both Union Pacific &  
BNSF RR

**Stockton**

**Metro Ports**  
World Trade Centre - Suite J  
2321 West Washington Street  
Stockton  
California 95203  
USA  
Contact: Mr Jon Allyn  
Director, Business Development  
T: + 1 510 522 9164  
F: + 1 310 816 6519  
E: info@metroports.com  
W: www.metroports.com  
Location: Port of Stockton

**Stockton**

**Sunshine Cement, Inc**  
Suite I  
2321 West Washington  
Stockton CA 95203  
USA  
Contact: Mr Randy Snyder  
VP / GM  
T: + 1 209 467 8325  
F: + 1 209 467 8065  
E: rsnyder@sunshinecement.com

**Stockton**

**Metropolitan Stevedore**  
2321 West Washington Street  
Suite J  
Stockton  
CA 95203  
USA  
Contact: Mr Thomas Mogan  
T: + 1 209 943 7252  
F: + 1 209 943 2656  
E: thomas.mogan@metsteco.com  
W: www.metsteco.com  
Location: California Delta  
Equipment & Capacity: 3,000 Mtp  
Bulk Berths: 11.3m Draught; 335m  
Berth (with Dolphins)  
Total uncovered Storage: 48,600 sqm  
(Other Port tenants)  
Total covered Storage: None  
Truck pit and rotary rail car tipper

**Superior**

**Superior Midwest Energy  
Terminal**  
PO Box 787  
Superior  
Wisconsin 54880  
USA  
Contact: Mr Fred Shusterich  
Vice President  
T: + 1 715 392 9807  
F: + 1 715 392 9137  
E: fshusterich@midwestenergy.com  
W: www.midwestenergy.com

**Superior**

**Cenex Harvest States**  
41 Dock St  
PO Box 518  
Superior  
WI 54880  
USA  
Contact: Mr Lance Helgeson  
Superintendent  
T: + 1 715 392 4734  
F: + 1 715 394 6926  
E: lance.helgeson@chsinc.com

**Superior**

**Peavey Company - Connor's  
Point Elevator**  
400 N Mail Street  
PO Box 937  
Superior WI 54880  
USA  
Contact: Mr Mick Sertich  
Superintendent  
T: + 1 715 392 9853  
F: + 1 715 392 9874  
E: msertich@conagrains.com

**Tacoma**

**Port of Tacoma Authority**  
Port of Tacoma  
PO Box 1837  
Tacoma WA 98401  
USA  
Contact: Mr Michael Wasem  
Communications & Media Relations  
Manager  
T: + 1 253 383 9436  
F: + 1 593 4534  
E: mwasem@portoftacoma.com  
W: www.portoftacoma.com

**Tacoma**

**Stevedoring Services of America**  
1980 Milwaukee Way

Tacoma  
WA 98421  
USA  
Contact: Mr Bob Luxa  
General Manager  
T: + 1 253 383 1763  
F: + 1 253 272 9570  
E: robert.luxa@ssamarine.com  
W: www.ssamarine.com

**Tallahassee**

**Florida Ports Council**  
315 Calhoun Street  
Suite 712  
Tallahassee  
FL 32301  
USA  
Contact: Mr Michael Rubin

**Tampa**

**Tampa Bay Stevedores Ltd**  
4801 Port Sutton Road  
Tampa  
Florida 33619  
USA  
Contact: Mr William Rudolph  
T: + 1 813 248 1971  
F: + 1 813 242 8011

**Tampa**

**Tampa Bay International  
Terminals Inc**  
1101 Channelside Drive  
Tampa  
Florida 33602  
USA  
Contact: Mr Robert (Bob) Callahan  
President, CEO  
T: + 1 813 241 1805  
F: + 1 813 241 1810  
E: bcallahan@tampaport.com  
W: www.tampaport.com

**Tampa**

**Tampa Port Authority**  
1101 Channelside Drive  
Tampa  
Florida 33602  
USA  
Contact: Mr Greg Lovelace  
Director of Marketing  
T: + 1 813 9055123  
F: + 1 813 9055109  
E: glovelace@tampaport.com  
W: www.tampaport.com  
Location: Central west coast of Florida  
(USA)  
Bulk Berths: max draft/berth  
dimension: max alongside/height of  
dock face/commodities handled:  
berth 1: 10.28m/198m/2.28m/scrap  
berth 2: 10.21m/198m/2.28m/liquid  
sulphur  
berth 3: 9.44m/168m/2.28m/cement  
berth 21: 5.8m/137m/2.4m  
berth 22: 10.4m/213m/3m/liquid  
sulphur  
berth 23: 10.5m/304m/3.65m/fertilizer  
berth 24:  
10.28m/217.9m/2.4m/chemical  
berth 24b: 4.3m/68.5m/1.9m/barge  
berth  
berth 26:  
9.6m/243.8m/3.35m/cement,  
aggregate  
berth 30: 13.1m/304.7m/2.6m/LPG  
berth 31:  
13.1m/304.7m/2.6m/cement,  
aggregate  
berth 204: 10.3m/280m/3m/fertilizer  
berth 205: 10.3m/176.7m/2.6m/juice  
berth 219: 11.4m/263.6m/3.35m/bulk  
berth 220: 12.4m/274m/3.35m/bulk  
berth 223: 10.2m/228.5m/2.4m/petro  
berth 224: 4.2m/54.8m/2.4m/bulk  
berth 226: 12.1m/268m/2.4m/petro  
berth 227: 12.1m/268m/2.4m/petro  
berth 256: 10.28m/230m/3.04m/dry  
bulk  
Total uncovered Storage: Contact  
Tampa Port Authority  
Total covered Storage: Contact Tampa

Port Authority. As Florida's largest  
port, Tampa handles nearly 50 M tpa,  
or half of the State of Florida's total  
seaborne cargo tonnage.

**Tampa**

**Kinder Morgan Terminals -  
Tampaplex Terminal**  
Southeast Regional Office  
4942 Port Sutton Road  
Tampa  
Florida  
33619  
USA  
Contact: Mr Roy Cook  
T: + 1 414 769 1901 ext-120  
F: + 1 414 769 1144  
E: roy\_cook@kindermorgan.com  
W: www.kindermorgan.com

**Tampa**

**United Maritime Group**  
601 S Harbour Island Boulevard  
Suite 230  
Tampa  
Florida 33602  
USA  
Contact: Mr Robin Hastings  
Vice President, Commercial  
T: + 1 813 209 4218  
F: + 1 813 273 0248  
E: sales@united-mar.com  
W: www.unitedmaritimegroup.com

**Texas City**

**Port of Texas City**  
Texas City Terminal Railway Co  
2425 Highway 146 N  
Texas City TX 77590  
USA  
Contact: Mr Dennis Jennings  
Director of Rail Operations  
T: + 1 409 945 4461(x23)  
F: + 1 409 945 8479  
E: info@railporttc.com  
W: www.railporttc.com

**Toledo**

**Midwest Terminals of Toledo  
International, Inc**  
3518 St. Lawrence Drive  
Toledo  
OH 43605  
USA  
Contact: Mr Jason Lowery  
Director of Business Development  
T: + 1 419 897 6868 ext 211  
F: + 1 419 691 7016  
E: jason.lowery@mwtti.com  
W: www.midwestterminals.com  
Location: Great Lakes (West end of  
Lake Erie)  
Equipment & Capacity: 6 shore  
cranes, ship loading conveyor  
Bulk Berths: 7 berths for a total of  
4,000 feet of dock frontage  
Total uncovered Storage: 100 acres  
Total covered Storage: 675,000  
square feet  
- Located at the mouth of the  
Maumee River with no air draught  
restrictions  
- Seaway Draught at all berths  
- 24 hour discharge service  
- Foreign Trade Zone  
- NYMEX approved warehouse space  
- Central location to several markets;  
40 percent of US households within  
10 hours  
- Truck and Rail served

**Toledo**

**Toledo-Lucas County Port  
Authority**  
One Maritime Plaza, 7th Floor  
Toledo  
Ohio  
43604  
USA  
Contact: Mr Joseph Cappel  
Director of Cargo Development

T: + 1 419 243 8251  
F: + 1 419 243 1835  
E: jcappel@toledoportauthority.org  
W: www.toledoseaport.org  
Location: Western Basin of Lake Erie  
at the mouth of the Maumee River  
Equipment & Capacity: General Cargo  
Facility (Midwest Terminals of Toledo  
International Inc.) has mobile harbor  
cranes and gantry cranes for bulk,  
project cargo, break-bulk handling.  
Ship loading conveyor system,  
hoppers and loaders for bulk material  
handling, on-dock rail, FTZ #8,  
warehousing, LME and NYMEX  
approved facility.  
Bulk Berths: General Cargo Facility  
(Midwest Terminals of Toledo  
International Inc.) has 1,250 m. of  
dock frontage with a Seaway draft of  
8.5 m. accommodates multiple loaded  
vessels with no air draft restrictions.  
Total uncovered Storage:  
1,133,120sqm  
Total covered Storage: 62,710sqm  
As the most cargo diverse and largest  
land mass Port on the Great Lakes,  
we have a terminal to match your  
cargo's handling requirements and  
your logistics needs. Please contact  
the Toledo-Lucas County Port  
Authority for additional information.

**Toledo**

**ADM Grain Company Ltd**  
1301 Miami St.  
Toledo  
Ohio 43605  
USA  
Contact: Mr Marty Wendt  
Regional Manager, Northern Ohio &  
Michigan  
T: + 1 419 324 0800  
F: + 1 419 324 0791  
E: marty\_wendt@admworld.com  
W: www.admworld.com  
Location: Lake Erie  
Equipment & Capacity: Load and  
discharge vessels  
Bulk Berths: 2 berths  
Total covered Storage: 9.2 million  
bushel  
CSXT 65 car train Loader. Can also  
unload covered hoppers. In addition,  
Inbound and Outbound trucks.

**Toledo**

**CSX Coal Dock**  
PO Box 8279  
Station A  
Toledo  
OH 43605  
USA  
Contact: Mr Paul LeCompte  
T: + 1 419 697 2353  
F: + 1 419 697 2320  
E: paul\_lecompte@csx.com  
W: www.csx.com

**Valdez**

**Port of Valdez**  
PO Box 307  
Valdez  
AK 99686  
USA  
Contact: Ms Diane Kinney  
Port Operations Supervisor  
T: + 1 907 835 4564  
F: + 1 907 835 4479  
E: portofvaldez@ci.valdez.ak.us  
W: www.ci.valdez.ak.us/port

**Vancouver**

**United Grain Corp  
Authority**  
900 Washington Street  
Suite 700  
Vancouver  
WA 98660  
USA  
Contact: Mr Augusto Bassanini  
VP Marketing  
T: + 1 360 816 1901



E: augusto@ugcprw.com  
W: www.ugcprw.com

**Vancouver**

**Port of Vancouver, USA**  
3103 Lower River Road  
Vancouver  
Washington 98660  
USA  
Contact: Mr Alastair Smith  
Sr. Director of Marketing and  
Operations  
T: + 1 360 693 3611  
F: + 1 360 735 1565  
E: info@portvanusa.com  
W: www.portvanusa.com

Location: Pacific Northwest on the  
Columbia River approximately 106  
miles from the Pacific Ocean.  
Equipment & Capacity: Liebherr 500S  
model Crane capable of 140 tonnes.  
P&H Crane/80 tonne capacity.  
Paceco Crane/ 53 tonne capacity  
w/spreader bar. Big Washington  
Crane/60 tonne capacity.  
Bulk Berths: Grain Elevator, Berth 1  
715' length w/dolphins  
Depth: 40' draught  
One mobile gantry spout served by  
conveyor system, one marine leg  
serving belt conveyor, silos. Total  
storage capacity about 5 million  
bushels.  
Dry bulk dock, Berth 7  
800' length  
Depth: 40' draft  
Telescoping conveyor loader  
Total uncovered Storage: 250 acres of  
open storage and marshalling yards  
Total covered Storage: 1,194,610 sq  
feet  
Accessible by river, road and rail, the  
Port of Vancouver, USA is well-  
equipped to handle all kinds of bulk  
cargo including mineral concentrates,  
bentonite clay, copper concentrates,  
bauxite, hydrate aluminum and ores.

**Vancouver**

**Vancouver-United Grain Elevator**  
1927 Elevator Way  
Vancouver  
Washington 98660  
USA  
Contact: Mr John Todd  
Manager  
T: + 1 360 693 1521  
F: + 1 360 694 1986  
E: jtodd@unitedharvest.com

**West Sacramento**

**Port of West Sacramento**  
1110 West Capitol Ave., FL3  
West Sacramento  
CA 95691-2717  
USA  
Contact: Mr Mike Luken  
Port Director  
T: + 1 916 371 8000  
F: + 1 916 372 4802  
E: mikel@cityofwestsacramento.org  
W: www.portofwestsac.com  
Location: Northern California, USA  
Equipment & Capacity: Transit sheds,  
dock hopper, export loader, bulk silos,  
on dock rail  
Bulk Berths: 8 berths, 600 feet in  
length  
Total uncovered Storage: 110,000sqm  
Total covered Storage: 66,387sqm  
Located in Central California via  
Sacramento Deep Water Channel.

**Whealersburg**

**Norfolk Southern - Wheelersburg  
Terminal**  
110 Franklin Road  
Roanoke  
Virginia 24042-0026  
USA  
Contact: Mr Randy Carter  
Director Industrial Coal Marketing &  
Transloading  
T: + 1 540 985 6795  
F: + 1 540 985 6398

E: Randy.Carter@nscorp.com  
W: www.nscorp.com

**Whittier**

**Whittier Port Authority  
Commission**  
PO Box 639  
Whittier  
Alaska 99693  
USA  
Contact: Ms Sue Miller  
Harbourmaster  
T: + 1 907 4722327  
F: + 1 907 4722472  
E: harbormaster@whittieralaska.gov  
W: www.whittieralaska.gov

**Wilmington (California)**

**Pasha Stevedoring & Terminals**



802 S Fries Ave  
Wilmington  
CA 90744  
USA  
Contact: Mr Fred Vandeventer  
VP, Contract Administration  
T: + 1 310 233 2000  
E: Fred.vandeventer@  
psterminals.com  
W: www.psterminals.com  
Location: Port of Los Angeles,  
California  
Berths 174-181  
Berths 153-155. Berths 207-209  
Equipment & Capacity: Forklifts 2T-  
45T For all cargoes, Top handlers, Side

Handlers, Maff Trailers, Bobcats &  
UTR's, 3-41mt hammerhead shore  
cranes  
Bulk Berths: 174-181~40 acres ~  
255,000 ft transit shed/storage, Water  
depth 35ft-45ft Rail access, 3300  
Linear feet berth space  
153-155~ 12 acres~180,000 ft  
covered storage, water depth 32-35  
ft, 1700 linear feet berth space  
207-209~86 acres~2180 linear feet  
berth space, 40-45 water depth,  
50,000 ft covered space  
With supporting omni-terminal  
operations, and diversified in  
international vessel loading, Pasha  
Stevedoring & Terminals excels in  
containers, breakbulk, steel, and  
heavy-lift cargo, providing  
personalized solutions for faster, safer  
shipments.

**Wilmington (Delaware)**

**Port of Wilmington,  
Delaware/Diamond State Port Co**  
Robert F. Senseny Administration  
Building  
1 Hausel Road  
Wilmington  
Delaware 19801-5852  
USA  
Contact: Mr Gene Bailey  
Executive Director  
T: + 1 302 472 7802  
F: + 1 302 472 7825  
E: gbailey@port.state.de.us  
W: www.portofwilmingtonde.com  
Location: Mid-Atlantic Port on the  
confluence of the Christina and  
Delaware Rivers, 65 miles from the  
Atlantic  
Equipment & Capacity: Two 50 ton  
capacity gantry container/bulk cranes  
Bulk Berths: 7 deep-water berths on  
the Christina and another berth on the  
Delaware River  
Total uncovered Storage: 33 acres on-  
dock, adjacent off-site storage and

distribution facilities available  
Total covered Storage: 250 sf of dry  
warehouse, adjacent off-site storage  
and distribution facilities available  
Specialized services:  
Product tarping, scale weighs, project  
management, engineering oversight,  
customized on-site processing, site  
facilitating, inventory management,  
material bagging / packaging,  
palletizing, material sizing, material  
blending, crushing / Screening, dust  
management / control, in-plant  
operations, rail access.

**Wilmington (N Carolina)**

**Metro Ports**  
348 Shipyard Blvd  
Wilmington NC 28412  
USA  
Contact: Mr Ted H Winter  
Vice President Business  
Development  
T: + 1 310 816 6545  
F: + 1 910 798 6188  
E: info@metports.com  
W: www.metports.com  
Location: Port of Wilmington

**Wilmington (N Carolina)**

**North Carolina State Ports  
Authority/ Wilmington**  
PO Box 9002  
2202 Burnett Road  
Wilmington  
NC 28402  
USA  
Contact: Ms Karen Fox  
Senior Director, Communications  
T: + 1 910 343 6491  
F: + 1 910 343 6225  
E: karen\_fox@ncports.com  
W: www.ncports.com  
Location: Located on the eastbank of  
the Cape Fear River  
Equipment & Capacity: 5 container  
cranes, 2 gantry cranes, 4 x 100ft  
gauge container cranes to be





# PST

Pasha Stevedoring & Terminals  
*Serving the steel industry for more than 20 years*

## PST Handles All Cargo All the Time

PST excels in handling steel, breakbulk, agricultural products, containers, and heavy-lift / project cargo, with supporting Omni-terminal operations and expert diversification in international vessel loading.

Holding the record for imports of coil and slab steel on the U.S. West Coast, PST also enlists traveling supercargoes to aid in loading in several international ports to ensure:

### Safe Stowage

- Maximum productivity at port of discharge
- Reduction in rate and damage
- Guaranteed on-time delivery

PST offers ancillary services such as reefer and chassis maintenance and repair, sensitive cargo warehousing, and logistics management.

*Pasha Stevedoring & Terminals  
Delivering personalized solutions for faster,  
safer, shipments around the world.*

*Port of Los Angeles • Port of Grays Harbor • Port of San Diego*



Pasha Stevedoring & Terminals  
(310) 835 – 9869

[www.psterminals.com](http://www.psterminals.com)

A wholly-owned subsidiary of The Pasha Group [www.pashagroup.com](http://www.pashagroup.com)



DC DRY CARGO  
Events presents

# BULK PORTS, TERMINALS & LOGISTICS 2013

Crowne Plaza Hotel  
Antwerp, Belgium  
12th-14th May 2013

Discuss, debate and join executives in the industry to tackle timely issues affecting the bulk ports sector.

## Programme Highlights

- ❖ Demand outlook for major dry bulk commodities, the rise and fall of the Euro: consequences for the dry bulk trade.
- ❖ Chinese Macroeconomic Outlook (Dry Bulk Divergence / Capesize Comeback).
- ❖ Challenges Facing Dry Bulk Terminals in Developing Regions.
- ❖ Raw materials trades - EU Policy and the impact of developing countries on future trade flows.
- ❖ Performance Analysis and Benchmarking for Bulk Operations.
- ❖ Emerging techniques for clean bulk handling in ports.
- ❖ Advances in Biomass handling at ports and terminals.
- ❖ Safe Fertilizer Handling at Ports and Terminals.
- ❖ New developments in environmentally friendly bulk handling using Continuous Ship Unloaders.
- ❖ Handling and transshipment solutions at bulk facilities to cope with the increased trade of wood pellets from the USA to Europe. From bigger vessels to silos and river barges, the discharge of river barges directly to the power stations and efficient handling solutions
- ❖ The redesign of bulk terminals (on the design of new or expansions of existing bulk terminals).
- ❖ Large scale fuel storage silos for coal, petcoke and wood pellets.
- ❖ Quebec City Terminal management case study: Developments in materials handling equipment installations and analysis of tonnage throughput within the context of the St Lawrence Seaway, the "Northern Corridor" trade route.

VISIT TWO EVENTS  
IN ONE WEEK!

After BULK PORTS, TERMINALS  
& LOGISTICS 2013,  
attend BREAKBULK  
EUROPE 14-16 May 2013

## Current Speakers

- Olle Östensson, President, Caromb Consulting*  
*Dr Corina Hebestreit, Director, Euromines*  
*Jeffrey Landsberg, Managing Director, Commodore Research & Consultancy*  
*David Peel, European Manager, RightShip Pty Ltd*  
*Prof.dr.ir. Gabriel Lodewijks, Head of Department-Marine and Transport Technology, Delft University of Technology*  
*Han Ozturk, Director, The Nectar Group*  
*David Trueman, Sales Director, DBIS*  
*Geoff Lemont, Vice President, St Lawrence Stevedoring*  
*Professor Mike Bradley, Director, The Wolfson Centre*  
*Mr Nicholas Dechamps, Managing Director, Vigan*  
*J.P.J. Ruijgrok, Managing Director, ESI Eurosilos BV*  
*Dr Holger Lieberwirth, Executive Vice President, TAKRAF GmbH*  
*Philip Waddell, International Sales Manager, Telestack*  
*Belan Velan, Managing Director, Scorpio Engineering Ltd*

## Media Partners



## Sponsors & Exhibitors



info@dc-int.com +27 (31) 583 4360 www.drycargoevents.com





delivered early 2007, 9 top-lift container handlers & various other cargo handling equipment.  
**Bulk Berths:** Open storage dry bulk facility which can outload over 800 tons per hr. w/ a 70,000-ton storage capacity. Covered dry bulk facility w/2.5 million cubic foot storage capacity & import conveyor system for grain & fertilizers which can handle 1,000 tons per hour.  
**Total uncovered Storage:** 100 acres of paved, open area; nearly 25 acres of semi-improved open storage area.  
**Total covered Storage:** Almost 1 million sq. ft. of covered, sprinklered storage.  
 Nearly 100 acres available for dev. North of present terminal. 94 acres available for development South of present terminal.

**Wilmington (California)**  
**Metropolitan Stevedore Company**  
 PO Box 547  
 Wilmington  
 California 90748  
 USA  
**Contact:** Mr Malcolm Pitt  
**T:** + 1 562 983 8425  
**F:** + 1 562 983 8520  
**E:** malcolm.pitt@metsteco.com  
**W:** www.metsteco.com  
**Location:** USA; South California, Port of Long Beach  
**Equipment & Capacity:** 2 travelling shiploaders. #1 - 2,500 MT/Hour, #2 - 5,000 MT/Hour  
**Bulk Berths:** 1548m - wharf.  
 5.24m Draught - Berth 212.  
 12.2m Draught - Berth 214  
**Total uncovered Storage:** 12,787 sqm  
**Total covered Storage:** 81,550 sqm (5 Port Tenants)  
 2 truck receiving pits, rotary rail car tipper, 2 rail bottom dumps.

**Wilmington (California)**  
**Metro Ports**  
 348 Shipyard Blvd  
 Wilmington  
 California NC 28412  
 USA  
**Contact:** Mr Rob Waterman  
 Vice President, Bulk Operations  
**T:** + 1 310 816 6557  
**F:** + 1 310 816 6519  
**E:** rob.waterman@metsteco.com  
**W:** www.metsteco.com  
**Location:** The Port of Long Beach, CA USA  
**Equipment & Capacity:** 2 shiploaders 5,000tph, 2,500tph capacity  
**Bulk Berths:** 2 berths (40', 50' draught) 1800' total wharf length, rotary and bottom dump rail car receiving  
**Total uncovered Storage:** 2 truck bottom dump pits  
 The operations staff at Metropolitan Stevedore Company has extensive experience in the handling of bulk cargoes. Metropolitan has a rich history of every kind and of every description. From grab buckets to highly automated, fully enclosed systems. We are the experts in our field.

**VENEZUELA**

**Estado**  
**Venteminales**  
 Apartado 234  
 Puerto Cabello  
 Estado  
 Carabobo  
 Venezuela  
**Contact:** Mr Johan Vermeulen  
**T:** + 58 242 769 647  
**F:** + 58 242 769 358  
**E:** agemar@agemar.com.ve

**Guidad Guayana**  
**Interalumina**  
 Zone Ind Mantanzas Apt 289  
 Estado Boliver  
 Guidad Guayana  
 Venezuela  
**Contact:** Mr L Mok  
 Gerente de Planta  
**T:** + 58 212 911 411  
**F:** + 58 212 911 411  
**E:** info@interalumina.com.ar

**Maracaibo**  
**BDV - Bulkguasare de Venezuela, SA**  
 (subsidiary of Coeclerici Logistics SPA)  
 Calle 77  
 Esq. Av 3C - Edif. Los Cerros  
 Piso 4, of 4B, Maracaibo  
 Zulia 4001  
 Venezuela  
**Contact:** Captain Guido Villani  
 Terminal Manager  
**T:** + 58 414 364 1331  
**F:** + 58 261 793 3576  
**E:** guidus2000@hotmail.com  
**W:** www.coeclerici.com  
**Location:** Lake of Maracaibo  
**Equipment & Capacity:** 8,000,000tpa  
**Bulk Berths:** Max Beam: 44m  
**Total covered Storage:** 60,000t  
**Commercial Contact:** Capt Giordano Scotto Coeclerici Logistics Spa-Piazza Diaz 7- 20123 Milan- email: newprojects@coeclerici.com

**Maracaibo**  
**Port Authority of Maracaibo**  
 Av 2 El Milagro  
 Modulo de Servicio  
 Puerto de Maracibo, Maracaibo  
 Venezuela  
**Contact:** Ms Teresa Reyes  
 Commercial Manager  
**T:** + 58 0261 7231721  
**F:** + 58 0261 7231272  
**E:** info@puertodemaracaibo.com

W: www.puertodemaracaibo.com

**Maracaibo**  
**Carbones del Guasare SA**  
 Centro De Operaciones Guasare  
 Av 9B Edif Banco  
 Industrial Piso 5  
 Maracaibo  
 Zulia 4001  
 Venezuela  
**Contact:** Mr Jose Rios  
 Marketing  
**T:** + 58 261 797 3831  
**F:** + 58 261 790 6664  
**E:** jrrios@guasare.com  
**W:** www.guasare.com

**Santa Cruz de Mara**  
**Santa Cruz Coal Terminal**  
 Carbones del Guasare SA  
 Terminal de Embarque  
 Edificio Banco Industrial, Piso 3  
 Santa Cruz de Mara  
 Edo Zulia 4002  
 Venezuela  
**Contact:** Ms Larissa Chacin  
 Marketing Manager  
**T:** + 58 261 790 6620  
**E:** lchacin@guasare.com  
**W:** www.guasare.com

**VIETNAM**

**Can Tho**  
**Can Tho Port**  
 148 Khanh Hoi Street  
 Ward 6, District 4  
 Ho Chi Minh City  
 Can Tho  
 Vietnam  
**Contact:** Mr Denny Chung  
**T:** + 84 39 411 767  
**F:** +84 39 411 523  
**E:** wss.vietnam@wilhelmsen.com  
**W:** www.wilhelmsen.com/

**Ho Chi Min city**  
**Ho Chi Minh Port Authority**  
 No 3 Nguyen  
 Tat Thanh Street  
 District 4  
 Ho Chi Min city  
 Vietnam  
**Contact:** Mr Tran Van On  
**T:** + 84 8 829 1825  
**F:** + 84 8 822 4168  
**E:** csg@hcm.vnn.vn

**Ngo Quyen District**  
**Haiphong Port Authority**  
 84 Tran Phu Street  
 Ngo Quyen District  
 Hai Phong  
 8431  
 Vietnam  
**Contact:** Mr Chang Mgyuen  
 Secretary to the General Director  
**T:** + 84 31385 9945  
**F:** + 84 31383 6943  
**E:** haiphongport@hn.vnn.vn  
**W:** www.haiphongport.com.vn  
**Location:** 20 52 N - 106 43'E, North East of Vietnam  
**Equipment & Capacity:** - 33 Multipurposed shore cranes: with lifting capacity from 5t to 42t  
 - 2 Floating cranes: with lifting capacity from 10 to 85t  
 - 6 QC: lifting capacity: 36t  
 - 12 RTG: lifting capacity: 40t  
 - 46 forklifts: from 3 to over 20t  
 - 25 Mobile crane: from 25 to 50t  
 - 4 Electronic weighing bridge: 80t  
 - 10 tug boats  
**Bulk Berths:** 11 berths with total lengths of 2 km  
**Total uncovered Storage:** 600,000sqm  
**Total covered Storage:** 40,000sqm



# PORTS & TERMINALS COMMODITIES HANDLED

**KEY:**

- CL = coal
- CC = coking coal
- PC = petcoke
- G-A = grain/agribulk
- AF = animal feed
- CM = cement
- CLK = clinker
- IO = iron ore
- BX = bauxite
- AL = alumina
- FR = fertilizer
- G-FGD = gypsum & FGD
- AG = aggregates
- SU = sugar
- SOY = soya products
- SODA = soda ash
- MIN = mineral concentrates
- CHEM = powdered chemicals
- BC = bagged cargoes
- FRS = forest products
- STL = steel products
- P&P = pulp & paper
- MB = minor bulks
- OTH = other commodities



COMMODITIES	CL	CC	PC	G-A	AF	CM	CLK	IO	BX	AL	FR	G-FGD	AG	SU	SOY	SODA	MIN	CHEM	BC	FRS	STL	P&P	MB	OTH	
<b>ALBANIA</b>																									
<b>Durres</b>																									
Port Authority of Durres				✓																					
<b>ALGERIA</b>																									
<b>Algiers</b>																									
Enterprise Portuaire d'Alger																									
<b>Annaba</b>																									
Enterprise Portuaire de Annaba	✓	✓		✓	✓	✓	✓	✓			✓			✓	✓	✓		✓	✓	✓	✓	✓	✓	✓	✓
<b>Bejaia</b>																									
Entreprise Portuaire de Bejaia																									
<b>Beni Saf</b>																									
Entreprise Portuaire de Beni Saf																									
<b>Ghazaouet</b>																									
Port Authority of Ghazaouet	✓			✓							✓														
<b>Mostaganem</b>																									
Enterprise Portuaire de Mostaganem																									
<b>Skikda</b>																									
Enterprise Portuaire de Skikda				✓																					
<b>ANGOLA</b>																									
<b>Lobito</b>																									
Porto do Lobito E.P.				✓	✓	✓	✓	✓	✓		✓		✓	✓	✓					✓	✓	✓	✓	✓	✓
<b>Luanda</b>																									
Porto de Luanda								✓																	
<b>Luanda</b>																									
Cabinda Gulf Oil Company Limited																									
<b>ARGENTINA</b>																									
<b>Bahia Blanca</b>																									
Puerto De Bahia Blanca				✓																					
<b>Bahia Blanca</b>																									
Bahia Blanca Port				✓																					
<b>Bahia Blanca</b>																									
Terminal Bahia Blanca, Piers 5/6, 7/8 and 9				✓																					
<b>Bahia Blanca</b>																									
Glencore/Toepfer Grain Elevator				✓																					



COMMODITIES	CL	CC	PC	G-A	AF	CM	CLK	IO	BX	AL	FR	G-FGD	AG	SU	SOY	SODA	MIN	CHEM	BC	FRS	STL	P&P	MB	OTH
<b>Bahia Blanca</b>																								
Oleaginoso Moreno																								
Hermanos SA				✓																				
<b>Barranqueras</b>																								
Puerto de Barranqueras						✓		✓																
<b>Barranqueras</b>																								
Puerto de Barranqueras																								
<b>Buenos Aires</b>																								
Quebracho Elevator				✓																				
<b>Buenos Aires</b>																								
TPA Terminals Portuarias																								
Argentinas																								
<b>Buenos Aires</b>																								
Terminal Buenos Aires SA				✓																				
<b>Buenos Aires</b>																								
SA Berth				✓																				
<b>Buenos Aires</b>																								
Del Bene SA				✓																				
<b>Buenos Aires</b>																								
ACA Berth - San Lorenzo Port				✓																				
<b>Buenos Aires</b>																								
ACA Berth Nbr 3 - Quequen Port				✓																				
<b>Buenos Aires</b>																								
Terminal EMCYM				✓																				
<b>Buenos Aires</b>																								
Terminal 4				✓																				
<b>Buenos Aires</b>																								
Terminals Río de la Plata																								
<b>Diamante</b>																								
Port of Diamante				✓																				
<b>Ensenada</b>																								
La Plata Port Administration								✓															✓	✓
<b>Puerto General San Martin</b>																								
Terminal 6 S.A.				✓												✓								
<b>Quequen</b>																								
Puerto Quequen				✓																				
<b>Quequen</b>																								
Consortio de Gestion del																								
Puerto de Quequen				✓							✓					✓								✓
<b>Rosario</b>																								
Puerto Rosario																								
<b>Rosario</b>																								
Neptun SA - Operadores																								
Maritimos				✓																				
<b>Rosario</b>																								
Puerto Rosario																								
<b>San Lorenzo</b>																								
Vicentin Elevator				✓																				
<b>San Lorenzo</b>																								
Port of San Lorenzo				✓																				
<b>San Pedro</b>																								
Terminal Puerto San Pedro S.A.				✓							✓										✓		✓	✓
<b>San Pedro</b>																								
Puerto de San Pedro																								
<b>Santa Fe</b>																								
Administration Puerto Santa Fe				✓																			✓	✓
<b>Villa Constitucion</b>																								
Villa Constitucion Port Authority				✓				✓														✓	✓	✓
<b>Zarate</b>																								
Zarate Port SA											✓						✓			✓	✓	✓		
<b>ARUBA</b>																								
<b>Oranjestad</b>																								
Port of Oranjestad																✓								
<b>San Nicolas</b>																								
San Nicolas Bay Port				✓							✓													
<b>AUSTRALIA</b>																								
<b>Adelaide</b>																								
Port Giles Grain Terminal				✓																				
<b>Adelaide</b>																								
Port Pirie Grain Terminal Berth 2				✓																				
<b>Adelaide</b>																								
Thevenard Grain Terminal				✓																				
<b>Adelaide</b>																								
Flinders Ports Pty. Ltd																								

# COMMODITIES HANDLED

COMMODITIES	CL	CC	PC	G-A	AF	CM	CLK	IO	BX	AL	FR	G-FGD	AG	SU	SOY	SODA	MIN	CHEM	BC	FRS	STL	P&P	MB	OTH
<b>Adelaide</b>																								
Wallaroo Grain Terminal Berth 2				✓																				
<b>Adelaide</b>																								
SACBH Ardrossan Grain Terminal				✓																				
<b>Adelaide</b>																								
ABB Grain				✓																				
<b>Adelaide</b>																								
Flinders Ports Pty Ltd						✓																		✓
<b>Adelaide</b>																								
ABB Grain				✓																				
<b>Albany</b>																								
Port of Albany				✓							✓													
<b>Brisbane</b>																								
Port Weipa								✓															✓	
<b>Brisbane</b>																								
Ports Corporation Queensland (PCQ)	✓																							
<b>Brisbane</b>																								
North Queensland Bulk Ports Corporation Limited	✓	✓		✓				✓			✓			✓										✓
<b>Brisbane</b>																								
Cape Flattery																							✓	
<b>Brisbane</b>																								
Queensland Bulk Handling Coal Export Terminal	✓																							
<b>Bunbury</b>																								
Bunbury Port Authority								✓			✓												✓	
<b>Burnie</b>																								
Tasmanian Ports																								
<b>Cairns</b>																								
Ports North											✓			✓									✓	✓
<b>Carrington</b>																								
Port Waratah Coal Services Limited	✓																							
<b>Carrington</b>																								
GrainCorp Operations Ltd				✓																				
<b>Carrington</b>																								
Newcastle Agri Terminal				✓																				
<b>Dampier</b>																								
Dampier Port Authority								✓															✓	
<b>Darwin</b>																								
P&O Automotive and General Stevedoring	✓			✓	✓	✓	✓	✓			✓	✓		✓	✓	✓	✓	✓	✓	✓	✓	✓	✓	✓
<b>Darwin</b>																								
Darwin Port Corporation								✓																✓
<b>East Davenport</b>																								
P & O Automotive & General Stevedoring								✓																
<b>East Perth</b>																								
James Point Pty Ltd (JPPL)																								
<b>Esperance</b>																								
Esperance Ports - Sean & Land				✓				✓			✓						✓							✓
<b>Fremantle</b>																								
Fremantle Ports	✓			✓							✓												✓	
<b>Geelong</b>																								
Geelong Port			✓	✓				✓	✓	✓	✓	✓	✓	✓	✓		✓			✓	✓	✓	✓	
<b>Geraldton</b>																								
Geraldton Port Authority				✓				✓			✓						✓						✓	
<b>Gladstone</b>																								
Gladstone Ports Corporation	✓																							
<b>Gladstone</b>																								
Gladstone Ports Corporation	✓		✓	✓		✓		✓			✓													
<b>Gladstone</b>																								
Barney Point Coal Terminal	✓																							
<b>Gladstone</b>																								
Central Queensland Ports Authority											✓												✓	
<b>Gladstone</b>																								
Grainco Queensland Gladstone Terminal Berth 2				✓																				
<b>Hastings</b>																								
Port of Hastings Authority																						✓		✓
<b>Kooragang Island</b>																								
PWCS Kooragang Terminal	✓																							



COMMODITIES	CL	CC	PC	G-A	AF	CM	CLK	IO	BX	AL	FR	G-FGD	AG	SU	SOY	SODA	MIN	CHEM	BC	FRS	STL	P&P	MB	OTH
<b>Kooragang Island</b>																								
Newcastle Coal Infrastructure Group	✓																							
<b>Mackay</b>																								
Dalrymple Bay Coal Terminal (DBCT)	✓																							
<b>Mackay</b>																								
Hay Point Coal Terminal (HPCT)	✓																							
<b>Melbourne</b>																								
P & O Ports - Geelong				✓							✓													
<b>Melbourne</b>																								
Port of Melbourne Corporation						✓					✓			✓										
<b>Newcastle</b>																								
Newcastle Port Corporation	✓	✓	✓	✓	✓	✓			✓	✓	✓				✓	✓	✓	✓	✓	✓	✓	✓	✓	✓
<b>North Sydney</b>																								
Patrick Stevedores Operations Pty Limited				✓	✓						✓								✓	✓	✓	✓	✓	✓
<b>Perth</b>																								
CBH Albany Grain Terminal				✓																				
<b>Perth</b>																								
CBH Esperance Grain Terminal				✓																				
<b>Perth</b>																								
CBH Kwinana Grain Terminal				✓																				
<b>Perth</b>																								
CBH Geraldton Grain Terminal				✓																				
<b>Pinekenba</b>																								
Grainco Queensland Pinekenba Terminal				✓																				
<b>Port Adelaide</b>																								
Flinders Ports - Port Pirie	✓			✓				✓			✓											✓		✓
<b>Port Hedland</b>																								
Port Hedland Port Authority								✓															✓	
<b>Port Kembla</b>																								
Port Kembla Port Corporation	✓	✓		✓		✓	✓	✓	✓		✓	✓	✓	✓		✓	✓			✓	✓	✓	✓	✓
<b>Port Lincoln</b>																								
Flinders Ports P/L				✓							✓													
<b>Port of Brisbane</b>																								
Port of Brisbane Pty Ltd	✓			✓		✓	✓				✓	✓	✓	✓	✓	✓				✓	✓		✓	
<b>Portland</b>																								
Vicgrain Portland Terminal				✓																	✓			
<b>Portland</b>																								
Port of Portland Pty Ltd				✓	✓				✓	✓	✓						✓			✓		✓		✓
<b>Seventeen Mile Rocks</b>																								
Mitchell Ports																								
<b>Sydney</b>																								
Patrick the Australian Stevedore												✓										✓		✓
<b>Sydney</b>																								
D P World - P & O Ports				✓																				
<b>Tasmania</b>																								
Tasmanian Ports Corporation (Tasports)																								
<b>Thevenard</b>																								
Thevenard Port												✓												
<b>Toowoomba</b>																								
Grainco Queensland Fisherman Island Terminal				✓																				
<b>Townsville</b>																								
Port of Townsville Limited		✓		✓	✓	✓		✓			✓			✓								✓	✓	✓
<b>Walsh Bay</b>																								
Sydney Ports Corporation				✓		✓		✓			✓			✓								✓		
<b>West Perth</b>																								
Co-Operative Bulk Handling Ltd				✓																				
<b>Wollongong</b>																								
Port Kembla Grain Terminal -				✓																				
<b>Wollongong</b>																								
Port Kembla Coal Terminal Limited	✓		✓										✓											
<b>Wyndham</b>																								
CGL Wyndham Port																		✓		✓				
<b>Wynnum Central</b>																								
Patrick Stevedores																							✓	✓
<b>AZORES</b>																								
<b>Ponta Delgada</b>																								
Port Authority of Ponta Delgada				✓																				

# COMMODITIES HANDLED

COMMODITIES	CL	CC	PC	G-A	AF	CM	CLK	IO	BX	AL	FR	G-FGD	AG	SU	SOY	SODA	MIN	CHEM	BC	FRS	STL	P&P	MB	OTH
<b>BAHAMAS</b>																								
<b>Freeport</b>																								
Grand Bahama Port Authority																								
<b>BAHRAIN</b>																								
<b>Manama</b>																								
Mina Salman Port Authority																								
<b>BANGLADESH</b>																								
<b>Chittagong</b>																								
Chittagong Port Authority																								
<b>BARBADOS</b>																								
<b>Bridgetown</b>																								
Barbados Port Authority																								
<b>BELGIUM</b>																								
<b>Antwerpen</b>																								
Boortmalt Group																								
<b>Antwerpen</b>																								
SCR - Sibelco																								
<b>Antwerpen</b>																								
Noord Natie Terminal																								
<b>Antwerpen</b>																								
Euroports Belgium NV																								
<b>Antwerpen</b>																								
Antwerp Port Authority																								
<b>Antwerpen</b>																								
Antwerp Bulk Terminal (ABT)																								
<b>Antwerpen</b>																								
Alfaport Antwerpen																								
<b>Brugge</b>																								
Firma Germain D'Hoore - Ostende																								
<b>Gent</b>																								
Reyniers Havenbedryf NV																								
<b>Gent</b>																								
Mekol																								
<b>Gent</b>																								
Arcelor Steel Belgium NV																								
<b>Gent</b>																								
Ensagent NV																								
<b>Gent</b>																								
Ghent Coal Terminal NV - GCT																								
<b>Gent</b>																								
Ghent Port Company ampc																								
<b>Gent</b>																								
Stukwerkers Havenbedrijf NV																								
<b>Gent</b>																								
Euro-Silo NV																								
<b>Gent</b>																								
Manuport NV																								
<b>Gent</b>																								
Ghent Transport & Storage																								
<b>Kalloy</b>																								
Belgian Scrap Terminal NV																								
<b>Kalloy</b>																								
Metal Terminals International (MTI)																								
<b>Liege</b>																								
Liege Port Authority																								
<b>Liege</b>																								
Terval S.A.																								
<b>Oostende</b>																								
Ter Polder																								
<b>Puurs</b>																								
SMEG Belgium NV																								
<b>Roeselare</b>																								
Van Eeckhout																								
Vervoermaatschappij																								
<b>Seraing</b>																								
CTB Logistics SA																								
<b>Zeebrugge</b>																								
Zeebrugse Behandelings Maatschappij																								



COMMODITIES	CL	CC	PC	G-A	AF	CM	CLK	IO	BX	AL	FR	G-FGD	AG	SU	SOY	SODA	MIN	CHEM	BC	FRS	STL	P&P	MB	OTH	
<b>Zeebrugge</b>																									
Devreese & Simon NV																									
<b>BENIN</b>																									
<b>Cotonou</b>																									
Port Autonome de Cotonou																									
<b>BERMUDA</b>																									
<b>Hamilton</b>																									
Department Marine & Port Services							✓																		
<b>BRAZIL</b>																									
<b>Anchieta</b>																									
Port Authority of Ponta Uba								✓																	
<b>Angra dos Reis</b>																									
Port of Angra dos Reis				✓																					
<b>Aracruz</b>																									
Portocel-Terminal Especializado de Barra do Riacho																					✓		✓		
<b>Baia de Aratu</b>																									
Port of Aratu									✓			✓							✓						
<b>Belem</b>																									
Port Authority of Para				✓																					
<b>Belem</b>																									
Port of Belem				✓																					
<b>Fortaleza</b>																									
Port of Fortaleza				✓																					
<b>Ilheus</b>																									
Port of Ilheus				✓																					
<b>Imbituba</b>																									
Imbituba Port Authority	✓		✓									✓													
<b>Itaguaí</b>																									
CSN – Terminal de Carvão e Minério TECAR	✓																								
<b>Jaragua</b>																									
Port of Maceio				✓										✓											
<b>Manaus</b>																									
Port of Manaus				✓																					
<b>Município de Oriximiná</b>																									
Trombetas Port									✓																
<b>Natal</b>																									
Natal Port Authority				✓																					
<b>Niteroi</b>																									
Port of Noiteroi				✓																					
<b>Para State</b>																									
Port Authority of Vila Do Conde									✓																
<b>Paranagua</b>																									
Port Silo/Socopar Berths 1/2; Gransol Berth 3				✓																					
<b>Paranagua</b>																									
Paranagua Port Authority				✓																					
<b>Paranagua</b>																									
PFT-Paranaguá Forestry Terminals																					✓				
<b>Pelotas</b>																									
Port of Pelotas				✓																					
<b>Porto Alegre</b>																									
Port of Porto Alegre	✓			✓																					
<b>Recife</b>																									
Port of Recife				✓										✓											
<b>Rio de Janeiro</b>																									
Rio de Janeiro Port Authority	✓							✓	✓		✓														
<b>Rio de Janeiro</b>																									
Cia Docas Do Rio de Janeiro																									
<b>Rio de Janeiro</b>																									
Petroleo Brasileiro SA-Petrobras				✓																					
<b>Rio de Janeiro</b>																									
Port of Forno				✓																				✓	
<b>Rio de Janeiro</b>																									
Companhia Portuaria Baia de Sepetiba																									
<b>Rio Grande</b>																									
Bianchini Terminal				✓																					

# COMMODITIES HANDLED

COMMODITIES	CL	CC	PC	G-A	AF	CM	CLK	IO	BX	AL	FR	G-FGD	AG	SU	SOY	SODA	MIN	CHEM	BC	FRS	STL	P&P	MB	OTH
<b>Rio Grande</b>																								
Port of Rio Grande				✓				✓			✓													
<b>Salvador</b>																								
Port Authority of Salvador																								
<b>Santos</b>																								
Port of Santos	✓	✓						✓			✓			✓	✓									
<b>Santos</b>																								
Companhia Docas do Estado de São Paulo - CODESP	✓			✓	✓						✓			✓	✓	✓				✓	✓	✓		
<b>Santos</b>																								
Tropical Agencia Maritima Ltda.	✓	✓	✓	✓	✓		✓		✓		✓	✓	✓				✓	✓					✓	
<b>Sao Francisco do Sul</b>																								
Sao Francisco do Sul Port Authority	✓			✓				✓			✓										✓	✓		✓
<b>Sao Luis</b>																								
Port of Ponta da Madeira				✓				✓	✓															
<b>Sao Paulo</b>																								
Coinbra - Grain				✓																				
<b>Vitoria</b>																								
Capuaba Quay Grain																								
Terminal/Port of Vitoria				✓																				
<b>Vitoria</b>																								
Port Authority of Espirito Santo				✓				✓													✓	✓		
<b>Vitoria</b>																								
Tubarao Port Authority	✓		✓					✓															✓	
<b>BULGARIA</b>																								
<b>Bourgas</b>																								
Bulk Terminal 2A	✓																							
<b>Bourgas</b>																								
Port of Bourgas JSC	✓	✓	✓	✓	✓		✓	✓	✓		✓			✓	✓		✓				✓	✓		✓
<b>CAMBODIA</b>																								
<b>Sihanoukville</b>																								
Sihanoukville Autonomous Port (PAS)				✓																				
<b>CAMEROON</b>																								
<b>Douala</b>																								
Delmas Cameroon (CMA-CGM Group)				✓					✓												✓			
<b>Douala</b>																								
Cameroon National Ports Authority																								
<b>CANADA</b>																								
<b>Becancour</b>																								
Becancour Waterfront Industrial Park	✓		✓	✓					✓	✓	✓									✓		✓		✓
<b>Belledune</b>																								
Port of Belledune	✓	✓	✓								✓	✓	✓				✓		✓	✓		✓		✓
<b>Burlington</b>																								
Lloyd's Register																								
<b>Churchill</b>																								
Hudson Bay Port Terminal				✓																				
<b>Contrecoeur</b>																								
Logistec	✓						✓	✓	✓		✓		✓				✓		✓					✓
<b>Contrecoeur</b>																								
Terminal Maritime																								
Contrecoeur Inc	✓	✓				✓	✓	✓	✓		✓						✓							
<b>Corner Brook</b>																								
Corner Brook Port Corporation						✓																		
<b>Dartmouth</b>																								
Port Authority of Georgetown																						✓		
<b>Delta</b>																								
Westshore Terminals	✓	✓	✓																					
<b>Goderich</b>																								
Southpier Terminals Limited				✓							✓													
<b>Guelph</b>																								
Parrish & Heimbecker				✓	✓								✓		✓									
<b>Halifax</b>																								
Halifax Port Corporation				✓																			✓	
<b>Halifax</b>																								
Halifax Grain Elevator Ltd				✓																				
<b>Hamilton</b>																								
Hamilton Port Authority	✓		✓	✓			✓	✓			✓	✓	✓		✓					✓	✓		✓	✓



COMMODITIES	CL	CC	PC	G-A	AF	CM	CLK	IO	BX	AL	FR	G-FGD	AG	SU	SOY	SODA	MIN	CHEM	BC	FRS	STL	P&P	MB	OTH
<b>Hamilton</b>																								
Richardson International Ltd				✓																				
<b>La Baie</b>																								
Alcan Primary Metal Group									✓															
<b>Milford</b>																								
National Gypsum Co Ltd												✓												
<b>Montreal</b>																								
Logistec Corporation	✓				✓	✓	✓	✓	✓		✓	✓	✓	✓							✓	✓		✓
<b>Montreal</b>																								
Les Silos Port-Cartier																								
<b>Montreal</b>																								
Montreal Port Authority (Grain Terminal)				✓																				
<b>Montreal</b>																								
Port of Montreal Authority				✓	✓			✓			✓	✓	✓	✓	✓		✓		✓	✓	✓	✓	✓	✓
<b>Montreal</b>																								
Strudes Inc	✓		✓	✓		✓		✓	✓		✓											✓	✓	
<b>Montreal</b>																								
Federal Marine Terminals	✓					✓			✓					✓										✓
<b>North Vancouver</b>																								
Richardson International Ltd				✓																				
<b>North Vancouver</b>																								
Neptune Bulk Terminals (Canada) Ltd	✓										✓													
<b>North Vancouver</b>																								
Kinder Morgan Canada Terminals Limited Partnership				✓	✓						✓						✓		✓				✓	✓
<b>Nova Scotia</b>																								
Port of Hantsport												✓												
<b>Oshawa</b>																								
Oshawa Harbour Commission																								
<b>Ottawa</b>																								
Transport Canada									✓															
<b>Ottawa</b>																								
Portha Inc																								
<b>Owen Sound</b>																								
Great Lakes Elevator				✓																				
<b>Parrsboro</b>																								
Port Authority of Parrsboro																								
<b>Port Cartier</b>																								
Les Silos Port Cartier				✓																				
<b>Port Colborne</b>																								
Port Colborne Grain Terminal				✓																				
<b>Prescott</b>																								
Port of Prescott				✓																				
<b>Prince Rupert</b>																								
Prince Rupert, Ridley Island Grain Elevator				✓																				
<b>Prince Rupert</b>																								
Prince Rupert Port Authority	✓	✓		✓																	✓	✓	✓	✓
<b>Prince Rupert</b>																								
Ridley Terminals Inc	✓	✓	✓					✓			✓										✓			
<b>Quebec City</b>																								
Bunge of Canada Elevator				✓																				
<b>Quebec City</b>																								
Sillery Distribution Center Inc.				✓																				
<b>Quebec City</b>																								
Quebec Port Authority	✓	✓		✓	✓	✓	✓	✓	✓	✓	✓	✓		✓										✓
<b>Quebec City</b>																								
St Lawrence Stevedoring	✓	✓	✓				✓	✓	✓	✓	✓	✓	✓				✓							✓
<b>Regina</b>																								
Viterra Inc				✓																				
<b>Saint John</b>																								
Saint John Port Authority				✓							✓		✓						✓	✓	✓	✓	✓	✓
<b>Salaberry-de-Valleyfield</b>																								
Valport Maritime Services Inc.	✓			✓			✓	✓			✓		✓				✓		✓	✓	✓	✓	✓	✓
<b>Saskatoon</b>																								
Canpotex Limited												✓												
<b>Sept-Iles</b>																								
Porlier Express Inc	✓	✓	✓	✓					✓	✓			✓	✓			✓							
<b>Sept-Iles</b>																								
Iron Ore Company of Canada								✓																
<b>Sept-Iles</b>																								
Tessier Ltd																								
<b>Sept-Iles</b>																								
Port of Sept-Iles	✓		✓					✓		✓			✓											✓

# COMMODITIES HANDLED

COMMODITIES	CL	CC	PC	G-A	AF	CM	CLK	IO	BX	AL	FR	G-FGD	AG	SU	SOY	SODA	MIN	CHEM	BC	FRS	STL	P&P	MB	OTH	
<b>Sept-Îles</b>																									
Wabush Mines																									
<b>Sept-Îles</b>																									
Sept-Îles Port Authority			✓					✓		✓			✓	✓			✓					✓	✓	✓	
<b>Sorel-Tracy</b>																									
Richardson International (Quebec)				✓																					
<b>Squamish</b>																									
Squamish Terminals Ltd																				✓	✓	✓	✓		✓
<b>St Catherines</b>																									
The St Lawrence Seaway Management Corporation	✓	✓	✓	✓	✓	✓	✓	✓	✓	✓	✓	✓	✓	✓	✓	✓	✓	✓	✓		✓	✓	✓	✓	✓
<b>St Johns</b>																									
Port of Stephenville																									✓
<b>St Johns</b>																									
Ports & Harbours																									✓
<b>Sydney</b>																									
Sydney Ports	✓																								
<b>Thunder Bay</b>																									
Richardson International Ltd				✓																					
<b>Thunder Bay</b>																									
Thunder Bay Terminals Ltd	✓		✓	✓							✓														
<b>Thunder Bay</b>																									
Valley Camp Terminal, Inc.	✓	✓	✓								✓						✓					✓			
<b>Thunder Bay</b>																									
Mission Terminal				✓																					
<b>Thunder Bay</b>																									
Western Grain By-Products				✓																					
<b>Thunder Bay</b>																									
Thunder Bay Port Authority	✓		✓	✓							✓		✓				✓		✓	✓	✓	✓	✓	✓	✓
<b>Toronto</b>																									
Toronto Port Authority	✓	✓		✓	✓	✓	✓				✓	✓	✓	✓	✓	✓	✓	✓	✓		✓	✓	✓	✓	✓
<b>Trois-Rivières</b>																									
Port of Trois Rivières	✓		✓	✓		✓	✓			✓	✓	✓			✓						✓	✓	✓		
<b>Trois-Rivières</b>																									
Group Prommel																									
<b>Trois-Rivières</b>																									
Three Rivers Elevators				✓																					
<b>Vancouver</b>																									
Cascadia Terminal				✓																					
<b>Vancouver</b>																									
Port of Vancouver	✓			✓	✓						✓		✓	✓			✓				✓	✓	✓	✓	✓
<b>Victoria</b>																									
Little Narrows Gypsum Company Ltd							✓																		
<b>Ville de La Baie</b>																									
Rio Tinto Alcan Port Alfred			✓						✓	✓															
<b>WaWa</b>																									
Michipicoten Harbour								✓	✓													✓			
<b>West Vancouver</b>																									
Canpotex Terminals Limited											✓														
<b>Windsor</b>																									
ADM Agri-Industries Company				✓													✓								
<b>Windsor</b>																									
Port of Windsor				✓		✓							✓	✓	✓						✓	✓		✓	
<b>Winnipeg</b>																									
Viterra				✓																					
<b>Winnipeg</b>																									
Richardson International Ltd				✓																					
<b>CANARY ISLANDS</b>																									
<b>Santa Cruz</b>																									
Junta del Puerto de Sto Cruz																									
<b>CAPE VERDE</b>																									
<b>Praia</b>																									
Capitania dos Portos de Sotavento																									
<b>CHILE</b>																									
<b>Antofagasta</b>																									
Caleta Coloso																									
<b>Arica</b>																									
Puerto Arica	✓			✓				✓			✓				✓		✓	✓							
<b>Castilla</b>																									
Tocopilla	✓																								



COMMODITIES	CL	CC	PC	G-A	AF	CM	CLK	IO	BX	AL	FR	G-FGD	AG	SU	SOY	SODA	MIN	CHEM	BC	FRS	STL	P&P	MB	OTH
<b>Concepcion</b>																								
Neuling Graneles SA	✓			✓				✓	✓		✓													
<b>Iquique</b>																								
Empresa Portuaria Iquique																								
<b>La Serena</b>																								
Port Authority of Guayacan								✓																
<b>Lirquen</b>																								
Port of Lirquen SA											✓													
<b>Mejillones</b>																								
Puerto de Mejillones S.A	✓		✓				✓										✓							✓
<b>Puerto Natales</b>																								
Port of Puerto Natales																							✓	
<b>Quintero</b>																								
Port Authority of Quintero	✓			✓					✓															
<b>San Antonio</b>																								
Puerto Panul S.A.																								
<b>Santiago</b>																								
Portuaria Puchoo SA	✓			✓																				
<b>Santiago</b>																								
E.CL S.A.	✓	✓	✓			✓	✓	✓		✓							✓	✓					✓	
<b>Tocopilla</b>																								
Central Termoelectrica Tocopilla	✓																							
<b>Valparaíso</b>																								
Valparaiso Port Authority	✓																							
<b>Valparaíso</b>																								
Saam				✓																	✓			
<b>CHINA</b>																								
<b>Anqing</b>																								
Anqing Port Authority	✓							✓					✓											
<b>Beihai</b>																								
Behai Harbour Administration				✓																				
<b>Chiwan</b>																								
Chiwan Harbour Container Office Building				✓		✓					✓			✓										
<b>Chongquin</b>																								
Chongquin Port Authority	✓								✓		✓													
<b>Dalian</b>																								
Ganjingzi Coal Terminal	✓																							
<b>Dalian</b>																								
DCW Group Co																								
<b>Dalian</b>																								
Dalian Port Authority	✓			✓																				
<b>Dalian</b>																								
Dalian Bay Coal Terminal	✓																							
<b>Dongfang County</b>																								
Basuo Port Corporation	✓		✓	✓		✓		✓					✓								✓		✓	
<b>Fangcheng</b>																								
Fangcheng HarbourAdministration	✓																							✓
<b>Fujian Province</b>																								
Dongshan Port Authority						✓							✓											
<b>Fuzhou</b>																								
Fuzhou Port																								✓
<b>Guangzhou</b>																								
Xinggang No1				✓																				
<b>Haikou</b>																								
Haikou Port Authority								✓																
<b>Hong Kong</b>																								
China Cement Co (HK) Ltd						✓																		
<b>Hong Kong</b>																								
CLP Power HK Limited	✓																							
<b>Hong Kong</b>																								
The Hongkong Electric Company Ltd	✓											✓												
<b>Hualien</b>																								
Hualien Harbour Bureau	✓																							
<b>Jiangsu</b>																								
Port of Lianyungang	✓										✓													
<b>Jinzhou</b>																								
Jinzhou Port Authority						✓		✓	✓															✓
<b>Lianyungang</b>																								
Lianyungang Port Authority	✓			✓							✓													
<b>Longkou City</b>																								
Longkou Port Authority				✓		✓					✓											✓		✓

# COMMODITIES HANDLED

COMMODITIES	CL	CC	PC	G-A	AF	CM	CLK	IO	BX	AL	FR	G-FGD	AG	SU	SOY	SODA	MIN	CHEM	BC	FRS	STL	P&P	MB	OTH	
<b>Nanjing</b>																									
Nanjing Port Authority								✓													✓				
<b>Nantong</b>																									
Nantong Port Authority	✓			✓							✓														
<b>Ningbo</b>																									
Ningbo Port Authority	✓			✓				✓			✓											✓			✓
<b>Pinghu</b>																									
Zhapu Port Authority	✓			✓		✓																			
<b>Putian</b>																									
Port of Xiuyu	✓			✓																	✓		✓		✓
<b>Qingdao</b>																									
Port of Qingdao	✓			✓							✓											✓		✓	
<b>Qingdao</b>																									
Port of Qingdao Coal Terminal	✓																								
<b>Qingdao</b>																									
Xigang Company				✓				✓		✓	✓										✓	✓	✓		
<b>Qinhuangdao</b>																									
Qinhuangdao Port Authority	✓			✓		✓		✓			✓										✓	✓		✓	
<b>Rizhao City</b>																									
Rizhao Port Authority	✓			✓		✓		✓	✓		✓														
<b>Sanya</b>																									
Sanya Port	✓			✓							✓			✓										✓	
<b>Shanghai</b>																									
Shanghai Port Luojing Bulk Terminals	✓																								
<b>Shanghai</b>																									
Ming Sheng Stevedores No 3/4 Terminals				✓																					
<b>Shanghai</b>																									
Shanghai International Port Group (SIPG)	✓			✓				✓	✓		✓														
<b>Shantou</b>																									
Shantou Port																									✓
<b>Shenzhen</b>																									
Shekou Port Service Co Ltd				✓																					
<b>Shenzhen</b>																									
Shenzhen Yantian Port								✓			✓											✓			✓
<b>Shenzhen</b>																									
Shenzhen Haixin Harbour Development Co Ltd											✓											✓			
<b>Shenzhen</b>																									
Chiwan Port Authority				✓		✓					✓			✓											
<b>Shijiazhuang</b>																									
Hebei Port Group Co, Inc	✓																								
<b>Taizhou City</b>																									
Port of Haimen	✓																								
<b>Tanggu</b>																									
Tianjin Port Authority	✓			✓					✓		✓											✓			
<b>Tanggu</b>																									
Tianjin Xingang Sinor Terminal Co Ltd																					✓	✓			
<b>Tangshan</b>																									
Jintang Port	✓																								
<b>Wenzhou</b>																									
Wenzhou Port																									✓
<b>Wuhu</b>																									
Wuhu Port Authority	✓			✓					✓		✓														
<b>Xiamen</b>																									
Xiamen Harbour Authority	✓			✓							✓														✓
<b>Yantai</b>																									
Yantai Port Authority	✓													✓								✓			
<b>Yingkou</b>																									
Port of Yingkou	✓			✓				✓			✓												✓		
<b>Zhanjiang</b>																									
Zhanjiang Port Authority	✓					✓		✓	✓																✓
<b>Zhanjiang</b>																									
Zhanjiang Port Authority	✓			✓		✓			✓		✓		✓									✓			
<b>Zhenjiang</b>																									
Zhenjiang Port Authority	✓			✓				✓			✓													✓	
<b>Zhoushan</b>																									
Zhoushan Port Administrative Bureau	✓					✓																			
<b>Zhoushan</b>																									
Zhoushan Port Haitong Transhipment & Storage Co Ltd	✓																								



COMMODITIES	CL	CC	PC	G-A	AF	CM	CLK	IO	BX	AL	FR	G-FGD	AG	SU	SOY	SODA	MIN	CHEM	BC	FRS	STL	P&P	MB	OTH	
<b>COLOMBIA</b>																									
<b>Barranquilla</b>																									
Sociedad Portuaria Del Norte	✓			✓																					
<b>Barranquilla</b>																									
Carbones del Carrejon LLC	✓																								
<b>Barranquilla</b>																									
Tolu	✓																								
<b>Barranquilla</b>																									
Sociedad Portuaria Regional de Barranquilla SA	✓																								
<b>Barranquilla</b>																									
Port of Puerto Bolivar	✓																								
<b>Barranquilla</b>																									
Cementos del Caribe						✓																			
<b>Barranquilla</b>																									
Sociedad Portuaria Golfo de Morrosquillo SA	✓	✓				✓	✓	✓	✓		✓	✓	✓						✓		✓				
<b>Bogota</b>																									
Santa Marta Coal Terminal	✓																								
<b>Bogota</b>																									
Puertos de Colombia																									
<b>Buenaventura</b>																									
Sociedad Portuaria Regional de Buenaventura S.A				✓							✓														
<b>Santa Marta</b>																									
Puerto Prodeco	✓																								
<b>Santa Marta</b>																									
Port of Santa Marta	✓			✓											✓						✓			✓	
<b>Sociedad Portuaria Santa Marta</b>																									
CTS de Colombia	✓																								
<b>CONGO (REPUBLIC OF)</b>																									
<b>Pointe Noire</b>																									
Port Authority of Pointe Noire	✓							✓																	
<b>CROATIA</b>																									
<b>Ploce</b>																									
Port of Ploce Authority	✓	✓	✓	✓			✓	✓	✓	✓				✓	✓						✓	✓			✓
<b>Rijeka</b>																									
LUKA Rijeka d.d.	✓							✓							✓						✓				
<b>Rijeka</b>																									
Terminal Bakar	✓							✓																	
<b>Zadar</b>																									
Zadar Port Authority				✓		✓									✓										
<b>CUBA</b>																									
<b>Antilla</b>																									
Nicaró	✓																								
<b>Antilla</b>																									
Port of Felton											✓														
<b>Antilla</b>																									
Antilla Port Authority				✓										✓											
<b>Cardenas</b>																									
Port of Cardenas											✓			✓											
<b>Cienfuegos</b>																									
Port of Cienfuegos				✓		✓								✓											
<b>Havana</b>																									
Port Authority of Havana	✓			✓							✓														
<b>Maríel</b>																									
Port of Maríel														✓											
<b>Matanzas</b>																									
Port Authority of Matanzas											✓														
<b>Puerto Tarafa Nuevitas</b>																									
Port of Nuevitas						✓								✓											
<b>Santiago de Cuba</b>																									
Port of Santiago de Cuba				✓		✓								✓											
<b>CURACAO</b>																									
<b>Willemstad</b>																									
Curacao Ports Authority				✓		✓								✓					✓				✓		✓
<b>CYPRUS</b>																									
<b>Nicosia</b>																									
Lemesos Port c/o Cyprus Port Authority				✓	✓										✓						✓	✓		✓	
<b>Nicosia</b>																									
Vassiliko Cement Works Ltd			✓			✓																			

# COMMODITIES HANDLED

COMMODITIES	CL	CC	PC	G-A	AF	CM	CLK	IO	BX	AL	FR	G-FGD	AG	SU	SOY	SODA	MIN	CHEM	BC	FRS	STL	P&P	MB	OTH	
<b>Nicosia</b>																									
Cyprus Port Authority																									
<b>Nicosia</b>																									
Port of Vassiliko c/o Cyprus Ports Authority		✓	✓	✓	✓	✓	✓				✓				✓								✓		
<b>Nicosia</b>																									
Vassiliko Port				✓		✓																			
<b>DENMARK</b>																									
<b>Aabenraa</b>																									
Aabenraa Havn Port Authority				✓		✓																			
<b>Aabenraa</b>																									
Ensted Transit Harbour I/S	✓																				✓				
<b>Aalborg</b>																									
Port of Aalborg				✓	✓		✓					✓	✓								✓	✓		✓	
<b>Aalborg</b>																									
Aalborg Bulk Terminal				✓	✓						✓				✓						✓		✓		✓
<b>Aalborg</b>																									
Aalborg Portland							✓																		
<b>Aarhus</b>																									
Port of Aarhus	✓			✓		✓																			
<b>Aarhus</b>																									
Cargo Service A/S				✓	✓						✓		✓		✓							✓	✓		
<b>Bandholm</b>																									
Port of Bandholm				✓							✓														
<b>Charlottenlund</b>																									
Copenhagen Merchants				✓	✓						✓				✓						✓				
<b>Copenhagen</b>																									
Copenhagen Malmo Port AB	✓		✓	✓		✓						✓	✓	✓							✓	✓	✓	✓	✓
<b>Esbjerg</b>																									
Port of Esbjerg	✓																								
<b>Fredericia</b>																									
DLA Agro				✓																					
<b>Fredericia</b>																									
Fredericia Bulk Terminal c/o Fredericia Shipping				✓	✓						✓				✓						✓	✓	✓		✓
<b>Fredericia</b>																									
Associated Danish Ports A/S				✓	✓	✓					✓		✓	✓	✓			✓			✓		✓	✓	✓
Port of Fredericia				✓	✓	✓					✓		✓	✓	✓			✓			✓		✓	✓	✓
<b>Grenaa</b>																									
Grenaa Bulk Terminal				✓																					
<b>Grenaa</b>																									
Port of Grenaa Ltd.				✓																	✓				
<b>Haderslev</b>																									
Port of Haderslev				✓							✓														
<b>Horsens</b>																									
Port Authority Horsens				✓																					✓
<b>Kalundborg</b>																									
Asnaes Power Station									✓		✓														
<b>Kalundborg</b>																									
Kalundborg Port Authority				✓	✓						✓	✓		✓								✓	✓	✓	
<b>Kalundborg</b>																									
Kalundborg Bulk Terminal				✓																					
<b>Kolding</b>																									
Kolding Port Authority				✓		✓					✓														
<b>Korsøer</b>																									
Port of Korsøer				✓		✓																			
<b>Naestved</b>																									
Naestved Port				✓							✓														✓
<b>Nakskov</b>																									
Nakskov Port				✓																					
<b>Nykøbing</b>																									
Nykøbing Port Authority				✓							✓		✓												
<b>Nykøbing Falster</b>																									
Guldborgsund Havne	✓			✓							✓			✓					✓	✓		✓	✓	✓	✓
<b>Odense</b>																									
Port of Odense				✓		✓					✓											✓		✓	
<b>Randers</b>																									
Randers Port	✓			✓	✓	✓	✓	✓	✓		✓		✓		✓		✓			✓	✓	✓	✓	✓	✓
<b>Rodby</b>																									
Rodby Port Authority				✓							✓														
<b>Roenne</b>																									
Port of Roenne Ltd.	✓			✓	✓	✓					✓		✓		✓						✓		✓		
<b>Roenne</b>																									
Roenne Port Authority				✓																					



COMMODITIES	CL	CC	PC	G-A	AF	CM	CLK	IO	BX	AL	FR	G-FGD	AG	SU	SOY	SODA	MIN	CHEM	BC	FRS	STL	P&P	MB	OTH
<b>Roenne</b>																								
BAF (Bornholms Andels Foderstofforretning)				✓																				
<b>Skaelskor</b>																								
Stigsnaesvaerkets Port Authority	✓																							
<b>Skaelskor</b>																								
Skaelskor Port Authority				✓																				
<b>Skoodstrup</b>																								
Studstrup Port Authority	✓																							
<b>Vordingborg</b>																								
Vordingborg Port Authority				✓							✓		✓											✓
<b>DOMINICAN REPUBLIC</b>																								
<b>Santa Domingo</b>																								
Port of Santo Domingo				✓							✓													
<b>Santo Domingo</b>																								
Barahona Port Authority						✓						✓		✓										
<b>Santo Domingo</b>																								
Cabo Rojo Port Authority									✓															✓
<b>Santo Domingo</b>																								
San Pedro de Macoris	✓		✓	✓		✓	✓				✓			✓					✓					
<b>Santo Domingo</b>																								
Maritima Dominicana SA	✓		✓	✓		✓	✓				✓		✓	✓	✓	✓	✓		✓	✓	✓	✓	✓	✓
<b>ECUADOR</b>																								
<b>Guayaquil</b>																								
Port Authority of Guayaquil				✓																				
<b>EGYPT</b>																								
<b>Alexandria</b>																								
Alexandria Port Authority	✓			✓		✓					✓													
<b>Alexandria</b>																								
Kamaria Grain Terminal				✓																				
<b>Cairo</b>																								
Abu Zenima Port Authority									✓															
<b>Cairo</b>																								
El Wadi Holdings				✓																				
<b>Cairo</b>																								
El Sokhna Port Development Company									✓			✓												
<b>Cairo</b>																								
Sinai Manganese Co S A E																								
<b>Cairo</b>																								
Medsofts				✓																				
<b>Damietta</b>																								
Mina Damyat Terminal				✓																				
<b>Damietta</b>																								
Damietta Port Authority				✓																				
<b>Hamrawein</b>																								
Hamrawein Port Authority									✓			✓												
<b>Ismailia</b>																								
Port Authority of Safaga				✓							✓		✓											
<b>Ismailia</b>																								
Suez Canal Authority																								
<b>Ismailia</b>																								
Suez Canal Authority																								
<b>Port Said</b>																								
Port Said Port Authority				✓																				
<b>Port Tewfik</b>																								
Red Sea Port Authority																								
<b>Safaga</b>																								
Safaga Grain Berth No1				✓																				
<b>EL SALVADOR</b>																								
<b>Acajutla</b>																								
Port of Acajutla				✓							✓													
<b>ERITREA</b>																								
<b>Assab</b>																								
Assab Port Administration				✓							✓													
<b>ESTONIA</b>																								
<b>Tallinn</b>																								
AS Coal Terminal	✓																							
<b>Tallinn</b>																								
KS Stevedoring				✓																				

# COMMODITIES HANDLED

COMMODITIES	CL	CC	PC	G-A	AF	CM	CLK	IO	BX	AL	FR	G-FGD	AG	SU	SOY	SODA	MIN	CHEM	BC	FRS	STL	P&P	MB	OTH
<b>Tallinn</b>																								
Muuga (Novotallinskiy)	✓			✓							✓		✓											✓
<b>Tallinn</b>																								
AS DBT (Dry Bulk Terminal)											✓													
<b>Tallinn</b>																								
Port of Tallinn	✓			✓	✓		✓			✓	✓		✓	✓	✓				✓	✓	✓	✓	✓	✓
<b>Tallinn</b>																								
AS Baltic Chemical Terminal											✓													
<b>Tallinn</b>																								
AS MGT Muuga Grain Terminal				✓																				
<b>Tallinn</b>																								
PETROMAKS SPEDIITORI AS	✓			✓																				
<b>Viimsi Vald</b>																								
AS Stivis	✓										✓										✓	✓		
<b>FIJI</b>																								
<b>Suva</b>																								
Ports Authority of Fiji								✓																
<b>FINLAND</b>																								
<b>Hamina</b>																								
Port of Hamina Ltd																					✓			
<b>Kokkola</b>																								
Oy M Raunheimo Ab																			✓	✓	✓			
<b>Kokkola</b>																								
Port of Kokkola						✓													✓	✓	✓			
<b>Kotka</b>																								
OY Finnterminals AB																								
<b>Kotka</b>																								
Port Of Kotka Ltd				✓							✓										✓		✓	
<b>Kotka</b>																								
Steveco Oy				✓							✓				✓		✓				✓			✓
<b>Loviisa</b>																								
Port of Loviisa				✓	✓																			
<b>Naantali</b>																								
Port of Naantali	✓			✓		✓																		
<b>Naantali</b>																								
Port of Olkiluoto																								
<b>Oulu</b>																								
Herman Andersson Oy																								
<b>Oulu</b>																								
Oulu Stevedoring OY																								
<b>Oulu</b>																								
Port of Oulu				✓		✓																✓		
<b>Pori</b>																								
Port of Pori	✓																				✓			✓
<b>Raahe</b>																								
Port of Raahe																							✓	
<b>Rauma</b>																								
Euroports Rauma (previously OY Rauma Stevedoring)										✓		✓						✓	✓	✓	✓	✓	✓	✓
<b>Rauma</b>																								
Port of Rauma Authority				✓	✓																✓	✓	✓	✓
<b>Turku</b>																								
Port of Turku Authority				✓											✓						✓	✓	✓	✓
<b>Vaasa</b>																								
Port of Vaasa	✓			✓	✓										✓									
<b>Vantaa</b>																								
Suomen Viljava Oy				✓																				
<b>FRANCE</b>																								
<b>Bassens</b>																								
Ste Aquitaine du Silo de																								
Bordeaux-Bassens				✓																				
<b>Bassens</b>																								
CIMALIT						✓																		
<b>Bassens</b>																								
Gemadocks											✓													
<b>Bassens</b>																								
Sea-invest Bordeaux																								
<b>Blainville Sur Orne</b>																								
SOGEMAR																								
<b>Blaye</b>																								
Blaye Grain Terminal				✓																				
<b>Bordeaux</b>																								
SPBL				✓																				



COMMODITIES	CL	CC	PC	G-A	AF	CM	CLK	IO	BX	AL	FR	G-FGD	AG	SU	SOY	SODA	MIN	CHEM	BC	FRS	STL	P&P	MB	OTH	
<b>Bordeaux</b>																									
Bordeaux Port Authority	✓			✓	✓	✓		✓			✓	✓	✓		✓					✓	✓	✓	✓	✓	✓
<b>Bordeaux</b>																									
SAIPOL				✓																					
<b>Bordeaux</b>																									
SEMABLA				✓																					
<b>Boucau</b>																									
Maisica				✓																					
<b>Brest</b>																									
Port of Brest - CCI				✓	✓	✓	✓				✓	✓	✓								✓	✓			
<b>Brest</b>																									
Port of Brest Dry Bulk Terminal				✓	✓	✓	✓				✓	✓	✓									✓			
<b>Brest</b>																									
CCI - Chambre de Commerce et d'industrie																									
<b>Brest</b>																									
Port of Brest - CCI				✓	✓	✓	✓				✓				✓										
<b>Calais</b>																									
Port of Calais																									
<b>Cherbourg-Octeville</b>																									
Port de Cherbourg	✓																								
<b>Dieppe</b>																									
Dieppe Port				✓									✓								✓	✓		✓	
<b>Dunkerque</b>																									
Sea-Bulk Terminal																									
<b>Dunkerque</b>																									
CAMEY Sables et Gravieres (Civil & Marine)																									
<b>Dunkerque</b>																									
SGD - Silo a Grain Dunkerque				✓																					
<b>Dunkerque</b>																									
Port of Dunkerque	✓			✓				✓	✓		✓		✓	✓							✓	✓			
<b>Dunkerque</b>																									
Silonor				✓																					
<b>Fecamp</b>																									
Fecamp Port Authority																								✓	✓
<b>La Rochelle</b>																									
Port Atlantique La Rochelle																						✓			
<b>La Rochelle-Pallice</b>																									
Silo de la Rochelle Pallice				✓																					
<b>Le Havre</b>																									
Coal Terminal	✓																								
<b>Le Havre</b>																									
CIPHA Multibulk Centre	✓			✓	✓	✓										✓									
<b>Le Havre</b>																									
Port of Le Havre Authority	✓			✓	✓	✓		✓	✓		✓		✓	✓							✓	✓	✓		
<b>Le Portel</b>																									
Gie Boulogne Clinker						✓	✓																		
<b>Lorient</b>																									
Port de Commerce-Lorient				✓																					
<b>Marseille</b>																									
Marseilles Grain Terminal				✓																					
<b>Marseille</b>																									
Port Autonome de Marseille/Fos									✓																
<b>Marseille</b>																									
Port of Marseilles	✓	✓	✓	✓	✓	✓	✓	✓	✓	✓	✓		✓	✓	✓	✓				✓	✓	✓	✓	✓	✓
<b>Martigues</b>																									
Carfos	✓																								
<b>Montoir-de-Bretagne</b>																									
Sea-invest Montoir																									
<b>Montoir-de-Bretagne</b>																									
SONASTOCK & ATLANTIQUE STOCKAGE				✓																					
<b>Nantes</b>																									
Montoir Agri-Bulk Terminal				✓							✓														
<b>Nantes</b>																									
Montoir Coal Terminal	✓																								
<b>Nantes</b>																									
Roche-Maurice Terminal				✓																					
<b>Nantes</b>																									
SODISTOCK Group				✓																					
<b>Nantes</b>																									
SONASTOCK - Nantes Export Terminal				✓																					

# COMMODITIES HANDLED

COMMODITIES	CL	CC	PC	G-A	AF	CM	CLK	IO	BX	AL	FR	G-FGD	AG	SU	SOY	SODA	MIN	CHEM	BC	FRS	STL	P&P	MB	OTH
<b>Nantes</b>																								
Grand Port Maritime Nantes																								
St Nazaire	✓	✓	✓	✓	✓	✓	✓				✓	✓	✓	✓	✓					✓	✓	✓	✓	✓
<b>Nantes</b>																								
Port Atlantique-Montoir																								
Agri-Bulk Terminal	✓	✓	✓	✓	✓	✓	✓	✓	✓	✓	✓	✓	✓	✓	✓	✓	✓	✓		✓	✓	✓	✓	✓
<b>Paris</b>																								
Port of Paris Authority				✓		✓							✓											✓
<b>Port De Montoir</b>																								
Sea-invest France (Stocaloire)	✓			✓																				
<b>Rouen</b>																								
Simarex Vilette				✓																				
<b>Rouen</b>																								
Maprochim											✓													
<b>Rouen</b>																								
Lecureur				✓																				
<b>Rouen</b>																								
SENALIA				✓																				
<b>Rouen</b>																								
Silos Soufflet - SOCOMAC																								
I/II Terminals				✓																				
<b>Rouen</b>																								
HAROPA																								
<b>Rouen</b>																								
SENALIA				✓																				
<b>Rouen</b>																								
Port of Rouen	✓			✓	✓				✓		✓		✓	✓							✓	✓	✓	✓
<b>Rouen</b>																								
Sogema																								
<b>Saint Malo</b>																								
St Malo Port Authority	✓			✓	✓	✓	✓	✓	✓		✓	✓	✓	✓							✓	✓	✓	✓
<b>Sète</b>																								
Sea-invest Sète																								
<b>Sète</b>																								
Sete-Multibulk Berth				✓																	✓		✓	
<b>St Malo</b>																								
SMG - Societe Malouine et Granvillaise				✓							✓													
<b>Strasbourg</b>																								
Strasbourg Port Authority				✓							✓													✓
<b>Tarnos</b>																								
Matrama Bayonne				✓		✓					✓										✓	✓		
<b>Toulon</b>																								
Port of Toulon						✓	✓		✓															
<b>GABON</b>																								
<b>Libreville</b>																								
Libreville Port Authority													✓											
<b>Libreville</b>																								
Owendo Port Authority								✓	✓															✓
<b>GEORGIA</b>																								
<b>Batumi</b>																								
Port of Poti	✓							✓	✓															
<b>Poti</b>																								
Poti Sea Port Corporation																								
<b>GERMANY</b>																								
<b>Brake</b>																								
J. Müller Agri Terminal GmbH & Co. KG				✓	✓						✓			✓	✓	✓	✓		✓				✓	✓
<b>Brake</b>																								
Niedersachsen Ports GmbH & Co. KG				✓							✓			✓					✓			✓	✓	
<b>Brake</b>																								
J. Müller BreakbulkTerminal GmbH & Co. KG																					✓	✓	✓	
<b>Bremen</b>																								
Weserport GmbH	✓	✓	✓	✓	✓	✓		✓	✓	✓	✓	✓									✓	✓		
<b>Bremerhaven</b>																								
bremenports GmbH & Co. KG	✓	✓		✓		✓		✓													✓	✓	✓	
<b>Brunsbüttel</b>																								
Brunsbüttel Ports GmbH	✓	✓	✓			✓	✓	✓	✓	✓	✓	✓					✓	✓	✓	✓	✓	✓	✓	✓
<b>Duisburg</b>																								
Rhenus AG & Co. KG	✓																							



COMMODITIES	CL	CC	PC	G-A	AF	CM	CLK	IO	BX	AL	FR	G-FGD	AG	SU	SOY	SODA	MIN	CHEM	BC	FRS	STL	P&P	MB	OTH
<b>Duisburg</b>																								
Duisburger Hafen AG	✓			✓																				
<b>Emden</b>																								
Emden Port Authority				✓																		✓		
<b>Emden</b>																								
EVAG Emden Verkehrs und Automotive	✓	✓	✓	✓	✓	✓	✓		✓	✓	✓	✓					✓				✓	✓	✓	✓
<b>Flensburg</b>																								
Flensburg Port Authority	✓			✓							✓		✓										✓	
<b>Hamburg</b>																								
NHG - NeuhoF																								
Hafengesellschaft mbH				✓																				
<b>Hamburg</b>																								
Mittal Steel Hamburg GmbH								✓														✓		
<b>Hamburg</b>																								
OAM Baustoffe GmbH													✓											
<b>Hamburg</b>																								
Louis Hagel (GmbH & Co. KG)											✓													
<b>Hamburg</b>																								
Silo P. Kruse Betriebs-GmbH & Co. KG				✓																				
<b>Hamburg</b>																								
Hamburg Sud																								
<b>Hamburg</b>																								
HaBeMa Futtermittel GmbH & Co KG				✓																				
<b>Hamburg</b>																								
GTH - Getreide Terminal Hamburg (GmbH & Co.KG)				✓																				
<b>Hamburg</b>																								
Hamburg Port Authority																								
<b>Hamburg</b>																								
K+S Terminal (Kalikai)				✓							✓						✓							
<b>Hamburg</b>																								
Wilhelm Mulch GmbH & Co KG																								✓
<b>Hamburg</b>																								
Buss Group GmbH & Co. KG													✓				✓							
<b>Hamburg</b>																								
Kali- Transport Gesellschaft GmbH											✓													
<b>Hamburg</b>																								
BUSS Ross Terminal GmbH & Co KG																						✓		✓
<b>Hamburg</b>																								
Diamant Mühle Hamburg GmbH				✓																				
<b>Hamburg</b>																								
Port of Hamburg Marketing Association	✓			✓	✓	✓		✓	✓	✓	✓	✓		✓	✓	✓					✓	✓	✓	
<b>Hamburg</b>																								
H J M (H Jürgen Müller GmbH)	✓		✓	✓	✓		✓	✓	✓		✓	✓	✓		✓		✓	✓			✓		✓	
<b>Hamburg</b>																								
Eichholtz GmbH				✓																				
<b>Hamburg</b>																								
HANSAPORT Itzehoe	✓							✓																
<b>Itzehoe</b>																								
Itzehoe Port Authority				✓							✓													
<b>Krefeld</b>																								
Krefeld Port Authority				✓																				
<b>Leer</b>																								
Rhenus AG				✓	✓	✓		✓			✓					✓			✓	✓	✓	✓		
<b>Neuss</b>																								
Neuss Port Authority				✓																				
<b>Nordenham</b>																								
Rhenus Midgard GmbH & Co. KG	✓	✓	✓	✓	✓	✓	✓	✓	✓		✓	✓									✓	✓	✓	✓
<b>Nuremberg</b>																								
Hafen Nürnberg-Roth GmbH	✓			✓		✓	✓	✓			✓					✓						✓		✓
<b>Oldenburg</b>																								
Seaports of Niedersachsen GmbH	✓	✓		✓	✓	✓	✓	✓	✓	✓	✓	✓	✓	✓	✓	✓	✓	✓	✓	✓	✓	✓	✓	✓
<b>Papenburg</b>																								
Schulte + Bruns GmbH & Co. KG	✓																							
<b>Rostock</b>																								
Bulk Terminal Rostock GmbH	✓			✓				✓			✓													

# COMMODITIES HANDLED

COMMODITIES	CL	CC	PC	G-A	AF	CM	CLK	IO	BX	AL	FR	G-FGD	AG	SU	SOY	SODA	MIN	CHEM	BC	FRS	STL	P&P	MB	OTH
<b>ROSTOCK</b>																								
Getreide Service Rostock GmbH				✓	✓		✓					✓												
<b>ROSTOCK</b>																								
Seehafen Rostock																								
Umschlagsgesellschaft mbH	✓			✓				✓				✓												
<b>STADE</b>																								
Butzfleth Port Authority									✓															
<b>STRALSUND</b>																								
Port of Stralsund				✓							✓		✓										✓	
<b>WILHELMSHAVEN</b>																								
Rhenus Midgard Wilhelmshaven GmbH & Co KG	✓	✓						✓																
<b>GHANA</b>																								
<b>Takoradi</b>																								
Ghana Ports & Harbours Authority																								
<b>Takoradi</b>																								
Takoradi Port Authority	✓			✓					✓		✓		✓											
<b>Tema</b>																								
Tema Port								✓																
<b>GREECE</b>																								
<b>Alexandroupolis</b>																								
Alexandroupolis Port Authority				✓																				
<b>Aliveri</b>																								
Mylaki Port Authority	✓					✓																		
<b>Attica</b>																								
Milaki Port-East Mediterranean Coal Terminal	✓																							
<b>Chalkis</b>																								
Chalkis Port Authority	✓					✓					✓													
<b>Chania Crete</b>																								
Suda Bay Port				✓																				
<b>Corfu</b>																								
Corfu Port Authority				✓																				
<b>Itea</b>																								
Itea Port Authority									✓															
<b>Kalamata</b>																								
Kalamata Port Authority				✓																	✓			
<b>Milos Island</b>																								
Milos Island Port Authority								✓	✓															
<b>Nissyros</b>																								
Yali Island Port Authority														✓										
<b>Piraeus</b>																								
Piraeus Port Authority				✓							✓													
<b>Pylos</b>																								
Pylos Port Authority																							✓	
<b>Thessaloniki</b>																								
Thessaloniki Port Authority SA	✓			✓	✓	✓	✓	✓	✓		✓	✓									✓	✓	✓	✓
<b>GUADELOUPE</b>																								
<b>Point A Pitre</b>																								
Pointe-a-Pitre Port	✓			✓			✓				✓	✓	✓	✓										
<b>GUAM</b>																								
<b>Piti</b>																								
Apra Harbour														✓								✓	✓	
<b>GUYANA</b>																								
<b>Georgetown</b>																								
Georgetown Port Authority				✓										✓										
<b>Kingston</b>																								
Linden Port Authority									✓															
<b>Kingston</b>																								
New Amsterdam Port Authority									✓															
<b>HAITI</b>																								
<b>Port Au Prince</b>																								
Port Au Prince Port Authority				✓		✓		✓						✓										
<b>HONDURAS</b>																								
<b>Puerto Cortés</b>																								
National Port Company																								
<b>Puerto Cortés</b>																								
Puerto Cortes Port Authority				✓				✓	✓		✓			✓										
<b>San Pedro Sula</b>																								
Terminales de Cortes, S.A de C.V	✓			✓	✓	✓	✓	✓			✓			✓							✓	✓	✓	



COMMODITIES	CL	CC	PC	G-A	AF	CM	CLK	IO	BX	AL	FR	G-FGD	AG	SU	SOY	SODA	MIN	CHEM	BC	FRS	STL	P&P	MB	OTH
<b>ICELAND</b>																								
<b>Grundartangi</b>																								
Grundartangi Port	✓																							
<b>Hafnarfjordur</b>																								
Port of Hafnarfjordur									✓	✓			✓											✓
<b>Raohusinu</b>																								
Vestmannaeyjar Port Authority																								✓
<b>Reykjavik</b>																								
Associated Icelandic Ports				✓		✓						✓												
<b>INDIA</b>																								
<b>Adyar</b>																								
Subarnarekha Port Private Ltd	✓	✓	✓	✓		✓	✓	✓																
<b>Bhavnagar Gujarat</b>																								
Bhavnagar Port Authority																								✓
<b>Bhubaneswar</b>																								
DPCL - Dhamra Port Company Limited	✓	✓						✓																
<b>Calcutta</b>																								
Calcutta Port Trust	✓			✓		✓		✓	✓					✓										✓
<b>Calicut</b>																								
Calicut Port Authority				✓				✓	✓															
<b>Chennai</b>																								
Sical Logistics Limited																								
<b>Chennai</b>																								
Port of Chennai	✓																							
<b>Chennai</b>																								
Ennore Port Limited	✓							✓																
<b>Chennai</b>																								
Karaikal Port Private Limited	✓	✓	✓	✓		✓		✓			✓	✓	✓	✓					✓	✓	✓		✓	✓
<b>Churchgate</b>																								
Yogaytan Ports Pvt. Ltd.																								
<b>Cochin</b>																								
Cochin Port Trust	✓			✓		✓	✓	✓	✓		✓	✓	✓			✓	✓			✓	✓	✓		✓
<b>Devanampattinam</b>																								
Cuddalore Port Authority	✓							✓																
<b>Dist. Nellore</b>																								
Krishnapatnam Port Company Limited	✓	✓	✓	✓		✓	✓	✓			✓	✓		✓			✓	✓	✓		✓		✓	✓
<b>Gandhinagar</b>																								
Gujarat Maritime Board	✓			✓		✓					✓													
<b>Goa</b>																								
Mormugao Port Trust	✓	✓	✓					✓	✓	✓	✓	✓							✓		✓			✓
<b>Gujarat</b>																								
Dahej Port Authority											✓													
<b>Gujarat</b>																								
Kandla Port Trust				✓							✓													
<b>Haldia</b>																								
TM International Logistics Ltd.	✓	✓	✓																			✓		
<b>Hyderabad</b>																								
Gangavaram Port Limited	✓																							
<b>Karnataka State</b>																								
New Mangalore Port Trust	✓			✓				✓	✓		✓													
<b>Karnataka State</b>																								
Karwar Port Authority								✓	✓		✓		✓											✓
<b>Kolkata</b>																								
Riverine Group	✓	✓		✓				✓											✓					
<b>Kolkata</b>																								
T M International Logistics Limited		✓						✓			✓											✓		
<b>Minapore</b>																								
Haldia Port Authority	✓							✓	✓		✓													✓
<b>Mumbai</b>																								
J.M. Baxi & Co	✓			✓	✓			✓			✓			✓								✓	✓	
<b>Mumbai</b>																								
Seacrest Marine Services Pvt. Ltd.	✓			✓				✓																
<b>Mumbai</b>																								
Skil Infrastructure Ltd	✓																							
<b>Mumbai</b>																								
Bombay Port Trust	✓			✓							✓													
<b>Mundra</b>																								
Adani Ports and Special Economic Zone Limited																								

# COMMODITIES HANDLED

COMMODITIES	CL	CC	PC	G-A	AF	CM	CLK	IO	BX	AL	FR	G-FGD	AG	SU	SOY	SODA	MIN	CHEM	BC	FRS	STL	P&P	MB	OTH
<b>Nagapattinam</b>																								
Nagapattinam Port Authority				✓							✓													
<b>Nungambakkam</b>																								
International Seaports (India) Pvt Ltd	✓																							
<b>Orissa</b>																								
Paradip Port Trust	✓			✓				✓	✓		✓												✓	
<b>Porbander</b>																								
Porbandar Port Authority	✓		✓	✓		✓			✓		✓													
<b>Port Okha</b>																								
Port Okha Port Authority	✓		✓	✓		✓	✓		✓		✓												✓	
<b>Tuticorin</b>																								
Tuticorin Port Trust	✓			✓		✓		✓																
<b>Visakhapatnam</b>																								
Visakhapatnam Port Trust	✓					✓		✓	✓		✓												✓	
<b>Visakhapatnam</b>																								
Port of Visakhapatnam	✓							✓															✓	
<b>INDONESIA</b>																								
<b>Bandar Lampung</b>																								
PT. Bukit Asam (Persero) Tbk	✓																							
<b>Banjarmasin</b>																								
Port of Banjarmasin	✓																							
<b>Bitung</b>																								
Port of Bitung																								
<b>Cilacap</b>																								
Cilacap						✓		✓			✓													✓
<b>Cilegon</b>																								
PT Krakatau Bandar Samudera	✓																							
<b>Irian Jaya</b>																								
Amamapare								✓	✓															
<b>Jakarta</b>																								
Pulau Laut	✓																							
<b>Jakarta</b>																								
Tanjung Priok				✓		✓																	✓	
<b>Jakarta</b>																								
PT. Terminal Batubara Indah	✓																							
<b>Jakarta</b>																								
Gebe Island								✓	✓															
<b>Jakarta</b>																								
Balikpapan Coal Export Terminal	✓																							
<b>Jakarta</b>																								
North Pulau Laut Coal Terminal	✓																							
<b>Jakarta</b>																								
P T Indominco Mandiri	✓																							
<b>Jakarta</b>																								
Pt. Pulau Laut																								
<b>Jakarta</b>																								
PT Indonesia Bulk Terminal	✓	✓																						
<b>Kijang</b>																								
Port of Kijang									✓															
<b>Kotabaru</b>																								
PT Indonesia Bulk Terminal	✓	✓																						
<b>Lampung</b>																								
Pelabuhan Panjang	✓			✓																				
<b>Lhokseumawe</b>																								
Port of Lhokseumawe																								✓
<b>Padang</b>																								
Teluk Bayur Coal Terminal	✓																							
<b>Padang</b>																								
Port of Teluk Bayur	✓					✓																		
<b>Palembang</b>																								
Port Authority Palembang																								✓
<b>Palembang</b>																								
Kertapati Coal Terminal	✓																							
<b>Sabang</b>																								
Port of Sabang	✓																							
<b>Surabaya</b>																								
Surabaya Port Authority	✓			✓							✓													
<b>Tanjung Priok</b>																								
Bogasari Flour Mills Terminal				✓																				
<b>IRAN</b>																								
<b>Tehran</b>																								
Chah Bandar Port Authority								✓																



COMMODITIES	CL	CC	PC	G-A	AF	CM	CLK	IO	BX	AL	FR	G-FGD	AG	SU	SOY	SODA	MIN	CHEM	BC	FRS	STL	P&P	MB	OTH
<b>Tehran</b>																								
Khorranshar Port Authority						✓																		
<b>Tehran</b>																								
Bandar Abbas Port Authority				✓				✓			✓													
<b>IRELAND</b>																								
<b>Arklow</b>																								
Arklow Port Authority													✓											
<b>Cork</b>																								
Ringaskiddy Deepwater Terminal				✓																				
<b>Cork</b>																								
Port of Cork Company	✓			✓	✓	✓					✓		✓		✓		✓			✓	✓	✓	✓	✓
<b>Dublin</b>																								
Dublin Port & Docks Board	✓			✓				✓	✓		✓		✓											✓
<b>Dundalk</b>																								
Dundalk Harbour Commissioners	✓			✓																				
<b>Foynes</b>																								
Shannon Foynes Port Company	✓			✓					✓		✓													
<b>Galway</b>																								
Galway Harbour Company	✓			✓							✓													
<b>Greenore</b>																								
Greenore Port Limited	✓			✓							✓													
<b>Kilrush</b>																								
Kilrush Port Authority				✓																				
<b>Kinsale</b>																								
Henry Good Limited				✓																				
<b>Kinsale</b>																								
Kinsale Harbour Commissioners				✓	✓						✓													
<b>New Ross</b>																								
New Ross Port Company	✓		✓	✓	✓	✓	✓	✓			✓								✓	✓	✓		✓	
<b>Tralee</b>																								
Fenit Port Authority	✓																							
<b>Turvey</b>																								
Moneypoint	✓																							
<b>Waterford</b>																								
Port of Waterford Company	✓			✓	✓	✓	✓				✓	✓	✓		✓				✓	✓	✓	✓		✓
<b>Wicklow</b>																								
Wicklow Port Co																				✓	✓	✓	✓	✓
<b>ISRAEL</b>																								
<b>Ashdod</b>																								
Ashdod Port Co. Ltd	✓			✓							✓													
<b>Ashkelon</b>																								
The National Coal Supply Corporation (N.C.S.C)	✓																							
<b>Eilat</b>																								
Eilat Port Ltd - Israel											✓													
<b>Hadera</b>																								
Port of Hadera	✓																							
<b>Hadera</b>																								
The National Coal Supply Corporation Ltd (NCSC)	✓																							
<b>Haifa</b>																								
Haifa Port Company Ltd	✓			✓																				
<b>Haifa</b>																								
Haifa Grain Terminal				✓																				
<b>Tel Aviv</b>																								
Ports & Railways Authority																								
<b>Tel Aviv</b>																								
Israel Ports Company																								✓
<b>Tel Aviv</b>																								
Ports and Railways Authority of Israel																								
<b>ITALY</b>																								
<b>Ancona</b>																								
Ancona Port Authority				✓		✓		✓			✓													✓
<b>Ancona</b>																								
Ancona Coal Terminal	✓																							
<b>Barlette</b>																								
Barletta Port Authority	✓			✓																				✓
<b>Cagliari</b>																								
Port of Cagliari	✓			✓																				✓
<b>Chioggia</b>																								
Chioggia Port Authority																								✓

# COMMODITIES HANDLED

COMMODITIES	CL	CC	PC	G-A	AF	CM	CLK	IO	BX	AL	FR	G-FGD	AG	SU	SOY	SODA	MIN	CHEM	BC	FRS	STL	P&P	MB	OTH
<b>Civitavecchia</b>																								
Civitavecchia Port Authority	✓		✓	✓							✓												✓	✓
<b>Crotone</b>																								
Crotone Port Authority				✓																			✓	
<b>Gaeta &amp; Civitavecchia</b>																								
Intergroup S.r.l.	✓		✓	✓		✓	✓	✓	✓	✓	✓	✓	✓	✓		✓	✓	✓	✓	✓	✓	✓	✓	
<b>Gela</b>																								
Gela Port Authority											✓													
<b>Genova</b>																								
Terminal Rinfuse Genova SpA	✓			✓				✓	✓		✓		✓									✓	✓	
<b>Genova</b>																								
Port of Genova				✓																				
<b>La Spezia</b>																								
La Spezia Port Authority	✓			✓							✓													
<b>Livorno</b>																								
Livorno Port Authority	✓			✓		✓		✓	✓	✓	✓				✓		✓	✓			✓		✓	
<b>Manfredonia</b>																								
Manfredonia Port Authority				✓							✓		✓											✓
<b>Palermo</b>																								
Palermo Port Authority	✓			✓				✓																✓
<b>Piazzale Cabato</b>																								
Gaeta Port Authority				✓		✓					✓		✓										✓	✓
<b>Piombino</b>																								
TOP - Terminal Offshore																								
Piombino	✓							✓														✓		
<b>Piombino (LI)</b>																								
Autorità Portuale di Piombino	✓							✓	✓														✓	✓
<b>Porto Torres</b>																								
Porto Torres Port Authority											✓													✓
<b>Ravenna</b>																								
Ravenna Port Authority	✓	✓	✓	✓	✓	✓	✓	✓			✓			✓	✓	✓	✓	✓			✓	✓		
<b>Sant Antioco</b>																								
Sant Antioco Port Authority	✓																							
<b>Savona</b>																								
Port Authority of Savona	✓		✓	✓		✓	✓				✓				✓	✓					✓	✓	✓	✓
<b>Savona</b>																								
Authorita Potuale di Savona				✓																				
<b>Sicily</b>																								
Siracusa Port Authority				✓																				
<b>Torre Annunziata (NA)</b>																								
SOLACEM Spa				✓	✓	✓				✓	✓			✓	✓				✓	✓	✓	✓	✓	✓
<b>Trieste</b>																								
Trieste Port, Pier 7																								
<b>Trieste</b>																								
Port of Trieste				✓				✓	✓													✓		
<b>Vado Ligure (SV)</b>																								
Terminal Rinfuse Vado	✓																							
<b>Venezia</b>																								
T.M.B SRL Venezia				✓																				
<b>Venice</b>																								
Port of Venice Marghera	✓			✓																				
<b>Venice</b>																								
Port Authority of Venice																						✓		
<b>IVORY COAST</b>																								
<b>Abidjan</b>																								
Port Autonome d'Abidjan									✓		✓													
<b>JAMAICA</b>																								
<b>Kingston</b>																								
Kingston Port Authority				✓		✓						✓												
<b>Kingston</b>																								
Port of Port Rhoades									✓															
<b>Kingston</b>																								
Port Kaiser									✓															
<b>Kingston</b>																								
Port Authority of Jamaica																								
<b>Saint Ann's Bay</b>																								
Ocho Rios Port									✓					✓										
<b>St Catherine</b>																								
Port Esquivel				✓	✓	✓				✓	✓		✓		✓	✓		✓	✓		✓	✓	✓	✓
<b>St Catherine</b>																								
West Indies Alumina Company				✓	✓	✓				✓	✓		✓		✓	✓		✓			✓	✓	✓	✓
<b>JAPAN</b>																								



COMMODITIES	CL	CC	PC	G-A	AF	CM	CLK	IO	BX	AL	FR	G-FGD	AG	SU	SOY	SODA	MIN	CHEM	BC	FRS	STL	P&P	MB	OTH
<b>Akigun</b>																								
Port of Mitsukojima																								✓
<b>Akita City</b>																								
Port of Akita				✓		✓		✓	✓		✓	✓	✓								✓		✓	✓
<b>Anan City</b>																								
Port of Anan											✓													✓
<b>Aomori</b>																								
Port of Hachinohe	✓			✓		✓		✓													✓			
<b>Aomori</b>																								
Port of Aomori																							✓	✓
<b>Chiba City</b>																								
Chiba Port				✓		✓		✓						✓				✓			✓			
<b>Chiba-City</b>																								
Kisarazu Port	✓		✓					✓	✓				✓									✓	✓	✓
<b>Chiyoda-ku</b>																								
Idemitsu Bulk Terminal-Chiba	✓																							
<b>Fukuoko City</b>																								
Hakata Port & Harbour Bureau				✓										✓										
<b>Hakodate</b>																								
Hakodate Port and Airport Department	✓			✓	✓	✓	✓				✓	✓	✓	✓				✓	✓	✓	✓	✓	✓	✓
<b>Handa City</b>																								
Port of Kinuura				✓										✓									✓	✓
<b>Hiroshima</b>																								
Port of Takehara No 1P/S	✓																							
<b>Hiroshima</b>																								
Kure Port Authority	✓							✓	✓															
<b>Hiroshima</b>																								
Fukuyama Port Authority	✓							✓															✓	✓
<b>Hiroshima</b>																								
Hiroshima Port Authority	✓			✓																				
<b>Hokkaido</b>																								
Tomato Coal Center	✓																							
<b>Ibaraki</b>																								
Hitachi Port Authority	✓																							✓
<b>Iymishima City</b>																								
Port of Mishima-Kawanoe	✓			✓																				
<b>Kagoshima City</b>																								
Port of Kagoshima				✓																				✓
<b>Kagoshima City</b>																								
Pacific Grain Terminal				✓																				
<b>Kakogawa City</b>																								
Higashi-Harima Port Authority	✓							✓	✓													✓	✓	
<b>Kamisu-City</b>																								
Kanto Grain Terminal Co. Ltd				✓																				
<b>Kanda-Machi</b>																								
Kanda Port						✓																		✓
<b>Kasaoka City</b>																								
Kasaoka Port																						✓	✓	✓
<b>Kawasaki City</b>																								
Port of Kawasaki	✓			✓				✓	✓													✓	✓	✓
<b>Kitakyushu City</b>																								
Port of Hibikinade												✓												
<b>Kitakyushu City</b>																								
Kitakyushu Port & Harbour Authority	✓							✓														✓		
<b>Kitakyushu City</b>																								
Port of Kokura	✓							✓																
<b>Kitakyushu City</b>																								
Port of Yawata																						✓		✓
<b>Kitakyushu City</b>																								
Yawata Hibikinada	✓					✓																		
<b>Kobe</b>																								
Port of Kobe	✓	✓	✓	✓	✓	✓	✓	✓	✓	✓	✓	✓	✓	✓	✓	✓	✓	✓	✓	✓	✓	✓	✓	✓
<b>Kobe</b>																								
Amagasaki Port Authority	✓							✓	✓													✓	✓	✓
<b>Kobe</b>																								
Port Authority of Himeji																								✓
<b>Kochi City</b>																								
Port of Kochi	✓																							✓
<b>Komatsushima City</b>																								
Port of Tokushima Komatsushima						✓																		
<b>Kurashiki City</b>																								
Mizushima Port Authority	✓			✓				✓															✓	✓

# COMMODITIES HANDLED

COMMODITIES	CL	CC	PC	G-A	AF	CM	CLK	IO	BX	AL	FR	G-FGD	AG	SU	SOY	SODA	MIN	CHEM	BC	FRS	STL	P&P	MB	OTH	
<b>Kushiro City</b>																									
Kushiro Port Authority	✓			✓		✓															✓				
<b>Maizuru City</b>																									
Maizuru Port Authority																									✓
<b>Marugame City</b>																									
Port of Marugame				✓																					
<b>Minatoku</b>																									
Niihama Coal Centre	✓																								
<b>Moji-ku Kitakyushu City</b>																									
Moji Port Authority	✓			✓		✓		✓			✓													✓	
<b>Moji-ku Kitakyushu City</b>																									
Port of Tobata	✓							✓	✓																
<b>Morioka</b>																									
Port of Kamaishi	✓			✓				✓																	
<b>Morioka</b>																									
Port of Ofunato	✓			✓		✓		✓				✓													✓
<b>Mubanti</b>																									
Shukuzu Coal Centre	✓																								
<b>Muroran City</b>																									
Muroran Port Authority	✓							✓	✓													✓			
<b>Nagasaki City</b>																									
Port of Matsushima																									✓
<b>Nagoya</b>																									
Gamagori Port Authority																									✓
<b>Niigata City</b>																									
Port of Niigata	✓																								
<b>Niihama City</b>																									
Port of Niihama	✓								✓																✓
<b>Oita City</b>																									
Port of Oita	✓							✓																	
<b>Osaka City</b>																									
Port of Osaka	✓			✓	✓	✓		✓															✓	✓	
<b>Otaru City</b>																									
Port of Otaru				✓		✓		✓	✓																
<b>Sakaide City</b>																									
Sakaide Port Administration	✓			✓	✓				✓																
<b>Sakaide City</b>																									
Sakaide Port Administration				✓																					
<b>Sasebo City</b>																									
Port of Sasebo				✓																					
<b>Schimonoseki City</b>																									
Shimonoseki Port & Harbour Bureau				✓							✓										✓	✓			
<b>Sendai</b>																									
Port of Ishinomaki	✓			✓							✓														
<b>Sendai</b>																									
Port of Sendai	✓			✓																				✓	
<b>Shibushi-shi</b>																									
Port of Shibushi				✓		✓																			
<b>Shizuoka City</b>																									
Port Authority of Shimizu	✓			✓	✓	✓	✓	✓	✓	✓	✓	✓	✓	✓	✓	✓	✓	✓	✓	✓	✓	✓	✓	✓	✓
<b>Shizuoka City</b>																									
Port of Tagonoura				✓																	✓				
<b>Takamatsu City</b>																									
Naoshima Port Authority								✓																	
<b>Tokuyama City</b>																									
Tokuyama Port Authority						✓		✓	✓		✓														
<b>Tokuyama City</b>																									
Tonda Port Authority																									✓
<b>Tokyo</b>																									
Tokyo Metropolitan Government	✓			✓		✓															✓	✓	✓		✓
<b>Tomakomai City</b>																									
Tomakomai Port Authority	✓			✓		✓		✓			✓														✓
<b>Toyama City</b>																									
Toyama Port Authority						✓																			
<b>Toyama City</b>																									
Toyama-Shinko Public Berths	✓																								
<b>Tsuruga City</b>																									
Tsuruga Port Authority	✓					✓					✓	✓													
<b>Ube City</b>																									
Port of Ube, Okinoyama																									
Coal Terminal	✓																								
<b>Usui City</b>																									
Tsukumi Port Authority	✓					✓																			✓



COMMODITIES	CL	CC	PC	G-A	AF	CM	CLK	IO	BX	AL	FR	G-FGD	AG	SU	SOY	SODA	MIN	CHEM	BC	FRS	STL	P&P	MB	OTH	
<b>Wakayama City</b>																									
Wakayama Port Authority	✓							✓																	
<b>Wakayama City</b>																									
Smikin Transport Service	✓																								
<b>Yatsushiro City</b>																									
Yatsushiro Port Office																								✓	
<b>Yokkaichi City</b>																									
Chubu Coal Centre	✓																								
<b>Yokohama</b>																									
Port of Yokohama	✓			✓		✓		✓	✓					✓											✓
<b>JERSEY</b>																									
<b>St Hellier</b>																									
Induvac						✓																			
<b>JORDAN</b>																									
<b>Aqaba</b>																									
The Ports Corporation Aqaba				✓		✓					✓														
<b>KENYA</b>																									
<b>Mombasa</b>																									
Port of Mombasa	✓			✓		✓					✓			✓											
<b>Mombasa</b>																									
Kenya Ports Authority	✓			✓	✓	✓	✓	✓	✓		✓	✓	✓	✓						✓	✓	✓	✓	✓	
<b>Mombasa</b>																									
Grain Bulk Handlers Ltd				✓																					
<b>KIRIBATI</b>																									
<b>Betio</b>																									
Kiribati Ports Authority											✓														
<b>KUWAIT</b>																									
<b>Safat</b>																									
Shuwaikh Port				✓		✓																			
<b>Safat</b>																									
Shuaiba Port				✓		✓		✓			✓														✓
<b>LATVIA</b>																									
<b>Liepaja</b>																									
Liepaja Port Authority													✓												
<b>Liepaja</b>																									
Liepaja Special Economic Zone Authority SEZ				✓																					
<b>Riga</b>																									
Riga Central Terminal	✓	✓	✓	✓	✓			✓			✓			✓	✓				✓		✓	✓			✓
<b>Riga</b>																									
WT Terminal Ltd											✓		✓			✓				✓	✓	✓	✓	✓	✓
<b>Riga</b>																									
Freeport of Riga Authority	✓			✓							✓			✓						✓				✓	
<b>Ventspils</b>																									
Free Port of Ventspils Authority	✓			✓				✓			✓			✓						✓	✓		✓	✓	✓
<b>Ventspils</b>																									
JSC BALTIC COAL TERMINAL	✓																								
<b>Ventspils</b>																									
Ventspils Grain Terminal				✓																					
<b>Ventspils</b>																									
AS Ventspils Tirdzniecibas Osta	✓																								
<b>Ventspils</b>																									
Kalija Parks											✓														
<b>LEBANON</b>																									
<b>Beirut</b>																									
Chekaa Bay						✓																			
<b>Beirut</b>																									
Port Authority of Selaata				✓																					
<b>Tripoli</b>																									
Tripoli Port Authority				✓																					
<b>LIBERIA</b>																									
<b>Monrovia</b>																									
National Port Authority																									
<b>Monrovia</b>																									
Monrovia Port								✓																	
<b>Robertsonfield</b>																									
Buchanan Port Authority								✓																	

# COMMODITIES HANDLED

COMMODITIES	CL	CC	PC	G-A	AF	CM	CLK	IO	BX	AL	FR	G-FGD	AG	SU	SOY	SODA	MIN	CHEM	BC	FRS	STL	P&P	MB	OTH	
<b>LITHUANIA</b>																									
<b>Klaipeda</b>																									
Vakaru krova, UAB																									
<b>Klaipeda</b>																									
BEGA, Stevedoring Company				✓	✓	✓	✓			✓	✓		✓	✓	✓	✓	✓		✓	✓		✓	✓	✓	✓
<b>Klaipeda</b>																									
State Enterprise Klaip da State Seaport Authority				✓	✓	✓	✓	✓			✓			✓	✓	✓	✓		✓	✓	✓	✓	✓	✓	✓
<b>Klaipeda</b>																									
Joint-Stock Stevedoring Company				✓																					✓
<b>Klaipeda</b>																									
Klaipeda Stevedoring Company (KLASCO)				✓	✓		✓	✓	✓		✓	✓	✓	✓	✓						✓	✓	✓	✓	✓
<b>LUXEMBOURG</b>																									
<b>Luxembourg</b>																									
Euroports Holdings S.a.r.l.	✓	✓	✓	✓		✓	✓	✓																	
<b>MADAGASCAR</b>																									
<b>Toamasina</b>																									
Societe d'Exploitation du Port de Toamasina																									
<b>MALAYSIA</b>																									
<b>Butterworth</b>																									
Penang Port SDN BHD				✓							✓														
<b>Johor</b>																									
Bulk & Breakbulk Terminal				✓																					
<b>Johor Baharu</b>																									
Johor Port BERHAD				✓	✓	✓	✓	✓			✓	✓		✓								✓		✓	
<b>Kota Kinabalu</b>																									
Sabah Ports Authority				✓							✓														✓
<b>Kuantan</b>																									
Kuantan Port Authority																									
<b>Kuantan</b>																									
Lembaga Pelabuhan Kuantan		✓		✓				✓			✓	✓									✓	✓			
<b>Kuantan</b>																									
Kuantan Port Consortium																									
Son Bhd	✓			✓	✓		✓	✓			✓	✓											✓		✓
<b>Labuan</b>																									
Labuan Port Authority				✓				✓																	
<b>Malacca</b>																									
Malacca Port Authority				✓																					✓
<b>Miri</b>																									
Miri Port Authority				✓	✓	✓	✓			✓	✓	✓		✓	✓	✓	✓	✓	✓		✓	✓	✓	✓	✓
<b>Penang</b>																									
Prai Bulk Cargo Terminal				✓																					
<b>Penang</b>																									
Penang Port Sdn Bhd (PPSB)	✓			✓							✓														
<b>Penang</b>																									
Penang Port SDN BHD																									
<b>Port Kelang</b>																									
West Fertilizer Terminal Sdn Bhd											✓														
<b>Port Klang</b>																									
Port Klang Authority	✓	✓	✓	✓	✓	✓	✓	✓	✓	✓	✓	✓		✓	✓	✓							✓		
<b>Port Klang</b>																									
Northport (Malaysia) Bhd.																									
<b>Pulau Indah</b>																									
Westports Malaysia Sdn Bhd	✓			✓							✓														
<b>Sandakan</b>																									
Sandakan Port Authority																									✓
<b>Seri Manjung</b>																									
Lumut Maritime Terminal Sdn Bhd	✓																								
<b>Sibu</b>																									
Rajang Port Authority	✓																								
<b>Terengganu Darul Iman</b>																									
Kemaman Port Authority																									✓
<b>Utara</b>																									
Kelang Port Management	✓			✓																					
<b>MALTA</b>																									
<b>Marsa</b>																									
Port of Valletta				✓	✓	✓		✓				✓		✓	✓					✓	✓	✓			
<b>Paola</b>																									
Kordin Grain Terminal Company Ltd				✓	✓																				



COMMODITIES	CL	CC	PC	G-A	AF	CM	CLK	IO	BX	AL	FR	G-FGD	AG	SU	SOY	SODA	MIN	CHEM	BC	FRS	STL	P&P	MB	OTH	
<b>Valletta</b>																									
Malta Maritime Authority				✓		✓							✓											✓	
<b>MAURITANIA</b>																									
<b>Nouadhibou</b>																									
Port Autonome de Nouadhibou																									
<b>MAURITIUS</b>																									
<b>Port Louis</b>																									
Mauritius Ports Authority	✓			✓	✓	✓					✓		✓	✓	✓						✓	✓	✓	✓	✓
<b>MEXICO</b>																									
<b>Acapulco</b>																									
Port Authority of Acapulco																									
<b>Altamira</b>																									
Industrial Port of Altamira				✓													✓				✓				
<b>Altamira</b>																									
Cooper/T. Smith De Mexico SA de CV	✓																								
<b>Altamira</b>																									
Terminal Maritima de Altamira, SA de CV				✓													✓								
<b>Chiapas</b>																									
Port Authority of Puerto Madero																								✓	
<b>Ensenada</b>																									
Port Authority of Ensenada						✓																			
<b>Garita de Otay</b>																									
Morro Redondo Port Authority																								✓	
<b>Guaymas</b>																									
Port Authority of Guaymas																								✓	
<b>La Paz</b>																									
San Juan de la Costa Port Authority											✓														
<b>Mazatlan</b>																									
Port Authority of Mazatlan				✓																				✓	
<b>Salina Cruz</b>																									
Port Authority of Salina Cruz				✓		✓																			
<b>San Carlos</b>																									
San Carlos Port Authority				✓																					
<b>Tampico</b>																									
Port Authority of Tampico	✓			✓		✓						✓													
<b>Topolobampo</b>																									
Topolobampo Port Authority						✓					✓														
<b>Veracruz</b>																									
Port Authority of Veracruz				✓		✓			✓		✓			✓											
<b>MOROCCO</b>																									
<b>Casablanca</b>																									
Office d'Exploitation des Ports																									
<b>Casablanca</b>																									
Port Nador				✓																					
<b>El Jadida</b>																									
Jorf Lasfar Power Station	✓										✓														
<b>El Jadida</b>																									
Agence Nationale Des Ports	✓			✓		✓					✓														
<b>Kenitra</b>																									
Port of Kenitra				✓																					
<b>Tangier</b>																									
Port of Tangier				✓																					
<b>MOZAMBIQUE</b>																									
<b>Beira</b>																									
Largo dos CFM-C	✓							✓																	
<b>Beira</b>																									
Cornelder de Moçambique, s.a.r.l																									
<b>Maputo</b>																									
Grindrod Terminals - Maputo	✓							✓																	
<b>Maputo</b>																									
Portos e Caminhos De Ferro de Mozambique				✓					✓					✓											
<b>Maputo</b>																									
Mozambique Ports and Railways - CFM	✓			✓				✓						✓								✓		✓	
<b>Maputo</b>																									
Maputo Port Development Company SARL	✓		✓	✓		✓	✓	✓	✓	✓	✓	✓	✓	✓	✓	✓	✓	✓	✓	✓	✓	✓	✓	✓	

# COMMODITIES HANDLED

COMMODITIES	CL	CC	PC	G-A	AF	CM	CLK	IO	BX	AL	FR	G-FGD	AG	SU	SOY	SODA	MIN	CHEM	BC	FRS	STL	P&P	MB	OTH
<b>Matola</b>																								
Stema SA				✓	✓											✓								
<b>Nacala</b>																								
Nacala Port Authority				✓							✓													
<b>MYANMAR</b>																								
<b>Yangon</b>																								
Yangon Port Authority	✓			✓																				
<b>NAMIBIA</b>																								
<b>Walvis Bay</b>																								
Namibian Ports Authority	✓			✓				✓	✓									✓					✓	✓
<b>Walvis Bay</b>																								
Namport																								
<b>Walvis Bay</b>																								
Grindrod Terminals - Walvis Bay																							✓	
<b>NAURU</b>																								
<b>Aiwo</b>																								
Nauru Port Authority											✓													
<b>NETHERLANDS ANTILLES</b>																								
<b>Bonaire</b>																								
Bonaire Pilots				✓																				✓
<b>NEW CALEDONIA</b>																								
<b>Houailou</b>																								
Societe des Mines du Cap Bocage																							✓	
<b>NEW CALEDONIA</b>																								
<b>Noumea</b>																								
Port Authority of New Caledonia	✓			✓				✓				✓												✓
<b>NEW ZEALAND</b>																								
<b>Auckland</b>																								
NZ Stevedoring Co Ltd																								
<b>Auckland</b>																								
Onehunga Port Authority																								✓
<b>Auckland</b>																								
Ports of Auckland Limited	✓			✓	✓	✓						✓	✓	✓	✓	✓					✓	✓	✓	✓
<b>Bluff</b>																								
South Port NZ Ltd	✓	✓	✓	✓	✓	✓				✓	✓										✓			✓
<b>Gisborne</b>																								
Port Gisborne Ltd						✓					✓													
<b>Lyttelton</b>																								
Lyttelton Coal Terminal	✓																							
<b>Mount Maunganui</b>																								
NZL Group Limited t/a NZ Marshalling & Stevedoring																								
<b>Napier</b>																								
Port of Napier Ltd						✓					✓								✓	✓	✓	✓		
<b>New Plymouth</b>																								
Port Taranaki Limited	✓			✓	✓	✓					✓				✓						✓			
<b>Port Chalmers</b>																								
Port Otago Ltd				✓		✓					✓										✓			
<b>Ruakaka</b>																								
North Port Ltd	✓			✓	✓	✓					✓	✓	✓						✓	✓	✓	✓	✓	✓
<b>Tauranga</b>																								
C3 Limited (previously Toll Owens Ltd)	✓			✓	✓						✓	✓							✓	✓	✓	✓	✓	✓
<b>Tauranga</b>																								
Port of Tauranga Ltd	✓	✓		✓	✓	✓	✓				✓	✓		✓	✓	✓		✓	✓	✓	✓	✓	✓	✓
<b>Timaru</b>																								
PrimePort Timaru				✓							✓			✓										
<b>Wanganui</b>																								
Wanganui Port Authority				✓							✓		✓								✓			✓
<b>Wellington</b>																								
Port of Wellington				✓							✓		✓											
<b>Westport</b>																								
Westport Harbour	✓					✓	✓				✓	✓							✓					
<b>NICARAGUA</b>																								
<b>Managua</b>																								
Empresa Portuaria Nacional (EPN)																								
<b>Sandino</b>																								
Port Sandino											✓													



COMMODITIES	CL	CC	PC	G-A	AF	CM	CLK	IO	BX	AL	FR	G-FGD	AG	SU	SOY	SODA	MIN	CHEM	BC	FRS	STL	P&P	MB	OTH
<b>NIGERIA</b>																								
<b>Lagos</b>																								
Nigerian Ports Authority Plc	✓					✓					✓													
<b>Lagos</b>																								
Lagos/Apapa	✓			✓							✓													✓
<b>Port Harcourt</b>																								
Nigerian Ports Plc																								
<b>Port Harcourt</b>																								
Port Harcourt	✓																							
<b>NORWAY</b>																								
<b>Brevik</b>																								
Grenland Port Authority	✓																							
<b>Drummen</b>																								
Port Authority of Drammen				✓																				
<b>Farsund</b>																								
Elkem Aluminium Lista									✓															
<b>Floro</b>																								
Port Authority of Floro																								
<b>Glomfjord</b>																								
Port Authority of Glomfjord											✓													
<b>Husnes</b>																								
Aluminium Works Terminal									✓															
<b>Kirkenes</b>																								
Port of Kirkenes								✓																
<b>Kristiansund</b>																								
Kristiansund and Nordmøre																								
Port Authority																								✓
<b>Larvik</b>																								
Larvik Port Authority								✓																✓
<b>Mo I Rana</b>																								
Mo I Rana Port Authority	✓		✓					✓	✓															✓
<b>Mosjoen</b>																								
Mosjoen Port Authority									✓															
<b>Moss</b>																								
Port Authority of Moss				✓																				
<b>Narvik</b>																								
Narvik Port Authority								✓																✓
<b>Narvik</b>																								
LKAB								✓									✓							
<b>Orkanger</b>																								
Port of Orkanger								✓																✓
<b>Ovre</b>																								
Aardalstangen			✓							✓														
<b>Sauda</b>																								
Sauda Port Authority								✓	✓															
<b>Sentrum</b>																								
Oslo Port Authority				✓		✓					✓			✓			✓				✓			
<b>Stavanger</b>																								
Stavanger Havnesilo				✓																				
<b>Stavanger</b>																								
Port Authority of Stavanger				✓																				✓
<b>Sundalsora</b>																								
Hydro Aluminium Sunndal A/S			✓							✓														
<b>Sundalsora</b>																								
Hydro Aluminium Private Terminal									✓															
<b>Svolvaer</b>																								
Vagan																								✓
<b>OMAN</b>																								
<b>Muscat</b>																								
Port Sultan Qaboos			✓	✓		✓	✓				✓			✓		✓			✓	✓	✓	✓	✓	✓
<b>PAKISTAN</b>																								
<b>Karachi</b>																								
Pak Shaheen Group	✓	✓	✓	✓				✓			✓													
<b>Karachi</b>																								
Bulk Trade International																								
<b>Karachi</b>																								
Port Muhammad Bin Qasim	✓			✓		✓	✓	✓			✓			✓										
<b>PAPUA NEW GUINEA</b>																								
<b>Alotau</b>																								
Alotau Port Authority																								✓
<b>Kavieng</b>																								
Kavieng Port Authority																								✓

# COMMODITIES HANDLED

COMMODITIES	CL	CC	PC	G-A	AF	CM	CLK	IO	BX	AL	FR	G-FGD	AG	SU	SOY	SODA	MIN	CHEM	BC	FRS	STL	P&P	MB	OTH
<b>Kimbe</b>																								
Kimbe Port Authority																								✓
<b>Kimbe</b>																								
Kieta Port Authority																								✓
<b>Lae</b>																								
Lae Port Authority																								✓
<b>Lae</b>																								
PNG Ports Corporation Limited				✓	✓	✓	✓				✓		✓	✓							✓	✓	✓	✓
<b>Popondetta</b>																								
Oro Bay Port Authority																								✓
<b>Rabaul</b>																								
Rabaul Port Authority																								✓
<b>PERU</b>																								
<b>Arequipa</b>																								
Terminal Internacional del Sur SA																								
<b>Callao</b>																								
Conchan Port Authority							✓																	
<b>Callao</b>																								
ENAPU SA	✓																							
<b>Chancy</b>																								
Chancay Port Authority																								✓
<b>Ilo</b>																								
Agencia Maritima Busonich																								✓
<b>Iquitos</b>																								
Iquitos Port Authority					✓																			
<b>La Caleta</b>																								
Port Authority of Chimbote	✓			✓	✓				✓	✓		✓												✓
<b>La Perla</b>																								
Autoridad Portuaria Nacional																								
<b>Moquegua</b>																								
ILO Port Terminal	✓																							
<b>Pisco</b>																								
General San Martin Port Authority					✓							✓												
<b>Supe Puerto</b>																								
Supe Port Authority					✓																			
<b>Trujillo</b>																								
ENAPU SA	✓																							
<b>PHILIPPINES</b>																								
<b>Batangas City</b>																								
Batangas Port Authority	✓																							✓
<b>Cagayan de Oro City</b>																								
Masao Port Authority					✓							✓		✓										✓
<b>Cagayan de Oro City</b>																								
Philippine Ports Authority					✓							✓		✓								✓		✓
<b>Cebu City</b>																								
Cebu Port Authority																								✓
<b>Iligan City</b>																								
Iligan Port Authority																								✓
<b>Iloilo City</b>																								
Iloilo Port Management Office																								✓
<b>Jolo Sulu</b>																								
Jolo Port Authority					✓																			
<b>La Union</b>																								
San Fernando Port Authority																								✓
<b>Legazpi City</b>																								
Lagazpi Port Management Authority					✓																			
<b>Makati City</b>																								
Mariveles Port-Smithbell & Co					✓																			
<b>Makati City</b>																								
Wilhelmsen-Smith Bell Shipping, Inc.	✓			✓	✓	✓	✓	✓	✓	✓	✓	✓	✓	✓	✓	✓	✓	✓	✓	✓	✓	✓	✓	✓
<b>Manila</b>																								
Asian Terminals Incorporated					✓																			
<b>Manila</b>																								
Mariveles Grain Terminal (MGT)					✓																			
<b>Manila</b>																								
Philippine Ports Authority												✓												
<b>Tacloban</b>																								
Philippine Ports Authority				✓	✓						✓		✓	✓								✓	✓	✓
<b>POLAND</b>																								
<b>Gdansk</b>																								
Port of Gdansk Authority SA	✓	✓	✓	✓	✓	✓	✓	✓	✓	✓	✓	✓	✓	✓	✓	✓	✓	✓	✓	✓	✓	✓	✓	✓



COMMODITIES	CL	CC	PC	G-A	AF	CM	CLK	IO	BX	AL	FR	G-FGD	AG	SU	SOY	SODA	MIN	CHEM	BC	FRS	STL	P&P	MB	OTH
<b>Gdansk</b>																								
Port Polnocny SEA-invest	✓							✓																✓
<b>Gdansk</b>																								
PPS Port Polnocny Co Ltd	✓																							
<b>Gdynia</b>																								
BTDG - Baltic General Cargo																								
Terminal Gdynia Ltd											✓										✓			
<b>Gdynia</b>																								
Baltic Grain Terminal				✓	✓																			
<b>Gdynia</b>																								
Maritime Bulk Terminal Gdynia Ltd	✓	✓	✓	✓	✓		✓	✓	✓	✓	✓		✓	✓	✓				✓				✓	✓
<b>Gdynia</b>																								
Rudoport SA	✓	✓						✓					✓											
<b>Gdynia</b>																								
Port of Gdynia	✓	✓						✓	✓		✓													
<b>Gdynia</b>																								
Baltic Ports Organization Secretariat																								
<b>Gdynia</b>																								
Baltic Bulk Terminal Ltd											✓													
<b>Kolobrzeg</b>																								
Port Authority of Kolobrzeg																								
<b>Police</b>																								
Port Police											✓													✓
<b>Swinoujscie</b>																								
Port Handlowy Swinoujscie Sp.	✓	✓	✓	✓	✓	✓	✓	✓	✓	✓	✓	✓	✓	✓	✓	✓	✓	✓	✓	✓	✓	✓	✓	✓
<b>Szczecin</b>																								
Bulk Cargo - Port Szczecin Sp.	✓	✓	✓	✓	✓	✓	✓	✓	✓	✓	✓		✓		✓		✓	✓			✓		✓	
<b>Szczecin</b>																								
Andreas sp. z o.o.				✓																				
<b>Szczecin</b>																								
Szczecin and Swinoujscie Seaports Authority	✓	✓	✓	✓	✓	✓	✓		✓	✓	✓	✓	✓	✓	✓	✓	✓	✓		✓	✓	✓	✓	✓
<b>Szczecin</b>																								
Przedsiębiorstwo Usług Portowych				✓																				
<b>Szczecin</b>																								
Rolsped Sp. Ltd				✓																				
<b>PORTUGAL</b>																								
<b>Aveiro</b>																								
Socarpor (Aveiro) SA				✓		✓	✓				✓						✓			✓	✓	✓	✓	
<b>Barreiro</b>																								
Barreiro Terminal - Atlanport	✓							✓			✓						✓				✓		✓	✓
<b>Funchal</b>																								
Port Authority of Maderia				✓																				
<b>Gafanha da Nazaré</b>																								
APA - Administração do Porto de Aveiro, S.A.				✓		✓					✓										✓			✓
<b>Leca da Palmeira</b>																								
Port Authority of Leixoes				✓						✓											✓	✓		
<b>Lisbon</b>																								
Silopor - Empresa de Silos Portuários, S.A				✓																				
<b>Lisbon</b>																								
Iberol - Sociedade Iberica de Biocombustíveis				✓												✓								✓
<b>Lisbon</b>																								
Poço Bispo Multipurpose Terminal - TMPB	✓			✓	✓	✓	✓				✓			✓	✓				✓	✓	✓	✓	✓	✓
<b>Lisbon</b>																								
Sovena - Oilseeds Portugal, SA				✓	✓											✓								✓
<b>Lisbon</b>																								
Silopor - Empresa De Silos Portuários, SA				✓	✓											✓								✓
<b>Lisbon</b>																								
TPB - SILOPOR SA										✓				✓					✓	✓	✓	✓	✓	✓
<b>Lisbon</b>																								
Lisbon Port Authority	✓			✓		✓		✓	✓		✓													
<b>Lisbon</b>																								
APL - Administration of Port of Lisbon				✓																				
<b>Setubal</b>																								
Junta Autonoma Do Porto De Setubal	✓			✓							✓													

# COMMODITIES HANDLED

COMMODITIES	CL	CC	PC	G-A	AF	CM	CLK	IO	BX	AL	FR	G-FGD	AG	SU	SOY	SODA	MIN	CHEM	BC	FRS	STL	P&P	MB	OTH
<b>Setubal</b>																								
Sadomar																								
<b>Sines</b>																								
Porto de Sines SA	✓																							
<b>Trafaria</b>																								
Trafaria Terminal - Silopor				✓																				
<b>Vila Franca de Xira</b>																								
Alhandra Terminal- Cimpor industria de Cimentos SA						✓	✓																	✓
<b>PUERTO RICO</b>																								
<b>San Juan</b>																								
Puerto Rico Port Authority				✓																				
<b>San Juan</b>																								
Port of Ponce	✓																							
<b>QATAR</b>																								
<b>Doha</b>																								
Qatar Flour Mills Co				✓																				
<b>Doha</b>																								
Umm Said Ports Authority				✓		✓		✓			✓													✓
<b>REPUBLIC OF GUINEA</b>																								
<b>Conakry</b>																								
Direction du Port de Kamsar									✓															
<b>Conakry</b>																								
Conakry Port Authority				✓				✓	✓														✓	
<b>Conakry</b>																								
Port Autonome de Conakry				✓				✓	✓															
<b>REPUBLIC OF YEMEN</b>																								
<b>Hodeidah</b>																								
Hodeidah Port				✓																				
<b>REUNION</b>																								
<b>Le Port Cedex, Reunion</b>																								
Direction Departementale de L'Equipment																								
<b>ROMANIA</b>																								
<b>Agigea</b>																								
Silotrans SRL																								
<b>Braila</b>																								
Braila Port Authority				✓		✓		✓			✓													✓
<b>Constanta</b>																								
SC Silotrans Srl																								
<b>Constanta</b>																								
SC MINMETAL SA																								
Constanta / Romania	✓			✓				✓	✓					✓								✓		
<b>Constanta</b>																								
Convex SA	✓	✓	✓				✓	✓	✓		✓						✓							✓
<b>Constantza</b>																								
Sicim SA						✓																		
<b>Constantza</b>																								
Constantza Port Administration	✓	✓		✓				✓			✓													
<b>Sulina</b>																								
Sulina Free Zone Administration											✓													✓
<b>RUSSIA</b>																								
<b>Arkangelsk</b>																								
Port of Arkangelsk				✓							✓											✓	✓	
<b>Kaliningrad</b>																								
Transmarine																					✓	✓		
<b>Moscow</b>																								
Port Management Company Ltd	✓	✓																						
<b>Murmansk</b>																								
Port of Murmansk Authority	✓							✓	✓		✓													✓
<b>Nakhodka</b>																								
VP- Vostochny Port	✓						✓	✓			✓		✓								✓	✓		
<b>Nakhodka</b>																								
Nakhodka Port Authority	✓			✓		✓		✓	✓		✓												✓	✓
<b>Novorossiysk</b>																								
Novorossiysk Port Authority	✓			✓		✓		✓						✓									✓	
<b>St Petersburg</b>																								
Seaport of St Petersburg JSC				✓	✓					✓	✓				✓	✓			✓	✓	✓	✓	✓	✓
<b>Tuapse</b>																								
Port of Tuapse Authority	✓																							



COMMODITIES	CL	CC	PC	G-A	AF	CM	CLK	IO	BX	AL	FR	G-FGD	AG	SU	SOY	SODA	MIN	CHEM	BC	FRS	STL	P&P	MB	OTH	
<b>Uglegorsk</b>																									
Uglegorsk Port Authority																									✓
<b>Vanino</b>																									
Vanino Commercial Sea Port, PJSC	✓																				✓				
<b>Vanino</b>																									
Vanino Port Authority	✓																								
<b>Vladivstok</b>																									
Vladivostok Port Authority	✓			✓		✓			✓		✓			✓											✓
<b>Vyborg</b>																									
Port of Vyborg Authority	✓							✓	✓				✓	✓											✓
<b>SAUDI ARABIA</b>																									
<b>Dammam</b>																									
King Abdul Aziz Port Authority-Dammam				✓		✓		✓	✓		✓														
<b>Dammam</b>																									
Ras Al Mishab						✓																			
<b>Dammam</b>																									
Arabian Agricultural Services (ARASCO)				✓																					
<b>Jeddah</b>																									
AJWA Port Services Co.			✓	✓	✓	✓	✓	✓			✓	✓	✓		✓	✓	✓	✓	✓	✓	✓	✓	✓	✓	✓
<b>Jeddah</b>																									
Jeddah Islamic Port				✓	✓	✓	✓				✓			✓	✓			✓	✓	✓	✓	✓	✓		✓
<b>Jizan</b>																									
Jizan Port Management				✓		✓								✓											
<b>Yanbu</b>																									
Yanbu Commercial Port			✓	✓		✓																			
<b>SENEGAL</b>																									
<b>Dakar</b>																									
Port Autonome de Dakar																									
<b>SEYCHELLES</b>																									
<b>Victoria</b>																									
Seychelles Ports Authority						✓																			
<b>SIERRA LEONE</b>																									
<b>Cline Town</b>																									
Sierra Leone Port Authority				✓					✓																✓
<b>Freetown</b>																									
Pepel								✓																	
<b>Freetown</b>																									
Sierra Leone Ports Authority				✓																					
<b>SINGAPORE</b>																									
<b>Jurong</b>																									
Sembawang Terminal																						✓			✓
<b>Singapore</b>																									
Offshore Bulk Terminal Pte Ltd	✓							✓																	
<b>Singapore</b>																									
Sin Heng Chan (Singapore) Pte Ltd						✓																			
<b>Singapore</b>																									
LD Ports & Logistics	✓							✓																	
<b>Singapore</b>																									
Maritime and Port Authority of Singapore																									
<b>Singapore</b>																									
Jaldhi Overseas Pte Ltd																									
<b>Singapore</b>																									
Jurong Port Pte Ltd						✓	✓						✓										✓		✓
<b>SLOVENIA</b>																									
<b>Koper</b>																									
Luka Koper d.d.,Dry Bulk Cargo Terminal			✓	✓		✓	✓	✓	✓	✓	✓		✓	✓	✓	✓	✓	✓							
<b>SOUTH AFRICA</b>																									
<b>Bishopsgate</b>																									
South African Sugar Association													✓												
<b>Durban</b>																									
South African Sugar Association (Pty) Ltd													✓												
<b>Durban</b>																									
South African Bulk Terminals LTD			✓	✓							✓		✓	✓	✓	✓	✓	✓							✓

# COMMODITIES HANDLED

COMMODITIES	CL	CC	PC	G-A	AF	CM	CLK	IO	BX	AL	FR	G-FGD	AG	SU	SOY	SODA	MIN	CHEM	BC	FRS	STL	P&P	MB	OTH	
<b>Durban</b>																									
Bidfreight Port Operations (Pty) Ltd				✓		✓		✓						✓							✓	✓	✓		✓
<b>Durban</b>																									
Grindrod Terminals - Maydon Wharf											✓									✓					
<b>Durban</b>																									
Transnet Port Terminals Head Office	✓			✓				✓					✓		✓								✓		✓
<b>Durban</b>																									
Bulk Connections			✓			✓	✓	✓			✓		✓											✓	✓
<b>East London</b>																									
S A Port Ops East London Grain Terminal				✓																					
<b>East London</b>																									
Transnet National Port Authority																									
<b>Johannesburg</b>																									
Anglo Coal	✓																								
<b>Johansberg</b>																									
National Ports Authority of South Africa (NPASA)				✓		✓							✓									✓			✓
<b>Meerensee</b>																									
Grindrod Terminals	✓	✓					✓						✓							✓				✓	✓
<b>Port Elizabeth</b>																									
Portnet Port Elizabeth								✓	✓															✓	✓
<b>Port Elizabeth</b>																									
Transnet Port Terminals				✓											✓							✓	✓	✓	✓
<b>Richards Bay</b>																									
Port of Richards Bay	✓						✓		✓		✓										✓	✓	✓	✓	
<b>Richards Bay</b>																									
Transnet Port Terminals	✓	✓	✓						✓	✓	✓										✓			✓	✓
<b>Richards Bay</b>																									
Richards Bay Coal Terminal	✓																								
<b>Saldanha</b>																									
Saldanha Bulk Terminal								✓																	
<b>Saldanha</b>																									
S A Port Ops																									
<b>SOUTH KOREA</b>																									
<b>Cheju</b>																									
Cheju Port Authority																									✓
<b>Donghae</b>																									
Mukho Port Authority	✓					✓																			✓
<b>Donghae City</b>																									
Donghae Port Authority	✓					✓			✓			✓													✓
<b>Inchon</b>																									
Korea Silo Company Pier 7				✓																					
<b>Jung-gu</b>																									
Incheon Port Authority	✓			✓																					
<b>Kunsan</b>																									
Changhang Port Authority																									✓
<b>Kunsan</b>																									
Kunsan Port Authority																									✓
<b>Masan-South</b>																									
Masan Port Authority																									✓
<b>Nam Ku</b>																									
Ulsan Port Authority	✓			✓		✓		✓			✓		✓												✓
<b>Pohang</b>																									
Pohang District Maritime & Port Authority	✓							✓																	
<b>Pohang</b>																									
Port of Pohang	✓																								
<b>Ulsan</b>																									
Port of Ulsan Public Piers 1&2	✓			✓		✓		✓			✓		✓												
<b>Yosu</b>																									
Yosu Port Authority	✓			✓							✓														
<b>Yosu</b>																									
Samil Port Authority											✓														
<b>SPAIN</b>																									
<b>Alcudia</b>																									
Port of Alcudia	✓					✓	✓																		
<b>Algeciras</b>																									
Port Authority of La Bahia de Algeciras	✓					✓																		✓	✓
<b>Alicante</b>																									
Port of Alicante	✓					✓		✓																	



COMMODITIES	CL	CC	PC	G-A	AF	CM	CLK	IO	BX	AL	FR	G-FGD	AG	SU	SOY	SODA	MIN	CHEM	BC	FRS	STL	P&P	MB	OTH
<b>Almeria</b>																								
Carboneras	✓		✓			✓		✓																✓
<b>Almeria</b>																								
Port of Almeria	✓																							
<b>Asturias</b>																								
Port Authority of Aviles	✓			✓				✓	✓		✓												✓	✓
<b>Barcelona</b>																								
Ergransa				✓																				
<b>Barcelona</b>																								
Moyresa Molturacion y Refino SA				✓																				
<b>Barcelona</b>																								
Ergransa Terminal				✓																				
<b>Barcelona</b>																								
Portcemen, SA						✓																		
<b>Barcelona</b>																								
Cemex España																								
<b>Barcelona</b>																								
Port of Barcelona	✓		✓	✓		✓	✓	✓	✓		✓			✓	✓		✓	✓		✓	✓	✓	✓	✓
<b>Barcelona</b>																								
Tramer SA											✓													
<b>Bilbao</b>																								
Autoridad Portuaria De Bilbao	✓		✓	✓	✓	✓	✓	✓	✓		✓				✓		✓	✓		✓	✓	✓	✓	✓
<b>Cadiz</b>																								
Cadiz Bay Port Authority	✓			✓		✓	✓				✓		✓	✓										✓
<b>Cartagena</b>																								
Port of Aguilas				✓		✓																		
<b>Cartagena</b>																								
Port Authority of Cartagena	✓		✓	✓	✓	✓	✓	✓			✓	✓	✓		✓	✓	✓	✓		✓	✓	✓	✓	✓
<b>Ferrol</b>																								
Port Authority of Ferrol – San Cibrao	✓					✓	✓	✓	✓	✓			✓				✓				✓	✓	✓	✓
<b>Ferrol</b>																								
Port Authority of Ferrol-San Ciprian	✓			✓							✓										✓		✓	
<b>Formentera</b>																								
Port of La Savina																								
<b>Garrucha</b>																								
Garrucha		✓										✓	✓											
<b>Gijón</b>																								
EBHI - European Bulk Handling Installation	✓	✓	✓					✓									✓							
<b>Gijón</b>																								
Port Authority of Gijon	✓	✓	✓	✓		✓	✓	✓			✓										✓	✓	✓	✓
<b>Huelva</b>																								
Port Authority of Huelva	✓										✓													✓
<b>Ibiza</b>																								
Port of Ibiza																								
<b>La Coruña</b>																								
T.M.G.A. SL	✓			✓							✓				✓						✓	✓		
<b>La Coruña</b>																								
Muelle del Centenario	✓																							
<b>La Coruña</b>																								
Port Authority of La Coruña	✓			✓	✓	✓	✓	✓		✓					✓							✓	✓	✓
<b>La Coruña</b>																								
Terminales Maritimos de Galicia, S.L.	✓	✓	✓	✓	✓	✓	✓	✓	✓	✓	✓	✓	✓	✓	✓	✓	✓	✓			✓	✓	✓	✓
<b>Los Barrios</b>																								
Endesa	✓							✓	✓															
<b>Madrid</b>																								
Puertos del Estado																								
<b>Madrid</b>																								
Ership S.A.U				✓																				
<b>Mahon</b>																								
Port of Mahon						✓																		
<b>Malaga</b>																								
Malaga Port Authority	✓	✓		✓		✓	✓				✓						✓				✓			✓
<b>Marin</b>																								
Ceferino Nogueira SA				✓																				
<b>Melilla</b>																								
Port Authority of Melilla						✓		✓	✓															
<b>Motril</b>																								
Port of Motril	✓			✓		✓	✓				✓						✓	✓	✓	✓	✓	✓	✓	✓
<b>Motril</b>																								
Motril Port - Granada																								

# COMMODITIES HANDLED

COMMODITIES	CL	CC	PC	G-A	AF	CM	CLK	IO	BX	AL	FR	G-FGD	AG	SU	SOY	SODA	MIN	CHEM	BC	FRS	STL	P&P	MB	OTH
<b>Palma</b>																								
Port of Palma				✓		✓					✓													✓
<b>Pasaia</b>																								
Port Authority of Pasaia	✓		✓	✓		✓		✓		✓	✓											✓	✓	✓
<b>Pto. Alcudia</b>																								
Transportes Maritimos																								
Alcudia, SA	✓																							
<b>Sagunto</b>																								
Port of Sagunto	✓					✓					✓													
<b>Santa Cruz de Tenerife</b>																								
Port Authority of Tenerife				✓		✓					✓													✓
<b>Santander</b>																								
Port Authority of Santander	✓			✓	✓	✓	✓	✓			✓			✓	✓		✓				✓	✓	✓	✓
<b>Santander</b>																								
Puerto de Santander	✓	✓	✓	✓	✓	✓		✓		✓	✓			✓	✓	✓	✓	✓	✓	✓	✓	✓	✓	✓
<b>Sevilla</b>																								
Port Authority of Sevilla	✓			✓																				
<b>Tarragona</b>																								
Berge Maritima				✓																				
<b>Tarragona</b>																								
Port Authority of Tarragona	✓		✓	✓	✓	✓	✓				✓				✓						✓	✓	✓	✓
<b>Tarragona</b>																								
Codemar-Iberbulk				✓																				✓
<b>Tarragona</b>																								
Silos de Tarragona SA (SITASA)				✓																				
<b>Tarragona</b>																								
Euroports Iberica TPS	✓		✓	✓	✓		✓				✓	✓			✓	✓	✓	✓	✓	✓	✓	✓	✓	✓
<b>Torrevieja</b>																								
Torrevieja Port Authority						✓																		✓
<b>Valencia</b>																								
Inst Portuarios de Estudios																								
<b>Valencia</b>																								
Port Authority of Valencia	✓	✓	✓	✓	✓	✓	✓				✓		✓		✓		✓	✓			✓	✓	✓	✓
<b>Vigo</b>																								
Port Authority of Vigo				✓		✓		✓	✓		✓													
<b>Vilagarcía de Arousa</b>																								
Port of Vilagarcía				✓		✓				✓	✓							✓				✓		
<b>Vilagarcía de Arousa</b>																								
Autoridad Portuaria de Vilagarcía de Arousa				✓	✓	✓					✓							✓	✓	✓	✓	✓	✓	✓
<b>SRI LANKA</b>																								
<b>Galle</b>																								
Galle Port				✓		✓					✓	✓												
<b>ST PIERRE &amp; MIQUELON</b>																								
<b>Saint-Pierre and Miquelon</b>																								
Saint-Pierre Harbour																								✓
<b>ST VINCENT &amp; THE GRENADINES</b>																								
<b>Kingstown</b>																								
Kingstown				✓																				
<b>SUDAN</b>																								
<b>Port Sudan</b>																								
Sea Ports Corporation	✓	✓	✓	✓	✓			✓	✓		✓		✓	✓	✓		✓	✓	✓	✓	✓	✓	✓	✓
<b>SULTANATE OF OMAN</b>																								
<b>Muscat</b>																								
Oman Flour Mills Co SAOG				✓																				
<b>N. Azaiba</b>																								
Port of Duqm																								
<b>SURINAME</b>																								
<b>Paramaribo</b>																								
N.V. Havenbeheer Suriname				✓	✓	✓	✓				✓		✓	✓	✓	✓	✓	✓	✓	✓	✓	✓	✓	✓
<b>SWEDEN</b>																								
<b>Gavle</b>																								
Port of Gavle Authority									✓												✓	✓		✓
<b>Göteborg</b>																								
Port of Göteborg																					✓			
<b>Halmstad</b>																								
Halmstad Port	✓																				✓	✓		
<b>Helsingborg</b>																								
Lantmännen, Farmers Assoc.				✓																				
<b>Helsingborg</b>																								



COMMODITIES	CL	CC	PC	G-A	AF	CM	CLK	IO	BX	AL	FR	G-FGD	AG	SU	SOY	SODA	MIN	CHEM	BC	FRS	STL	P&P	MB	OTH
<b>Helsingborgs Hamn, Port of Helsingborg</b>				✓					✓		✓													
<b>Helsingborg</b>																								
Helsingborg Coal Terminal	✓																							
<b>Husum</b>																								
Husum Port																								
<b>Kalmar</b>																								
Kalmar Hamn AB (Port of Kalmar)				✓	✓		✓				✓		✓		✓						✓	✓		✓
<b>Karlshamn</b>																								
Port of Karlshamn				✓																	✓			
<b>Karlstad</b>																								
Vänerhamn AB	✓		✓	✓	✓	✓		✓	✓		✓		✓		✓	✓	✓		✓		✓	✓	✓	
<b>Kristinehamn</b>																								
Kristinehamn Port	✓			✓				✓																
<b>Lulea</b>																								
Port of Lulea	✓	✓	✓			✓		✓	✓															
<b>Lysekil</b>																								
Port of Lysekil				✓													✓		✓		✓	✓	✓	✓
<b>Malmö</b>																								
Copenhagen Malmö Port AB	✓		✓	✓		✓						✓	✓	✓							✓	✓	✓	✓
<b>Oxelsund</b>																								
Oxelosunds Hamn AB	✓																							
<b>Södertälje</b>																								
Port of Sodertälje																								
<b>Sonderhamn</b>																								
Sonderhamn Port				✓																				
<b>Stockholm</b>																								
Port of Hargshamn								✓	✓												✓			
<b>Uddevalla</b>																								
Uddevalla Port				✓				✓	✓		✓													
<b>Västerås</b>																								
Mälardammar AB	✓	✓	✓	✓	✓	✓		✓		✓	✓		✓				✓	✓	✓	✓	✓	✓	✓	✓
<b>Ystad</b>																								
Port of Ystad	✓			✓							✓										✓	✓		✓
<b>SWITZERLAND</b>																								
<b>Basel</b>																								
Ultra-Brag AG	✓	✓	✓	✓	✓					✓	✓			✓	✓		✓		✓	✓	✓	✓	✓	✓
<b>Basel</b>																								
Port of Switzerland	✓	✓	✓	✓	✓	✓				✓	✓	✓	✓	✓	✓	✓	✓	✓	✓	✓	✓	✓	✓	✓
<b>Basel</b>																								
Rhenus-Alpina AG				✓																				
<b>Birsfelden</b>																								
BIRS Terminal AG	✓	✓						✓				✓										✓		
<b>Lugano</b>																								
Interbulk						✓	✓																	
<b>SYRIA</b>																								
<b>Lattakia</b>																								
Lattakia General Port Company				✓																				
<b>Tartous</b>																								
Tartous Port Authority											✓													
<b>TAIWAN</b>																								
<b>Hualien</b>																								
Hualien Port	✓					✓						✓	✓											✓
<b>Kaohsiung</b>																								
Kaohsiung Harbour Bureau	✓	✓		✓	✓	✓	✓	✓	✓	✓	✓	✓		✓	✓	✓	✓	✓	✓	✓	✓	✓	✓	✓
<b>Keelung</b>																								
Keelung Port Authority	✓			✓		✓																		
<b>Mai Liao</b>																								
Mai Liao Harbour Administration Corp	✓		✓															✓						✓
<b>Suao Port Building</b>																								
Su-Ao Port Authority	✓					✓																		
<b>Taichung</b>																								
Taichung-Wharf No 1				✓																				
<b>Taichung</b>																								
Port of Taichung, Asia Cement Berth																								
<b>Taipei</b>																								
Eastern Media International Corporation				✓																				
<b>Wuchi</b>																								
Taichung Port Authority	✓			✓		✓						✓											✓	✓

# COMMODITIES HANDLED

COMMODITIES	CL	CC	PC	G-A	AF	CM	CLK	IO	BX	AL	FR	G-FGD	AG	SU	SOY	SODA	MIN	CHEM	BC	FRS	STL	P&P	MB	OTH
<b>TANZANIA</b>																								
<b>Dar es Salaam</b>																								
Tanzania Harbours Authority				✓																				
<b>Dar es Salaam</b>																								
Tanzania Ports Authority	✓			✓	✓	✓	✓				✓	✓		✓	✓	✓	✓	✓		✓	✓	✓	✓	✓
<b>Kurasini</b>																								
Grindrod Terminals - Dar Es Salaam																		✓						
<b>THAILAND</b>																								
<b>Bangpli</b>																								
S.P. Intermarine Co., Ltd	✓			✓				✓																
<b>Sattahip</b>																								
Sattahip Port Authority																								✓
<b>Singhanakorn</b>																								
Chaophaya Terminal International Co. Ltd				✓							✓													
<b>THE GAMBIA</b>																								
<b>Banjul</b>																								
The Gambia Ports Authority																								
<b>THE NETHERLANDS</b>																								
<b>Amsterdam</b>																								
Port of Amsterdam	✓	✓	✓	✓	✓	✓	✓	✓	✓	✓	✓	✓	✓	✓	✓	✓	✓	✓	✓	✓	✓	✓	✓	✓
<b>Amsterdam</b>																								
Amfert											✓													
<b>Amsterdam</b>																								
B.V. Bouwgrondstoffen AGM													✓											
<b>Amsterdam</b>																								
Civil and Marine Nederland													✓											
<b>Amsterdam</b>																								
Graham - Grondstoffen Exp. Amsterdam (Arc Marine)													✓											
<b>Amsterdam</b>																								
Maja Stuwadoors Rotterdam	✓			✓				✓																
<b>Amsterdam</b>																								
Rietlanden Stevedores BV	✓	✓						✓																✓
<b>Amsterdam</b>																								
OBA - Bulk Terminal Amsterdam	✓	✓	✓	✓	✓			✓					✓		✓			✓			✓		✓	
<b>Badhoevedorp</b>																								
IGMA	✓	✓		✓	✓	✓	✓	✓	✓	✓	✓	✓		✓	✓	✓	✓	✓	✓		✓		✓	
<b>Botlek</b>																								
Jewometaal Stainless Processing																						✓		
<b>Botlek</b>																								
Borax Rotterdam N.V.																								
<b>Delfzijl</b>																								
Groningen Seaports																								
<b>Delfzijl</b>																								
Aldel - Aluminium Delfzijl											✓													
<b>Delfzijl</b>																								
Groningen Seaports								✓			✓													✓
<b>Dordrecht</b>																								
Port Authority of Dordrecht				✓							✓													✓
<b>Dordrecht</b>																								
BV Zeehavenbedrijf Dordrecht (ZHD Stevedoring)	✓	✓	✓	✓	✓	✓	✓	✓	✓	✓	✓	✓	✓	✓	✓	✓	✓	✓	✓	✓	✓	✓	✓	✓
<b>Europoort - Rt</b>																								
Ertsoverslagbedrijf																								
Europoort C.V. (EECV)	✓	✓						✓																
<b>Farmsum</b>																								
Akzonobel	✓																							✓
<b>Ijmuiden</b>																								
Nebam BV	✓							✓	✓													✓		
<b>Koudekerk aan den Rijn</b>																								
ENBO BV						✓																		
<b>Mierlo</b>																								
International Bulk Handling Technology BV	✓		✓					✓			✓		✓	✓										
<b>Moerdijk</b>																								
Combined Cargo Terminals B.V.										✓									✓		✓	✓		✓
<b>Moerdijk</b>																								
Associated Metal Services B.V.				✓	✓	✓		✓	✓	✓	✓						✓		✓	✓	✓	✓	✓	
<b>Rotterdam</b>																								
Van Uden Bulk Logistics			✓	✓	✓		✓	✓	✓	✓		✓	✓			✓	✓	✓	✓		✓	✓	✓	✓



COMMODITIES	CL	CC	PC	G-A	AF	CM	CLK	IO	BX	AL	FR	G-FGD	AG	SU	SOY	SODA	MIN	CHEM	BC	FRS	STL	P&P	MB	OTH	
<b>Rotterdam</b>																									
Van Uden NedCargo																									
<b>Rotterdam</b>																									
Port of Rotterdam	✓	✓	✓	✓	✓	✓	✓	✓	✓	✓	✓	✓	✓	✓	✓	✓	✓	✓	✓	✓	✓	✓	✓	✓	
<b>Rotterdam</b>																									
Meneba				✓																					
<b>Rotterdam</b>																									
Van Uden Stevedoring	✓			✓	✓		✓	✓	✓		✓	✓					✓				✓		✓	✓	
<b>Rotterdam</b>																									
Marcor Stevedoring																									
BV Rotterdam	✓	✓	✓	✓	✓		✓	✓	✓	✓	✓	✓	✓	✓	✓	✓	✓					✓		✓	
<b>Rotterdam</b>																									
European Bulk Services (EBS) BV	✓	✓	✓	✓	✓	✓	✓	✓	✓	✓	✓		✓	✓	✓		✓						✓	✓	
<b>Rotterdam</b>																									
C. Steinweg-Handelsvem BV									✓													✓		✓	✓
<b>Rotterdam</b>																									
Europees-Massagoed Overslagbedrijf (EMO) BV	✓	✓						✓																	
<b>Rotterdam</b>																									
RHB Stevedoring & Warehousing																				✓	✓	✓	✓		✓
<b>Rotterdam</b>																									
Stuwadoors en Controlebedrijf BV					✓																	✓			✓
<b>Rozenburg</b>																									
EP Shipping & Trading BV	✓			✓																					
<b>Sas van Ghent</b>																									
Zuid-Chemie											✓														
<b>Sas van Ghent</b>																									
Cerestar Benelux																									
<b>Schiedam</b>																									
Van Mannekus & Co																								✓	
<b>Schiedam</b>																									
Nieuwe Waterweg Silo	✓		✓	✓	✓	✓	✓	✓	✓		✓	✓		✓	✓						✓	✓		✓	✓
<b>Spijkernisse</b>																									
SGS (Nederland) BV	✓			✓	✓	✓	✓	✓	✓		✓	✓	✓	✓							✓	✓	✓	✓	✓
<b>Stiens</b>																									
EMG-Silo Groningen				✓																					
<b>Terneuzen</b>																									
Terneuzen Port Authority																									
<b>Vlissingen</b>																									
Ovet BV - Vlissingen Terminal	✓	✓	✓	✓	✓		✓	✓	✓	✓	✓	✓	✓		✓	✓	✓				✓	✓		✓	✓
<b>Terneuzen</b>																									
Zeeland Seaports	✓			✓					✓		✓										✓	✓	✓	✓	✓
<b>Terneuzen</b>																									
Ovet BV - Terneuzen Terminal	✓	✓	✓	✓	✓		✓	✓	✓	✓	✓	✓	✓		✓	✓	✓				✓	✓		✓	✓
<b>Terneuzen</b>																									
Verbrugge Terneuzen Terminals					✓						✓						✓	✓	✓	✓	✓	✓	✓	✓	✓
<b>Vlaardingen</b>																									
Vulcaanhaven BV									✓									✓							
<b>Vlaardingen</b>																									
Port of Vlaardingen	✓			✓	✓		✓	✓	✓		✓											✓		✓	✓
<b>Vlaardingen</b>																									
Rotterdam Bulk Terminal (R.B.T.) B.V.	✓	✓	✓	✓			✓	✓	✓		✓		✓	✓			✓							✓	✓
<b>Zwijndrecht</b>																									
Agro Delta Group				✓	✓						✓				✓										✓
<b>TOGA</b>																									
<b>Lome</b>																									
Office Togolaise des Phosphates																									
<b>TRINIDAD &amp; TOBAGO</b>																									
<b>Couvra Trinidad</b>																									
Point Lisas Industrial Port Development Corp Ltd																					✓	✓			
<b>Point Lisas</b>																									
Point Lisas Industrial Port Development Corp				✓		✓	✓				✓	✓	✓								✓			✓	✓
<b>Port of Spain</b>																									
Port Authority of Trinidad and Tobago				✓																					
<b>Port of Spain</b>																									
Port of Spain				✓																					
<b>Port of Spain</b>																									
Chaguaramas Terminals Ltd								✓	✓																

# COMMODITIES HANDLED

COMMODITIES	CL	CC	PC	G-A	AF	CM	CLK	IO	BX	AL	FR	G-FGD	AG	SU	SOY	SODA	MIN	CHEM	BC	FRS	STL	P&P	MB	OTH
<b>Port of Spain</b>																								
Cronstadt Island																								✓
<b>TUNISIA</b>																								
<b>Bizerte</b>																								
Office des Ports Nationaux Tunisiens				✓							✓													
<b>Bizerte</b>																								
Port Authority of Bizerte				✓		✓																		
<b>Port de la Goulette</b>																								
Port Authority of Tunis Goulette				✓				✓			✓													
<b>Sfax</b>																								
Port Authority of Sfax				✓							✓													✓
<b>TURKEY</b>																								
<b>Bursa</b>																								
Gemlik Port											✓													
<b>Eregli</b>																								
Eregli Port Authority	✓							✓	✓															
<b>Hereke-Izmit</b>																								
NUH Cement Factory of Hereke						✓																		
<b>Istanbul</b>																								
Toros Tarim Sanayi ve Ticaret A -TOROS Ceyhan Term	✓	✓	✓	✓	✓	✓	✓	✓	✓	✓	✓	✓	✓	✓	✓	✓	✓	✓	✓	✓	✓	✓	✓	✓
<b>Istanbul</b>																								
Toros Tarim Sanayi ve Ticaret A -TOROS Samsun Term	✓	✓	✓	✓	✓	✓	✓	✓	✓	✓	✓	✓	✓		✓				✓		✓		✓	✓
<b>Izmir</b>																								
Izmir Port				✓				✓	✓															
<b>Mersin</b>																								
Famagusta Port Authority				✓		✓						✓												
<b>Tekirdag</b>																								
Tekirdag Port				✓																				
<b>Tekkeköy/Samsun</b>																								
Toros Tarim San. ve Tic. A.	✓																							
<b>Trabzon</b>																								
Trabzon Port				✓				✓	✓															
<b>UAE</b>																								
<b>Abu Dhabi</b>																								
Port Zayed																								
<b>Abu Dhabi</b>																								
Abu Dhabi Seaport Authority				✓							✓													✓
<b>Ajman</b>																								
Emirates Ports Services																								
<b>Dubai</b>																								
Dubai Port World			✓	✓	✓		✓	✓	✓	✓	✓	✓	✓	✓					✓	✓	✓	✓	✓	✓
<b>Dubai</b>																								
DP World	✓			✓		✓		✓			✓										✓	✓	✓	
<b>UAE</b>																								
<b>Fujairah</b>																								
Port of Fujairah								✓	✓				✓											✓
<b>UK</b>																								
<b>Ayr</b>																								
Ayr	✓			✓							✓													
<b>Ayr</b>																								
Associated British Ports (Ayr and Troon)	✓			✓	✓	✓					✓		✓		✓	✓			✓	✓	✓		✓	✓
<b>Barrow upon Humber</b>																								
New Holland Bulk Services				✓							✓													
<b>Barrow-in-Furness</b>																								
Port of Barrow-in-Furness														✓							✓	✓	✓	✓
<b>Belfast</b>																								
Belfast Harbour Commissioners	✓		✓	✓	✓	✓	✓				✓				✓						✓	✓	✓	
<b>Berwick-Upon-Tweed</b>																								
Berwick Harbour Commission				✓	✓	✓					✓										✓			✓
<b>Blyth</b>																								
Port of Blyth	✓																				✓		✓	
<b>Bootle</b>																								
E-ON UK Liverpool	✓																							
<b>Boston</b>																								
Lingrain Services Ltd				✓																				
<b>Bristol</b>																								
The Bristol Port Company	✓			✓	✓						✓	✓	✓		✓				✓	✓		✓	✓	



COMMODITIES	CL	CC	PC	G-A	AF	CM	CLK	IO	BX	AL	FR	G-FGD	AG	SU	SOY	SODA	MIN	CHEM	BC	FRS	STL	P&P	MB	OTH
<b>Canningtown</b>																								
European Metal Recycling Ltd	✓	✓						✓					✓											✓
<b>Cardiff</b>																								
Associated British Ports	✓			✓	✓	✓	✓	✓	✓	✓	✓	✓	✓	✓	✓	✓	✓	✓	✓	✓	✓	✓	✓	✓
<b>Cardiff</b>																								
ABP South Wales (Ports of Newport,	✓			✓		✓																		
<b>Coleraine</b>																								
Coleraine Harbour																								
Commissioners	✓																						✓	
<b>Dundee</b>																								
Forth Ports PLC - Port of Dundee				✓							✓													
<b>Dundee</b>																								
Grainfax				✓	✓								✓											
<b>Egham</b>																								
Cemex UK						✓																		
<b>Falmouth</b>																								
A & P Falmouth Ltd	✓	✓		✓	✓						✓		✓				✓		✓	✓			✓	
<b>Felixstowe</b>																								
Felixstowe Dock & Railway Company																								✓
<b>Feltham</b>																								
RMC Feltham													✓											✓
<b>Fowey</b>																								
Fowey Harbour Commissioners																								✓
<b>Garston</b>																								
ABP - Garston				✓	✓	✓	✓				✓		✓		✓				✓	✓	✓	✓	✓	✓
<b>Glasgow</b>																								
Clyde Port Authority	✓					✓							✓								✓			✓
<b>Glasgow</b>																								
Clydeport Operations	✓					✓		✓					✓								✓			
<b>Goole</b>																								
ABP - Goole Port				✓		✓		✓	✓		✓												✓	✓
<b>Grangemouth</b>																								
Casper Shipping Ltd																						✓		
<b>Grangemouth</b>																								
Forth Ports Plc				✓																				
<b>Grangemouth</b>																								
Grangemouth	✓								✓				✓			✓	✓	✓	✓	✓	✓	✓	✓	✓
<b>Grangemouth</b>																								
Leith Docks	✓			✓							✓													
<b>Gravesend</b>																								
Port of London Authority	✓			✓																				
<b>Great Yarmouth</b>																								
East Port UK	✓			✓	✓	✓					✓		✓								✓		✓	✓
<b>Grimsby</b>																								
Associated British Ports - Grimsby & Immingham	✓		✓	✓	✓	✓	✓	✓	✓		✓	✓	✓	✓							✓	✓	✓	✓
<b>Hartlepool</b>																								
Tees and Hartlepool Port Authority	✓		✓	✓				✓	✓		✓		✓											✓
<b>Holywell</b>																								
Mostyn Docks Limited					✓								✓									✓		
<b>Hull</b>																								
Frontier Agriculture Ltd				✓																				
<b>Hull</b>																								
ABP - Port of Hull	✓			✓		✓			✓		✓		✓											✓
<b>Hull</b>																								
Titan Cement UK						✓																		
<b>Immingham</b>																								
Casper Shipping Ltd	✓	✓	✓	✓	✓			✓					✓		✓									✓
<b>Ipswich</b>																								
Clarksons Port Services				✓																				
<b>Ipswich</b>																								
ABP - Port of Ipswich	✓			✓	✓	✓	✓			✓	✓		✓		✓	✓		✓	✓	✓	✓	✓	✓	✓
<b>Ipswich</b>																								
The Grain Terminal (Ipswich) Ltd				✓	✓																			
<b>Ipswich</b>																								
ABP Port of Lowestoft				✓		✓					✓		✓								✓			
<b>Isle of Man</b>																								
Port of Ramsey	✓			✓	✓	✓					✓												✓	✓
<b>Kings Lynn</b>																								
King's Lynn Conservancy Board				✓																				

# COMMODITIES HANDLED

COMMODITIES	CL	CC	PC	G-A	AF	CM	CLK	IO	BX	AL	FR	G-FGD	AG	SU	SOY	SODA	MIN	CHEM	BC	FRS	STL	P&P	MB	OTH	
<b>Liverpool</b>																									
Mersey Docks & Harbour Company	✓			✓	✓	✓	✓				✓		✓		✓						✓	✓	✓	✓	✓
<b>Liverpool</b>																									
Royal Seaforth Grain Terminal				✓																					
<b>London</b>																									
MacQuarie Capital (Europe) Limited																									
<b>Londonderry</b>																									
Londonderry Port & Harbour Commissioners	✓			✓		✓					✓														✓
<b>Manningtree</b>																									
Mistley Quay & Forwarding				✓				✓	✓		✓														
<b>Merton</b>																									
ABP																									
<b>Methil</b>																									
Port of Burntisland									✓																
<b>Middlesbrough</b>																									
Casper Shipping Ltd	✓																								
<b>Middlesex</b>																									
Hall Aggregates Wharf													✓												
<b>Montrose</b>																									
Montrose Port Authority				✓	✓	✓					✓				✓			✓			✓	✓	✓	✓	✓
<b>Near Hull</b>																									
Hull Agency (Goole)	✓																								
<b>Newport</b>																									
ABP - Port of Newport	✓	✓	✓	✓	✓	✓					✓		✓				✓				✓	✓	✓	✓	✓
<b>Newport</b>																									
ABP - Port of Swansea	✓					✓							✓												
<b>Newport</b>																									
Newport Stevedores Ltd	✓		✓			✓																			✓
<b>North Killingholme</b>																									
Humber Sea Terminal																									
<b>Nottingham</b>																									
Hull Bulk Handling Ltd	✓		✓	✓	✓							✓	✓		✓									✓	
<b>Oban</b>																									
Glensanda Harbour													✓												
<b>Padstow</b>																									
Padstow Harbour Commissioners				✓							✓		✓												✓
<b>Penzance</b>																									
Penzance Harbour																									✓
<b>Perth</b>																									
Perth Harbour	✓		✓	✓	✓						✓		✓								✓				✓
<b>Poole</b>																									
Poole Harbour Commissioners				✓																					✓
<b>Port Talbot</b>																									
ABP - Port Talbot	✓																								
<b>Portbury</b>																									
Agricultural Bulk Services				✓																					
<b>Portland</b>																									
Portland Port Ltd				✓							✓		✓								✓	✓			
<b>Rosyth</b>																									
Port of Methil	✓			✓							✓														✓
<b>Runcorn</b>																									
Manchester Ship Canal Company Ltd				✓		✓				✓	✓		✓			✓	✓								✓
<b>Rye</b>																									
Rastrum Ltd				✓	✓								✓						✓		✓	✓		✓	
<b>Seaham</b>																									
Seaham Harbour Dock Company	✓			✓							✓		✓												✓
<b>Sharpness</b>																									
Port of Sharpness	✓			✓	✓	✓					✓		✓								✓	✓		✓	✓
<b>Silloth</b>																									
ABP - Port of Silloth				✓		✓					✓														
<b>South Shields</b>																									
Port of Tyne	✓	✓	✓	✓	✓	✓	✓	✓	✓	✓	✓	✓	✓	✓	✓	✓	✓	✓	✓	✓	✓	✓	✓	✓	✓
<b>Southampton</b>																									
Southampton Grain Terminal Ltd				✓																					
<b>Southampton</b>																									
ABP - Southampton				✓		✓					✓														
<b>Southampton</b>																									
Solent Stevedores Ltd				✓	✓			✓			✓	✓	✓	✓	✓				✓		✓	✓	✓	✓	✓
<b>Sunderland</b>																									
Port of Sunderland	✓	✓	✓				✓				✓	✓	✓								✓	✓	✓		



COMMODITIES	CL	CC	PC	G-A	AF	CM	CLK	IO	BX	AL	FR	G-FGD	AG	SU	SOY	SODA	MIN	CHEM	BC	FRS	STL	P&P	MB	OTH	
<b>Swansea</b>																									
ABP Harbour Office	✓	✓		✓		✓		✓			✓		✓								✓	✓	✓		✓
<b>Teignmouth</b>																									
ABP - Teignmouth				✓																					
<b>Tilbury</b>																									
Stema Shipping UK													✓												
<b>Tilbury</b>																									
Port of Tilbury London Limited				✓							✓										✓	✓	✓		
<b>Tilbury</b>																									
Port of Tilbury London Ltd - Grain Terminal				✓	✓						✓			✓											
<b>Warrenpoint</b>																									
Warrenpoint Harbour Authority				✓																	✓	✓			
<b>Whitstable</b>																									
Whitstable Harbour													✓												
<b>Wolverhampton</b>																									
Tarmac Limited													✓												
<b>Workington</b>																									
Port of Workington	✓																								
<b>UKRAINE</b>																									
<b>Berdiansk</b>																									
Berdiansk Port Authority				✓				✓			✓														
<b>Ilichevsk</b>																									
Port of Ilichevsk Authority								✓																	
<b>Izmail</b>																									
Commercial Sea Port of Izmail	✓			✓																					
<b>Kerch</b>																									
The Kerch Merchant Port																								✓	✓
<b>Kyiv</b>																									
PORTINVEST LLC																									
<b>Mariupol</b>																									
Mariupol Sea Commercial Port	✓	✓	✓	✓		✓	✓	✓	✓		✓							✓	✓		✓				✓
<b>Nikoleav</b>																									
Nikolayev Port Authority				✓				✓																	
<b>Odessa</b>																									
Port of Odessa Authority				✓		✓								✓											
<b>Odessa</b>																									
Transinvestservice (TIS) Ltd	✓	✓		✓				✓			✓							✓							
<b>Odessa</b>																									
Odessa Port Silo				✓																					
<b>Odessa</b>																									
PortInvest																									
<b>Port of Kilia</b>																									
Kiliya Transshipment Point				✓																					
<b>Reni</b>																									
Port of Reni	✓	✓	✓	✓	✓	✓	✓	✓	✓	✓	✓	✓	✓	✓	✓	✓	✓	✓	✓	✓	✓	✓	✓	✓	✓
<b>Vikovo</b>																									
Port of Ust-Dunaysk				✓																					
<b>Yalta</b>																									
Yalta Sea Trade Port Authority																									✓
<b>Yuzhny</b>																									
Port Yuzhny	✓			✓			✓	✓	✓		✓											✓			
<b>Yuzhny</b>																									
JV Transinvestservice TIS				✓							✓														
<b>URUGUAY</b>																									
<b>Montevideo</b>																									
T.G.U.S.A Uruguayan Grain Terminals				✓																					
<b>Montevideo</b>																									
Corporación Navios S.A.				✓																					
<b>Montevideo</b>																									
Paysandu Coordinadora de Puertos Uruguay				✓																					
<b>Nueva Palmira</b>																									
Terminal Nueva Palmira				✓																					
<b>Rio Negro</b>																									
Terminal Fray Bentos				✓																					
<b>USA</b>																									
<b>Aberdeen</b>																									
Port of Grays Harbor				✓	✓				✓				✓								✓	✓	✓		✓
<b>Albany</b>																									
Albany Port District Commission				✓	✓						✓		✓								✓	✓	✓		

# COMMODITIES HANDLED

COMMODITIES	CL	CC	PC	G-A	AF	CM	CLK	IO	BX	AL	FR	G-FGD	AG	SU	SOY	SODA	MIN	CHEM	BC	FRS	STL	P&P	MB	OTH
<b>Alexandria</b>																								
American Association of Port Authorities (AAPA)																								
<b>Ama</b>																								
ADM Gromark-Destrehan				✓																				
<b>Anacortes</b>																								
Metropolitan Stevedore Company			✓										✓											
<b>Anacortes</b>																								
Metro Ports			✓																					✓
<b>Anacortes</b>																								
Port of Anacortes			✓															✓		✓	✓			
<b>Anchorage</b>																								
Port of Anchorage																								
<b>Anchorage</b>																								
North Star Terminal																					✓			
Stevedore Company																					✓			✓
<b>Arabi</b>																								
Associated Terminals of																								
St Bernard	✓	✓	✓	✓	✓			✓	✓	✓	✓	✓	✓	✓	✓	✓	✓	✓	✓	✓	✓	✓	✓	✓
<b>Louisville</b>																								
Kinder Morgan Terminals - Louisville	✓																							
<b>Evansville</b>																								
Kinder Morgan Terminals - Evansville	✓																							
<b>Argo</b>																								
Kinder Morgan Terminals	✓																							
<b>Owensboro</b>																								
Kinder Morgan Terminals - Owensboro	✓																							
<b>Baltimore</b>																								
Maryland Port Administration																								
<b>Baltimore</b>																								
CNX Marine Terminal, Inc.	✓																				✓	✓		
<b>Baltimore</b>																								
Rukert Terminals Corp				✓					✓		✓	✓	✓								✓		✓	✓
<b>Baltimore</b>																								
Port of Baltimore	✓			✓				✓	✓		✓	✓									✓			
<b>Baltimore</b>																								
Baltimore Terminal	✓																							
<b>Baton Rouge</b>																								
Louisiana Mid-Stream Terminals, LLC	✓	✓	✓																					
<b>Bayonne</b>																								
Duraport Marine & Rail Terminal, LLC													✓											
<b>Beaumont</b>																								
Port of Beaumont				✓																	✓	✓		✓
<b>Beaumont</b>																								
Beaumont Bulk Terminal Inc				✓				✓													✓	✓		
<b>Bellingham</b>																								
Port of Bellingham					✓					✓	✓		✓								✓		✓	
<b>Benicia</b>																								
Port of Benicia Authority			✓																					✓
<b>Boston</b>																								
Massport Maritime Department	✓			✓		✓		✓				✓												
<b>Braithwaite</b>																								
Plaquemines Port	✓	✓		✓																				✓
<b>Bridgeport</b>																								
Bridgeport Port Authority													✓											✓
<b>Brownsville</b>																								
Port of Brownsville				✓						✓												✓		
<b>Brunswick</b>																								
Marine Port Terminals Inc			✓	✓							✓													✓
<b>Buffalo</b>																								
Port of Buffalo	✓		✓					✓				✓	✓								✓	✓		✓
<b>Burlingame</b>																								
Ports America						✓	✓				✓	✓	✓								✓	✓	✓	✓
<b>Camden</b>																								
South Jersey Ports Corp			✓																		✓			
<b>Camden</b>																								
Delaware River Port Authority																								
<b>Cape Canaveral</b>																								
Port Canaveral					✓	✓					✓	✓	✓					✓		✓	✓	✓	✓	✓



COMMODITIES	CL	CC	PC	G-A	AF	CM	CLK	IO	BX	AL	FR	G-FGD	AG	SU	SOY	SODA	MIN	CHEM	BC	FRS	STL	P&P	MB	OTH
<b>Carteret</b>																								
Kinder Morgan Liquid Terminals, LLC																								
<b>Caruthersville</b>																								
Pemiscot County Port Authority				✓							✓													✓
<b>Catoosa</b>																								
Tulsa Port of Catoosa				✓							✓	✓								✓		✓		✓
<b>Catoosa</b>																								
Gavilon Fertilizer, LLC				✓							✓	✓												✓
<b>Ceredo</b>																								
Kanawha River Terminal Inc	✓																							
<b>Cora</b>																								
Kinder Morgan Terminals - Cora						✓																		
<b>Charleston</b>																								
Port of Charleston	✓			✓							✓													
<b>Charleston</b>																								
Stevens Shipping & Terminal Co																								
<b>Charleston</b>																								
Kinder Morgan Terminals - Shipyard River Terminal	✓																							
<b>Charleston</b>																								
Kinder Morgan Terminals - Pier IX Terminal	✓																							
<b>Grand Rivers</b>																								
Kinder Morgan Terminals - Grand Rivers	✓																							
<b>Charlotte</b>																								
CSX World Terminals																								
<b>Chesapeake</b>																								
Kinder Morgan Elizabeth River Terminals				✓					✓		✓													
<b>Chicago</b>																								
KCBX Terminals Company	✓	✓	✓					✓																
<b>Chicago</b>																								
Illinois International Port Dist.	✓	✓	✓	✓	✓	✓	✓	✓	✓	✓	✓	✓	✓	✓	✓	✓	✓	✓	✓	✓	✓	✓	✓	✓
<b>Cleveland</b>																								
Port of Cleveland						✓		✓														✓		✓
<b>Conneaut</b>																								
Pittsburgh & Conneaut Dock Co.	✓	✓	✓					✓			✓	✓	✓				✓					✓	✓	
<b>Convent</b>																								
St. James Stevedoring Partners, LLC	✓	✓	✓	✓	✓	✓	✓	✓	✓	✓	✓	✓	✓	✓	✓	✓	✓	✓	✓	✓	✓	✓	✓	✓
<b>Convent</b>																								
IC RailMarine Terminal (ICRMT)	✓	✓	✓					✓			✓		✓				✓				✓			✓
<b>Coos Bay</b>																								
Oregon International Port of Coos Bay								✓													✓	✓		
<b>Cordova</b>																								
Port of Cordova																								
<b>Corpus Christi</b>																								
Boyd-Campbell Company	✓	✓	✓	✓	✓	✓	✓	✓					✓						✓			✓		✓
<b>Corpus Christi</b>																								
Sherwin Alumina, L.P.									✓	✓														
<b>Corpus Christi</b>																								
Public Elevator				✓																				
<b>Corpus Christi</b>																								
Port of Corpus Christi	✓		✓	✓				✓	✓															
<b>Corpus Christi</b>																								
Port of Corpus Christi - Bulk Terminal	✓	✓	✓	✓	✓			✓	✓				✓								✓	✓		✓
<b>Darrow</b>																								
Cooper/Consolidated	✓	✓	✓	✓	✓	✓	✓	✓	✓	✓	✓	✓	✓	✓	✓	✓	✓	✓	✓	✓	✓	✓	✓	✓
<b>Darrow</b>																								
Burnside Bulk Marine Terminal	✓								✓	✓														
<b>Davant</b>																								
U.S. United Bulk Terminal	✓	✓	✓					✓		✓	✓	✓	✓											✓
<b>Davant</b>																								
United Bulk Terminals - Davant	✓	✓	✓																					
<b>Decatur</b>																								
ARTCO	✓		✓	✓					✓	✓	✓													
<b>Detroit</b>																								
Detroit / Wayne County Port Authority				✓																		✓		✓

# COMMODITIES HANDLED

COMMODITIES	CL	CC	PC	G-A	AF	CM	CLK	IO	BX	AL	FR	G-FGD	AG	SU	SOY	SODA	MIN	CHEM	BC	FRS	STL	P&P	MB	OTH	
<b>Detroit</b>																									
Port of Detroit																						✓			
<b>Duluth</b>																									
Duluth Seaway Port Authority	✓	✓		✓	✓	✓	✓	✓			✓		✓					✓		✓	✓	✓	✓	✓	✓
<b>Duluth</b>																									
AGP Grain Limited				✓																					
<b>Duluth</b>																									
General Mills Elevator A				✓																					
<b>East Liverpool</b>																									
Columbiana County Port Authority																									✓
<b>Eastport</b>																									
Eastport Port Authority													✓								✓				
<b>Erie</b>																									
Mount Fort Terminal													✓										✓	✓	✓
<b>Eureka</b>																									
Humboldt Bay Harbour District																									
<b>Everett</b>																									
Port of Everett										✓											✓	✓			✓
<b>Fields Landing</b>																									
Port of Eureka				✓																	✓				
<b>Fort Lauderdale</b>																									
Port Everglades Department of Broward County	✓	✓				✓			✓														✓	✓	✓
<b>Fresno</b>																									
Penny Newman Grain Co				✓																					
<b>Galveston</b>																									
Port of Galveston				✓										✓							✓	✓			
<b>Galveston</b>																									
Farmland Elevator G				✓																					
<b>Galveston</b>																									
Metro Ports																									
<b>Garden City</b>																									
Metro Ports									✓		✓	✓	✓		✓	✓	✓		✓						✓
<b>Georgetown</b>																									
Port of Georgetown						✓		✓					✓												
<b>Georgetown</b>																									
Stevedoring Services of America (SSA)	✓																								
<b>Georgetown</b>																									
Winyah Stevedoring Inc																									
<b>Georgetown</b>																									
Liberty Terminals, LLC																									
<b>Georgetown</b>																									
WSI of the Southeast llc	✓																								
<b>Glen Carbon</b>																									
SymFuel Technologies Inc.																									
<b>Green Bay</b>																									
Port of Green Bay	✓				✓	✓																✓	✓	✓	✓
<b>Gretna</b>																									
Associated Grain Terminals				✓	✓																				✓
<b>Gulfport</b>																									
Mississippi State Port Authority at Gulfport																									
<b>Hilo</b>																									
State of Hawaii, Department of Transportation							✓													✓	✓				
<b>Hilo</b>																									
Hilo Harbour	✓																								
<b>Homer</b>																									
City of Homer Port and Harbor																				✓	✓	✓		✓	✓
<b>Honolulu</b>																									
Honolulu Port Authority				✓																					
<b>Houston</b>																									
Cooper/T. Smith Stevedoring																									
<b>Houston</b>																									
Public Elevator 2				✓																					
<b>Houston</b>																									
Tx Tx Corporation	✓																								
<b>Houston</b>																									
Port of Houston Authority				✓	✓				✓																
<b>Humble</b>																									
P&O Ports Texas, Inc.				✓																	✓	✓	✓		
<b>Indiana</b>																									
Port of Indiana																									



COMMODITIES	CL	CC	PC	G-A	AF	CM	CLK	IO	BX	AL	FR	G-FGD	AG	SU	SOY	SODA	MIN	CHEM	BC	FRS	STL	P&P	MB	OTH	
<b>Indianapolis</b>																									
Burns International Harbour-Port of Indiana		✓		✓							✓											✓			
<b>Jacksonville</b>																									
Jacksonville Port Authority																									
<b>Jacksonville</b>																									
Jacksonville Electric Authority																									
<b>Juneau</b>																									
Port of Juneau																									
<b>Kalama</b>																									
Peavey Elevator				✓																					
<b>Kalama</b>																									
Harvest States Elevator				✓																					
<b>Kenai</b>																									
Port of Kenai																									
<b>Kenova</b>																									
Big Sandy Terminal Inc	✓																								
<b>Kirkland</b>																									
Macquarie Ports Inc																									
<b>Kodiak</b>																									
City of Kodiak Harbour Dep't																									
<b>LaPlace</b>																									
Consolidated Terminals & Logistics Company	✓	✓	✓	✓	✓	✓	✓	✓	✓	✓	✓	✓	✓	✓				✓			✓	✓	✓	✓	✓
<b>LaPlace</b>																									
Cooper/Consolidated	✓	✓	✓	✓	✓	✓	✓	✓	✓	✓	✓	✓	✓	✓	✓	✓	✓	✓	✓	✓	✓	✓	✓	✓	✓
<b>La Place</b>																									
Port of South Louisiana	✓	✓	✓	✓	✓	✓	✓	✓	✓	✓	✓		✓	✓	✓	✓	✓	✓				✓			
<b>Lake Charles</b>																									
Lake Charles Harbor & Terminal District				✓	✓				✓												✓				
<b>Lake Charles</b>																									
Port of Lake Charles				✓																					
<b>Long Beach</b>																									
MCC-Lucky Cement Terminal						✓																			
<b>Long Beach</b>																									
Port of Long Beach	✓		✓	✓		✓						✓									✓				
<b>Long Beach</b>																									
Oxbow Carbon & Minerals LLC	✓		✓																						
<b>Long Beach</b>																									
Cooper/T. Smith Stevedoring	✓																								
<b>Long Beach</b>																									
Metro Ports	✓		✓			✓												✓	✓						
<b>Longview</b>																									
Port of Longview			✓	✓	✓			✓			✓				✓	✓	✓			✓	✓	✓	✓		
<b>Louisville</b>																									
Cooper/T. Smith Stevedoring	✓																								
<b>Mason</b>																									
Coal Network	✓																								
<b>Maumee</b>																									
Kuhlman Corporation				✓	✓						✓			✓											
<b>Maumee</b>																									
The Andersons - Maumee Grain Marine facilities				✓	✓						✓				✓										
<b>Maumee</b>																									
The Andersons, Inc				✓	✓											✓									
<b>Metairie</b>																									
Kinder Morgan Terminals	✓		✓								✓		✓												
<b>Metropolis</b>																									
AEP/Cook Coal Terminal	✓																								
<b>Miami</b>																									
Port of Miami																									
<b>Miami</b>																									
Panama Canal Authority (ACP)																									
<b>Milwaukee</b>																									
Continental Grain Elevator				✓																					
<b>Milwaukee</b>																									
Port of Milwaukee	✓			✓		✓	✓				✓		✓						✓		✓	✓	✓	✓	✓
<b>Milwaukee</b>																									
Milwaukee Bulk Terminals	✓										✓		✓												
<b>Mobile</b>																									
Stevedoring Services																									
Services of America																									

# COMMODITIES HANDLED

COMMODITIES	CL	CC	PC	G-A	AF	CM	CLK	IO	BX	AL	FR	G-FGD	AG	SU	SOY	SODA	MIN	CHEM	BC	FRS	STL	P&P	MB	OTH
<b>Mobile</b>																								
Alabama State Port Authority	✓							✓												✓	✓			
<b>Mobile</b>																								
Port of Mobile	✓			✓		✓		✓	✓			✓	✓							✓	✓	✓	✓	✓
<b>Mobile</b>																								
FGDI LLC - ASPA Pier D																								
Grain Elevator				✓																				
<b>Mobile</b>																								
McDuffie Coal Terminal	✓																							
<b>Mobile</b>																								
Cooper/T. Smith Stevedoring	✓					✓		✓													✓			
<b>Monaca</b>																								
Colona Terminal Services	✓	✓										✓	✓				✓							
<b>Monroe</b>																								
Tower Monroe Port Commission																								
<b>Morehead City</b>																								
North Carolina State Ports Authority/Morehead City				✓	✓	✓					✓		✓							✓	✓	✓		✓
<b>Mount Pleasant</b>																								
Strachan Shipping Co	✓																							✓
<b>Mount Vernon</b>																								
Ports Of Indiana				✓							✓													
<b>Myrtle Grove</b>																								
International Marine Terminals	✓		✓			✓	✓	✓			✓		✓											✓
<b>New Haven</b>																								
New Haven Terminal																								✓
<b>New Haven</b>																								
New Haven	✓											✓												✓
<b>New Orleans</b>																								
Port of New Orleans																								
<b>New Orleans</b>																								
Cooper/T. Smith Stevedoring	✓																							
<b>Newark</b>																								
Metal Management NE	✓							✓	✓			✓										✓		
<b>Newport News</b>																								
Dominion Terminal Associates	✓	✓	✓																					
<b>Newport News</b>																								
Kinder Morgan -Pier IX Terminal	✓					✓																		
<b>Norfolk</b>																								
Virginia Maritime Association	✓																							
<b>Norfolk</b>																								
Virginia International Terminals Inc				✓																				
<b>Norfolk</b>																								
Virginia Port Authority																								
<b>North Charleston</b>																								
Cooper/T. Smith Stevedoring																								
<b>Oakland</b>																								
Port of Oakland													✓								✓		✓	
<b>Oakville</b>																								
The Andersons				✓																				
<b>Ogdensburg</b>																								
Ogdensburg Bridge & Port Authority																								
<b>Olympia</b>																								
Port of Olympia																				✓	✓	✓	✓	✓
<b>Omaha</b>																								
Hansen-Mueller Company				✓																				
<b>Oswego</b>																								
Port of Oswego Authority				✓		✓					✓													
<b>Pago Pago</b>																								
Port of Pago Pago																								
<b>Palmer</b>																								
Port MacKenzie/Mat-Su Borough	✓					✓						✓								✓	✓			
<b>Palmer</b>																								
Port MacKenzie, Matanuska-Susitna Borough	✓					✓						✓							✓	✓				✓
<b>Palmetto</b>																								
Port Manatee Forestry Terminal Inc																					✓			
<b>Pascagoula</b>																								
Port of Pascagoula				✓							✓	✓								✓	✓	✓	✓	✓
<b>Pensacola</b>																								
Port of Pensacola				✓							✓	✓											✓	



COMMODITIES	CL	CC	PC	G-A	AF	CM	CLK	IO	BX	AL	FR	G-FGD	AG	SU	SOY	SODA	MIN	CHEM	BC	FRS	STL	P&P	MB	OTH
<b>Philadelphia</b>																								
Agway				✓																				
<b>Philadelphia</b>																								
Port of Philadelphia & Camden																					✓	✓	✓	
<b>Piti</b>																								
Port Authority of Guam							✓						✓											✓
<b>Point Comfort</b>																								
Port of Point Comfort/Port Lavaca									✓															
<b>Port Allen</b>																								
Port of Greater Baton Rouge	✓		✓	✓		✓	✓		✓													✓		✓
<b>Port Allen</b>																								
Associated Terminals of																								
Baton Rouge/Port Allen	✓	✓			✓			✓	✓		✓	✓	✓			✓	✓	✓			✓	✓	✓	✓
<b>Port Angeles</b>																								
Port of Port Angeles																					✓		✓	
<b>Port Arthur</b>																								
Port of Port Arthur			✓										✓						✓	✓	✓	✓		✓
<b>Port Arthur</b>																								
Pabtex	✓		✓																					
<b>Port Hueneme</b>																								
Port Hueneme Port Authority				✓																				✓
<b>Port Newark</b>																								
Port Authority of NY & N Jersey	✓			✓																				
<b>Port Royal</b>																								
Port of Port Royal																								✓
<b>Port Smith</b>																								
Granite State Minerals	✓			✓		✓	✓	✓			✓		✓											✓
<b>Portland</b>																								
Columbia Grain Elevator				✓																				
<b>Portland</b>																								
International Terminals								✓																
<b>Portland</b>																								
Port of Portland				✓	✓			✓			✓					✓					✓	✓	✓	✓
<b>Portsmouth</b>																								
Sprague Energy	✓	✓	✓			✓	✓	✓	✓			✓	✓						✓	✓	✓	✓	✓	✓
<b>Providence</b>																								
Waterson Terminal Services.	✓	✓	✓			✓		✓	✓	✓			✓						✓	✓	✓			✓
<b>Pueblo</b>																								
Association of American Railroads																								
<b>Redwood City</b>																								
Port of Redwood City						✓			✓			✓	✓									✓		✓
<b>Reserve</b>																								
Associated Terminals at																								
Globalplex	✓	✓	✓		✓			✓	✓	✓	✓	✓	✓			✓	✓	✓	✓	✓	✓	✓	✓	✓
<b>Reserve</b>																								
Associated Terminals LLC	✓	✓	✓	✓	✓	✓	✓	✓	✓	✓	✓	✓	✓	✓	✓	✓	✓	✓	✓	✓	✓	✓	✓	✓
<b>Richmond</b>																								
Port of Richmond																								
<b>Richmond</b>																								
Levin-Richmond Terminal																								
Corporation (LRTC)	✓	✓	✓					✓	✓				✓					✓					✓	✓
<b>Wheelersburg</b>																								
Norfolk Southern -																								
Wheelersburg Terminal	✓																							
<b>Lamberts Point</b>																								
Norfolk Southern - Lamberts Point	✓																							
<b>Saint Paul</b>																								
Port of St Paul																								
<b>Salt Lake City</b>																								
Savage Companies	✓																							
<b>San Diego</b>																								
Port of San Diego																						✓		
<b>San Francisco</b>																								
Port of San Francisco													✓						✓	✓	✓	✓	✓	✓
<b>San Pedro</b>																								
Los Angeles Export Terminal		✓																						
<b>San Pedro</b>																								
World Port LA (Port of																								
Los Angeles)	✓																							
<b>San Pedro</b>																								
Marine Terminals Corporatrion						✓															✓	✓	✓	
<b>San Pedro</b>																								
Port of Los Angeles																								

# COMMODITIES HANDLED

COMMODITIES	CL	CC	PC	G-A	AF	CM	CLK	IO	BX	AL	FR	G-FGD	AG	SU	SOY	SODA	MIN	CHEM	BC	FRS	STL	P&P	MB	OTH	
<b>San Pedro</b>																									
Los Angeles Harbour Department																									✓
<b>Sandusky</b>																									
Sandusky Dock Corporation, Pier #3	✓		✓																						
<b>Sandusky</b>																									
CT Stevedoring	✓																								
<b>Savannah</b>																									
Georgia Ports Authority USA				✓	✓			✓			✓	✓			✓				✓	✓	✓	✓	✓		✓
<b>Seattle</b>																									
Stevedoring Services of America	✓																				✓	✓			
<b>Seattle</b>																									
Port of Seattle				✓		✓			✓			✓	✓								✓	✓	✓		
<b>Seward</b>																									
Port of Seward																									
<b>Seward</b>																									
Aurora Energy Services, LLC	✓																								
<b>Skagway</b>																									
Port of Skagway																									
<b>Decatur</b>																									
Kinder Morgan Terminals - Decatur	✓			✓	✓	✓	✓	✓	✓		✓	✓	✓								✓	✓	✓	✓	✓
<b>St Louis</b>																									
Bunge St Louis				✓																					
<b>St Louis</b>																									
Cahokia Marine Services	✓																								
<b>Stamford</b>																									
Oxbow Carbon Minerals		✓	✓																						
<b>Stockton</b>																									
Port of Stockton	✓	✓	✓	✓	✓	✓	✓	✓	✓	✓	✓	✓	✓	✓	✓	✓	✓	✓	✓	✓	✓	✓	✓	✓	✓
<b>Stockton</b>																									
Metropolitan Stevedore	✓	✓	✓					✓					✓				✓								
<b>Stockton</b>																									
Metro Ports	✓		✓			✓		✓			✓		✓						✓						✓
<b>Stockton</b>																									
Sunshine Cement, Inc						✓																			
<b>Superior</b>																									
Superior Midwest Energy Terminal	✓																								
<b>Superior</b>																									
Cenex Harvest States				✓																					
<b>Superior</b>																									
Peavey Company - Connor's Point Elevator				✓																					
<b>Tacoma</b>																									
Stevedoring Services of America				✓																					
<b>Tacoma</b>																									
Port of Tacoma Authority				✓					✓																
<b>Tallahassee</b>																									
Florida Ports Council																									
<b>Tampa</b>																									
Kinder Morgan Terminals - Tampaplex Terminal	✓																								
<b>Tampa</b>																									
Tampa Port Authority	✓			✓	✓	✓					✓	✓	✓								✓	✓		✓	✓
<b>Tampa</b>																									
Tampa Bay Stevedores Ltd												✓													
<b>Tampa</b>																									
United Maritime Group	✓							✓			✓														
<b>Tampa</b>																									
Tampa Bay International Terminals Inc																					✓	✓			
<b>Texas City</b>																									
Port of Texas City				✓	✓						✓														
<b>Toledo</b>																									
Midwest Terminals of Toledo International, Inc	✓		✓	✓	✓			✓	✓	✓	✓		✓	✓								✓			
<b>Toledo</b>																									
ADM Grain Company Ltd				✓	✓										✓										
<b>Toledo</b>																									
CSX Coal Dock	✓																								
<b>Toledo</b>																									
Toledo-Lucas County Port Authority	✓	✓	✓	✓	✓	✓	✓	✓	✓	✓	✓	✓	✓	✓	✓	✓	✓	✓	✓	✓	✓	✓	✓	✓	✓



COMMODITIES	CL	CC	PC	G-A	AF	CM	CLK	IO	BX	AL	FR	G-FGD	AG	SU	SOY	SODA	MIN	CHEM	BC	FRS	STL	P&P	MB	OTH	
<b>Valdez</b>																									
Port of Valdez						✓															✓				
<b>Vancouver</b>																									
Vancouver-United Grain Elevator				✓																					
<b>Vancouver</b>																									
Port of Vancouver, USA				✓		✓			✓		✓						✓				✓	✓	✓	✓	✓
<b>Vancouver</b>																									
United Grain Corp				✓																					
<b>West Sacramento</b>																									
Port of West Sacramento			✓	✓	✓	✓	✓	✓			✓		✓		✓	✓	✓		✓	✓	✓	✓	✓	✓	✓
<b>Whittier</b>																									
Whittier Port Authority Commission																									
<b>Wilmington</b>																									
Metro Ports											✓						✓		✓	✓	✓	✓	✓	✓	✓
<b>Wilmington</b>																									
Metropolitan Stevedore Company	✓	✓	✓					✓				✓				✓	✓								
<b>Wilmington</b>																									
Metro Ports	✓		✓								✓					✓					✓	✓	✓		
<b>Wilmington</b>																									
Pasha Stevedoring & Terminals				✓																	✓	✓	✓		✓
<b>Wilmington</b>																									
Port of Wilmington,																									
Delaware/Diamond State Port Co			✓		✓			✓	✓		✓								✓	✓	✓	✓	✓	✓	✓
<b>Wilmington</b>																									
North Carolina State																									
Ports Authority/ Wilmington	✓			✓	✓	✓					✓		✓					✓			✓	✓	✓		✓
<b>VENEZUELA</b>																									
<b>Estado</b>																									
Venterminales											✓														
<b>Guidad Guayana</b>																									
Interalumina																									
<b>Maracaibo</b>																									
Carbones del Guasare SA	✓																								
<b>Maracaibo</b>																									
Port Authority of Maracaibo				✓																					
<b>Maracaibo</b>																									
BDV - Bulkguasare																									
de Venezuela, SA	✓																								
<b>Santa Cruz de Mara</b>																									
Santa Cruz Coal Terminal	✓																								
<b>VIETNAM</b>																									
<b>Can Tho</b>																									
Can Tho Port																									
<b>Ho Chi Min city</b>																									
Ho Chi Minh Port Authority				✓		✓					✓														✓
<b>Ngo Quyen District</b>																									
Haiphong Port Authority	✓			✓	✓	✓	✓	✓	✓	✓	✓		✓	✓	✓	✓					✓	✓	✓	✓	✓



Company	Page	Company	Page
4B BRAIME Elevator Components	2	Maschinen und Mühlenbau Erhard Muhr GmbH	59
Achenbach GmbH Metalltechnik	2	METSO	58
Agrico Sales, Inc.	4	MRS Greifer GmbH	60
Agromatic AG	6	Nemag BV	61
Anvil Attachments	8	Neuro Industrietechnik GmbH	63
Bedeschi SpA	10	NKM Noell Special Cranes	44
Beumer Group GmbH & Co KG	7	NM Heilig BV	62
BLUG Credeblug S.L.	11	OBA - Bulk Terminal Amsterdam	196
Bühler AG, Grain Logistics	12	Orthos Projects Ltd.	64
Bulk Connections	188	ORTS GmbH Maschinenfabrik	66
Bulk Logistic Landmark	15	Ovet BV	206
BV Beco	14	Pavan Group	68
BV Zeehavenbedrijf Dordrecht (ZHD Stevedoring)	199	PINTSCH BUBENZER GmbH	69
Cargotec Sweden Bulk Handling AB	17	Pirs SA	70
Christianson Systems Inc.	18	PIV Drives GmbH - a Brevini Power Transmission Co.	74
Cimbria Bulk Equipment	20	PLM Cranes B.V.	72
Cleveland Cascades Ltd	21	Poço Bispo Multipurpose Terminal – TMPB	181
Coaltrans Conferences Ltd	134	Port of Amsterdam	198
Conductix-Wampfler AG	22	Port of Belledune	139
Cooper/Consolidated	220	Port of Kokkola	152
Coperion GmbH	23	Port of Pori	153
CorrPak Bulk Packaging Systems, LLC	127	Port-Trade ApS	73
CST Covers	24	PT Indonesia Bulk Terminal	164, 165
DCL, Incorporated	26	RHB Stevedoring & Warehousing	200
Dos Santos International, LLC	28	Rhenus Midgard GmbH & Co. KG	160
DSH Systems Ltd.	28	RockTree Logistics Pte. Ltd.	Front Cover, 77, 78
Duisburger Hafen AG	158	Ronin GMS	76
E Buttmer & Co. Ltd	31	Rotterdam Bulk Terminal (R.B.T.) B.V.	208
E-Crane World Wide / E-Crane International USA	30	Royal Haskoning	79
Euromec Srl	32	RTA ALESA Ltd.	115
European Bulk Services (EBS) BV	204	RULMECA HOLDING S.P.A.	80
Europees-Massagoed Overslagbedrijf (EMO) BV	202, 203	Salzgitter Maschinenbau AG/PEINER Grabs	81
Fednav Ltd	140	Sandvik Mining and Construction	82
FLSmidth Inc.	34	Schenck Process GmbH	84
FLSmidth Wadgassen GmbH	36	Seabulk Systems Inc	86
Grindrod Management Services (Pty) Ltd	5, 7, 190	Sea Invest	178
Gulf Agency Company Ltd	186	SENNEBOGEN Maschinenfabrik GmbH	89
HAROPA	156	Sept-Îles Port Authority	142
HAYER & BOECKER OHG, Machinery Division	38	SIG Società Italiana Gomma Spa	88
Henry International Diplomatic Marine	39	SMB International GmbH	91
Heyl & Patterson Inc	41	Starlinger & Co. GmbH	124
Hitachi Construction Machinery (Europe) NV	40	Stema SA	174
Hudig & Veder BV	207	Stevenel OY	93
IBAU HAMBURG	42, 43	Superior Industries	92
IHI Transport Machinery Co., Ltd. (IUK)	46	Swire CTM	96
Indexator AB	45	Telestack Limited	95
Inspectorate International Ltd	47	Terex Fuchs GmbH	97
J & B Grabs b.v.	48	The Pasha Group	229
Konecranes Finland Corporation	51	Thiele GmbH & Co KG	98
Laidig Systems Inc	52	Thunder Bay Port Authority	144
Liebherr-Werk Nenzing GmbH	Back Cover	Tramco, Inc	100
Listenow GmbH & Co.	55	Van Aalst Bulk Handling BV	Inside Back Cover
Loibl Allen-Sherman-Hoff GmbH	54	Verstegen Grijpers BV	Inside Front Cover
Mack Manufacturing Inc	54	Vibrafloor	102
Mantsinen Group Ltd Oy	56	VIGAN	104, Belly Band
Marcor Stevedoring BV Rotterdam	201	Vossloh Kiepe GmbH	106
Maritime Bulk Terminal Gdynia Ltd	180	Zeeland Seaports	205
Martin Engineering	57		





# VAN AALST BULK HANDLING B.V.

made to measure

## Van Aalst Bulk Handling

Specialized in pneumatic bulk handling equipment for loading, unloading, conveying and storing of powders and dusty or abrasive materials such as:

- ▼ Cement
- ▼ Granulated slag
- ▼ Fly ash
- ▼ China clay
- ▼ Alumina



Ship Loading



Ship Unloading



Ship Unloading

## SERVICE AND SPARE PARTS!



Storage

(International Trade Centre) Engelandlaan 56  
2391 PN Hazerswoude-Dorp, The Netherlands

tel: +31 172 213 341  
fax: +31 172 232 804  
e-mail: [info@vanaalstbulkhandling.com](mailto:info@vanaalstbulkhandling.com)  
internet: [www.vanaalstbulkhandling.com](http://www.vanaalstbulkhandling.com)

# Experience the progress.



**Liebherr-Werk Nenzing GmbH**  
P.O. Box 10, 6710 Nenzing/Austria  
Tel.: +43 50809 41-725  
Fax: +43 50809 41-447  
mobile.harbour.crane@liebherr.com  
www.liebherr.com

# LIEBHERR

**The Group**